

**SPANNROLLENSÄTZE
BELT TENSIONER KITS
KITS DE DISTRIBUTION
ZESTAWY PASKA ROZRZĄDU**

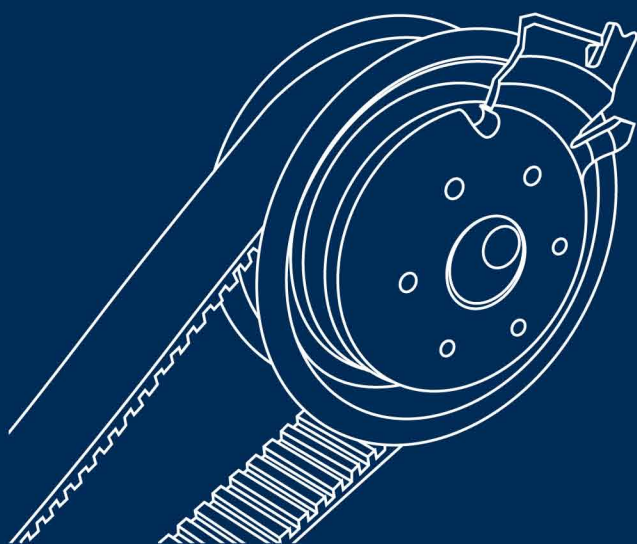

OPTIMAL®



OPTIMAL®

Spannrollensätze



Radlagersätze

Wheel Bearing Kits
Kits de Roulements de Roues
Zestawy łożyskowe do kół

Art. Nr. **WBM-3000**



Lenkungsteile

Steering and Suspension Parts
Pièces de Direction et Suspension
Elementy zawieszenia

Art. Nr. **WBM-3001A** European Cars
Art. Nr. **WBM-3001B** Asian Cars



Stoßdämpfer

Shock Absorbers
Amortisseurs
Amortyzatory

Art. Nr. **WBM-3002**



Bremssysteme

Brake Systems
Systèmes de Freinage
Systemy hamulcowe

Art. Nr. **WBM-3003**



Gummimetallteile

Rubber Metal Parts
Pièces Caoutchouc-Métal
Części metalowo-gumowe

Art. Nr. **WBM-3004**



Spannrollensätze

Belt Tensioner Kits
Kits de Distribution
Zestawy paska rozrządu

Art. Nr. **WBM-3005**



Wasserpumpen

Waterpumps
Pompes à Eau
Pompy wodne

Art. Nr. **WBM-3006**



Gasfedern

Gas Springs
Vérins à Gaz
Sprężyny gazowe

Art. Nr. **WBM-3007**



Sensoren Raddrehzahl

Sensors wheel speed
Capteurs vitesse de roue
Czujniki liczba obrotów koła

Art. Nr. **WBM-3008**

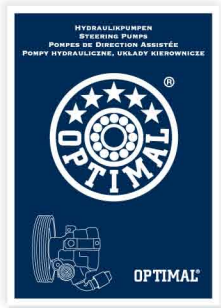

Hydraulikpumpen

Steering Pumps
Pompes de Direction Assistée
Pompy hydrauliczne

Art. Nr. **WBM-3010**



Fahrwerksfedern

Coil Springs
Ressorts de Suspension
Sprężyny zawieszenia

Art. Nr. **WBM-3011** Premium Line
Art. Nr. **WBM-3011S** Standard Line

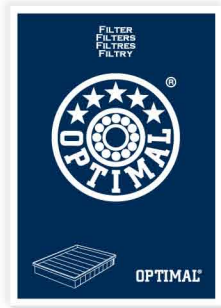

Filter

Filters
Filtres
Filtry

Art. Nr. **WBM-3012**



Ersatzteile für Kleintransporter

Parts for Light Commercial Vehicles
Pièces de Recharge Véhicules
Utilitaires Légers
Części do samochodów dostawczych

Art. Nr. **WBM-3013**



Bremsbackensätze

Brake Shoe Kits
Jeu de Mâchoires de Frein
Zestawy szczęk hamulcowych

Art. Nr. **WBM-3014**



Ersatzteile für Elektro- und Hybridfahrzeuge

Parts for electric- and hybrid vehicles
Pièce de rechange pour véhicules
électrique et hybride

Art. Nr. **WBM-3015**



Sensoren Motorsteuerung

Engine control sensors
Capteurs pour commande moteur
Czujniki układu sterowania silnika

Art. Nr. **WBM-3016**

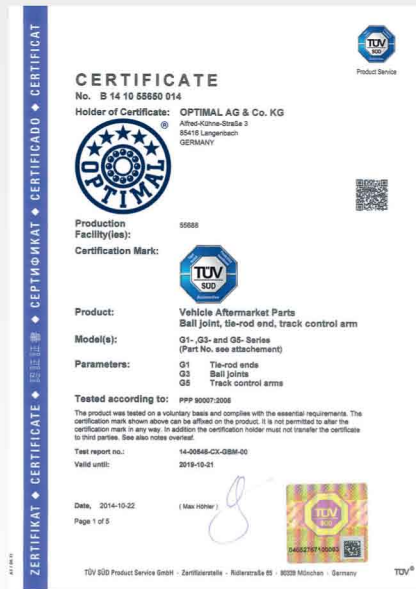

Steering and Suspension Parts



Lenkungsteile





I. Kfz-Hersteller:

ABARTH.....	1 - 1
ACURA.....	2 - 2
ALFA ROMEO.....	3 - 15
ALPINA.....	16 - 16
AUDI.....	17 - 77
AUDI (FAW).....	78 - 78
AUSTIN.....	79 - 79
AUTOBIANCHI.....	80 - 80
BEDFORD.....	81 - 81
BMW.....	82 - 118
BMW (BRILLIANCE).....	119 - 119
BUICK.....	120 - 121
BUICK (SGM).....	122 - 122
CADILLAC.....	123 - 124
CHANGAN (CHANA).....	125 - 125
CHANGFENG.....	126 - 126
CHERY.....	127 - 127
CHEVROLET.....	128 - 138
CHEVROLET (SGM).....	139 - 139
CHEVROLET (SGMW).....	140 - 140
CHRYSLER.....	141 - 144
CHRYSLER (BBDC).....	145 - 145
CITROËN.....	146 - 199
CITROEN (DF-PSA).....	200 - 200
DACIA.....	201 - 206
DAEWOO.....	207 - 212
DAIHATSU.....	213 - 215
DODGE.....	216 - 218
DONGNAN (SOUEAST).....	219 - 219
EUNOS.....	220 - 220
FENGXING (DONGFENG).....	221 - 221
FIAT.....	222 - 258
FIAT (NANJING).....	259 - 259
FORD.....	260 - 305
FORD (CHANGAN).....	306 - 306
FORD ASIA / OZEANIA.....	307 - 307
FORD AUSTRALIA.....	308 - 309
FORD OTOSAN.....	310 - 310
FORD USA.....	311 - 312
FSO.....	313 - 313
GEELY.....	314 - 314
GEO.....	315 - 315
GMC.....	316 - 316
HAFEI.....	317 - 317



HOLDEN.....	318 - 321
HONDA.....	322 - 333
HONDA (DONGFENG).....	334 - 334
HONDA (GAC).....	335 - 335
HONGQI.....	336 - 336
HUMMER.....	337 - 337
HYUNDAI.....	338 - 354
HYUNDAI (BEIJING).....	355 - 355
HYUNDAI (HUATAI).....	356 - 356
INFINITI.....	357 - 357
INNOCENTI.....	358 - 358
INOKOM.....	359 - 359
ISUZU.....	360 - 361
IVECO.....	362 - 371
JAGUAR.....	372 - 373
JEEP.....	374 - 376
KIA.....	377 - 387
KIA (DYK).....	388 - 388
LADA.....	389 - 391
LANCIA.....	392 - 401
LAND ROVER.....	402 - 404
LDV.....	405 - 405
LEXUS.....	406 - 408
LINCOLN.....	409 - 409
LOTUS.....	410 - 410
MAZDA.....	411 - 426
MAZDA (CHANGAN).....	427 - 427
MAZDA (FAW).....	428 - 428
MEGA.....	429 - 429
MERCEDES-BENZ.....	430 - 475
MERCEDES-BENZ (BBDC).....	476 - 476
MERCURY.....	477 - 477
MG.....	478 - 480
MINI.....	481 - 482
MITSUBISHI.....	483 - 504
MITSUBISHI (BJC).....	505 - 505
MITSUBISHI (GAC).....	506 - 506
MORGAN.....	507 - 507
NISSAN.....	508 - 520
NISSAN (DONGFENG).....	521 - 521
NISSAN (ZHENGZHOU).....	522 - 522
OLDSMOBILE.....	523 - 523
OPEL.....	524 - 573
PEUGEOT.....	574 - 630
PEUGEOT (DF-PSA).....	631 - 631



PLYMOUTH.....	632 - 632
PONTIAC.....	633 - 633
PORSCHE.....	634 - 637
PROTON.....	638 - 639
PUCH.....	640 - 640
RENAULT.....	641 - 701
RENAULT TRUCKS.....	702 - 703
ROEWE (SAIC).....	704 - 704
ROLLS-ROYCE.....	705 - 705
ROVER.....	706 - 714
SAAB.....	715 - 719
SANTANA.....	720 - 720
SEAT.....	721 - 748
SKODA.....	749 - 769
SKODA (SVW).....	770 - 770
SMART.....	771 - 771
SSANGYONG.....	772 - 773
SUBARU.....	774 - 785
SUZUKI.....	786 - 791
SUZUKI (CHANGAN).....	792 - 792
TALBOT.....	793 - 793
TATA.....	794 - 794
TOYOTA.....	795 - 823
TOYOTA (FAW).....	824 - 824
TOYOTA (GAC).....	825 - 825
UAZ.....	826 - 826
VAUXHALL.....	827 - 866
VOLVO.....	867 - 897
VW.....	898 - 981
VW (FAW).....	982 - 982
VW (SVW).....	983 - 983
YUGO.....	984 - 984
ZASTAVA.....	985 - 985
ZAZ.....	986 - 986
ZHONGHUA(BRILLIANCE).....	987 - 987

II. Vergleichslisten

Vergleichs-Nr. / OPTIMAL Nr.....	A-1 - A-42
REFERENZ-NR. / OPTIMAL Nr.....	B-1 - B-108

III. Fotos

Fotos.....	C-1 - E-97
------------	------------









Dieser Katalog wurde mit großer Sorgfalt zusammengestellt.
Dennoch kann für die darin gemachten Angaben und Hinweise keine Gewähr übernommen werden.
Herstellernamen und -nummern sind nur zu Informationszwecken aufgeführt.

All data in the catalogue have been carefully checked.
No liability, however, can be accepted for any errors.
Original replacement numbers are for comparison reasons only.

Toutes les données de ce catalogue ont été soigneusement contrôlées.
Nous déclinons cependant toute responsabilité pour des erreurs éventuelles.
Les numéros des pièces de rechange d'origine sont présents seulement dans un but de comparaison.

Wszystkie dane w katalogu zostały dokładnie sprawdzone,
niemniej wydawca nie ponosi żadnej odpowiedzialności za ewentualne błędy.
Oryginalne numery zamienników podane są tylko w celach informacyjnych.

**D****GB**

	Für Fahrzeuge ohne ABS	For vehicles without ABS
	Für Fahrzeuge mit Automatikgetriebe	For vehicles with automatic transmission
	Für Fahrzeuge mit Schaltgetriebe	For vehicles with manual transmission
	Für Fahrzeuge mit Klimaanlage	For vehicles with air conditioning
	Für Fahrzeuge ohne Klimaanlage	For vehicles without air conditioning
	Motorcode	Engine Code
LHT	Für Linksverkehr	For left-hand traffic
RHT	Für Rechtsverkehr	For right-hand traffic
	Mit Schraube	With screw
19x142	19 (Breite [mm]) x 142 (Zähnezahl)	19 (Width [mm]) x 142 (Number of Teeth)
BTK	Zahnriemensatz	Belt tensioner kit
BTKW	Zahnriemensatz mit Wasserpumpe	Belt tensioner kit with water pump
TB [BT]	Steuerriemen [Riemenspanner]	timing belt [belt tensioner]
TB [DG]	Steuerriemen [Umlenk-/Führungsrolle]	timing belt [deflection- /guider roller]
TB [TE]	Steuerriemen [Spannrolle]	timing belt [tensioner roller]
TB [VD]	Steuerriemen [Schwingungsdämpfer]	timing belt [vibration damper]
VB [BT]	Keilrippenriemen [Riemenspanner]	v-belt [belt tensioner]
VB [DG]	Keilrippenriemen [Umlenk-/Führungsrolle]	v-belt [deflection- /guider roller]
VB [TE]	Keilrippenriemen [Spannrolle]	v-belt [tensioner roller]
VB [VD]	Keilrippenriemen [Schwingungsdämpfer]	v-belt [vibration damper]
FB [DG]	Keilriemen [Umlenk-/Führungsrolle]	fan belt [deflection- /guider roller]
FB [TE]	Keilriemen [Spannrolle]	fan belt [tensioner roller]



OPTIMAL®

ABARTH

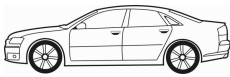

CM³



Art. Nr.



ohne Halter

500 (312)

1.4 Abarth	08/08-	312 A1.000, 312 A3.000	1368	22x124; 01/2009 →; Baumuster: 312	SK-1412	BTK	
1.4 Abarth	08/08-	312 A3.000	1368	22x124; 09/2010 →; Baumuster: 312	SK-1412	BTK	
1.4 Abarth	08/08-	312 A1.000, 312 A1.000, 312 A9.000	1368	22x124; Baumuster: 312	SK-1412	BTK	
1.4 Abarth	08/08-	312 A1.000, 312 A1.000, 312 A9.000	1368	22x124	SK-1412AQ2	BTKW	
1.4 Abarth	08/08-	312 A1.000, 312 A3.000	1368	22x124; 01/2009 →	SK-1412AQ2	BTKW	
1.4 Abarth	08/08-	312 A3.000	1368	22x124; 09/2010 →	SK-1412AQ2	BTKW	
1.4 Abarth	05/10-	312 A3.000	1368	22x124; 07/2012 →	SK-1412	BTK	
1.4 Abarth	08/08-	312 A1.000, 312 A1.000, 312 A3.000, 312 A1.000, 312 A9.000, 312 A3.000	1368		0-N195	TB [TE]	
1.4 Abarth	08/08-	312 A1.000, 312 A1.000, 312 A3.000, 312 A1.000, 312 A9.000, 312 A3.000	1368		0-N1517	VB [BT]	S

500C (312)

1.4 Abarth	09/09-	312 A3.000	1368	22x124; 01/2010 →; Baumuster: 312	SK-1412	BTK	
1.4 Abarth	09/09-	312 A1.000, 312 A3.000, 312 A3.000	1368	22x124	SK-1412AQ2	BTKW	
1.4, 1.4 Abarth	01/11-	312 A1.000, 312 A1.000, 312 A3.000	1368	22x124	SK-1412	BTK	
1.4 Abarth	09/09-	312 A1.000, 312 A3.000, 312 A3.000	1368		0-N195	TB [TE]	
1.4 Abarth	09/09-	312 A1.000, 312 A3.000, 312 A3.000	1368		0-N1517	VB [BT]	S

GRANDE PUNTO (199)

1.4 Abarth	12/07-06/10	199 A8.000	1368	22x124; Baumuster: 199	SK-1412	BTK	
1.4 Abarth	12/07-12/12	199 A8.000	1368	22x124; 04/2009 →; Baumuster: 199	SK-1412	BTK	
1.4 Abarth	12/07-06/10	199 A8.000	1368	22x124	SK-1412AQ2	BTKW	
1.4 Abarth	12/07-12/12	199 A8.000, 955 A8.000	1368	22x124; 04/2009 →	SK-1412AQ2	BTKW	
1.4 Abarth	12/07-12/12	199 A8.000, 199 A8.000, 955 A8.000	1368		0-N195	TB [TE]	
1.4 Abarth	12/07-12/12	199 A8.000, 199 A8.000, 955 A8.000	1368		0-N1517	VB [BT]	S

PUNTO (199)

1.4 Abarth	07/08-	199 A8.000, 955 A8.000	1368	22x124	SK-1412	BTK	
1.4 Abarth	07/08-	199 A8.000, 955 A8.000, 955 A8.000	1368	22x124	SK-1412AQ2	BTKW	
1.4 Abarth	10/09-	955 A8.000	1368	22x124; 06/2010 →; Baumuster: 199	SK-1412	BTK	
1.4 Abarth	07/08-	199 A8.000, 955 A8.000, 955 A8.000	1368		0-N195	TB [TE]	
1.4 Abarth	07/08-	199 A8.000, 955 A8.000, 955 A8.000	1368		0-N1517	VB [BT]	S

RITMO (138A)

130 TC Abarth 2.0	04/83-12/87	138 AR2.000	1995	01/1986 →	0-N823	TB [TE]	
-------------------	-------------	-------------	------	-----------	--------	---------	--

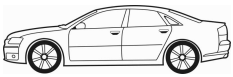

CM³



Art. Nr.



ohne Halter

CL Coupe

2.2	10/96-09/97	F22B2	2156		0-N178	TB [TE]	
2.2	10/96-09/97	F22B2	2156		0-N905	TB [TE]	
2.3 Vtec	10/98-09/00	F23A7	2254		0-N178	TB [TE]	
2.3 Vtec	10/98-09/00	F23A7	2254		0-N905	TB [TE]	

RDX

2.3 Turbo Allrad	04/06-	R23A2	2298		0-N1850	VB [BT]	S
------------------	--------	-------	------	--	----------------	---------	----------

RSX Coupe (DC_)

2.0 Sport	10/01-	K20A3	1998		0-N2033	VB [DG]	
2.0, 2.0 Sport, 2.0 Vtec, 2.0 Vtec Sport	10/01-	K20A, K20A3	1998		0-N2207	VB [TE]	

TSX (CL_)

2.0 Vtec	10/05-12/08	K20A8	1998		0-N1850	VB [BT]	S
2.0 Vtec	10/05-12/08	K20A8	1998		0-N2207	VB [TE]	
2.4 Vtec	10/03-12/08	K24A2	2354		0-N1850	VB [BT]	S
2.4 Vtec	10/03-12/08	K24A2	2354		0-N2033	VB [DG]	
2.4 Vtec	10/03-12/08	K24A2	2354		0-N2207	VB [TE]	

TSX (CU_)

2.4	09/10-	K24Z3	2354		0-N2399	VB [BT]	S
-----	--------	-------	------	--	----------------	---------	----------



CM³



Art. Nr.



4C (960, 960_)							
1.8 Tbi	03/13-	960 A1.000	1742			0-N2149	TB [DG]
1.8 Tbi	03/13-	960 A1.000	1742			0-N2150	TB [TE]
4C SPIDER (960, 960_)							
1.8 Tbi	10/14-	960 A1.000	1742			0-N2149	TB [DG]
1.8 Tbi	10/14-	960 A1.000	1742			0-N2150	TB [TE]
33 (905)							
1.5	05/83-12/93	AR 30182	1490	17x100		SK-1065	BTK
1.7	01/86-12/89	AR 30550	1712	17x100; 01/1989 →		SK-1065	BTK
1.7, 1.7 i.e., 1.7 QV	01/86-12/89	AR 30550, AR 30558	1712	17x100		SK-1065	BTK
1.2	06/83-12/89	AR 30585	1186			0-N800	TB [TE]
1.2	06/83-12/89	AR 30585	1186			0-N801	TB [TE]
1.3	06/83-12/89	AR 30168, AR 30587, AR 30502, AR 30586	1351			0-N800	TB [TE]
1.3	06/83-12/89	AR 30168, AR 30587, AR 30502, AR 30586	1351			0-N801	TB [TE]
1.5, 1.5 4x4, 1.5 QV	06/83-12/89	AR 30143, AR 30504, AR 30146, AR 30508, AR 30588, AR 30146, AR 30588, AR 30504, AR 30520, AR 30588	1490			0-N800	TB [TE]
1.5, 1.5 4x4, 1.5 QV	06/83-12/89	AR 30143, AR 30504, AR 30146, AR 30508, AR 30588, AR 30146, AR 30588, AR 30504, AR 30520, AR 30588	1490			0-N801	TB [TE]
1.7 i.e., 1.7 QV	03/88-12/89	AR 30550, AR 30558	1712			0-N800	TB [TE]
1.7 i.e., 1.7 QV	03/88-12/89	AR 30550, AR 30558	1712			0-N801	TB [TE]
33 Sportwagon (905A)							
1.7, 1.7 i.e., 1.7 i.e. 4x4	03/88-12/89	AR 30550, AR 30558, AR 30558, AR 30737	1712	17x100		SK-1065	BTK
1.5, 1.5 4x4	09/84-12/89	AR 30146, AR 30508, AR 30588, AR 30520, AR 30588	1490			0-N800	TB [TE]
1.5, 1.5 4x4	09/84-12/89	AR 30146, AR 30508, AR 30588, AR 30520, AR 30588	1490			0-N801	TB [TE]
1.7, 1.7 i.e., 1.7 i.e. 4x4	03/88-12/89	AR 30550, AR 30558, AR 30558, AR 30737	1712			0-N800	TB [TE]
1.7, 1.7 i.e., 1.7 i.e. 4x4	03/88-12/89	AR 30550, AR 30558, AR 30558, AR 30737	1712			0-N801	TB [TE]
33 (907A)							
1.4 4x4	07/90-12/92	AR 30755	1351	17x100; 01/1991 →		SK-1065	BTK
1.4 i.e.	06/91-09/94	AR 30753, AR 30755	1351	17x100		SK-1065	BTK
1.5, 1.5 i.e., 1.5 i.e.	01/90-09/94	AR 30734, AR 30750, AR 30751	1490	17x100		SK-1065	BTK
1.7 16V, 1.7 16V 4x4	01/90-09/94	AR 30746, AR 30747	1712	20x121; 07/1990 →		SK-1072	BTK
1.7 i.e., 1.7 i.e. 4x4	01/90-09/94	AR 30736, AR 30737, AR 30737 A	1712	17x100		SK-1065	BTK
1.4 i.e.	06/91-09/94	AR 30753, AR 30755	1351			0-N800	TB [TE]
1.4 i.e.	06/91-09/94	AR 30753, AR 30755	1351			0-N801	TB [TE]
1.5, 1.5 i.e.	01/90-04/93	AR 30734, AR 30750	1490			0-N800	TB [TE]
1.5, 1.5 i.e.	01/90-04/93	AR 30734, AR 30750	1490			0-N801	TB [TE]
1.7 16V, 1.7 16V 4x4	01/90-09/94	AR 30746, AR 30747	1712			0-N937	TB [TE]
1.7 i.e., 1.7 i.e. 4x4	01/90-09/94	AR 30736, AR 30737, AR 30737 A	1712			0-N800	TB [TE]
1.7 i.e., 1.7 i.e. 4x4	01/90-09/94	AR 30736, AR 30737, AR 30737 A	1712			0-N801	TB [TE]
33 Sportwagon (907B)							
1.4 i.e., 1.4 i.e. 4x4	06/91-09/94	AR 30587, AR 30755, AR 30753, AR 30755, AR 30755	1351	17x100		SK-1065	BTK
1.5 i.e.	01/90-09/94	AR 30751	1490	17x100		SK-1065	BTK
1.7 16V, 1.7 16V 4x4	01/90-09/94	AR 30746, AR 30747	1712	20x121; 07/1990 →		SK-1072	BTK
1.7 i.e., 1.7 i.e. 4x4	01/90-09/94	AR 30736, AR 30737, AR 30737	1712	17x100		SK-1065	BTK
1.4 i.e., 1.4 i.e. 4x4	06/91-09/94	AR 30587, AR 30755, AR 30753, AR 30755, AR 30755	1351			0-N800	TB [TE]
1.4 i.e., 1.4 i.e. 4x4	06/91-09/94	AR 30587, AR 30755, AR 30753, AR 30755, AR 30755	1351			0-N801	TB [TE]
1.5 i.e.	01/90-09/94	AR 30751	1490			0-N800	TB [TE]
1.5 i.e.	01/90-09/94	AR 30751	1490			0-N801	TB [TE]
1.7 16V, 1.7 16V 4x4	01/90-09/94	AR 30746, AR 30747	1712			0-N937	TB [TE]
1.7 i.e., 1.7 i.e. 4x4	01/90-09/94	AR 30736, AR 30737, AR 30737	1712			0-N800	TB [TE]
1.7 i.e., 1.7 i.e. 4x4	01/90-09/94	AR 30736, AR 30737, AR 30737	1712			0-N801	TB [TE]
145 (930)							
1.4 i.e.	07/94-12/96	AR 33501	1351	17x100		SK-1065	BTK
1.4 i.e. 16V T.S.	12/96-01/01	AR33503	1370	24x163; Baumuster: 930		SK-1365	BTK
1.4 i.e. 16V T.S.	12/96-01/01	AR33503	1370	24x163		SK-1697AQ1	BTKW
1.6 i.e.	10/94-12/96	AR 33201	1596	17x100		SK-1065	BTK
1.6 i.e. 16V T.S.	12/96-01/01	AR 38201, AR 67601	1598	24x166		SK-1415	BTK
1.7 i.e. 16V	10/94-12/96	AR 33401	1712	20x121		SK-1072	BTK
1.8 i.e. 16V, 1.8 i.e. 16V T.S.	12/96-01/01	AR 32201, AR 38401, AR 67106, AR 67199	1747	24x168		SK-1361	BTK

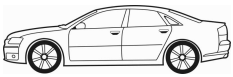

CM³



Art. Nr.



145 (930)

1.8 i.e. 16V, 1.8 i.e. 16V T.S.	12/96-01/01	AR 32201, AR 38401, AR 67106, AR 67199	1747	24x168	SK-1361AQ1	BTKW
1.9 JTD	02/99-01/01	AR 32302	1910	24x190; mit Zubehör	SK-1629	BTK
1.9 JTD	02/99-01/01	AR 32302	1910	24x190; mit Zubehör	SK-1629AQ1	BTKW
1.9 TD	10/94-02/99	AR 33601, AR 67501	1929	22x173	SK-1033	BTK
2.0 16V Quadrifoglio	03/98-01/01	AR 32301	1970	15x130	SK-1664	BTK
2.0 16V Quadrifoglio, 2.0 16V T.S.	10/95-01/01	AR 32301, AR 67204	1970	24x168	SK-1361	BTK
2.0 16V Quadrifoglio, 2.0 16V T.S.	10/95-01/01	AR 32301, AR 67204	1970	24x168	SK-1361AQ1	BTKW
2.0 16V Quadrifoglio, 2.0 16V T.S.	10/95-01/01	AR 32301, AR 67204	1970	24x168; 15x130	SK-1755	BTK
2.0 16V Quadrifoglio, 2.0 16V T.S.	10/95-01/01	AR 32301, AR 67204	1970	24x168; 15x130	SK-1755AQ1	BTKW
2.0 16V T.S.	10/95-01/01	AR 67204	1970	15x130; :0117878→	SK-1664	BTK
1.4 i.e.	07/94-12/96	AR 33501	1351		0-N800	TB [TE]
1.4 i.e.	07/94-12/96	AR 33501	1351		0-N801	TB [TE]
1.4 i.e. 16V T.S.	12/96-01/01	AR33503	1370		0-N194	TB [TE]
1.4 i.e. 16V T.S.	12/96-01/01	AR33503	1370		0-N938	TB [DG]
1.6 i.e.	10/94-12/96	AR 33201	1596		0-N800	TB [TE]
1.6 i.e.	10/94-12/96	AR 33201	1596		0-N801	TB [TE]
1.6 i.e. 16V T.S.	12/96-01/01	AR67601	1598		0-N194	TB [TE]
1.6 i.e. 16V T.S.	12/96-01/01	AR67601	1598		0-N938	TB [DG]
1.7 i.e. 16V	10/94-12/96	AR 33401	1712		0-N937	TB [TE]
1.8 i.e. 16V, 1.8 i.e. 16V T.S.	12/96-01/01	AR 32201, AR 38401, AR 67106, AR 67199	1747		0-N114	TB [TE]
1.8 i.e. 16V, 1.8 i.e. 16V T.S.	12/96-01/01	AR 32201, AR 38401, AR 67106, AR 67199	1747		0-N938	TB [DG]
1.9 JTD	02/99-01/01	AR 32302	1910		0-N115	TB [TE]
1.9 JTD	02/99-01/01	AR 32302	1910		0-N1326	TB [DG]
1.9 TD	10/94-02/99	AR 33601, AR 67501	1929		0-N835	TB [TE]
1.9 TD	10/94-02/99	AR 33601, AR 67501	1929		0-N889	TB [DG]
2.0 16V Quadrifoglio, 2.0 16V T.S.	10/95-01/01	AR 32301, AR 67204	1970		0-N114	TB [TE]
2.0 16V Quadrifoglio, 2.0 16V T.S.	10/95-01/01	AR 32301, AR 67204	1970		0-N1572	TB [TE]
2.0 16V Quadrifoglio, 2.0 16V T.S.	10/95-01/01	AR 32301, AR 67204	1970		0-N938	TB [DG]
1.4 i.e. 16V T.S.	12/96-01/01	AR 33503, AR 38501	1370		0-N1403	VB [DG]
1.4 i.e. 16V T.S.	12/96-01/01	AR33503	1370		0-N1407	VB [BT] S
1.6 i.e. 16V T.S.	12/96-01/01	AR 38201, AR 67601	1598		0-N1403	VB [DG]
1.6 i.e. 16V T.S.	12/96-01/01	AR67601	1598		0-N1407	VB [BT] S
1.8 i.e. 16V	03/98-01/01	AR 32201	1747		0-N1407	VB [BT] S
1.8 i.e. 16V T.S.	12/96-12/98	AR67106	1747		0-N1407	VB [BT] S
1.8 i.e. 16V, 1.8 i.e. 16V T.S.	12/96-01/01	AR 32201, AR 38401, AR 67106, AR 67199	1747		0-N1403	VB [DG]
1.9 JTD	02/99-01/01	AR 32302	1910		0-N1415	VB [DG]
1.9 JTD	02/99-01/01	AR 32302	1910		0-N1487	VB [BT] S
2.0 16V Quadrifoglio, 2.0 16V T.S.	10/95-01/01	AR 32301, AR 67204	1970		0-N1407	VB [BT] S
2.0 16V Quadrifoglio, 2.0 16V T.S.	10/95-01/01	AR 32301, AR 67204	1970		0-N1628	VB [DG]

146 (930)

1.4 i.e.	12/94-12/96	AR 33501	1351	17x100	SK-1065	BTK
1.4 i.e. 16V T.S.	11/96-01/01	AR33503	1370	24x163; Baumuster: 930	SK-1365	BTK
1.4 i.e. 16V T.S.	11/96-01/01	AR33503	1370	24x163	SK-1697AQ1	BTKW
1.6 i.e.	12/94-12/96	AR 33201	1596	17x100	SK-1065	BTK
1.6 i.e. 16V T.S.	11/96-01/01	AR 38201, AR 67601	1598	24x166	SK-1415	BTK
1.7 i.e. 16V	12/94-12/96	AR 33401	1712	20x121; 05/1995 →	SK-1072	BTK
1.8 i.e. 16V T.S.	11/96-01/01	AR 32201, AR 38401, AR 67106	1747	24x168	SK-1361	BTK
1.8 i.e. 16V T.S.	11/96-01/01	AR 32201, AR 38401, AR 67106	1747	24x168	SK-1361AQ1	BTKW
1.9 JTD	02/99-01/01	AR 32302	1910	24x190; mit Zubehör	SK-1629	BTK
1.9 JTD	02/99-01/01	AR 32302	1910	24x190; mit Zubehör	SK-1629AQ1	BTKW
1.9 TD	12/94-02/99	AR 33601, AR 67501	1929	22x173	SK-1033	BTK
2.0 16V Quadrifoglio	03/98-01/01	AR 32301	1970	15x130	SK-1664	BTK
2.0 16V Quadrifoglio	03/98-01/01	AR 32301	1970	24x168; 15x130	SK-1755	BTK
2.0 16V Quadrifoglio	03/98-01/01	AR 32301	1970	24x168; 15x130	SK-1755AQ1	BTKW
2.0 16V Quadrifoglio, 2.0 16V T.S.	10/95-01/01	AR 32301, AR 67204	1970	24x168	SK-1361	BTK
2.0 16V Quadrifoglio, 2.0 16V T.S.	10/95-01/01	AR 32301, AR 67204	1970	24x168	SK-1361AQ1	BTKW
2.0 16V T.S.	10/95-01/01	AR 67204	1970	15x130; :0117878→	SK-1664	BTK
2.0 16V T.S.	10/95-01/01	AR 67204	1970	24x168; 15x130; :0117879→	SK-1755	BTK
2.0 16V T.S.	10/95-01/01	AR 67204	1970	24x168; 15x130; :0117879→	SK-1755AQ1	BTKW
1.4 i.e.	12/94-12/96	AR 33501	1351		0-N800	TB [TE]
1.4 i.e.	12/94-12/96	AR 33501	1351		0-N801	TB [TE]
1.4 i.e. 16V T.S.	11/96-01/01	AR33503	1370		0-N194	TB [TE]
1.4 i.e. 16V T.S.	11/96-01/01	AR33503	1370		0-N938	TB [DG]
1.6 i.e.	12/94-12/96	AR 33201	1596		0-N800	TB [TE]
1.6 i.e.	12/94-12/96	AR 33201	1596		0-N801	TB [TE]



OPTIMAL®

ALFA ROMEO



CM³



Art. Nr.



146 (930)							
1.6 i.e. 16V T.S.	11/96-01/01	AR67601	1598			0-N194	TB [TE]
1.6 i.e. 16V T.S.	11/96-01/01	AR67601	1598			0-N938	TB [DG]
1.7 i.e. 16V	12/94-12/96	AR 33401	1712			0-N937	TB [TE]
1.8 i.e. 16V T.S.	11/96-01/01	AR 32201, AR 38401, AR 67106	1747			0-N114	TB [TE]
1.8 i.e. 16V T.S.	11/96-01/01	AR 32201, AR 38401, AR 67106	1747			0-N938	TB [DG]
1.9 JTD	02/99-01/01	AR 32302	1910			0-N115	TB [TE]
1.9 JTD	02/99-01/01	AR 32302	1910			0-N1326	TB [DG]
1.9 TD	12/94-02/99	AR 33601, AR 67501	1929			0-N835	TB [TE]
1.9 TD	12/94-02/99	AR 33601, AR 67501	1929			0-N889	TB [DG]
2.0 16V Quadrifoglio, 2.0 16V T.S.	10/95-01/01	AR 32301, AR 67204	1970			0-N114	TB [TE]
2.0 16V Quadrifoglio, 2.0 16V T.S.	10/95-01/01	AR 32301, AR 67204	1970			0-N1572	TB [TE]
2.0 16V Quadrifoglio, 2.0 16V T.S.	10/95-01/01	AR 32301, AR 67204	1970			0-N938	TB [DG]
1.4 i.e. 16V T.S.	11/96-01/01	AR 33503, AR 38501	1370			0-N1403	VB [DG]
1.4 i.e. 16V T.S.	11/96-01/01	AR33503	1370			0-N1407	VB [BT] S
1.6 i.e. 16V T.S.	11/96-01/01	AR 38201, AR 67601	1598			0-N1403	VB [DG]
1.6 i.e. 16V T.S.	11/96-01/01	AR67601	1598			0-N1407	VB [BT] S
1.8 i.e. 16V T.S.	11/96-01/01	AR 32201, AR 38401, AR 67106	1747			0-N1403	VB [DG]
1.8 i.e. 16V T.S.	11/96-01/01	AR67106	1747			0-N1407	VB [BT] S
1.8 i.e. 16V T.S.	03/98-01/01	AR 32201	1747			0-N1407	VB [BT] S
1.9 JTD	02/99-01/01	AR 32302	1910			0-N1415	VB [DG]
1.9 JTD	02/99-01/01	AR 32302	1910			0-N1487	VB [BT] S
2.0 16V Quadrifoglio, 2.0 16V T.S.	10/95-01/01	AR 32301, AR 67204	1970			0-N1407	VB [BT] S
2.0 16V Quadrifoglio, 2.0 16V T.S.	10/95-01/01	AR 32301, AR 67204	1970	*		0-N1628	VB [DG]
147 (937)							
1.6 16V T.SPARK	01/01-03/10	AR32104	1598	24x163; → 09/2008; Baumuster: 937AXB1A		SK-1365	BTK
1.6 16V T.SPARK , 1.6 16V T.SPARK ECO	01/01-03/10	AR 32104, AR 37203	1598	24x163; 09/2008 →		SK-1697	BTK
1.6 16V T.SPARK , 1.6 16V T.SPARK ECO	01/01-03/10	AR 32104, AR 37203	1598	24x163		SK-1697AQ1	BTKW
1.6 16V T.SPARK ECO	01/01-03/10	AR 37203	1598	24x163; → 09/2008; Baumuster: 937AXA1A		SK-1365	BTK
1.9 JTD , 1.9 JTDM, 1.9 JTDM 8V	04/01-03/10	182 B9.000, 937 A2.000, 937 A3.000, 939 A7.000	1910	24x190; mit Zubehör		SK-1629	BTK
1.9 JTD , 1.9 JTDM, 1.9 JTDM 8V	04/01-03/10	182 B9.000, 937 A2.000, 937 A3.000, 939 A7.000	1910	24x190; mit Zubehör		SK-1629AQ1	BTKW
1.9 JTD 16V	11/02-03/10	192 A5.000, 937 A4.000	1910	24x198; mit Zubehör		SK-1602	BTK
1.9 JTD 16V	11/02-03/10	192 A5.000, 937 A4.000	1910	24x198; mit Zubehör		SK-1602AQ1	BTKW
1.9 JTD 16V, 1.9 JTDM 16V	11/02-03/10	192 A5.000, 192 B1.000, 937 A5.000	1910	24x199; Abgasnorm: Euro 4 (D4)		SK-1586	BTK
1.9 JTD 16V, 1.9 JTDM 16V	09/04-03/10	192 B1.000, 937 A5.000	1910	24x199; Abgasnorm: Euro 4 (D4)		SK-1586AQ1	BTKW
1.9 JTD 16V, 1.9 JTDM 16V	09/04-03/10	192 B1.000, 937 A5.000	1910	24x198; Abgasnorm: Euro 3 (D3); mit Zubehör		SK-1602	BTK
1.9 JTD 16V, 1.9 JTDM 16V	09/04-03/10	192 B1.000, 937 A5.000	1910	24x198; Abgasnorm: Euro 3 (D3); mit Zubehör		SK-1602AQ1	BTKW
1.9 JTDM 16V	06/08-03/10	937 A6.000	1910	24x199; Baumuster: 937		SK-1586	BTK
1.9 JTDM 16V	06/08-03/10	937 A6.000	1910	24x199		SK-1586AQ1	BTKW
2.0 16V T.SPARK	01/01-03/10	AR 32310	1970	24x168		SK-1361	BTK
2.0 16V T.SPARK	01/01-03/10	AR 32310	1970	24x168		SK-1361AQ1	BTKW
2.0 16V T.SPARK	01/01-03/10	AR 32310	1970	15x130		SK-1664	BTK
2.0 16V T.SPARK	01/01-03/10	AR 32310	1970	24x168; 15x130		SK-1755	BTK
2.0 16V T.SPARK	01/01-03/10	AR 32310	1970	24x168; 15x130		SK-1755AQ1	BTKW
1.6 16V T.SPARK , 1.6 16V T.SPARK ECO	01/01-03/10	AR 32104, AR 37203	1598			0-N194	TB [TE]
1.6 16V T.SPARK , 1.6 16V T.SPARK ECO	01/01-03/10	AR 32104, AR 37203	1598			0-N938	TB [DG]
1.9 JTD , 1.9 JTD 16V, 1.9 JTDM, 1.9 JTDM 16V, 1.9 JTDM 8V	04/01-03/10	182 B9.000, 192 A5.000, 192 B1.000, 937 A2.000, 937 A3.000, 937 A4.000, 937 A5.000, 937 A6.000, 939 A7.000	1910			0-N115	TB [TE]
1.9 JTD , 1.9 JTD 16V, 1.9 JTDM, 1.9 JTDM 16V, 1.9 JTDM 8V	04/01-03/10	182 B9.000, 192 A5.000, 192 B1.000, 937 A2.000, 937 A3.000, 937 A4.000, 937 A5.000, 937 A6.000, 939 A7.000	1910			0-N1326	TB [DG]
1.9 JTD 16V, 1.9 JTDM 16V	11/02-03/10	192 A5.000, 192 B1.000, 937 A4.000, 937 A5.000	1910	Abgasnorm: Euro 3 (D3)		0-N2149	TB [DG]
2.0	07/02-05/05	937 A1.000	1970			0-N194	TB [TE]
2.0, 2.0 16V T.SPARK	01/01-03/10	937 A1.000, AR 32310	1970			0-N114	TB [TE]
2.0, 2.0 16V T.SPARK	01/01-03/10	937 A1.000, AR 32310	1970			0-N1572	TB [TE]
2.0, 2.0 16V T.SPARK	01/01-03/10	937 A1.000, AR 32310	1970			0-N938	TB [DG]
3.2 GTA	02/03-03/10	932 A.000	3179			0-N1092	TB [TE]
3.2 GTA	02/03-03/10	932 A.000	3179			0-N1093	TB [DG]
1.6 16V T.SPARK	01/01-03/10	AR32104	1598	→ 09/2003		0-N1407	VB [BT] S

CM³

Art. Nr.



ohne Halter

147 (937)								
1.6 16V T.SPARK	01/01-03/10	AR32104	1598			0-N2117	VB [BT]	S
1.6 16V T.SPARK , 1.6 16V T.SPARK ECO	01/01-03/10	AR 32104, AR 37203	1598			0-N1403	VB [DG]	
1.6 16V T.SPARK ECO	01/01-03/10	AR 37203	1598	→ 09/2003		0-N1407	VB [BT]	S
1.6 16V T.SPARK ECO	01/01-03/10	AR 37203	1598			0-N2117	VB [BT]	S
1.9 JTD , 1.9 JTD 16V, 1.9 JTDM, 1.9 JTDM 16V, 1.9 JTDM 8V	04/01-03/10	182 B9.000, 192 A5.000, 192 B1.000, 937 A2.000, 937 A3.000, 937 A4.000, 937 A5.000, 937 A6.000, 939 A7.000	1910			0-N1487	VB [BT]	S
1.9 JTD, 1.9 JTD 16V, 1.9 JTDM, 1.9 JTDM 16V, 1.9 JTDM 8V	04/01-03/10	182 B9.000, 192 A5.000, 192 B1.000, 937 A2.000, 937 A3.000, 937 A4.000, 937 A5.000, 937 A6.000, 939 A7.000	1910			0-N1415	VB [DG]	
2.0 16V T.SPARK	01/01-03/10	AR 32310	1970	✳		0-N1628	VB [DG]	
2.0 16V T.SPARK	01/01-03/10	AR 32310	1970			0-N2117	VB [BT]	S
3.2 GTA	02/03-03/10	932 A.000	3179			0-N1408	VB [DG]	
3.2 GTA	02/03-03/10	932 A.000	3179			0-N1594	VB [DG]	
3.2 GTA	02/03-03/10	932 A.000	3179	†		0-N1595	VB [BT]	S
155 (167)								
1.6 16V T.S.	05/96-12/97	AR 67601	1598	24x166		SK-1415	BTK	
1.7 T.S. 16V	05/96-12/97	AR 67106	1747	24x168		SK-1361	BTK	
1.7 T.S. 16V	05/96-12/97	AR 67106	1747	24x168		SK-1361AQ1	BTKW	
1.9 TD	04/93-12/97	AR 67501	1929	22x173		SK-1033	BTK	
2.0 16V Turbo Q4	01/92-12/97	AR 67203	1995	18x173		SK-1050	BTK	
2.0 T.S. 16V	03/95-12/97	AR 67204, AR 67299	1970	24x168		SK-1361	BTK	
2.0 T.S. 16V	03/95-12/97	AR 67204, AR 67299	1970	24x168		SK-1361AQ1	BTKW	
2.0 T.S. 16V	03/95-12/97	AR 67204, AR 67299	1970	15x130; :0087812→		SK-1664	BTK	
2.0 T.S. 16V	03/95-12/97	AR 67204, AR 67299	1970	24x168; 15x130		SK-1755	BTK	
2.0 T.S. 16V	03/95-12/97	AR 67204, AR 67299	1970	24x168; 15x130		SK-1755AQ1	BTKW	
1.6 16V T.S.	05/96-12/97	AR 67601	1598			0-N194	TB [TE]	
1.6 16V T.S.	05/96-12/97	AR 67601	1598			0-N938	TB [DG]	
1.7 T.S. 16V	05/96-12/97	AR 67106	1747			0-N114	TB [TE]	
1.7 T.S. 16V	05/96-12/97	AR 67106	1747			0-N938	TB [DG]	
1.9 TD	04/93-12/97	AR 67501	1929			0-N835	TB [TE]	
1.9 TD	04/93-12/97	AR 67501	1929			0-N889	TB [DG]	
2.0 16V Turbo Q4	01/92-12/97	AR 67203	1995			0-N818	TB [TE]	
2.0 T.S. 16V	03/95-12/97	AR 67204, AR 67299	1970			0-N114	TB [TE]	
2.0 T.S. 16V	03/95-12/97	AR 67204, AR 67299	1970			0-N1572	TB [TE]	
2.0 T.S. 16V	03/95-12/97	AR 67204, AR 67299	1970			0-N938	TB [DG]	
1.6 16V T.S.	05/96-12/97	AR 67601	1598			0-N1403	VB [DG]	
1.6 16V T.S.	05/96-12/97	AR67601	1598			0-N1407	VB [BT]	S
1.7 T.S. 16V	05/96-12/97	AR 67106	1747			0-N1403	VB [DG]	
1.7 T.S. 16V	05/96-12/97	AR67106	1747			0-N1407	VB [BT]	S
2.0 T.S.	02/92-02/95	AR 67201, AR 67202	1995			0-N187	VB [DG]	
2.0 T.S. 16V	03/95-12/97	AR 67204, AR 67299	1970			0-N1407	VB [BT]	S
2.0 T.S. 16V	03/95-12/97	AR 67204, AR 67299	1970	✳		0-N1628	VB [DG]	
2.5 TD	04/93-12/97	VM 07 B, VM 31 B	2499			0-N2156	VB [DG]	
2.5 TD	04/93-12/97	VM 07 B, VM 31 B	2499			0-N2413	VB [VD]	
2.5 V6	02/92-12/97	AR 67301, AR 67302, AR 67303	2492			0-N1623	VB [TE]	
156 (932)								
1.6 16V T.SPARK	09/97-09/05	AR32102, AR32103, AR32104	1598	24x163; Baumuster: 932A4		SK-1365	BTK	
1.6 16V T.SPARK	09/97-09/05	AR32102, AR67601	1598	24x166		SK-1415	BTK	
1.6 16V T.SPARK	09/97-09/05	AR32103, AR32104	1598	24x163		SK-1697AQ1	BTKW	
1.8 16V T.SPARK	09/97-10/00	AR 32201	1747	24x168		SK-1361	BTK	
1.8 16V T.SPARK	09/97-10/00	AR 32201	1747	24x168		SK-1361AQ1	BTKW	
1.8 16V T.SPARK	10/00-09/05	AR 32205	1747	24x166		SK-1639	BTK	
1.9 JTD	09/97-09/05	937 A2.000, AR 32302, AR 37101	1910	24x190; mit Zubehör		SK-1629	BTK	
1.9 JTD	09/97-09/05	937 A2.000, AR 32302, AR 37101	1910	24x190; mit Zubehör		SK-1629AQ1	BTKW	
1.9 JTD	11/02-11/04	192 B1.000	1910	24x199		SK-1586	BTK	
1.9 JTD	11/03-09/05	937 A4.000, 937 A5.000	1910	24x199; Abgasnorm: Euro 4 (D4)		SK-1586	BTK	
1.9 JTD	07/04-09/05	937 A5.000	1910	24x199; Abgasnorm: Euro 4 (D4)		SK-1586AQ1	BTKW	
1.9 JTD	07/04-09/05	937 A5.000	1910	24x198; Abgasnorm: Euro 3 (D3); mit Zubehör		SK-1602	BTK	
1.9 JTD	07/04-09/05	937 A5.000	1910	24x198; Abgasnorm: Euro 3 (D3); mit Zubehör		SK-1602AQ1	BTKW	
1.9 JTD, 1.9 JTD 16V	11/02-09/05	192 A5.000, 192 B1.000, 937 A4.000	1910	24x198; mit Zubehör		SK-1602	BTK	
1.9 JTD, 1.9 JTD 16V	11/02-09/05	192 A5.000, 192 B1.000, 937 A4.000	1910	24x198; mit Zubehör		SK-1602AQ1	BTKW	
2.0 16V T.SPARK , 2.0 JTS	09/97-09/05	937 A1.000, AR 32301, AR 32310	1970	15x130		SK-1664	BTK	



OPTIMAL®

ALFA ROMEO



CM³



Art. Nr.



ohne Halter

156 (932)

2.0 16V T.SPARK , 2.0 Twin Spark	09/97-09/05	932 A2.000, AR 32301, AR 32310	1970	24x168		SK-1361	BTK	
2.0 16V T.SPARK , 2.0 Twin Spark	09/97-09/05	932 A2.000, AR 32301, AR 32310	1970	24x168		SK-1361AQ1	BTKW	
2.0 16V T.SPARK , 2.0 Twin Spark	09/97-09/05	932 A2.000, AR 32301, AR 32310	1970	24x168; 15x130		SK-1755	BTK	
2.0 16V T.SPARK , 2.0 Twin Spark	09/97-09/05	932 A2.000, AR 32301, AR 32310	1970	24x168; 15x130		SK-1755AQ1	BTKW	
2.0 JTS	03/02-09/05	937 A1.000	1970	24x168		SK-1410	BTK	
2.0 JTS	03/02-09/05	937 A1.000	1970	24x168		SK-1410AQ1	BTKW	
2.0 JTS	03/02-09/05	937 A1.000	1970	24x168; 15x130		SK-1756	BTK	
2.4 JTD	09/97-09/03	AR 32501	2387	24x190; Baumuster: 932B1		SK-1112	BTK	
2.4 JTD	09/97-09/05	839 A6.000, 841 C000, AR 32501	2387	24x190		SK-1112AQ1	BTKW	
2.4 JTD	10/00-09/05	839 A6.000	2387	24x190; Baumuster: 932A1B_		SK-1112	BTK	
2.4 JTD	03/02-09/05	841 C000	2387	24x190; Baumuster: 932AXC		SK-1112	BTK	
2.4 JTD	10/03-09/05	841 G.000	2387	24x198		SK-1367	BTK	
2.4 JTD	10/03-09/05	841 G.000	2387	24x198		SK-1367AQ1	BTKW	
1.6 16V T.SPARK	09/97-09/05	AR 32102, AR 32103, AR 32104, AR 67601	1598			0-N194	TB [TE]	
1.6 16V T.SPARK	09/97-09/05	AR 32102, AR 32103, AR 32104, AR 67601	1598			0-N938	TB [DG]	
1.8 16V T.SPARK	09/97-09/05	AR 32201, AR 32205	1747			0-N114	TB [TE]	
1.8 16V T.SPARK	09/97-09/05	AR 32201, AR 32205	1747			0-N938	TB [DG]	
1.9 JTD , 1.9 JTD 16V	09/97-09/05	192 A5.000, 192 B1.000, 937 A2.000, 937 A4.000, 937 A5.000, AR 32302, AR 37101	1910			0-N115	TB [TE]	
1.9 JTD , 1.9 JTD 16V	09/97-09/05	192 A5.000, 192 B1.000, 937 A2.000, 937 A4.000, 937 A5.000, AR 32302, AR 37101	1910			0-N1326	TB [DG]	
1.9 JTD, 1.9 JTD 16V	11/02-09/05	192 A5.000, 192 B1.000, 937 A4.000	1910	ABGAS (ENGINE):4109228→; Abgasnorm: Euro 3 (D3)		0-N2149	TB [DG]	
2.0 16V T.SPARK , 2.0 JTS , 2.0 Twin Spark	09/97-09/05	932 A2.000, 937 A1.000, AR 32301, AR 32310	1970			0-N1572	TB [TE]	
2.0 16V T.SPARK , 2.0 JTS , 2.0 Twin Spark	09/97-09/05	932 A2.000, 937 A1.000, AR 32301, AR 32310	1970			0-N938	TB [DG]	
2.0 16V T.SPARK , 2.0 Twin Spark	09/97-09/05	932 A2.000, AR 32301, AR 32310	1970			0-N114	TB [TE]	
2.0 JTS	03/02-09/05	937 A1.000	1970			0-N194	TB [TE]	
2.4 JTD	09/97-09/05	839 A6.000, 841 C000, 841 G.000, 841 M.000, 841 N.000, AR 32501	2387			0-N115	TB [TE]	
2.4 JTD	09/97-09/05	839 A6.000, 841 C000, 841 G.000, 841 M.000, 841 N.000, AR 32501	2387			0-N950	TB [DG]	
2.5 V6 24V	09/97-09/05	AR 32401, AR 32402, AR 32405	2492			0-N1092	TB [TE]	
2.5 V6 24V	09/97-09/05	AR 32401, AR 32402, AR 32405	2492			0-N1093	TB [DG]	
3.2 GTA	03/02-09/05	932 A.000	3179			0-N1092	TB [TE]	
3.2 GTA	03/02-09/05	932 A.000	3179			0-N1093	TB [DG]	
1.6 16V T.SPARK	09/97-09/05	AR 32102, AR 32103, AR 32104, AR 67601	1598			0-N1403	VB [DG]	
1.6 16V T.SPARK	09/97-09/05	AR32102	1598			0-N1407	VB [BT]	S
1.6 16V T.SPARK	09/97-09/05	AR32103	1598			0-N1407	VB [BT]	S
1.6 16V T.SPARK	09/97-09/05	AR32104	1598			0-N1407	VB [BT]	S
1.6 16V T.SPARK	09/97-09/05	AR67601	1598			0-N1407	VB [BT]	S
1.6 16V T.SPARK	09/97-09/05	AR32104	1598	→ 06/2004		0-N2117	VB [BT]	S
1.8 16V T.SPARK	09/97-09/05	AR 32201, AR 32205	1747			0-N1403	VB [DG]	
1.8 16V T.SPARK	09/97-09/05	AR 32201, AR 32205	1747			0-N1407	VB [BT]	S
1.8 16V T.SPARK	10/00-09/05	AR 32205	1747	09/2003 →		0-N2117	VB [BT]	S
1.9 JTD	09/97-10/00	AR 32302	1910	→ 04/1998		0-N1407	VB [BT]	S
1.9 JTD	09/97-10/00	AR 32302	1910	04/1998 →; ⚠; ⚠		0-N1487	VB [BT]	S
1.9 JTD , 1.9 JTD 16V	09/97-09/05	192 A5.000, 192 B1.000, 937 A2.000, 937 A4.000, 937 A5.000, AR 32302, AR 37101	1910			0-N1415	VB [DG]	
1.9 JTD , 1.9 JTD 16V	10/00-09/05	192 A5.000, 192 B1.000, 937 A2.000, 937 A4.000, 937 A5.000, AR 37101	1910			0-N1487	VB [BT]	S
2.0 16V T.SPARK	09/97-03/02	AR 32301, AR 32310	1970			0-N1407	VB [BT]	S
2.0 16V T.SPARK , 2.0 JTS , 2.0 Twin Spark	09/97-09/05	932 A2.000, 937 A1.000, AR 32301, AR 32310	1970	⚠		0-N1628	VB [DG]	
2.0 JTS	03/02-09/05	937 A1.000	1970			0-N2117	VB [BT]	S
2.4 JTD	09/97-09/05	839 A6.000, 841 C000, 841 G.000, 841 M.000, 841 N.000, AR 32501	2387			0-N1404	VB [DG]	
2.4 JTD	09/97-09/05	839 A6.000, 841 C000, 841 G.000, 841 M.000, 841 N.000, AR 32501	2387	†		0-N1490S	VB [TE]	
2.4 JTD	09/97-09/05	839 A6.000, 841 C000, 841 G.000, 841 M.000, 841 N.000, AR 32501	2387			0-N1894	VB [BT]	
2.4 JTD	09/97-09/05	839 A6.000, 841 C000, 841 G.000, 841 M.000, 841 N.000, AR 32501	2387			0-N1916	VB [BT]	
2.5 V6 24V	09/97-09/05	AR 32401, AR 32402, AR 32405	2492			0-N1408	VB [DG]	
2.5 V6 24V	09/97-09/05	AR 32401, AR 32402, AR 32405	2492			0-N1594	VB [DG]	
2.5 V6 24V	09/97-09/05	AR 32401, AR 32402, AR 32405	2492	†		0-N1595	VB [BT]	S
3.2 GTA	03/02-09/05	932 A.000	3179			0-N1594	VB [DG]	
3.2 GTA	03/02-09/05	932 A.000	3179	†		0-N1595	VB [BT]	S

CM³

Art. Nr.



ohne Halter

156 Sportwagon (932)

1.6 16V T.SPARK.	05/00-05/06	AR32104, AR67601	1598	24x163; Baumuster: 932A4	SK-1365	BTK	
1.6 16V T.SPARK.	05/00-05/06	AR32103, AR32104	1598	24x163	SK-1697AQ1	BTKW	
1.8 16V T.SPARK	05/00-10/00	AR 32201	1747	24x168	SK-1361	BTK	
1.8 16V T.SPARK	05/00-10/00	AR 32201	1747	24x168	SK-1361AQ1	BTKW	
1.8 16V T.SPARK	10/00-05/06	AR 32205	1747	24x166	SK-1639	BTK	
1.9 JTD	05/00-05/06	937 A2.000, AR 32302, AR 37101	1910	24x190; mit Zubehör	SK-1629	BTK	
1.9 JTD	05/00-05/06	937 A2.000, AR 32302, AR 37101	1910	24x190; mit Zubehör	SK-1629AQ1	BTKW	
1.9 JTD	11/02-11/04	192 B1.000	1910	24x199	SK-1586	BTK	
1.9 JTD, 1.9 JTD 16V	11/02-05/06	192 A5.000, 192 B1.000	1910	24x198; mit Zubehör	SK-1602	BTK	
1.9 JTD, 1.9 JTD 16V	11/02-05/06	192 A5.000, 192 B1.000, 937 A4.000	1910	24x198; mit Zubehör	SK-1602AQ1	BTKW	
1.9 JTD, 1.9 JTD 16V Q4	11/03-05/06	937 A4.000, 937 A5.000	1910	24x199; Abgasnorm: Euro 4 (D4)	SK-1586	BTK	
1.9 JTD, 1.9 JTD 16V Q4	11/03-05/06	937 A4.000, 937 A5.000	1910	24x198; Abgasnorm: Euro 3 (D3); mit Zubehör	SK-1602	BTK	
1.9 JTD, 1.9 JTD 16V Q4	07/04-05/06	937 A5.000	1910	24x199; Abgasnorm: Euro 4 (D4)	SK-1586AQ1	BTKW	
1.9 JTD, 1.9 JTD 16V Q4	07/04-05/06	937 A5.000	1910	24x198; Abgasnorm: Euro 3 (D3); mit Zubehör	SK-1602AQ1	BTKW	
2.0 16V T.SPARK	05/00-06/02	AR 32301, AR 32310	1970	24x168	SK-1361	BTK	
2.0 16V T.SPARK	05/00-06/02	AR 32301, AR 32310	1970	24x168	SK-1361AQ1	BTKW	
2.0 16V T.SPARK	05/00-06/02	AR 32301, AR 32310	1970	24x168; 15x130	SK-1755	BTK	
2.0 16V T.SPARK	05/00-06/02	AR 32301, AR 32310	1970	24x168; 15x130	SK-1755AQ1	BTKW	
2.0 16V T.SPARK, 2.0 JTS	05/00-05/06	937 A1.000, AR 32301, AR 32310	1970	15x130	SK-1664	BTK	
2.0, 2.0 JTS	03/02-05/06	932 A2.000, 937 A1.000	1970	24x168	SK-1410	BTK	
2.0, 2.0 JTS	03/02-05/06	932 A2.000, 937 A1.000	1970	24x168	SK-1410AQ1	BTKW	
2.0, 2.0 JTS	03/02-05/06	932 A2.000, 937 A1.000	1970	24x168; 15x130	SK-1756	BTK	
2.4 JTD	05/00-09/03	AR 32501	2387	24x190; Baumuster: 932B1	SK-1112	BTK	
2.4 JTD	05/00-05/06	839 A6.000, 841 C000, AR 32501	2387	24x190	SK-1112AQ1	BTKW	
2.4 JTD	10/00-05/06	839 A6.000	2387	24x190; Baumuster: 932B1B_	SK-1112	BTK	
2.4 JTD	03/02-05/06	841 C000	2387	24x190; Baumuster: 932BXC	SK-1112	BTK	
2.4 JTD	10/03-05/06	841 G.000	2387	24x198	SK-1367	BTK	
2.4 JTD	10/03-05/06	841 G.000	2387	24x198	SK-1367AQ1	BTKW	
1.6 16V T.SPARK.	05/00-05/06	AR 32102, AR 32103, AR 32104, AR 67601	1598		0-N194	TB [TE]	
1.6 16V T.SPARK.	05/00-05/06	AR 32102, AR 32103, AR 32104, AR 67601	1598		0-N938	TB [DG]	
1.8 16V T.SPARK	05/00-05/06	AR 32201, AR 32205	1747		0-N114	TB [TE]	
1.8 16V T.SPARK	05/00-05/06	AR 32201, AR 32205	1747		0-N938	TB [DG]	
1.9 JTD, 1.9 JTD 16V, 1.9 JTD 16V Q4	05/00-05/06	192 A5.000, 192 B1.000, 937 A2.000, 937 A4.000, 937 A5.000, AR 32302, AR 37101	1910		0-N115	TB [TE]	
1.9 JTD, 1.9 JTD 16V, 1.9 JTD 16V Q4	05/00-05/06	192 A5.000, 192 B1.000, 937 A2.000, 937 A4.000, 937 A5.000, AR 32302, AR 37101	1910		0-N1326	TB [DG]	
1.9 JTD, 1.9 JTD 16V	11/02-05/06	192 A5.000, 192 B1.000, 937 A4.000	1910	4109228→; Abgasnorm: Euro 3 (D3)	0-N2149	TB [DG]	
2.0 16V T.SPARK	05/00-06/02	AR 32301, AR 32310	1970		0-N114	TB [TE]	
2.0, 2.0 16V T.SPARK, 2.0 JTS	05/00-05/06	932 A2.000, 937 A1.000, AR 32301, AR 32310	1970		0-N1572	TB [TE]	
2.0, 2.0 16V T.SPARK, 2.0 JTS	05/00-05/06	932 A2.000, 937 A1.000, AR 32301, AR 32310	1970		0-N938	TB [DG]	
2.0, 2.0 JTS	03/02-05/06	932 A2.000, 937 A1.000	1970		0-N194	TB [TE]	
2.4 JTD	05/00-05/06	839 A6.000, 841 C000, 841 G.000, 841 M.000, 841 N.000, AR 32501	2387		0-N115	TB [TE]	
2.4 JTD	05/00-05/06	839 A6.000, 841 C000, 841 G.000, 841 M.000, 841 N.000, AR 32501	2387		0-N950	TB [DG]	
2.5 V6 24V	05/00-05/06	AR 32401, AR 32405	2492		0-N1092	TB [TE]	
2.5 V6 24V	05/00-05/06	AR 32401, AR 32405	2492		0-N1093	TB [DG]	
3.2 GTA	03/02-05/06	932 A.000	3179		0-N1092	TB [TE]	
3.2 GTA	03/02-05/06	932 A.000	3179		0-N1093	TB [DG]	
1.6 16V T.SPARK.	05/00-05/06	AR 32102, AR 32103, AR 32104, AR 67601	1598		0-N1403	VB [DG]	
1.6 16V T.SPARK.	05/00-05/06	AR32104	1598		0-N1407	VB [BT]	S
1.6 16V T.SPARK.	05/00-05/06	AR67601	1598		0-N1407	VB [BT]	S
1.6 16V T.SPARK.	05/00-05/06	AR32104	1598	→ 06/2004	0-N2117	VB [BT]	S
1.8 16V T.SPARK	05/00-05/06	AR 32201, AR 32205	1747		0-N1403	VB [DG]	
1.8 16V T.SPARK	05/00-05/06	AR 32201, AR 32205	1747		0-N1407	VB [BT]	S
1.8 16V T.SPARK	10/00-05/06	AR 32205	1747	09/2003 →	0-N2117	VB [BT]	S
1.9 JTD, 1.9 JTD 16V, 1.9 JTD 16V Q4	05/00-05/06	192 A5.000, 192 B1.000, 937 A2.000, 937 A4.000, 937 A5.000, AR 32302, AR 37101	1910		0-N1487	VB [BT]	S
1.9 JTD, 1.9 JTD 16V, 1.9 JTD 16V Q4	05/00-05/06	192 A5.000, 192 B1.000, 937 A2.000, 937 A4.000, 937 A5.000, AR 32302, AR 37101	1910		0-N1415	VB [DG]	
2.0 16V T.SPARK	05/00-06/02	AR 32301, AR 32310	1970		0-N1407	VB [BT]	S
2.0, 2.0 16V T.SPARK, 2.0 JTS	05/00-05/06	932 A2.000, 937 A1.000, AR 32301, AR 32310	1970	✳	0-N1628	VB [DG]	
2.0, 2.0 JTS	03/02-05/06	932 A2.000, 937 A1.000	1970		0-N2117	VB [BT]	S



OPTIMAL®

ALFA ROMEO

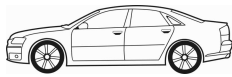

CM³



Art. Nr.



156 Sportwagon (932)

2.4 JTD	05/00-05/06	839 A6.000, 841 C000, 841 G.000, 841 M.000, 841 N.000, AR 32501	2387		0-N1404	VB [DG]	
2.4 JTD	05/00-05/06	839 A6.000, 841 C000, 841 G.000, 841 M.000, 841 N.000, AR 32501	2387	†	0-N1490S	VB [TE]	
2.4 JTD	05/00-05/06	839 A6.000, 841 C000, 841 G.000, 841 M.000, 841 N.000, AR 32501	2387		0-N1894	VB [BT]	
2.4 JTD	05/00-05/06	839 A6.000, 841 C000, 841 G.000, 841 M.000, 841 N.000, AR 32501	2387		0-N1916	VB [BT]	
2.5 V6 24V	05/00-05/06	AR 32401, AR 32405	2492		0-N1408	VB [DG]	
2.5 V6 24V	05/00-05/06	AR 32401, AR 32405	2492		0-N1594	VB [DG]	
2.5 V6 24V	05/00-05/06	AR 32401, AR 32405	2492	†	0-N1595	VB [BT]	S
3.2 GTA	03/02-05/06	932 A.000	3179		0-N1594	VB [DG]	
3.2 GTA	03/02-05/06	932 A.000	3179	†	0-N1595	VB [BT]	S

159 (939)

1.8 MPI	03/07-11/11	939 A4.000	1796	24x146	SK-1607	BTK	
1.8 TBi	05/09-11/11	939 B1.000	1742	24x171	SK-1733	BTK	
1.8 TBi	05/09-11/11	939 B1.000	1742	24x171	SK-1733AQ1	BTKW	
1.9 JTDM 16V	09/05-11/11	937 A8.000	1910	24x199; 04/2006 →; Baumuster: 939	SK-1586	BTK	
1.9 JTDM 16V	09/05-11/11	939 A2.000	1910	24x199; Baumuster: 939	SK-1586	BTK	
1.9 JTDM 16V	09/05-11/11	937 A8.000, 939 A8.000, 939 A2.000	1910	24x199	SK-1586AQ1	BTKW	
1.9 JTDM 8V	09/05-11/11	937 A7.000, 939 A7.000	1910	24x190; mit Zubehör	SK-1629	BTK	
1.9 JTDM 8V	09/05-11/11	939 A1.000	1910	24x190	SK-1696	BTK	
1.9 JTDM 8V	09/05-11/11	937 A7.000, 939 A7.000	1910	24x190; 12/2005 →	SK-1696	BTK	
1.9 JTDM 8V	09/05-11/11	937 A7.000, 939 A7.000, 939 A1.000	1910	24x190	SK-1696AQ1	BTKW	
2.0 JTDM	05/09-11/11	844 A2.000, 939 B3.000, 939 B4.000	1956	24x199	SK-1586	BTK	
2.0 JTDM	05/09-11/11	844 A2.000, 939 B3.000, 939 B4.000	1956	24x199	SK-1586AQ1	BTKW	
2.4 JTDM, 2.4 JTDM Q4	09/05-11/11	939 A3.000, 939 A9.000	2387	24x199	SK-1587	BTK	
2.4 JTDM, 2.4 JTDM Q4	09/05-11/11	939 A3.000, 939 A9.000	2387	24x199	SK-1587AQ1	BTKW	
1.8 MPI	03/07-11/11	939 A4.000	1796		0-N1347	TB [TE]	
1.8 MPI	03/07-11/11	939 A4.000	1796		0-N1348	TB [DG]	
1.8 TBi	05/09-11/11	939 B1.000	1742		0-N2149	TB [DG]	
1.8 TBi	05/09-11/11	939 B1.000	1742		0-N2150	TB [TE]	
1.9 JTDM 16V, 1.9 JTDM 8V	09/05-11/11	937 A7.000, 939 A7.000, 937 A8.000, 939 A8.000, 939 A1.000, 939 A2.000	1910		0-N115	TB [TE]	
1.9 JTDM 16V, 1.9 JTDM 8V	09/05-11/11	937 A7.000, 939 A7.000, 937 A8.000, 939 A8.000, 939 A1.000, 939 A2.000	1910		0-N2149	TB [DG]	
2.0 JTDM	05/09-11/11	844 A2.000, 939 B3.000, 939 B4.000	1956		0-N115	TB [TE]	
2.0 JTDM	05/09-11/11	844 A2.000, 939 B3.000, 939 B4.000	1956		0-N2149	TB [DG]	
2.4 JTDM, 2.4 JTDM Q4	09/05-11/11	939 A3.000, 939 A9.000	2387		0-N115	TB [TE]	
2.4 JTDM, 2.4 JTDM Q4	09/05-11/11	939 A3.000, 939 A9.000	2387		0-N950	TB [DG]	
1.8 MPI	03/07-11/11	939 A4.000	1796		0-N1799	VB [BT]	S
1.8 TBi	05/09-11/11	939 B1.000	1742		0-N1503	VB [BT]	S
1.8 TBi	05/09-11/11	939 B1.000	1742	⊛	0-N1522	VB [DG]	
1.8 TBi	05/09-11/11	939 B1.000	1742		0-N2049	VB [DG]	
1.9 JTDM 16V, 1.9 JTDM 8V	09/05-11/11	937 A7.000, 939 A7.000, 937 A8.000, 939 A8.000, 939 A1.000, 939 A2.000	1910		0-N1503	VB [BT]	S
1.9 JTDM 16V, 1.9 JTDM 8V	09/05-11/11	937 A7.000, 939 A7.000, 937 A8.000, 939 A8.000, 939 A1.000, 939 A2.000	1910		0-N1522	VB [DG]	
1.9 JTDM 16V, 1.9 JTDM 8V	09/05-11/11	937 A7.000, 939 A7.000, 937 A8.000, 939 A8.000, 939 A1.000, 939 A2.000	1910		0-N1976	VB [DG]	
1.9 JTS	09/05-11/11	939 A6.000	1859		0-N1588	VB [BT]	S
2.0 JTDM	05/09-11/11	939 B3.000, 939 B4.000	1956		0-N1503	VB [BT]	S
2.0 JTDM	05/09-11/11	844 A2.000, 939 B3.000	1956		0-N1522	VB [DG]	
2.0 JTDM	05/09-11/11	939 B3.000, 939 B4.000	1956		0-N2049	VB [DG]	
2.0 JTDM	06/10-11/11	939 B4.000	1956	⊛	0-N1522	VB [DG]	
2.2 JTS	09/05-11/11	939 A5.000	2198		0-N1588	VB [BT]	S
2.4 JTDM, 2.4 JTDM Q4	09/05-11/11	939 A3.000, 939 A9.000	2387		0-N1522	VB [DG]	
2.4 JTDM, 2.4 JTDM Q4	09/05-11/11	939 A3.000, 939 A9.000	2387		0-N2093	VB [BT]	S
3.2 JTS, 3.2 JTS Q4	12/05-11/11	939 A.000	3195		0-N2194	VB [BT]	S

159 Sportwagon (939)

1.8 MPI	03/07-11/11	939 A4.000	1796	24x146	SK-1607	BTK	
1.8 TBi	05/09-11/11	939 B1.000	1742	24x171	SK-1733	BTK	
1.8 TBi	05/09-11/11	939 B1.000	1742	24x171	SK-1733AQ1	BTKW	
1.9 JTDM 16V	03/06-11/11	937 A8.000, 939 A2.000	1910	24x199; Baumuster: 939	SK-1586	BTK	
1.9 JTDM 16V	03/06-11/11	937 A8.000, 939 A2.000	1910	24x199	SK-1586AQ1	BTKW	
1.9 JTDM 8V	03/06-11/11	937 A7.000, 939 A1.000	1910	24x190	SK-1696	BTK	
1.9 JTDM 8V	03/06-11/11	937 A7.000, 939 A1.000	1910	24x190	SK-1696AQ1	BTKW	

CM³

Art. Nr.

**159 Sportwagon (939)**

2.0 JTDM	05/09-11/11	844 A2.000, 939 B3.000, 939 B4.000	1956	24x199	SK-1586	BTK	
2.0 JTDM	05/09-11/11	844 A2.000, 939 B3.000, 939 B4.000	1956	24x199	SK-1586AQ1	BTKW	
2.4 JTDM	03/06-11/11	939 A3.000, 939 A9.000	2387	24x199	SK-1587	BTK	
2.4 JTDM Q4	05/07-11/11	939 A9.000	2387	24x199; 09/2007 →	SK-1587	BTK	
2.4 JTDM, 2.4 JTDM Q4	03/06-11/11	939 A3.000, 939 A9.000	2387	24x199	SK-1587AQ1	BTKW	
1.8 MPI	03/07-11/11	939 A4.000	1796		0-N1347	TB [TE]	
1.8 MPI	03/07-11/11	939 A4.000	1796		0-N1348	TB [DG]	
1.8 TBi	05/09-11/11	939 B1.000	1742		0-N2149	TB [DG]	
1.8 TBi	05/09-11/11	939 B1.000	1742		0-N2150	TB [TE]	
1.9 JTDM 16V, 1.9 JTDM 8V	03/06-11/11	937 A7.000, 937 A8.000, 939 A1.000, 939 A2.000	1910		0-N115	TB [TE]	
1.9 JTDM 16V, 1.9 JTDM 8V	03/06-11/11	937 A7.000, 937 A8.000, 939 A1.000, 939 A2.000	1910		0-N2149	TB [DG]	
2.0 JTDM	05/09-11/11	844 A2.000, 939 B3.000, 939 B4.000	1956		0-N115	TB [TE]	
2.0 JTDM	05/09-11/11	844 A2.000, 939 B3.000, 939 B4.000	1956		0-N2149	TB [DG]	
2.4 JTDM, 2.4 JTDM Q4	03/06-11/11	939 A3.000, 939 A9.000	2387		0-N115	TB [TE]	
2.4 JTDM, 2.4 JTDM Q4	03/06-11/11	939 A3.000, 939 A9.000	2387		0-N950	TB [DG]	
1.8 MPI	03/07-11/11	939 A4.000	1796		0-N1799	VB [BT]	S
1.8 TBi	05/09-11/11	939 B1.000	1742		0-N1503	VB [BT]	S
1.8 TBi	05/09-11/11	939 B1.000	1742	✳	0-N1522	VB [DG]	
1.8 TBi	05/09-11/11	939 B1.000	1742		0-N2049	VB [DG]	
1.9 JTDM 16V, 1.9 JTDM 8V	03/06-11/11	937 A7.000, 937 A8.000, 939 A1.000, 939 A2.000	1910		0-N1503	VB [BT]	S
1.9 JTDM 16V, 1.9 JTDM 8V	03/06-11/11	937 A7.000, 937 A8.000, 939 A1.000, 939 A2.000	1910		0-N1522	VB [DG]	
1.9 JTDM 16V, 1.9 JTDM 8V	03/06-11/11	937 A7.000, 937 A8.000, 939 A1.000, 939 A2.000	1910		0-N1976	VB [DG]	
1.9 JTS	03/06-11/11	939 A6.000	1859		0-N1588	VB [BT]	S
2.0 JTDM	05/09-11/11	939 B3.000, 939 B4.000	1956		0-N1503	VB [BT]	S
2.0 JTDM	05/09-11/11	844 A2.000, 939 B3.000, 939 B4.000	1956		0-N1522	VB [DG]	
2.0 JTDM	05/09-11/11	939 B3.000, 939 B4.000	1956		0-N2049	VB [DG]	
2.2 JTS	03/06-11/11	939 A5.000	2198		0-N1588	VB [BT]	S
2.4 JTDM, 2.4 JTDM Q4	03/06-11/11	939 A3.000, 939 A9.000	2387		0-N1522	VB [DG]	
2.4 JTDM, 2.4 JTDM Q4	03/06-11/11	939 A3.000, 939 A9.000	2387		0-N2093	VB [BT]	S
3.2 JTS, 3.2 JTS Q4	03/06-11/11	939 A.000	3195		0-N2194	VB [BT]	S

164 (164)

2.0 Turbo	10/87-09/98	AR 06476	1995	18x142	SK-1155	BTK	
2.5 TD	09/92-09/98	VM 08 B, VM 32 B	2499	✳	0-N1546	VB [DG]	
2.5 TD	09/92-09/98	VM 08 B, VM 32 B	2499		0-N2156	VB [DG]	
2.5 TD	09/92-09/98	VM 08 B, VM 32 B	2499		0-N2413	VB [VD]	
3.0 24V	09/92-09/98	AR 64306, AR 66301, AR 66302	2959		0-N2413	VB [VD]	
3.0 24V QV	09/92-09/98	AR 64304	2959		0-N2412	VB [VD]	
3.0 V6	09/92-09/98	AR 64303, AR 64305, AR 64399, AR 66303	2959		0-N1623	VB [TE]	

166 (936)

2.0 T.Spark	09/98-06/07	AR 34103, AR 36301	1970	24x168	SK-1361	BTK	
2.0 T.Spark	09/98-06/07	AR 34103, AR 36301	1970	24x168	SK-1361AQ1	BTKW	
2.0 T.Spark	09/98-06/07	AR 34103, AR 36301	1970	15x130	SK-1664	BTK	
2.0 T.Spark	09/98-06/07	AR 34103, AR 36301	1970	24x168; 15x130	SK-1755	BTK	
2.0 T.Spark	09/98-06/07	AR 34103, AR 36301	1970	24x168; 15x130	SK-1755AQ1	BTKW	
2.4 JTD	09/98-10/00	AR 34202	2387	24x190; Baumuster: 936A2A_	SK-1112	BTK	
2.4 JTD	09/98-06/07	839 A6.000, 841 C000, AR 34202	2387	24x190	SK-1112AQ1	BTKW	
2.4 JTD	10/00-06/07	839 A6.000	2387	24x190; Baumuster: 936A2B_	SK-1112	BTK	
2.4 JTD	04/02-06/07	841 C000	2387	24x190; Baumuster: 936	SK-1112	BTK	
2.4 JTD	10/03-06/07	841 G.000, 841 H.000, 841 M.000, 841 N.000	2387	24x198	SK-1367	BTK	
2.4 JTD	10/03-06/07	841 G.000, 841 H.000, 841 M.000, 841 N.000	2387	24x198	SK-1367AQ1	BTKW	
2.4 JTD	07/05-06/07	841 M.000, 841 M.000, 936 B.000	2387	24x199	SK-1587	BTK	
2.4 JTD	07/05-06/07	841 M.000, 841 M.000, 936 B.000	2387	24x199	SK-1587AQ1	BTKW	
2.0 T.Spark	09/98-06/07	AR 34103, AR 36301	1970		0-N114	TB [TE]	
2.0 T.Spark	09/98-06/07	AR 34103, AR 36301	1970		0-N1572	TB [TE]	
2.0 T.Spark	09/98-06/07	AR 34103, AR 36301	1970		0-N938	TB [DG]	
2.4 JTD	09/98-06/07	839 A6.000, 841 C000, 841 G.000, 841 H.000, 841 M.000, 841 M.000, 936 B.000, AR 34202	2387		0-N115	TB [TE]	



OPTIMAL®

ALFA ROMEO



CM³



Art. Nr.



ohne Halter

166 (936)								
2.4 JTD	09/98-06/07	839 A6.000, 841 C000, 841 G.000, 841 H.000, 841 M.000, 841 M.000, 936 B.000, AR 34202	2387				0-N950	TB [DG]
2.5 V6 24V	09/98-06/07	AR 34201, AR 36201	2492				0-N1092	TB [TE]
2.5 V6 24V	09/98-06/07	AR 34201, AR 36201	2492				0-N1093	TB [DG]
3.0 V6 24V	09/98-06/07	AR 34301, AR 34302, AR 36101	2959				0-N1092	TB [TE]
3.0 V6 24V	09/98-06/07	AR 34301, AR 34302, AR 36101	2959				0-N1093	TB [DG]
2.0 T.Spark	09/98-06/07	AR 34103, AR 36301	1970	*			0-N1628	VB [DG]
2.0 V6	09/98-10/00	AR 34102	1996				0-N1408	VB [DG]
2.0 V6	09/98-10/00	AR 34102	1996				0-N1594	VB [DG]
2.0 V6	09/98-10/00	AR 34102	1996	†			0-N1595	VB [BT] S
2.4 JTD	09/98-06/07	839 A6.000, 841 C000, 841 G.000, 841 H.000, 841 M.000, 841 M.000, 936 B.000, AR 34202	2387				0-N1404	VB [DG]
2.4 JTD	09/98-06/07	839 A6.000, 841 C000, 841 G.000, 841 H.000, AR 34202	2387	†			0-N1490S	VB [TE]
2.4 JTD	09/98-06/07	839 A6.000, 841 C000, 841 G.000, 841 H.000, 841 M.000, 841 M.000, 936 B.000, AR 34202	2387				0-N1652	VB [BT]
2.4 JTD	09/98-06/07	839 A6.000, 841 C000, 841 G.000, 841 H.000, AR 34202	2387				0-N1916	VB [BT]
2.5 V6 24V	09/98-06/07	AR 34201, AR 36201	2492				0-N1408	VB [DG]
2.5 V6 24V	09/98-06/07	AR 34201, AR 36201	2492				0-N1594	VB [DG]
2.5 V6 24V	09/98-06/07	AR 34201, AR 36201	2492	†			0-N1595	VB [BT] S
3.0 V6 24V	09/98-06/07	AR 34301, AR 34302, AR 36101	2959				0-N1408	VB [DG]
3.0 V6 24V	09/98-06/07	AR 34301, AR 34302, AR 36101	2959				0-N1594	VB [DG]
3.0 V6 24V	09/98-06/07	AR 34301, AR 34302, AR 36101	2959	†			0-N1595	VB [BT] S
ALFASUD (901)								
1.2, 1.2 ti	06/72-09/84	AR 30102, AR 30102 S, AR 30104	1186				0-N800	TB [TE]
1.2, 1.2 ti	06/72-09/84	AR 30102, AR 30102 S, AR 30104	1186				0-N801	TB [TE]
1.3, 1.3 ti	09/77-09/84	AR 30180, AR 30184	1286				0-N800	TB [TE]
1.3, 1.3 ti	09/77-09/84	AR 30180, AR 30184	1286				0-N801	TB [TE]
1.3 SC/ti Super, 1.3 Super, 1.3 ti	09/77-12/84	AR 30160, AR 30164, AR 30168	1351				0-N800	TB [TE]
1.3 SC/ti Super, 1.3 Super, 1.3 ti	09/77-12/84	AR 30160, AR 30164, AR 30168	1351				0-N801	TB [TE]
1.5 ti, 1.5 ti Sprint	01/79-12/84	AR 30124, AR 30128, AR 30146	1490				0-N800	TB [TE]
1.5 ti, 1.5 ti Sprint	01/79-12/84	AR 30124, AR 30128, AR 30146	1490				0-N801	TB [TE]
ALFASUD Sprint (902.A)								
1.7, 1.7 i.e.	03/87-12/89	AR 30550, AR 30558	1712	17x100; 01/1989 →			SK-1065	BTK
1.3	09/76-12/81	AR 30184	1286				0-N800	TB [TE]
1.3	09/76-12/81	AR 30184	1286				0-N801	TB [TE]
1.4	05/78-12/89	AR 30164, AR 30168	1351				0-N800	TB [TE]
1.4	05/78-12/89	AR 30164, AR 30168	1351				0-N801	TB [TE]
1.5	05/78-12/87	AR 30124, AR 30128, AR 30146	1490				0-N800	TB [TE]
1.5	05/78-12/87	AR 30124, AR 30128, AR 30146	1490				0-N801	TB [TE]
1.7, 1.7 i.e.	03/87-12/89	AR 30550, AR 30558	1712				0-N800	TB [TE]
1.7, 1.7 i.e.	03/87-12/89	AR 30550, AR 30558	1712				0-N801	TB [TE]
ALFASUD Giardinetta (904)								
1.2	01/78-12/81	AR 30102	1186				0-N800	TB [TE]
1.2	01/78-12/81	AR 30102	1186				0-N801	TB [TE]
1.3	01/78-07/79	AR 30180	1286				0-N800	TB [TE]
1.3	01/78-07/79	AR 30180	1286				0-N801	TB [TE]
1.3	03/80-12/81	AR 30160	1351				0-N800	TB [TE]
1.3	03/80-12/81	AR 30160	1351				0-N801	TB [TE]
ARNA (920)								
1.2	03/83-12/86	AR 30102, AR 30500, AR 31000	1186				0-N800	TB [TE]
1.2	03/83-12/86	AR 30102, AR 30500, AR 31000	1186				0-N801	TB [TE]
1.3 TI	03/83-12/86	AR 30168, AR 31010	1351				0-N800	TB [TE]
1.3 TI	03/83-12/86	AR 30168, AR 31010	1351				0-N801	TB [TE]
BRERA (939)								
1.8 TBi	05/09-06/10	939 B1.000	1742	24x171			SK-1733	BTK
1.8 TBi	05/09-06/10	939 B1.000	1742	24x171			SK-1733AQ1	BTKW
2.0 JTDM	03/08-06/10	844 A2.000, 939 B3.000	1956	24x199			SK-1586	BTK
2.0 JTDM	03/08-06/10	844 A2.000, 939 B3.000	1956	24x199			SK-1586AQ1	BTKW
2.4 JTDM 20V	01/06-06/10	939 A3.000, 939 A9.000	2387	24x199			SK-1587	BTK
2.4 JTDM 20V	01/06-06/10	939 A3.000, 939 A9.000	2387	24x199			SK-1587AQ1	BTKW

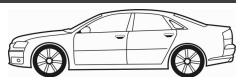
CM³

Art. Nr.

**BRERA (939)**

1.8 TBi	05/09-06/10	939 B1.000	1742		0-N2149	TB [DG]	
1.8 TBi	05/09-06/10	939 B1.000	1742		0-N2150	TB [TE]	
2.0 JTDM	03/08-06/10	844 A2.000, 939 B3.000	1956		0-N115	TB [TE]	
2.0 JTDM	03/08-06/10	844 A2.000, 939 B3.000	1956		0-N2149	TB [DG]	
2.4 JTDM 20V	01/06-06/10	939 A3.000, 939 A9.000	2387		0-N115	TB [TE]	
2.4 JTDM 20V	01/06-06/10	939 A3.000, 939 A9.000	2387		0-N950	TB [DG]	
1.8 TBi	05/09-06/10	939 B1.000	1742		0-N1503	VB [BT]	S
1.8 TBi	05/09-06/10	939 B1.000	1742	*	0-N1522	VB [DG]	
1.8 TBi	05/09-06/10	939 B1.000	1742		0-N2049	VB [DG]	
2.0 JTDM	03/08-06/10	844 A2.000, 939 B3.000	1956		0-N1503	VB [BT]	S
2.0 JTDM	03/08-06/10	844 A2.000, 939 B3.000	1956	*	0-N1522	VB [DG]	
2.0 JTDM	03/08-06/10	844 A2.000, 939 B3.000	1956		0-N2049	VB [DG]	
2.2 JTS	01/06-06/10	939 A5.000	2198		0-N1588	VB [BT]	S
2.4 JTDM 20V	01/06-06/10	939 A3.000, 939 A9.000	2387		0-N1522	VB [DG]	
2.4 JTDM 20V	01/06-06/10	939 A3.000, 939 A9.000	2387		0-N2093	VB [BT]	S
3.2 JTS, 3.2 JTS Q4	01/06-06/10	939 A.000	3195		0-N2194	VB [BT]	S

GIULIETTA (940)

1.4 BiFuel, 1.4 TB	04/10-	198 A4.000, 940 B1.000, 940 B8.000, 955 A8.000	1368	22x124	SK-1412	BTK	
1.4 BiFuel, 1.4 TB	04/10-	198 A4.000, 198 A4.000, 940 B7.000, 940 A2.000, 940 A6.000, 940 B1.000, 940 B8.000, 955 A8.000	1368	22x124	SK-1412AQ2	BTKW	
1.4 TB	04/10-	198 A4.000, 940 B7.000, 940 A2.000, 940 A6.000	1368	22x124; Baumuster: 940	SK-1412	BTK	
1.6 JTDM	04/10-	940 A3.000	1598	24x194	SK-1693	BTK	
1.6 JTDM	04/10-	940 A3.000	1598	24x194	SK-1693AQ1	BTKW	
1.8 TBi	04/10-09/13	940 A1.000	1742	24x171	SK-1733	BTK	
1.8 TBi	09/13-	960 A1.000	1742	24x171; → 01/2014	SK-1733	BTK	
1.8 TBi	09/13-	960 A1.000	1742	24x171; → 01/2014	SK-1733AQ1	BTKW	
2.0 JTDM	04/10-	940 A4.000, 940 A5.000, 940 A7.000, 940 A8.000, 940 B6.000, 940 B4.000, 940 B5.000	1956	24x199	SK-1586	BTK	
2.0 JTDM	04/10-	940 A4.000, 940 A5.000, 940 A7.000, 940 A8.000, 940 B6.000, 940 B4.000, 940 B5.000	1956	24x199	SK-1586AQ1	BTKW	
1.4 BiFuel, 1.4 TB	04/10-	198 A4.000, 198 A4.000, 940 B7.000, 940 A2.000, 940 A6.000, 940 B1.000, 940 B8.000, 955 A8.000	1368		0-N195	TB [TE]	
1.6 JTDM	04/10-	940 A3.000	1598		0-N115	TB [TE]	
1.6 JTDM	04/10-	940 A3.000, 940 C1.000, 940 C5.000	1598		0-N2149	TB [DG]	
1.8 TBi	04/10-09/13	940 A1.000, 960 A1.000	1742		0-N2149	TB [DG]	
1.8 TBi	04/10-09/13	940 A1.000, 960 A1.000	1742		0-N2150	TB [TE]	
2.0 JTDM	04/10-	940 A4.000, 940 A5.000, 940 A7.000	1956		0-N115	TB [TE]	
2.0 JTDM	04/10-	940 A4.000, 940 A5.000, 940 A7.000, 940 A8.000, 940 B6.000, 940 B4.000, 940 B5.000	1956		0-N2149	TB [DG]	
1.4 BiFuel, 1.4 TB	04/10-	198 A4.000, 198 A4.000, 940 B7.000, 940 A2.000, 940 A6.000, 940 B1.000, 940 B8.000, 955 A8.000	1368		0-N1517	VB [BT]	S
1.6 JTDM	04/10-	940 A3.000	1598		0-N1503	VB [BT]	S
1.6 JTDM	04/10-	940 A3.000	1598		0-N1522	VB [DG]	
1.6 JTDM	04/10-	940 A3.000	1598	Rippenanzahl: 6	0-N2122	VB [DG]	
1.8 TBi	04/10-	940 A1.000	1742		0-N2030	VB [BT]	S
1.8 TBi	04/10-	940 A1.000	1742	Rippenanzahl: 6	0-N2122	VB [DG]	
2.0 JTDM	04/10-	940 A4.000, 940 A5.000	1956		0-N1503	VB [BT]	S
2.0 JTDM	04/10-	940 A4.000, 940 A5.000	1956		0-N1522	VB [DG]	
2.0 JTDM	04/10-	940 A4.000, 940 A5.000	1956	Rippenanzahl: 6	0-N2122	VB [DG]	

GT (937)

1.8 TS	11/03-09/10	AR 32205	1747	24x166; 01/2005 →	SK-1415	BTK	
1.9 JTD	11/03-09/10	937 A5.000	1910	24x199; Abgasnorm: Euro 4 (D4)	SK-1586	BTK	
1.9 JTD	11/03-09/10	937 A5.000	1910	24x199; Abgasnorm: Euro 4 (D4)	SK-1586AQ1	BTKW	
1.9 JTD	11/03-09/10	937 A5.000	1910	24x198; Abgasnorm: Euro 3 (D3); mit Zubehör	SK-1602	BTK	
1.9 JTD	11/03-09/10	937 A5.000	1910	24x198; Abgasnorm: Euro 3 (D3); mit Zubehör	SK-1602AQ1	BTKW	
1.9 JTD	05/08-09/10	937 A6.000	1910	24x199; Baumuster: 937	SK-1586	BTK	
1.9 JTD	05/08-09/10	937 A6.000	1910	24x199	SK-1586AQ1	BTKW	
2.0 JTS	11/03-09/10	932 A2.000, 932 A2.000, 937 A1.000	1970	24x168	SK-1410	BTK	



OPTIMAL®

ALFA ROMEO



CM³



Art. Nr.



ohne Halter

GT (937)								
2.0 JTS	11/03-09/10	932 A2.000, 932 A2.000, 937 A1.000	1970	24x168	SK-1410AQ1	BTKW		
2.0 JTS	11/03-09/10	932 A2.000, 932 A2.000, 937 A1.000	1970	24x168; 15x130	SK-1756	BTK		
1.8 TS	11/03-09/10	AR 32205	1747		0-N114	TB [TE]		
1.8 TS	11/03-09/10	AR 32205	1747		0-N938	TB [DG]		
1.9 JTD	11/03-09/10	937 A5.000, 937 A6.000	1910		0-N115	TB [TE]		
1.9 JTD	11/03-09/10	937 A5.000, 937 A6.000	1910		0-N1326	TB [DG]		
1.9 JTD	11/03-09/10	937 A5.000	1910	ENGINE:4109228→; Abgasnorm: Euro 3 (D3)	0-N2149	TB [DG]		
2.0 JTS	11/03-09/10	932 A2.000, 932 A2.000, 937 A1.000	1970		0-N1572	TB [TE]		
2.0 JTS	11/03-09/10	932 A2.000, 932 A2.000, 937 A1.000	1970		0-N194	TB [TE]		
2.0 JTS	11/03-09/10	932 A2.000, 932 A2.000, 937 A1.000	1970		0-N938	TB [DG]		
3.2 GTA	11/03-09/10	936 A.000	3179		0-N1092	TB [TE]		
3.2 GTA	11/03-09/10	936 A.000	3179		0-N1093	TB [DG]		
1.8 TS	11/03-09/10	AR 32205	1747		0-N1403	VB [DG]		
1.9 JTD	11/03-09/10	937 A5.000, 937 A6.000	1910		0-N1415	VB [DG]		
1.9 JTD	11/03-09/10	937 A5.000, 937 A6.000	1910		0-N1487	VB [BT]		S
2.0 JTS	11/03-09/10	932 A2.000, 932 A2.000, 937 A1.000	1970	✳	0-N1628	VB [DG]		
3.2 GTA	11/03-09/10	936 A.000	3179		0-N1408	VB [DG]		
3.2 GTA	11/03-09/10	936 A.000	3179		0-N1594	VB [DG]		
3.2 GTA	11/03-09/10	936 A.000	3179	†	0-N1595	VB [BT]		S
GTV (916C_)								
1.8 16V	05/98-10/05	AR 32201	1747	24x168	SK-1361	BTK		
1.8 16V	05/98-10/05	AR 32201	1747	24x168	SK-1361AQ1	BTKW		
2.0 JTS	04/03-10/05	937 A1.000	1970	24x168	SK-1410	BTK		
2.0 JTS	04/03-10/05	937 A1.000	1970	24x168	SK-1410AQ1	BTKW		
2.0 JTS	04/03-10/05	937 A1.000	1970	24x168; 15x130	SK-1756	BTK		
2.0 JTS, 2.0 T.SPARK 16V	05/98-10/05	937 A1.000, AR 32301	1970	15x130	SK-1664	BTK		
2.0 T.SPARK 16V	06/95-10/05	AR16201	1970	24x168	SK-1361	BTK		
2.0 T.SPARK 16V	06/95-10/05	AR32310	1970	24x168	SK-1361	BTK		
2.0 T.SPARK 16V	06/95-10/05	AR16201	1970	24x168	SK-1361AQ1	BTKW		
2.0 T.SPARK 16V	06/95-10/05	AR32310	1970	24x168	SK-1361AQ1	BTKW		
2.0 T.SPARK 16V	06/95-10/05	AR 16201, AR 32310	1970	15x130; ENGINE:0134319→; ENGINE:→2417143	SK-1664	BTK		
2.0 T.SPARK 16V	06/95-10/05	AR32310	1970	24x168; 15x130	SK-1755	BTK		
2.0 T.SPARK 16V	06/95-10/05	AR16201	1970	24x168; 15x130; ENGINE:0134320→	SK-1755	BTK		
2.0 T.SPARK 16V	06/95-10/05	AR32310	1970	24x168; 15x130	SK-1755AQ1	BTKW		
2.0 T.SPARK 16V	06/95-10/05	AR16201	1970	24x168; 15x130; ENGINE:0134320→	SK-1755AQ1	BTKW		
2.0 T.SPARK 16V	05/98-08/00	AR 32301	1970	24x168	SK-1361	BTK		
2.0 T.SPARK 16V	05/98-08/00	AR 32301	1970	24x168	SK-1361AQ1	BTKW		
2.0 T.SPARK 16V	05/98-08/00	AR 32301	1970	24x168; 15x130	SK-1755	BTK		
2.0 T.SPARK 16V	05/98-08/00	AR 32301	1970	24x168; 15x130	SK-1755AQ1	BTKW		
1.8 16V	05/98-10/05	AR 32201	1747		0-N114	TB [TE]		
1.8 16V	05/98-10/05	AR 32201	1747		0-N938	TB [DG]		
2.0 JTS	04/03-10/05	937 A1.000	1970		0-N194	TB [TE]		
2.0 JTS, 2.0 T.SPARK 16V	06/95-10/05	937 A1.000, AR 16201, AR 32310, AR 32301	1970		0-N1572	TB [TE]		
2.0 JTS, 2.0 T.SPARK 16V	06/95-10/05	937 A1.000, AR 16201, AR 32310, AR 32301	1970		0-N938	TB [DG]		
2.0 T.SPARK 16V	06/95-10/05	AR 16201, AR 32310, AR 32301	1970		0-N114	TB [TE]		
3.0 V6 24V	10/96-10/05	AR 16102, AR 16105	2959		0-N1092	TB [TE]		
3.0 V6 24V	10/96-10/05	AR 16102, AR 16105	2959		0-N1093	TB [DG]		
3.2 V6 24V	04/03-10/05	936 A6.000	3179		0-N1092	TB [TE]		
3.2 V6 24V	04/03-10/05	936 A6.000	3179		0-N1093	TB [DG]		
1.8 16V	05/98-10/05	AR 32201	1747		0-N1403	VB [DG]		
1.8 16V	05/98-10/05	AR 32201	1747		0-N1407	VB [BT]		S
2.0 JTS, 2.0 T.SPARK 16V	06/95-10/05	937 A1.000, AR 16201, AR 32310, AR 32301	1970	✳	0-N1628	VB [DG]		
2.0 T.SPARK 16V	06/95-10/05	AR16201	1970		0-N1407	VB [BT]		S
2.0 T.SPARK 16V	06/95-10/05	AR32310	1970		0-N2117	VB [BT]		S
2.0 T.SPARK 16V	05/98-08/00	AR 32301	1970		0-N2117	VB [BT]		S
2.0 V6 Turbo	06/95-09/98	AR 16202	1996		0-N1623	VB [TE]		
3.0 V6 24V	10/96-10/05	AR 16102, AR 16105	2959		0-N1408	VB [DG]		
3.0 V6 24V	10/96-10/05	AR 16102, AR 16105	2959		0-N1594	VB [DG]		
3.0 V6 24V	10/96-10/05	AR 16102, AR 16105	2959	†	0-N1595	VB [BT]		S
3.2 V6 24V	04/03-10/05	936 A6.000	3179		0-N1408	VB [DG]		
3.2 V6 24V	04/03-10/05	936 A6.000	3179		0-N1594	VB [DG]		
3.2 V6 24V	04/03-10/05	936 A6.000	3179	†	0-N1595	VB [BT]		S



CM³



Art. Nr.



MITO (955)							
1.4	09/08-	199 A6.000	1368	22x124; Baumuster: 955	SK-1412	BTK	
1.4	05/11-	955 A9.000	1368	22x129	SK-1677	BTK	
1.4 TB	10/09-	955 A2.000, 955 A7.000	1368	22x124; Baumuster: 955	SK-1412	BTK	
1.4 Turbo	09/08-	198 A1.000	1368	22x124; 09/2009 →; Baumuster: 955	SK-1412	BTK	
1.4, 1.4 Bifuel	03/11-	198 A4.000, 350 A1.000, 955 A1.000	1368	22x124	SK-1412	BTK	
1.4, 1.4 Bifuel, 1.4 TB, 1.4 Turbo	09/08-	198 A1.000, 198 A4.000, 199 A6.000, 199 A8.000, 350 A1.000, 940 A2.000, 955 A1.000, 955 A2.000, 955 A7.000, 955 A6.000, 955 A8.000	1368	22x124	SK-1412AQ2	BTKW	
1.4, 1.4 TB	09/08-	198 A4.000, 199 A8.000, 940 A2.000, 955 A1.000, 955 A6.000, 955 A8.000	1368	22x124; Baumuster: 955	SK-1412	BTK	
1.6 JTDM	09/08-	198 A2.000, 955 A3.000, 955 A4.000	1598	24x194	SK-1693	BTK	
1.6 JTDM	09/08-	198 A2.000, 955 A3.000, 955 A4.000	1598	24x194	SK-1693AQ1	BTKW	
1.4	03/11-	350 A1.000, 955 A9.000	1368		0-N1616	TB [TE]	
1.4, 1.4 Bifuel, 1.4 TB, 1.4 Turbo	09/08-	198 A1.000, 198 A4.000, 199 A6.000, 199 A8.000, 940 A2.000, 955 A1.000, 955 A2.000, 955 A7.000, 955 A6.000, 955 A8.000	1368		0-N195	TB [TE]	
1.6 JTDM	09/08-	198 A2.000	1598	→ 07/2010	0-N115	TB [TE]	
1.6 JTDM	09/08-	955 A4.000	1598	→ 07/2010	0-N115	TB [TE]	
1.6 JTDM	09/08-	198 A2.000, 955 A3.000, 955 A4.000	1598		0-N2149	TB [DG]	
1.3 JTDM	09/08-	199 A3.000, 199 B1.000	1248		0-N1526	VB [BT]	S
1.3 JTDM	10/09-	199 B1.000, 199 B4.000	1248		0-N1478S	VB [TE]	
1.4, 1.4 Bifuel, 1.4 TB, 1.4 Turbo	09/08-	198 A1.000, 198 A4.000, 199 A6.000, 199 A8.000, 350 A1.000, 940 A2.000, 955 A1.000, 955 A2.000, 955 A7.000, 955 A6.000, 955 A8.000, 955 A9.000	1368		0-N1517	VB [BT]	S
1.6 JTDM	09/08-	198 A2.000, 955 A3.000, 955 A4.000	1598		0-N1503	VB [BT]	S
1.6 JTDM	09/08-	198 A2.000, 955 A3.000, 955 A4.000	1598	✳	0-N1522	VB [DG]	
1.6 JTDM	09/08-	198 A2.000, 955 A3.000, 955 A4.000	1598	Rippenanzahl: 6	0-N2122	VB [DG]	

SPIDER (916S_, 916_)							
1.8 16V	05/98-04/05	AR 32201	1747	24x168	SK-1361	BTK	
1.8 16V	05/98-04/05	AR 32201	1747	24x168	SK-1361AQ1	BTKW	
2.0 JTS	04/03-04/05	937 A1.000	1970	24x168	SK-1410	BTK	
2.0 JTS	04/03-04/05	937 A1.000	1970	24x168	SK-1410AQ1	BTKW	
2.0 JTS	04/03-04/05	937 A1.000	1970	24x168; 15x130	SK-1756	BTK	
2.0 JTS, 2.0 T.SPARK 16V	05/98-04/05	937 A1.000, AR 32301	1970	15x130	SK-1664	BTK	
2.0 T.SPARK 16V	06/95-04/05	AR16201	1970	24x168	SK-1361	BTK	
2.0 T.SPARK 16V	06/95-04/05	AR32310	1970	24x168	SK-1361	BTK	
2.0 T.SPARK 16V	06/95-04/05	AR16201	1970	24x168	SK-1361AQ1	BTKW	
2.0 T.SPARK 16V	06/95-04/05	AR32310	1970	24x168	SK-1361AQ1	BTKW	
2.0 T.SPARK 16V	06/95-04/05	AR 16201, AR 32310	1970	15x130; :0134319→	SK-1664	BTK	
2.0 T.SPARK 16V	06/95-04/05	AR32310	1970	24x168; 15x130	SK-1755	BTK	
2.0 T.SPARK 16V	06/95-04/05	AR16201	1970	24x168; 15x130; :0134320→	SK-1755	BTK	
2.0 T.SPARK 16V	06/95-04/05	AR32310	1970	24x168; 15x130	SK-1755AQ1	BTKW	
2.0 T.SPARK 16V	06/95-04/05	AR16201	1970	24x168; 15x130; :0134320→	SK-1755AQ1	BTKW	
2.0 T.SPARK 16V	05/98-08/00	AR 32301	1970	24x168	SK-1361	BTK	
2.0 T.SPARK 16V	05/98-08/00	AR 32301	1970	24x168	SK-1361AQ1	BTKW	
2.0 T.SPARK 16V	05/98-08/00	AR 32301	1970	24x168; 15x130	SK-1755	BTK	
2.0 T.SPARK 16V	05/98-08/00	AR 32301	1970	24x168; 15x130	SK-1755AQ1	BTKW	
1.8 16V	05/98-04/05	AR 32201	1747		0-N114	TB [TE]	
1.8 16V	05/98-04/05	AR 32201	1747		0-N938	TB [DG]	
2.0 JTS	04/03-04/05	937 A1.000	1970		0-N194	TB [TE]	
2.0 JTS, 2.0 T.SPARK 16V	06/95-04/05	937 A1.000, AR 16201, AR 32310, AR 32301	1970		0-N1572	TB [TE]	
2.0 JTS, 2.0 T.SPARK 16V	06/95-04/05	937 A1.000, AR 16201, AR 32310, AR 32301	1970		0-N938	TB [DG]	
2.0 T.SPARK 16V	06/95-04/05	AR 16201, AR 32310, AR 32301	1970		0-N114	TB [TE]	
3.0 V6 , 3.0 V6 24V	09/94-10/03	AR 16102, AR 16105	2959		0-N1092	TB [TE]	
3.0 V6 , 3.0 V6 24V	09/94-10/03	AR 16102, AR 16105	2959		0-N1093	TB [DG]	
3.2 V6 24V	04/03-04/05	936 A6.000	3179		0-N1092	TB [TE]	
3.2 V6 24V	04/03-04/05	936 A6.000	3179		0-N1093	TB [DG]	
1.8 16V	05/98-04/05	AR 32201	1747		0-N1403	VB [DG]	
1.8 16V	05/98-04/05	AR 32201	1747		0-N1407	VB [BT]	S
2.0 JTS, 2.0 T.SPARK 16V	06/95-04/05	937 A1.000, AR 16201, AR 32310, AR 32301	1970	✳	0-N1628	VB [DG]	
2.0 T.SPARK 16V	06/95-04/05	AR16201	1970		0-N1407	VB [BT]	S
2.0 T.SPARK 16V	06/95-04/05	AR32310	1970		0-N1407	VB [BT]	S

CM³

Art. Nr.



ohne Halter

SPIDER (916S_, 916_)

2.0 T.SPARK 16V	05/98-08/00	AR 32301	1970		0-N1407	VB [BT]	S
2.0 V6 Turbo	05/98-04/05	AR 16202	1996		0-N1623	VB [TE]	
3.0 V6	06/95-04/05	AR 16101	2959		0-N1623	VB [TE]	
3.0 V6 , 3.0 V6 24V	09/94-10/03	AR 16102, AR 16105	2959		0-N1408	VB [DG]	
3.0 V6 , 3.0 V6 24V	09/94-10/03	AR 16102, AR 16105	2959		0-N1594	VB [DG]	
3.0 V6 , 3.0 V6 24V	09/94-10/03	AR 16102, AR 16105	2959	†	0-N1595	VB [BT]	S
3.2 V6 24V	04/03-04/05	936 A6.000	3179		0-N1408	VB [DG]	
3.2 V6 24V	04/03-04/05	936 A6.000	3179		0-N1594	VB [DG]	
3.2 V6 24V	04/03-04/05	936 A6.000	3179	†	0-N1595	VB [BT]	S

SPIDER (939, 939_)

1.8 TBi	05/09-06/10	939 B1.000	1742	24x171	SK-1733	BTK	
1.8 TBi	05/09-06/10	939 B1.000	1742	24x171	SK-1733AQ1	BTKW	
2.0 JTDM	04/09-06/10	844 A2.000, 939 B3.000	1956	24x199	SK-1586	BTK	
2.0 JTDM	04/09-06/10	844 A2.000, 939 B3.000	1956	24x199	SK-1586AQ1	BTKW	
2.4 JTDM	04/07-06/10	939 A3.000	2387	24x199	SK-1587	BTK	
2.4 JTDM	04/07-06/10	939 A3.000	2387	24x199	SK-1587AQ1	BTKW	
1.8 TBi	05/09-06/10	939 B1.000	1742		0-N2149	TB [DG]	
1.8 TBi	05/09-06/10	939 B1.000	1742		0-N2150	TB [TE]	
2.0 JTDM	04/09-06/10	844 A2.000, 939 B3.000	1956		0-N115	TB [TE]	
2.0 JTDM	04/09-06/10	844 A2.000, 939 B3.000	1956		0-N2149	TB [DG]	
2.4 JTDM	04/07-06/10	939 A3.000	2387		0-N115	TB [TE]	
2.4 JTDM	04/07-06/10	939 A3.000	2387		0-N950	TB [DG]	
1.8 TBi	05/09-06/10	939 B1.000	1742		0-N1503	VB [BT]	S
1.8 TBi	05/09-06/10	939 B1.000	1742	⊛	0-N1522	VB [DG]	
1.8 TBi	05/09-06/10	939 B1.000	1742		0-N2049	VB [DG]	
2.0 JTDM	04/09-06/10	844 A2.000, 939 B3.000	1956		0-N1503	VB [BT]	S
2.0 JTDM	04/09-06/10	844 A2.000, 939 B3.000	1956	⊛	0-N1522	VB [DG]	
2.0 JTDM	04/09-06/10	844 A2.000, 939 B3.000	1956		0-N2049	VB [DG]	
2.2 JTS	03/06-06/10	939 A5.000	2198		0-N1588	VB [BT]	S
2.4 JTDM	04/07-06/10	939 A3.000	2387		0-N1522	VB [DG]	
2.4 JTDM	04/07-06/10	939 A3.000	2387		0-N2093	VB [BT]	S
3.2 JTS, 3.2 JTS Q4	03/06-06/10	939 A.000	3195		0-N2194	VB [BT]	S



CM³



Art. Nr.



ohne Halter

D3 (E90)							
2.0	12/05-04/08	M47 D22 (2204D4)	1995		0-N1793	VB [BT]	S
2.0	12/05-04/08	204D4	1995		0-N1871	VB [DG]	
D3 Kombi (E91)							
2.0	12/05-02/14	M47 D22 (2204D4)	1995		0-N1793	VB [BT]	S
2.0	12/05-02/14	204D4	1995		0-N1871	VB [DG]	



OPTIMAL®

AUDI



CM³



Art. Nr.



80 (80, 82, B1)								
1.3	05/72-07/78	ZA, ZF	1297	18x121; mit Zubehör	SK-1026	BTK		
1.5	05/72-07/76	ZC	1471	18x121; 05/1973 →; mit Zubehör	SK-1026	BTK		
1.5	05/72-08/75	YJ, ZB	1471	18x121; mit Zubehör	SK-1026	BTK		
1.6	09/75-07/78	YN, YP	1588	18x121; mit Zubehör	SK-1026	BTK		
1.6 GT	09/73-07/76	XX	1584	18x121; mit Zubehör	SK-1026	BTK		
1.6 GTE	01/76-07/78	YS	1588	18x121; 08/1976 →; mit Zubehör	SK-1026	BTK		
1.3	05/72-07/78	ZA, ZF	1297		0-N805	TB [TE]		
1.5	05/72-07/76	YJ, ZB, ZC	1471		0-N805	TB [TE]		
1.6 GT	09/73-07/76	XX	1584		0-N805	TB [TE]		
1.6, 1.6 GTE	09/75-07/78	YN, YP, YS	1588		0-N805	TB [TE]		

80 (81, 85, B2)								
1.3	09/78-07/86	EP	1297	18x121; mit Zubehör	SK-1026	BTK		
1.6	08/78-07/81	YY	1588	18x121; mit Zubehör	SK-1026	BTK		
1.6	08/78-07/86	DT, SA	1595	18x121; mit Zubehör	SK-1026	BTK		
1.6 D, 1.6 TD	08/80-08/86	CR, JK, CY	1588	25x135; mit Zubehör	SK-1001	BTK		
1.6, 1.6 GLE	08/78-07/86	WV, YN, YP, YZ	1588	18x121; mit Zubehör	SK-1026	BTK		
1.8, 1.8 CC quattro, 1.8 GTE, 1.8 GTE quattro	01/83-08/86	DS, JV, DZ, JN, JV, NE, PV, SF	1781	18x121; mit Zubehör	SK-1026	BTK		
1.3	09/78-07/86	EP	1297		0-N805	TB [TE]		
1.6	08/78-07/86	DT, SA	1595		0-N805	TB [TE]		
1.6 D, 1.6 TD	08/80-08/86	CR, JK, CY	1588		0-N806	TB [TE]		
1.6, 1.6 GLE	08/78-07/86	WV, YN, YP, YT, YY, YZ	1588		0-N805	TB [TE]		
1.8, 1.8 CC quattro, 1.8 GTE, 1.8 GTE quattro	01/83-08/86	DS, JV, DZ, JN, JV, NE, PV, SF	1781		0-N805	TB [TE]		
1.9 CD-5S	09/81-07/83	WN	1921		0-N807	TB [DG]		
2.0, 2.0 quattro	10/83-09/84	HP, HP, JS, JS	1994		0-N807	TB [DG]		
2.2 quattro	08/82-07/84	KK	2144		0-N807	TB [DG]		

80 (89, 89Q, 8A, B3)								
1.6	09/86-10/91	ABB, PP, RN	1595	18x121; mit Zubehör	SK-1026	BTK		
1.6 D, 1.6 TD	09/86-08/91	JK, RA, SB	1588	25x135; mit Zubehör	SK-1001	BTK		
1.8, 1.8 E, 1.8 E quattro, 1.8 S, 1.8 S quattro	06/86-10/91	DZ, JN, NE, PM, RU, SF	1781	18x121; mit Zubehör	SK-1026	BTK		
1.8, 1.8 quattro	09/86-08/90	SD	1847	18x121; mit Zubehör	SK-1026	BTK		
1.9 D	08/89-08/91	1Y	1896	25.4x137; mit Zubehör	SK-1029	BTK		
2.0 E 16V, 2.0 E 16V quattro	03/90-09/91	6A	1984	25x147	SK-1047	BTK		
2.0 E, 2.0 E quattro, 2.0 quattro	08/88-10/90	3A	1984	18x121; mit Zubehör	SK-1026	BTK		
2.0, 2.0 quattro	10/90-08/91	AAD	1984	18x124	SK-1119	BTK		
2.3 quattro	10/87-07/89	NG	2309	19x142; ch.89-J-394743→	SK-1126AQ1	BTKW		
2.3 quattro	10/87-07/89	NG	2309	19x147	SK-1130	BTK		
1.6	09/86-10/91	ABB, PP, RN	1595		0-N805	TB [TE]		
1.6 D, 1.6 TD	09/86-08/91	JK, RA, SB	1588		0-N806	TB [TE]		
1.8, 1.8 E, 1.8 E quattro, 1.8 S, 1.8 S quattro	06/86-10/91	DZ, JN, NE, PM, RU, SF	1781		0-N805	TB [TE]		
1.8, 1.8 quattro	09/86-08/90	SD	1847		0-N805	TB [TE]		
1.9 D	08/89-08/91	1Y	1896		0-N806	TB [TE]		
2.0 E 16V, 2.0 E 16V quattro	03/90-09/91	6A	1984		0-N808	TB [TE]		
2.0 E, 2.0 E quattro, 2.0 quattro	08/88-10/90	3A	1984		0-N805	TB [TE]		
2.0, 2.0 quattro	10/90-08/91	AAD	1984		0-N922	TB [TE]		

80 (8C, B4)								
1.6, 1.6 E	09/91-12/94	ABM, ADA	1595	18x121; mit Zubehör	SK-1026	BTK		
1.9 TD	09/91-12/94	AAZ	1896	25.4x137; → 07/1994; :→AAZ552765; mit Zubehör	SK-1029	BTK		
1.9 TD	09/91-12/94	AAZ	1896	25.4x137; 07/1994 →; :AAZ552766→; mit Zubehör	SK-1122	BTK		
1.9 TDI	09/91-12/94	1Z	1896	25.4x137; → 07/1994; :→1Z289575; mit Zubehör	SK-1069	BTK		
1.9 TDI	09/91-12/94	1Z	1896	25x137; 07/1994 →; :289576→; mit Zubehör	SK-1098	BTK		
2.0 E	09/91-12/94	ABK	1984	18x124	SK-1119	BTK		
2.0 E 16V, 2.0 E 16V quattro	09/91-12/94	6A, ACE	1984	25x147	SK-1047	BTK		
2.0, 2.0 E quattro	09/91-12/94	ABK, ABT	1984	18x124; ch.→8C-S-075037	SK-1119	BTK		
2.0, 2.0 E quattro	09/91-12/94	ABK, ABT	1984	18x124; ch.8C-S-075038→	SK-1261	BTK		
2.3 E, 2.3 E quattro	09/91-12/94	NG	2309	19x147	SK-1130	BTK		
2.6, 2.6 quattro	06/92-12/94	ABC	2598	25x239; ch.→8C-S-025820; Baumuster: 8C, B4	SK-1343	BTK		
2.6, 2.6 quattro	06/92-12/94	ABC	2598	25x239; ch.→8C-S-025820	SK-1343AQ1	BTKW		
2.6, 2.6 quattro	06/92-12/94	ABC	2598	25x239; ch.8C-S-025821→; mit Zubehör	SK-1376	BTK		

Alle in diesem Katalog genannten Original-Nummern der Kfz-Hersteller sind ausschließlich zu Vergleichszwecken bestimmt und dürfen in Rechnungen an Wagenbesitzer nicht verwendet werden.
 All original numbers from automobile manufacturers listed in this catalogue are for comparison purposes only and may not be used in invoices to car owners.
 Nachdruck, auch auszugsweise, nur mit unserer schriftlichen Genehmigung gestattet. - Full or partial reproduction only permitted with our approval.
 Les références des constructeurs n'ont aucune valeur et ne sont indiquées qu'à titre d'identification. La reproduction complète ou partielle de notre catalogue est interdite sans notre accord écrit.



CM³



Art. Nr.



80 (8C, B4)

2.6, 2.6 quattro	06/92-12/94	ABC	2598	25x239; ch.8C-S-025821→	SK-1376AQ1	BTKW	
2.8, 2.8 quattro	09/91-12/94	AAH	2771	25x239; ch.→8C-S-025820; Baumuster: 8C, B4	SK-1343	BTK	
2.8, 2.8 quattro	09/91-12/94	AAH	2771	25x239; ch.→8C-S-025820	SK-1343AQ1	BTKW	
2.8, 2.8 quattro	09/91-12/94	AAH	2771	25x239; ch.8C-S-025821→; mit Zubehör	SK-1376	BTK	
2.8, 2.8 quattro	09/91-12/94	AAH	2771	25x239; ch.8C-S-025821→	SK-1376AQ1	BTKW	
1.6, 1.6 E	09/91-12/94	ABM, ADA	1595		0-N805	TB [TE]	
1.9 TD	09/91-12/94	AAZ	1896	:552766→	0-N104	TB [TE]	
1.9 TD	09/91-12/94	AAZ	1896	:→552765	0-N806	TB [TE]	
1.9 TDI	09/91-12/94	1Z	1896	:→289575	0-N103	TB [TE]	
1.9 TDI	09/91-12/94	1Z	1896	:289576→	0-N104	TB [TE]	
1.9 TDI	09/91-12/94	1Z	1896		0-N128	TB [DG]	
2.0 E 16V, 2.0 E 16V quattro	04/92-12/94	ACE	1984	:017140→	0-N129	TB [TE]	
2.0 E 16V, 2.0 E 16V quattro	04/92-12/94	ACE	1984	:→017139	0-N808	TB [TE]	
2.0, 2.0 E, 2.0 E quattro	09/91-12/94	ABK, ABT	1984	ch.8C-S-075038→	0-N132	TB [TE]	
2.0, 2.0 E, 2.0 E quattro	09/91-12/94	ABK, ABT	1984	ch.→8C-S-075037	0-N922	TB [TE]	
2.3 E, 2.3 E quattro	09/91-12/94	NG	2309	ch.→8B-M-033000	0-N923	TB [TE]	
2.3 E, 2.3 E quattro	09/91-12/94	NG	2309	ch.8B-M-033001→	0-N939	TB [TE]	
2.6, 2.6 quattro	06/92-12/94	ABC	2598	ch.8C-S-025821→	0-N160	TB [TE]	
2.6, 2.6 quattro	06/92-12/94	ABC	2598	ch.8C-S-025821→	0-N2000	TB [DG]	
2.6, 2.6 quattro	06/92-12/94	ABC	2598	ch.→8C-S-025820	0-N940	TB [TE]	
2.6, 2.6 quattro	06/92-12/94	ABC	2598	ch.→8C-S-025820	0-N941	TB [DG]	
2.8, 2.8 quattro	09/91-12/94	AAH	2771	ch.8C-S-025821→	0-N160	TB [TE]	
2.8, 2.8 quattro	09/91-12/94	AAH	2771	ch.8C-S-025821→	0-N2000	TB [DG]	
2.8, 2.8 quattro	09/91-12/94	AAH	2771	ch.→8C-S-025820	0-N940	TB [TE]	
2.8, 2.8 quattro	09/91-12/94	AAH	2771	ch.→8C-S-025820	0-N941	TB [DG]	
S2 quattro	02/93-12/94	ABY	2226		0-N941	TB [DG]	
1.9 TD, 1.9 TDI	09/91-12/94	1Z, AAZ	1896		0-N1417	VB [TE]	
1.9 TD, 1.9 TDI	09/91-12/94	1Z, AAZ	1896		0-N1609	VB [BT]	
2.0 E 16V, 2.0 E 16V quattro	04/92-12/94	ACE	1984		0-N2345	VB [DG]	
2.6, 2.6 quattro	06/92-12/94	ABC	2598	ch.8C-S-050001→	0-N1083	VB [BT]	S
2.6, 2.6 quattro	06/92-12/94	ABC	2598		0-N1414	VB [DG]	
2.8, 2.8 quattro	09/91-12/94	AAH	2771	ch.8C-S-050001→	0-N1083	VB [BT]	S
2.8, 2.8 quattro	09/91-12/94	AAH	2771		0-N1414	VB [DG]	

80 Avant (8C, B4)

1.6 E	06/93-01/96	ADA	1595	18x121; mit Zubehör	SK-1026	BTK	
1.9 TD	09/91-12/94	AAZ	1896	25.4x137; :→552765; mit Zubehör	SK-1029	BTK	
1.9 TD	09/91-12/94	AAZ	1896	25.4x137; :AAZ552766→; mit Zubehör	SK-1122	BTK	
1.9 TDI	07/92-01/96	1Z	1896	25.4x137; → 07/1994; :→1Z289575; mit Zubehör	SK-1069	BTK	
1.9 TDI	07/92-01/96	1Z	1896	25x137; 07/1994 →; :289576→; mit Zubehör	SK-1098	BTK	
2.0 E 16V	02/93-01/96	ACE	1984	25x147; :→017139	SK-1047	BTK	
2.0 E 16V quattro	12/92-07/95	ACE	1984	25x147; 08/1994 →; :→017139	SK-1047	BTK	
2.0 E 16V, 2.0 E 16V quattro	12/92-01/96	ACE	1984	25x147; 01/1995 →	SK-1124	BTK	
2.0, 2.0 E, 2.0 quattro	07/92-01/96	ABK, ABT, ADW	1984	18x124; ch.→8C-S-075037	SK-1119	BTK	
2.0, 2.0 E, 2.0 quattro	07/92-01/96	ABK, ABT, ADW	1984	18x124; ch.8C-S-075038→	SK-1261	BTK	
2.3 E	07/92-01/96	NG	2309	19x147	SK-1130	BTK	
2.3 E quattro	09/91-11/94	NG	2309	19x147; 08/1992 →	SK-1130	BTK	
2.6, 2.6 quattro	07/92-01/96	ABC	2598	25x239; ch.→8C-S-025820; Baumuster: 8C, B4	SK-1343	BTK	
2.6, 2.6 quattro	07/92-01/96	ABC	2598	25x239; ch.→8C-S-025820	SK-1343AQ1	BTKW	
2.6, 2.6 quattro	07/92-01/96	ABC	2598	25x239; ch.8C-S-025821→; mit Zubehör	SK-1376	BTK	
2.6, 2.6 quattro	07/92-01/96	ABC	2598	25x239; ch.8C-S-025821→	SK-1376AQ1	BTKW	
2.8, 2.8 quattro	09/91-01/96	AAH	2771	25x239; ch.→8C-S-025820; Baumuster: 8C, B4	SK-1343	BTK	
2.8, 2.8 quattro	09/91-01/96	AAH	2771	25x239; ch.→8C-S-025820	SK-1343AQ1	BTKW	
2.8, 2.8 quattro	09/91-01/96	AAH	2771	25x239; ch.8C-S-025821→; mit Zubehör	SK-1376	BTK	
2.8, 2.8 quattro	09/91-01/96	AAH	2771	25x239; ch.8C-S-025821→	SK-1376AQ1	BTKW	
1.6 E	06/93-01/96	ADA	1595		0-N805	TB [TE]	
1.9 TD	09/91-12/94	AAZ	1896	:552766→	0-N104	TB [TE]	
1.9 TD	09/91-12/94	AAZ	1896	:→552765	0-N806	TB [TE]	
1.9 TDI	07/92-01/96	1Z	1896	:→289575	0-N103	TB [TE]	
1.9 TDI	07/92-01/96	1Z	1896	:289576→	0-N104	TB [TE]	
1.9 TDI	07/92-01/96	1Z	1896		0-N128	TB [DG]	
2.0 E 16V, 2.0 E 16V quattro	12/92-01/96	ACE	1984	:017140→	0-N129	TB [TE]	

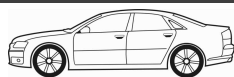
CM³

Art. Nr.

**80 Avant (8C, B4)**

2.0 E 16V, 2.0 E 16V quattro	12/92-01/96	ACE	1984	→017139	0-N808	TB [TE]	
2.0, 2.0 E	07/92-01/96	ABK, ABT	1984	ch.8C-S-075038→	0-N132	TB [TE]	
2.0, 2.0 E	07/92-01/96	ABK, ABT	1984	ch.→8C-S-075037	0-N922	TB [TE]	
2.3 E, 2.3 E quattro	09/91-01/96	NG	2309	ch.→8B-M-033000	0-N923	TB [TE]	
2.3 E, 2.3 E quattro	09/91-01/96	NG	2309	ch.8B-M-033001→	0-N939	TB [TE]	
2.6, 2.6 quattro	07/92-01/96	ABC	2598	ch.8C-S-025821→	0-N160	TB [TE]	
2.6, 2.6 quattro	07/92-01/96	ABC	2598	ch.8C-S-025821→	0-N2000	TB [DG]	
2.6, 2.6 quattro	07/92-01/96	ABC	2598	ch.→8C-S-025820	0-N940	TB [TE]	
2.6, 2.6 quattro	07/92-01/96	ABC	2598	ch.→8C-S-025820	0-N941	TB [DG]	
2.8, 2.8 quattro	09/91-01/96	AAH	2771	ch.8C-S-025821→	0-N160	TB [TE]	
2.8, 2.8 quattro	09/91-01/96	AAH	2771	ch.8C-S-025821→	0-N2000	TB [DG]	
2.8, 2.8 quattro	09/91-01/96	AAH	2771	ch.→8C-S-025820	0-N940	TB [TE]	
2.8, 2.8 quattro	09/91-01/96	AAH	2771	ch.→8C-S-025820	0-N941	TB [DG]	
RS2 quattro, S2 quattro	02/93-07/95	ABY, ADU	2226		0-N941	TB [DG]	
1.9 TD, 1.9 TDI	09/91-01/96	1Z, AAZ	1896		0-N1417	VB [TE]	
1.9 TD, 1.9 TDI	09/91-01/96	1Z, AAZ	1896		0-N1609	VB [BT]	
2.0 E 16V, 2.0 E 16V quattro	12/92-01/96	ACE	1984		0-N2345	VB [DG]	
2.6, 2.6 quattro	07/92-01/96	ABC	2598	ch.8C-S-050001→	0-N1083	VB [BT]	S
2.6, 2.6 quattro	07/92-01/96	ABC	2598		0-N1414	VB [DG]	
2.8, 2.8 quattro	09/91-01/96	AAH	2771	ch.8C-S-050001→	0-N1083	VB [BT]	S
2.8, 2.8 quattro	09/91-01/96	AAH	2771		0-N1414	VB [DG]	

90 (81, 85, B2)

1.6 TD	10/85-01/87	CY	1588	25x135; mit Zubehör	SK-1001	BTK	
1.6 TD	10/85-01/87	CY	1588		0-N806	TB [TE]	
2.0, 2.0 quattro	08/84-03/87	HP, JS, JS, SK	1994		0-N807	TB [DG]	
2.2 E quattro	08/85-03/87	JT	2226	ch.→89-J-394742	0-N807	TB [DG]	
2.2, 2.2 E quattro	10/84-03/87	HY, KV, KV, KX	2226		0-N807	TB [DG]	

90 (89, 89Q, 8A, B3)

1.6 TD	04/87-09/91	RA, SB	1588	25x135; mit Zubehör	SK-1001	BTK	
2.0	07/88-09/91	PS	1994	19x142	SK-1126	BTK	
2.0	07/88-09/91	PS	1994	19x142; ch.89-J-394743→	SK-1126AQ1	BTKW	
2.0 20 V, 2.0 20 V quattro	08/88-09/91	NM	1994	19x147	SK-1127	BTK	
2.0 quattro	08/89-07/90	6A	1984	25x147	SK-1047	BTK	
2.2 E, 2.2 E quattro	04/87-09/91	KV	2226	19x142	SK-1126	BTK	
2.2 E, 2.2 E quattro	04/87-09/91	KV	2226	19x142; ch.89-J-394743→	SK-1126AQ1	BTKW	
2.3 E	04/87-09/91	NG	2309	19x142; 05/1988 →	SK-1126	BTK	
2.3 E	04/87-09/91	NG	2309	19x142; ch.89-J-396703→	SK-1126AQ1	BTKW	
2.3 E 20V, 2.3 E 20V quattro	06/88-09/91	7A	2309	19x147	SK-1127	BTK	
2.3 E quattro	04/87-09/91	NG	2309	19x142; 05/1988 →; nicht für Länderausführung Deutschland	SK-1126	BTK	
2.3 E quattro	04/87-09/91	NG	2309	19x142; Länderausführung Deutschland	SK-1126	BTK	
2.3 E quattro	04/87-09/91	NG	2309	19x142; ch.89-J-394743→	SK-1126AQ1	BTKW	
1.6 TD	04/87-09/91	RA, SB	1588		0-N806	TB [TE]	
2.0	07/88-09/91	PS	1994	ch.→89-J-394742	0-N807	TB [DG]	
2.0	07/88-09/91	PS	1994	ch.89-J-394743→	0-N923	TB [TE]	
2.0 20 V, 2.0 20 V quattro	08/88-09/91	NM	1994		0-N807	TB [DG]	
2.2 E, 2.2 E quattro	04/87-09/91	KV	2226	ch.→89-J-394742	0-N807	TB [DG]	
2.2 E, 2.2 E quattro	04/87-09/91	KV	2226	ch.89-J-394743→	0-N923	TB [TE]	
2.3 E 20V, 2.3 E 20V quattro	06/88-09/91	7A	2309		0-N807	TB [DG]	
2.3 E, 2.3 E quattro	04/87-09/91	NG	2309	ch.→89-J-396702	0-N807	TB [DG]	
2.3 E, 2.3 E quattro	04/87-09/91	NG	2309	ch.89-J-396703→	0-N923	TB [TE]	

100 (C1)

1.6	01/75-07/76	YM	1588	18x121; mit Zubehör	SK-1026	BTK	
1.6	01/75-07/76	YM	1588		0-N805	TB [TE]	

100 (43, C2)

1.6	08/76-07/82	YV	1588	18x121; mit Zubehör	SK-1026	BTK	
1.9	08/80-07/82	WH	1921	19x142; ch.44-E-000001→	SK-1126AQ1	BTKW	
2.0	06/76-08/78	WA	1984	18x121; mit Zubehör	SK-1026	BTK	
2.0 D	08/78-07/82	CN	1986	20x75; 25.4x119	SK-1129	BTK	
2.0 D	08/78-07/82	CN	1986	25x119	SK-1129AQ1	BTKW	
1.6	08/76-07/82	YV	1588		0-N805	TB [TE]	
1.9	08/80-07/82	WH	1921		0-N807	TB [DG]	
2.0	06/76-08/78	WA	1984		0-N805	TB [TE]	
2.0 D	08/78-07/82	CN	1986		0-N807	TB [DG]	



CM³



Art. Nr.



100 (43, C2)							
2.1	03/77-07/82	WB, WE, WE, WC, WG, WG	2144			0-N807	TB [DG]
100 Avant (43, C2)							
1.6	07/77-02/83	YV	1588	18x121; mit Zubehör		SK-1026	BTK
1.9	08/80-07/82	WH	1921	19x142; ch.44-E-000001→		SK-1126AQ1	BTKW
2.0	08/77-07/80	WA	1984	18x121; mit Zubehör		SK-1026	BTK
2.0 D	08/78-02/83	CN	1986	20x75; 25.4x119		SK-1129	BTK
2.0 D	08/78-02/83	CN	1986	25x119		SK-1129AQ1	BTKW
1.6	07/77-02/83	YV	1588			0-N805	TB [TE]
1.9	08/80-07/82	WH	1921			0-N807	TB [DG]
2.0	08/77-07/80	WA	1984			0-N805	TB [TE]
2.0 D	08/78-02/83	CN	1986			0-N807	TB [DG]
2.1	07/77-02/83	WB, WE, WE, WC, WG, WG	2144			0-N807	TB [DG]
100 (44, 44Q, C3)							
1.8	02/86-07/88	SH	1781	18x121; 08/1986 →; mit Zubehör		SK-1026	BTK
1.8, 1.8 KAT, 1.8 quattro, 1.8 quattro KAT	08/82-11/90	4B, PH, DR, RS, DS, JW, JW, NP, JW, JW, NP, SH	1781	18x121; mit Zubehör		SK-1026	BTK
2.0 D, 2.0 D Turbo	08/82-11/90	CN, DE, NC	1986	20x75; 25.4x119		SK-1129	BTK
2.0 D, 2.0 D Turbo	08/82-11/90	CN, DE, NC	1986	25x119		SK-1129AQ1	BTKW
2.0 KAT	01/88-11/90	RT	1994	19x142; 05/1988 →		SK-1126	BTK
2.0 KAT	01/88-11/90	RT	1994	19x142; ch.44-J-246282→		SK-1126AQ1	BTKW
2.2 E quattro	08/85-07/86	PX	2226	19x142		SK-1126	BTK
2.2 Turbo	08/86-11/90	MC	2226	19x142; ch.44-J-200100→ 07/1990		SK-1126	BTK
2.2, 2.2 E Turbo quattro, 2.2 KAT, 2.2 quattro, 2.2 quattro KAT	08/84-11/90	HX, KU, KU, MC	2226	19x142; ch.44-J-200100→		SK-1126	BTK
2.2, 2.2 E Turbo quattro, 2.2 KAT, 2.2 quattro, 2.2 quattro KAT, 2.2 Turbo	08/84-11/90	HX, KU, KU, MC	2226	19x142; ch.44-J-246282→		SK-1126AQ1	BTKW
2.3 E, 2.3 E quattro	08/86-11/90	NF	2309	19x142; 05/1988 →		SK-1126	BTK
2.3 E, 2.3 E quattro	08/86-11/90	NF	2309	19x142; ch.44-J-246282→		SK-1126AQ1	BTKW
1.8, 1.8 KAT, 1.8 quattro, 1.8 quattro KAT	08/82-11/90	4B, PH, DR, RS, DS, JW, JW, NP, JW, JW, NP, SH	1781			0-N805	TB [TE]
1.9	08/82-07/84	WH	1921			0-N807	TB [DG]
2.0	08/84-12/87	KP, SL	1994			0-N807	TB [DG]
2.0 D, 2.0 D Turbo	08/82-11/90	CN, DE, NC	1986			0-N807	TB [DG]
2.0 KAT	01/88-11/90	RT	1994	EMANE: →010235		0-N807	TB [DG]
2.0 KAT	01/88-11/90	RT	1994	EMANE: 010236→		0-N923	TB [TE]
2.1, 2.2	08/82-07/84	WC, WU	2144			0-N807	TB [DG]
2.2 E Turbo quattro, 2.2 Turbo	08/86-11/90	MC	2226	EMANE: →039950		0-N807	TB [DG]
2.2 E Turbo quattro, 2.2 Turbo	08/86-11/90	MC	2226	EMANE: 039951→		0-N923	TB [TE]
2.2, 2.2 E quattro	10/84-09/86	KZ, PX	2226			0-N807	TB [DG]
2.2, 2.2 KAT, 2.2 quattro, 2.2 quattro KAT	08/84-11/90	HX, KU, KU	2226	EMANE: →077116		0-N807	TB [DG]
2.2, 2.2 KAT, 2.2 quattro, 2.2 quattro KAT	08/84-11/90	HX, KU, KU	2226	EMANE: 077117→		0-N923	TB [TE]
2.3 E, 2.3 E quattro	08/86-11/90	NF	2309	EMANE: →063968		0-N807	TB [DG]
2.3 E, 2.3 E quattro	08/86-11/90	NF	2309	EMANE: 063969→		0-N923	TB [TE]
2.3 E, 2.3 quattro	01/90-11/90	NF	2309			0-N939	TB [TE]
2.4 D	08/89-07/91	3D	2370			0-N924	TB [DG]
2.5 TDI	01/90-11/90	1T	2461			0-N1229	TB [TE]
2.5 TDI	01/90-11/90	1T	2461			0-N1230	TB [DG]
2.5 TDI	01/90-11/90	1T	2461			0-N924	TB [DG]
100 Avant (44, 44Q, C3)							
1.8	02/86-07/90	SH	1781	18x121; 08/1986 →; mit Zubehör		SK-1026	BTK
1.8, 1.8 KAT, 1.8 quattro, 1.8 quattro KAT	08/82-11/90	4B, PH, DR, RS, DS, JW, JW, NP, JW, JW, NP, SH	1781	18x121; mit Zubehör		SK-1026	BTK
2.0 D, 2.0 TD	03/83-11/90	CN, DE, NC	1986	20x75; 25.4x119		SK-1129	BTK
2.0 D, 2.0 TD	03/83-11/90	CN, DE, NC	1986	25x119		SK-1129AQ1	BTKW
2.0 E KAT	01/88-11/90	RT	1994	19x142; 05/1988 →		SK-1126	BTK
2.0 E KAT	01/88-11/90	RT	1994	19x142; ch.44-J-246282→		SK-1126AQ1	BTKW
2.2 E quattro	08/85-07/86	PX	2226	19x142		SK-1126	BTK
2.2, 2.2 KAT, 2.2 quattro, 2.2 quattro KAT, 2.2 Turbo, 2.2 Turbo quattro	08/84-11/90	HX, KU, KU, MC	2226	19x142; ch.44-J-200100→		SK-1126	BTK
2.2, 2.2 KAT, 2.2 quattro, 2.2 quattro KAT, 2.2 Turbo, 2.2 Turbo quattro	08/84-11/90	HX, KU, KU, MC	2226	19x142; ch.44-J-246282→		SK-1126AQ1	BTKW
2.3, 2.3 E quattro	08/86-11/90	NF	2309	19x142; 05/1988 →		SK-1126	BTK
2.3, 2.3 E quattro	08/86-11/90	NF	2309	19x142; ch.44-J-246282→		SK-1126AQ1	BTKW
1.8, 1.8 KAT, 1.8 quattro, 1.8 quattro KAT	08/82-11/90	4B, PH, DR, RS, DS, JW, JW, NP, JW, JW, NP, SH	1781			0-N805	TB [TE]
1.9	02/83-07/84	WH	1921			0-N807	TB [DG]



CM³



Art. Nr.



100 Avant (44, 44Q, C3)

2.0 D, 2.0 TD	03/83-11/90	CN, DE, NC	1986		0-N807	TB [DG]
2.0 E KAT	01/88-11/90	RT	1994	:→010235	0-N807	TB [DG]
2.0 E KAT	01/88-11/90	RT	1994	:010236→	0-N923	TB [TE]
2.0, 2.0 E	01/85-12/87	KP, SL	1994		0-N807	TB [DG]
2.1	08/82-07/84	WC	2144		0-N807	TB [DG]
2.2 Turbo, 2.2 Turbo quattro	08/86-11/90	MC	2226	:→039950	0-N807	TB [DG]
2.2 Turbo, 2.2 Turbo quattro	08/86-11/90	MC	2226	:039951→	0-N923	TB [TE]
2.2, 2.2 E quattro	10/84-09/86	KZ, PX	2226		0-N807	TB [DG]
2.2, 2.2 KAT, 2.2 quattro, 2.2 quattro KAT	08/84-11/90	HX, KU, KU	2226	:→077116	0-N807	TB [DG]
2.2, 2.2 KAT, 2.2 quattro, 2.2 quattro KAT	08/84-11/90	HX, KU, KU	2226	:077117→	0-N923	TB [TE]
2.3, 2.3 E quattro	08/86-11/90	NF	2309	:→063968	0-N807	TB [DG]
2.3, 2.3 E quattro	08/86-11/90	NF	2309	:063969→	0-N923	TB [TE]
2.3, 2.3 quattro	01/90-11/90	NF	2309		0-N807	TB [DG]
2.4 D	08/89-11/90	3D	2370		0-N924	TB [DG]
2.5 TDI	01/90-11/90	1T	2461		0-N1229	TB [TE]
2.5 TDI	01/90-11/90	1T	2461		0-N1230	TB [DG]
2.5 TDI	01/90-11/90	1T	2461		0-N924	TB [DG]

100 (4A, C4)

1.6	03/92-07/93		1595	18x121; mit Zubehör	SK-1026	BTK
2.0 E 16V, 2.0 E 16V quattro	01/92-06/94	ACE	1984	25x147	SK-1047	BTK
2.0, 2.0 E, 2.0 E quattro	12/90-06/94	AAD, AAD, ABK, AAE	1984	18x124; 08/1991 →	SK-1119	BTK
2.3 E, 2.3 E quattro	12/90-06/94	AAR	2309	19x147	SK-1130	BTK
2.5 TDI	12/90-06/94	AAT, ABP	2461	26.5x124; 08/1991 →; :→038460	SK-1570	BTK
2.6	07/93-06/94	ACZ	2598	25x239; 11/1993 →	SK-1343	BTK
2.6 E quattro	08/93-07/94	ACZ	2598	25x239	SK-1343	BTK
2.6, 2.6 E quattro, 2.6 quattro	03/92-07/94	ABC, ACZ	2598	25x239	SK-1343AQ1	BTKW
2.6, 2.6 quattro	03/92-06/94	ABC	2598	25x239; 08/1992 →	SK-1343	BTK
2.8 E	12/90-06/94	AAH	2771	25x239; 08/1991 → 07/1993	SK-1343	BTK
2.8 E quattro	12/90-06/94	AAH	2771	25x239; 08/1991 →	SK-1343	BTK
2.8 E, 2.8 E quattro	12/90-06/94	AAH	2771	25x239	SK-1343AQ1	BTKW
1.6	03/92-07/93		1595		0-N805	TB [TE]
2.0 E 16V, 2.0 E 16V quattro	01/92-06/94	ACE	1984	:017140→	0-N129	TB [TE]
2.0 E 16V, 2.0 E 16V quattro	01/92-06/94	ACE	1984	:→017139	0-N808	TB [TE]
2.0, 2.0 E, 2.0 E quattro	12/90-06/94	AAD, AAD, ABK, AAE	1984		0-N922	TB [TE]
2.3 E, 2.3 E quattro	12/90-06/94	AAR	2309		0-N939	TB [TE]
2.4 D	12/90-06/94	AAS	2370		0-N807	TB [DG]
2.4 D	12/90-06/94	AAS	2370		0-N921	TB [TE]
2.5 TDI	12/90-06/94	AAT, ABP	2461		0-N1229	TB [TE]
2.5 TDI	12/90-06/94	ABP	2461		0-N1230	TB [DG]
2.5 TDI	12/90-06/94	AAT	2461	für OE: N90705901	0-N1230	TB [DG]
2.5 TDI	12/90-06/94	AAT, ABP	2461		0-N921	TB [TE]
2.5 TDI	12/90-06/94	AAT, ABP	2461		0-N924	TB [DG]
2.6, 2.6 quattro	03/92-06/94	ABC	2598		0-N940	TB [TE]
2.6, 2.6 quattro	03/92-06/94	ABC	2598		0-N941	TB [DG]
2.8 E, 2.8 E quattro	12/90-06/94	AAH	2771		0-N940	TB [TE]
2.8 E, 2.8 E quattro	12/90-06/94	AAH	2771		0-N941	TB [DG]
S4 Turbo quattro	08/91-06/94	AAN	2226		0-N941	TB [DG]
S4 V8 quattro	10/92-06/94	ABH	4172		0-N2414	TB [VD]
2.0 E 16V, 2.0 E 16V quattro	01/92-06/94	ACE	1984		0-N2345	VB [DG]
2.4 D	12/90-06/94	AAS	2370		0-N1601	VB [BT] S
2.5 TDI	12/90-06/94	AAT, ABP	2461		0-N1601	VB [BT] S
2.6, 2.6 E quattro, 2.6 quattro	03/92-07/94	ABC, ACZ	2598	ch.→4A-N-023926	0-N2347	VB [DG]
2.6, 2.6 quattro	03/92-06/94	ABC	2598	ch.4A-N-023927→	0-N1414	VB [DG]
2.8 E, 2.8 E quattro	12/90-06/94	AAH	2771	ch.4A-N-023927→	0-N1414	VB [DG]
2.8 E, 2.8 E quattro	12/90-06/94	AAH	2771	ch.→4A-N-023926	0-N2347	VB [DG]
S4 V8 quattro	10/92-06/94	ABH, AEC	4172		0-N1632	VB [DG]
S4 V8 quattro	10/92-06/94	ABH, AEC	4172		0-N1967	VB [VD]

100 Avant (4A, C4)

2.0 E	09/91-06/94	AAD, ABK, AAE	1984	18x124	SK-1119	BTK
2.0 E 16V, 2.0 E 16V quattro	07/92-06/94	ACE	1984	25x147	SK-1047	BTK
2.0 E quattro	12/90-07/92	AAD	1984	18x124; 08/1991 →	SK-1119	BTK
2.3 E, 2.3 E quattro	09/91-06/94	AAR	2309	19x147	SK-1130	BTK
2.5 TDI	12/90-06/94	AAT, ABP	2461	26.5x124; 08/1991 →; :→038460	SK-1570	BTK
2.6	03/92-06/94	ABC	2598	25x239; 08/1992 →	SK-1343	BTK

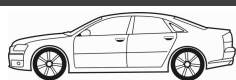

CM³



Art. Nr.



100 Avant (4A, C4)

2.6	07/93-06/94	ACZ	2598	25x239; 11/1993 →	SK-1343	BTK
2.6 E quattro, 2.6 quattro	07/92-07/94	ABC, ACZ	2598	25x239	SK-1343	BTK
2.6, 2.6 E quattro, 2.6 quattro	03/92-07/94	ABC, ACZ	2598	25x239	SK-1343AQ1	BTKW
2.8 E	09/91-06/94	AAH	2771	25x239; → 07/1993	SK-1343	BTK
2.8 E quattro	09/91-06/94	AAH	2771	25x239	SK-1343	BTK
2.8 E, 2.8 E quattro	09/91-06/94	AAH	2771	25x239	SK-1343AQ1	BTKW
1.6	03/92-07/93		1595		0-N805	TB [TE]
2.0 E 16V, 2.0 E 16V quattro	07/92-06/94	ACE	1984	:017140→	0-N129	TB [TE]
2.0 E, 2.0 E quattro	12/90-06/94	AAD, AAD, ABK, AAE	1984		0-N922	TB [TE]
2.3 E, 2.3 E quattro	09/91-06/94	AAR	2309		0-N939	TB [TE]
2.4 D	12/90-06/94	AAS	2370		0-N807	TB [DG]
2.4 D	12/90-06/94	AAS	2370		0-N921	TB [TE]
2.5 TDI	12/90-06/94	AAT, ABP	2461		0-N1229	TB [TE]
2.5 TDI	12/90-06/94	ABP	2461		0-N1230	TB [DG]
2.5 TDI	12/90-06/94	AAT	2461	für OE: N90705901	0-N1230	TB [DG]
2.5 TDI	12/90-06/94	AAT, ABP	2461		0-N921	TB [TE]
2.5 TDI	12/90-06/94	AAT, ABP	2461		0-N924	TB [DG]
2.6, 2.6 quattro	03/92-06/94	ABC	2598		0-N940	TB [TE]
2.6, 2.6 quattro	03/92-06/94	ABC	2598		0-N941	TB [DG]
2.8 E, 2.8 E quattro	09/91-06/94	AAH	2771		0-N940	TB [TE]
2.8 E, 2.8 E quattro	09/91-06/94	AAH	2771		0-N941	TB [DG]
S4 Turbo quattro	09/91-06/94	AAN	2226		0-N941	TB [DG]
S4 V8 quattro	10/92-06/94	ABH	4172		0-N2414	TB [VD]
2.0 E 16V, 2.0 E 16V quattro	07/92-06/94	ACE	1984		0-N2345	VB [DG]
2.4 D	12/90-06/94	AAS	2370		0-N1601	VB [BT] S
2.5 TDI	12/90-06/94	AAT, ABP	2461		0-N1601	VB [BT] S
2.6, 2.6 E quattro, 2.6 quattro	03/92-07/94	ABC, ACZ	2598	ch.→4A-N-023926	0-N2347	VB [DG]
2.6, 2.6 quattro	03/92-06/94	ABC	2598	ch.4A-N-023927→	0-N1414	VB [DG]
2.8 E, 2.8 E quattro	09/91-06/94	AAH	2771	ch.4A-N-023927→	0-N1414	VB [DG]
2.8 E, 2.8 E quattro	09/91-06/94	AAH	2771	ch.→4A-N-023926	0-N2347	VB [DG]
S4 V8 quattro	10/92-06/94	ABH, AEC	4172		0-N1632	VB [DG]
S4 V8 quattro	10/92-06/94	ABH, AEC	4172		0-N1967	VB [VD]

200 (43)

2.1 5 E, 2.1 5 T	10/79-09/82	WC, WJ	2144		0-N807	TB [DG]
------------------	-------------	--------	------	--	--------	---------

200 (44, 44Q)

2.2 20V Turbo quattro	03/89-12/90	3B	2226	19x147	SK-1127	BTK
2.2 Turbo	08/85-09/91	MC	2226	19x142; ch.44-K-000001→	SK-1126	BTK
2.2 Turbo	08/85-09/91	1B, 2B, MC	2226	19x142; ch.44-K-000001→	SK-1126AQ1	BTKW
2.2 Turbo quattro	01/85-12/91	MC	2226	19x142; ch.44-J-246282→	SK-1126	BTK
2.2 Turbo quattro	01/85-12/91	1B, MC	2226	19x142; ch.44-J-246282→	SK-1126AQ1	BTKW
2.2 Turbo, 2.2 Turbo quattro	02/88-12/90	1B, 2B	2226	19x142	SK-1126	BTK
2.3	11/86-09/91	NF	2309	19x142; :063969→	SK-1126AQ1	BTKW
2.1 5 E	08/83-07/84	WC	2144	ch.44-E-000001→	0-N807	TB [DG]
2.1 Turbo, 2.1 Turbo quattro	08/83-01/88	KG	2144	ch.44-E-012001→	0-N807	TB [DG]
2.2	08/84-07/85	KU	2226		0-N807	TB [DG]
2.2 20V Turbo quattro, 2.2 Turbo, 2.2 Turbo quattro	02/88-12/90	1B, 3B	2226	:→001570	0-N807	TB [DG]
2.2 20V Turbo quattro, 2.2 Turbo, 2.2 Turbo quattro	02/88-12/90	1B, 3B	2226	:001571→	0-N923	TB [TE]
2.2 Turbo	02/88-12/90	2B	2226	:→001068	0-N807	TB [DG]
2.2 Turbo	02/88-12/90	2B	2226	:001069→	0-N923	TB [TE]
2.2 Turbo, 2.2 Turbo quattro	01/85-12/91	MC	2226	:→039950	0-N807	TB [DG]
2.2 Turbo, 2.2 Turbo quattro	01/85-12/91	MC	2226	:039951→	0-N923	TB [TE]
2.3	11/86-09/91	NF	2309	:→063968	0-N807	TB [DG]
2.3	11/86-09/91	NF	2309	:063969→	0-N923	TB [TE]

200 Avant (44, 44Q)

2.2 20V Turbo quattro	07/89-12/90	3B	2226	19x147	SK-1127	BTK
2.2 Turbo	08/85-09/91	MC	2226	19x142; ch.44-K-000001→	SK-1126	BTK
2.2 Turbo	08/85-09/91	MC	2226	19x142; ch.44-K-000001→	SK-1126AQ1	BTKW
2.2 Turbo quattro	09/83-12/90	MC	2226	19x142; ch.44-J-246282→	SK-1126	BTK
2.2 Turbo quattro	09/83-12/91	1B, MC	2226	19x142; ch.44-J-246282→	SK-1126AQ1	BTKW
2.2 Turbo quattro	02/88-12/91	1B	2226	19x142; → 11/1990	SK-1126	BTK
2.3	11/86-09/91	NF	2309	19x142; :063969→	SK-1126AQ1	BTKW
2.1 Turbo quattro	09/83-01/88	JY, KG	2144		0-N807	TB [DG]
2.2 20V Turbo quattro, 2.2 Turbo quattro	02/88-12/91	1B, 3B	2226	:→001570	0-N807	TB [DG]



CM³



Art. Nr.



200 Avant (44, 44Q)

2.2 20V Turbo quattro, 2.2 Turbo quattro	02/88-12/91	1B, 3B	2226	:001571→	0-N923	TB [TE]	
2.2 Turbo, 2.2 Turbo quattro	09/83-09/91	MC	2226	:→039950	0-N807	TB [DG]	
2.2 Turbo, 2.2 Turbo quattro	09/83-09/91	MC	2226	:039951→	0-N923	TB [TE]	
2.3	11/86-09/91	NF	2309	:→063968	0-N807	TB [DG]	
2.3	11/86-09/91	NF	2309	:063969→	0-N923	TB [TE]	

A1 (8X1, 8XK, 8XF)

1.6 TDI	05/10-	CAYC	1598	25x160	SK-1695	BTK	
1.6 TDI	05/10-	CAYC	1598	25x160	SK-1695AQ1	BTKW	
1.6 TDI	05/10-	CAYC	1598	25x160	SK-1727AQ1	BTKW	
1.6 TDI	03/11-	CAYB	1598	25x160	SK-1727	BTK	
1.6 TDI	03/11-	CAYB	1598	25x160	SK-1727AQ1	BTKW	
2.0 TDI	09/11-	CFHB, CFHD	1968	25x160	SK-1727	BTK	
2.0 TDI	09/11-	CFHB, CFHD	1968	25x160	SK-1727AQ1	BTKW	
2.0 TFSI quattro	03/12-	CDLH	1984	23x148	SK-1724	BTK	
2.0 TFSI quattro	03/12-	CDLH	1984	23x148	SK-1724AQ1	BTKW	
1.4 TDI	11/14-	CUSB	1422		0-N2314	TB [TE]	
1.4 TFSI	04/12-	CPTA	1395		0-N2313	TB [TE]	
1.4 TFSI	04/12-	CPTA	1395		0-N2381	TB [DG]	
1.6 TDI	05/10-	CAYB, CAYC	1598		0-N131	TB [DG]	
1.6 TDI	05/10-	CAYB, CAYC	1598		0-N2025	TB [DG]	
1.6 TDI	05/10-	CAYB, CAYC	1598		0-N2061	TB [TE]	
1.6 TDI	05/10-	CAYB, CAYC	1598		0-N2200	TB [DG]	
2.0 TDI	09/11-	CFHB, CFHD	1968		0-N131	TB [DG]	
2.0 TDI	09/11-	CFHD	1968		0-N2025	TB [DG]	
2.0 TDI	09/11-	CFHB, CFHD	1968		0-N2061	TB [TE]	
2.0 TDI	09/11-	CFHB, CFHD	1968		0-N2200	TB [DG]	
2.0 TFSI quattro	03/12-	CDLH	1984		0-N1316	TB [DG]	
2.0 TFSI quattro	03/12-	CDLH	1984		0-N1346	TB [DG]	
2.0 TFSI quattro	03/12-	CDLH	1984		0-N2208	TB [TE]	
1.2 TFSI	05/10-	CBZA	1197		0-N1733	VB [BT]	S
1.2 TFSI	05/10-	CBZA	1197		0-N2121	VB [DG]	
1.4 TFSI	05/10-	CAXA, CNVA	1390		0-N1454	VB [DG]	
1.4 TFSI	05/10-	CAXA, CNVA	1390		0-N1525	VB [BT]	S
1.4 TFSI	05/10-	CAXA, CNVA	1390		0-N1733	VB [BT]	S
1.4 TFSI	01/11-	CAVG, CTHG, CTJA	1390		0-N2091	VB [BT]	S
1.4 TFSI	01/11-	CAVG, CTHG, CTJA	1390		0-N2092	VB [BT]	S
1.4 TFSI	01/11-	CAVG, CTHG, CTJA	1390		0-N2111	VB [BT]	S
1.4 TFSI	01/11-	CAVG, CTHG, CTJA	1390	Rippenanzahl: 6;	0-N2133	VB [DG]	
1.6 TDI	05/10-	CAYB, CAYC	1598		0-N1534	VB [BT]	S
1.6 TDI	11/14-	CXMA	1598		0-N2288	VB [BT]	S
2.0 TDI	09/11-	CFHB, CFHD	1968		0-N1534	VB [BT]	S
2.0 TFSI quattro	03/12-	CDLH	1984		0-N1656	VB [BT]	S

A1 Sportback (8XA, 8XF, 8XK)

1.6 TDI	11/11-	CAYC	1598	25x160	SK-1695	BTK	
1.6 TDI	11/11-	CAYC	1598	25x160	SK-1695AQ1	BTKW	
1.6 TDI	11/11-	CAYB	1598	25x160	SK-1727	BTK	
1.6 TDI	11/11-	CAYB	1598	25x160	SK-1727AQ1	BTKW	
1.6 TDI	11/11-	CAYC	1598	25x160	SK-1727AQ1	BTKW	
2.0 TDI	09/11-	CFHB, CFHD	1968	25x160	SK-1727	BTK	
2.0 TDI	05/12-	CFHB	1968	25x160	SK-1727AQ1	BTKW	
1.4 TDI	11/14-	CUSB	1422		0-N2314	TB [TE]	
1.4 TFSI	04/12-	CPTA, CZEA	1395		0-N2313	TB [TE]	
1.4 TFSI	04/12-	CPTA	1395		0-N2381	TB [DG]	
1.6 TDI	11/11-	CAYC	1598		0-N131	TB [DG]	
1.6 TDI	11/11-	CAYC	1598		0-N2061	TB [TE]	
1.6 TDI	11/11-	CAYC	1598		0-N2200	TB [DG]	
2.0 TDI	09/11-	CFHB, CFHD	1968		0-N131	TB [DG]	
2.0 TDI	09/11-	CFHB, CFHD	1968		0-N2061	TB [TE]	
2.0 TDI	09/11-	CFHB, CFHD	1968		0-N2200	TB [DG]	
1.2 TFSI	01/12-	CBZA	1197		0-N1733	VB [BT]	S
1.2 TFSI	01/12-	CBZA	1197		0-N2121	VB [DG]	
1.4 TFSI	11/11-	CAXA, CNVA	1390		0-N1525	VB [BT]	S
1.4 TFSI	11/11-	CAXA, CNVA	1390		0-N1733	VB [BT]	S
1.4 TFSI	11/11-	CAVG, CTHG, CTJA	1390		0-N2091	VB [BT]	S

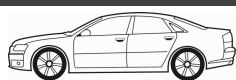

CM³



Art. Nr.



A1 Sportback (8XA, 8XF, 8XK)

1.4 TFSI	11/11-	CAVG, CTHG, CTJA	1390		0-N2092	VB [BT]	S
1.4 TFSI	11/11-	CAVG, CTHG, CTJA	1390	✳	0-N2111	VB [BT]	S
1.4 TFSI	11/11-	CAVG, CTHG, CTJA	1390	Rippenanzahl: 6; ✳	0-N2133	VB [DG]	
1.6 TDI	11/11-	CAYC	1598		0-N1534	VB [BT]	S
1.6 TDI	11/11-	CAYB	1598	✳	0-N1534	VB [BT]	S
1.6 TDI	11/14-	CXMA	1598	✳	0-N2288	VB [BT]	S
2.0 TDI	09/11-	CFHB, CFHD	1968		0-N1534	VB [BT]	S

A2 (8Z0)

1.2 TDI	03/01-08/05	ANY	1191	30x117; → 07/2005; ohne Spanndämpfer, Spannrolle; Baumuster: 8Z0	SK-1603	BTK	
1.2 TDI	03/01-08/05	ANY	1191	30x117; ohne Spanndämpfer, Spannrolle	SK-1603AQ1	BTKW	
1.2 TDI	03/01-08/05	ANY	1191	30x117; → 07/2005; mit Spanndämpfer, Spannrolle; Baumuster: 8Z0	SK-1604	BTK	
1.2 TDI	03/01-08/05	ANY	1191	30x117; mit Spanndämpfer, Spannrolle	SK-1604AQ1	BTKW	
1.4	02/00-08/05	AUA, BBY	1390	20x130; 17x58; beinhaltetete Rollen: 4	SK-1511	BTK	
1.4	02/00-08/05	AUA, BBY	1390	20x130; 17x58; beinhaltetete Rollen: 4	SK-1511AQ1	BTKW	
1.4 TDI	02/00-08/05	AMF, BHC	1422	30x120; ch.8Z-2-017001→; mit Zubehör	SK-1372	BTK	
1.4 TDI	02/00-08/05	AMF, BHC	1422	30x120; ch.8Z-2-022814→; 8Z-2-070000	SK-1372AQ1	BTKW	
1.4 TDI	02/00-08/05	AMF, BHC	1422	30x120; ch.8Z-3-000001→	SK-1372AQ1	BTKW	
1.4 TDI	02/00-08/05	AMF, BHC	1422	30x120; ch.→8Z-2-017000; mit Zubehör; Baumuster: 8Z0	SK-1582	BTK	
1.4 TDI	02/00-08/05	AMF, BHC	1422	30x120; ch.→8Z-2-022813; ohne Spanndämpfer, Spannrolle; mit Zubehör	SK-1582AQ2	BTKW	
1.4 TDI	02/00-08/05	AMF, BHC	1422	30x120; ch.→8Z-2-017000; mit Spanndämpfer, Spannrolle; mit Zubehör; Baumuster: 8Z0	SK-1583	BTK	
1.4 TDI	02/00-08/05	AMF, BHC	1422	30x120; ch.→8Z-2-022813; mit Spanndämpfer, Spannrolle; mit Zubehör	SK-1583AQ2	BTKW	
1.4 TDI	11/03-08/05	ATL	1422	30x120; mit Zubehör	SK-1372	BTK	
1.4 TDI	11/03-08/05	ATL	1422	30x120	SK-1372AQ1	BTKW	
1.6 FSI	05/02-08/05	BAD	1598	20x130; 17x58; beinhaltetete Rollen: 4	SK-1511	BTK	
1.6 FSI	05/02-08/05	BAD	1598	20x130; 17x58; beinhaltetete Rollen: 4	SK-1511AQ2	BTKW	
1.2 TDI	03/01-08/05	ANY	1191		0-N1048	TB [TE]	
1.2 TDI	03/01-08/05	ANY	1191		0-N1268	TB [DG]	
1.2 TDI	03/01-08/05	ANY	1191		0-N1344	TB [BT]	
1.4	02/00-08/05	AUA, BBY	1390		0-N1262	TB [DG]	
1.4	02/00-08/05	AUA, BBY	1390		0-N1263	TB [TE]	
1.4	02/00-08/05	AUA, BBY	1390		0-N158	TB [TE]	
1.4	02/00-08/05	AUA, BBY	1390		0-N164	TB [DG]	
1.4 TDI	02/00-08/05	BHC	1422		0-N1045	TB [TE]	
1.4 TDI	02/00-08/05	AMF, BHC	1422	ch.8Z-2-017001→	0-N1045	TB [TE]	
1.4 TDI	02/00-08/05	BHC	1422		0-N1046	TB [DG]	
1.4 TDI	02/00-08/05	AMF	1422	ch.8Z-2-017001→	0-N1046	TB [DG]	
1.4 TDI	02/00-08/05	AMF	1422	ch.→8Z-2-017000	0-N1048	TB [TE]	
1.4 TDI	02/00-08/05	AMF	1422	ch.→8Z-2-017000	0-N1268	TB [DG]	
1.4 TDI	02/00-08/05	AMF	1422	ch.→8Z-2-017000	0-N1274	TB [BT]	
1.4 TDI	11/03-08/05	ATL	1422		0-N1045	TB [TE]	
1.4 TDI	11/03-08/05	ATL	1422		0-N1046	TB [DG]	
1.6 FSI	05/02-08/05	BAD	1598		0-N1262	TB [DG]	
1.6 FSI	05/02-08/05	BAD	1598		0-N1263	TB [TE]	
1.6 FSI	05/02-08/05	BAD	1598		0-N158	TB [TE]	
1.6 FSI	05/02-08/05	BAD	1598		0-N164	TB [DG]	
1.2 TDI	03/01-08/05	ANY	1191		0-N1704	VB [BT]	S
1.4	02/00-08/05	AUA, BBY	1390	✳	0-N1445	VB [BT]	S
1.4 TDI	02/00-08/05	AMF, BHC, ATL	1422		0-N1704	VB [BT]	S
1.6 FSI	05/02-08/05	BAD	1598	✳	0-N1445	VB [BT]	S

A3 (8L1)

1.6	09/96-05/03	AEH, AKL, APF	1595	23x138; Baumuster: 8L1	SK-1109	BTK	
1.6	09/96-05/03	AEH, AKL, APF, AVU, BFQ	1595	23x138	SK-1109AQ1	BTKW	
1.6	08/00-05/03	AVU, BFQ	1595	23x138; Baumuster: 8L1	SK-1109	BTK	
1.8 T	12/96-05/03	AGU, ARZ, AUM	1781	23x150; ch.→8L-Y-125000; mit Spanndämpfer, Spannrolle	SK-1337	BTK	
1.8 T	12/96-05/03	AGU, ARZ, AUM	1781	23x150; ch.→8L-Y-125000; mit Spanndämpfer, Spannrolle	SK-1337AQ1	BTKW	
1.8 T	12/96-05/03	AGU, ARZ, AUM	1781	23x150; ch.8L-Y-125001→	SK-1660	BTK	
1.8 T	12/96-05/03	AGU, ARZ, AUM	1781	23x150; ch.8L-Y-125001→	SK-1660AQ1	BTKW	
1.8 T	12/96-05/03	AGU, ARZ, AUM	1781	23x150; ch.→8L-Y-125000	SK-1709	BTK	



CM³



Art. Nr.



ohne Halter

A3 (8L1)

1.8 T	12/96-05/03	AGU, ARZ, AUM	1781	23x150; ch.8L-Y-125001→	SK-1710	BTK
1.8 T	12/98-05/03	AJQ, APP, ARY, AUQ	1781	23x150; ch.→8L-Y-125000; 07/1999 →; mit Spanndämpfer, Spannrolle	SK-1337	BTK
1.8 T	12/98-05/03	AJQ, APP, ARY, AUQ	1781	23x150; ch.→8L-Y-125000; 07/1999 →; mit Spanndämpfer, Spannrolle	SK-1337AQ1	BTKW
1.8 T	12/98-05/03	AJQ, APP, ARY, AUQ	1781	23x150; ch.8L-Y-125001→; 07/1999 →	SK-1660	BTK
1.8 T	12/98-05/03	AJQ, APP, ARY, AUQ	1781	23x150; ch.8L-Y-125001→; 07/1999 →	SK-1660AQ1	BTKW
1.8 T	12/98-05/03	AJQ, APP, ARY, AUQ	1781	23x150; ch.→8L-Y-125000; 07/1999 →	SK-1709	BTK
1.8 T	12/98-05/03	AJQ, APP, ARY, AUQ	1781	23x150; ch.8L-Y-125001→; 07/1999 →	SK-1710	BTK
1.8 T quattro	12/96-05/03	AGU, AQA, ARX	1781	23x150; ch.→8L-Y-125000; 08/1997 →; mit Spanndämpfer, Spannrolle	SK-1337	BTK
1.8 T quattro	12/96-05/03	AGU, AQA, ARX	1781	23x150; ch.→8L-Y-125000; 08/1997 →; mit Spanndämpfer, Spannrolle	SK-1337AQ1	BTKW
1.8 T quattro	12/96-05/03	AGU, AQA, ARX	1781	23x150; ch.8L-Y-125001→; 08/1997 →	SK-1660	BTK
1.8 T quattro	12/96-05/03	AGU, AQA, ARX	1781	23x150; ch.8L-Y-125001→; 08/1997 →	SK-1660AQ1	BTKW
1.8 T quattro	12/96-05/03	AGU, AQA, ARX	1781	23x150; ch.→8L-Y-125000; 08/1997 →	SK-1709	BTK
1.8 T quattro	12/96-05/03	AGU, AQA, ARX	1781	23x150; ch.8L-Y-125001→; 08/1997 →	SK-1710	BTK
1.8 T quattro	10/98-05/03	AJQ, ARY	1781	23x150; ch.→8L-Y-125000; 11/1998 →	SK-1709	BTK
1.8 T quattro	10/98-05/03	AJQ, ARY	1781	23x150; ch.8L-Y-125001→; 11/1998 →	SK-1710	BTK
1.8, 1.8 T quattro, S3 quattro	09/96-05/03	AGN, APG, AJQ, ARY, AMK, APY, AUL	1781	23x150; ch.→8L-Y-125000 mit Spanndämpfer, Spannrolle	SK-1337	BTK
1.8, 1.8 T quattro, S3 quattro	09/96-05/03	AGN, APG, AJQ, ARY, AMK, APY, AUL	1781	23x150; ch.→8L-Y-125000 mit Spanndämpfer, Spannrolle	SK-1337AQ1	BTKW
1.8, 1.8 T quattro, S3 quattro	09/96-05/03	AGN, APG, AJQ, ARY, AMK, APY, AUL	1781	23x150; ch.8L-Y-125001→	SK-1660	BTK
1.8, 1.8 T quattro, S3 quattro	09/96-05/03	AGN, APG, AJQ, ARY, AMK, APY, AUL	1781	23x150; ch.8L-Y-125001→	SK-1660AQ1	BTKW
1.8, S3 quattro	09/96-05/03	AGN, APG, AMK, APY, AUL	1781	23x150; ch.→8L-Y-125000	SK-1709	BTK
1.8, S3 quattro	09/96-05/03	AGN, APG, AMK, APY, AUL	1781	23x150; ch.8L-Y-125001→	SK-1710	BTK
1.9 TDI	09/96-07/01	AGR, ALH	1896	25x141; →AGR044441; mit Zubehör	SK-1110	BTK
1.9 TDI	09/96-07/01	AGR, ALH	1896	25x141; →ALH500000; mit Zubehör	SK-1111	BTK
1.9 TDI	09/96-07/01	AGR, ALH	1896	25x141; →AGR044442→; →AGR565000; mit Zubehör	SK-1111	BTK
1.9 TDI	09/96-07/01	AGR, ALH	1896	25x141; →ALH500000; mit Zubehör	SK-1111AQ1	BTKW
1.9 TDI	09/96-07/01	AGR, ALH	1896	25x141; →AGR044442→; →AGR565000; mit Zubehör	SK-1111AQ1	BTKW
1.9 TDI	09/96-07/01	AGR, ALH	1896	25x141; →ALH500001→; mit Zubehör	SK-1258	BTK
1.9 TDI	09/96-07/01	AGR, ALH	1896	25x141; →AGR565001→; mit Zubehör	SK-1258AQ1	BTKW
1.9 TDI	09/96-07/01	AGR, ALH	1896	25x141; →ALH500001→; mit Zubehör	SK-1258AQ1	BTKW
1.9 TDI	09/96-07/01	AGR, ALH	1896	25x141; →AGR044441	SK-1259	BTK
1.9 TDI	08/97-07/01	AHF	1896	25x141; →AHF006065; mit Zubehör	SK-1110	BTK
1.9 TDI	08/97-07/01	ASV	1896	25x141; →ASV150000; mit Zubehör	SK-1111	BTK
1.9 TDI	08/97-07/01	AHF	1896	25x141; →AHF006066→; →AHF006065; mit Zubehör	SK-1111	BTK
1.9 TDI	08/97-07/01	ASV	1896	25x141; →ASV150000; mit Zubehör	SK-1111AQ1	BTKW
1.9 TDI	08/97-07/01	AHF	1896	25x141; →AHF006066→; →AHF595000; mit Zubehör	SK-1111AQ1	BTKW
1.9 TDI	08/97-07/01	AHF, ASV	1896	25x141; →AHF595001, ASV150001→; mit Zubehör	SK-1258	BTK
1.9 TDI	08/97-07/01	AHF	1896	25x141; →AHF595001→; mit Zubehör	SK-1258AQ1	BTKW
1.9 TDI	08/97-07/01	ASV	1896	25x141; →ASV150001→; mit Zubehör	SK-1258AQ1	BTKW
1.9 TDI	08/97-07/01	AHF	1896	25x141; →AHF006065	SK-1259	BTK
1.9 TDI	10/00-05/03	ATD, AXR	1896	30x120; →165001→; mit Zubehör	SK-1372	BTK
1.9 TDI	10/00-05/03	AXR	1896	30x120	SK-1372AQ2	BTKW
1.9 TDI	10/00-05/03	ATD	1896	30x120; →ATD165001→	SK-1372AQ2	BTKW
1.9 TDI	10/00-05/03	ATD, AXR	1896	30x120; →ATD165000; mit Zubehör; Baumuster: 8L1	SK-1582	BTK
1.9 TDI	10/00-05/03	ATD	1896	30x120; →ATD165000; ohne Spanndämpfer, Spannrolle; mit Zubehör	SK-1582AQ1	BTKW
1.9 TDI	10/00-05/03	ATD, AXR	1896	30x120; →ATD165000; mit Spanndämpfer, Spannrolle; mit Zubehör; Baumuster: 8L1	SK-1583	BTK
1.9 TDI	10/00-05/03	ATD	1896	30x120; →ATD165000; mit Spanndämpfer, Spannrolle; mit Zubehör	SK-1583AQ1	BTKW
1.9 TDI, 1.9 TDI quattro	08/00-05/03	ASZ	1896	30x120; →115001→; mit Zubehör	SK-1372	BTK
1.9 TDI, 1.9 TDI quattro	08/00-05/03	ASZ	1896	30x120; →ASZ115001→	SK-1372AQ2	BTKW
1.9 TDI, 1.9 TDI quattro	08/00-05/03	ASZ	1896	30x120; →ASZ115000; mit Zubehör; Baumuster: 8L1	SK-1582	BTK
1.9 TDI, 1.9 TDI quattro	08/00-05/03	ASZ	1896	30x120; →ASZ115000; ohne Spanndämpfer, Spannrolle; mit Zubehör	SK-1582AQ1	BTKW
1.9 TDI, 1.9 TDI quattro	08/00-05/03	ASZ	1896	30x120; →ASZ115000; mit Spanndämpfer, Spannrolle; mit Zubehör; Baumuster: 8L1	SK-1583	BTK



CM³



Art. Nr.



A3 (8L1)							
1.9 TDI, 1.9 TDI quattro	08/00-05/03	ASZ	1896	30x120; → ASZ115000; mit Spanndämpfer, Spannrolle; mit Zubehör	SK-1583AQ1	BTKW	
S3 quattro	10/01-05/03	BAM	1781	23x150	SK-1660	BTK	
S3 quattro	10/01-05/03	BAM	1781	23x150	SK-1660AQ1	BTKW	
S3 quattro	10/01-05/03	BAM	1781	23x150	SK-1710	BTK	
1.6	09/96-05/03	AEH, AKL, APF, AVU, BFQ	1595		0-N157	TB [TE]	
1.8 T	12/96-05/03	AGU, ARZ, AUM	1781	ch.8L-Y-125001→	0-N1042	TB [TE]	
1.8 T	12/96-05/03	AGU, ARZ, AUM	1781	ch.→8L-Y-125000	0-N1654	TB [TE]	
1.8 T	12/98-05/03	AJQ, APP, ARY, AUQ	1781	ch.8L-Y-125001→; 07/1999 →	0-N1042	TB [TE]	
1.8 T	12/98-05/03	AJQ, APP, ARY, AUQ	1781	ch.→8L-Y-125000; 07/1999 →	0-N1654	TB [TE]	
1.8 T quattro	12/96-05/03	AGU, AQA, ARX	1781	ch.8L-Y-125001→; 08/1997 →	0-N1042	TB [TE]	
1.8 T quattro	12/96-05/03	AGU, AQA, ARX	1781	ch.→8L-Y-125000; 08/1997 →	0-N1654	TB [TE]	
1.8 T quattro	10/98-05/03	AJQ, ARY	1781	ch.8L-Y-125001→; 11/1998 →	0-N1042	TB [TE]	
1.8 T quattro	10/98-05/03	AJQ, ARY	1781	ch.→8L-Y-125000; 11/1998 →	0-N1654	TB [TE]	
1.8, 1.8 T, 1.8 T quattro, S3 quattro	09/96-05/03	AGN, APG, AGU, AQA, ARX, AGU, AQA, ARZ, AUM, AJQ, APP, ARY, AUQ, AJQ, ARY, AMK, APY, AUL, BAM	1781		0-N1237	TB [BT]	
1.8, 1.8 T, 1.8 T quattro, S3 quattro	09/96-05/03	AGN, APG, AGU, AQA, ARX, AGU, AQA, ARZ, AUM, AJQ, APP, ARY, AUQ, AJQ, ARY, AMK, APY, AUL, BAM	1781		0-N1316	TB [DG]	
1.8, S3 quattro	09/96-05/03	AGN, APG, AMK, APY, AUL	1781	ch.8L-Y-125001→	0-N1042	TB [TE]	
1.8, S3 quattro	09/96-05/03	AGN, APG, AMK, APY, AUL	1781	ch.→8L-Y-125000	0-N1654	TB [TE]	
1.9 TDI	09/96-07/01	ALH	1896		0-N107	TB [TE]	
1.9 TDI	09/96-07/01	AGR	1896	:→044441	0-N107	TB [TE]	
1.9 TDI	09/96-07/01	AGR	1896	:044442→	0-N107	TB [TE]	
1.9 TDI	09/96-07/01	AGR, ALH, AHF, ASV	1896		0-N131	TB [DG]	
1.9 TDI	09/96-07/01	AGR, ALH, AHF, ASV	1896		0-N166	TB [DG]	
1.9 TDI	09/96-07/01	ALH	1896		0-N167	TB [DG]	
1.9 TDI	09/96-07/01	AGR	1896	:044442→	0-N167	TB [DG]	
1.9 TDI	08/97-07/01	ASV	1896		0-N107	TB [TE]	
1.9 TDI	08/97-07/01	AHF	1896	:→006065	0-N107	TB [TE]	
1.9 TDI	08/97-07/01	AHF	1896	:006066→	0-N107	TB [TE]	
1.9 TDI	08/97-07/01	ASV	1896		0-N167	TB [DG]	
1.9 TDI	08/97-07/01	AHF	1896	:006066→	0-N167	TB [DG]	
1.9 TDI	10/00-05/03	AXR	1896		0-N1045	TB [TE]	
1.9 TDI	10/00-05/03	ATD	1896	:165001→	0-N1045	TB [TE]	
1.9 TDI	10/00-05/03	AXR	1896		0-N1046	TB [DG]	
1.9 TDI	10/00-05/03	ATD	1896	:165001→	0-N1046	TB [DG]	
1.9 TDI	10/00-05/03	ATD	1896	:→165000	0-N1048	TB [TE]	
1.9 TDI	10/00-05/03	ATD	1896	:→165000	0-N1268	TB [DG]	
1.9 TDI	10/00-05/03	ATD	1896	:→165000	0-N1274	TB [BT]	
1.9 TDI, 1.9 TDI quattro	08/00-05/03	ASZ	1896	:115001→	0-N1045	TB [TE]	
1.9 TDI, 1.9 TDI quattro	08/00-05/03	ASZ	1896	:115001→	0-N1046	TB [DG]	
1.9 TDI, 1.9 TDI quattro	08/00-05/03	ASZ	1896	:→115000	0-N1048	TB [TE]	
1.9 TDI, 1.9 TDI quattro	08/00-05/03	ASZ	1896	:→115000	0-N1268	TB [DG]	
1.9 TDI, 1.9 TDI quattro	08/00-05/03	ASZ	1896	:→115000	0-N1274	TB [BT]	
S3 quattro	10/01-05/03	BAM	1781		0-N1042	TB [TE]	
1.6	09/96-05/03	AEH, AKL, APF	1595		0-N1041	VB [BT]	S
1.6	08/00-05/03	AVU	1595		0-N1041	VB [BT]	S
1.8 T	12/98-05/03	AJQ, APP, AUQ	1781		0-N1041	VB [BT]	S
1.8 T quattro	12/96-05/03	AGU, AQA	1781		0-N1041	VB [BT]	S
1.8 T quattro	10/98-05/03	AJQ	1781		0-N1041	VB [BT]	S
1.8, 1.8 T	09/96-05/03	AGN, APG, AGU, AQA, ARZ, AUM	1781		0-N1041	VB [BT]	S
1.9 TDI	09/96-07/01	AGR, ALH, AHF, ASV	1896	ch.8L-W-000001→	0-N1538	VB [BT]	S
1.9 TDI	09/96-07/01	AGR, ALH, AHF, ASV	1896	ch.→8L-V-200000	0-N1606	VB [BT]	S
1.9 TDI	09/96-07/01	AGR, ALH, AHF, ASV	1896		0-N174	VB [DG]	
1.9 TDI, 1.9 TDI quattro	08/00-05/03	ASZ, ATD, AXR	1896		0-N1494	VB [BT]	S
A3 (8P1)							
1.6	05/03-08/12	BGU, BSE, BSF, CCSA	1595	23x138; Baumuster: 8P1	SK-1109	BTK	
1.6 E-Power	01/11-08/12	CCSA, CMXA	1595	23x138; Baumuster: 8P1	SK-1109	BTK	
1.6 TDI	05/09-08/12	CAYB, CAYC	1598	25x160	SK-1695	BTK	
1.6 TDI	05/09-08/12	CAYC	1598	25x160	SK-1695AQ1	BTKW	
1.6 TDI	05/09-08/12	CAYB	1598	25x160	SK-1727AQ1	BTKW	
1.6 TDI	05/09-08/12	CAYC	1598	25x160	SK-1727AQ1	BTKW	
1.6, 1.6 E-Power	05/03-08/12	BGU, BSE, BSF, CCSA, CMXA, CCSA, CMXA	1595	23x138	SK-1109AQ1	BTKW	



CM³



Art. Nr.



A3 (8P1)

1.9 TDI	05/03-05/10	BKC, BLS, BXE	1896	30x120; mit Zubehör	SK-1372	BTK
1.9 TDI	05/03-05/10	BKC, BLS, BXE	1896	30x120	SK-1372AQ1	BTkW
2.0 FSI	05/03-06/08	AXW, BMB	1984	23x145; mit Zubehör	SK-1599	BTK
2.0 FSI	05/03-06/08	AXW, BMB	1984	23x145; mit Zubehör	SK-1599AQ1	BTkW
2.0 FSI	05/03-06/08	BLR, BLX, BLY, BVY, BVZ	1984	23x148	SK-1724	BTK
2.0 FSI	05/03-06/08	BLR, BLX, BLY, BVY, BVZ	1984	23x148	SK-1724AQ2	BTkW
2.0 TDI	05/03-08/12	AZV	1968	30x141; → 12/2006; mit Zubehör	SK-1595	BTK
2.0 TDI	05/03-08/12	AZV	1968	30x141; → 12/2006; mit Zubehör	SK-1595AQ1	BTkW
2.0 TDI	05/03-08/12	AZV	1968	30x141; 01/2007 →; mit Zubehör	SK-1668	BTK
2.0 TDI	05/03-08/12	AZV	1968	30x141; 01/2007 →	SK-1668AQ1	BTkW
2.0 TDI	05/03-08/12	CBAA	1968	30x160; 06/2003 →	SK-1694	BTK
2.0 TDI	05/03-08/12	CBAA	1968	30x160	SK-1694AQ1	BTkW
2.0 TDI	05/03-08/12	CFFA	1968	25x160	SK-1695	BTK
2.0 TDI	05/03-08/12	CFFA	1968	25x160	SK-1695AQ1	BTkW
2.0 TDI	06/06-06/08	BUY	1968	30x141; mit Zubehör	SK-1668	BTK
2.0 TDI	06/06-06/08	BUY	1968	30x141	SK-1668AQ1	BTkW
2.0 TDI 16V	05/03-08/12	BKD	1968	30x141; → 01/2007; mit Zubehör	SK-1595	BTK
2.0 TDI 16V	05/03-08/12	BKD	1968	30x141; → 01/2007; mit Zubehör	SK-1595AQ1	BTkW
2.0 TDI 16V	05/03-08/12	CBAB	1968	30x160; 06/2003 →	SK-1694	BTK
2.0 TDI 16V	05/03-08/12	CFFB, CLJA	1968	25x160	SK-1695	BTK
2.0 TDI 16V	05/03-08/12	CFFB, CLJA	1968	25x160	SK-1695AQ1	BTkW
2.0 TDI 16V	05/03-08/12	BKD, CBAB, CFFB, CLJA	1968	25x160; → 11/2010	SK-1727AQ1	BTkW
2.0 TDI 16V quattro	08/04-08/12	BKD	1968	30x141; → 12/2006; mit Zubehör	SK-1595	BTK
2.0 TDI 16V quattro	08/04-08/12	BKD	1968	30x141; → 12/2006; mit Zubehör	SK-1595AQ1	BTkW
2.0 TDI 16V quattro	08/04-08/12	CBAB	1968	30x160	SK-1694	BTK
2.0 TDI 16V quattro	08/04-08/12	CFFB	1968	25x160	SK-1695	BTK
2.0 TDI 16V quattro	08/04-08/12	CFFB	1968	25x160	SK-1695AQ1	BTkW
2.0 TDI 16V, 2.0 TDI 16V quattro	05/03-08/12	BKD	1968	30x141; 01/2007 →; mit Zubehör	SK-1668	BTK
2.0 TDI 16V, 2.0 TDI 16V quattro	05/03-08/12	BKD	1968	30x141; 01/2007 →	SK-1668AQ1	BTkW
2.0 TDI 16V, 2.0 TDI 16V quattro	05/03-08/12	CBAB	1968	30x160	SK-1694AQ1	BTkW
2.0 TDI quattro	05/03-06/08	AZV	1968	30x141; → 01/2007; mit Zubehör	SK-1595	BTK
2.0 TDI quattro	05/03-06/08	AZV	1968	30x141; → 12/2006; mit Zubehör	SK-1595AQ1	BTkW
2.0 TDI quattro	05/03-06/08	AZV	1968	30x141; 01/2007 →; mit Zubehör	SK-1668	BTK
2.0 TDI quattro	05/03-06/08	AZV	1968	30x141; 01/2007 →	SK-1668AQ1	BTkW
2.0 TDI quattro	05/03-06/08	AZV	1968	30x160	SK-1694	BTK
2.0 TDI quattro	05/03-06/08	AZV	1968	30x160	SK-1694AQ1	BTkW
2.0 TDI, 2.0 TDI 16V quattro	05/03-08/12	CFFA, CFFB	1968	25x160; → 11/2010	SK-1727AQ1	BTkW
2.0 TDI, 2.0 TDI quattro	06/05-06/08	BMM	1968	30x120; mit Zubehör	SK-1372	BTK
2.0 TDI, 2.0 TDI quattro	06/05-06/08	BMM	1968	30x120; ch.→8P-6-131500	SK-1372AQ2	BTkW
2.0 TDI, 2.0 TDI quattro	03/06-08/12	BMN	1968	30x141; mit Zubehör	SK-1668	BTK
2.0 TDI, 2.0 TDI quattro	03/06-08/12	BMN	1968	30x141	SK-1668AQ1	BTkW
2.0 TDI, 2.0 TDI quattro	03/06-08/12	CBBB	1968	30x160	SK-1694	BTK
2.0 TDI, 2.0 TDI quattro	03/06-08/12	CBBB	1968	30x160	SK-1694AQ2	BTkW
2.0 TDI, 2.0 TDI quattro	03/06-08/12	CFGB	1968	25x160	SK-1695	BTK
2.0 TDI, 2.0 TDI quattro	03/06-08/12	CFGB	1968	25x160	SK-1695AQ1	BTkW
2.0 TDI, 2.0 TDI quattro	03/06-08/12	CFGB	1968	25x160; → 11/2010	SK-1727AQ2	BTkW
2.0 TFSI, 2.0 TFSI quattro	09/04-08/12	AXX, BWA	1984	23x148	SK-1724	BTK
2.0 TFSI, 2.0 TFSI quattro	09/04-08/12	AXX, BWA	1984	23x148	SK-1724AQ1	BTkW
S3 quattro	11/06-08/12	BHZ, CDLA, BZC, CDLC	1984	23x148	SK-1724	BTK
S3 quattro	11/06-08/12	BHZ, CDLA, BZC, CDLC	1984	23x148	SK-1724AQ1	BTkW
1.6 TDI	05/09-08/12	CAYB, CAYC	1598		0-N131	TB [DG]
1.6 TDI	05/09-08/12	CAYB, CAYC	1598		0-N2025	TB [DG]
1.6 TDI	05/09-08/12	CAYB, CAYC	1598		0-N2061	TB [TE]
1.6 TDI	05/09-08/12	CAYB, CAYC	1598		0-N2200	TB [DG]
1.6, 1.6 E-Power	05/03-08/12	BGU, BSE, BSF, CCSA, CMXA, CCSA, CMXA	1595		0-N157	TB [TE]
1.9 TDI	05/03-05/10	BKC, BLS, BXE	1896		0-N1045	TB [TE]
1.9 TDI	05/03-05/10	BKC, BLS, BXE	1896		0-N1046	TB [DG]
2.0 FSI	05/03-06/08	AXW, BMB	1984		0-N1340	TB [TE]
2.0 FSI	05/03-06/08	AXW, BMB	1984		0-N1341	TB [DG]
2.0 FSI	05/03-06/08	BLR, BLX, BLY, BVY, BVZ	1984		0-N1346	TB [DG]
2.0 FSI	05/03-06/08	BLR, BLX, BLY, BVY, BVZ	1984		0-N2208	TB [TE]
2.0 FSI, S3 quattro	05/03-08/12	AXW, BLR, BLX, BLY, BMB, BVY, BVZ, BHZ, CDLA, BZC, CDLC	1984		0-N1316	TB [DG]
2.0 TDI	05/03-08/12	AZV, CBAA	1968		0-N1046	TB [DG]
2.0 TDI	05/03-08/12	CFFA	1968	→ 11/2010	0-N1046	TB [DG]

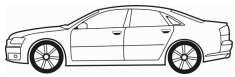

CM³



Art. Nr.



A3 (8P1)							
2.0 TDI	05/03-08/12	CFFA	1968			0-N131	TB [DG]
2.0 TDI	05/03-08/12	AZV	1968			0-N1335	TB [TE]
2.0 TDI	05/03-08/12	CBAA	1968			0-N1336	TB [DG]
2.0 TDI	05/03-08/12	AZV	1968	→ 01/2007		0-N1336	TB [DG]
2.0 TDI	05/03-08/12	AZV	1968	01/2007 →		0-N1575	TB [DG]
2.0 TDI	05/03-08/12	CBAA	1968			0-N1905	TB [BT]
2.0 TDI	05/03-08/12	CFFA	1968			0-N2025	TB [DG]
2.0 TDI	05/03-08/12	CFFA	1968			0-N2061	TB [TE]
2.0 TDI	05/03-08/12	CFFA	1968	12/2010 →		0-N2200	TB [DG]
2.0 TDI	06/06-06/08	BUY	1968			0-N1575	TB [DG]
2.0 TDI 16V	05/03-08/12	CFFB, CLJA	1968			0-N131	TB [DG]
2.0 TDI 16V	05/03-08/12	CFFB, CLJA	1968			0-N2025	TB [DG]
2.0 TDI 16V	05/03-08/12	CFFB, CLJA	1968			0-N2061	TB [TE]
2.0 TDI 16V	05/03-08/12	CFFB, CLJA	1968	12/2010 →		0-N2200	TB [DG]
2.0 TDI 16V quattro	08/04-08/12	CFFB	1968			0-N131	TB [DG]
2.0 TDI 16V quattro	08/04-08/12	CFFB	1968			0-N2025	TB [DG]
2.0 TDI 16V quattro	08/04-08/12	CFFB	1968			0-N2061	TB [TE]
2.0 TDI 16V quattro	08/04-08/12	CFFB	1968	12/2010 →		0-N2200	TB [DG]
2.0 TDI 16V, 2.0 TDI 16V quattro	05/03-08/12	BKD, CBAB	1968			0-N1046	TB [DG]
2.0 TDI 16V, 2.0 TDI 16V quattro	05/03-08/12	CFFB, CLJA	1968	→ 11/2010		0-N1046	TB [DG]
2.0 TDI 16V, 2.0 TDI 16V quattro	05/03-08/12	BKD	1968			0-N1335	TB [TE]
2.0 TDI 16V, 2.0 TDI 16V quattro	05/03-08/12	CBAB	1968			0-N1336	TB [DG]
2.0 TDI 16V, 2.0 TDI 16V quattro	05/03-08/12	BKD	1968	→ 01/2007		0-N1336	TB [DG]
2.0 TDI 16V, 2.0 TDI 16V quattro	05/03-08/12	BKD	1968	01/2007 →		0-N1575	TB [DG]
2.0 TDI 16V, 2.0 TDI 16V quattro	05/03-08/12	CBAB	1968			0-N1905	TB [BT]
2.0 TDI quattro	05/03-06/08	AZV	1968	→ 01/2007		0-N1336	TB [DG]
2.0 TDI quattro	05/03-06/08	AZV	1968	01/2007 →		0-N1575	TB [DG]
2.0 TDI, 2.0 TDI quattro	05/03-06/08	AZV, BMM, BUY	1968			0-N1046	TB [DG]
2.0 TDI, 2.0 TDI quattro	05/03-06/08	AZV, BUY	1968			0-N1335	TB [TE]
2.0 TDI, 2.0 TDI quattro	06/05-06/08	BMM	1968			0-N1045	TB [TE]
2.0 TDI, 2.0 TDI quattro	03/06-08/12	BMN, CBBB	1968			0-N1046	TB [DG]
2.0 TDI, 2.0 TDI quattro	03/06-08/12	CFGB	1968	→ 11/2010		0-N1046	TB [DG]
2.0 TDI, 2.0 TDI quattro	03/06-08/12	CBBB	1968			0-N1268	TB [DG]
2.0 TDI, 2.0 TDI quattro	03/06-08/12	CFGB	1968			0-N131	TB [DG]
2.0 TDI, 2.0 TDI quattro	03/06-08/12	BMN	1968			0-N1335	TB [TE]
2.0 TDI, 2.0 TDI quattro	03/06-08/12	CBBB	1968			0-N1336	TB [DG]
2.0 TDI, 2.0 TDI quattro	03/06-08/12	BMN	1968			0-N1575	TB [DG]
2.0 TDI, 2.0 TDI quattro	03/06-08/12	CBBB	1968			0-N1905	TB [BT]
2.0 TDI, 2.0 TDI quattro	03/06-08/12	CFGB	1968			0-N2025	TB [DG]
2.0 TDI, 2.0 TDI quattro	03/06-08/12	CFGB	1968			0-N2061	TB [TE]
2.0 TDI, 2.0 TDI quattro	03/06-08/12	CFGB	1968	12/2010 →		0-N2200	TB [DG]
2.0 TFSI, 2.0 TFSI quattro	09/04-08/12	AXX, BWA	1984			0-N1316	TB [DG]
2.0 TFSI, 2.0 TFSI quattro	09/04-08/12	AXX, BWA	1984			0-N1346	TB [DG]
2.0 TFSI, 2.0 TFSI quattro	09/04-08/12	AXX, BWA	1984			0-N1346	TB [TE]
S3 quattro	11/06-08/12	BHZ, CDLA, BZC, CDLC	1984			0-N1346	TB [DG]
S3 quattro	11/06-08/12	BHZ, CDLA, BZC, CDLC	1984			0-N2208	TB [TE]
1.2 TSI	04/10-08/12	CBZB	1197	☼		0-N1733	VB [BT] S
1.2 TSI	04/10-08/12	CBZB	1197	☼		0-N2121	VB [DG]
1.4 TFSI	09/07-08/12	CAXC, CMSA	1390	☼; ☼		0-N1454	VB [DG]
1.4 TFSI	09/07-08/12	CAXC, CMSA	1390	☼		0-N1525	VB [BT] S
1.4 TFSI	09/07-08/12	CAXC, CMSA	1390	☼		0-N1733	VB [BT] S
1.6 FSI	08/03-09/07	BAG, BLF, BLP	1598	☼; ☼		0-N1454	VB [DG]
1.6 FSI	08/03-09/07	BAG, BLF, BLP	1598	☼		0-N1525	VB [BT] S
1.6 FSI	08/03-09/07	BAG, BLF, BLP	1598	☼		0-N1733	VB [BT] S
1.6 TDI	05/09-08/12	CAYB, CAYC	1598			0-N1534	VB [BT] S
1.8 TFSI, 1.8 TFSI quattro	11/06-08/12	BYT, BZB, CDAA, CDAA	1798			0-N1832	VB [BT] S
1.9 TDI	05/03-05/10	BKC	1896	ch.→8P-5A200000, 8P-5B050000		0-N1530	VB [BT] S
1.9 TDI	05/03-05/10	BLS, BXE	1896			0-N1531	VB [BT] S
1.9 TDI	05/03-05/10	BKC	1896	ch.8P-6A000001, 8P-6B000001→		0-N1531	VB [BT] S
2.0 TDI	05/03-08/12	AZV	1968			0-N1530	VB [BT] S
2.0 TDI 16V, 2.0 TDI 16V quattro	05/03-08/12	BKD	1968			0-N1530	VB [BT] S
2.0 TDI, 2.0 TDI 16V quattro	05/03-08/12	CBAA	1968			0-N1534	VB [BT] S
2.0 TDI, 2.0 TDI 16V, 2.0 TDI quattro	05/03-08/12	CBAA, CFGB	1968			0-N1534	VB [BT] S
2.0 TDI, 2.0 TDI quattro	05/03-06/08	AZV, BUY	1968			0-N1530	VB [BT] S
2.0 TDI, 2.0 TDI quattro	06/05-06/08	BMM	1968	ch.→8P-5A200000, 8P-5B050000		0-N1530	VB [BT] S



CM³



Art. Nr.



A3 (8P1)

2.0 TDI, 2.0 TDI quattro	06/05-06/08	BMM	1968	ch.8P-6A000001, 8P-6B000001→	0-N1531	VB [BT]	S
2.0 TDI, 2.0 TDI quattro	03/06-08/12	BMN	1968		0-N1530	VB [BT]	S
2.0 TFSI, 2.0 TFSI quattro	09/04-08/12	AXX, BWA	1984		0-N1656	VB [BT]	S
3.2 V6 quattro	07/03-05/09	BDB, BMJ, BUB	3189		0-N1715	VB [DG]	
3.2 V6 quattro	07/03-05/09	BDB, BMJ, BUB	3189		0-N2209	VB [BT]	S
S3 quattro	11/06-08/12	BHZ, CDLA, BZC, CDLC	1984		0-N1656	VB [BT]	S

A3 Cabriolet (8P7)

1.6	09/08-05/10	BSE	1595	23x138; Baumuster: 8P7	SK-1109	BTK	
1.6	09/08-05/10	BSE	1595	23x138	SK-1109AQ1	BTKW	
1.6 TDI	05/09-05/13	CAYC	1598	25x160	SK-1695	BTK	
1.6 TDI	05/09-05/13	CAYC	1598	25x160	SK-1695AQ1	BTKW	
1.6 TDI	05/09-05/13	CAYC	1598	25x160	SK-1727AQ1	BTKW	
1.9 TDI	04/08-10/09	BLS	1896	30x120; mit Zubehör	SK-1372	BTK	
1.9 TDI	04/08-10/09	BLS	1896	30x120	SK-1372AQ1	BTKW	
2.0 TDI	04/08-05/13	CBAA	1968	30x160	SK-1694	BTK	
2.0 TDI	04/08-05/13	CBAB	1968	30x160	SK-1694	BTK	
2.0 TDI	04/08-05/13	CBAA	1968	30x160	SK-1694AQ1	BTKW	
2.0 TDI	04/08-05/13	CBAB	1968	30x160	SK-1694AQ1	BTKW	
2.0 TDI	04/08-05/13	CFFA	1968	25x160	SK-1695	BTK	
2.0 TDI	04/08-05/13	CFFB	1968	25x160	SK-1695	BTK	
2.0 TDI	04/08-05/13	CFFA	1968	25x160	SK-1695AQ1	BTKW	
2.0 TDI	04/08-05/13	CFFB	1968	25x160	SK-1695AQ1	BTKW	
2.0 TDI	04/08-05/13	CFFA, CFFB	1968	25x160; → 11/2010	SK-1727AQ1	BTKW	
1.6	09/08-05/10	BSE	1595		0-N157	TB [TE]	
1.6 TDI	05/09-05/13	CAYC	1598		0-N131	TB [DG]	
1.6 TDI	05/09-05/13	CAYC	1598		0-N2025	TB [DG]	
1.6 TDI	05/09-05/13	CAYC	1598		0-N2061	TB [TE]	
1.6 TDI	05/09-05/13	CAYC	1598		0-N2200	TB [DG]	
1.9 TDI	04/08-10/09	BLS	1896		0-N1045	TB [TE]	
1.9 TDI	04/08-10/09	BLS	1896		0-N1046	TB [DG]	
2.0 TDI	04/08-05/13	CBAA	1968		0-N1046	TB [DG]	
2.0 TDI	04/08-05/13	CBAB	1968		0-N1046	TB [DG]	
2.0 TDI	04/08-05/13	CFFA	1968	→ 11/2010	0-N1046	TB [DG]	
2.0 TDI	04/08-05/13	CFFB	1968	→ 11/2010	0-N1046	TB [DG]	
2.0 TDI	04/08-05/13	CBAA	1968		0-N1268	TB [DG]	
2.0 TDI	04/08-05/13	CBAB	1968		0-N1268	TB [DG]	
2.0 TDI	04/08-05/13	CFFA	1968		0-N131	TB [DG]	
2.0 TDI	04/08-05/13	CFFB	1968		0-N131	TB [DG]	
2.0 TDI	04/08-05/13	CBAA	1968		0-N1336	TB [DG]	
2.0 TDI	04/08-05/13	CBAB	1968		0-N1336	TB [DG]	
2.0 TDI	04/08-05/13	CBAA	1968		0-N1905	TB [BT]	
2.0 TDI	04/08-05/13	CBAB	1968		0-N1905	TB [BT]	
2.0 TDI	04/08-05/13	CFFA	1968		0-N2025	TB [DG]	
2.0 TDI	04/08-05/13	CFFB	1968		0-N2025	TB [DG]	
2.0 TDI	04/08-05/13	CFFA	1968		0-N2061	TB [TE]	
2.0 TDI	04/08-05/13	CFFB	1968		0-N2061	TB [TE]	
2.0 TDI	04/08-05/13	CFFA	1968	12/2010 →	0-N2200	TB [DG]	
2.0 TDI	04/08-05/13	CFFB	1968	12/2010 →	0-N2200	TB [DG]	
1.2 TFSI	03/10-05/13	CBZB	1197	⊛	0-N1733	VB [BT]	S
1.2 TFSI	03/10-05/13	CBZB	1197	⊛	0-N2121	VB [DG]	
1.4 TFSI	02/11-05/13	CAXC	1390	⊛	0-N1525	VB [BT]	S
1.4 TFSI	02/11-05/13	CAXC	1390	⊛	0-N1733	VB [BT]	S
1.6 TDI	05/09-05/13	CAYC	1598		0-N1534	VB [BT]	S
1.8 TFSI	04/08-05/13	BZB, CDAA	1798		0-N1832	VB [BT]	S
1.9 TDI	04/08-10/09	BLS	1896		0-N1531	VB [BT]	S
1.9 TDI	04/08-10/09	BLS	1896		0-N1534	VB [BT]	S
2.0 TDI	04/08-05/13	CBAA	1968		0-N1534	VB [BT]	S
2.0 TFSI	04/08-05/13	CAWB, CCZA	1984		0-N1832	VB [BT]	S

A3 Cabriolet (8V7)

1.4 TFSI	10/13-	CPTA, CXSB, CZCA, CZEA	1395		0-N2313	TB [TE]	
1.4 TFSI	10/13-	CPTA, CXSB, CZCA, CZEA	1395		0-N2381	TB [DG]	
1.6 TDI	02/14-	CRKB, CXXB	1598	⊛	0-N2288	VB [BT]	S
2.0 TDI, 2.0 TDI quattro	10/13-	CRLB, CRLC, CUNA	1968	⊛	0-N2288	VB [BT]	S

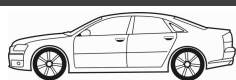

CM³



Art. Nr.



ohne Halter

A3 Limousine (8VS)							
1.2 TFSI	10/13-	CJZA, CYVB	1197			0-N2313	TB [TE]
1.2 TFSI	10/13-	CJZA, CYVB	1197			0-N2381	TB [DG]
1.4 TFSI	05/13-	CMBA, CXSA, CPTA, CXSB, CZCA, CZEA	1395			0-N2313	TB [TE]
1.4 TFSI	05/13-	CMBA, CXSA, CPTA, CXSB, CZCA, CZEA	1395			0-N2381	TB [DG]
1.6 TDI	09/13-	CLHA	1598			0-N131	TB [DG]
1.6 TDI	09/13-	CLHA	1598			0-N2314	TB [TE]
2.0 TDI	05/13-	CRBC, CRLB, CRUA, CRBD, CRLC, CRFA	1968			0-N131	TB [DG]
2.0 TDI	05/13-	CRBC, CRLB, CRUA, CRBD, CRLC, CRFA	1968			0-N2314	TB [TE]
1.6 TDI	09/13-	CLHA, CRKB, CXXB, DBKA	1598	✳		0-N2288	VB [BT] S
2.0 TDI, 2.0 TDI quattro	05/13-	CRBC, CRLB, CRBC, CRLB, CRUA, CRBD, CRLC, CRFA, CRFC, CUNA	1968	✳		0-N2288	VB [BT] S
A3 Sportback (8PA)							
1.6	09/04-03/13	BGU, BSE, BSF, CCSA	1595	23x138; Baumuster: 8PA		SK-1109	BTK
1.6 E-Power	01/11-03/13	CCSA, CMXA	1595	23x138; Baumuster: 8PA		SK-1109	BTK
1.6 TDI	05/09-03/13	CAYB	1598	25x160		SK-1695	BTK
1.6 TDI	05/09-03/13	CAYC	1598	25x160; → 08/2012		SK-1695	BTK
1.6 TDI	05/09-03/13	CAYB, CAYC	1598	25x160		SK-1695AQ1	BTKW
1.6 TDI	05/09-03/13	CAYC	1598	25x160		SK-1727AQ1	BTKW
1.6, 1.6 E-Power	09/04-03/13	BGU, BSE, BSF, CCSA, CMXA, CCSA, CMXA	1595	23x138		SK-1109AQ1	BTKW
1.9 TDI	09/04-05/10	BKC, BLS, BXE	1896	30x120; mit Zubehör		SK-1372	BTK
1.9 TDI	09/04-05/10	BKC, BLS, BXE	1896	30x120		SK-1372AQ1	BTKW
2.0 FSI	09/04-06/08	BMB	1984	23x145; mit Zubehör		SK-1599	BTK
2.0 FSI	09/04-06/08	AXW, BLR, BLX, BLY, BMB, BVY, BVZ	1984	23x148		SK-1724AQ2	BTKW
2.0 FSI, S3 quattro	09/04-03/13	AXW, BLR, BLX, BLY, BMB, BVY, BVZ, BHZ, CDLA, CDLC	1984	23x148		SK-1724	BTK
2.0 TDI	09/04-03/13	AZV	1968	30x141; → 12/2006; mit Zubehör		SK-1595	BTK
2.0 TDI	09/04-03/13	AZV	1968	30x141; → 12/2006; mit Zubehör		SK-1595AQ1	BTKW
2.0 TDI	09/04-03/13	AZV	1968	30x141; 01/2007 → 03/2013; mit Zubehör		SK-1668	BTK
2.0 TDI	09/04-03/13	AZV	1968	30x141; 01/2007 →		SK-1668AQ1	BTKW
2.0 TDI	09/04-03/13	CBAA	1968	30x160		SK-1694	BTK
2.0 TDI	09/04-03/13	CBAA	1968	30x160		SK-1694AQ1	BTKW
2.0 TDI	09/04-03/13	CFFA	1968	25x160; → 03/2013		SK-1695	BTK
2.0 TDI	09/04-03/13	CFFA	1968	25x160		SK-1695AQ1	BTKW
2.0 TDI	03/06-03/13	CFGB	1968	25x160		SK-1695	BTK
2.0 TDI	06/06-06/08	BUY	1968	30x141; mit Zubehör		SK-1668	BTK
2.0 TDI	06/06-06/08	BUY	1968	30x141		SK-1668AQ1	BTKW
2.0 TDI 16V	09/04-03/13	BKD	1968	30x141; → 01/2007; mit Zubehör		SK-1595	BTK
2.0 TDI 16V	09/04-03/13	BKD	1968	30x141; → 01/2007; mit Zubehör		SK-1595AQ1	BTKW
2.0 TDI 16V	09/04-03/13	BKD	1968	30x141; 01/2007 →; mit Zubehör		SK-1668	BTK
2.0 TDI 16V	09/04-03/13	CFFB, CLJA	1968	25x160		SK-1695	BTK
2.0 TDI 16V	09/04-03/13	CFFB, CLJA	1968	25x160		SK-1695AQ1	BTKW
2.0 TDI 16V quattro	11/05-03/13	BKD	1968	30x141; → 12/2006; mit Zubehör		SK-1595	BTK
2.0 TDI 16V quattro	11/05-03/13	BKD	1968	30x141; → 12/2006; mit Zubehör		SK-1595AQ1	BTKW
2.0 TDI 16V quattro	11/05-03/13	BKD	1968	30x141; 01/2007 → 03/2013; mit Zubehör		SK-1668	BTK
2.0 TDI 16V quattro	11/05-03/13	CFFB	1968	25x160; → 03/2013		SK-1695	BTK
2.0 TDI 16V quattro	11/05-03/13	CFFB	1968	25x160		SK-1695AQ1	BTKW
2.0 TDI 16V, 2.0 TDI 16V quattro	09/04-03/13	BKD	1968	30x141; 01/2007 →		SK-1668AQ1	BTKW
2.0 TDI 16V, 2.0 TDI 16V quattro	09/04-03/13	CBAB	1968	30x160		SK-1694	BTK
2.0 TDI 16V, 2.0 TDI 16V quattro	09/04-03/13	CBAB	1968	30x160		SK-1694AQ1	BTKW
2.0 TDI quattro	03/06-03/13	CFGB	1968	25x160; → 03/2013		SK-1695	BTK
2.0 TDI, 2.0 TDI 16V, 2.0 TDI 16V quattro	09/04-03/13	CFFA, CFFB	1968	25x160; → 11/2010		SK-1727AQ1	BTKW
2.0 TDI, 2.0 TDI quattro	06/05-06/08	BMM	1968	30x120; mit Zubehör		SK-1372	BTK
2.0 TDI, 2.0 TDI quattro	06/05-06/08	BMM	1968	30x120; ch.→8P-6-131500		SK-1372AQ2	BTKW
2.0 TDI, 2.0 TDI quattro	03/06-03/13	BMN	1968	30x141; mit Zubehör		SK-1668	BTK
2.0 TDI, 2.0 TDI quattro	03/06-03/13	BMN	1968	30x141		SK-1668AQ1	BTKW
2.0 TDI, 2.0 TDI quattro	03/06-03/13	CBBB	1968	30x160		SK-1694	BTK
2.0 TDI, 2.0 TDI quattro	03/06-03/13	CBBB	1968	30x160		SK-1694AQ2	BTKW
2.0 TDI, 2.0 TDI quattro	03/06-03/13	CFGB	1968	25x160		SK-1695AQ1	BTKW
2.0 TDI, 2.0 TDI quattro	03/06-03/13	CFGB	1968	25x160; → 11/2010		SK-1727AQ2	BTKW
2.0 TFSI, 2.0 TFSI quattro	09/04-03/13	AXX, BWA	1984	23x148		SK-1724	BTK
2.0 TFSI, 2.0 TFSI quattro	09/04-03/13	AXX, BWA	1984	23x148		SK-1724AQ1	BTKW
S3 quattro	06/08-03/13	BHZ, CDLA, CDLC	1984	23x148		SK-1724AQ1	BTKW
1.6 TDI	05/09-03/13	CAYB, CAYC	1598			0-N131	TB [DG]
1.6 TDI	05/09-03/13	CAYB, CAYC	1598			0-N2025	TB [DG]
1.6 TDI	05/09-03/13	CAYB, CAYC	1598			0-N2061	TB [TE]



CM³



Art. Nr.



A3 Sportback (8PA)

1.6 TDI	05/09-03/13	CAYB, CAYC	1598		0-N2200	TB [DG]	
1.6, 1.6 E-Power	09/04-03/13	BGU, BSE, BSF, CCSA, CMXA, CCSA, CMXA	1595		0-N157	TB [TE]	
1.9 TDI	09/04-05/10	BKC, BLS, BXE	1896		0-N1045	TB [TE]	
1.9 TDI	09/04-05/10	BKC, BLS, BXE	1896		0-N1046	TB [DG]	
2.0 FSI	09/04-06/08	BMB	1984		0-N1340	TB [TE]	
2.0 FSI	09/04-06/08	BMB	1984		0-N1341	TB [DG]	
2.0 FSI	09/04-06/08	BLR, BLX, BLY, BVY, BVZ	1984		0-N1346	TB [DG]	
2.0 FSI	09/04-06/08	BLR, BLX, BLY, BVY, BVZ	1984		0-N2208	TB [TE]	
2.0 FSI, S3 quattro	09/04-03/13	AXW, BLR, BLX, BLY, BMB, BVY, BVZ, BHZ, CDLA, CDLC	1984		0-N1316	TB [DG]	
2.0 TDI	09/04-03/13	AZV, CBAA	1968		0-N1046	TB [DG]	
2.0 TDI	09/04-03/13	CFFA	1968	→ 11/2010	0-N1046	TB [DG]	
2.0 TDI	09/04-03/13	CBAA	1968		0-N1268	TB [DG]	
2.0 TDI	09/04-03/13	CFFA	1968		0-N131	TB [DG]	
2.0 TDI	09/04-03/13	AZV	1968		0-N1335	TB [TE]	
2.0 TDI	09/04-03/13	CBAA	1968		0-N1336	TB [DG]	
2.0 TDI	09/04-03/13	AZV	1968	→ 01/2007	0-N1336	TB [DG]	
2.0 TDI	09/04-03/13	AZV	1968	01/2007 →	0-N1575	TB [DG]	
2.0 TDI	09/04-03/13	CBAA	1968		0-N1905	TB [BT]	
2.0 TDI	09/04-03/13	CFFA	1968		0-N2025	TB [DG]	
2.0 TDI	09/04-03/13	CFFA	1968		0-N2061	TB [TE]	
2.0 TDI	09/04-03/13	CFFA	1968	12/2010 →	0-N2200	TB [DG]	
2.0 TDI	06/06-06/08	BUY	1968		0-N1335	TB [TE]	
2.0 TDI	06/06-06/08	BUY	1968		0-N1575	TB [DG]	
2.0 TDI 16V	09/04-03/13	CFFB, CLJA	1968		0-N131	TB [DG]	
2.0 TDI 16V	09/04-03/13	CFFB, CLJA	1968		0-N2025	TB [DG]	
2.0 TDI 16V	09/04-03/13	CFFB, CLJA	1968		0-N2061	TB [TE]	
2.0 TDI 16V	09/04-03/13	CFFB, CLJA	1968	12/2010 →	0-N2200	TB [DG]	
2.0 TDI 16V quattro	11/05-03/13	CFFB	1968		0-N131	TB [DG]	
2.0 TDI 16V quattro	11/05-03/13	CFFB	1968		0-N2025	TB [DG]	
2.0 TDI 16V quattro	11/05-03/13	CFFB	1968		0-N2061	TB [TE]	
2.0 TDI 16V quattro	11/05-03/13	CFFB	1968	12/2010 →	0-N2200	TB [DG]	
2.0 TDI 16V, 2.0 TDI 16V quattro	09/04-03/13	BKD, CBAB	1968		0-N1046	TB [DG]	
2.0 TDI 16V, 2.0 TDI 16V quattro	09/04-03/13	CFFB, CLJA	1968	→ 11/2010	0-N1046	TB [DG]	
2.0 TDI 16V, 2.0 TDI 16V quattro	09/04-03/13	BKD	1968		0-N1335	TB [TE]	
2.0 TDI 16V, 2.0 TDI 16V quattro	09/04-03/13	CBAB	1968		0-N1336	TB [DG]	
2.0 TDI 16V, 2.0 TDI 16V quattro	09/04-03/13	BKD	1968	→ 01/2007	0-N1336	TB [DG]	
2.0 TDI 16V, 2.0 TDI 16V quattro	09/04-03/13	BKD	1968	01/2007 →	0-N1575	TB [DG]	
2.0 TDI 16V, 2.0 TDI 16V quattro	09/04-03/13	CBAB	1968		0-N1905	TB [BT]	
2.0 TDI, 2.0 TDI quattro	06/05-06/08	BMM	1968		0-N1045	TB [TE]	
2.0 TDI, 2.0 TDI quattro	06/05-06/08	BMM, BUY	1968		0-N1046	TB [DG]	
2.0 TDI, 2.0 TDI quattro	03/06-03/13	BMN, CBBB	1968		0-N1046	TB [DG]	
2.0 TDI, 2.0 TDI quattro	03/06-03/13	CFGB	1968	→ 11/2010	0-N1046	TB [DG]	
2.0 TDI, 2.0 TDI quattro	03/06-03/13	CBBB	1968		0-N1268	TB [DG]	
2.0 TDI, 2.0 TDI quattro	03/06-03/13	CFGB	1968		0-N131	TB [DG]	
2.0 TDI, 2.0 TDI quattro	03/06-03/13	BMN	1968		0-N1335	TB [TE]	
2.0 TDI, 2.0 TDI quattro	03/06-03/13	CBBB	1968		0-N1336	TB [DG]	
2.0 TDI, 2.0 TDI quattro	03/06-03/13	BMN	1968		0-N1575	TB [DG]	
2.0 TDI, 2.0 TDI quattro	03/06-03/13	CBBB	1968		0-N1905	TB [BT]	
2.0 TDI, 2.0 TDI quattro	03/06-03/13	CFGB	1968		0-N2025	TB [DG]	
2.0 TDI, 2.0 TDI quattro	03/06-03/13	CFGB	1968		0-N2061	TB [TE]	
2.0 TDI, 2.0 TDI quattro	03/06-03/13	CFGB	1968	12/2010 →	0-N2200	TB [DG]	
2.0 TFSI	09/04-03/13	AXX, BPY, BWA	1984		0-N1316	TB [DG]	
2.0 TFSI	09/04-03/13	AXX, BPY, BWA	1984		0-N1346	TB [DG]	
2.0 TFSI	09/04-03/13	AXX, BWA, BPY	1984		0-N2208	TB [TE]	
2.0 TFSI quattro	09/04-03/13	AXX, BWA	1984		0-N1316	TB [DG]	
2.0 TFSI quattro	09/04-03/13	AXX, BWA	1984		0-N1346	TB [DG]	
2.0 TFSI quattro	09/04-03/13	BWA, AXX, BPY	1984		0-N2208	TB [TE]	
S3 quattro	06/08-03/13	BHZ, CDLA, CDLC	1984		0-N1346	TB [DG]	
S3 quattro	06/08-03/13	BHZ, CDLA, CDLC	1984		0-N2208	TB [TE]	
1.2 TSI	04/10-03/13	CBZB	1197	⚠	0-N1733	VB [BT]	S
1.2 TSI	04/10-03/13	CBZB	1197	⚠	0-N2121	VB [DG]	
1.4 TFSI	09/07-03/13	CAXC, CMSA	1390	⚠; ⚠	0-N1454	VB [DG]	
1.4 TFSI	09/07-03/13	CAXC, CMSA	1390	⚠	0-N1525	VB [BT]	S
1.4 TFSI	09/07-03/13	CAXC, CMSA	1390	⚠	0-N1733	VB [BT]	S

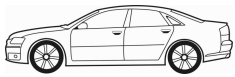

CM³



Art. Nr.



A3 Sportback (8PA)

1.6 FSI	09/04-09/07	BLF, BLP	1598	☼; ☼	0-N1454	VB [DG]	
1.6 FSI	09/04-09/07	BLF, BLP	1598	☼	0-N1525	VB [BT]	S
1.6 FSI	09/04-09/07	BLF, BLP	1598	☼	0-N1733	VB [BT]	S
1.6 TDI	05/09-03/13	CAYB, CAYC	1598		0-N1534	VB [BT]	S
1.8 TFSI, 1.8 TFSI quattro	11/06-03/13	BYT, BZB, CDAA, CDAA	1798		0-N1832	VB [BT]	S
1.9 TDI	09/04-05/10	BKC	1896	ch.→8P-5A200000, 8P-5B050000	0-N1530	VB [BT]	S
1.9 TDI	09/04-05/10	BLS, BXE	1896		0-N1531	VB [BT]	S
1.9 TDI	09/04-05/10	BKC	1896	ch.8P-6A000001, 8P-6B000001→	0-N1531	VB [BT]	S
2.0 TDI	06/06-06/08	BUY	1968		0-N1530	VB [BT]	S
2.0 TDI 16V, 2.0 TDI 16V quattro	09/04-03/13	BKD	1968		0-N1530	VB [BT]	S
2.0 TDI, 2.0 TDI 16V quattro	09/04-03/13	CBAA	1968		0-N1534	VB [BT]	S
2.0 TDI, 2.0 TDI 16V, 2.0 TDI quattro	09/04-03/13	CBAA, CFGB	1968		0-N1534	VB [BT]	S
2.0 TDI, 2.0 TDI quattro	06/05-06/08	BMM	1968	ch.→8P-5A200000, 8P-5B050000	0-N1530	VB [BT]	S
2.0 TDI, 2.0 TDI quattro	06/05-06/08	BMM	1968	ch.8P-6A000001, 8P-6B000001→	0-N1531	VB [BT]	S
2.0 TDI, 2.0 TDI quattro	03/06-03/13	BMN	1968		0-N1530	VB [BT]	S
2.0 TFSI	09/04-03/13	AXX, BPY, BWA	1984		0-N1656	VB [BT]	S
2.0 TFSI	09/04-03/13	CAWB, CBFA, CCZA	1984		0-N1832	VB [BT]	S
2.0 TFSI quattro	09/04-03/13	AXX, BWA	1984		0-N1656	VB [BT]	S
3.2 V6 quattro	09/04-05/09	BMJ, BUB	3189		0-N1715	VB [DG]	
3.2 V6 quattro	09/04-05/09	BMJ, BUB	3189		0-N2209	VB [BT]	S
RS3 quattro	01/11-12/12	CEPA	2480		0-N1892	VB [BT]	S
RS3 quattro	01/11-12/12	CEPA	2480		0-N1893	VB [BT]	S
S3 quattro	06/08-03/13	BHZ, CDLA, CDLC	1984		0-N1656	VB [BT]	S

A3 (8V1)

1.2 TFSI	02/13-	CJZA, CYVB	1197		0-N2313	TB [TE]	
1.2 TFSI	02/13-	CJZA, CYVB	1197		0-N2381	TB [DG]	
1.4 TFSI	04/12-	CMBA, CXSA, CPTA, CXSB, CZCA, CZEA	1395		0-N2313	TB [TE]	
1.4 TFSI	04/12-	CMBA, CXSA, CPTA, CXSB, CZCA, CZEA	1395		0-N2381	TB [DG]	
1.6 TDI	10/12-	CLHA	1598		0-N131	TB [DG]	
1.6 TDI	10/12-	CLHA	1598		0-N2314	TB [TE]	
2.0 TDI, 2.0 TDI quattro	04/12-	CRBC, CRBC, CRLB, CRUA, CRBD, CRLC, CRFA, CRFC, CUNA	1968		0-N131	TB [DG]	
2.0 TDI, 2.0 TDI quattro	04/12-	CRBC, CRBC, CRLB, CRUA, CRBD, CRLC, CRFA, CRFC, CUNA	1968		0-N2314	TB [TE]	
1.6 TDI	10/12-	CLHA, CRKB, CXXB, DBKA	1598	☼	0-N2288	VB [BT]	S
1.8 TFSI	04/12-	CJSA	1798		0-N1832	VB [BT]	S
2.0 TDI, 2.0 TDI quattro	04/12-	CRBC, CRBC, CRLB, CRUA, CRBD, CRLC, CRFA, CRFC, CUNA	1968	☼	0-N2288	VB [BT]	S

A3 Sportback (8VA)

1.2 TFSI	05/13-	CJZA, CYVB	1197		0-N2313	TB [TE]	
1.2 TFSI	05/13-	CJZA, CYVB	1197		0-N2381	TB [DG]	
1.4 TFSI, 1.4 TFSI e-tron	09/12-	CMBA, CXSA, CPTA, CPWA, CUKB, CXUA, CXSB, CZCA, CZEA	1395		0-N2313	TB [TE]	
1.4 TFSI, 1.4 TFSI e-tron	09/12-	CMBA, CXSA, CPTA, CPWA, CUKB, CXUA, CXSB, CZCA, CZEA	1395		0-N2381	TB [DG]	
1.6 TDI	10/12-	CLHA	1598		0-N131	TB [DG]	
1.6 TDI	10/12-	CLHA	1598		0-N2314	TB [TE]	
2.0 TDI, 2.0 TDI quattro	09/12-	CRBC, CRLB, CRBC, CRLB, CRUA, CRBD, CRLC, CRFC, CUNA	1968		0-N131	TB [DG]	
2.0 TDI, 2.0 TDI quattro	09/12-	CRBC, CRLB, CRBC, CRLB, CRUA, CRBD, CRLC, CRFC, CUNA	1968		0-N2314	TB [TE]	
1.6 TDI	10/12-	CLHA, CRKB, CXXB, DBKA	1598	☼	0-N2288	VB [BT]	S
2.0 TDI, 2.0 TDI quattro	09/12-	CRBC, CRLB, CRBC, CRLB, CRUA, CRBD, CRLC, CRFA, CRFC, CUNA	1968	☼	0-N2288	VB [BT]	S

A4 (8D2, B5)

1.6	11/94-10/00	ADP	1595	18x121; mit Zubehör	SK-1101	BTK	
1.6	11/94-10/00	AHL, ANA, ARM	1595	23x138	SK-1109	BTK	
1.6	11/94-10/00	AHL, ANA, ARM	1595	23x138	SK-1109AQ1	BTKW	
1.6	07/00-11/00	ALZ	1595	23x138; Baumuster: 8D2, B5	SK-1109	BTK	
1.6	07/00-11/00	ALZ	1595	23x138	SK-1109AQ1	BTKW	
1.8	01/95-11/00	ADR, APT, ARG, AVV	1781	25x153; ch.8D-T-155001→; mit Zubehör; Baumuster: 8D2, B5	SK-1346	BTK	
1.8	01/95-11/00	ARG, AVV	1781	25x153; ch.8D-T-155001→; mit Zubehör; Baumuster: 8D2, B5	SK-1346	BTK	
1.8	01/95-11/00	ADR	1781	25x153; ch.→8D-T-155000; ohne Spanndämpfer, Spannrolle	SK-1641	BTK	



CM³



Art. Nr.



A4 (8D2, B5)

1.8	04/95-11/00	AFY	1781	25x153; ch.→8D-T-155000; 07/1995 →; mit Spanndämpfer, Spannrolle	SK-1121	BTK
1.8	04/95-11/00	AFY	1781	25x153; ch.8D-T-155001→; mit Zubehör; Baumuster: 8D2, B5	SK-1346	BTK
1.8	04/95-11/00	AFY	1781	25x153; ch.→8D-T-155000; 07/1995 →; ohne Spanndämpfer, Spannrolle	SK-1641	BTK
1.8	05/00-09/00	AMB	1781	23x150; mit Zubehör	SK-1726	BTK
1.8 quattro	01/95-11/00	ADR, APT, ARG	1781	25x153; ch.8D-T-155001→; mit Zubehör; Baumuster: 8D2, B5	SK-1346	BTK
1.8 quattro, 1.8 T, 1.8 T quattro	07/95-11/00	AFY, AJL	1781	25x153; mit Zubehör; Baumuster: 8D2, B5	SK-1346	BTK
1.8 quattro, 1.8 T, 1.8 T quattro	07/95-11/00	AFY, AJL	1781	25x153; mit Spanndämpfer, Spannrolle; mit Zubehör	SK-1638	BTK
1.8 T	01/95-11/00	AEB	1781	25x153; ch.→8D-T-155009	SK-1121	BTK
1.8 T	01/95-11/00	AEB, ANB, APU	1781	25x153; 10/1995 →; mit Zubehör	SK-1346	BTK
1.8 T	01/95-11/00	AEB, ANB, APU	1781	25x153; 10/1995 →; mit Spanndämpfer, Spannrolle; mit Zubehör	SK-1638	BTK
1.8 T	01/95-11/00	AWT	1781	23x150; ch.8D-1-042385→; 10/1995 →; ohne Spanndämpfer, Spannrolle; mit Zubehör	SK-1640	BTK
1.8 T	01/95-11/00	AWT	1781	23x150; ch.8D-1-042385→; 10/1995 →; ohne Spanndämpfer, Spannrolle; mit Zubehör	SK-1640AQ1	BTKW
1.8 T	01/95-11/00	AWT	1781	23x150; ch.→8D-1-042384; 10/1995 →	SK-1660	BTK
1.8 T	01/95-11/00	AWT	1781	23x150; ch.→8D-1-042384; 10/1995 →	SK-1660AQ1	BTKW
1.8 T	01/95-11/00	AWT	1781	23x150; ch.→8D-1-042384; 10/1995 →	SK-1710	BTK
1.8 T quattro	01/95-11/00	AEB, ANB, APU, ARK	1781	25x153; ch.8D-T-155001→; mit Zubehör; Baumuster: 8D2, B5	SK-1346	BTK
1.8 T quattro	01/95-11/00	AWT	1781	23x150; ch.→8D-1-042384	SK-1660	BTK
1.8 T, 1.8 T quattro	01/95-11/00	AEB	1781	25x153; → 07/1999; ohne Spanndämpfer, Spannrolle; Baumuster: 8D2, B5	SK-1641	BTK
1.8 T, 1.8 T quattro	01/95-11/00	AWT	1781	23x150; ch.8D-1-042 385→; mit Zubehör	SK-1726	BTK
1.8 T, 1.8 T quattro	01/95-11/00	AWT	1781	23x150; ch.8D-1-042 385→; mit Zubehör	SK-1726AQ1	BTKW
1.8, 1.8 quattro	01/95-11/00	ADR	1781	25x153; → 07/1999; ohne Spanndämpfer, Spannrolle; Baumuster: 8D2, B5	SK-1641	BTK
1.8, 1.8 quattro, 1.8 T quattro	01/95-11/00	ADR, ADR, APT, ARG, ADR, APT, ARG, AVV, AEB, ANB, APU, ARK, AWT	1781	25x153; ch.→8D-T-155000; mit Spanndämpfer, Spannrolle	SK-1121	BTK
1.8, 1.8 quattro, 1.8 T quattro	01/95-11/00	ADR, ADR, APT, ARG, ADR, APT, ARG, AVV, AEB, ANB, APU, ARK, AWT, AFY	1781	25x153; ch.8D-T-155001→; mit Spanndämpfer, Spannrolle; mit Zubehör	SK-1638	BTK
1.9 TDI	01/95-11/00	1Z, AHU	1896	25x137; mit Zubehör	SK-1098	BTK
1.9 TDI	01/95-11/00	1Z, AHH, AHU	1896	25x137; ch.→8D1200000; 04/1997 →; mit Zubehör	SK-1593	BTK
1.9 TDI	10/95-11/00	AFN, AVG	1896	25x137; 02/1996 →; mit Zubehör	SK-1098	BTK
1.9 TDI	03/00-11/00	AJM	1896	30x120; mit Zubehör; Baumuster: 8D2, B5	SK-1582	BTK
1.9 TDI	03/00-11/00	AJM	1896	30x120; mit Spanndämpfer, Spannrolle; mit Zubehör; Baumuster: 8D2, B5	SK-1583	BTK
1.9 TDI quattro	03/00-11/00	ATJ	1896	30x120; mit Zubehör; Baumuster: 8D2, B5	SK-1582	BTK
1.9 TDI quattro	03/00-11/00	ATJ	1896	30x120; mit Spanndämpfer, Spannrolle; mit Zubehör; Baumuster: 8D2, B5	SK-1583	BTK
1.9 TDI, 1.9 TDI quattro	12/95-11/00	AFF, AFN, AVG	1896	25x137; mit Zubehör	SK-1098	BTK
1.9 TDI, 1.9 TDI quattro	03/00-11/00	AJM, AJM, ATJ	1896	30x120; ohne Spanndämpfer, Spannrolle; mit Zubehör	SK-1582AQ1	BTKW
1.9 TDI, 1.9 TDI quattro	03/00-11/00	AJM, AJM, ATJ	1896	30x120; mit Spanndämpfer, Spannrolle; mit Zubehör	SK-1583AQ1	BTKW
2.4	07/95-07/97	AFM	2393	25x239; mit Zubehör	SK-1376	BTK
2.4	07/95-07/97	AFM	2393	25x239	SK-1376AQ1	BTKW
2.4	08/97-11/00	AJG, AMM, APZ	2393	30x253; mit Spanndämpfer, Spannrolle; mit Zubehör; Baumuster: 8D2, B5	SK-1377	BTK
2.4	08/97-11/00	AJG, AMM, APZ	2393	30x253; ch.→8D-X-315000; mit Zubehör	SK-1383AQ1	BTKW
2.4 quattro	08/97-11/00	APZ	2393	30x253; ch.→8D-X-315000; mit Zubehör	SK-1383AQ1	BTKW
2.4, 2.4 quattro	07/95-11/00	AFM, APZ	2393	30x253; mit Spanndämpfer, Spannrolle; mit Zubehör; Baumuster: 8D2, B5	SK-1377	BTK
2.4, 2.4 quattro	03/97-11/00	AGA, ALF, APS, ARJ	2393	30x253; 08/1997 →; mit Spanndämpfer, Spannrolle; mit Zubehör; Baumuster: 8D2, B5	SK-1377	BTK
2.4, 2.4 quattro	03/97-11/00	AGA, ALF, AML, APS, ARJ, AJG, AMM, APZ, APZ	2393	30x253; mit Spanndämpfer, Spannrolle; mit Zubehör	SK-1377AQ1	BTKW
2.4, 2.4 quattro	03/97-11/00	AGA, ALF, AML, APS, ARJ	2393	30x253; 08/1997 →; ohne Spanndämpfer, Spannrolle; mit Zubehör	SK-1383	BTK
2.4, 2.4 quattro	03/97-11/00	AGA, ALF, AML, APS, ARJ	2393	30x253; ch.→8D-X-315000; mit Zubehör	SK-1383AQ1	BTKW
2.4, 2.4 quattro	08/97-11/00	AJG, AMM, APZ, APZ	2393	30x253; ohne Spanndämpfer, Spannrolle; mit Zubehör	SK-1383	BTK



CM³



Art. Nr.



A4 (8D2, B5)							
2.5 TDI, 2.5 TDI quattro	09/97-11/00	AFB, AKN	2496	32x207; 24x87; ohne Spanndämpfer, Spannrolle; mit Zubehör; Baumuster: 8D2, B5	SK-1375	BTK	
2.5 TDI, 2.5 TDI quattro	09/97-11/00	AFB, AKN	2496	30x207; 24x87; mit Spanndämpfer, Spannrolle; mit Zubehör	SK-1621AQ1	BTKW	
2.5 TDI, 2.5 TDI quattro	09/97-11/00	AFB, AKN	2496	32x207; 24x87; mit Spanndämpfer, Spannrolle; mit Zubehör	SK-1633	BTK	
2.5 TDI, 2.5 TDI quattro	09/97-11/00	AKN	2496	32x207; 24x87; mit Spanndämpfer, Spannrolle; mit Zubehör	SK-1633AQ1	BTKW	
2.6, 2.6 quattro	01/95-11/00	ABC, ACZ	2598	25x239; mit Zubehör	SK-1376	BTK	
2.6, 2.6 quattro	01/95-11/00	ABC, ACZ	2598	25x239	SK-1376AQ1	BTKW	
2.7 Bi Turbo quattro	08/98-12/98	APB	2671	30x253; mit Spanndämpfer, Spannrolle; mit Zubehör	SK-1377	BTK	
2.8	10/96-11/00	ALG, AMX, APR, AQD	2771	30x253; ch.8D-V-205001→; 8D-X-315000; mit Zubehör	SK-1383AQ1	BTKW	
2.8 quattro	10/96-08/01	AGA, ALF, ARJ	2771	30x253; ch.→8D-X-315000; mit Zubehör	SK-1383AQ1	BTKW	
2.8, 2.8 24V, 2.8 quattro	09/95-08/01	AAH, ACK, AHA, ALG, AMX, APR, AQD, AHA	2771	30x253; ch.8D-V-205001→; mit Spanndämpfer, Spannrolle; mit Zubehör	SK-1377	BTK	
2.8, 2.8 24V, 2.8 quattro	10/96-08/01	ACK, AHA, ALG, AMX, APR, AQD, AHA	2771	30x253; ch.8D-V-205001→; mit Spanndämpfer, Spannrolle; mit Zubehör	SK-1377AQ1	BTKW	
2.8, 2.8 24V, 2.8 quattro	10/96-08/01	ACK, AHA, ALG, AMX, APR, AQD, AHA	2771	30x253; ohne Spanndämpfer, Spannrolle; mit Zubehör	SK-1383	BTK	
2.8, 2.8 24V, 2.8 quattro	10/96-08/01	ACK, AHA, ALG, AMX, APR, AQD, AHA	2771	30x253; ch.→8D-V-205000; mit Spanndämpfer, Spannrolle; mit Zubehör	SK-1636	BTK	
2.8, 2.8 quattro	01/95-07/97	AAH	2771	25x239; mit Zubehör	SK-1376	BTK	
2.8, 2.8 quattro	01/95-07/97	AAH	2771	25x239	SK-1376AQ1	BTKW	
S4 quattro	09/97-09/01	AGB, AZB	2671	30x253; mit Spanndämpfer, Spannrolle; mit Zubehör; Baumuster: 8D2, B5	SK-1377	BTK	
S4 quattro	09/97-09/01	AGB, AZB	2671	30x253; ohne Spanndämpfer, Spannrolle; mit Zubehör	SK-1383	BTK	
1.6	11/94-10/00	ADP	1595		0-N132	TB [TE]	
1.6	11/94-10/00	AHL, ANA, ARM	1595		0-N157	TB [TE]	
1.6	11/94-11/00	ADP, AHL, ANA, ARM, ALZ	1595		0-N1822	TB [BT]	S
1.6	07/00-11/00	ALZ	1595		0-N157	TB [TE]	
1.8	01/95-11/00	APT, ARG, AVV	1781		0-N1236	TB [TE]	
1.8	04/95-11/00	AFY	1781	ch.→T-155000; 07/1995 → 12/1995	0-N130	TB [TE]	S
1.8	05/00-09/00	AMB	1781		0-N1316	TB [DG]	
1.8 quattro	01/95-11/00	APT, ARG	1781		0-N1236	TB [TE]	
1.8 T	01/95-11/00	AWT	1781	ch.→8D-1-042384; 10/1995 →	0-N1042	TB [TE]	
1.8 T	01/95-11/00	AWT	1781	ch.8D-1-042385→; 10/1995 →	0-N1050	TB [TE]	
1.8 T	01/95-11/00	AEB, ANB, APU, ARK, AWT	1781	→ 07/1998	0-N130	TB [TE]	S
1.8 T quattro	01/95-11/00	AWT	1781	ch.→8D-1-042384	0-N1042	TB [TE]	
1.8 T, 1.8 T quattro	01/95-11/00	AWT	1781	ch.8D-1-042385→; 01/2000 →	0-N1051	TB [BT]	S
1.8 T, 1.8 T quattro	01/95-11/00	ARK	1781		0-N1236	TB [TE]	
1.8 T, 1.8 T quattro	01/95-11/00	AEB	1781	ch.8D-T-155010→	0-N1236	TB [TE]	
1.8 T, 1.8 T quattro	01/95-11/00	ANB, APU	1781	:020001→	0-N1236	TB [TE]	
1.8 T, 1.8 T quattro	01/95-11/00	AWT	1781	ch.→8D-1-042384	0-N1237	TB [BT]	
1.8 T, 1.8 T quattro	01/95-11/00	ARK	1781		0-N1276	TB [BT]	
1.8 T, 1.8 T quattro	01/95-11/00	AEB	1781	ch.8D-T-155010→	0-N1276	TB [BT]	
1.8 T, 1.8 T quattro	01/95-11/00	ANB, APU	1781	:020001→	0-N1276	TB [BT]	
1.8 T, 1.8 T quattro	01/95-11/00	AEB, ANB, ARK	1781		0-N131	TB [DG]	
1.8 T, 1.8 T quattro	01/95-11/00	AWT	1781		0-N1316	TB [DG]	
1.8 T, 1.8 T quattro	01/95-11/00	AWT	1781	ch.8D-1-042385→; 01/2000 →;	0-N2195	TB [TE]	
1.8 T, 1.8 T quattro	01/95-11/00	AWT	1781	ch.8D-1-042385→; 01/2000 →	0-N2234	TB [DG]	
1.8, 1.8 quattro	01/95-11/00	ADR	1781	ch.8D-T-155010→	0-N1236	TB [TE]	
1.8, 1.8 quattro, 1.8 T	01/95-11/00	ADR, AEB, ANB, APU, ARK, AWT, AFY	1781	ch.→T-155000; → 12/1995	0-N130	TB [TE]	S
1.8, 1.8 quattro, 1.8 T quattro	01/95-11/00	ADR, APT, ARG, ADR, APT, ARG, AVV, AEB, ANB, APU, ARK, AWT	1781	ch.→8D-T-155000	0-N130	TB [TE]	S
1.8, 1.8 quattro, 1.8 T, 1.8 T quattro	01/95-11/00	ADR, APT, ARG, ADR, APT, ARG, AVV, AFY, AJL	1781		0-N1276	TB [BT]	
1.8, 1.8 quattro, 1.8 T, 1.8 T quattro	01/95-11/00	ADR, APT, ARG, ADR, APT, ARG, AVV, AFY, AJL	1781		0-N131	TB [DG]	
1.8, 1.8 quattro, 1.8 T, 1.8 T quattro	01/95-11/00	ADR, APT, ARG, ADR, APT, ARG, AVV, AEB, ANB, APU, ARK, AWT, AFY, AJL	1781		0-N1822	TB [BT]	S
1.8, 1.8 quattro, 1.8 T, 1.8 T quattro	04/95-11/00	AFY, AJL	1781		0-N1236	TB [TE]	
1.9 TDI	01/95-11/00	1Z, AHU	1896		0-N104	TB [TE]	
1.9 TDI	01/95-11/00	AHH	1896		0-N1332	TB [TE]	
1.9 TDI, 1.9 TDI quattro	01/95-11/00	1Z, AHH, AHU, AFF, AFN, AVG	1896		0-N128	TB [DG]	
1.9 TDI, 1.9 TDI quattro	10/95-11/00	AFF, AFN, AVG	1896		0-N104	TB [TE]	

CM³

Art. Nr.



ohne Halter

A4 (8D2, B5)

1.9 TDI, 1.9 TDI quattro	03/00-11/00	AJM, AJM, ATJ	1896		0-N1048	TB [TE]	
1.9 TDI, 1.9 TDI quattro	03/00-11/00	AJM, AJM, ATJ	1896		0-N1268	TB [DG]	
1.9 TDI, 1.9 TDI quattro	03/00-11/00	AJM, AJM, ATJ	1896		0-N1274	TB [BT]	
2.4	07/95-07/97	AFM	2393		0-N160	TB [TE]	
2.4	07/95-07/97	AFM	2393		0-N2000	TB [DG]	
2.4, 2.4 quattro	03/97-11/00	AGA, ALF, AML, APS, ARJ, AJG, AMM, APZ, APZ	2393		0-N1238	TB [TE]	
2.4, 2.4 quattro	03/97-11/00	AGA, ALF, AML, APS, ARJ, AJG, AMM, APZ, APZ	2393		0-N1275	TB [BT]	
2.4, 2.4 quattro	03/97-11/00	AGA, ALF, AML, APS, ARJ, AJG, AMM, APZ, APZ	2393		0-N1371	TB [TE]	
2.4, 2.4 quattro	03/97-11/00	AGA, ALF, AML, APS, ARJ, AJG, AMM, APZ, APZ	2393		0-N2001	TB [DG]	
2.5 TDI, 2.5 TDI quattro	09/97-11/00	AFB, AKN	2496		0-N1266	TB [TE]	
2.5 TDI, 2.5 TDI quattro	09/97-11/00	AFB, AKN	2496		0-N1363	TB [TE]	
2.5 TDI, 2.5 TDI quattro	09/97-11/00	AFB, AKN	2496		0-N1364	TB [BT]	
2.5 TDI, 2.5 TDI quattro	09/97-11/00	AFB, AKN	2496		0-N168	TB [DG]	
2.5 TDI, 2.5 TDI quattro	09/97-11/00	AFB, AKN	2496		0-N201	TB [BT]	
2.6, 2.6 quattro	01/95-11/00	ABC, ACZ	2598		0-N160	TB [TE]	
2.6, 2.6 quattro	01/95-11/00	ABC, ACZ	2598		0-N2000	TB [DG]	
2.7 Turbo quattro, S4 quattro	09/97-09/01	AGB, AZB, AJK	2671		0-N1238	TB [TE]	
2.7 Turbo quattro, S4 quattro	09/97-09/01	AGB, AZB, AJK	2671		0-N1275	TB [BT]	
2.7 Turbo quattro, S4 quattro	09/97-09/01	AGB, AZB, AJK	2671		0-N1371	TB [TE]	
2.7 Turbo quattro, S4 quattro	09/97-09/01	AGB, AZB, AJK	2671		0-N2001	TB [DG]	
2.8 24V	10/96-07/99	AHA	2771	ch.8D-V-205001→	0-N1275	TB [BT]	
2.8, 2.8 24V, 2.8 quattro	10/96-08/01	ACK, AHA, ALG, AMX, APR, AQD, AHA	2771		0-N1238	TB [TE]	
2.8, 2.8 24V, 2.8 quattro	10/96-08/01	ACK, AHA, ALG, AMX, APR, AQD, AHA	2771		0-N1371	TB [TE]	
2.8, 2.8 24V, 2.8 quattro	10/96-08/01	ACK, AHA, ALG, AMX, APR, AQD, AHA	2771		0-N2001	TB [DG]	
2.8, 2.8 quattro	01/95-07/97	AAH	2771		0-N160	TB [TE]	
2.8, 2.8 quattro	01/95-07/97	AAH	2771		0-N2000	TB [DG]	
2.8, 2.8 quattro	10/96-08/01	AMX, APR, AQD	2771		0-N1275	TB [BT]	
2.8, 2.8 quattro	10/96-08/01	ACK, ALG	2771	ch.8D-V-205001→	0-N1275	TB [BT]	
2.8, 2.8 quattro	10/96-08/01	ACK	2771	ch.→8D-V-205000	0-N1372	TB [BT]	
1.6	11/94-10/00	ADP, AHL, ANA, ARM	1595	Rippenanzahl: 4	0-N1317	VB [TE]	S
1.6	07/00-11/00	ALZ	1595		0-N1662	VB [DG]	
1.8, 1.8 quattro, 1.8 T, 1.8 T quattro	01/95-11/00	ADR, APT, ARG, ADR, APT, ARG, AVV, AEB, ANB, APU, ARK, AWT, AFY, AJL	1781	Rippenanzahl: 4	0-N1317	VB [TE]	S
1.9 TDI, 1.9 TDI quattro	01/95-11/00	1Z, AHH, AHU, AFF, AFN, AVG	1896	Rippenanzahl: 4	0-N1317	VB [TE]	S
1.9 TDI, 1.9 TDI quattro	01/95-11/00	1Z, AHH, AHU, AFF, AFN, AVG	1896	Rippenanzahl: 5	0-N1432	VB [TE]	S
1.9 TDI, 1.9 TDI quattro	03/00-11/00	AJM, AJM, ATJ	1896	Rippenanzahl: 5	0-N1441	VB [BT]	S
1.9 TDI, 1.9 TDI quattro	03/00-11/00	AJM, AJM, ATJ	1896		0-N2047	VB [DG]	
1.9 TDI, 1.9 TDI quattro	03/00-11/00	AJM, AJM, ATJ	1896		0-N2139	VB [VD]	
2.4, 2.4 quattro	03/97-11/00	AGA, ALF, AML, APS, ARJ, AJG, AMM, APZ, APZ	2393		0-N1083	VB [BT]	S
2.5 TDI, 2.5 TDI quattro	09/97-11/00	AFB, AKN	2496		0-N1005	VB [TE]	
2.5 TDI, 2.5 TDI quattro	09/97-11/00	AFB, AKN	2496		0-N1308	VB [TE]	
2.5 TDI, 2.5 TDI quattro	09/97-11/00	AFB, AKN	2496		0-N1315	VB [DG]	
2.5 TDI, 2.5 TDI quattro	09/97-11/00	AFB, AKN	2496	Rippenanzahl: 6	0-N1431	VB [DG]	
2.5 TDI, 2.5 TDI quattro	09/97-11/00	AFB, AKN	2496		0-N1947	VB [VD]	
2.5 TDI, 2.5 TDI quattro	09/97-11/00	AFB, AKN	2496		0-N2196	VB [BT]	
2.5 TDI, 2.5 TDI quattro	09/97-11/00	AFB, AKN	2496		0-N2258	VB [BT]	
2.5 TDI, 2.5 TDI quattro	09/97-11/00	AFB, AKN	2496		0-N2417	VB [BT]	
2.6, 2.6 quattro	01/95-11/00	ABC	2598		0-N1083	VB [BT]	S
2.6, 2.6 quattro	01/95-11/00	ABC	2598		0-N1414	VB [DG]	
2.8, 2.8 quattro	01/95-08/01	AAH, ACK, AHA, ALG, AMX, APR, AQD	2771		0-N1083	VB [BT]	S
2.8, 2.8 quattro	01/95-07/97	AAH	2771		0-N1414	VB [DG]	
S4 quattro	09/97-09/01	AGB, AZB	2671		0-N1083	VB [BT]	S

A4 Avant (8D5, B5)

1.6	11/94-09/01	ADP	1595	18x121; mit Zubehör	SK-1101	BTK	
1.6	11/94-09/01	AHL, ANA, ARM	1595	23x138	SK-1109	BTK	
1.6	11/94-09/01	AHL, ANA, ARM	1595	23x138	SK-1109AQ1	BTKW	
1.6	07/00-09/01	ALZ	1595	23x138; Baumuster: 8D5, B5	SK-1109	BTK	
1.6	07/00-09/01	ALZ	1595	23x138	SK-1109AQ1	BTKW	
1.8	07/95-09/01	AFY	1781	25x153; ch.8D-T-155001→; 01/1996 →; mit Zubehör; Baumuster: 8D5, B5	SK-1346	BTK	
1.8	07/95-09/01	AFY	1781	25x153; ch.8D-T-155001→; 01/1996 →; mit Spanndämpfer, Spannrolle; mit Zubehör	SK-1638	BTK	



CM³



Art. Nr.

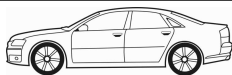

A4 Avant (8D5, B5)							
1.8	07/95-09/01	AFY	1781	25x153; ch.→8D-T-155000; ohne Spanndämpfer, Spannrolle	SK-1641	BTK	
1.8	02/96-09/01	ADR, APT, ARG, AVV	1781	25x153; ch.8D-T-155001→; mit Zubehör; Baumuster: 8D5, B5	SK-1346	BTK	
1.8	02/96-09/01	ADR, APT, ARG, AVV	1781	25x153; ch.8D-T-155001→; mit Spanndämpfer, Spannrolle; mit Zubehör	SK-1638	BTK	
1.8 quattro	01/96-09/01	ADR, APT, ARG	1781	25x153; ch.8D-T-155001→; 08/1997 →; mit Zubehör; Baumuster: 8D5, B5	SK-1346	BTK	
1.8 quattro, 1.8 T quattro	01/96-09/01	ADR, APT, ARG, AEB, ANB, APU, ARK, AWT	1781	25x153; ch.8D-T-155001→; 08/1997 →; mit Spanndämpfer, Spannrolle; mit Zubehör	SK-1638	BTK	
1.8 quattro, 1.8 T, 1.8 T quattro	07/95-09/01	AFY, AJL	1781	25x153; mit Zubehör; Baumuster: 8D5, B5	SK-1346	BTK	
1.8 quattro, 1.8 T, 1.8 T quattro	07/95-09/01	AFY, AJL	1781	25x153; mit Spanndämpfer, Spannrolle; mit Zubehör	SK-1638	BTK	
1.8 T	03/96-09/01	AEB	1781	25x153; ch.→8D-T-155009	SK-1121	BTK	
1.8 T	03/96-09/01	AEB, ANB, APU, ARK	1781	25x153; mit Zubehör	SK-1346	BTK	
1.8 T	03/96-09/01	AEB, ANB, APU, ARK	1781	25x153; mit Spanndämpfer, Spannrolle; mit Zubehör	SK-1638	BTK	
1.8 T	03/96-09/01	AWT	1781	23x150; ch.8D-1-042385→; ohne Spanndämpfer, Spannrolle; mit Zubehör	SK-1640	BTK	
1.8 T	03/96-09/01	AWT	1781	23x150; ch.8D-1-042385→; ohne Spanndämpfer, Spannrolle; mit Zubehör	SK-1640AQ1	BTKW	
1.8 T	03/96-09/01	AWT	1781	23x150; ch.→8D-1-042384	SK-1660AQ1	BTKW	
1.8 T	03/96-09/01	AWT	1781	23x150; ch.→8D-1-042384	SK-1710	BTK	
1.8 T quattro	01/96-09/01	AEB, ANB, APU, ARK	1781	25x153; ch.8D-T-155001→; 08/1997 →; mit Zubehör; Baumuster: 8D5, B5	SK-1346	BTK	
1.8 T, 1.8 T quattro	01/96-09/01	AEB	1781	25x153; → 07/1999; ohne Spanndämpfer, Spannrolle; Baumuster: 8D5, B5	SK-1641	BTK	
1.8 T, 1.8 T quattro	01/96-09/01	AWT	1781	23x150; ch.→8D-1-042384	SK-1660	BTK	
1.8 T, 1.8 T quattro	01/96-09/01	AWT	1781	23x150; ch.8D-1-042 385→; mit Zubehör	SK-1726	BTK	
1.8 T, 1.8 T quattro	01/96-09/01	AWT	1781	23x150; ch.8D-1-042 385→; mit Zubehör	SK-1726AQ1	BTKW	
1.8, 1.8 quattro	01/96-09/01	ADR	1781	25x153; → 07/1999; ohne Spanndämpfer, Spannrolle; Baumuster: 8D5, B5	SK-1641	BTK	
1.8, 1.8 quattro, 1.8 T quattro	07/95-09/01	ADR, APT, ARG, ADR, APT, ARG, AVV, AEB, ANB, APU, ARK, AWT, AFY	1781	25x153; ch.→8D-T-155000; mit Spanndämpfer, Spannrolle	SK-1121	BTK	
1.9 DUO, 1.9 TDI, 1.9 TDI quattro	02/96-09/01	AFF, AFN, AVG, AHU	1896	25x137; mit Zubehör	SK-1098	BTK	
1.9 TDI	02/96-09/01	1Z, AHU	1896	25x137; mit Zubehör	SK-1098	BTK	
1.9 TDI	02/96-09/01	1Z, AHH, AHU	1896	25x137; ch.→8D1200000; 04/1997 → 09/2000; mit Zubehör	SK-1593	BTK	
1.9 TDI	03/00-09/01	AJM	1896	30x120; mit Zubehör; Baumuster: 8D5, B5	SK-1582	BTK	
1.9 TDI	03/00-09/01	AJM	1896	30x120; mit Spanndämpfer, Spannrolle; mit Zubehör; Baumuster: 8D5, B5	SK-1583	BTK	
1.9 TDI quattro	03/00-09/01	ATJ	1896	30x120; mit Zubehör; Baumuster: 8D5, B5	SK-1582	BTK	
1.9 TDI quattro	03/00-09/01	ATJ	1896	30x120; mit Spanndämpfer, Spannrolle; mit Zubehör; Baumuster: 8D5, B5	SK-1583	BTK	
1.9 TDI, 1.9 TDI quattro	03/00-09/01	AJM, AJM, ATJ	1896	30x120; ohne Spanndämpfer, Spannrolle; mit Zubehör	SK-1582AQ1	BTKW	
1.9 TDI, 1.9 TDI quattro	03/00-09/01	AJM, AJM, ATJ	1896	30x120; mit Spanndämpfer, Spannrolle; mit Zubehör	SK-1583AQ1	BTKW	
2.4	07/95-07/97	AFM	2393	25x239; mit Zubehör	SK-1376	BTK	
2.4	07/95-07/97	AFM	2393	25x239	SK-1376AQ1	BTKW	
2.4	07/95-07/97	AFM	2393	30x253; mit Spanndämpfer, Spannrolle; mit Zubehör	SK-1377	BTK	
2.4	03/97-09/01	AGA, ALF, AML, APS, ARJ	2393	30x253; mit Spanndämpfer, Spannrolle; mit Zubehör; Baumuster: 8D5, B5	SK-1377	BTK	
2.4	08/97-09/01	AJG, AMM, APZ	2393	30x253; mit Spanndämpfer, Spannrolle; mit Zubehör; Baumuster: 8D5, B5	SK-1377	BTK	
2.4	08/97-09/01	AJG, APZ	2393	30x253; ch.→8D-X-315000; mit Zubehör	SK-1383AQ1	BTKW	
2.4 quattro	03/97-09/01	AGA, ALF, APS, ARJ	2393	30x253; 08/1997 →; mit Spanndämpfer, Spannrolle; mit Zubehör; Baumuster: 8D5, B5	SK-1377	BTK	
2.4 quattro	08/97-09/01	APZ	2393	30x253; mit Spanndämpfer, Spannrolle; mit Zubehör; Baumuster: 8D5, B5	SK-1377	BTK	
2.4 quattro	08/97-09/01	APZ	2393	30x253; ch.→8D-X-315000; mit Zubehör	SK-1383AQ1	BTKW	
2.4, 2.4 quattro	03/97-09/01	AGA, ALF, AML, APS, ARJ, AJG, AMM, APZ, APZ	2393	30x253; mit Spanndämpfer, Spannrolle; mit Zubehör	SK-1377AQ1	BTKW	
2.4, 2.4 quattro	03/97-09/01	AGA, ALF, AML, APS, ARJ	2393	30x253; 08/1997 →; ohne Spanndämpfer, Spannrolle; mit Zubehör	SK-1383	BTK	
2.4, 2.4 quattro	03/97-09/01	AGA, ALF, AML, APS, ARJ	2393	30x253; ch.→8D-X-315000; mit Zubehör	SK-1383AQ1	BTKW	
2.4, 2.4 quattro	08/97-09/01	AJG, AMM, APZ, APZ	2393	30x253; ohne Spanndämpfer, Spannrolle; mit Zubehör	SK-1383	BTK	
2.5 TDI, 2.5 TDI quattro	09/97-09/01	AFB, AKN	2496	32x207; 24x87; ohne Spanndämpfer, Spannrolle; mit Zubehör; Baumuster: 8D5, B5	SK-1375	BTK	

CM³

Art. Nr.



ohne Halter

A4 Avant (8D5, B5)

2.5 TDI, 2.5 TDI quattro	09/97-09/01	AFB, AKN	2496	30x207; 24x87; mit Spanndämpfer, Spannrolle; mit Zubehör	SK-1621AQ1	BTKW	
2.5 TDI, 2.5 TDI quattro	09/97-09/01	AFB, AKN	2496	32x207; 24x87; mit Spanndämpfer, Spannrolle; mit Zubehör	SK-1633	BTK	
2.5 TDI, 2.5 TDI quattro	09/97-09/01	AKN	2496	32x207; 24x87; mit Spanndämpfer, Spannrolle; mit Zubehör	SK-1633AQ1	BTKW	
2.6, 2.6 quattro	01/96-09/01	ABC	2598	25x239; mit Zubehör	SK-1376	BTK	
2.6, 2.6 quattro	01/96-09/01	ABC	2598	25x239	SK-1376AQ1	BTKW	
2.8, 2.8 quattro	10/96-09/01	ACK, AHA, ALG, AMX, APR, AQD	2771	30x253; ch.8D-V-205001→; mit Spanndämpfer, Spannrolle; mit Zubehör	SK-1377	BTK	
2.8, 2.8 quattro	10/96-09/01	ACK, AHA, ALG, AMX, APR, AQD	2771	30x253; ch.8D-V-205001→; mit Spanndämpfer, Spannrolle; mit Zubehör	SK-1377AQ1	BTKW	
2.8, 2.8 quattro	10/96-09/01	ACK, AHA, ALG, AMX, APR, AQD	2771	30x253; ohne Spanndämpfer, Spannrolle; mit Zubehör	SK-1383	BTK	
2.8, 2.8 quattro	10/96-09/01	ACK, ALG, AMX, APR, AQD	2771	30x253; ch.8D-V-205001→; 8D-X-315000; mit Zubehör	SK-1383AQ1	BTKW	
2.8, 2.8 quattro	10/96-09/01	ACK, AHA, ALG, AMX, APR, AQD	2771	30x253; ch.→8D-V-205000; mit Spanndämpfer, Spannrolle; mit Zubehör	SK-1636	BTK	
2.8, 2.8 quattro	03/99-09/00	ATX	2771	30x253; mit Spanndämpfer, Spannrolle; mit Zubehör	SK-1377	BTK	
RS4 quattro	05/00-09/01	ASJ	2671	30x253; mit Spanndämpfer, Spannrolle; mit Zubehör; Baumuster: 8D5, B5	SK-1377	BTK	
RS4 quattro, S4 quattro	09/97-09/01	AGB, AZB, ASJ, AZR	2671	30x253; ohne Spanndämpfer, Spannrolle; mit Zubehör	SK-1383	BTK	
S4 quattro	09/97-09/01	AGB	2671	30x253; mit Spanndämpfer, Spannrolle; mit Zubehör; Baumuster: 8D5, B5	SK-1377	BTK	
1.6	11/94-09/01	ADP	1595		0-N132	TB [TE]	
1.6	11/94-09/01	AHL, ANA, ARM	1595		0-N157	TB [TE]	
1.6	11/94-09/01	ADP, AHL, ANA, ARM, ALZ	1595		0-N1822	TB [BT]	S
1.6	07/00-09/01	ALZ	1595		0-N157	TB [TE]	
1.8	07/95-09/01	AFY	1781	ch.→T-155000; → 12/1995	0-N130	TB [TE]	S
1.8	02/96-09/01	APT, ARG, AVV	1781		0-N1236	TB [TE]	
1.8 quattro	01/96-09/01	APT, ARG	1781		0-N1236	TB [TE]	
1.8 T	03/96-09/01	AWT	1781	ch.8D-1-042385→	0-N1050	TB [TE]	
1.8 T	03/96-09/01	AEB, ANB, APU, ARK, AWT, AJL	1781	→ 07/1998	0-N130	TB [TE]	S
1.8 T, 1.8 T quattro	01/96-09/01	AWT	1781	ch.→8D-1-042384	0-N1042	TB [TE]	
1.8 T, 1.8 T quattro	01/96-09/01	AWT	1781	ch.8D-1-042385→; 01/2000 →	0-N1051	TB [BT]	S
1.8 T, 1.8 T quattro	01/96-09/01	ARK	1781		0-N1236	TB [TE]	
1.8 T, 1.8 T quattro	01/96-09/01	AEB	1781	ch.8D-T-155010→	0-N1236	TB [TE]	
1.8 T, 1.8 T quattro	01/96-09/01	ANB, APU	1781	020001→	0-N1236	TB [TE]	
1.8 T, 1.8 T quattro	01/96-09/01	AWT	1781	ch.→8D-1-042384	0-N1237	TB [BT]	
1.8 T, 1.8 T quattro	01/96-09/01	ARK	1781		0-N1276	TB [BT]	
1.8 T, 1.8 T quattro	01/96-09/01	AEB	1781	ch.8D-T-155010→	0-N1276	TB [BT]	
1.8 T, 1.8 T quattro	01/96-09/01	ANB, APU	1781	020001→	0-N1276	TB [BT]	
1.8 T, 1.8 T quattro	01/96-09/01	AEB, ANB, ARK	1781		0-N131	TB [DG]	
1.8 T, 1.8 T quattro	01/96-09/01	AWT	1781		0-N1316	TB [DG]	
1.8 T, 1.8 T quattro	01/96-09/01	AWT	1781	ch.8D-1-042385→; 01/2000 →; Spannrollenbetätigung: automatisch	0-N2195	TB [TE]	
1.8 T, 1.8 T quattro	01/96-09/01	AWT	1781	ch.8D-1-042385→; 01/2000 →	0-N2234	TB [DG]	
1.8, 1.8 quattro	01/96-09/01	ADR	1781	ch.8D-T-155010→	0-N1236	TB [TE]	
1.8, 1.8 quattro, 1.8 T quattro	01/96-09/01	ADR, APT, ARG, ADR, APT, ARG, AVV, AEB, ANB, APU, ARK, AWT	1781	ch.→8D-T-155000	0-N130	TB [TE]	S
1.8, 1.8 quattro, 1.8 T, 1.8 T quattro	07/95-09/01	AFY, AJL	1781		0-N1236	TB [TE]	
1.8, 1.8 quattro, 1.8 T, 1.8 T quattro	07/95-09/01	ADR, APT, ARG, ADR, APT, ARG, AVV, AFY, AJL	1781		0-N1276	TB [BT]	
1.8, 1.8 quattro, 1.8 T, 1.8 T quattro	07/95-09/01	ADR, APT, ARG, ADR, APT, ARG, AVV, AFY, AJL	1781		0-N131	TB [DG]	
1.8, 1.8 quattro, 1.8 T, 1.8 T quattro	07/95-09/01	ADR, APT, ARG, ADR, APT, ARG, AVV, AEB, ANB, APU, ARK, AWT, AFY, AJL	1781		0-N1822	TB [BT]	S
1.9 DUO, 1.9 TDI, 1.9 TDI quattro	02/96-09/01	AFF, AFN, AVG, AHU	1896		0-N104	TB [TE]	
1.9 DUO, 1.9 TDI, 1.9 TDI quattro	02/96-09/01	1Z, AHH, AHU, AFF, AFN, AVG, AHU	1896		0-N128	TB [DG]	
1.9 TDI	02/96-09/01	1Z, AHU	1896		0-N104	TB [TE]	
1.9 TDI	02/96-09/01	AHH	1896		0-N1332	TB [TE]	
1.9 TDI, 1.9 TDI quattro	03/00-09/01	AJM, AJM, ATJ	1896		0-N1048	TB [TE]	
1.9 TDI, 1.9 TDI quattro	03/00-09/01	AJM, AJM, ATJ	1896		0-N1268	TB [DG]	
1.9 TDI, 1.9 TDI quattro	03/00-09/01	AJM, AJM, ATJ	1896		0-N1274	TB [BT]	
2.4	07/95-07/97	AFM	2393		0-N160	TB [TE]	
2.4	07/95-07/97	AFM	2393		0-N2000	TB [DG]	
2.4, 2.4 quattro	03/97-09/01	AGA, ALF, AML, APS, ARJ, AJG, AMM, APZ, APZ	2393		0-N1238	TB [TE]	



CM³



Art. Nr.



A4 Avant (8D5, B5)

2.4, 2.4 quattro	03/97-09/01	AGA, ALF, AML, APS, ARJ, AJG, AMM, APZ, APZ	2393		0-N1275	TB [BT]	
2.4, 2.4 quattro	03/97-09/01	AGA, ALF, AML, APS, ARJ, AJG, AMM, APZ, APZ	2393		0-N1371	TB [TE]	
2.4, 2.4 quattro	03/97-09/01	AGA, ALF, AML, APS, ARJ, AJG, AMM, APZ, APZ	2393		0-N2001	TB [DG]	
2.5 TDI, 2.5 TDI quattro	09/97-09/01	AFB, AKN	2496		0-N1266	TB [TE]	
2.5 TDI, 2.5 TDI quattro	09/97-09/01	AFB, AKN	2496		0-N1363	TB [TE]	
2.5 TDI, 2.5 TDI quattro	09/97-09/01	AFB, AKN	2496		0-N1364	TB [BT]	
2.5 TDI, 2.5 TDI quattro	09/97-09/01	AFB, AKN	2496		0-N168	TB [DG]	
2.5 TDI, 2.5 TDI quattro	09/97-09/01	AFB, AKN	2496		0-N201	TB [BT]	
2.6, 2.6 quattro	01/96-09/01	ABC, ACZ	2598		0-N160	TB [TE]	
2.6, 2.6 quattro	01/96-09/01	ABC, ACZ	2598		0-N2000	TB [DG]	
2.8, 2.8 quattro	01/96-09/96	AAH	2771		0-N160	TB [TE]	
2.8, 2.8 quattro	01/96-09/96	AAH	2771		0-N2000	TB [DG]	
2.8, 2.8 quattro	10/96-09/01	ACK, AHA, ALG, AMX, APR, AQD, ATX	2771		0-N1238	TB [TE]	
2.8, 2.8 quattro	10/96-09/01	AMX, APR, AQD	2771		0-N1275	TB [BT]	
2.8, 2.8 quattro	10/96-09/01	ACK, ALG	2771	ch.8D-V-205001→	0-N1275	TB [BT]	
2.8, 2.8 quattro	10/96-09/01	ACK, AHA, ALG, AMX, APR, AQD, ATX	2771		0-N1371	TB [TE]	
2.8, 2.8 quattro	10/96-09/01	ACK	2771	ch.→8D-V-205000	0-N1372	TB [BT]	
2.8, 2.8 quattro	10/96-09/01	ACK, AHA, ALG, AMX, APR, AQD, ATX	2771		0-N2001	TB [DG]	
2.8, 2.8 quattro	03/99-09/00	ATX	2771		0-N1275	TB [BT]	
RS4 quattro, S4 quattro	09/97-09/01	AGB, AZB, ASJ, AZR	2671		0-N1238	TB [TE]	
RS4 quattro, S4 quattro	09/97-09/01	AGB, AZB, ASJ, AZR	2671		0-N1275	TB [BT]	
RS4 quattro, S4 quattro	09/97-09/01	AGB, AZB, ASJ, AZR	2671		0-N1371	TB [TE]	
RS4 quattro, S4 quattro	09/97-09/01	AGB, AZB, ASJ, AZR	2671		0-N2001	TB [DG]	
1.6	11/94-09/01	ADP, AHL, ANA, ARM	1595	Rippenanzahl: 4	0-N1317	VB [TE]	S
1.6	07/00-09/01	ALZ	1595		0-N1662	VB [DG]	
1.8, 1.8 quattro, 1.8 T, 1.8 T quattro	07/95-09/01	ADR, APT, ARG, ADR, APT, ARG, AVV, AEB, ANB, APU, ARK, AWT, AFY, AJL	1781	Rippenanzahl: 4	0-N1317	VB [TE]	S
1.9 DUO, 1.9 TDI, 1.9 TDI quattro	02/96-09/01	1Z, AHH, AHU, AFF, AFN, AVG, AHU	1896	Rippenanzahl: 4	0-N1317	VB [TE]	S
1.9 DUO, 1.9 TDI, 1.9 TDI quattro	02/96-09/01	1Z, AHH, AHU, AFF, AFN, AVG, AHU	1896	Rippenanzahl: 5	0-N1432	VB [TE]	S
1.9 TDI, 1.9 TDI quattro	03/00-09/01	AJM, AJM, ATJ	1896	Rippenanzahl: 5	0-N1441	VB [BT]	S
1.9 TDI, 1.9 TDI quattro	03/00-09/01	AJM, AJM, ATJ	1896		0-N2047	VB [DG]	
1.9 TDI, 1.9 TDI quattro	03/00-09/01	AJM, AJM, ATJ	1896		0-N2139	VB [VD]	
2.4, 2.4 quattro	03/97-09/01	AGA, ALF, AML, APS, ARJ, AJG, AMM, APZ, APZ	2393		0-N1083	VB [BT]	S
2.5 TDI, 2.5 TDI quattro	09/97-09/01	AFB, AKN	2496		0-N1005	VB [TE]	
2.5 TDI, 2.5 TDI quattro	09/97-09/01	AFB, AKN	2496		0-N1308	VB [TE]	
2.5 TDI, 2.5 TDI quattro	09/97-09/01	AFB, AKN	2496		0-N1315	VB [DG]	
2.5 TDI, 2.5 TDI quattro	09/97-09/01	AFB, AKN	2496	Rippenanzahl: 6	0-N1431	VB [DG]	
2.5 TDI, 2.5 TDI quattro	09/97-09/01	AFB, AKN	2496		0-N1947	VB [VD]	
2.5 TDI, 2.5 TDI quattro	09/97-09/01	AFB, AKN	2496		0-N2196	VB [BT]	
2.5 TDI, 2.5 TDI quattro	09/97-09/01	AFB, AKN	2496		0-N2258	VB [BT]	
2.5 TDI, 2.5 TDI quattro	09/97-09/01	AFB, AKN	2496		0-N2417	VB [BT]	
2.6, 2.6 quattro	01/96-09/01	ABC	2598		0-N1083	VB [BT]	S
2.6, 2.6 quattro	01/96-09/01	ABC	2598		0-N1414	VB [DG]	
2.8, 2.8 quattro	01/96-09/01	AAH, ACK, AHA, ALG, AMX, APR, AQD	2771		0-N1083	VB [BT]	S
2.8, 2.8 quattro	01/96-09/96	AAH	2771		0-N1414	VB [DG]	
RS4 quattro, S4 quattro	09/97-09/01	AGB, AZB, ASJ, AZR	2671		0-N1083	VB [BT]	S

A4 (8E2, B6)

1.6	11/00-12/04	ALZ	1595	23x138; Baumuster: 8E2, B6	SK-1109	BTK	
1.6	11/00-12/04	ALZ	1595	23x138	SK-1109AQ1	BTKW	
1.8 T, 1.8 T quattro	11/00-12/04	AVJ, BEX, BFB	1781	23x150; ohne Spanndämpfer, Spannrolle; mit Zubehör	SK-1640	BTK	
1.8 T, 1.8 T quattro	11/00-12/04	AVJ, BEX, BFB	1781	23x150; ohne Spanndämpfer, Spannrolle; mit Zubehör	SK-1640AQ1	BTKW	
1.8 T, 1.8 T quattro	11/00-12/04	AMB, AVJ, BEX, BFB	1781	23x150; mit Zubehör	SK-1726	BTK	
1.8 T, 1.8 T quattro	11/00-12/04	AMB, AVJ, BEX, BFB	1781	23x150; mit Zubehör	SK-1726AQ1	BTKW	
1.9 TDI	11/00-12/04	AVF, AWX	1896	30x120; ch.→8E-2-297100; mit Zubehör; Baumuster: 8E2, B6	SK-1582	BTK	
1.9 TDI	11/00-12/04	AVF, AWX	1896	30x120; ch.→8E-2-297100; mit Spanndämpfer, Spannrolle; mit Zubehör; Baumuster: 8E2, B6	SK-1583	BTK	
1.9 TDI	06/04-12/04	BKE	1896	30x120	SK-1372AQ2	BTKW	
1.9 TDI	06/04-12/04	BKE	1896	30x120; ch.→8E-2-297100; mit Zubehör	SK-1582	BTK	
1.9 TDI	06/04-12/04	BKE	1896	30x120; ch.→8E-2-297100; mit Spanndämpfer, Spannrolle; mit Zubehör	SK-1583	BTK	



CM³



Art. Nr.



A4 (8E2, B6)

1.9 TDI, 1.9 TDI quattro	11/00-12/04	AVB, AVF, AVF, AWX, BKE	1896	30x120; ch.8E-2-297101→; mit Zubehör	SK-1372	BTK	
1.9 TDI, 1.9 TDI quattro	11/00-12/04	AVB, AVF, AVF, AWX	1896	30x120; ch.8E-2-297101→	SK-1372AQ2	BTKW	
1.9 TDI, 1.9 TDI quattro	11/00-12/04	AVB, AVF, AVF, AWX	1896	30x120; ch.→8E-2-297100; ohne Spanndämpfer, Spannrolle; mit Zubehör	SK-1582AQ1	BTKW	
1.9 TDI, 1.9 TDI quattro	11/00-12/04	AVB, AVF, AVF, AWX	1896	30x120; ch.→8E-2-297100; mit Spanndämpfer, Spannrolle; mit Zubehör	SK-1583AQ1	BTKW	
1.9 TDI, 1.9 TDI quattro	05/01-12/04	AVB, AVF	1896	30x120; ch.→8E-2-297100; mit Zubehör; Baumuster: 8E2, B6	SK-1582	BTK	
1.9 TDI, 1.9 TDI quattro	05/01-12/04	AVB, AVF	1896	30x120; ch.→8E-2-297100; mit Spanndämpfer, Spannrolle; mit Zubehör; Baumuster: 8E2, B6	SK-1583	BTK	
2.0	11/00-12/04	ALT	1984	23x150; ohne Spanndämpfer, Spannrolle; mit Zubehör	SK-1640	BTK	
2.0	11/00-12/04	ALT	1984	23x150; ohne Spanndämpfer, Spannrolle; mit Zubehör	SK-1640AQ2	BTKW	
2.0	11/00-12/04	ALT	1984	23x150; mit Zubehör	SK-1726	BTK	
2.0	11/00-12/04	ALT	1984	23x150; mit Zubehör	SK-1726AQ2	BTKW	
2.0 FSI	07/02-12/04	AWA	1984	23x145; ch.8E-3-390001→; 8E-4-400000; mit Zubehör	SK-1599	BTK	
2.0 FSI	07/02-12/04	AWA	1984	23x145; ch.8E-3-390001→; 8E-4-400000; mit Zubehör	SK-1599AQ1	BTKW	
2.0 FSI	07/02-12/04	AWA	1984	23x148; ch.8E-5-000 001→	SK-1606	BTK	
2.4	09/01-12/04	AMM, BDV	2393	30x253; mit Spanndämpfer, Spannrolle; mit Zubehör; Baumuster: 8E2, B6	SK-1377	BTK	
2.4	09/01-12/04	AMM, BDV	2393	30x253; mit Spanndämpfer, Spannrolle; mit Zubehör	SK-1377AQ1	BTKW	
2.4	09/01-12/04	AMM, BDV	2393	30x253; ohne Spanndämpfer, Spannrolle; mit Zubehör	SK-1383	BTK	
2.5 TDI	08/01-07/02	AYM	2496	30x207; 24x87; ohne Spanndämpfer, Spannrolle; mit Zubehör; Baumuster: 8E2, B6	SK-1619	BTK	
2.5 TDI	08/01-07/02	AYM	2496	30x207; 24x87; mit Spanndämpfer, Spannrolle; mit Zubehör; Baumuster: 8E2, B6	SK-1621	BTK	
2.5 TDI	07/02-12/04	BCZ, BDG, BFC	2496	30x207; 24x87; ohne Spanndämpfer, Spannrolle; mit Zubehör; Baumuster: 8E2, B6	SK-1619	BTK	
2.5 TDI	07/02-12/04	BCZ, BDG, BFC	2496	30x207; 24x87; mit Spanndämpfer, Spannrolle; mit Zubehör; Baumuster: 8E2, B6	SK-1621	BTK	
2.5 TDI quattro	11/00-12/04	AKE, BAU, BDH	2496	30x207; 24x87; ohne Spanndämpfer, Spannrolle; mit Zubehör; Baumuster: 8E2, B6	SK-1619	BTK	
2.5 TDI quattro	11/00-12/04	AKE, BAU, BDH	2496	30x207; 24x87; mit Spanndämpfer, Spannrolle; mit Zubehör; Baumuster: 8E2, B6	SK-1621	BTK	
2.5 TDI, 2.5 TDI quattro	11/00-12/04	AKE, BAU, BDH, AYM, BCZ, BDG, BFC	2496	30x207; 24x87; nur in Verbindung mit: 078 121 113 F; mit Zubehör	SK-1619AQ2	BTKW	
2.5 TDI, 2.5 TDI quattro	11/00-12/04	AKE, BAU, BDH, AYM, BCZ, BDG, BFC	2496	30x207; 24x87; mit Spanndämpfer, Spannrolle; mit Zubehör	SK-1621AQ1	BTKW	
2.5 TDI, 2.5 TDI quattro	11/00-12/04	AKE, BAU, BDH, AYM, BCZ, BDG, BFC	2496	32x207; 24x87; mit Spanndämpfer, Spannrolle; mit Zubehör	SK-1633AQ1	BTKW	
3.0, 3.0 quattro	11/00-12/04	ASN, AVK, BBJ	2976	30x281; ohne Spanndämpfer, Spannrolle	SK-1538	BTK	
3.0, 3.0 quattro	11/00-12/04	ASN, AVK, BBJ	2976	30x281; mit Spanndämpfer, Spannrolle	SK-1601	BTK	
1.6	11/00-12/04	ALZ	1595		0-N157	TB [TE]	
1.6	11/00-12/04	ALZ	1595	ch.→8E-1-000000	0-N1822	TB [BT]	S
1.8 T, 1.8 T quattro	11/00-12/04	AVJ, BEX, BFB	1781		0-N1050	TB [TE]	
1.8 T, 1.8 T quattro	11/00-12/04	AMB, AVJ, BEX, BFB	1781		0-N1051	TB [BT]	S
1.8 T, 1.8 T quattro	11/00-12/04	AMB, AVJ, BEX, BFB	1781		0-N1316	TB [DG]	
1.9 TDI	06/04-12/04	BKE	1896		0-N1045	TB [TE]	
1.9 TDI	06/04-12/04	BKE	1896		0-N1046	TB [DG]	
1.9 TDI, 1.9 TDI quattro	11/00-12/04	AVB, AVF, AVF, AWX	1896	ch.8E-2-297101→	0-N1045	TB [TE]	
1.9 TDI, 1.9 TDI quattro	11/00-12/04	AVB, AVF, AVF, AWX	1896	ch.8E-2-297101→	0-N1046	TB [DG]	
1.9 TDI, 1.9 TDI quattro	11/00-12/04	AVB, AVF, AVF, AWX	1896	ch.→8E-2-297100	0-N1048	TB [TE]	
1.9 TDI, 1.9 TDI quattro	11/00-12/04	AVB, AVF, AVF, AWX	1896	ch.→8E-2-297100	0-N1268	TB [DG]	
1.9 TDI, 1.9 TDI quattro	11/00-12/04	AVB, AVF, AVF, AWX	1896	ch.→8E-2-297100	0-N1274	TB [BT]	
2.0	11/00-12/04	ALT	1984		0-N1050	TB [TE]	
2.0	11/00-12/04	ALT	1984		0-N1051	TB [BT]	S
2.0 FSI	07/02-12/04	AWA	1984	ch.8E-3-390001→	0-N1340	TB [TE]	
2.0 FSI	07/02-12/04	AWA	1984	ch.→8E-4-400000	0-N1341	TB [DG]	
2.0 FSI	07/02-12/04	AWA	1984	ch.8E-4-400001→	0-N1346	TB [DG]	
2.0 FSI	07/02-12/04	AWA	1984	ch.→8E-3-390 000	0-N1817	TB [BT]	S

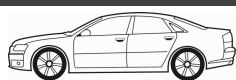

CM³



Art. Nr.



A4 (8E2, B6)							
2.0 FSI	07/02-12/04	AWA	1984	ch.→8E-3-390 000		0-N1818	TB [BT]
2.0, 2.0 FSI	11/00-12/04	ALT, AWA	1984			0-N1316	TB [DG]
2.4	09/01-12/04	AMM, BDV	2393			0-N1238	TB [TE]
2.4	09/01-12/04	AMM, BDV	2393			0-N1275	TB [BT]
2.4	09/01-12/04	AMM, BDV	2393			0-N1371	TB [TE]
2.4	09/01-12/04	AMM, BDV	2393			0-N2001	TB [DG]
2.5 TDI, 2.5 TDI quattro	11/00-12/04	AKE, BAU, BDH, AYM, BCZ, BDG, BFC	2496			0-N1266	TB [TE]
2.5 TDI, 2.5 TDI quattro	11/00-12/04	AKE, BAU, BDH, AYM, BCZ, BDG, BFC	2496			0-N1363	TB [TE]
2.5 TDI, 2.5 TDI quattro	11/00-12/04	AKE, BAU, BDH, AYM, BCZ, BDG, BFC	2496			0-N1364	TB [BT]
2.5 TDI, 2.5 TDI quattro	11/00-12/04	AKE, BAU, BDH, AYM, BCZ, BDG, BFC	2496			0-N168	TB [DG]
2.5 TDI, 2.5 TDI quattro	11/00-12/04	AKE, BAU, BDH, AYM, BCZ, BDG, BFC	2496			0-N201	TB [BT]
3.0, 3.0 quattro	11/00-12/04	ASN, AVK, BBJ	2976			0-N1052	TB [DG]
3.0, 3.0 quattro	11/00-12/04	ASN, AVK, BBJ	2976			0-N1053	TB [DG]
3.0, 3.0 quattro	11/00-12/04	ASN, AVK, BBJ	2976			0-N1054	TB [TE]
3.0, 3.0 quattro	11/00-12/04	ASN, AVK, BBJ	2976			0-N1342	TB [BT]
1.6	11/00-12/04	ALZ	1595			0-N1662	VB [DG]
1.6	11/00-12/04	ALZ	1595	ch.8E-1-000001→		0-N1671	VB [BT] S
1.8 T, 1.8 T quattro	11/00-12/04	AMB, AVJ, BEX, BFB	1781			0-N1662	VB [DG]
1.8 T, 1.8 T quattro	11/00-12/04	AMB, AVJ, BEX, BFB	1781			0-N1671	VB [BT] S
1.9 TDI	11/00-12/04	AWX	1896	Rippenanzahl: 5		0-N1441	VB [BT] S
1.9 TDI	11/00-12/04	AVF	1896	ch.8E-4-010001→;		0-N1534	VB [BT] S
1.9 TDI	11/00-12/04	AVF	1896	ch.8E-4-000001→;		0-N1738	VB [DG]
1.9 TDI	11/00-12/04	AWX	1896	ch.→8E-3-500000;		0-N2047	VB [DG]
1.9 TDI	11/00-12/04	AWX	1896			0-N2139	VB [VD]
1.9 TDI	05/01-12/04	CBAA	1896			0-N1534	VB [BT] S
1.9 TDI	05/01-12/04	AVB	1896	ch.8E-4-000001→		0-N1738	VB [DG]
1.9 TDI	05/01-12/04	AVB	1896	ch.→8E-3-500000		0-N2047	VB [DG]
1.9 TDI	06/04-12/04	BKE	1896			0-N1534	VB [BT] S
1.9 TDI	06/04-12/04	BKE	1896			0-N1738	VB [DG]
1.9 TDI quattro	11/01-12/04	AVF	1896			0-N1534	VB [BT] S
1.9 TDI quattro	11/01-12/04	AVF	1896	ch.8E-4-000001→;		0-N1738	VB [DG]
1.9 TDI quattro	11/01-12/04	AVF	1896	ch.→8E-3-500000;		0-N2047	VB [DG]
1.9 TDI, 1.9 TDI quattro	11/00-12/04	AVB, AVF, AVF, AWX	1896	Rippenanzahl: 4		0-N1317	VB [TE] S
1.9 TDI, 1.9 TDI quattro	11/00-12/04	AVB, AVF, AVF, AWX	1896	ch.→8E-3-500000; Rippenanzahl: 5		0-N1441	VB [BT] S
1.9 TDI, 1.9 TDI quattro	11/00-12/04	AVF, AVF, AWX	1896	ch.→8E-4-010000; Rippenanzahl: 5		0-N1441	VB [BT] S
1.9 TDI, 1.9 TDI quattro	11/00-12/04	CBAA, CFGB	1896			0-N1534	VB [BT] S
1.9 TDI, 1.9 TDI quattro	11/00-12/04	AVF, AVF, AWX	1896	ch.→8E-4-010000;		0-N2047	VB [DG]
1.9 TDI, 1.9 TDI quattro	11/00-12/04	AVB, AVF, AVF, AWX	1896	ch.→8E-3-500000		0-N2139	VB [VD]
1.9 TDI, 1.9 TDI quattro	11/00-12/04	AVF, AVF, AWX	1896	ch.→8E-4-010000		0-N2139	VB [VD]
2.0, 2.0 FSI	11/00-12/04	ALT, AWA	1984			0-N1662	VB [DG]
2.0, 2.0 FSI	11/00-12/04	ALT, AWA	1984			0-N1671	VB [BT] S
2.4	09/01-12/04	AMM, BDV	2393			0-N1083	VB [BT] S
2.5 TDI, 2.5 TDI quattro	11/00-12/04	AKE, BAU, BDH, AYM, BCZ, BDG, BFC	2496			0-N1005	VB [TE]
2.5 TDI, 2.5 TDI quattro	11/00-12/04	AKE, BAU, BDH, AYM, BCZ, BDG, BFC	2496			0-N1308	VB [TE]
2.5 TDI, 2.5 TDI quattro	11/00-12/04	AKE, BAU, BDH, AYM, BCZ, BDG, BFC	2496			0-N1315	VB [DG]
2.5 TDI, 2.5 TDI quattro	11/00-12/04	AKE, BAU, BDH, AYM, BCZ, BDG, BFC	2496	Rippenanzahl: 6		0-N1431	VB [DG]
2.5 TDI, 2.5 TDI quattro	11/00-12/04	AKE, BAU, BDH, AYM, BCZ, BDG, BFC	2496			0-N1947	VB [VD]
2.5 TDI, 2.5 TDI quattro	11/00-12/04	AKE, BAU, BDH, AYM, BCZ, BDG, BFC	2496			0-N2196	VB [BT]
2.5 TDI, 2.5 TDI quattro	11/00-12/04	AKE, BAU, BDH, AYM, BCZ, BDG, BFC	2496			0-N2258	VB [BT]
2.5 TDI, 2.5 TDI quattro	11/00-12/04	AKE, BAU, BDH, AYM, BCZ, BDG, BFC	2496			0-N2417	VB [BT]
3.0, 3.0 quattro	11/00-12/04	ASN, AVK, BBJ	2976			0-N1537	VB [BT] S
3.0, 3.0 quattro	04/01-12/04	BBJ	2976	ch.8E-5-400001→		0-N2407	VB [BT] S
A4 Avant (8E5, B6)							
1.6	09/01-12/04	ALZ	1595	23x138; Baumuster: 8E5, B6		SK-1109	BTK
1.6	09/01-12/04	ALZ	1595	23x138		SK-1109AQ1	BTKW
1.8 T, 1.8 T quattro	09/01-12/04	AVJ, BEX, BFB	1781	23x150; ohne Spanndämpfer, Spannrolle; mit Zubehör		SK-1640	BTK
1.8 T, 1.8 T quattro	09/01-12/04	AVJ, BEX, BFB	1781	23x150; ohne Spanndämpfer, Spannrolle; mit Zubehör		SK-1640AQ1	BTKW
1.8 T, 1.8 T quattro	09/01-12/04	AMB, AVJ, BEX, BFB	1781	23x150; mit Zubehör		SK-1726	BTK
1.8 T, 1.8 T quattro	09/01-12/04	AMB, AVJ, BEX, BFB	1781	23x150; mit Zubehör		SK-1726AQ1	BTKW
1.9 TDI	09/01-12/04	AVF, AWX	1896	30x120; ch.→8E-2-297100; mit Zubehör; Baumuster: 8E5, B6		SK-1582	BTK
1.9 TDI	09/01-12/04	AVF, AWX	1896	30x120; ch.→8E-2-297100; mit Spanndämpfer, Spannrolle; mit Zubehör; Baumuster: 8E5, B6		SK-1583	BTK

CM³

Art. Nr.



ohne Halter

A4 Avant (8E5, B6)

1.9 TDI	06/04-12/04	BKE	1896	30x120	SK-1372AQ2	BTKW	
1.9 TDI	06/04-12/04	BKE	1896	30x120; ch.→8E-2-297100; mit Zubehör	SK-1582	BTK	
1.9 TDI	06/04-12/04	BKE	1896	30x120; ch.→8E-2-297100; mit Spanndämpfer, Spannrolle; mit Zubehör	SK-1583	BTK	
1.9 TDI, 1.9 TDI quattro	09/01-12/04	AVB, AVF, AVF, AWX, BKE	1896	30x120; ch.8E-2-297101→; mit Zubehör	SK-1372	BTK	
1.9 TDI, 1.9 TDI quattro	09/01-12/04	AVB, AVF, AVF, AWX	1896	30x120; ch.8E-2-297101→	SK-1372AQ2	BTKW	
1.9 TDI, 1.9 TDI quattro	09/01-12/04	AVB, AVF, AVF, AWX	1896	30x120; ch.→8E-2-297100; ohne Spanndämpfer, Spannrolle; mit Zubehör	SK-1582AQ1	BTKW	
1.9 TDI, 1.9 TDI quattro	09/01-12/04	AVB, AVF, AVF, AWX	1896	30x120; ch.→8E-2-297100; mit Spanndämpfer, Spannrolle; mit Zubehör	SK-1583AQ1	BTKW	
1.9 TDI, 1.9 TDI quattro	11/01-12/04	AVB, AVF	1896	30x120; ch.→8E-2-297100; mit Zubehör; Baumuster: 8E5, B6	SK-1582	BTK	
1.9 TDI, 1.9 TDI quattro	11/01-12/04	AVB, AVF	1896	30x120; ch.→8E-2-297100; mit Spanndämpfer, Spannrolle; mit Zubehör; Baumuster: 8E5, B6	SK-1583	BTK	
2.0	09/01-12/04	ALT	1984	23x150; ohne Spanndämpfer, Spannrolle; mit Zubehör	SK-1640	BTK	
2.0	09/01-12/04	ALT	1984	23x150; ohne Spanndämpfer, Spannrolle; mit Zubehör	SK-1640AQ2	BTKW	
2.0	09/01-12/04	ALT	1984	23x150; mit Zubehör	SK-1726	BTK	
2.0	09/01-12/04	ALT	1984	23x150; mit Zubehör	SK-1726AQ2	BTKW	
2.0 FSI	07/02-12/04	AWA	1984	23x145; ch.8E-3-390001→; 8E-4-400000; mit Zubehör	SK-1599	BTK	
2.0 FSI	07/02-12/04	AWA	1984	23x145; ch.8E-3-390001→; 8E-4-400000; mit Zubehör	SK-1599AQ1	BTKW	
2.0 FSI	07/02-12/04	AWA	1984	23x148; ch.8E-5-000 001→	SK-1606	BTK	
2.4	09/01-12/04	AMM, BDV	2393	30x253; mit Spanndämpfer, Spannrolle; mit Zubehör; Baumuster: 8E5, B6	SK-1377	BTK	
2.4	09/01-12/04	AMM, BDV	2393	30x253; mit Spanndämpfer, Spannrolle; mit Zubehör	SK-1377AQ1	BTKW	
2.4	09/01-12/04	AMM, BDV	2393	30x253; ohne Spanndämpfer, Spannrolle; mit Zubehör	SK-1383	BTK	
2.5 TDi	10/00-05/03	AKE, AYM	2496	30x207; 24x87; ohne Spanndämpfer, Spannrolle; mit Zubehör; Baumuster: 8E5, B6	SK-1619	BTK	
2.5 TDi	10/00-05/03	AKE, AYM	2496	30x207; 24x87; mit Spanndämpfer, Spannrolle; mit Zubehör; Baumuster: 8E5, B6	SK-1621	BTK	
2.5 TDI	07/02-12/04	BCZ, BDG, BFC	2496	30x207; 24x87; ohne Spanndämpfer, Spannrolle; mit Zubehör; Baumuster: 8E5, B6	SK-1619	BTK	
2.5 TDI	07/02-12/04	BCZ, BDG, BFC	2496	30x207; 24x87; mit Spanndämpfer, Spannrolle; mit Zubehör; Baumuster: 8E5, B6	SK-1621	BTK	
2.5 TDI quattro	09/01-12/04	AKE, BAU, BDH	2496	30x207; 24x87; ohne Spanndämpfer, Spannrolle; mit Zubehör; Baumuster: 8E5, B6	SK-1619	BTK	
2.5 TDI quattro	09/01-12/04	AKE, BAU, BDH	2496	30x207; 24x87; mit Spanndämpfer, Spannrolle; mit Zubehör; Baumuster: 8E5, B6	SK-1621	BTK	
2.5 TDi, 2.5 TDI quattro	10/00-12/04	AKE, AKE, BAU, BDH, AYM, BCZ, BDG, BFC	2496	32x207; 24x87; mit Spanndämpfer, Spannrolle; mit Zubehör	SK-1633AQ1	BTKW	
2.5 TDI, 2.5 TDI quattro	09/01-12/04	AKE, BAU, BDH, AYM, BCZ, BDG, BFC	2496	30x207; 24x87; nur in Verbindung mit: 078 121 113 F; mit Zubehör	SK-1619AQ2	BTKW	
2.5 TDI, 2.5 TDI quattro	09/01-12/04	AKE, BAU, BDH, AYM, BCZ, BDG, BFC	2496	30x207; 24x87; mit Spanndämpfer, Spannrolle; mit Zubehör	SK-1621AQ1	BTKW	
3.0, 3.0 quattro	04/01-12/04	ASN, ASN, AVK, BBJ	2976	30x281; ohne Spanndämpfer, Spannrolle	SK-1538	BTK	
3.0, 3.0 quattro	04/01-12/04	ASN, ASN, AVK, BBJ	2976	30x281; mit Spanndämpfer, Spannrolle	SK-1601	BTK	
1.6	09/01-12/04	ALZ	1595		0-N157	TB [TE]	
1.6	09/01-12/04	ALZ	1595	ch.→8E-1-000000	0-N1822	TB [BT]	S
1.8 T, 1.8 T quattro	09/01-12/04	AVJ, BEX, BFB	1781		0-N1050	TB [TE]	
1.8 T, 1.8 T quattro	09/01-12/04	AMB, AVJ, BEX, BFB	1781		0-N1051	TB [BT]	S
1.8 T, 1.8 T quattro	09/01-12/04	AMB, AVJ, BEX, BFB	1781		0-N1316	TB [DG]	
1.9 TDI	06/04-12/04	BKE	1896		0-N1045	TB [TE]	
1.9 TDI	06/04-12/04	BKE	1896		0-N1046	TB [DG]	
1.9 TDI, 1.9 TDI quattro	09/01-12/04	AVB, AVF, AVF, AWX	1896	ch.8E-2-297101→	0-N1045	TB [TE]	
1.9 TDI, 1.9 TDI quattro	09/01-12/04	AVB, AVF, AVF, AWX	1896	ch.8E-2-297101→	0-N1046	TB [DG]	
1.9 TDI, 1.9 TDI quattro	09/01-12/04	AVB, AVF, AVF, AWX	1896	ch.→8E-2-297100	0-N1048	TB [TE]	
1.9 TDI, 1.9 TDI quattro	09/01-12/04	AVB, AVF, AVF, AWX	1896	ch.→8E-2-297100	0-N1268	TB [DG]	
1.9 TDI, 1.9 TDI quattro	09/01-12/04	AVB, AVF, AVF, AWX	1896	ch.→8E-2-297100	0-N1274	TB [BT]	
2.0	09/01-12/04	ALT	1984		0-N1050	TB [TE]	
2.0	09/01-12/04	ALT	1984		0-N1051	TB [BT]	S



CM³



Art. Nr.



A4 Avant (8E5, B6)

2.0 FSI	07/02-12/04	AWA	1984	ch.8E-3-390001→	0-N1340	TB [TE]	
2.0 FSI	07/02-12/04	AWA	1984	ch.→8E-4-400000	0-N1341	TB [DG]	
2.0 FSI	07/02-12/04	AWA	1984	ch.8E-4-400001→	0-N1346	TB [DG]	
2.0 FSI	07/02-12/04	AWA	1984	ch.→8E-3-390 000	0-N1817	TB [BT]	S
2.0 FSI	07/02-12/04	AWA	1984	ch.→8E-3-390 000	0-N1818	TB [BT]	
2.0, 2.0 FSI	09/01-12/04	ALT, AWA	1984		0-N1316	TB [DG]	
2.4	09/01-12/04	AMM, BDV	2393		0-N1238	TB [TE]	
2.4	09/01-12/04	AMM, BDV	2393		0-N1275	TB [BT]	
2.4	09/01-12/04	AMM, BDV	2393		0-N1371	TB [TE]	
2.4	09/01-12/04	AMM, BDV	2393		0-N2001	TB [DG]	
2.5 TDi, 2.5 TDi quattro	10/00-12/04	AKE, AKE, BAU, BDH, AYM, BCZ, BDG, BFC	2496		0-N168	TB [DG]	
2.5 TDi, 2.5 TDi quattro	09/01-12/04	AKE, BAU, BDH, AYM, BCZ, BDG, BFC	2496		0-N1266	TB [TE]	
2.5 TDi, 2.5 TDi quattro	09/01-12/04	AKE, BAU, BDH, AYM, BCZ, BDG, BFC	2496		0-N1363	TB [TE]	
2.5 TDi, 2.5 TDi quattro	09/01-12/04	AKE, BAU, BDH, AYM, BCZ, BDG, BFC	2496		0-N1364	TB [BT]	
2.5 TDi, 2.5 TDi quattro	09/01-12/04	AKE, BAU, BDH, AYM, BCZ, BDG, BFC	2496		0-N201	TB [BT]	
3.0, 3.0 quattro	04/01-12/04	ASN, ASN, AVK, BBJ	2976		0-N1052	TB [DG]	
3.0, 3.0 quattro	04/01-12/04	ASN, ASN, AVK, BBJ	2976		0-N1053	TB [DG]	
3.0, 3.0 quattro	04/01-12/04	ASN, ASN, AVK, BBJ	2976		0-N1054	TB [TE]	
3.0, 3.0 quattro	04/01-12/04	ASN, ASN, AVK, BBJ	2976		0-N1342	TB [BT]	
1.6	09/01-12/04	ALZ	1595		0-N1662	VB [DG]	
1.6	09/01-12/04	ALZ	1595	ch.8E-1-000001→	0-N1671	VB [BT]	S
1.8 T, 1.8 T quattro	09/01-12/04	AMB, AVJ, BEX, BFB	1781		0-N1662	VB [DG]	
1.8 T, 1.8 T quattro	09/01-12/04	AMB, AVJ, BEX, BFB	1781		0-N1671	VB [BT]	S
1.9 TDi	09/01-12/04	AWX	1896	Rippenanzahl: 5	0-N1441	VB [BT]	S
1.9 TDi	09/01-12/04	AVF	1896	ch.8E-4-010001→;	0-N1534	VB [BT]	S
1.9 TDi	09/01-12/04	AVF	1896	ch.8E-4-000001→;	0-N1738	VB [DG]	
1.9 TDi	09/01-12/04	AWX	1896	ch.→8E-3-500000;	0-N2047	VB [DG]	
1.9 TDi	09/01-12/04	AWX	1896		0-N2139	VB [VD]	
1.9 TDi	11/01-12/04	CBAA	1896		0-N1534	VB [BT]	S
1.9 TDi	11/01-12/04	AVB	1896	ch.8E-4-000001→	0-N1738	VB [DG]	
1.9 TDi	11/01-12/04	AVB	1896	ch.→8E-3-500000	0-N2047	VB [DG]	
1.9 TDi	06/04-12/04	BKE	1896		0-N1534	VB [BT]	S
1.9 TDi	06/04-12/04	BKE	1896		0-N1738	VB [DG]	
1.9 TDi quattro	11/01-12/04	AVF	1896		0-N1534	VB [BT]	S
1.9 TDi quattro	11/01-12/04	AVF	1896	ch.8E-4-000001→;	0-N1738	VB [DG]	
1.9 TDi quattro	11/01-12/04	AVF	1896	ch.→8E-3-500000;	0-N2047	VB [DG]	
1.9 TDi, 1.9 TDi quattro	09/01-12/04	AVB, AVF, AVF, AWX	1896	Rippenanzahl: 4	0-N1317	VB [TE]	S
1.9 TDi, 1.9 TDi quattro	09/01-12/04	AVB, AVF, AVF, AWX	1896	ch.→8E-3-500000; Rippenanzahl: 5	0-N1441	VB [BT]	S
1.9 TDi, 1.9 TDi quattro	09/01-12/04	AVF, AVF, AWX	1896	ch.→8E-4-010000; Rippenanzahl: 5	0-N1441	VB [BT]	S
1.9 TDi, 1.9 TDi quattro	09/01-12/04	CBAA, CFGB	1896		0-N1534	VB [BT]	S
1.9 TDi, 1.9 TDi quattro	09/01-12/04	AVF, AVF, AWX	1896	ch.→8E-4-010000;	0-N2047	VB [DG]	
1.9 TDi, 1.9 TDi quattro	09/01-12/04	AVB, AVF, AVF, AWX	1896	ch.→8E-3-500000	0-N2139	VB [VD]	
1.9 TDi, 1.9 TDi quattro	09/01-12/04	AVF, AVF, AWX	1896	ch.→8E-4-010000	0-N2139	VB [VD]	
2.0, 2.0 FSI	09/01-12/04	ALT, AWA	1984		0-N1662	VB [DG]	
2.0, 2.0 FSI	09/01-12/04	ALT, AWA	1984		0-N1671	VB [BT]	S
2.4	09/01-12/04	AMM, BDV	2393		0-N1083	VB [BT]	S
2.5 TDi, 2.5 TDi quattro	10/00-12/04	AKE, AKE, BAU, BDH, AYM, BCZ, BDG, BFC	2496		0-N1308	VB [TE]	
2.5 TDi, 2.5 TDi quattro	10/00-12/04	AKE, AKE, BAU, BDH, AYM, BCZ, BDG, BFC	2496		0-N2258	VB [BT]	
2.5 TDi, 2.5 TDi quattro	10/00-12/04	AKE, AKE, BAU, BDH, AYM, BCZ, BDG, BFC	2496		0-N2417	VB [BT]	
2.5 TDi, 2.5 TDi quattro	09/01-12/04	AKE, BAU, BDH, AYM, BCZ, BDG, BFC	2496		0-N1005	VB [TE]	
2.5 TDi, 2.5 TDi quattro	09/01-12/04	AKE, BAU, BDH, AYM, BCZ, BDG, BFC	2496		0-N1315	VB [DG]	
2.5 TDi, 2.5 TDi quattro	09/01-12/04	AKE, BAU, BDH, AYM, BCZ, BDG, BFC	2496	Rippenanzahl: 6	0-N1431	VB [DG]	
2.5 TDi, 2.5 TDi quattro	09/01-12/04	AKE, BAU, BDH, AYM, BCZ, BDG, BFC	2496		0-N1947	VB [VD]	
2.5 TDi, 2.5 TDi quattro	09/01-12/04	AKE, BAU, BDH, AYM, BCZ, BDG, BFC	2496		0-N2196	VB [BT]	
3.0, 3.0 quattro	04/01-12/04	ASN, ASN, AVK, BBJ	2976		0-N1537	VB [BT]	S
3.0, 3.0 quattro	04/01-12/04	BBJ	2976	ch.8E-5-400001→	0-N2407	VB [BT]	S

A4 (8EC, B7)

1.6	11/04-06/08	ALZ	1595	23x138; Baumuster: 8EC, B7	SK-1109	BTK	
1.6	11/04-06/08	ALZ	1595	23x138	SK-1109AQ1	BTKW	
1.8 T, 1.8 T quattro	11/04-06/08	BFB	1781	23x150; ohne Spanndämpfer, Spannrolle; mit Zubehör	SK-1640	BTK	

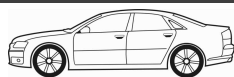

CM³



Art. Nr.



A4 (8EC, B7)

1.8 T, 1.8 T quattro	11/04-06/08	BFB	1781	23x150; ohne Spanndämpfer, Spannrolle; mit Zubehör	SK-1640AQ1	BTKW	
1.8 T, 1.8 T quattro	11/04-06/08	BFB	1781	23x150; mit Zubehör	SK-1726	BTK	
1.8 T, 1.8 T quattro	11/04-06/08	BFB	1781	23x150; mit Zubehör	SK-1726AQ1	BTKW	
1.9 TDI	11/04-06/08	BKE	1896	30x120; mit Zubehör	SK-1372	BTK	
1.9 TDI	11/04-06/08	BKE, BRB	1896	30x120	SK-1372AQ2	BTKW	
2.0	11/04-06/08	ALT	1984	23x150; ohne Spanndämpfer, Spannrolle; mit Zubehör	SK-1640	BTK	
2.0	11/04-06/08	ALT	1984	23x150; ohne Spanndämpfer, Spannrolle; mit Zubehör	SK-1640AQ2	BTKW	
2.0	11/04-06/08	ALT	1984	23x150; mit Zubehör	SK-1726	BTK	
2.0	11/04-06/08	ALT	1984	23x150; mit Zubehör	SK-1726AQ2	BTKW	
2.0 FSi	01/05-07/05	AWA	1984	23x145; ch.8E-3-390001→; 8E-4-400000; mit Zubehör	SK-1599	BTK	
2.0 TDI, 2.0 TDI 16V, 2.0 TDI quattro	11/04-06/08	BLB, BRE, BNA, BRB, BPW, BRD, BVA, BVF, BVG	1968	30x141; mit Zubehör	SK-1595	BTK	
2.0 TDI, 2.0 TDI 16V, 2.0 TDI quattro	11/04-06/08	BLB, BRE, BNA, BRB, BRD, BVA, BVF, BVG	1968	30x141; mit Zubehör	SK-1595AQ1	BTKW	
2.0 TDI, 2.0 TDI quattro	11/04-06/08	BPW	1968	30x120; mit Zubehör	SK-1372	BTK	
2.0 TDI, 2.0 TDI quattro	11/04-06/08	BPW	1968	30x120	SK-1372AQ2	BTKW	
2.0 TFSi, 2.0 TFSi quattro	11/04-06/08	BGB, BPG, BPG, BWE, BWT, BGB, BPG, BWE, BWT, BPJ, BYK, BUL	1984	23x148	SK-1724	BTK	
2.0 TFSi, 2.0 TFSi quattro	11/04-06/08	BGB, BPG, BPG, BWE, BWT, BGB, BPG, BWE, BWT, BPJ, BYK, BUL	1984	23x148	SK-1724AQ1	BTKW	
2.5 TDI	11/04-05/06	BDG	2496	30x207; 24x87; ohne Spanndämpfer, Spannrolle; mit Zubehör; Baumuster: 8EC, B7	SK-1619	BTK	
2.5 TDI	11/04-05/06	BDG	2496	30x207; 24x87; nur in Verbindung mit: 078 121 113 F; mit Zubehör	SK-1619AQ2	BTKW	
2.5 TDI	11/04-05/06	BDG	2496	30x207; 24x87; mit Spanndämpfer, Spannrolle; mit Zubehör; Baumuster: 8EC, B7	SK-1621	BTK	
2.5 TDI	11/04-05/06	BDG	2496	30x207; 24x87; mit Spanndämpfer, Spannrolle; mit Zubehör	SK-1621AQ1	BTKW	
2.5 TDI	11/04-05/06	BDG	2496	32x207; 24x87; mit Spanndämpfer, Spannrolle; mit Zubehör	SK-1633AQ1	BTKW	
2.7 TDI	11/05-06/08	BSG	2698	24x83; 03/2006 →; mit Zubehör	SK-1597	BTK	
2.7 TDI	01/06-06/08	BPP	2698	24x83; mit Zubehör	SK-1597	BTK	
3.0 TDI quattro	11/04-06/08	BKN	2967	24x83; mit Zubehör	SK-1597	BTK	
3.0 TDI quattro	01/06-06/08	ASB	2967	24x83; → 10/2007; mit Zubehör	SK-1597	BTK	
3.0, 3.0 quattro	11/04-07/06	BBJ	2976	30x281; ohne Spanndämpfer, Spannrolle	SK-1538	BTK	
3.0, 3.0 quattro	11/04-07/06	BBJ	2976	30x281; mit Spanndämpfer, Spannrolle	SK-1601	BTK	
1.6	11/04-06/08	ALZ	1595		0-N157	TB [TE]	
1.8 T, 1.8 T quattro	11/04-06/08	BFB	1781		0-N1050	TB [TE]	
1.8 T, 1.8 T quattro	11/04-06/08	BFB	1781		0-N1051	TB [BT]	S
1.8 T, 1.8 T quattro	11/04-06/08	BFB	1781		0-N1316	TB [DG]	
1.9 TDI	11/04-06/08	BKE, BRB	1896		0-N1045	TB [TE]	
1.9 TDI	11/04-06/08	BKE, BRB	1896		0-N1046	TB [DG]	
2.0	11/04-06/08	ALT	1984		0-N1050	TB [TE]	
2.0	11/04-06/08	ALT	1984		0-N1051	TB [BT]	S
2.0 FSi	01/05-07/05	AWA	1984		0-N1340	TB [TE]	
2.0 FSi, 2.0 TFSi, 2.0 TFSi quattro	11/04-06/08	AWA, BGB, BPG, BPG, BWE, BWT, BGB, BPG, BWE, BWT, BPJ, BYK, BUL	1984		0-N1346	TB [DG]	
2.0 TDI, 2.0 TDI 16V, 2.0 TDI quattro	11/04-06/08	BLB, BRE, BNA, BRB, BPW, BRD, BVA, BVF, BVG	1968		0-N1046	TB [DG]	
2.0 TDI, 2.0 TDI 16V, 2.0 TDI quattro	11/04-06/08	BLB, BRE, BNA, BRB, BRD, BVA, BVF, BVG	1968		0-N1335	TB [TE]	
2.0 TDI, 2.0 TDI 16V, 2.0 TDI quattro	11/04-06/08	BLB, BRE, BNA, BRB, BRD, BVA, BVF, BVG	1968		0-N1336	TB [DG]	
2.0 TDI, 2.0 TDI quattro	11/04-06/08	BPW	1968		0-N1045	TB [TE]	
2.0 TFSi, 2.0 TFSi quattro	11/04-06/08	BGB, BPG, BPG, BWE, BWT, BGB, BPG, BWE, BWT, BPJ, BYK, BUL	1984		0-N2208	TB [TE]	
2.0, 2.0 FSi, 2.0 TFSi, 2.0 TFSi quattro	11/04-06/08	ALT, AWA, BGB, BPG, BPG, BWE, BWT, BGB, BPG, BWE, BWT, BPJ, BYK, BUL	1984		0-N1316	TB [DG]	
2.5 TDI	11/04-05/06	BDG	2496		0-N1266	TB [TE]	
2.5 TDI	11/04-05/06	BDG	2496		0-N1363	TB [TE]	
2.5 TDI	11/04-05/06	BDG	2496		0-N1364	TB [BT]	
2.5 TDI	11/04-05/06	BDG	2496		0-N168	TB [DG]	
2.5 TDI	11/04-05/06	BDG	2496		0-N201	TB [BT]	
2.7 TDI	11/05-06/08	BPP, BSG	2698		0-N1337	TB [TE]	
3.0 quattro	11/04-07/06	BBJ	2976		0-N1053	TB [DG]	



CM³



Art. Nr.



A4 (8EC, B7)							
3.0 quattro	11/04-07/06	BBJ	2976			0-N1054	TB [TE]
3.0 TDI quattro	11/04-06/08	ASB, BKN	2967			0-N1337	TB [TE]
3.0, 3.0 quattro	11/04-07/06	BBJ	2976			0-N1052	TB [DG]
3.0, 3.0 quattro	11/04-07/06	BBJ	2976			0-N1342	TB [BT]
1.6	11/04-06/08	ALZ	1595			0-N1662	VB [DG]
1.6	11/04-06/08	ALZ	1595			0-N1671	VB [BT] S
1.8 T, 1.8 T quattro	11/04-06/08	BFB	1781			0-N1662	VB [DG]
1.8 T, 1.8 T quattro	11/04-06/08	BFB	1781			0-N1671	VB [BT] S
1.9 TDI	11/04-06/08	BKE, BRB	1896			0-N1534	VB [BT] S
1.9 TDI	11/04-06/08	BKE, BRB	1896			0-N1738	VB [DG]
2.0 TDI, 2.0 TDI 16V, 2.0 TDI quattro	11/04-06/08	BLB, BRE, BNA, BRF, BPW, BRD, BVA, BVF, BVG	1968			0-N1534	VB [BT] S
2.0 TDI, 2.0 TDI 16V, 2.0 TDI quattro	11/04-06/08	BLB, BRE, BNA, BRF, BPW, BRD, BVA, BVF, BVG	1968			0-N1738	VB [DG]
2.0, 2.0 FSi, 2.0 TFSI, 2.0 TFSI quattro	11/04-06/08	ALT, AWA, BGB, BPG, BPG, BWE, BWT, BGB, BPG, BWE, BWT, BPJ, BYK, BUL	1984			0-N1662	VB [DG]
2.0, 2.0 FSi, 2.0 TFSI, 2.0 TFSI quattro	11/04-06/08	ALT, AWA, BGB, BPG, BPG, BWE, BWT, BGB, BPG, BWE, BWT, BPJ, BYK, BUL	1984			0-N1671	VB [BT] S
2.5 TDI	11/04-05/06	BDG	2496			0-N1005	VB [TE]
2.5 TDI	11/04-05/06	BDG	2496			0-N1308	VB [TE]
2.5 TDI	11/04-05/06	BDG	2496			0-N1315	VB [DG]
2.5 TDI	11/04-05/06	BDG	2496	Rippenanzahl: 6		0-N1431	VB [DG]
2.5 TDI	11/04-05/06	BDG	2496			0-N1947	VB [VD]
2.5 TDI	11/04-05/06	BDG	2496			0-N2196	VB [BT]
2.5 TDI	11/04-05/06	BDG	2496			0-N2258	VB [BT]
2.5 TDI	11/04-05/06	BDG	2496			0-N2417	VB [BT]
2.7 TDI	11/05-06/08	BPP, BSG	2698	Rippenanzahl: 6		0-N1431	VB [DG]
2.7 TDI	11/05-06/08	BPP, BSG	2698			0-N1795	VB [DG]
2.7 TDI	11/05-06/08	BPP, BSG	2698	ch.8E-6-252205→		0-N1918	VB [BT] S
2.7 TDI	11/05-06/08	BPP, BSG	2698	ch.8E-5-400001→; 8E-6-252204		0-N1955	VB [BT] S
3.0	11/04-05/06	BBJ	2976			0-N1537	VB [BT] S
3.0 quattro	11/04-07/06	BBJ	2976	ch.→8E-5-400000		0-N1537	VB [BT] S
3.0 TDI quattro	11/04-06/08	ASB, BKN	2967	Rippenanzahl: 6		0-N1431	VB [DG]
3.0 TDI quattro	11/04-06/08	ASB, BKN	2967	ch.8E-5-580001→		0-N1795	VB [DG]
3.0 TDI quattro	11/04-06/08	ASB, BKN	2967	ch.→8E-5-580000		0-N1907	VB [DG]
3.0 TDI quattro	11/04-06/08	ASB, BKN	2967			0-N1918	VB [BT] S
3.0, 3.0 quattro	11/04-07/06	BBJ	2976	ch.8E-5-400001→		0-N2407	VB [BT] S
3.2 FSi, 3.2 FSi quattro	01/05-06/08	AUK, AUK, BKH	3123			0-N1830	VB [BT] S
3.2 FSi, 3.2 FSi quattro	01/05-06/08	AUK, AUK, BKH	3123			0-N2199	VB [DG]
A4 Avant (8ED, B7)							
1.6	11/04-06/08	ALZ	1595	23x138; Baumuster: 8ED, B7		SK-1109	BTK
1.6	11/04-06/08	ALZ	1595	23x138		SK-1109AQ1	BTKW
1.8 T, 1.8 T quattro	11/04-06/08	BFB	1781	23x150; ohne Spanndämpfer, Spannrolle; mit Zubehör		SK-1640	BTK
1.8 T, 1.8 T quattro	11/04-06/08	BFB	1781	23x150; ohne Spanndämpfer, Spannrolle; mit Zubehör		SK-1640AQ1	BTKW
1.8 T, 1.8 T quattro	11/04-06/08	BFB	1781	23x150; mit Zubehör		SK-1726	BTK
1.8 T, 1.8 T quattro	11/04-06/08	BFB	1781	23x150; mit Zubehör		SK-1726AQ1	BTKW
1.9 TDI	11/04-06/08	BKE	1896	30x120; mit Zubehör		SK-1372	BTK
1.9 TDI	11/04-06/08	BKE, BRB	1896	30x120		SK-1372AQ2	BTKW
2.0	11/04-06/08	ALT	1984	23x150; ohne Spanndämpfer, Spannrolle; mit Zubehör		SK-1640	BTK
2.0	11/04-06/08	ALT	1984	23x150; ohne Spanndämpfer, Spannrolle; mit Zubehör		SK-1640AQ2	BTKW
2.0	11/04-06/08	ALT	1984	23x150; mit Zubehör		SK-1726	BTK
2.0	11/04-06/08	ALT	1984	23x150; mit Zubehör		SK-1726AQ2	BTKW
2.0 FSi	01/05-07/05	AWA	1984	23x145; ch.8E-3-390001→; 8E-4-400000; mit Zubehör		SK-1599	BTK
2.0 TDI, 2.0 TDI 16V, 2.0 TDI quattro	11/04-06/08	BLB, BRE, BNA, BRF, BPW, BRD, BVA, BVF, BVG	1968	30x141; mit Zubehör		SK-1595	BTK
2.0 TDI, 2.0 TDI 16V, 2.0 TDI quattro	11/04-06/08	BLB, BRE, BNA, BRF, BRD, BVA, BVF, BVG	1968	30x141; mit Zubehör		SK-1595AQ1	BTKW
2.0 TDI, 2.0 TDI quattro	11/04-06/08	BPW	1968	30x120; mit Zubehör		SK-1372	BTK
2.0 TDI, 2.0 TDI quattro	11/04-06/08	BPW	1968	30x120		SK-1372AQ2	BTKW
2.0 TFSI, 2.0 TFSI quattro	11/04-06/08	BGB, BWE, BGB, BWE, BWT, BPJ, BYK, BUL	1984	23x148		SK-1724	BTK
2.0 TFSI, 2.0 TFSI quattro	11/04-06/08	BGB, BWE, BGB, BWE, BWT, BPJ, BYK, BUL	1984	23x148		SK-1724AQ1	BTKW



CM³



Art. Nr.



A4 Avant (8ED, B7)

2.5 TDI	11/04-05/06	BDG	2496	30x207; 24x87; ohne Spanndämpfer, Spannrolle; mit Zubehör; Baumuster: 8ED, B7	SK-1619	BTK	
2.5 TDI	11/04-05/06	BDG	2496	30x207; 24x87; nur in Verbindung mit: 078 121 113 F; mit Zubehör	SK-1619AQ2	BTKW	
2.5 TDI	11/04-05/06	BDG	2496	30x207; 24x87; mit Spanndämpfer, Spannrolle; mit Zubehör; Baumuster: 8ED, B7	SK-1621	BTK	
2.5 TDI	11/04-05/06	BDG	2496	30x207; 24x87; mit Spanndämpfer, Spannrolle; mit Zubehör	SK-1621AQ1	BTKW	
2.5 TDI	11/04-05/06	BDG	2496	32x207; 24x87; mit Spanndämpfer, Spannrolle; mit Zubehör	SK-1633AQ1	BTKW	
2.7 TDi	11/05-03/08	BSG	2698	24x83; 03/2006 →; mit Zubehör	SK-1597	BTK	
2.7 TDI	01/06-06/08	BPP	2698	24x83; mit Zubehör	SK-1597	BTK	
3.0 TDI quattro	11/04-06/08	BKN	2967	24x83; mit Zubehör	SK-1597	BTK	
3.0 TDI quattro	01/06-06/08	ASB	2967	24x83; → 03/2008; mit Zubehör	SK-1597	BTK	
3.0, 3.0 quattro	11/04-07/06	BBJ	2976	30x281; ohne Spanndämpfer, Spannrolle	SK-1538	BTK	
3.0, 3.0 quattro	11/04-07/06	BBJ	2976	30x281; mit Spanndämpfer, Spannrolle	SK-1601	BTK	
1.6	11/04-06/08	ALZ	1595		0-N157	TB [TE]	
1.8 T, 1.8 T quattro	11/04-06/08	BFB	1781		0-N1050	TB [TE]	
1.8 T, 1.8 T quattro	11/04-06/08	BFB	1781		0-N1051	TB [BT]	S
1.8 T, 1.8 T quattro	11/04-06/08	BFB	1781		0-N1316	TB [DG]	
1.9 TDI	11/04-06/08	BKE, BRB	1896		0-N1045	TB [TE]	
1.9 TDI	11/04-06/08	BKE, BRB	1896		0-N1046	TB [DG]	
2.0	11/04-06/08	ALT	1984		0-N1050	TB [TE]	
2.0	11/04-06/08	ALT	1984		0-N1051	TB [BT]	S
2.0 FSi	01/05-07/05	AWA	1984		0-N1340	TB [TE]	
2.0 FSi, 2.0 TFSI, 2.0 TFSI quattro	11/04-06/08	AWA, BGB, BWE, BGB, BWE, BWT, BPJ, BYK, BUL	1984		0-N1346	TB [DG]	
2.0 TDI, 2.0 TDI 16V, 2.0 TDI quattro	11/04-06/08	BLB, BRE, BNA, BRF, BPW, BRD, BVA, BVF, BVG	1968		0-N1046	TB [DG]	
2.0 TDI, 2.0 TDI 16V, 2.0 TDI quattro	11/04-06/08	BLB, BRE, BNA, BRF, BRD, BVA, BVF, BVG	1968		0-N1335	TB [TE]	
2.0 TDI, 2.0 TDI 16V, 2.0 TDI quattro	11/04-06/08	BLB, BRE, BNA, BRF, BRD, BVA, BVF, BVG	1968		0-N1336	TB [DG]	
2.0 TDI, 2.0 TDI quattro	11/04-06/08	BPW	1968		0-N1045	TB [TE]	
2.0 TFSI, 2.0 TFSI quattro	11/04-06/08	BGB, BWE, BGB, BWE, BWT, BPJ, BYK, BUL	1984		0-N2208	TB [TE]	
2.0, 2.0 FSi, 2.0 TFSI, 2.0 TFSI quattro	11/04-06/08	ALT, AWA, BGB, BWE, BGB, BWE, BWT, BPJ, BYK, BUL	1984		0-N1316	TB [DG]	
2.5 TDI	11/04-05/06	BDG	2496		0-N1266	TB [TE]	
2.5 TDI	11/04-05/06	BDG	2496		0-N1363	TB [TE]	
2.5 TDI	11/04-05/06	BDG	2496		0-N1364	TB [BT]	
2.5 TDI	11/04-05/06	BDG	2496		0-N168	TB [DG]	
2.5 TDI	11/04-05/06	BDG	2496		0-N201	TB [BT]	
2.7 TDI	11/05-06/08	BPP, BSG	2698		0-N1337	TB [TE]	
3.0 TDI quattro	11/04-06/08	ASB, BKN	2967		0-N1337	TB [TE]	
3.0, 3.0 quattro	11/04-07/06	BBJ	2976		0-N1052	TB [DG]	
3.0, 3.0 quattro	11/04-07/06	BBJ	2976		0-N1053	TB [DG]	
3.0, 3.0 quattro	11/04-07/06	BBJ	2976		0-N1054	TB [TE]	
3.0, 3.0 quattro	11/04-07/06	BBJ	2976		0-N1342	TB [BT]	
1.6	11/04-06/08	ALZ	1595		0-N1662	VB [DG]	
1.6	11/04-06/08	ALZ	1595		0-N1671	VB [BT]	S
1.8 T, 1.8 T quattro	11/04-06/08	BFB	1781		0-N1662	VB [DG]	
1.8 T, 1.8 T quattro	11/04-06/08	BFB	1781		0-N1671	VB [BT]	S
1.9 TDI	11/04-06/08	BKE, BRB	1896		0-N1534	VB [BT]	S
1.9 TDI	11/04-06/08	BKE, BRB	1896		0-N1738	VB [DG]	
2.0 TDI, 2.0 TDI 16V, 2.0 TDI quattro	11/04-06/08	BLB, BRE, BNA, BRF, BPW, BRD, BVA, BVF, BVG	1968		0-N1534	VB [BT]	S
2.0 TDI, 2.0 TDI 16V, 2.0 TDI quattro	11/04-06/08	BLB, BRE, BNA, BRF, BPW, BRD, BVA, BVF, BVG	1968		0-N1738	VB [DG]	
2.0, 2.0 FSi, 2.0 TFSI, 2.0 TFSI quattro	11/04-06/08	ALT, AWA, BGB, BWE, BGB, BWE, BWT, BPJ, BYK, BUL	1984		0-N1662	VB [DG]	
2.0, 2.0 FSi, 2.0 TFSI, 2.0 TFSI quattro	11/04-06/08	ALT, AWA, BGB, BWE, BGB, BWE, BWT, BUL	1984		0-N1671	VB [BT]	S
2.5 TDI	11/04-05/06	BDG	2496		0-N1005	VB [TE]	
2.5 TDI	11/04-05/06	BDG	2496		0-N1308	VB [TE]	
2.5 TDI	11/04-05/06	BDG	2496		0-N1315	VB [DG]	
2.5 TDI	11/04-05/06	BDG	2496	Rippenanzahl: 6	0-N1431	VB [DG]	
2.5 TDI	11/04-05/06	BDG	2496		0-N1947	VB [VD]	



CM³



Art. Nr.



ohne Halter

A4 Avant (8ED, B7)							
2.5 TDI	11/04-05/06	BDG	2496			0-N2196	VB [BT]
2.5 TDI	11/04-05/06	BDG	2496			0-N2258	VB [BT]
2.5 TDI	11/04-05/06	BDG	2496			0-N2417	VB [BT]
2.7 TDI	11/05-06/08	BPP, BSG	2698			0-N1795	VB [DG]
2.7 TDI	11/05-06/08	BPP, BSG	2698	ch.8E-6-252205→		0-N1918	VB [BT] S
2.7 TDI	11/05-06/08	BPP, BSG	2698	ch.8E-5-400001→; 8E-6-252204		0-N1955	VB [BT] S
2.7 TDI	01/06-06/08	BPP	2698	Rippenanzahl: 6		0-N1431	VB [DG]
3.0 TDI quattro	11/04-06/08	ASB, BKN	2967	Rippenanzahl: 6		0-N1431	VB [DG]
3.0 TDI quattro	11/04-06/08	ASB, BKN	2967	ch.8E-5-580001→		0-N1795	VB [DG]
3.0 TDI quattro	11/04-06/08	ASB, BKN	2967	ch.→8E-5-580000		0-N1907	VB [DG]
3.0 TDI quattro	11/04-06/08	ASB, BKN	2967	ch.8E-5-400001→		0-N1918	VB [BT] S
3.0, 3.0 quattro	11/04-07/06	BBJ	2976	ch.→8E-5-400000		0-N1537	VB [BT] S
3.0, 3.0 quattro	11/04-07/06	BBJ	2976	ch.8E-5-400001→		0-N2407	VB [BT] S
3.2 FSI, 3.2 FSI quattro	01/05-06/08	AUK	3123			0-N1830	VB [BT] S
3.2 FSI, 3.2 FSI quattro	01/05-06/08	AUK	3123			0-N2199	VB [DG]
A4 Cabriolet (8H7, B6, 8HE, B7)							
1.8 T, 1.8 T quattro	07/02-03/09	BFB	1781	23x150; ohne Spanndämpfer, Spannrolle; mit Zubehör		SK-1640	BTK
1.8 T, 1.8 T quattro	07/02-03/09	BFB	1781	23x150; ohne Spanndämpfer, Spannrolle; mit Zubehör		SK-1640AQ1	BTKW
1.8, 1.8 T, 1.8 T quattro	07/02-03/09	AMB, BFB	1781	23x150; mit Zubehör		SK-1726	BTK
1.8, 1.8 T, 1.8 T quattro	07/02-03/09	AMB, BFB	1781	23x150; mit Zubehör		SK-1726AQ1	BTKW
2.0	09/04-12/05	ALT	1984	23x150; ohne Spanndämpfer, Spannrolle; mit Zubehör		SK-1640	BTK
2.0	09/04-12/05	ALT	1984	23x150; ohne Spanndämpfer, Spannrolle; mit Zubehör		SK-1640AQ2	BTKW
2.0	09/04-12/05	ALT	1984	23x150; mit Zubehör		SK-1726	BTK
2.0	09/04-12/05	ALT	1984	23x150; mit Zubehör		SK-1726AQ2	BTKW
2.0 TDI	01/06-03/09	BPW, BRC	1968	30x120; mit Zubehör		SK-1372	BTK
2.0 TDI	01/06-03/09	BPW, BRC	1968	30x120		SK-1372AQ2	BTKW
2.0 TFSI 16V	01/06-03/09	BWE, BWT	1984	23x148		SK-1724	BTK
2.0 TFSI 16V	01/06-03/09	BWE, BWT	1984	23x148		SK-1724AQ1	BTKW
2.4	04/02-12/05	AMM, BDV	2393	30x253; mit Spanndämpfer, Spannrolle; mit Zubehör; Baumuster: 8H7, B6		SK-1377	BTK
2.4	04/02-12/05	AMM, BDV	2393	30x253; mit Spanndämpfer, Spannrolle; mit Zubehör		SK-1377AQ1	BTKW
2.4	04/02-12/05	AMM, BDV	2393	30x253; ohne Spanndämpfer, Spannrolle; mit Zubehör		SK-1383	BTK
2.5 TDI	08/02-12/05	BCZ, BDG, BFC	2496	30x207; 24x87; ohne Spanndämpfer, Spannrolle; mit Zubehör; Baumuster: 8H7, B6		SK-1619	BTK
2.5 TDI	08/02-12/05	BCZ, BDG, BFC	2496	30x207; 24x87; nur in Verbindung mit: 078 121 113 F; mit Zubehör		SK-1619AQ2	BTKW
2.5 TDI	08/02-12/05	BCZ, BDG, BFC	2496	30x207; 24x87; mit Spanndämpfer, Spannrolle; mit Zubehör; Baumuster: 8H7, B6		SK-1621	BTK
2.5 TDI	08/02-12/05	BCZ, BDG, BFC	2496	30x207; 24x87; mit Spanndämpfer, Spannrolle; mit Zubehör		SK-1621AQ1	BTKW
2.5 TDI	08/02-12/05	BCZ, BDG, BFC	2496	32x207; 24x87; mit Spanndämpfer, Spannrolle; mit Zubehör		SK-1633AQ1	BTKW
2.7 TDI	06/06-03/09	BPP	2698	24x83; mit Zubehör		SK-1597	BTK
3.0 TDI quattro	01/06-03/09	ASB, BKN	2967	24x83; mit Zubehör		SK-1597	BTK
3.0, 3.0 quattro	04/02-12/05	ASN	2976	30x281; ohne Spanndämpfer, Spannrolle		SK-1538	BTK
3.0, 3.0 quattro	04/02-12/05	ASN	2976	30x281; mit Spanndämpfer, Spannrolle		SK-1601	BTK
1.8 T, 1.8 T quattro	07/02-03/09	BFB	1781			0-N1050	TB [TE]
1.8 T, 1.8 T quattro	07/02-03/09	BFB	1781			0-N1051	TB [BT] S
1.8, 1.8 T, 1.8 T quattro	07/02-03/09	AMB, BFB	1781			0-N1316	TB [DG]
2.0	09/04-12/05	ALT	1984			0-N1050	TB [TE]
2.0	09/04-12/05	ALT	1984	Spannrollenbetätigung: automatisch		0-N2195	TB [TE]
2.0	09/04-12/05	ALT	1984			0-N2234	TB [DG]
2.0 TDI	01/06-03/09	BPW, BRC	1968			0-N1045	TB [TE]
2.0 TDI	01/06-03/09	BPW, BRC	1968			0-N1046	TB [DG]
2.0 TFSI 16V, 2.0 TFSI quattro	11/05-03/09	BWE, BWT, BWT	1984			0-N2208	TB [TE]
2.0, 2.0 TFSI 16V, 2.0 TFSI quattro	09/04-03/09	ALT, BWE, BWE, BWT, BWT	1984			0-N1316	TB [DG]
2.0, 2.0 TFSI 16V, 2.0 TFSI quattro	11/05-03/09	BWE, BWE, BWT, BWT	1984			0-N1346	TB [DG]
2.4	04/02-12/05	AMM, BDV	2393			0-N1238	TB [TE]
2.4	04/02-12/05	AMM, BDV	2393			0-N1275	TB [BT]
2.4	04/02-12/05	AMM, BDV	2393			0-N1371	TB [TE]
2.4	04/02-12/05	AMM, BDV	2393			0-N2001	TB [DG]

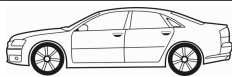

CM³



Art. Nr.



A4 Cabriolet (8H7, B6, 8HE, B7)

2.5 TDI	08/02-12/05	BCZ, BDG, BFC	2496		0-N1266	TB [TE]	
2.5 TDI	08/02-12/05	BCZ, BDG, BFC	2496		0-N1363	TB [TE]	
2.5 TDI	08/02-12/05	BCZ, BDG, BFC	2496		0-N1364	TB [BT]	
2.5 TDI	08/02-12/05	BCZ, BDG, BFC	2496		0-N168	TB [DG]	
2.5 TDI	08/02-12/05	BCZ, BDG, BFC	2496		0-N201	TB [BT]	
2.7 TDI	06/06-03/09	BPP	2698		0-N1337	TB [TE]	
3.0 TDI quattro	01/06-03/09	ASB, BKN	2967		0-N1337	TB [TE]	
3.0, 3.0 quattro	04/02-12/05	ASN	2976		0-N1052	TB [DG]	
3.0, 3.0 quattro	04/02-12/05	ASN	2976		0-N1053	TB [DG]	
3.0, 3.0 quattro	04/02-12/05	ASN	2976		0-N1054	TB [TE]	
3.0, 3.0 quattro	04/02-12/05	ASN	2976		0-N1342	TB [BT]	
1.8 T, 1.8 T quattro	07/02-03/09	BFB	1781		0-N1662	VB [DG]	
1.8, 1.8 T, 1.8 T quattro	07/02-03/09	AMB, BFB	1781		0-N1671	VB [BT]	S
2.0 TDI	01/06-03/09	BPW, BRC	1968		0-N1534	VB [BT]	S
2.0 TDI	01/06-03/09	BPW, BRC	1968		0-N1738	VB [DG]	
2.0, 2.0 TFSI 16V	09/04-03/09	ALT, BWE, BWT	1984		0-N1662	VB [DG]	
2.0, 2.0 TFSI 16V, 2.0 TFSi quattro	09/04-03/09	ALT, BWE, BWE, BWT, BWT	1984		0-N1671	VB [BT]	S
2.4	04/02-12/05	AMM, BDV	2393		0-N1083	VB [BT]	S
2.5 TDI	08/02-12/05	BCZ, BDG, BFC	2496		0-N1005	VB [TE]	
2.5 TDI	08/02-12/05	BCZ, BDG, BFC	2496		0-N1308	VB [TE]	
2.5 TDI	08/02-12/05	BCZ, BDG, BFC	2496		0-N1315	VB [DG]	
2.5 TDI	08/02-12/05	BCZ, BDG, BFC	2496	Rippenanzahl: 6	0-N1431	VB [DG]	
2.5 TDI	08/02-12/05	BCZ, BDG, BFC	2496		0-N1947	VB [VD]	
2.5 TDI	08/02-12/05	BCZ, BDG, BFC	2496		0-N2196	VB [BT]	
2.5 TDI	08/02-12/05	BCZ, BDG, BFC	2496		0-N2258	VB [BT]	
2.5 TDI	08/02-12/05	BCZ, BDG, BFC	2496		0-N2417	VB [BT]	
2.7 TDI	06/06-03/09	BPP	2698	Rippenanzahl: 6	0-N1431	VB [DG]	
2.7 TDI	06/06-03/09	BPP	2698		0-N1795	VB [DG]	
2.7 TDI	06/06-03/09	BPP	2698	ch.8E-6-252205→	0-N1918	VB [BT]	S
2.7 TDI	06/06-03/09	BPP	2698	ch.8E-5-400001→; 8E-6-252204	0-N1955	VB [BT]	S
3.0 TDI quattro	01/06-03/09	ASB, BKN	2967	Rippenanzahl: 6	0-N1431	VB [DG]	
3.0 TDI quattro	01/06-03/09	ASB, BKN	2967		0-N1795	VB [DG]	
3.0 TDI quattro	01/06-03/09	ASB, BKN	2967		0-N1918	VB [BT]	S
3.0, 3.0 quattro	04/02-12/05	ASN	2976		0-N1537	VB [BT]	S
3.2 FSI, 3.2 FSI quattro	01/06-03/09	AUK	3123		0-N1830	VB [BT]	S
3.2 FSI, 3.2 FSI quattro	01/06-03/09	AUK	3123		0-N2199	VB [DG]	

A4 (8K2, B8)

2.0 TDI	11/07-12/15	CAGA, CMEA	1968	30x160	SK-1694	BTK	
2.0 TDI	11/07-12/15	CAGB	1968	30x160	SK-1694	BTK	
2.0 TDI	11/07-12/15	CAGB, CMEA	1968	30x160	SK-1694AQ1	BTKW	
2.0 TDI	11/07-12/15	CJCA, CMFA	1968	25x160	SK-1695	BTK	
2.0 TDI	11/07-12/15	CJCB	1968	25x160	SK-1695	BTK	
2.0 TDI	11/07-12/15	CJCA, CMFA	1968	25x160	SK-1695AQ1	BTKW	
2.0 TDI	11/07-12/15	CJCB	1968	25x160	SK-1695AQ1	BTKW	
2.0 TDI	06/08-12/15	CAGC	1968	30x160	SK-1694	BTK	
2.0 TDI	06/08-12/15	CAGC, CMEA	1968	30x160	SK-1694AQ1	BTKW	
2.0 TDI	06/08-12/15	CJCC	1968	25x160	SK-1695	BTK	
2.0 TDI	06/08-12/15	CJCC	1968	25x160	SK-1695AQ1	BTKW	
2.0 TDI	08/08-12/15	CAHB	1968	30x160	SK-1694	BTK	
2.0 TDI	08/08-12/15	CAHB	1968	30x160	SK-1694AQ2	BTKW	
2.0 TDI	08/08-12/15	CGLD	1968	25x160	SK-1695	BTK	
2.0 TDI	08/08-12/15	CGLD	1968	25x160	SK-1695AQ1	BTKW	
2.0 TDI	11/11-12/15	CGLC, CMGB	1968	25x160	SK-1727AQ2	BTKW	
2.0 TDI	05/13-12/15	CJCD, CMFB	1968	25x160	SK-1695AQ1	BTKW	
2.0 TDi quattro	01/08-03/12	CAHA	1968	30x160; 08/2008 → 03/2012	SK-1694	BTK	
2.0 TDI quattro	11/08-12/15	CJCA	1968	25x160; 05/2009 →	SK-1695	BTK	
2.0 TDI quattro	11/08-12/15	CJCA	1968	25x160	SK-1695AQ1	BTKW	
2.0 TDI, 2.0 TDI quattro	11/07-12/15	CAGA, CMEA	1968	30x160	SK-1694AQ1	BTKW	
2.0 TDI, 2.0 TDI quattro	11/07-12/15	CJCA, CJCB, CJCC, CMFA	1968	25x160	SK-1727AQ2	BTKW	
2.0 TDI, 2.0 TDI quattro	01/08-12/15	CAGA, CJCA, CAHA	1968	30x160; → 03/2012	SK-1694	BTK	
2.0 TDI, 2.0 TDI quattro	01/08-03/12	CAHA	1968	30x160	SK-1694AQ2	BTKW	
2.0 TDI, 2.0 TDI quattro	08/08-12/15	CGLC, CGLD	1968	25x160	SK-1727AQ2	BTKW	
2.0 TDI, 2.0 TDI quattro	11/11-12/15	CGLC, CGLC, CMGB, CJCD, CSUA	1968	25x160	SK-1695AQ1	BTKW	
2.0 TDI, 2.0 TDI quattro	05/13-12/15	CJCD, CMFB, CSUA, CJCD, CSUA	1968	25x160	SK-1695	BTK	



CM³



Art. Nr.



A4 (8K2, B8)							
2.7 TDI	11/07-03/12	CAMA, CGKA, CAME, CGKB	2698	24x83; ch.→8K-8A040982; → 03/2012; mit Zubehör	SK-1597	BTK	
2.7 TDI	11/07-03/12	CAMA, CGKA, CAME, CGKB	2698	24x83; ch.→8K-8N022419; → 03/2012; mit Zubehör	SK-1597	BTK	
2.7 TDI	11/07-03/12	CAMA, CGKA, CAME, CGKB	2698	24x82; ch.8K-8A040983, 8K-8N022420→	SK-1720	BTK	
2.7 TDI	11/07-03/12	CAMA, CGKA, CAME, CGKB	2698	24x83; ch.→8K-8A040982, 8K-8N022419	SK-1743	BTK	
3.0 TDI quattro	11/07-03/12	CAPA, CCLA, CCWA	2967	24x82; ch.8K-8A040983, 8K-8N022420→	SK-1720	BTK	
3.0 TDI quattro	11/07-03/12	CAPA	2967	24x83; ch.→8K-8A040982, 8K-8N022419	SK-1743	BTK	
3.0 TDI quattro	06/08-05/10	CCWB	2967	24x82	SK-1720	BTK	
3.0 TDI quattro	06/08-05/10	CCWB	2967	24x82	SK-1729	BTK	
2.0 TDI	11/07-12/15	CAGB	1968		0-N1046	TB [DG]	
2.0 TDI	11/07-12/15	CJCB	1968	→ 11/2010	0-N1046	TB [DG]	
2.0 TDI	11/07-12/15	CAGB	1968		0-N1268	TB [DG]	
2.0 TDI	11/07-12/15	CJCB	1968		0-N131	TB [DG]	
2.0 TDI	11/07-12/15	CAGB	1968		0-N1336	TB [DG]	
2.0 TDI	11/07-12/15	CAGB	1968		0-N1905	TB [BT]	
2.0 TDI	11/07-12/15	CJCB	1968		0-N2025	TB [DG]	
2.0 TDI	11/07-12/15	CJCB	1968		0-N2061	TB [TE]	
2.0 TDI	11/07-12/15	CJCA	1968		0-N2200	TB [DG]	
2.0 TDI	11/07-12/15	CJCB	1968	12/2010 →	0-N2200	TB [DG]	
2.0 TDI	06/08-12/15	CJCC	1968		0-N131	TB [DG]	
2.0 TDI	06/08-12/15	CJCC	1968		0-N2200	TB [DG]	
2.0 TDI	08/08-12/15	CAHB	1968		0-N1046	TB [DG]	
2.0 TDI	08/08-12/15	CAHB	1968		0-N1268	TB [DG]	
2.0 TDI	08/08-12/15	CGLD	1968		0-N131	TB [DG]	
2.0 TDI	08/08-12/15	CAHB	1968		0-N1336	TB [DG]	
2.0 TDI	08/08-12/15	CAHB	1968		0-N1905	TB [BT]	
2.0 TDI	08/08-12/15	CGLD	1968		0-N2061	TB [TE]	
2.0 TDI	08/08-12/15	CGLD	1968		0-N2200	TB [DG]	
2.0 TDI quattro	11/08-12/15	CJCA	1968	12/2010 →	0-N2200	TB [DG]	
2.0 TDI, 2.0 TDI quattro	11/07-12/15	CAGA, CJCA, CAGA, CJCA, CMEA, CMFA, CAGC, CJCC, CAHA	1968		0-N1046	TB [DG]	
2.0 TDI, 2.0 TDI quattro	11/07-12/15	CAGA, CJCA, CAGA, CJCA, CMEA, CMFA, CAGC, CJCC, CAHA	1968		0-N1268	TB [DG]	
2.0 TDI, 2.0 TDI quattro	11/07-12/15	CJCA	1968		0-N131	TB [DG]	
2.0 TDI, 2.0 TDI quattro	11/07-12/15	CAGA, CJCA, CAGA, CJCA, CMEA, CMFA, CAGC, CJCC, CAHA	1968		0-N1336	TB [DG]	
2.0 TDI, 2.0 TDI quattro	11/07-12/15	CAGA, CJCA, CAGA, CJCA, CMEA, CMFA, CAGC, CJCC, CAHA	1968		0-N1905	TB [BT]	
2.0 TDI, 2.0 TDI quattro	11/11-12/15	CGLC, CGLC, CMGB, CJCD, CMFB, CSUA, CJCD, CSUA, CNHA	1968		0-N131	TB [DG]	
2.0 TDI, 2.0 TDI quattro	11/11-12/15	CGLC, CGLC, CMGB	1968		0-N2061	TB [TE]	
2.0 TDI, 2.0 TDI quattro	11/11-12/15	CGLC, CGLC, CMGB	1968		0-N2200	TB [DG]	
2.0 TDI, 2.0 TDI quattro	09/13-12/15	CNHA	1968		0-N2314	TB [TE]	
2.7 TDI	11/07-03/12	CAMA, CGKA, CAME, CGKB	2698		0-N1337	TB [TE]	
3.0 TDI quattro	11/07-03/12	CCLA	2967		0-N131	TB [DG]	
3.0 TDI quattro	11/07-03/12	CAPA, CCLA, CCWA, CCWB	2967		0-N1337	TB [TE]	
1.8 TFSI, 1.8 TFSI quattro	11/07-12/15	CABA, CDHA, CABB, CCUA, CDHB, CDHB	1798	→ 10/2010	0-N2026	VB [TE]	S
1.8 TFSI, 1.8 TFSI quattro	11/07-12/15	CABA, CDHA, CABB, CCUA, CDHB, CDHB	1798	→ 10/2010	0-N2027	VB [DG]	
2.0 TDI	11/07-12/15	CAGA, CMEA	1968		0-N1738	VB [DG]	
2.0 TDI	11/07-12/15	CJCA	1968		0-N1907	VB [DG]	
2.0 TDI	06/08-12/15	CJCC	1968		0-N1907	VB [DG]	
2.0 TDI	08/08-12/15	CAHB	1968		0-N1738	VB [DG]	
2.0 TDI	08/08-12/15	CGLD	1968		0-N1907	VB [DG]	
2.0 TDI quattro	11/08-12/15	CAGA	1968		0-N1738	VB [DG]	
2.0 TDI, 2.0 TDI quattro	11/07-12/15	CAGA, CJCA, CMEA, CMFA, CAGC, CJCC, CAHA, CAHB, CGLD, CNHC, CGLC, CGLC, CMGB, CJCD, CMFB, CSUA, CJCD, CSUA	1968		0-N1534	VB [BT]	S
2.0 TDI, 2.0 TDI quattro	11/07-12/15	CBAA	1968		0-N1534	VB [BT]	S
2.0 TDI, 2.0 TDI quattro	11/07-12/15	CAGB, CJCB, CSUB, CAGC, CJCC, CAHA	1968		0-N1738	VB [DG]	
2.0 TDI, 2.0 TDI quattro	11/08-12/15	CAGA, CJCA, CGLC, CGLC, CMGB	1968		0-N1907	VB [DG]	
2.0 TDI, 2.0 TDI quattro	09/13-12/15	CNHA	1968		0-N2288	VB [BT]	S
2.0 TFSI flexible fuel, 2.0 TFSI flexible fuel quattro	11/09-12/15	CFKA	1984		0-N2026	VB [TE]	S
2.0 TFSI flexible fuel, 2.0 TFSI flexible fuel quattro	11/09-12/15	CFKA	1984		0-N2027	VB [DG]	
2.0 TFSI, 2.0 TFSI quattro	06/08-12/15	CAEA, CDNB, CFKA, CAEB, CAEB, CDNC, CAEB, CDNC, CPMA	1984	→ 10/2010	0-N2026	VB [TE]	S



CM³



Art. Nr.



A4 (8K2, B8)

2.0 TFSI, 2.0 TFSI quattro	06/08-12/15	CAEA, CDNB, CFKA, CAEB, CAEB, CDNC, CAEB, CDNC, CPMA	1984	→ 10/2010	0-N2027	VB [DG]	
2.7 TDI	11/07-03/12	CAMB, CGKB	2698	ch.8K-8-000001→; Rippenanzahl: 6	0-N1431	VB [DG]	
2.7 TDI	11/07-03/12	CAMA, CGKA	2698	Rippenanzahl: 6	0-N1431	VB [DG]	
2.7 TDI	11/07-03/12	CAMA, CGKA, CAMB, CGKB	2698		0-N1795	VB [DG]	
2.7 TDI	11/07-03/12	CAMA, CGKA, CAMB, CGKB	2698	→ 09/2010	0-N1918	VB [BT]	S
3.0 TDI quattro	11/07-03/12	CAPA, CCLA, CCWA	2967	Rippenanzahl: 6	0-N1431	VB [DG]	
3.0 TDI quattro	11/07-03/12	CAPA, CCLA, CCWA, CCWB	2967		0-N1795	VB [DG]	
3.0 TDI quattro	11/07-03/12	CAPA, CCLA, CCWA	2967	→ 09/2010	0-N1918	VB [BT]	S
3.0 TDI quattro	06/08-05/10	CCWB	2967	ch.8K-8-000001→; Rippenanzahl: 6	0-N1431	VB [DG]	
3.0 TDI quattro	06/08-05/10	CCWB	2967		0-N1918	VB [BT]	S
3.0 TDI, 3.0 TDI quattro	11/11-12/15	CDUC, CKVB, CKVC, CLAB	2967		0-N2287	VB [BT]	S
3.0 TFSI quattro	02/12-12/15	CMUA, CRED	2995		0-N1830	VB [BT]	S
3.0 TFSI quattro, S4 quattro	11/08-12/15	CAKA, CCBA, CGWC, CGXC, CREC, CTUB, CMUA, CRED	2995		0-N2199	VB [DG]	
3.0 TFSI quattro, S4 quattro	11/08-12/15	CAKA, CCBA, CGWC, CGXC, CREC, CTUB, CMUA, CRED	2995		0-N2289	VB [BT]	S
3.0 TFSI quattro, S4 quattro	11/08-12/15	CAKA, CCBA, CGWC, CGXC, CREC, CTUB, CMUA, CRED	2995		0-N2351	VB [DG]	
3.2 FSI, 3.2 FSI quattro	11/07-03/12	CALA	3197		0-N1830	VB [BT]	S
3.2 FSI, 3.2 FSI quattro	11/07-03/12	CALA	3197		0-N2199	VB [DG]	
S4 quattro	11/08-12/15	CAKA, CCBA, CGWC, CGXC, CREC, CTUB	2995	03/2009 →	0-N1830	VB [BT]	S

A4 Allroad (8KH, B8)

2.0 TDI quattro	04/09-	CAHA, CAHB, CGLD, CNHC	1968	30x160; → 01/2012	SK-1694	BTK	
2.0 TDI quattro	04/09-	CAHA	1968	30x160	SK-1694AQ2	BTKW	
2.0 TDI quattro	04/09-	CAHB	1968	30x160	SK-1694AQ2	BTKW	
2.0 TDI quattro	04/09-	CGLD	1968	25x160	SK-1695	BTK	
2.0 TDI quattro	04/09-	CGLD	1968	25x160	SK-1695AQ1	BTKW	
2.0 TDI quattro	04/09-	CGLC, CGLD	1968	25x160	SK-1727AQ2	BTKW	
2.0 TDI quattro	09/09-	CAGA	1968	30x160	SK-1694	BTK	
2.0 TDI quattro	09/09-	CAGB, CJCB, CSUB	1968	30x160	SK-1694	BTK	
2.0 TDI quattro	09/09-	CAGA	1968	30x160	SK-1694AQ1	BTKW	
2.0 TDI quattro	09/09-	CAGB	1968	30x160	SK-1694AQ1	BTKW	
2.0 TDI quattro	09/09-	CJCA	1968	25x160	SK-1695	BTK	
2.0 TDI quattro	09/09-	CJCB	1968	25x160	SK-1695	BTK	
2.0 TDI quattro	09/09-	CJCA	1968	25x160	SK-1695AQ1	BTKW	
2.0 TDI quattro	09/09-	CJCB	1968	25x160	SK-1695AQ1	BTKW	
2.0 TDI quattro	09/09-	CJCA, CJCB	1968	25x160	SK-1727AQ2	BTKW	
2.0 TDI quattro	11/11-	CGLC, CJCD, CSUA	1968	25x160	SK-1695AQ1	BTKW	
2.0 TDI quattro	05/13-	CJCD, CSUA	1968	25x160	SK-1695	BTK	
3.0 TDI quattro	04/09-	CCWA	2967	24x82	SK-1720	BTK	
3.0 TDI quattro	04/09-	CCWA	2967	24x82	SK-1729	BTK	
2.0 TDI quattro	04/09-	CAGA, CJCA, CAGB, CJCB, CSUB, CAHA, CAHB, CGLD, CNHC	1968		0-N1046	TB [DG]	
2.0 TDI quattro	04/09-	CAGA, CJCA, CAGB, CJCB, CSUB, CAHA, CAHB, CGLD, CNHC	1968		0-N1268	TB [DG]	
2.0 TDI quattro	04/09-	CGLD	1968		0-N131	TB [DG]	
2.0 TDI quattro	04/09-	CAGA, CJCA, CAGB, CJCB, CSUB, CAHA, CAHB, CGLD, CNHC	1968		0-N1336	TB [DG]	
2.0 TDI quattro	04/09-	CAGA, CJCA, CAGB, CJCB, CSUB, CAHA, CAHB, CGLD, CNHC	1968		0-N1905	TB [BT]	
2.0 TDI quattro	09/09-	CJCA	1968		0-N131	TB [DG]	
2.0 TDI quattro	09/09-	CJCB	1968		0-N131	TB [DG]	
2.0 TDI quattro	09/09-	CJCA	1968	12/2010 →	0-N2200	TB [DG]	
2.0 TDI quattro	09/09-	CJCB	1968	12/2010 →	0-N2200	TB [DG]	
2.0 TDI quattro	11/11-	CGLC, CJCD, CSUA	1968		0-N131	TB [DG]	
2.0 TDI quattro	11/11-	CGLC	1968		0-N2200	TB [DG]	
3.0 TDI quattro	04/09-	CCWA	2967		0-N1337	TB [TE]	
2.0 TDI quattro	04/09-	CAGB, CJCB, CSUB, CAHA, CAHB, CGLD, CNHC, CGLC, CJCD, CSUA	1968		0-N1534	VB [BT]	S
2.0 TDI quattro	04/09-	CAGB, CJCB, CSUB, CAHA	1968		0-N1738	VB [DG]	
2.0 TDI quattro	04/09-	CAHB	1968		0-N1738	VB [DG]	
2.0 TDI quattro	09/09-	CBAA	1968		0-N1534	VB [BT]	S
2.0 TDI quattro	09/09-	CAGA	1968		0-N1738	VB [DG]	
2.0 TDI quattro	09/09-	CAGA, CJCA, CGLC	1968		0-N1907	VB [DG]	
2.0 TDI quattro	09/13-	CNHA	1968		0-N2288	VB [BT]	S
2.0 TFSI quattro	04/09-	CDNC, CPMA	1984		0-N2026	VB [TE]	S



CM³



Art. Nr.



A4 Allroad (8KH, B8)

2.0 TFSI quattro	04/09-	CDNC, CPMA	1984		0-N2027	VB [DG]	
3.0 TDI quattro	04/09-	CCWA	2967	Rippenanzahl: 6	0-N1431	VB [DG]	
3.0 TDI quattro	04/09-	CCWA	2967		0-N1795	VB [DG]	
3.0 TDI quattro	04/09-	CCWA	2967	→ 09/2010	0-N1918	VB [BT]	S
3.0 TDI quattro	01/12-	CDUC, CKVB, CKVC	2967		0-N2287	VB [BT]	S

A4 Avant (8K5, B8)

2.0 TDI	04/08-12/15	CAGA, CMEA	1968	30x160	SK-1694	BTK	
2.0 TDI	04/08-12/15	CAGB	1968	30x160	SK-1694	BTK	
2.0 TDI	04/08-12/15	CAGB, CMEA	1968	30x160	SK-1694AQ1	BTKW	
2.0 TDI	04/08-12/15	CJCA, CMFA	1968	25x160	SK-1695	BTK	
2.0 TDI	04/08-12/15	CJCB	1968	25x160	SK-1695	BTK	
2.0 TDI	04/08-12/15	CJCA, CMFA	1968	25x160	SK-1695AQ1	BTKW	
2.0 TDI	04/08-12/15	CJCB	1968	25x160	SK-1695AQ1	BTKW	
2.0 TDI	06/08-12/15	CAGC	1968	30x160	SK-1694	BTK	
2.0 TDI	06/08-12/15	CAGB, CAGC, CMEA	1968	30x160	SK-1694AQ1	BTKW	
2.0 TDI	06/08-12/15	CJCC	1968	25x160	SK-1695	BTK	
2.0 TDI	06/08-12/15	CJCC	1968	25x160	SK-1695AQ1	BTKW	
2.0 TDI	08/08-12/15	CAHB	1968	30x160	SK-1694	BTK	
2.0 TDI	08/08-12/15	CAHB	1968	30x160	SK-1694AQ2	BTKW	
2.0 TDI	08/08-12/15	CGLD	1968	25x160	SK-1695	BTK	
2.0 TDI	08/08-12/15	CGLD	1968	25x160	SK-1695AQ1	BTKW	
2.0 TDI	11/11-12/15	CFGB	1968	25x160	SK-1695AQ1	BTKW	
2.0 TDI	05/13-12/15	CJCD, CMFB	1968	25x160	SK-1695AQ1	BTKW	
2.0 TDI quattro	04/08-12/15	CAGA, CJCA	1968	30x160; 11/2008 → 03/2012	SK-1694	BTK	
2.0 TDI quattro	04/08-12/15	CJCA	1968	25x160; 11/2008 →	SK-1695	BTK	
2.0 TDI quattro	04/08-12/15	CJCA	1968	25x160	SK-1695AQ1	BTKW	
2.0 TDI quattro	11/11-12/15	CGLC, CJCD, CSUA	1968	25x160	SK-1695AQ1	BTKW	
2.0 TDI, 2.0 TDI quattro	04/08-03/12	CAHA	1968	30x160; → 03/2012	SK-1694	BTK	
2.0 TDI, 2.0 TDI quattro	04/08-12/15	CAGA, CMEA	1968	30x160	SK-1694AQ1	BTKW	
2.0 TDI, 2.0 TDI quattro	04/08-03/12	CAHA	1968	30x160	SK-1694AQ2	BTKW	
2.0 TDI, 2.0 TDI quattro	04/08-12/15	CJCA, CJCB, CJCC, CMFA	1968	25x160	SK-1727AQ2	BTKW	
2.0 TDI, 2.0 TDI quattro	08/08-12/15	CGLC, CGLD	1968	25x160	SK-1727AQ2	BTKW	
2.0 TDI, 2.0 TDI quattro	05/13-12/15	CJCD, CMFB, CSUA, CJCD, CSUA	1968	25x160	SK-1695	BTK	
2.7 TDI	04/08-03/12	CAMA, CGKA, CAMB, CGKB	2698	24x83; ch.→8K-8A040982; → 03/2012; mit Zubehör	SK-1597	BTK	
2.7 TDI	04/08-03/12	CAMA, CGKA, CAMB, CGKB	2698	24x83; ch.→8K-8N022419; → 03/2012; mit Zubehör	SK-1597	BTK	
2.7 TDI	04/08-03/12	CAMA, CGKA, CAMB, CGKB	2698	24x82; ch.8K-8A040983, 8K-8N022420→	SK-1720	BTK	
2.7 TDI	04/08-03/12	CAMA, CGKA, CAMB, CGKB	2698	24x83; ch.→8K-8A040982, 8K-8N022419	SK-1743	BTK	
3.0 TDI quattro	04/08-03/12	CAPA, CCLA, CCWA	2967	24x82; ch.8K-8A040983, 8K-8N022420→	SK-1720	BTK	
3.0 TDI quattro	04/08-03/12	CAPA	2967	24x83; ch.→8K-8A040982, 8K-8N022419	SK-1743	BTK	
3.0 TDI quattro	06/08-05/10	CCWB	2967	24x82	SK-1720	BTK	
3.0 TDI quattro	06/08-05/10	CCWB	2967	24x82	SK-1729	BTK	
2.0 TDI	04/08-12/15	CAGB	1968		0-N1046	TB [DG]	
2.0 TDI	04/08-12/15	CJCB	1968	→ 11/2010	0-N1046	TB [DG]	
2.0 TDI	04/08-12/15	CAGB	1968		0-N1268	TB [DG]	
2.0 TDI	04/08-12/15	CJCB	1968		0-N131	TB [DG]	
2.0 TDI	04/08-12/15	CAGB	1968		0-N1336	TB [DG]	
2.0 TDI	04/08-12/15	CAGB	1968		0-N1905	TB [BT]	
2.0 TDI	04/08-12/15	CJCB	1968		0-N2025	TB [DG]	
2.0 TDI	04/08-12/15	CJCB	1968		0-N2061	TB [TE]	
2.0 TDI	04/08-12/15	CJCA	1968		0-N2200	TB [DG]	
2.0 TDI	04/08-12/15	CJCB	1968	12/2010 →	0-N2200	TB [DG]	
2.0 TDI	06/08-12/15	CJCC	1968		0-N131	TB [DG]	
2.0 TDI	08/08-12/15	CAHB	1968		0-N1046	TB [DG]	
2.0 TDI	08/08-12/15	CAHB	1968		0-N1268	TB [DG]	
2.0 TDI	08/08-12/15	CGLD	1968		0-N131	TB [DG]	
2.0 TDI	08/08-12/15	CAHB	1968		0-N1336	TB [DG]	
2.0 TDI	08/08-12/15	CAHB	1968		0-N1905	TB [BT]	
2.0 TDI	08/08-12/15	CGLD	1968		0-N2061	TB [TE]	
2.0 TDI	08/08-12/15	CGLD	1968		0-N2200	TB [DG]	
2.0 TDI quattro	04/08-12/15	CJCA	1968	12/2010 →	0-N2200	TB [DG]	
2.0 TDI, 2.0 TDI quattro	04/08-12/15	CAGA, CJCA, CAGA, CJCA, CMEA, CMFA, CAGC, CJCC, CAHA	1968		0-N1046	TB [DG]	
2.0 TDI, 2.0 TDI quattro	04/08-12/15	CAGA, CJCA, CAGA, CJCA, CMEA, CMFA, CAGC, CJCC, CAHA	1968		0-N1268	TB [DG]	



CM³



Art. Nr.



A4 Avant (8K5, B8)

2.0 TDI, 2.0 TDI quattro	04/08-12/15	CJCA	1968		0-N131	TB [DG]	
2.0 TDI, 2.0 TDI quattro	04/08-12/15	CAGA, CJCA, CAGA, CJCA, CMEA, CMFA, CAGC, CJCC, CAHA	1968		0-N1336	TB [DG]	
2.0 TDI, 2.0 TDI quattro	04/08-12/15	CAGA, CJCA, CAGA, CJCA, CMEA, CMFA, CAGC, CJCC, CAHA	1968		0-N1905	TB [BT]	
2.0 TDI, 2.0 TDI quattro	11/11-12/15	CGLC, CJCD, CMFB, CSUA, CJCD, CSUA, CNHA	1968		0-N131	TB [DG]	
2.0 TDI, 2.0 TDI quattro	11/11-12/15	CGLC	1968		0-N2061	TB [TE]	
2.0 TDI, 2.0 TDI quattro	11/11-12/15	CGLC	1968		0-N2200	TB [DG]	
2.0 TDI, 2.0 TDI quattro	09/13-12/15	CNHA	1968		0-N2314	TB [TE]	
2.7 TDI	04/08-03/12	CAMA, CGKA, CAMB, CGKB	2698		0-N1337	TB [TE]	
2.7 TDI	06/08-03/12	CAMB, CGKB	2698		0-N131	TB [DG]	
3.0 TDI quattro	04/08-03/12	CCLA	2967		0-N131	TB [DG]	
3.0 TDI quattro	04/08-03/12	CAPA, CCLA, CCWA, CCWB	2967		0-N1337	TB [TE]	
1.8 TFSI, 1.8 TFSI quattro	11/07-12/15	CABB, CCUA, CDHB, CDHA, CDHB	1798	→ 10/2010	0-N2026	VB [TE]	S
1.8 TFSI, 1.8 TFSI quattro	11/07-12/15	CABB, CCUA, CDHB, CDHA, CDHB	1798	→ 10/2010	0-N2027	VB [DG]	
2.0 TDI	04/08-12/15	CAGA, CMEA	1968		0-N1738	VB [DG]	
2.0 TDI	04/08-12/15	CJCA	1968		0-N1907	VB [DG]	
2.0 TDI	08/08-12/15	CAHB	1968		0-N1738	VB [DG]	
2.0 TDI	08/08-12/15	CGLD	1968		0-N1907	VB [DG]	
2.0 TDI quattro	04/08-12/15	CBAA	1968		0-N1534	VB [BT]	S
2.0 TDI quattro	04/08-12/15	CAGA	1968		0-N1738	VB [DG]	
2.0 TDI, 2.0 TDI quattro	04/08-12/15	CAGA, CJCA, CMEA, CMFA, CAGB, CJCB, CSUB, CAGC, CJCC, CAHA, CAHB, CGLD, CNHC, CGLC, CJCD, CMFB, CSUA, CJCD, CSUA	1968		0-N1534	VB [BT]	S
2.0 TDI, 2.0 TDI quattro	04/08-12/15	CAGB, CJCB, CSUB, CAGC, CJCC, CAHA	1968		0-N1738	VB [DG]	
2.0 TDI, 2.0 TDI quattro	04/08-12/15	CAGA, CJCA, CGLC	1968		0-N1907	VB [DG]	
2.0 TDI, 2.0 TDI quattro	09/13-12/15	CNHA	1968		0-N2288	VB [BT]	S
2.0 TFSI flexible fuel, 2.0 TFSI flexible fuel quattro	11/09-12/15	CFKA	1984		0-N2026	VB [TE]	S
2.0 TFSI flexible fuel, 2.0 TFSI flexible fuel quattro	11/09-12/15	CFKA	1984		0-N2027	VB [DG]	
2.0 TFSI, 2.0 TFSI quattro	06/08-12/15	CAEA, CDNB, CFKA, CAEB, CDNC	1984	→ 10/2010	0-N2026	VB [TE]	S
2.0 TFSI, 2.0 TFSI quattro	06/08-12/15	CAEA, CDNB, CFKA, CAEB, CDNC	1984	→ 10/2010	0-N2027	VB [DG]	
2.7 TDI	04/08-03/12	CAMA, CGKA, CAMB, CGKB	2698	Rippenanzahl: 6	0-N1431	VB [DG]	
2.7 TDI	04/08-03/12	CAMA, CGKA, CAMB, CGKB	2698		0-N1795	VB [DG]	
2.7 TDI	04/08-03/12	CAMA, CGKA, CAMB, CGKB	2698	ch.8K-8-000001→	0-N1918	VB [BT]	S
3.0 TDI quattro	04/08-03/12	CAPA, CCLA, CCWA, CCWB	2967	Rippenanzahl: 6	0-N1431	VB [DG]	
3.0 TDI quattro	04/08-03/12	CAPA, CCLA, CCWA, CCWB	2967		0-N1795	VB [DG]	
3.0 TDI quattro	04/08-03/12	CAPA, CCLA, CCWA	2967	→ 09/2010	0-N1918	VB [BT]	S
3.0 TDI quattro	06/08-05/10	CCWB	2967		0-N1918	VB [BT]	S
3.0 TDI, 3.0 TDI quattro	11/11-12/15	CDUC, CKVB, CKVC, CLAB	2967		0-N2287	VB [BT]	S
3.0 TFSI quattro	02/12-12/15	CMUA, CRED	2995		0-N1830	VB [BT]	S
3.0 TFSI quattro, S4 quattro	11/08-12/15	CAKA, CCBA, CGWC, CGXC, CREC, CTUB, CMUA, CRED	2995		0-N2199	VB [DG]	
3.0 TFSI quattro, S4 quattro	11/08-12/15	CAKA, CCBA, CGWC, CGXC, CREC, CTUB, CMUA, CRED	2995		0-N2289	VB [BT]	S
3.0 TFSI quattro, S4 quattro	11/08-12/15	CAKA, CCBA, CGWC, CGXC, CREC, CTUB, CMUA, CRED	2995		0-N2351	VB [DG]	
3.2 FSI, 3.2 FSI quattro	04/08-03/12	CALA	3197		0-N1830	VB [BT]	S
3.2 FSI, 3.2 FSI quattro	04/08-03/12	CALA	3197		0-N2199	VB [DG]	
S4 quattro	11/08-12/15	CAKA, CCBA, CGWC, CGXC, CREC, CTUB	2995	03/2009 →	0-N1830	VB [BT]	S

A5 (8T3)

2.0 TDI	08/08-	CAHB, CGLD	1968	30x160	SK-1694	BTK	
2.0 TDI	08/08-	CAHB	1968	30x160	SK-1694AQ2	BTKW	
2.0 TDI	08/08-	CGLD	1968	25x160	SK-1695	BTK	
2.0 TDI, 2.0 TDI quattro	08/08-	CAHA	1968	30x160; → 02/2012	SK-1694	BTK	
2.0 TDI, 2.0 TDI quattro	08/08-	CAHA	1968	30x160	SK-1694AQ2	BTKW	
2.0 TDI, 2.0 TDI quattro	10/11-	CGLC	1968	25x160	SK-1727	BTK	
2.0 TDI, 2.0 TDI quattro	10/11-	CGLC, CGLD	1968	25x160	SK-1727AQ2	BTKW	
2.7 TDI	06/07-	CAMA, CGKA, CAMB, CGKB	2698	24x83; ch.→8T-8-041400; → 02/2012; mit Zubehör	SK-1597	BTK	
2.7 TDI	06/07-	CAMA, CGKA, CAMB, CGKB	2698	24x82; ch.8T-8-041401→	SK-1720	BTK	
2.7 TDI	06/07-	CAMA, CGKA, CAMB, CGKB	2698	24x83; → 05/2008	SK-1743	BTK	
3.0 TDI quattro	06/07-	CAPA, CCWA	2967	24x83; ch.→8T-8-041400; → 02/2012; mit Zubehör	SK-1597	BTK	
3.0 TDI quattro	06/07-	CAPA, CCWA, CCWB	2967	24x82; ch.8T-8-041401→	SK-1720	BTK	



CM³



Art. Nr.



ohne Halter

A5 (8T3)							
3.0 TDI quattro	06/07-	CAPA, CCWA, CCWB	2967	24x83; → 05/2008	SK-1743	BTK	
3.0 TDI quattro	03/08-	CCWB	2967	24x83; ch.→8T-8-041400; → 05/2010; mit Zubehör	SK-1597	BTK	
2.0 TDI	08/08-	CGLD	1968		0-N131	TB [DG]	
2.0 TDI, 2.0 TDI quattro	08/08-	CAHA, CAHB, CGLD	1968		0-N1046	TB [DG]	
2.0 TDI, 2.0 TDI quattro	08/08-	CAHA, CAHB, CGLD	1968		0-N1268	TB [DG]	
2.0 TDI, 2.0 TDI quattro	08/08-	CAHA, CAHB, CGLD	1968		0-N1336	TB [DG]	
2.0 TDI, 2.0 TDI quattro	08/08-	CAHA, CAHB, CGLD	1968		0-N1905	TB [BT]	
2.0 TDI, 2.0 TDI quattro	10/11-	CGLC	1968		0-N131	TB [DG]	
2.0 TDI, 2.0 TDI quattro	10/11-	CGLC	1968		0-N2061	TB [TE]	
2.0 TDI, 2.0 TDI quattro	10/11-	CGLC	1968		0-N2200	TB [DG]	
2.7 TDI	06/07-	CAMA, CGKA, CAMB, CGKB	2698		0-N1337	TB [TE]	
3.0 TDI quattro	06/07-	CAPA, CCWA, CCWB	2967		0-N1337	TB [TE]	
1.8 TFSI	10/07-	CABD, CJEB, CDHB	1798	→ 09/2011	0-N2026	VB [TE]	S
1.8 TFSI	10/07-	CABD, CJEB, CDHB	1798	→ 09/2011	0-N2027	VB [DG]	
2.0 TDI	08/08-	CAHB	1968		0-N1738	VB [DG]	
2.0 TDI, 2.0 TDI quattro	08/08-	CAHA, CAHB, CGLD, CGLC	1968		0-N1534	VB [BT]	S
2.0 TDI, 2.0 TDI quattro	08/08-	CAHA	1968		0-N1738	VB [DG]	
2.0 TDI, 2.0 TDI quattro	08/08-	CAHB, CGLD, CNHA	1968		0-N2288	VB [BT]	S
2.0 TDI, 2.0 TDI quattro	10/11-	CGLC	1968		0-N1907	VB [DG]	
2.0 TFSI, 2.0 TFSI quattro	06/08-	CAEB, CDNC, CDNB, CDNC	1984	→ 09/2011	0-N2026	VB [TE]	S
2.0 TFSI, 2.0 TFSI quattro	06/08-	CAEB, CDNC, CDNB, CDNC	1984	→ 09/2011	0-N2027	VB [DG]	
2.7 TDI	06/07-	CAMA, CGKA	2698	Rippenanzahl: 6	0-N1431	VB [DG]	
2.7 TDI	06/07-	CAMA, CGKA, CAMB, CGKB	2698		0-N1795	VB [DG]	
2.7 TDI	06/07-	CAMA, CGKA, CAMB, CGKB	2698	ch.8K-8-000001→	0-N1918	VB [BT]	S
3.0 TDI quattro	06/07-	CAPA, CCWA, CCWB	2967	Rippenanzahl: 6	0-N1431	VB [DG]	
3.0 TDI quattro	06/07-	CAPA, CCWA, CCWB	2967		0-N1795	VB [DG]	
3.0 TDI quattro	06/07-	CAPA, CCWA, CCWB	2967		0-N1918	VB [BT]	S
3.0 TDI, 3.0 TDI quattro	10/11-	CDUC, CKVB, CKVC, CLAB	2967		0-N2287	VB [BT]	S
3.0 TFSI quattro, S5 quattro	10/11-	CAKA, CGWC, CGXC, CREC, CTDA, CTUB, CMUA	2995		0-N1830	VB [BT]	S
3.0 TFSI quattro, S5 quattro	10/11-	CAKA, CGWC, CGXC, CREC, CTDA, CTUB, CMUA	2995		0-N2199	VB [DG]	
3.0 TFSI quattro, S5 quattro	10/11-	CAKA, CGWC, CGXC, CREC, CTDA, CTUB, CMUA	2995		0-N2289	VB [BT]	S
3.0 TFSI quattro, S5 quattro	10/11-	CAKA, CGWC, CGXC, CREC, CTDA, CTUB, CMUA	2995		0-N2351	VB [DG]	
3.2 FSI, 3.2 FSI quattro	06/07-	CALA	3197		0-N1830	VB [BT]	S
3.2 FSI, 3.2 FSI quattro	06/07-	CALA	3197		0-N2199	VB [DG]	
A5 Cabriolet (8F7)							
2.0 TDI	05/09-	CAHB, CGLD	1968	30x160	SK-1694	BTK	
2.0 TDI	05/09-	CAHA	1968	30x160; → 03/2012	SK-1694	BTK	
2.0 TDI	05/09-	CAHA	1968	30x160	SK-1694AQ2	BTKW	
2.0 TDI	05/09-	CAHB	1968	30x160	SK-1694AQ2	BTKW	
2.0 TDI	05/09-	CGLD	1968	25x160	SK-1695	BTK	
2.0 TDI, 2.0 TDI quattro	10/11-	CGLC, CJCA, CJCD	1968	25x160	SK-1727	BTK	
2.0 TDI, 2.0 TDI quattro	10/11-	CGLC, CGLD	1968	25x160	SK-1727AQ2	BTKW	
2.7 TDI	03/09-	CGKA, CGKB	2698	24x82	SK-1720	BTK	
2.7 TDI	03/09-	CGKA, CGKB	2698	24x82	SK-1729	BTK	
3.0 TDI quattro	03/09-	CCWA	2967	24x82	SK-1720	BTK	
3.0 TDI quattro	03/09-	CCWA	2967	24x82	SK-1729	BTK	
2.0 TDI	05/09-	CAHA, CAHB, CGLD	1968		0-N1046	TB [DG]	
2.0 TDI	05/09-	CAHA, CAHB, CGLD	1968		0-N1268	TB [DG]	
2.0 TDI	05/09-	CGLD	1968		0-N131	TB [DG]	
2.0 TDI	05/09-	CAHA, CAHB, CGLD	1968		0-N1336	TB [DG]	
2.0 TDI	05/09-	CAHA, CAHB, CGLD	1968		0-N1905	TB [BT]	
2.0 TDI, 2.0 TDI quattro	10/11-	CGLC, CJCA, CJCD	1968		0-N131	TB [DG]	
2.0 TDI, 2.0 TDI quattro	10/11-	CGLC, CJCA	1968		0-N2061	TB [TE]	
2.0 TDI, 2.0 TDI quattro	10/11-	CGLC, CJCA	1968		0-N2200	TB [DG]	
2.7 TDI	03/09-	CGKA, CGKB	2698		0-N1337	TB [TE]	
3.0 TDI quattro	03/09-	CCWA	2967		0-N1337	TB [TE]	
1.8 TFSI	09/09-	CDHB	1798		0-N2026	VB [TE]	S
1.8 TFSI	09/09-	CDHB	1798		0-N2027	VB [DG]	
2.0 TDI	05/09-	CAHA	1968		0-N1738	VB [DG]	
2.0 TDI	05/09-	CAHB	1968		0-N1738	VB [DG]	
2.0 TDI, 2.0 TDI quattro	05/09-	CAHA, CAHB, CGLD, CGLC, CJCA, CJCD	1968		0-N1534	VB [BT]	S

CM³

Art. Nr.

**A5 Cabriolet (8F7)**

2.0 TDI, 2.0 TDI quattro	10/11-	CGLC, CJCA	1968		0-N1907	VB [DG]	
2.0 TDI, 2.0 TDI quattro	09/13-	CNHA	1968		0-N2288	VB [BT]	S
2.0 TFSI, 2.0 TFSI quattro	03/09-	CAEA, CDNB, CAEB, CDNC	1984	→ 09/2011	0-N2026	VB [TE]	S
2.0 TFSI, 2.0 TFSI quattro	03/09-	CAEA, CDNB, CAEB, CDNC	1984	→ 09/2011	0-N2027	VB [DG]	
2.7 TDI	03/09-	CGKA, CGKB	2698		0-N1795	VB [DG]	
2.7 TDI	03/09-	CGKA, CGKB	2698		0-N1918	VB [BT]	S
3.0 TDI quattro	03/09-	CCWA	2967		0-N1795	VB [DG]	
3.0 TDI quattro	03/09-	CCWA	2967		0-N1918	VB [BT]	S
3.0 TDI, 3.0 TDI quattro	10/11-	CDUC, CKVC, CLAB	2967		0-N2287	VB [BT]	S
3.0 TFSI quattro, S5 quattro	06/09-	CAKA, CCBA, CGWC, CGXC, CREC, CTDA, CTUB, CMUA	2995		0-N1830	VB [BT]	S
3.0 TFSI quattro, S5 quattro	06/09-	CAKA, CCBA, CGWC, CGXC, CREC, CTDA, CTUB, CMUA	2995		0-N2199	VB [DG]	
3.0 TFSI quattro, S5 quattro	06/09-	CAKA, CCBA, CGWC, CGXC, CREC, CTDA, CTUB, CMUA	2995		0-N2289	VB [BT]	S
3.0 TFSI quattro, S5 quattro	06/09-	CAKA, CCBA, CGWC, CGXC, CREC, CTDA, CTUB, CMUA	2995		0-N2351	VB [DG]	
3.2 FSI, 3.2 FSI quattro	03/09-	CALA	3197		0-N1830	VB [BT]	S
3.2 FSI, 3.2 FSI quattro	03/09-	CALA	3197		0-N2199	VB [DG]	

A5 Sportback (8TA)

2.0 TDI	09/09-	CAGA, CMEA	1968	30x160	SK-1694	BTK	
2.0 TDI	09/09-	CAGB	1968	30x160	SK-1694	BTK	
2.0 TDI	09/09-	CAHB, CGLD	1968	30x160	SK-1694	BTK	
2.0 TDI	09/09-	CAGA, CMEA	1968	30x160	SK-1694AQ1	BTKW	
2.0 TDI	09/09-	CAGB	1968	30x160	SK-1694AQ1	BTKW	
2.0 TDI	09/09-	CAHB	1968	30x160	SK-1694AQ2	BTKW	
2.0 TDI	09/09-	CGLD	1968	25x160	SK-1695	BTK	
2.0 TDI	09/09-	CJCA, CMFA	1968	25x160	SK-1695	BTK	
2.0 TDI	09/09-	CJCB	1968	25x160	SK-1695	BTK	
2.0 TDI, 2.0 TDI quattro	09/09-	CAHA	1968	30x160; → 02/2012	SK-1694	BTK	
2.0 TDI, 2.0 TDI quattro	09/09-	CAHA	1968	30x160	SK-1694AQ2	BTKW	
2.0 TDI, 2.0 TDI quattro	10/11-	CGLC, CJCD	1968	25x160	SK-1727	BTK	
2.0 TDI, 2.0 TDI quattro	10/11-	CGLC, CGLD	1968	25x160	SK-1727AQ2	BTKW	
2.7 TDI	09/09-	CGKA, CGKB	2698	24x83; ch.→8T-8-041400; → 02/2012; mit Zubehör	SK-1597	BTK	
2.7 TDI	09/09-	CGKA, CGKB	2698	24x82; ch.8T-8-041401→	SK-1720	BTK	
3.0 TDI quattro	09/09-	CCWA	2967	24x83; ch.→8T-8-041400; → 02/2012; mit Zubehör	SK-1597	BTK	
3.0 TDI quattro	09/09-	CCWA	2967	24x82; ch.8T-8-041401→	SK-1720	BTK	
2.0 TDI	09/09-	CGLD	1968		0-N131	TB [DG]	
2.0 TDI	09/09-	CJCA	1968		0-N131	TB [DG]	
2.0 TDI	09/09-	CJCB	1968		0-N131	TB [DG]	
2.0 TDI	09/09-	CJCA	1968		0-N2200	TB [DG]	
2.0 TDI, 2.0 TDI quattro	09/09-	CAGA, CJCA, CMEA, CMFA, CAGB, CJCB, CAHA, CAHB, CGLD	1968		0-N1046	TB [DG]	
2.0 TDI, 2.0 TDI quattro	09/09-	CAGA, CJCA, CMEA, CMFA, CAGB, CJCB, CAHA, CAHB, CGLD	1968		0-N1268	TB [DG]	
2.0 TDI, 2.0 TDI quattro	09/09-	CAGA, CJCA, CMEA, CMFA, CAGB, CJCB, CAHA, CAHB, CGLD	1968		0-N1336	TB [DG]	
2.0 TDI, 2.0 TDI quattro	09/09-	CAGA, CJCA, CMEA, CMFA, CAGB, CJCB, CAHA, CAHB, CGLD	1968		0-N1905	TB [BT]	
2.0 TDI, 2.0 TDI quattro	10/11-	CGLC, CJCD	1968		0-N131	TB [DG]	
2.0 TDI, 2.0 TDI quattro	10/11-	CGLC	1968		0-N2061	TB [TE]	
2.0 TDI, 2.0 TDI quattro	10/11-	CGLC	1968		0-N2200	TB [DG]	
2.7 TDI	09/09-	CGKA, CGKB	2698		0-N1337	TB [TE]	
3.0 TDI quattro	09/09-	CCWA	2967		0-N1337	TB [TE]	
1.8 TFSI	11/09-	CDHB	1798		0-N2026	VB [TE]	S
1.8 TFSI	11/09-	CDHB	1798		0-N2027	VB [DG]	
2.0 TDI	09/09-	CAGA, CMEA	1968		0-N1738	VB [DG]	
2.0 TDI	09/09-	CAHB	1968		0-N1738	VB [DG]	
2.0 TDI	09/09-	CJCA	1968		0-N1907	VB [DG]	
2.0 TDI, 2.0 TDI quattro	09/09-	CAGA, CJCA, CMEA, CMFA, CAGB, CJCB, CAHA, CAHB, CGLD, CGLC, CJCD	1968		0-N1534	VB [BT]	S
2.0 TDI, 2.0 TDI quattro	09/09-	CAGB, CJCB, CAHA	1968		0-N1738	VB [DG]	
2.0 TDI, 2.0 TDI quattro	09/09-	CAHB, CGLD, CNHA	1968		0-N2288	VB [BT]	S
2.0 TDI, 2.0 TDI quattro	10/11-	CGLC	1968		0-N1907	VB [DG]	
2.0 TFSI	09/09-	CDNC	1984		0-N2026	VB [TE]	S
2.0 TFSI	09/09-	CDNC	1984		0-N2027	VB [DG]	



CM³



Art. Nr.



A5 Sportback (8TA)							
2.0 TFSI, 2.0 TFSI quattro	09/09-	CDNB, CDNC	1984	→ 09/2011	0-N2026	VB [TE]	S
2.0 TFSI, 2.0 TFSI quattro	09/09-	CDNB, CDNC	1984	→ 09/2011	0-N2027	VB [DG]	
2.7 TDI	09/09-	CGKA, CGKB	2698		0-N1795	VB [DG]	
2.7 TDI	09/09-	CGKA	2698		0-N1918	VB [BT]	S
2.7 TDI	09/09-	CGKB	2698	→ 09/2010	0-N1918	VB [BT]	S
3.0 TDI quattro	09/09-	CCWA	2967		0-N1795	VB [DG]	
3.0 TDI quattro	09/09-	CCWA	2967		0-N1918	VB [BT]	S
3.0 TDI, 3.0 TDI quattro	10/11-	CDUC, CKVB, CKVC, CLAB	2967		0-N2287	VB [BT]	S
3.0 TFSI quattro, S5 quattro	01/10-	CAKA, CGWC, CGXC, CREC, CTDA, CTUB, CMUA	2995		0-N1830	VB [BT]	S
3.0 TFSI quattro, S5 quattro	01/10-	CAKA, CGWC, CGXC, CREC, CTDA, CTUB, CMUA	2995		0-N2199	VB [DG]	
3.0 TFSI quattro, S5 quattro	01/10-	CAKA, CGWC, CGXC, CREC, CTDA, CTUB, CMUA	2995		0-N2289	VB [BT]	S
3.0 TFSI quattro, S5 quattro	01/10-	CAKA, CGWC, CGXC, CREC, CTDA, CTUB, CMUA	2995		0-N2351	VB [DG]	
3.2 FSI quattro	09/09-	CALA	3197		0-N1830	VB [BT]	S
3.2 FSI quattro	09/09-	CALA	3197		0-N2199	VB [DG]	
A6 (4A, C4)							
1.8	12/95-10/97	ADR	1781	25x153; mit Zubehör; Baumuster: 4A2	SK-1346	BTK	
1.8 quattro	12/95-10/97	ADR	1781	25x153; 08/1996 →; mit Zubehör; Baumuster: 4A2	SK-1346	BTK	
1.8, 1.8 quattro	12/95-10/97	ADR	1781	25x153; mit Spanndämpfer, Spannrolle; mit Zubehör	SK-1638	BTK	
1.9 TDI	06/94-10/97	1Z, AHU	1896	25x137; mit Zubehör	SK-1098	BTK	
2.0	06/94-10/97	AAE, ABK, ADW	1984	18x124; ch.→4A-S-060808	SK-1119	BTK	
2.0	06/94-10/97	AAE, ABK, ADW	1984	18x124; ch.4A-S-060809→	SK-1261	BTK	
2.0 16V, 2.0 16V quattro	06/94-10/97	ACE	1984	25x147	SK-1047	BTK	
2.3, 2.3 quattro	06/94-12/95	AAR	2309	19x147	SK-1130	BTK	
2.4	07/95-06/96	AFM	2393	25x239; mit Zubehör	SK-1376	BTK	
2.4	07/95-06/96	AFM	2393	25x239	SK-1376AQ1	BTKW	
2.5 TDI, 2.5 TDI quattro	06/94-10/97	AAT, AEL	2461	26.5x122; 21x80	SK-1539	BTK	
2.5 TDI, 2.5 TDI quattro	06/94-10/97	AAT, AEL	2461	26.5x122; 21x80	SK-1539AQ1	BTKW	
2.6	06/94-10/97	ABC, ACZ	2598	25x239; ch.→4A-S-026714; Baumuster: 4A2, 4A5	SK-1343	BTK	
2.6 quattro	06/94-10/97	ABC	2598	25x239; ch.→4A-S-026714; → 04/1997; Baumuster: 4A2, 4A5	SK-1343	BTK	
2.6, 2.6 quattro	06/94-10/97	ABC, ACZ	2598	25x239; ch.→4A-S-026714	SK-1343AQ1	BTKW	
2.6, 2.6 quattro	06/94-10/97	ABC, ACZ	2598	25x239; ch.4A-S-026715→; mit Zubehör	SK-1376	BTK	
2.6, 2.6 quattro	06/94-10/97	ABC, ACZ	2598	25x239; ch.4A-S-026715→	SK-1376AQ1	BTKW	
2.8	06/94-10/97	AAH, AEJ, AFC	2771	25x239; ch.→4A-S-026714; Baumuster: 4A2, 4A5	SK-1343	BTK	
2.8	08/95-07/96	AEJ	2771	25x239; ch.→4A-S-026714; Baumuster: 4A2, 4A5	SK-1343	BTK	
2.8 quattro	06/94-10/97	AAH	2771	25x239; ch.→4A-S-026714; → 04/1997; Baumuster: 4A2, 4A5	SK-1343	BTK	
2.8, 2.8 quattro	06/94-10/97	AAH, AEJ, AAH, AEJ, AFC, AEJ	2771	25x239; ch.→4A-S-026714	SK-1343AQ1	BTKW	
2.8, 2.8 quattro	06/94-10/97	AAH, AEJ, AAH, AEJ, AFC, AEJ	2771	25x239; ch.4A-S-026715→; mit Zubehör	SK-1376	BTK	
2.8, 2.8 quattro	06/94-10/97	AAH, AEJ, AAH, AEJ, AFC, AEJ	2771	25x239; ch.4A-S-026715→	SK-1376AQ1	BTKW	
2.8, 2.8 quattro	12/95-10/97	ACK	2771	30x253; ohne Spanndämpfer, Spannrolle; mit Zubehör	SK-1383	BTK	
2.8, 2.8 quattro	12/95-10/97	ACK	2771	30x253; mit Spanndämpfer, Spannrolle; mit Zubehör	SK-1636	BTK	
1.8, 1.8 quattro	12/95-10/97	ADR	1781		0-N1236	TB [TE]	
1.8, 1.8 quattro	12/95-10/97	ADR	1781		0-N1276	TB [BT]	
1.8, 1.8 quattro	12/95-10/97	ADR	1781		0-N131	TB [DG]	
1.8, 1.8 quattro	12/95-10/97	ADR	1781		0-N1822	TB [BT]	S
1.9 TDI	06/94-10/97	1Z, AHU	1896		0-N104	TB [TE]	
1.9 TDI	06/94-10/97	1Z, AHU	1896		0-N128	TB [DG]	
2.0	06/94-10/97	AAE, ABK	1984	ch.4A-S-060809→	0-N132	TB [TE]	
2.0	06/94-10/97	AAE, ABK	1984	ch.→4A-S-060808	0-N922	TB [TE]	
2.0 16V, 2.0 16V quattro	06/94-10/97	ACE	1984	EMERSON: 017140→	0-N129	TB [TE]	
2.0 16V, 2.0 16V quattro	06/94-10/97	ACE	1984	EMERSON: →017139	0-N808	TB [TE]	
2.3, 2.3 quattro	06/94-12/95	AAR	2309		0-N939	TB [TE]	
2.4	07/95-06/96	AFM	2393		0-N160	TB [TE]	
2.4	07/95-06/96	AFM	2393		0-N2000	TB [DG]	
2.5 TDI	06/94-10/97	AAT	2461	für OE: N90705901	0-N1230	TB [DG]	
2.5 TDI, 2.5 TDI quattro	06/94-10/97	AAT, AEL	2461		0-N109	TB [TE]	

CM³

Art. Nr.

**A6 (4A, C4)**

2.5 TDI, 2.5 TDI quattro	06/94-10/97	AAT, AEL	2461		0-N1229	TB [TE]	
2.5 TDI, 2.5 TDI quattro	08/94-10/97	AEL	2461		0-N1230	TB [DG]	
2.6, 2.6 quattro	06/94-10/97	ABC, ACZ	2598	ch.4A-S-026715→	0-N160	TB [TE]	
2.6, 2.6 quattro	06/94-10/97	ABC, ACZ	2598	ch.4A-S-026715→	0-N2000	TB [DG]	
2.6, 2.6 quattro	06/94-10/97	ABC	2598	ch.→4A-S-026714	0-N940	TB [TE]	
2.6, 2.6 quattro	06/94-10/97	ABC	2598	ch.→4A-S-026714	0-N941	TB [DG]	
2.8	08/95-07/96	AEJ	2771		0-N160	TB [TE]	
2.8	08/95-07/96	AEJ	2771		0-N2000	TB [DG]	
2.8, 2.8 quattro	06/94-10/97	AAH, AEJ, AAH, AEJ, AFC	2771	ch.4A-S-026715→	0-N160	TB [TE]	
2.8, 2.8 quattro	06/94-10/97	AAH, AEJ, AAH, AEJ, AFC	2771	ch.4A-S-026715→	0-N2000	TB [DG]	
2.8, 2.8 quattro	06/94-10/97	AAH, AEJ, AAH, AEJ, AFC	2771	ch.→4A-S-026714	0-N940	TB [TE]	
2.8, 2.8 quattro	06/94-10/97	AAH, AEJ, AAH, AEJ, AFC	2771	ch.→4A-S-026714	0-N941	TB [DG]	
2.8, 2.8 quattro	12/95-10/97	ACK	2771		0-N1238	TB [TE]	
2.8, 2.8 quattro	12/95-10/97	ACK	2771		0-N1371	TB [TE]	
2.8, 2.8 quattro	12/95-10/97	ACK	2771		0-N1372	TB [BT]	
2.8, 2.8 quattro	12/95-10/97	ACK	2771		0-N2001	TB [DG]	
S6 4.2 quattro, S6 Plus quattro	06/94-10/97	AEC, AHK	4172		0-N2414	TB [VD]	
S6 Turbo quattro	06/94-10/97	AAN	2226		0-N941	TB [DG]	
1.8, 1.8 quattro	12/95-10/97	ADR	1781	Rippenanzahl: 4	0-N1317	VB [TE]	S
1.9 TDI	06/94-10/97	1Z, AHU	1896		0-N1417	VB [TE]	
1.9 TDI	06/94-10/97	1Z, AHU	1896		0-N1609	VB [BT]	
2.0 16V, 2.0 16V quattro	06/94-10/97	ACE	1984		0-N2345	VB [DG]	
2.6, 2.6 quattro	06/94-10/97	ABC	2598	ch.4A-S-026715→	0-N1083	VB [BT]	S
2.6, 2.6 quattro	06/94-10/97	ABC	2598		0-N1414	VB [DG]	
2.8, 2.8 quattro	06/94-10/97	AAH, AEJ, AAH, AEJ, AFC	2771	ch.4A-S-026715→	0-N1083	VB [BT]	S
2.8, 2.8 quattro	06/94-10/97	AAH, AEJ, AAH, AEJ, AFC	2771		0-N1414	VB [DG]	
2.8, 2.8 quattro	12/95-10/97	ACK	2771		0-N1083	VB [BT]	S
S6 4.2 quattro, S6 Plus quattro	06/94-10/97	AEC, AHK	4172		0-N1632	VB [DG]	
S6 4.2 quattro, S6 Plus quattro	06/94-10/97	AEC, AHK	4172		0-N1967	VB [VD]	

A6 Avant (4A, C4)

1.8	12/95-12/97	ADR	1781	25x153; mit Zubehör; Baumuster: 4A5	SK-1346	BTK	
1.8 quattro	12/95-12/97	ADR	1781	25x153; 08/1996 →; mit Zubehör; Baumuster: 4A5	SK-1346	BTK	
1.8, 1.8 quattro	12/95-12/97	ADR	1781	25x153; mit Spanndämpfer, Spannrolle; mit Zubehör	SK-1638	BTK	
1.9 TDI	06/94-12/97	1Z, AHU	1896	25x137; mit Zubehör	SK-1098	BTK	
2.0	06/94-12/97	AAE, ABK	1984	18x124; ch.→4A-S-060808	SK-1119	BTK	
2.0	06/94-12/97	AAE, ABK	1984	18x124; ch.4A-S-060809→	SK-1261	BTK	
2.0 16V, 2.0 16V quattro	06/94-12/97	ACE	1984	25x147	SK-1047	BTK	
2.3, 2.3 quattro	06/94-12/95	AAR	2309	19x147	SK-1130	BTK	
2.4	07/96-12/97	AFM	2393	25x239; mit Zubehör	SK-1376	BTK	
2.4	07/96-12/97	AFM	2393	25x239	SK-1376AQ1	BTKW	
2.5 TDI, 2.5 TDI quattro	06/94-12/97	AAT, AEL	2461	26.5x122; 21x80	SK-1539	BTK	
2.5 TDI, 2.5 TDI quattro	06/94-12/97	AAT, AEL	2461	26.5x122; 21x80	SK-1539AQ1	BTKW	
2.6	06/94-12/97	ABC, ACZ	2598	25x239; ch.→4A-S-026714; Baumuster: 4A2, 4A5	SK-1343	BTK	
2.6 quattro	06/94-12/97	ABC	2598	25x239; ch.→4A-S-026714; → 04/1997; Baumuster: 4A2, 4A5	SK-1343	BTK	
2.6, 2.6 quattro	06/94-12/97	ABC, ACZ	2598	25x239; ch.→4A-S-026714	SK-1343AQ1	BTKW	
2.6, 2.6 quattro	06/94-12/97	ABC, ACZ	2598	25x239; ch.4A-S-026715→; mit Zubehör	SK-1376	BTK	
2.6, 2.6 quattro	06/94-12/97	ABC, ACZ	2598	25x239; ch.4A-S-026715→	SK-1376AQ1	BTKW	
2.8	06/94-12/97	AAH, AEJ	2771	25x239; ch.→4A-S-026714; Baumuster: 4A2, 4A5	SK-1343	BTK	
2.8	08/95-07/96	AEJ	2771	25x239; ch.→4A-S-026714; Baumuster: 4A2, 4A5	SK-1343	BTK	
2.8	12/95-12/97	ACK	2771	30x253; 10/1997 →; mit Spanndämpfer, Spannrolle; mit Zubehör	SK-1377	BTK	
2.8	12/95-12/97	ACK	2771	30x253; 10/1997 →; mit Spanndämpfer, Spannrolle; mit Zubehör	SK-1377AQ1	BTKW	
2.8 quattro	06/94-12/97	AAH	2771	25x239; ch.→4A-S-026714; → 04/1997; Baumuster: 4A2, 4A5	SK-1343	BTK	
2.8, 2.8 quattro	06/94-12/97	AAH, AEJ	2771	25x239; ch.→4A-S-026714	SK-1343AQ1	BTKW	
2.8, 2.8 quattro	06/94-12/97	AAH, AEJ	2771	25x239; ch.4A-S-026715→; mit Zubehör	SK-1376	BTK	
2.8, 2.8 quattro	06/94-12/97	AAH, AEJ	2771	25x239; ch.4A-S-026715→	SK-1376AQ1	BTKW	
2.8, 2.8 quattro	12/95-12/97	ACK	2771	30x253; ohne Spanndämpfer, Spannrolle; mit Zubehör	SK-1383	BTK	
2.8, 2.8 quattro	12/95-12/97	ACK	2771	30x253; mit Spanndämpfer, Spannrolle; mit Zubehör	SK-1636	BTK	



CM³



Art. Nr.



A6 Avant (4A, C4)

1.8, 1.8 quattro	12/95-12/97	ADR	1781		0-N1236	TB [TE]	
1.8, 1.8 quattro	12/95-12/97	ADR	1781		0-N1276	TB [BT]	
1.8, 1.8 quattro	12/95-12/97	ADR	1781		0-N131	TB [DG]	
1.8, 1.8 quattro	12/95-12/97	ADR	1781		0-N1822	TB [BT]	S
1.9 TDI	06/94-12/97	1Z, AHU	1896		0-N104	TB [TE]	
1.9 TDI	06/94-12/97	1Z, AHU	1896		0-N128	TB [DG]	
2.0	06/94-12/97	AAE, ABK	1984	ch.4A-S-060809→	0-N132	TB [TE]	
2.0	06/94-12/97	AAE, ABK	1984	ch.→4A-S-060808	0-N922	TB [TE]	
2.0 16V, 2.0 16V quattro	06/94-12/97	ACE	1984	017140 →	0-N129	TB [TE]	
2.0 16V, 2.0 16V quattro	06/94-12/97	ACE	1984	017139	0-N808	TB [TE]	
2.3, 2.3 quattro	06/94-12/95	AAR	2309		0-N939	TB [TE]	
2.4	07/96-12/97	AFM	2393		0-N160	TB [TE]	
2.4	07/96-12/97	AFM	2393		0-N2000	TB [DG]	
2.5 TDI	06/94-12/97	AAT	2461	für OE: N90705901	0-N1230	TB [DG]	
2.5 TDI, 2.5 TDI quattro	06/94-12/97	AAT, AEL	2461		0-N109	TB [TE]	
2.5 TDI, 2.5 TDI quattro	06/94-12/97	AAT, AEL	2461		0-N1229	TB [TE]	
2.5 TDI, 2.5 TDI quattro	08/94-12/97	AEL	2461		0-N1230	TB [DG]	
2.6, 2.6 quattro	06/94-12/97	ABC, ACZ	2598	ch.4A-S-026715→	0-N160	TB [TE]	
2.6, 2.6 quattro	06/94-12/97	ABC, ACZ	2598	ch.4A-S-026715→	0-N2000	TB [DG]	
2.6, 2.6 quattro	06/94-12/97	ABC	2598	ch.→4A-S-026714	0-N940	TB [TE]	
2.6, 2.6 quattro	06/94-12/97	ABC	2598	ch.→4A-S-026714	0-N941	TB [DG]	
2.8, 2.8 quattro	06/94-12/97	AAH, AEJ	2771	ch.4A-S-026715→	0-N160	TB [TE]	
2.8, 2.8 quattro	06/94-12/97	AAH, AEJ	2771	ch.4A-S-026715→	0-N2000	TB [DG]	
2.8, 2.8 quattro	06/94-12/97	AAH, AEJ	2771	ch.→4A-S-026714	0-N940	TB [TE]	
2.8, 2.8 quattro	06/94-12/97	AAH, AEJ	2771	ch.→4A-S-026714	0-N941	TB [DG]	
2.8, 2.8 quattro	12/95-12/97	ACK	2771		0-N1238	TB [TE]	
2.8, 2.8 quattro	12/95-12/97	ACK	2771		0-N1371	TB [TE]	
2.8, 2.8 quattro	12/95-12/97	ACK	2771		0-N1372	TB [BT]	
2.8, 2.8 quattro	12/95-12/97	ACK	2771		0-N2001	TB [DG]	
S6 4.2 quattro, S6 Plus quattro	06/94-12/97	AEC, AHK	4172		0-N2414	TB [VD]	
S6 Turbo quattro	06/94-12/97	AAN	2226		0-N941	TB [DG]	
1.8, 1.8 quattro	12/95-12/97	ADR	1781	Rippenanzahl: 4	0-N1317	VB [TE]	S
1.9 TDI	06/94-12/97	1Z, AHU	1896		0-N1417	VB [TE]	
1.9 TDI	06/94-12/97	1Z, AHU	1896		0-N1609	VB [BT]	
2.0 16V, 2.0 16V quattro	06/94-12/97	ACE	1984		0-N2345	VB [DG]	
2.6, 2.6 quattro	06/94-12/97	ABC	2598	ch.4A-S-026715→	0-N1083	VB [BT]	S
2.6, 2.6 quattro	06/94-12/97	ABC	2598		0-N1414	VB [DG]	
2.8, 2.8 quattro	06/94-12/97	AAH, AEJ	2771	ch.4A-S-026715→	0-N1083	VB [BT]	S
2.8, 2.8 quattro	06/94-12/97	AAH, AEJ	2771		0-N1414	VB [DG]	
2.8, 2.8 quattro	12/95-12/97	ACK	2771		0-N1083	VB [BT]	S
S6 4.2 quattro, S6 Plus quattro	06/94-12/97	AEC, AHK	4172		0-N1632	VB [DG]	
S6 4.2 quattro, S6 Plus quattro	06/94-12/97	AEC, AHK	4172		0-N1967	VB [VD]	

A6 (4B2, C5)

1.8	07/97-01/05	AJP, ANQ, AQE, ARH	1781	23x150; 12/1997 →; mit Spanndämpfer, Spannrolle	SK-1337	BTK	
1.8	07/97-01/05	AJP, ANQ, AQE, ARH	1781	23x150; 12/1997 →	SK-1709	BTK	
1.8 T	01/97-01/05	AEB, ANB, APU, ARK	1781	25x153; 04/1997 →; mit Spanndämpfer, Spannrolle; mit Zubehör	SK-1638	BTK	
1.8 T	01/97-01/05	AWT	1781	23x150; ch.4B-1-040001→; 04/1997 →; ohne Spanndämpfer, Spannrolle; mit Zubehör	SK-1640	BTK	
1.8 T	01/97-01/05	AWT	1781	23x150; ch.→4B-1-040000; 04/1997 →	SK-1660	BTK	
1.8 T	01/97-01/05	AWT	1781	23x150; ch.→4B-1-040000; 04/1997 →	SK-1660AQ1	BTKW	
1.8 T quattro	02/97-01/05	AEB, ANB, APU, ARK	1781	25x153; mit Spanndämpfer, Spannrolle; mit Zubehör	SK-1638	BTK	
1.8 T quattro	02/97-01/05	AWT	1781	23x150; ch.4B-1-040001→; ohne Spanndämpfer, Spannrolle; mit Zubehör	SK-1640	BTK	
1.8 T quattro	02/97-01/05	AWT	1781	23x150; ch.→4B-1-040000	SK-1660	BTK	
1.8 T quattro	02/97-01/05	AWT	1781	23x150; ch.→4B-1-040000	SK-1660AQ1	BTKW	
1.8 T, 1.8 T quattro	01/97-01/05	AEB, ANB, APU, ARK	1781	25x153; mit Zubehör	SK-1346	BTK	
1.8 T, 1.8 T quattro	01/97-01/05	AWT	1781	23x150; ch.4B-1-040001→; ohne Spanndämpfer, Spannrolle; mit Zubehör	SK-1640AQ1	BTKW	
1.8 T, 1.8 T quattro	01/97-01/05	AWT	1781	23x150; ch.→4B-1-040000; 04/1997 →	SK-1710	BTK	
1.8 T, 1.8 T quattro	01/97-01/05	AWT	1781	23x150; mit Zubehör	SK-1726	BTK	
1.8 T, 1.8 T quattro	01/97-01/05	AWT	1781	23x150; mit Zubehör	SK-1726AQ1	BTKW	
1.8, 1.8 T, 1.8 T quattro	05/97-01/05	AFY, AJL	1781	25x153; mit Zubehör; Baumuster: 4B2	SK-1346	BTK	

CM³

Art. Nr.



ohne Halter

A6 (4B2, C5)

1.8, 1.8 T, 1.8 T quattro	05/97-01/05	AFY, AJL	1781	25x153; mit Spanndämpfer, Spannrolle; mit Zubehör	SK-1638	BTK
1.9 TDI	04/97-10/00	AFN, AVG	1896	25x137; mit Zubehör	SK-1098	BTK
1.9 TDI	07/00-01/05	AJM	1896	30x120; 11/2000 →; mit Spanndämpfer, Spannrolle; mit Zubehör; Baumuster: 4B2	SK-1378	BTK
1.9 TDI	07/00-01/05	AJM	1896	30x120; mit Spanndämpfer, Spannrolle	SK-1378AQ1	BTKW
1.9 TDI	07/00-01/05	AJM	1896	30x120; 11/2000 →; ohne Spanndämpfer, Spannrolle; mit Zubehör; Baumuster: 4B2	SK-1388	BTK
1.9 TDI	07/00-01/05	AJM	1896	30x120; ohne Spanndämpfer, Spannrolle; mit Zubehör	SK-1388AQ1	BTKW
1.9 TDI	08/01-01/05	AVF, AWX	1896	30x120; ch.4B-2-120001→; mit Zubehör	SK-1372	BTK
1.9 TDI	08/01-01/05	AVF, AWX	1896	30x120; ch.4B-2-120001→	SK-1372AQ2	BTKW
1.9 TDI	08/01-01/05	AVF, AWX	1896	30x120; ch.→4B-2-120000; mit Zubehör; Baumuster: 4B2	SK-1582	BTK
1.9 TDI	08/01-01/05	AVF, AWX	1896	30x120; ch.→4B-2-120000; ohne Spanndämpfer, Spannrolle; mit Zubehör	SK-1582AQ1	BTKW
1.9 TDI	08/01-01/05	AVF, AWX	1896	30x120; ch.→4B-2-120000; mit Spanndämpfer, Spannrolle; mit Zubehör; Baumuster: 4B2	SK-1583	BTK
1.9 TDI	08/01-01/05	AVF, AWX	1896	30x120; ch.→4B-2-120000; mit Spanndämpfer, Spannrolle; mit Zubehör	SK-1583AQ1	BTKW
2.0	08/01-01/05	ALT	1984	23x150; ohne Spanndämpfer, Spannrolle; mit Zubehör	SK-1640	BTK
2.0	08/01-01/05	ALT	1984	23x150; ohne Spanndämpfer, Spannrolle; mit Zubehör	SK-1640AQ2	BTKW
2.0	08/01-01/05	ALT	1984	23x150; mit Zubehör	SK-1726	BTK
2.0	08/01-01/05	ALT	1984	23x150; mit Zubehör	SK-1726AQ2	BTKW
2.4	02/97-01/05	APC	2393	30x253; 04/1998 →; mit Spanndämpfer, Spannrolle; mit Zubehör; Baumuster: 4B2	SK-1377	BTK
2.4	02/97-01/05	AJG, AMM, APZ	2393	30x253; mit Spanndämpfer, Spannrolle; mit Zubehör; Baumuster: 4B2	SK-1377	BTK
2.4	02/97-01/05	APC	2393	30x253; 04/1998 →; ohne Spanndämpfer, Spannrolle; mit Zubehör	SK-1383	BTK
2.4	02/97-01/05	AJG, APZ	2393	30x253; ch.→4B-X-160000; mit Zubehör	SK-1383AQ1	BTKW
2.4	07/98-01/05	ALW, ARN, ASM	2393	30x253; mit Spanndämpfer, Spannrolle; mit Zubehör; Baumuster: 4B2	SK-1377	BTK
2.4 quattro	02/97-01/05	AJG, APZ	2393	30x253; mit Spanndämpfer, Spannrolle; mit Zubehör; Baumuster: 4B2	SK-1377	BTK
2.4, 2.4 quattro	02/97-01/05	AGA, ALF, AML, APS, ARJ	2393	30x253; mit Spanndämpfer, Spannrolle; mit Zubehör; Baumuster: 4B2	SK-1377	BTK
2.4, 2.4 quattro	02/97-01/05	AGA, ALF, AML, APS, ARJ, AJG, AMM, APZ, AJG, APZ, ALW, ARN, ASM, APC, BDV	2393	30x253; mit Spanndämpfer, Spannrolle; mit Zubehör	SK-1377AQ1	BTKW
2.4, 2.4 quattro	02/97-01/05	AGA, ALF, AML, APS, ARJ, AJG, AMM, APZ, AJG, APZ	2393	30x253; 05/1997 →; ohne Spanndämpfer, Spannrolle; mit Zubehör	SK-1383	BTK
2.4, 2.4 quattro	02/97-01/05	AGA, ALF, AML, APS, ARJ, AJG, APZ	2393	30x253; ch.→4B-X-160000; mit Zubehör	SK-1383AQ1	BTKW
2.4, 2.4 quattro	07/98-01/05	ALW, ARN, ASM, APC, BDV	2393	30x253; ohne Spanndämpfer, Spannrolle; mit Zubehör	SK-1383	BTK
2.4, 2.4 quattro	08/98-01/05	APC, BDV	2393	30x253; mit Spanndämpfer, Spannrolle; mit Zubehör; Baumuster: 4B2	SK-1377	BTK
2.5 TDI	02/00-01/05	AKE, BAU, BDH	2496	32x207; 24x87; ch.→4B-Y-050000; ohne Spanndämpfer, Spannrolle; mit Zubehör; Baumuster: 4B2	SK-1375	BTK
2.5 TDI	02/00-01/05	AKE, BAU, BDH, BND	2496	32x207; 24x87; ch.4B-Y-050001→; mit Spanndämpfer, Spannrolle; mit Zubehör	SK-1633AQ1	BTKW
2.5 TDI	08/01-01/05	AYM	2496	30x207; 24x87; ch.4B-Y-050001→; ohne Spanndämpfer, Spannrolle; mit Zubehör; Baumuster: 4B2	SK-1619	BTK
2.5 TDI	08/01-01/05	AYM	2496	30x207; 24x87; ch.4B-Y-050001→; mit Spanndämpfer, Spannrolle; mit Zubehör; Baumuster: 4B2	SK-1621	BTK
2.5 TDI	07/02-01/05	BCZ, BDG, BFC	2496	30x207; 24x87; ohne Spanndämpfer, Spannrolle; mit Zubehör; Baumuster: 4B2	SK-1619	BTK
2.5 TDI	07/02-01/05	BCZ, BDG, BFC	2496	30x207; 24x87; nur in Verbindung mit: 078 121 113 F; mit Zubehör	SK-1619AQ2	BTKW
2.5 TDI	07/02-01/05	BCZ, BDG, BFC	2496	30x207; 24x87; mit Spanndämpfer, Spannrolle; mit Zubehör; Baumuster: 4B2	SK-1621	BTK
2.5 TDI, 2.5 TDI quattro	07/97-01/05	AFB, AKN	2496	32x207; 24x87; ohne Spanndämpfer, Spannrolle; mit Zubehör; Baumuster: 4B2	SK-1375	BTK
2.5 TDI, 2.5 TDI quattro	07/97-01/05	AFB, AKN, BCZ, BDG, BFC	2496	30x207; 24x87; mit Spanndämpfer, Spannrolle; mit Zubehör	SK-1621AQ1	BTKW
2.5 TDI, 2.5 TDI quattro	07/97-01/05	AFB, AKN	2496	32x207; 24x87; mit Spanndämpfer, Spannrolle; mit Zubehör	SK-1633	BTK
2.5 TDI, 2.5 TDI quattro	07/97-01/05	AKN	2496	32x207; 24x87; ch.4B-X-037001→ 04/2001; mit Spanndämpfer, Spannrolle; mit Zubehör	SK-1633AQ1	BTKW



CM³



Art. Nr.



A6 (4B2, C5)							
2.5 TDI, 2.5 TDI quattro	02/00-01/05	AKE, BAU, BDH, AYM	2496	32x207; 24x87; ch.→4B-Y-050000; ohne Spanndämpfer, Spannrolle; mit Zubehör; Baumuster: 4B2	SK-1375	BTK	
2.5 TDI, 2.5 TDI quattro	02/00-01/05	AKE, BAU, BDH	2496	30x207; 24x87; ch.4B-Y-050001→; ohne Spanndämpfer, Spannrolle; mit Zubehör; Baumuster: 4B2	SK-1619	BTK	
2.5 TDI, 2.5 TDI quattro	02/00-01/05	AKE, BAU, BDH, AKE, BAU, BDH, BND, AYM	2496	30x207; 24x87; ch.4B-Y-050001→; nur in Verbindung mit: 078 121 113 F; mit Zubehör	SK-1619AQ2	BTKW	
2.5 TDI, 2.5 TDI quattro	02/00-01/05	AKE, BAU, BDH	2496	30x207; 24x87; ch.4B-Y-050001→; mit Spanndämpfer, Spannrolle; mit Zubehör; Baumuster: 4B2	SK-1621	BTK	
2.5 TDI, 2.5 TDI quattro	02/00-01/05	AKE, BAU, BDH, AKE, BAU, BDH, BND, AYM	2496	30x207; 24x87; ch.4B-Y-050001→; mit Spanndämpfer, Spannrolle; mit Zubehör	SK-1621AQ1	BTKW	
2.5 TDI, 2.5 TDI quattro	02/00-01/05	AKE, BAU, BDH, AKE, BAU, BDH, BND, AYM	2496	32x207; 24x87; ch.→4B-Y-050000; mit Spanndämpfer, Spannrolle; mit Zubehör	SK-1633	BTK	
2.5 TDI, 2.5 TDI quattro	02/00-01/05	AKE, BAU, BDH, AYM, BCZ, BDG, BFC	2496	32x207; 24x87; mit Spanndämpfer, Spannrolle; mit Zubehör	SK-1633AQ1	BTKW	
2.7 T	02/99-01/05	AJK	2671	30x253; mit Spanndämpfer, Spannrolle; mit Zubehör; Baumuster: 4B2	SK-1377	BTK	
2.7 T quattro	12/97-01/05	AJK, AZA	2671	30x253; 02/1999 →; mit Spanndämpfer, Spannrolle; mit Zubehör; Baumuster: 4B2	SK-1377	BTK	
2.7 T quattro	12/97-01/05	AJK, AZA	2671	30x253; 02/1999 →; ohne Spanndämpfer, Spannrolle; mit Zubehör	SK-1383	BTK	
2.7 T quattro	08/01-01/05	ARE, BES	2671	30x253; mit Spanndämpfer, Spannrolle; mit Zubehör; Baumuster: 4B2	SK-1377	BTK	
2.7 T, 2.7 T quattro	02/99-01/05	AJK, ARE, BES	2671	30x253; ohne Spanndämpfer, Spannrolle; mit Zubehör	SK-1383	BTK	
2.7, 2.7 quattro	05/01-07/04	APB, BEL, BEL	2671	30x253; mit Spanndämpfer, Spannrolle; mit Zubehör	SK-1377	BTK	
2.8	02/97-01/05	ACK, AHA, ALG, AMX, APR, AQD	2771	30x253; 05/1997 →; ohne Spanndämpfer, Spannrolle; mit Zubehör	SK-1383	BTK	
2.8	10/97-05/00	AGE	2771	30x253; ch.→4B-X-160000; mit Zubehör	SK-1383AQ1	BTKW	
2.8	07/99-01/05	ATX	2771	30x253; mit Spanndämpfer, Spannrolle; mit Zubehör; Baumuster: 4B2	SK-1377	BTK	
2.8 quattro	01/98-04/00	AGE	2771	30x253; mit Spanndämpfer, Spannrolle; mit Zubehör	SK-1377	BTK	
2.8, 2.8 quattro	02/97-01/05	ACK, AHA, ALG, AMX	2771	30x253; mit Spanndämpfer, Spannrolle; mit Zubehör; Baumuster: 4B2	SK-1377	BTK	
2.8, 2.8 quattro	02/97-01/05	ACK, AHA, ALG, AMX, APR, AQD, AGE, ATX, ATX, BBG	2771	30x253; mit Spanndämpfer, Spannrolle; mit Zubehör	SK-1377AQ1	BTKW	
2.8, 2.8 quattro	02/97-01/05	ACK, AHA, ALG, AMX, APR, AQD, AGE, ATX, ATX, BBG	2771	30x253; ohne Spanndämpfer, Spannrolle; mit Zubehör	SK-1383	BTK	
2.8, 2.8 quattro	02/97-01/05	ACK, ALG, APR, AQD	2771	30x253; ch.→4B-X-160000; mit Zubehör	SK-1383AQ1	BTKW	
2.8, 2.8 quattro	10/97-05/01	AGE, ATX	2771	30x253; mit Spanndämpfer, Spannrolle; mit Zubehör; Baumuster: 4B2	SK-1377	BTK	
3.0, 3.0 quattro	06/01-01/05	ASN, BBJ	2976	30x281; ohne Spanndämpfer, Spannrolle	SK-1538	BTK	
3.0, 3.0 quattro	06/01-01/05	ASN, BBJ	2976	30x281; mit Spanndämpfer, Spannrolle	SK-1601	BTK	
3.7	03/99-01/05	AQG	3697	30x253; ch.4D-Y-016501→	SK-1386AQ1	BTKW	
3.7 quattro	03/99-01/05	AQG	3697	30x253; ch.4B-Y-085001→	SK-1386AQ1	BTKW	
4.2 quattro	11/98-01/05	ARS, ASG	4172	30x253; ch.4B-Y-085001→	SK-1386AQ1	BTKW	
4.2 quattro	11/98-01/05	ARS, ASG, AWN	4172	30x253; ch.→4B-Y-085000; 04/1999 →	SK-1687	BTK	
4.2 quattro	11/98-01/05	ARS, ASG, AWN	4172	30x253; ch.4B-Y-085001→; 04/1999 →	SK-1688	BTK	
RS6 quattro	07/02-01/05	BCY	4172	30x253	SK-1386AQ1	BTKW	
RS6 quattro	07/02-01/05	BCY	4172	30x253	SK-1688	BTK	
S6 quattro	09/99-01/05	ANK, AQJ	4172	30x253; ch.4B-Y-085001→	SK-1386AQ1	BTKW	
S6 quattro	09/99-01/05	ANK, AQJ	4172	30x253; ch.→4B-Y-085000	SK-1687	BTK	
S6 quattro	09/99-01/05	ANK, AQJ	4172	30x253; ch.4B-Y-085001→	SK-1688	BTK	
1.8	07/97-01/05	AJP, ANQ, AQE, ARH	1781		0-N1237	TB [BT]	
1.8	07/97-01/05	AJP, ANQ, AQE, ARH	1781		0-N1316	TB [DG]	
1.8	07/97-01/05	AJP, ANQ, AQE, ARH	1781	12/1997 →	0-N1654	TB [TE]	
1.8 T	01/97-01/05	AWT	1781	ch.4B-1-040001→; 04/1997 →	0-N1050	TB [TE]	
1.8 T	01/97-01/05	AWL, AWT	1781	→ 01/1998	0-N1237	TB [BT]	
1.8 T quattro	02/97-01/05	AWT	1781	ch.4B-1-040001→	0-N1050	TB [TE]	
1.8 T quattro	02/97-01/05	AWT	1781	→ 06/2001	0-N1237	TB [BT]	
1.8 T, 1.8 T quattro	01/97-01/05	AWT	1781	ch.→4B-1-040000; 04/1997 →	0-N1042	TB [TE]	
1.8 T, 1.8 T quattro	01/97-01/05	AEB, ANB, APU, ARK	1781	ch.4B-X-140001→	0-N1236	TB [TE]	
1.8 T, 1.8 T quattro	01/97-01/05	AEB, ANB, APU, ARK	1781	ch.4B-X-140001→	0-N1276	TB [BT]	
1.8 T, 1.8 T quattro	01/97-01/05	AEB, ANB, APU, ARK	1781		0-N131	TB [DG]	
1.8 T, 1.8 T quattro	01/97-01/05	AWT	1781		0-N1316	TB [DG]	
1.8 T, 1.8 T quattro	01/97-01/05	AWT	1781	Spannrollenbetätigung: automatisch	0-N2195	TB [TE]	
1.8 T, 1.8 T quattro	01/97-01/05	AWT	1781		0-N2234	TB [DG]	



OPTIMAL®

AUDI



CM³



Art. Nr.



A6 (4B2, C5)

1.8, 1.8 T, 1.8 T quattro	01/97-01/05	AEB, ANB, APU, ARK, AWL, AWT, AEB, ANB, APU, ARK, AWT, AFY, AJL, AJP, ANQ, AQE, ARH	1781		0-N1822	TB [BT]	S
1.8, 1.8 T, 1.8 T quattro	05/97-01/05	AFY, AJL	1781		0-N1236	TB [TE]	
1.8, 1.8 T, 1.8 T quattro	05/97-01/05	AFY, AJL	1781		0-N1276	TB [BT]	
1.8, 1.8 T, 1.8 T quattro	05/97-01/05	AFY, AJL	1781		0-N131	TB [DG]	
1.9 TDI	04/97-10/00	AFN, AVG	1896		0-N104	TB [TE]	
1.9 TDI	04/97-10/00	AFN, AVG	1896		0-N128	TB [DG]	
1.9 TDI	07/00-01/05	AJM	1896		0-N1049	TB [BT]	
1.9 TDI	07/00-01/05	AJM	1896	mit Anbaumaterial	0-N1265	TB [TE]	
1.9 TDI	07/00-01/05	AJM	1896		0-N1268	TB [DG]	
1.9 TDI	08/01-01/05	AVF, AWX	1896	ch.4B-2-120001→	0-N1045	TB [TE]	
1.9 TDI	08/01-01/05	AVF, AWX	1896	ch.4B-2-120001→	0-N1046	TB [DG]	
1.9 TDI	08/01-01/05	AVF, AWX	1896	ch.→4B-2-120000	0-N1048	TB [TE]	
1.9 TDI	08/01-01/05	AVF, AWX	1896	ch.→4B-2-120000	0-N1268	TB [DG]	
1.9 TDI	08/01-01/05	AVF, AWX	1896	ch.→4B-2-120000	0-N1274	TB [BT]	
2.0	08/01-01/05	ALT	1984		0-N1050	TB [TE]	
2.0	08/01-01/05	ALT	1984		0-N1051	TB [BT]	S
2.0	08/01-01/05	ALT	1984		0-N1316	TB [DG]	
2.4, 2.4 quattro	02/97-01/05	AGA, ALF, AML, APS, ARJ, AJG, AMM, APZ, AJG, APZ, ALW, ARN, ASM, APC, BDV	2393		0-N1238	TB [TE]	
2.4, 2.4 quattro	02/97-01/05	AGA, ALF, AML, APS, ARJ, AJG, AMM, APZ, AJG, APZ, ALW, ARN, ASM, APC, BDV	2393		0-N1275	TB [BT]	
2.4, 2.4 quattro	02/97-01/05	AGA, ALF, AML, APS, ARJ, AJG, AMM, APZ, AJG, APZ, ALW, ARN, ASM, APC, BDV	2393		0-N1371	TB [TE]	
2.4, 2.4 quattro	02/97-01/05	AGA, ALF, AML, APS, ARJ, AJG, AMM, APZ, AJG, APZ, ALW, ARN, ASM, APC, BDV	2393		0-N2001	TB [DG]	
2.5 TDI, 2.5 TDI quattro	07/97-01/05	AFB, AKN, AKE, BAU, BDH, AKE, BAU, BDH, BND, AYM, BCZ, BDG, BFC	2496		0-N1266	TB [TE]	
2.5 TDI, 2.5 TDI quattro	07/97-01/05	AFB, AKN, AKE, BAU, BDH, AKE, BAU, BDH, BND, AYM, BCZ, BDG, BFC	2496		0-N1363	TB [TE]	
2.5 TDI, 2.5 TDI quattro	07/97-01/05	AFB, AKN, AKE, BAU, BDH, AKE, BAU, BDH, BND, AYM, BCZ, BDG, BFC	2496		0-N1364	TB [BT]	
2.5 TDI, 2.5 TDI quattro	07/97-01/05	AFB, AKN, AKE, BAU, BDH, AKE, BAU, BDH, BND, AYM, BCZ, BDG, BFC	2496		0-N168	TB [DG]	
2.5 TDI, 2.5 TDI quattro	07/97-01/05	AFB, AKN, AKE, BAU, BDH, AKE, BAU, BDH, BND, AYM, BCZ, BDG, BFC	2496		0-N201	TB [BT]	
2.7 T, 2.7 T quattro	12/97-01/05	AJK, AJK, AZA, ARE, BES	2671		0-N1238	TB [TE]	
2.7 T, 2.7 T quattro	12/97-01/05	AJK, AJK, AZA, ARE, BES	2671		0-N1275	TB [BT]	
2.7 T, 2.7 T quattro	12/97-01/05	AJK, AJK, AZA, ARE, BES	2671		0-N1371	TB [TE]	
2.7 T, 2.7 T quattro	12/97-01/05	AJK, AJK, AZA, ARE, BES	2671		0-N2001	TB [DG]	
2.8, 2.8 quattro	02/97-01/05	ACK, AHA, ALG, AMX, APR, AQD, AGE, ATX, ATX, BBG	2771		0-N1238	TB [TE]	
2.8, 2.8 quattro	02/97-01/05	ACK, AHA, ALG, AMX, APR, AQD	2771	01/1998 →	0-N1275	TB [BT]	
2.8, 2.8 quattro	02/97-01/05	ACK, AHA, ALG, AMX, APR, AQD, AGE, ATX, ATX, BBG	2771		0-N1371	TB [TE]	
2.8, 2.8 quattro	02/97-01/05	ACK, AHA, ALG, AMX, APR, AQD, AGE, ATX, ATX, BBG	2771		0-N2001	TB [DG]	
2.8, 2.8 quattro	10/97-01/05	AGE, ATX, ATX, BBG	2771		0-N1275	TB [BT]	
3.0, 3.0 quattro	06/01-01/05	ASN, BBJ	2976		0-N1052	TB [DG]	
3.0, 3.0 quattro	06/01-01/05	ASN, BBJ	2976		0-N1342	TB [BT]	
3.0, 3.0 quattro	08/01-01/05	ASN	2976		0-N1053	TB [DG]	
3.0, 3.0 quattro	08/01-01/05	ASN	2976		0-N1054	TB [TE]	
3.7, 3.7 quattro	03/99-01/05	AQG	3697	ch.→4B-Y-085000	0-N1364	TB [BT]	
3.7, 3.7 quattro	03/99-01/05	AQG	3697		0-N1568	TB [TE]	
3.7, 3.7 quattro	03/99-01/05	AQG	3697	ch.4B-Y-085001→	0-N1569	TB [BT]	
3.7, 3.7 quattro	03/99-01/05	AQG	3697		0-N1570	TB [DG]	
3.7, 3.7 quattro	03/99-01/05	AQG	3697		0-N169	TB [DG]	
4.2 quattro, RS6 quattro, S6 quattro	11/98-01/05	ANK, AQJ, ARS, ASG, AWN, BCY	4172		0-N1568	TB [TE]	
4.2 quattro, RS6 quattro, S6 quattro	11/98-01/05	ANK, AQJ, ARS, ASG, AWN, BCY	4172		0-N1569	TB [BT]	
4.2 quattro, RS6 quattro, S6 quattro	11/98-01/05	ANK, AQJ, ARS, ASG, AWN, BCY	4172		0-N1570	TB [DG]	
4.2 quattro, RS6 quattro, S6 quattro	11/98-01/05	ANK, AQJ, ARS, ASG, AWN, BCY	4172		0-N169	TB [DG]	
4.2 quattro, S6 quattro	11/98-01/05	ANK, AQJ, ARS, ASG, AWN	4172	ch.→4B-Y-085000	0-N1364	TB [BT]	
1.8, 1.8 T, 1.8 T quattro	01/97-01/05	AEB, ANB, APU, ARK, AWL, AWT, AEB, ANB, APU, ARK, AWT, AFY, AJL, AJP, ANQ, AQE, ARH	1781	Rippenanzahl: 4	0-N1317	VB [TE]	S



CM³



Art. Nr.



A6 (4B2, C5)							
1.9 TDI	04/97-01/05	AFN, AVG, AVF, AWX	1896	Rippenanzahl: 4	0-N1317	VB [TE]	S
1.9 TDI	04/97-10/00	AFN, AVG	1896	Rippenanzahl: 5	0-N1432	VB [TE]	S
1.9 TDI	07/00-01/05	AJM, AVF, AWX	1896	Rippenanzahl: 5	0-N1441	VB [BT]	S
1.9 TDI	07/00-01/05	AJM, AVF, AWX	1896		0-N2047	VB [DG]	
1.9 TDI	07/00-01/05	AJM, AVF, AWX	1896		0-N2139	VB [VD]	
2.0	08/01-01/05	ALT	1984		0-N1662	VB [DG]	
2.0	08/01-01/05	ALT	1984		0-N1671	VB [BT]	S
2.4, 2.4 quattro	02/97-01/05	AGA, ALF, AML, APS, ARJ, AJG, AMM, APZ, AJG, APZ, ALW, ARN, ASM, APC, BDV	2393		0-N1083	VB [BT]	S
2.5 TDI, 2.5 TDI quattro	07/97-01/05	AFB, AKN, AKE, BAU, BDH, AKE, BAU, BDH, BND, AYM, BCZ, BDG, BFC	2496		0-N1005	VB [TE]	
2.5 TDI, 2.5 TDI quattro	07/97-01/05	AFB, AKN, AKE, BAU, BDH, AKE, BAU, BDH, BND, AYM, BCZ, BDG, BFC	2496		0-N1308	VB [TE]	
2.5 TDI, 2.5 TDI quattro	07/97-01/05	AFB, AKN, AKE, BAU, BDH, AKE, BAU, BDH, BND, AYM, BCZ, BDG, BFC	2496		0-N1315	VB [DG]	
2.5 TDI, 2.5 TDI quattro	07/97-01/05	AFB, AKN, AKE, BAU, BDH, AKE, BAU, BDH, BND, AYM, BCZ, BDG, BFC	2496	Rippenanzahl: 6	0-N1431	VB [DG]	
2.5 TDI, 2.5 TDI quattro	07/97-01/05	AFB, AKN, AKE, BAU, BDH, AKE, BAU, BDH, BND, AYM, BCZ, BDG, BFC	2496		0-N1947	VB [VD]	
2.5 TDI, 2.5 TDI quattro	07/97-01/05	AFB, AKN, AKE, BAU, BDH, AKE, BAU, BDH, BND, AYM, BCZ, BDG, BFC	2496		0-N2196	VB [BT]	
2.5 TDI, 2.5 TDI quattro	07/97-01/05	AFB, AKN, AKE, BAU, BDH, AKE, BAU, BDH, BND, AYM, BCZ, BDG, BFC	2496		0-N2258	VB [BT]	
2.5 TDI, 2.5 TDI quattro	07/97-01/05	AFB, AKN, AKE, BAU, BDH, AKE, BAU, BDH, BND, AYM, BCZ, BDG, BFC	2496		0-N2417	VB [BT]	
2.7 T, 2.7 T quattro	12/97-01/05	AJK, AJK, AZA, ARE, BES	2671		0-N1083	VB [BT]	S
2.8, 2.8 quattro	02/97-01/05	ACK, AHA, ALG, AMX, APR, AQD, AGE, ATX, ATX, BBG	2771		0-N1083	VB [BT]	S
3.0 quattro	06/01-07/04	BBJ	2976	ch.4F-5-000001→	0-N2407	VB [BT]	S
3.0, 3.0 quattro	06/01-01/05	ASN, BBJ	2976		0-N1537	VB [BT]	S
3.7, 3.7 quattro	03/99-01/05	AQG	3697		0-N1632	VB [DG]	
4.2 quattro	11/98-01/05	ARS, ASG	4172		0-N1889	VB [BT]	S
4.2 quattro, RS6 quattro, S6 quattro	11/98-01/05	ANK, AQJ, ARS, ASG, AWN, BCY	4172		0-N1632	VB [DG]	
RS6 quattro, S6 quattro	09/99-01/05	ANK, AQJ, BCY	4172		0-N1889	VB [BT]	S

A6 Avant (4B5, C5)							
1.8	12/97-01/05	AJP, AQE, ARH	1781	23x150; mit Spanndämpfer, Spannrolle	SK-1337	BTK	
1.8	12/97-01/05	AJP, AQE, ARH	1781	23x150; 02/1998 →	SK-1709	BTK	
1.8 T	12/97-01/05	AWT	1781	23x150; ch.→4B-1-040000; 02/1998 →	SK-1710	BTK	
1.8 T quattro	12/97-01/05	AWT	1781	23x150; ch.→4B-1-040000	SK-1710	BTK	
1.8 T, 1.8 T quattro	12/97-01/05	AEB, ANB, APU, ARK	1781	25x153; mit Zubehör	SK-1346	BTK	
1.8 T, 1.8 T quattro	12/97-01/05	AEB, ANB, APU, ARK	1781	25x153; mit Spanndämpfer, Spannrolle; mit Zubehör	SK-1638	BTK	
1.8 T, 1.8 T quattro	12/97-01/05	AWT	1781	23x150; ch.4B-1-040001→; ohne Spanndämpfer, Spannrolle; mit Zubehör	SK-1640	BTK	
1.8 T, 1.8 T quattro	12/97-01/05	AWT	1781	23x150; ch.4B-1-040001→; ohne Spanndämpfer, Spannrolle; mit Zubehör	SK-1640AQ1	BTKW	
1.8 T, 1.8 T quattro	12/97-01/05	AWT	1781	23x150; ch.→4B-1-040000	SK-1660	BTK	
1.8 T, 1.8 T quattro	12/97-01/05	AWT	1781	23x150; ch.→4B-1-040000	SK-1660AQ1	BTKW	
1.8 T, 1.8 T quattro	12/97-01/05	AWT	1781	23x150; mit Zubehör	SK-1726	BTK	
1.8 T, 1.8 T quattro	12/97-01/05	AWT	1781	23x150; mit Zubehör	SK-1726AQ1	BTKW	
1.8, 1.8 T, 1.8 T quattro	12/97-01/05	AFY, AJL	1781	25x153; mit Zubehör; Baumuster: 4B5	SK-1346	BTK	
1.8, 1.8 T, 1.8 T quattro	12/97-01/05	AFY, AJL	1781	25x153; mit Spanndämpfer, Spannrolle; mit Zubehör	SK-1638	BTK	
1.9 TDI	02/98-04/01	AFN	1896	25x137; mit Zubehör	SK-1098	BTK	
1.9 TDI	07/00-01/05	AJM	1896	30x120; 11/2000 →; mit Spanndämpfer, Spannrolle; mit Zubehör; Baumuster: 4B5	SK-1378	BTK	
1.9 TDI	07/00-01/05	AJM	1896	30x120; mit Spanndämpfer, Spannrolle	SK-1378AQ1	BTKW	
1.9 TDI	07/00-01/05	AJM	1896	30x120; 11/2000 →; ohne Spanndämpfer, Spannrolle; mit Zubehör; Baumuster: 4B5	SK-1388	BTK	
1.9 TDI	07/00-01/05	AJM	1896	30x120; ohne Spanndämpfer, Spannrolle; mit Zubehör	SK-1388AQ1	BTKW	
1.9 TDI	08/01-01/05	AVF, AWX	1896	30x120; ch.4B-2-120001→; mit Zubehör	SK-1372	BTK	
1.9 TDI	08/01-01/05	AVF, AWX	1896	30x120; ch.4B-2-125001→	SK-1372AQ2	BTKW	
1.9 TDI	08/01-01/05	AVF, AWX	1896	30x120; ch.→4B-2-120000; mit Zubehör; Baumuster: 4B5	SK-1582	BTK	
1.9 TDI	08/01-01/05	AVF, AWX	1896	30x120; ch.→4B-2-120000; ohne Spanndämpfer, Spannrolle; mit Zubehör	SK-1582AQ1	BTKW	
1.9 TDI	08/01-01/05	AVF, AWX	1896	30x120; ch.→4B-2-120000; mit Spanndämpfer, Spannrolle; mit Zubehör; Baumuster: 4B5	SK-1583	BTK	

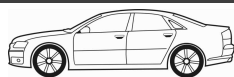

CM³



Art. Nr.



ohne Halter

A6 Avant (4B5, C5)

1.9 TDI	08/01-01/05	AVF, AWX	1896	30x120; ch.→4B-2-120000; mit Spanndämpfer, Spannrolle; mit Zubehör	SK-1583AQ1	BTKW
2.0	08/01-01/05	ALT	1984	23x150; ohne Spanndämpfer, Spannrolle; mit Zubehör	SK-1640	BTK
2.0	08/01-01/05	ALT	1984	23x150; ohne Spanndämpfer, Spannrolle; mit Zubehör	SK-1640AQ2	BTKW
2.0	08/01-01/05	ALT	1984	23x150; mit Zubehör	SK-1726	BTK
2.0	08/01-01/05	ALT	1984	23x150; mit Zubehör	SK-1726AQ2	BTKW
2.4	12/97-01/05	APC	2393	30x253; 04/1998 →; mit Spanndämpfer, Spannrolle; mit Zubehör; Baumuster: 4B5	SK-1377	BTK
2.4	12/97-01/05	AGA, ALF, AML, APS, ARJ	2393	30x253; mit Spanndämpfer, Spannrolle; mit Zubehör; Baumuster: 4B5	SK-1377	BTK
2.4	12/97-01/05	AJG, AMM, APZ	2393	30x253; mit Spanndämpfer, Spannrolle; mit Zubehör; Baumuster: 4B5	SK-1377	BTK
2.4	12/97-01/05	APC	2393	30x253; 04/1998 →; ohne Spanndämpfer, Spannrolle; mit Zubehör	SK-1383	BTK
2.4	12/97-01/05	AJG, APZ	2393	30x253; ch.→4B-X-160000; mit Zubehör	SK-1383AQ1	BTKW
2.4	07/98-01/05	ALW, ARN, ASM	2393	30x253; mit Spanndämpfer, Spannrolle; mit Zubehör; Baumuster: 4B5	SK-1377	BTK
2.4 quattro	12/97-01/05	AGA, AML, APS	2393	30x253; mit Spanndämpfer, Spannrolle; mit Zubehör; Baumuster: 4B5	SK-1377	BTK
2.4 quattro	12/97-01/05	AJG, APZ	2393	30x253; mit Spanndämpfer, Spannrolle; mit Zubehör; Baumuster: 4B5	SK-1377	BTK
2.4, 2.4 quattro	12/97-01/05	AGA, ALF, AML, APS, ARJ, AJG, AMM, APZ, AJG, APZ, ALW, ARN, ASM, APC, BDV	2393	30x253; mit Spanndämpfer, Spannrolle; mit Zubehör	SK-1377AQ1	BTKW
2.4, 2.4 quattro	12/97-01/05	AGA, ALF, AML, APS, ARJ, AJG, AMM, APZ, AJG, APZ, ALW, ARN, ASM, APC, BDV	2393	30x253; ohne Spanndämpfer, Spannrolle; mit Zubehör	SK-1383	BTK
2.4, 2.4 quattro	12/97-01/05	AGA, ALF, AML, APS, ARJ, AJG, APZ	2393	30x253; ch.→4B-X-160000; mit Zubehör	SK-1383AQ1	BTKW
2.4, 2.4 quattro	08/98-01/05	APC, BDV	2393	30x253; mit Spanndämpfer, Spannrolle; mit Zubehör; Baumuster: 4B5	SK-1377	BTK
2.5 TDI	08/01-01/05	AYM	2496	30x207; 24x87; ch.4B-Y-050001→; ohne Spanndämpfer, Spannrolle; mit Zubehör; Baumuster: 4B5	SK-1619	BTK
2.5 TDI	08/01-01/05	AYM	2496	30x207; 24x87; ch.4B-Y-050001→; mit Spanndämpfer, Spannrolle; mit Zubehör; Baumuster: 4B5	SK-1621	BTK
2.5 TDI	07/02-01/05	BCZ, BDG, BFC	2496	30x207; 24x87; ohne Spanndämpfer, Spannrolle; mit Zubehör; Baumuster: 4B5	SK-1619	BTK
2.5 TDI	07/02-01/05	BCZ, BDG, BFC	2496	30x207; 24x87; nur in Verbindung mit: 078 121 113 F; mit Zubehör	SK-1619AQ2	BTKW
2.5 TDI	07/02-01/05	BCZ, BDG, BFC	2496	30x207; 24x87; mit Spanndämpfer, Spannrolle; mit Zubehör; Baumuster: 4B5	SK-1621	BTK
2.5 TDI, 2.5 TDI quattro	12/97-01/05	AFB, AKN	2496	32x207; 24x87; ohne Spanndämpfer, Spannrolle; mit Zubehör; Baumuster: 4B5	SK-1375	BTK
2.5 TDI, 2.5 TDI quattro	12/97-01/05	AFB, AKN, BCZ, BDG, BFC	2496	30x207; 24x87; mit Spanndämpfer, Spannrolle; mit Zubehör	SK-1621AQ1	BTKW
2.5 TDI, 2.5 TDI quattro	12/97-01/05	AFB, AKN	2496	32x207; 24x87; mit Spanndämpfer, Spannrolle; mit Zubehör	SK-1633	BTK
2.5 TDI, 2.5 TDI quattro	12/97-01/05	AKN	2496	32x207; 24x87; ch.4B-X-037001→ 04/2001; mit Spanndämpfer, Spannrolle; mit Zubehör	SK-1633AQ1	BTKW
2.5 TDI, 2.5 TDI quattro	02/00-01/05	AKE, BAU, BDH, AYM	2496	32x207; 24x87; ch.→4B-Y-050000; ohne Spanndämpfer, Spannrolle; mit Zubehör; Baumuster: 4B5	SK-1375	BTK
2.5 TDI, 2.5 TDI quattro	02/00-01/05	AKE, BAU, BDH	2496	30x207; 24x87; ch.4B-Y-050001→; ohne Spanndämpfer, Spannrolle; mit Zubehör; Baumuster: 4B5	SK-1619	BTK
2.5 TDI, 2.5 TDI quattro	02/00-01/05	AKE, BAU, BDH, AYM	2496	30x207; 24x87; ch.4B-Y-050001→; nur in Verbindung mit: 078 121 113 F; mit Zubehör	SK-1619AQ2	BTKW
2.5 TDI, 2.5 TDI quattro	02/00-01/05	AKE, BAU, BDH	2496	30x207; 24x87; ch.4B-Y-050001→; mit Spanndämpfer, Spannrolle; mit Zubehör; Baumuster: 4B5	SK-1621	BTK
2.5 TDI, 2.5 TDI quattro	02/00-01/05	AKE, BAU, BDH, AYM	2496	30x207; 24x87; ch.4B-Y-050001→; mit Spanndämpfer, Spannrolle; mit Zubehör	SK-1621AQ1	BTKW
2.5 TDI, 2.5 TDI quattro	02/00-01/05	AKE, BAU, BDH, AYM	2496	32x207; 24x87; ch.→4B-Y-050000; mit Spanndämpfer, Spannrolle; mit Zubehör	SK-1633	BTK
2.5 TDI, 2.5 TDI quattro	02/00-01/05	AKE, BAU, BDH, AYM, BCZ, BDG, BFC	2496	32x207; 24x87; mit Spanndämpfer, Spannrolle; mit Zubehör	SK-1633AQ1	BTKW
2.7 T	02/99-01/05	AJK	2671	30x253; mit Spanndämpfer, Spannrolle; mit Zubehör; Baumuster: 4B5	SK-1377	BTK
2.7 T quattro	12/97-01/05	AJK, AZA	2671	30x253; 02/1999 →; mit Spanndämpfer, Spannrolle; mit Zubehör; Baumuster: 4B5	SK-1377	BTK
2.7 T quattro	12/97-01/05	AJK, AZA	2671	30x253; 02/1999 →; ohne Spanndämpfer, Spannrolle; mit Zubehör	SK-1383	BTK



CM³



Art. Nr.



A6 Avant (4B5, C5)

2.7 T quattro	08/01-01/05	ARE, BES	2671	30x253; mit Spanndämpfer, Spannrolle; mit Zubehör; Baumuster: 4B5	SK-1377	BTK	
2.7 T, 2.7 T quattro	02/99-01/05	AJK, ARE, BES	2671	30x253; ohne Spanndämpfer, Spannrolle; mit Zubehör	SK-1383	BTK	
2.8	12/97-01/05	ACK, ALG, AMX, APR, AQD	2771	30x253; mit Spanndämpfer, Spannrolle; mit Zubehör; Baumuster: 4B5	SK-1377	BTK	
2.8	12/97-01/05	AGE, ATX	2771	30x253; mit Spanndämpfer, Spannrolle; mit Zubehör; Baumuster: 4B5	SK-1377	BTK	
2.8	12/97-01/05	ACK, ALG, APR, AQD	2771	30x253; ch.→3B-X-160000; mit Zubehör	SK-1383AQ1	BTKW	
2.8	12/97-05/00	AGE	2771	30x253; ch.→4B-X-160000; mit Zubehör	SK-1383AQ1	BTKW	
2.8 quattro	12/97-01/05	AHA, AMX, AQD	2771	30x253; mit Spanndämpfer, Spannrolle; mit Zubehör; Baumuster: 4B5	SK-1377	BTK	
2.8 quattro	12/97-01/05	ACK, ALG, APR, AQD	2771	30x253; ch.→4B-X-160000; mit Zubehör	SK-1383AQ1	BTKW	
2.8, 2.8 quattro	12/97-01/05	ACK, AHA, ALG, AMX, APR, AQD, AGE, ATX	2771	30x253; mit Spanndämpfer, Spannrolle; mit Zubehör	SK-1377AQ1	BTKW	
2.8, 2.8 quattro	12/97-01/05	ACK, AHA, ALG, AMX, APR, AQD, AGE, ATX	2771	30x253; ohne Spanndämpfer, Spannrolle; mit Zubehör	SK-1383	BTK	
3.0, 3.0 quattro	08/01-01/05	ASN	2976	30x281; ohne Spanndämpfer, Spannrolle	SK-1538	BTK	
3.0, 3.0 quattro	08/01-01/05	ASN	2976	30x281; mit Spanndämpfer, Spannrolle	SK-1601	BTK	
3.7	03/99-01/05	AQG	3697	30x253; ch.4D-Y-016501→	SK-1386AQ1	BTKW	
3.7 quattro	03/99-01/05	AQG	3697	30x253; ch.4B-Y-085001→	SK-1386AQ1	BTKW	
4.2 quattro	11/98-01/05	ARS, ASG	4172	30x253; ch.4B-Y-085001→	SK-1386AQ1	BTKW	
4.2 quattro	11/98-01/05	ARS, ASG, AWN	4172	30x253; ch.→4B-Y-085000; 04/1999 →	SK-1687	BTK	
4.2 quattro	11/98-01/05	ARS, ASG, AWN	4172	30x253; ch.4B-Y-085001→; 04/1999 →	SK-1688	BTK	
RS6 plus quattro	04/04-01/05	BRV	4172	30x253	SK-1386	BTK	
RS6 plus quattro, RS6 quattro	07/02-01/05	BCY, BRV	4172	30x253	SK-1386AQ1	BTKW	
RS6 plus quattro, RS6 quattro	07/02-01/05	BCY, BRV	4172	30x253	SK-1688	BTK	
S6 quattro	09/99-01/05	ANK, AQJ	4172	30x253; ch.4B-Y-085001→	SK-1386AQ1	BTKW	
S6 quattro	09/99-01/05	ANK, AQJ	4172	30x253; ch.→4B-Y-085000	SK-1687	BTK	
S6 quattro	09/99-01/05	ANK, AQJ	4172	30x253; ch.4B-Y-085001→	SK-1688	BTK	
1.8	12/97-01/05	AJP, AQE, ARH	1781		0-N1237	TB [BT]	
1.8	12/97-01/05	AJP, AQE, ARH	1781		0-N1316	TB [DG]	
1.8	12/97-01/05	AJP, AQE, ARH	1781	02/1998 →	0-N1654	TB [TE]	
1.8 T	12/97-01/05	AWT	1781	ch.→4B-1-040000; 02/1998 →	0-N1042	TB [TE]	
1.8 T quattro	12/97-01/05	AWT	1781	ch.→4B-1-040000	0-N1042	TB [TE]	
1.8 T quattro	12/97-01/05	AWT	1781	→ 06/2001	0-N1237	TB [BT]	
1.8 T, 1.8 T quattro	12/97-01/05	AWT	1781	ch.4B-1-040001→	0-N1050	TB [TE]	
1.8 T, 1.8 T quattro	12/97-01/05	AEB, ANB, APU, ARK	1781	ch.4B-X-140001→	0-N1236	TB [TE]	
1.8 T, 1.8 T quattro	12/97-01/05	AEB, ANB, APU, ARK	1781	ch.4B-X-140001→	0-N1276	TB [BT]	
1.8 T, 1.8 T quattro	12/97-01/05	AEB, ANB, APU, ARK	1781		0-N131	TB [DG]	
1.8 T, 1.8 T quattro	12/97-01/05	AWT	1781		0-N1316	TB [DG]	
1.8 T, 1.8 T quattro	12/97-01/05	AWT	1781	Spannrollenbetätigung: automatisch	0-N2195	TB [TE]	
1.8 T, 1.8 T quattro	12/97-01/05	AWT	1781		0-N2234	TB [DG]	
1.8, 1.8 T, 1.8 T quattro	12/97-01/05	AFY, AJL	1781		0-N1236	TB [TE]	
1.8, 1.8 T, 1.8 T quattro	12/97-01/05	AFY, AJL	1781		0-N1276	TB [BT]	
1.8, 1.8 T, 1.8 T quattro	12/97-01/05	AFY, AJL	1781		0-N131	TB [DG]	
1.8, 1.8 T, 1.8 T quattro	12/97-01/05	AEB, ANB, APU, ARK, AWT, AFY, AJL, AJP, AQE, ARH	1781		0-N1822	TB [BT]	S
1.9 TDI	02/98-04/01	AFN	1896		0-N104	TB [TE]	
1.9 TDI	02/98-04/01	AFN	1896		0-N128	TB [DG]	
1.9 TDI	07/00-01/05	AJM	1896		0-N1049	TB [BT]	
1.9 TDI	07/00-01/05	AJM	1896	mit Anbaumaterial	0-N1265	TB [TE]	
1.9 TDI	07/00-01/05	AJM	1896		0-N1268	TB [DG]	
1.9 TDI	08/01-01/05	AVF, AWX	1896	ch.4B-2-120001→	0-N1045	TB [TE]	
1.9 TDI	08/01-01/05	AVF, AWX	1896	ch.4B-2-120001→	0-N1046	TB [DG]	
1.9 TDI	08/01-01/05	AVF, AWX	1896	ch.→4B-2-120000	0-N1048	TB [TE]	
1.9 TDI	08/01-01/05	AVF, AWX	1896	ch.→4B-2-120000	0-N1268	TB [DG]	
1.9 TDI	08/01-01/05	AVF, AWX	1896	ch.→4B-2-120000	0-N1274	TB [BT]	
2.0	08/01-01/05	ALT	1984		0-N1050	TB [TE]	
2.0	08/01-01/05	ALT	1984		0-N1051	TB [BT]	S
2.0	08/01-01/05	ALT	1984		0-N1316	TB [DG]	
2.4, 2.4 quattro	12/97-01/05	AGA, ALF, AML, APS, ARJ, AJG, AMM, APZ, AJG, APZ, ALW, ARN, ASM, APC, BDV	2393		0-N1238	TB [TE]	
2.4, 2.4 quattro	12/97-01/05	AGA, ALF, AML, APS, ARJ, AJG, AMM, APZ, AJG, APZ, ALW, ARN, ASM, APC, BDV	2393		0-N1275	TB [BT]	

CM³

Art. Nr.



A6 Avant (4B5, C5)							
2.4, 2.4 quattro	12/97-01/05	AGA, ALF, AML, APS, ARJ, AJG, AMM, APZ, AJG, APZ, ALW, ARN, ASM, APC, BDV	2393			0-N1371	TB [TE]
2.4, 2.4 quattro	12/97-01/05	AGA, ALF, AML, APS, ARJ, AJG, AMM, APZ, AJG, APZ, ALW, ARN, ASM, APC, BDV	2393			0-N2001	TB [DG]
2.5 TDI, 2.5 TDI quattro	12/97-01/05	AFB, AKN, AKE, BAU, BDH, AYM, BCZ, BDG, BFC	2496			0-N1266	TB [TE]
2.5 TDI, 2.5 TDI quattro	12/97-01/05	AFB, AKN, AKE, BAU, BDH, AYM, BCZ, BDG, BFC	2496			0-N1363	TB [TE]
2.5 TDI, 2.5 TDI quattro	12/97-01/05	AFB, AKN, AKE, BAU, BDH, AYM, BCZ, BDG, BFC	2496			0-N1364	TB [BT]
2.5 TDI, 2.5 TDI quattro	12/97-01/05	AFB, AKN, AKE, BAU, BDH, AYM, BCZ, BDG, BFC	2496			0-N168	TB [DG]
2.5 TDI, 2.5 TDI quattro	12/97-01/05	AFB, AKN, AKE, BAU, BDH, AYM, BCZ, BDG, BFC	2496			0-N201	TB [BT]
2.7 T, 2.7 T quattro	12/97-01/05	AJK, AJK, AZA, ARE, BES	2671			0-N1238	TB [TE]
2.7 T, 2.7 T quattro	12/97-01/05	AJK, AJK, AZA, ARE, BES	2671			0-N1275	TB [BT]
2.7 T, 2.7 T quattro	12/97-01/05	AJK, AJK, AZA, ARE, BES	2671			0-N1371	TB [TE]
2.7 T, 2.7 T quattro	12/97-01/05	AJK, AJK, AZA, ARE, BES	2671			0-N2001	TB [DG]
2.8	12/97-01/05	AGE, ATX	2771			0-N1275	TB [BT]
2.8, 2.8 quattro	12/97-01/05	ACK, AHA, ALG, AMX, APR, AQD, AGE, ATX	2771			0-N1238	TB [TE]
2.8, 2.8 quattro	12/97-01/05	ACK, AHA, ALG, AMX, APR, AQD	2771	01/1998 →		0-N1275	TB [BT]
2.8, 2.8 quattro	12/97-01/05	ACK, AHA, ALG, AMX, APR, AQD, AGE, ATX	2771			0-N1371	TB [TE]
2.8, 2.8 quattro	12/97-01/05	ACK, AHA, ALG, AMX, APR, AQD, AGE, ATX	2771			0-N2001	TB [DG]
3.0, 3.0 quattro	08/01-01/05	ASN	2976			0-N1052	TB [DG]
3.0, 3.0 quattro	08/01-01/05	ASN	2976			0-N1053	TB [DG]
3.0, 3.0 quattro	08/01-01/05	ASN	2976			0-N1054	TB [TE]
3.0, 3.0 quattro	08/01-01/05	ASN	2976			0-N1342	TB [BT]
3.7, 3.7 quattro	03/99-01/05	AQG	3697	ch.→4B-Y-085000		0-N1364	TB [BT]
3.7, 3.7 quattro	03/99-01/05	AQG	3697			0-N1568	TB [TE]
3.7, 3.7 quattro	03/99-01/05	AQG	3697	ch.4B-Y-085001→		0-N1569	TB [BT]
3.7, 3.7 quattro	03/99-01/05	AQG	3697			0-N1570	TB [DG]
3.7, 3.7 quattro	03/99-01/05	AQG	3697			0-N169	TB [DG]
4.2 quattro, RS6 plus quattro, RS6 quattro, S6 quattro	11/98-01/05	ANK, AQJ, ARS, ASG, AWN, BCY, BRV	4172			0-N1568	TB [TE]
4.2 quattro, RS6 plus quattro, RS6 quattro, S6 quattro	11/98-01/05	ANK, AQJ, ARS, ASG, AWN, BCY, BRV	4172			0-N1569	TB [BT]
4.2 quattro, RS6 plus quattro, RS6 quattro, S6 quattro	11/98-01/05	ANK, AQJ, ARS, ASG, AWN, BCY, BRV	4172			0-N1570	TB [DG]
4.2 quattro, RS6 plus quattro, RS6 quattro, S6 quattro	11/98-01/05	ANK, AQJ, ARS, ASG, AWN, BCY, BRV	4172			0-N169	TB [DG]
4.2 quattro, S6 quattro	11/98-01/05	ANK, AQJ, ARS, ASG, AWN	4172	ch.→4B-Y-085000		0-N1364	TB [BT]
1.8, 1.8 T, 1.8 T quattro	12/97-01/05	AEB, ANB, APU, ARK, AWT, AFY, AJL, AJP, AQE, ARH	1781	Rippenanzahl: 4		0-N1317	VB [TE] S
1.9 TDI	02/98-01/05	AFN, AVF, AWX	1896	Rippenanzahl: 4		0-N1317	VB [TE] S
1.9 TDI	02/98-04/01	AFN	1896	Rippenanzahl: 5		0-N1432	VB [TE] S
1.9 TDI	07/00-01/05	AJM, AVF, AWX	1896	Rippenanzahl: 5		0-N1441	VB [BT] S
1.9 TDI	07/00-01/05	AJM, AVF, AWX	1896			0-N2047	VB [DG]
1.9 TDI	07/00-01/05	AJM, AVF, AWX	1896			0-N2139	VB [VD]
2.0	08/01-01/05	ALT	1984			0-N1662	VB [DG]
2.0	08/01-01/05	ALT	1984			0-N1671	VB [BT] S
2.4, 2.4 quattro	12/97-01/05	AGA, ALF, AML, APS, ARJ, AJG, AMM, APZ, AJG, APZ, ALW, ARN, ASM, APC, BDV	2393			0-N1083	VB [BT] S
2.5 TDI, 2.5 TDI quattro	12/97-01/05	AFB, AKN, AKE, BAU, BDH, AYM, BCZ, BDG, BFC	2496			0-N1005	VB [TE]
2.5 TDI, 2.5 TDI quattro	12/97-01/05	AFB, AKN, AKE, BAU, BDH, AYM, BCZ, BDG, BFC	2496			0-N1308	VB [TE]
2.5 TDI, 2.5 TDI quattro	12/97-01/05	AFB, AKN, AKE, BAU, BDH, AYM, BCZ, BDG, BFC	2496			0-N1315	VB [DG]
2.5 TDI, 2.5 TDI quattro	12/97-01/05	AFB, AKN, AKE, BAU, BDH, AYM, BCZ, BDG, BFC	2496	Rippenanzahl: 6		0-N1431	VB [DG]
2.5 TDI, 2.5 TDI quattro	12/97-01/05	AFB, AKN, AKE, BAU, BDH, AYM, BCZ, BDG, BFC	2496			0-N1947	VB [VD]
2.5 TDI, 2.5 TDI quattro	12/97-01/05	AFB, AKN, AKE, BAU, BDH, AYM, BCZ, BDG, BFC	2496			0-N2196	VB [BT]
2.5 TDI, 2.5 TDI quattro	12/97-01/05	AFB, AKN, AKE, BAU, BDH, AYM, BCZ, BDG, BFC	2496			0-N2258	VB [BT]

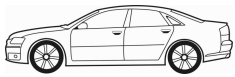

CM³



Art. Nr.



A6 Avant (4B5, C5)

2.5 TDI, 2.5 TDI quattro	12/97-01/05	AFB, AKN, AKE, BAU, BDH, AYM, BCZ, BDG, BFC	2496		0-N2417	VB [BT]	
2.7 T, 2.7 T quattro	12/97-01/05	AJK, AJK, AZA, ARE, BES	2671		0-N1083	VB [BT]	S
2.8, 2.8 quattro	12/97-01/05	ACK, AHA, ALG, AMX, APR, AQD, AGE, ATX	2771		0-N1083	VB [BT]	S
3.0, 3.0 quattro	08/01-01/05	ASN	2976		0-N1537	VB [BT]	S
3.7, 3.7 quattro	03/99-01/05	AQG	3697		0-N1632	VB [DG]	
4.2 quattro	11/98-01/05	ARS, ASG	4172		0-N1889	VB [BT]	S
4.2 quattro, RS6 plus quattro, RS6 quattro, S6 quattro	11/98-01/05	ANK, AQJ, ARS, ASG, AWN, BCY, BRV	4172		0-N1632	VB [DG]	
RS6 plus quattro, RS6 quattro, S6 quattro	09/99-01/05	ANK, AQJ, BCY, BRV	4172		0-N1889	VB [BT]	S

A6 (4F2, C6)

2.0 TDI	07/04-03/11	BNA, BRF	1968	30x141; mit Zubehör	SK-1595	BTK	
2.0 TDI	07/04-10/08	BLB, BRE, BVG	1968	30x141; mit Zubehör	SK-1595	BTK	
2.0 TDI	07/04-03/11	BNA, BRF	1968	30x141; mit Zubehör	SK-1595AQ1	BTKW	
2.0 TDI	07/04-10/08	BLB, BRE, BVG	1968	30x141; mit Zubehör	SK-1595AQ1	BTKW	
2.0 TDI	07/04-03/11	CAGB	1968	30x160	SK-1694	BTK	
2.0 TDI	07/04-03/11	CAGB	1968	30x160	SK-1694AQ2	BTKW	
2.0 TDI	11/08-03/11	CAHA, CAHB	1968	30x160	SK-1694	BTK	
2.0 TDI	11/08-03/11	CAHA, CAHB	1968	30x160	SK-1694AQ2	BTKW	
2.0 TFSI	06/05-03/11	BPJ, BYK	1984	23x148	SK-1724	BTK	
2.0 TFSI	06/05-03/11	BPJ, BYK	1984	23x148	SK-1724AQ1	BTKW	
2.7 TDI	11/04-10/08	BPP	2698	24x83; mit Zubehör	SK-1597	BTK	
2.7 TDI	11/04-03/11	CANB	2698	24x82	SK-1729	BTK	
2.7 TDI quattro	11/04-10/08	BPP	2698	24x83; 06/2005 →; mit Zubehör	SK-1597	BTK	
2.7 TDI quattro	06/05-03/11	CAND	2698	24x82	SK-1729	BTK	
2.7 TDI, 2.7 TDI quattro	11/04-03/11	BSG	2698	24x83; mit Zubehör	SK-1597	BTK	
2.7 TDI, 2.7 TDI quattro	11/04-03/11	CANB, CAND	2698	24x82	SK-1720	BTK	
2.7 TDI, 2.7 TDI quattro	10/08-03/11	CANA, CANC	2698	24x82	SK-1720	BTK	
2.7 TDI, 2.7 TDI quattro	10/08-03/11	CANA, CANC	2698	24x82	SK-1729	BTK	
3.0 TDI quattro	05/04-03/11	BNG	2967	24x83; 02/2005 →; mit Zubehör	SK-1597	BTK	
3.0 TDI quattro	05/04-10/08	ASB, BMK	2967	24x83; mit Zubehör	SK-1597	BTK	
3.0 TDI quattro	05/04-03/11	CDYB	2967	24x82	SK-1729	BTK	
3.0 TDI quattro	10/08-03/11	CDYA, CDYC	2967	24x82	SK-1720	BTK	
3.0 TDI quattro	10/08-03/11	CDYA, CDYC	2967	24x82	SK-1729	BTK	
3.0, 3.0 quattro	05/04-05/06	BBJ	2976	30x281; ohne Spanndämpfer, Spannrolle	SK-1538	BTK	
3.0, 3.0 quattro	05/04-05/06	BBJ	2976	30x281; mit Spanndämpfer, Spannrolle	SK-1601	BTK	
2.0 TDI	07/04-03/11	BLB, BRE, BNA, BRF, CAGB, BVG, CAHA, CAHB	1968		0-N1046	TB [DG]	
2.0 TDI	07/04-03/11	CAGB	1968		0-N1268	TB [DG]	
2.0 TDI	07/04-03/11	BNA, BRF	1968		0-N1335	TB [TE]	
2.0 TDI	07/04-10/08	BLB, BRE, BVG	1968		0-N1335	TB [TE]	
2.0 TDI	07/04-03/11	BLB, BRE, BVG, CAHA, CAHB	1968		0-N1336	TB [DG]	
2.0 TDI	07/04-03/11	CAGB	1968		0-N1336	TB [DG]	
2.0 TDI	07/04-03/11	CAGB	1968		0-N1905	TB [BT]	
2.0 TDI	11/08-03/11	CAHA, CAHB	1968		0-N1268	TB [DG]	
2.0 TDI	11/08-03/11	CAHA, CAHB	1968		0-N1905	TB [BT]	
2.0 TFSI	06/05-03/11	BPJ, BYK	1984		0-N1316	TB [DG]	
2.0 TFSI	06/05-03/11	BPJ, BYK	1984		0-N1346	TB [DG]	
2.0 TFSI	06/05-03/11	BPJ, BYK	1984		0-N2208	TB [TE]	
2.7 TDI, 2.7 TDI quattro	11/04-03/11	BPP, BSG, CANB, BSG, CAND, CANA, CANC	2698		0-N1337	TB [TE]	
3.0 TDI, 3.0 TDI quattro	05/04-03/11	ASB, BMK, BNG, CDYB, CDYA, CDYC	2967		0-N1337	TB [TE]	
3.0, 3.0 quattro	05/04-05/06	BBJ	2976		0-N1052	TB [DG]	
3.0, 3.0 quattro	05/04-05/06	BBJ	2976		0-N1053	TB [DG]	
3.0, 3.0 quattro	05/04-05/06	BBJ	2976		0-N1054	TB [TE]	
3.0, 3.0 quattro	05/04-05/06	BBJ	2976		0-N1342	TB [BT]	
2.0 TDI	07/04-03/11	BLB, BRE, BNA, BRF, CAGB, BVG, CAHA, CAHB	1968		0-N1534	VB [BT]	S
2.0 TDI	07/04-03/11	CAGB	1968		0-N1738	VB [DG]	
2.0 TDI	07/04-03/11	BNA, BRF	1968		0-N1928	VB [DG]	
2.0 TDI	07/04-10/08	BLB, BRE	1968	ch.4F-5-000001→	0-N1928	VB [DG]	
2.0 TDI	09/05-03/11	BVG, CAHA, CAHB	1968		0-N1738	VB [DG]	
2.0 TDI	09/05-06/06	BVG	1968		0-N1928	VB [DG]	
2.0 TFSI	06/05-03/11	BPJ, BYK	1984		0-N1662	VB [DG]	
2.0 TFSI	06/05-03/11	BPJ, BYK	1984		0-N1671	VB [BT]	S



CM³



Art. Nr.



A6 (4F2, C6)							
2.4, 2.4 quattro	05/04-10/08	BDW	2393			0-N1830	VB [BT] S
2.4, 2.4 quattro	05/04-10/08	BDW	2393			0-N2199	VB [DG]
2.7 TDI	11/04-10/08	BPP	2698	ch.→4F-5-140000, 4F-6-017400		0-N1907	VB [DG]
2.7 TDI quattro	11/04-10/08	BPP	2698	ch.→4F-5-140000, 4F-6-017400; 03/2005 →		0-N1907	VB [DG]
2.7 TDI, 2.7 TDI quattro	11/04-03/11	BPP, BSG, CANB, BSG, CAND	2698	Rippenanzahl: 6		0-N1431	VB [DG]
2.7 TDI, 2.7 TDI quattro	11/04-03/11	BPP, BSG, CANB, BSG, CAND	2698	ch.4F-5-140001→		0-N1795	VB [DG]
2.7 TDI, 2.7 TDI quattro	11/04-03/11	BSG	2698	ch.→4F-5-140000, 4F-6-017400		0-N1907	VB [DG]
2.7 TDI, 2.7 TDI quattro	11/04-03/11	BSG	2698	ch.4F-5-000001, 4F-6-172454→; 4F-7-029698; CVT-Automatikgetriebe (Stufenlos),		0-N1918	VB [BT] S
2.7 TDI, 2.7 TDI quattro	11/04-10/08	BPP	2698	ch.4F-5-000001, 4F-6-172454→; 4F-7-029698; CVT-Automatikgetriebe (Stufenlos),		0-N1918	VB [BT] S
2.7 TDI, 2.7 TDI quattro	11/04-03/11	BSG	2698	ch.4F-6-172454→; 4F-7-029698;		0-N1955	VB [BT] S
2.7 TDI, 2.7 TDI quattro	11/04-10/08	BPP	2698	ch.4F-6-172454→; 4F-7-029698;		0-N1955	VB [BT] S
2.7 TDI, 2.7 TDI quattro	10/08-03/11	CANA, CANC	2698			0-N1795	VB [DG]
2.7 TDI, 2.7 TDI quattro	10/08-03/11	CANA, CANC	2698	→ 09/2010		0-N1918	VB [BT] S
2.8 FSI, 2.8 FSI quattro	11/06-03/11	BDX, CCDA, CCEA	2773			0-N1830	VB [BT] S
2.8 FSI, 2.8 FSI quattro	11/06-03/11	BDX, CCDA, CCEA	2773			0-N2199	VB [DG]
3.0	08/04-05/06	BBJ	2976	ch.→4F-5-000000		0-N1537	VB [BT] S
3.0 quattro	05/04-05/06	BBJ	2976			0-N1537	VB [BT] S
3.0 TDI quattro	05/04-03/11	CDYB	2967			0-N1795	VB [DG]
3.0 TDI quattro	05/04-03/11	BNG	2967	ch.4F-5-140001→		0-N1795	VB [DG]
3.0 TDI quattro	05/04-05/06	BMK	2967	ch.4F-5-140001→		0-N1795	VB [DG]
3.0 TDI quattro	05/04-03/11	BNG	2967	ch.→4F-5-140000, 4F-6-017400		0-N1907	VB [DG]
3.0 TDI quattro	05/04-10/08	ASB, BMK	2967	ch.→4F-5-140000, 4F-6-017400		0-N1907	VB [DG]
3.0 TDI quattro	05/04-03/11	BNG	2967			0-N1918	VB [BT] S
3.0 TDI quattro	05/04-03/11	CDYB	2967	→ 09/2010		0-N1918	VB [BT] S
3.0 TDI quattro	05/04-03/11	BNG	2967			0-N1955	VB [BT] S
3.0 TDI quattro	10/08-03/11	CDYA, CDYC	2967			0-N1795	VB [DG]
3.0 TDI quattro	10/08-03/11	CDYA, CDYC	2967	→ 09/2010		0-N1918	VB [BT] S
3.0 TDI, 3.0 TDI quattro	05/04-03/11	ASB, BMK, BNG, CDYB	2967	Rippenanzahl: 6		0-N1431	VB [DG]
3.0 TDI, 3.0 TDI quattro	05/04-03/11	ASB, BMK	2967	ch.4F-5-000001, 4F-6-172454, 4F-7-029699→; 4F-6-100000, 4F-7-029698, 4F-8-250000;		0-N1918	VB [BT] S
3.0 TDI, 3.0 TDI quattro	05/04-03/11	ASB, BMK	2967	ch.4F-6-100001, 4F-6-172454→; 4F-6-172453, 4F-7-029698;		0-N1955	VB [BT] S
3.0 TDI, 3.0 TDI quattro	06/06-03/11	ASB	2967	ch.4F-5-140001, 4F-6-017401→		0-N1795	VB [DG]
3.0 TFSI quattro	10/08-03/11	CAJA, CCAA	2995			0-N1830	VB [BT] S
3.0 TFSI quattro	10/08-03/11	CAJA, CCAA	2995			0-N2199	VB [DG]
3.0 TFSI quattro	10/08-03/11	CAJA, CCAA	2995			0-N2289	VB [BT] S
3.0 TFSI quattro	10/08-03/11	CAJA, CCAA	2995			0-N2351	VB [DG]
3.0, 3.0 quattro	05/04-05/06	BBJ	2976	ch.4F-5-000001→		0-N2407	VB [BT] S
3.2 FSI	05/09-03/11	CALA	3197			0-N1830	VB [BT] S
3.2 FSI	05/09-03/11	CALA	3197			0-N2199	VB [DG]
3.2 FSI, 3.2 FSI quattro	05/04-05/09	AUK, BKH, BYU	3123	ch.→4F-7-064000		0-N1830	VB [BT] S
3.2 FSI, 3.2 FSI quattro	05/04-05/09	AUK, BKH, BYU	3123			0-N2199	VB [DG]
4.2 FSI quattro	06/06-03/11	BVJ	4163			0-N1830	VB [BT] S
A6 Allroad (4FH, C6)							
2.7 TDI quattro	05/06-08/11	BSG	2698	24x83; mit Zubehör		SK-1597	BTK
2.7 TDI quattro	05/06-10/08	BPP	2698	24x83; mit Zubehör		SK-1597	BTK
2.7 TDI quattro	05/06-08/11	CAND	2698	24x82		SK-1729	BTK
2.7 TDI quattro	10/08-08/11	CANC	2698	24x82		SK-1720	BTK
2.7 TDI quattro	10/08-08/11	CANC	2698	24x82		SK-1729	BTK
3.0 TDI quattro	05/06-08/11	BNG	2967	24x83; mit Zubehör		SK-1597	BTK
3.0 TDI quattro	05/06-10/08	ASB	2967	24x83; mit Zubehör		SK-1597	BTK
3.0 TDI quattro	05/06-08/11	CDYB	2967	24x82		SK-1729	BTK
3.0 TDI quattro	10/08-08/11	CDYA, CDYC	2967	24x82		SK-1720	BTK
3.0 TDI quattro	10/08-08/11	CDYA, CDYC	2967	24x82		SK-1729	BTK
2.7 TDI quattro	05/06-08/11	BPP, BSG, CAND, CANC	2698			0-N1337	TB [TE]
3.0 TDI quattro	05/06-08/11	ASB, BNG, CDYB, CDYA, CDYC	2967			0-N1337	TB [TE]
2.7 TDI quattro	05/06-08/11	BPP, BSG, CAND, CANC	2698	Rippenanzahl: 6		0-N1431	VB [DG]
2.7 TDI quattro	05/06-08/11	BPP, BSG, CAND	2698	ch.4F-7-029698→		0-N1795	VB [DG]
2.7 TDI quattro	05/06-08/11	BSG	2698	ch.4F-5-000001, 4F-6-172454→; 4F-7-029698; CVT-Automatikgetriebe (Stufenlos),		0-N1918	VB [BT] S



CM³



Art. Nr.



A6 Allroad (4FH, C6)

2.7 TDI quattro	05/06-10/08	BPP	2698	ch.4F-5-000001, 4F-6-172454→; 4F-7-029698; CVT-Automatikgetriebe (Stufenlos),	0-N1918	VB [BT]	S
2.7 TDI quattro	05/06-08/11	BSG	2698	ch.4F-6-172454→; 4F-7-029698;	0-N1955	VB [BT]	S
2.7 TDI quattro	05/06-10/08	BPP	2698	ch.4F-6-172454→; 4F-7-029698;	0-N1955	VB [BT]	S
2.7 TDI quattro	10/08-08/11	CANC	2698		0-N1795	VB [DG]	
2.7 TDI quattro	10/08-08/11	CANC	2698	→ 09/2010	0-N1918	VB [BT]	S
3.0 TDI quattro	05/06-08/11	ASB, BNG, CDYB, CDYA, CDYC	2967	Rippenanzahl: 6	0-N1431	VB [DG]	
3.0 TDI quattro	05/06-08/11	ASB, BNG, CDYB	2967	ch.4F-7-029698→	0-N1795	VB [DG]	
3.0 TDI quattro	05/06-08/11	ASB, BNG, CDYB	2967	ch.4F-5-000001, 4F-6-172454, 4F-7-029699→; 4F-6-100000, 4F-7-029698, 4F-8-250000;	0-N1918	VB [BT]	S
3.0 TDI quattro	05/06-08/11	ASB, BNG, CDYB	2967	ch.4F-6-100001, 4F-6-172454→; 4F-6-172453, 4F-7-029698;	0-N1955	VB [BT]	S
3.0 TDI quattro	10/08-08/11	CDYA, CDYC	2967		0-N1795	VB [DG]	
3.0 TDI quattro	10/08-08/11	CDYA, CDYC	2967	→ 09/2010	0-N1918	VB [BT]	S
3.0 TFSI quattro	10/08-08/11	CAJA	2995		0-N1830	VB [BT]	S
3.0 TFSI quattro	10/08-08/11	CAJA	2995		0-N2199	VB [DG]	
3.0 TFSI quattro	10/08-08/11	CAJA	2995		0-N2289	VB [BT]	S
3.0 TFSI quattro	10/08-08/11	CAJA	2995		0-N2351	VB [DG]	
3.2 FSI quattro	05/06-10/08	AUK	3123	ch.→4F-7-064000	0-N1830	VB [BT]	S
3.2 FSI quattro	05/06-10/08	AUK	3123		0-N2199	VB [DG]	

A6 Avant (4F5, C6)

2.0 TDI	06/05-08/11	BNA, BRF	1968	30x141; mit Zubehör	SK-1595	BTK	
2.0 TDI	06/05-10/08	BLB, BRE, BVG	1968	30x141; mit Zubehör	SK-1595	BTK	
2.0 TDI	06/05-08/11	BNA, BRF	1968	30x141; mit Zubehör	SK-1595AQ1	BTKW	
2.0 TDI	06/05-10/08	BLB, BRE, BVG	1968	30x141; mit Zubehör	SK-1595AQ1	BTKW	
2.0 TDI	06/05-08/11	CAGB	1968	30x160	SK-1694	BTK	
2.0 TDI	06/05-08/11	CAGB	1968	30x160	SK-1694AQ2	BTKW	
2.0 TDI	10/08-08/11	CAHA	1968	30x160; 11/2008 →	SK-1694	BTK	
2.0 TDI	10/08-08/11	CAHA, CAHB	1968	30x160	SK-1694AQ2	BTKW	
2.0 TDI	04/09-08/11	CAHB	1968	30x160	SK-1694	BTK	
2.0 TFSI	06/05-08/11	BPJ	1984	23x148	SK-1724	BTK	
2.0 TFSI	06/05-08/11	BPJ	1984	23x148	SK-1724AQ1	BTKW	
2.7 TDI	03/05-10/08	BPP	2698	24x83; mit Zubehör	SK-1597	BTK	
2.7 TDI	03/05-08/11	CANB	2698	24x82	SK-1729	BTK	
2.7 TDI quattro	03/05-10/08	BPP	2698	24x83; 06/2005 →; mit Zubehör	SK-1597	BTK	
2.7 TDI quattro	06/05-08/11	CAND	2698	24x82	SK-1729	BTK	
2.7 TDI, 2.7 TDI quattro	03/05-08/11	BSG	2698	24x83; mit Zubehör	SK-1597	BTK	
2.7 TDI, 2.7 TDI quattro	03/05-08/11	CANB, CAND	2698	24x82	SK-1720	BTK	
2.7 TDI, 2.7 TDI quattro	10/08-08/11	CANA, CANC	2698	24x82	SK-1720	BTK	
2.7 TDI, 2.7 TDI quattro	10/08-08/11	CANA, CANC	2698	24x82	SK-1729	BTK	
3.0 TDI quattro	03/05-08/11	BNG	2967	24x83; mit Zubehör	SK-1597	BTK	
3.0 TDI quattro	03/05-10/08	ASB, BMK	2967	24x83; mit Zubehör	SK-1597	BTK	
3.0 TDI quattro	03/05-08/11	CDYB	2967	24x82	SK-1729	BTK	
3.0 TDI quattro	10/08-08/11	CDYA, CDYC	2967	24x82	SK-1720	BTK	
3.0 TDI quattro	10/08-08/11	CDYA, CDYC	2967	24x82	SK-1729	BTK	
3.0, 3.0 quattro	03/05-05/06	BBJ	2976	30x281; ohne Spanndämpfer, Spannrolle	SK-1538	BTK	
3.0, 3.0 quattro	03/05-05/06	BBJ	2976	30x281; mit Spanndämpfer, Spannrolle	SK-1601	BTK	
2.0 TDI	06/05-08/11	BLB, BRE, BNA, BRF, CAGB, BVG, CAHA, CAHB	1968		0-N1046	TB [DG]	
2.0 TDI	06/05-08/11	CAGB	1968		0-N1268	TB [DG]	
2.0 TDI	06/05-08/11	BNA, BRF	1968		0-N1335	TB [TE]	
2.0 TDI	06/05-10/08	BLB, BRE, BVG	1968		0-N1335	TB [TE]	
2.0 TDI	06/05-08/11	BLB, BRE, BVG, CAHA, CAHB	1968		0-N1336	TB [DG]	
2.0 TDI	06/05-08/11	CAGB	1968		0-N1336	TB [DG]	
2.0 TDI	06/05-08/11	CAGB	1968		0-N1905	TB [BT]	
2.0 TDI	10/08-08/11	CAHA, CAHB	1968		0-N1268	TB [DG]	
2.0 TDI	10/08-08/11	CAHA, CAHB	1968		0-N1905	TB [BT]	
2.0 TFSI	06/05-08/11	BPJ	1984		0-N1316	TB [DG]	
2.0 TFSI	06/05-08/11	BPJ	1984		0-N1346	TB [DG]	
2.0 TFSI	06/05-08/11	BPJ	1984		0-N2208	TB [TE]	
2.7 TDI, 2.7 TDI quattro	03/05-08/11	BPP, BSG, CANB, BSG, CAND, CANA, CANC	2698		0-N1337	TB [TE]	
3.0 TDi, 3.0 TDI quattro	03/05-08/11	ASB, BMK, BNG, CDYB, CDYA, CDYC	2967		0-N1337	TB [TE]	
3.0, 3.0 quattro	03/05-05/06	BBJ	2976		0-N1052	TB [DG]	
3.0, 3.0 quattro	03/05-05/06	BBJ	2976		0-N1053	TB [DG]	

CM³

Art. Nr.

**A6 Avant (4F5, C6)**

3.0, 3.0 quattro	03/05-05/06	BBJ	2976			0-N1054	TB [TE]	
3.0, 3.0 quattro	03/05-05/06	BBJ	2976			0-N1342	TB [BT]	
2.0 TDI	06/05-08/11	BLB, BRE, BNA, BRF, CAGB, BVG, CAHA, CAHB	1968			0-N1534	VB [BT]	S
2.0 TDI	06/05-08/11	CAGB	1968			0-N1738	VB [DG]	
2.0 TDI	06/05-08/11	BNA, BRF	1968			0-N1928	VB [DG]	
2.0 TDI	06/05-10/08	BLB, BRE	1968	ch.4F-5-000001→		0-N1928	VB [DG]	
2.0 TDI	09/05-08/11	BVG, CAHA, CAHB	1968			0-N1738	VB [DG]	
2.0 TDI	09/05-06/06	BVG	1968			0-N1928	VB [DG]	
2.0 TFSI	06/05-08/11	BPJ	1984			0-N1662	VB [DG]	
2.0 TFSI	06/05-08/11	BPJ	1984			0-N1671	VB [BT]	S
2.4, 2.4 quattro	03/05-10/08	BDW	2393			0-N1830	VB [BT]	S
2.4, 2.4 quattro	03/05-10/08	BDW	2393			0-N2199	VB [DG]	
2.7 TDI, 2.7 TDI quattro	03/05-08/11	BPP, BSG, CANB, BSG, CAND	2698	Rippenanzahl: 6		0-N1431	VB [DG]	
2.7 TDI, 2.7 TDI quattro	03/05-08/11	BPP, BSG, CANB, BSG, CAND	2698	ch.4F-6-017401→		0-N1795	VB [DG]	
2.7 TDI, 2.7 TDI quattro	03/05-08/11	BSG	2698	ch.→4F-5-140000, 4F-6-017400; → 03/2011		0-N1907	VB [DG]	
2.7 TDI, 2.7 TDI quattro	03/05-10/08	BPP	2698	ch.→4F-5-140000, 4F-6-017400		0-N1907	VB [DG]	
2.7 TDI, 2.7 TDI quattro	03/05-08/11	BSG	2698	ch.4F-5-000001, 4F-6-172454→; 4F-7-029698; CVT-Automatikgetriebe (Stufenlos),		0-N1918	VB [BT]	S
2.7 TDI, 2.7 TDI quattro	03/05-10/08	BPP	2698	ch.4F-5-000001, 4F-6-172454→; 4F-7-029698; CVT-Automatikgetriebe (Stufenlos),		0-N1918	VB [BT]	S
2.7 TDI, 2.7 TDI quattro	03/05-08/11	BSG	2698	ch.4F-6-172454→; 4F-7-029698;		0-N1955	VB [BT]	S
2.7 TDI, 2.7 TDI quattro	03/05-10/08	BPP	2698	ch.4F-6-172454→; 4F-7-029698;		0-N1955	VB [BT]	S
2.7 TDI, 2.7 TDI quattro	10/08-08/11	CANA, CANC	2698			0-N1795	VB [DG]	
2.7 TDI, 2.7 TDI quattro	10/08-08/11	CANA, CANC	2698	→ 09/2010		0-N1918	VB [BT]	S
2.8 FSI, 2.8 FSI quattro	11/06-08/11	BDX, CCDA, CCEA	2773			0-N1830	VB [BT]	S
2.8 FSI, 2.8 FSI quattro	11/06-08/11	BDX, CCDA, CCEA	2773			0-N2199	VB [DG]	
3.0	03/05-05/06	BBJ	2976	ch.→4F-5-000000		0-N1537	VB [BT]	S
3.0 quattro	03/05-05/06	BBJ	2976			0-N1537	VB [BT]	S
3.0 TDI quattro	03/05-08/11	BNG, CDYB, CDYA, CDYC	2967			0-N1795	VB [DG]	
3.0 TDI quattro	03/05-08/11	BNG	2967	ch.→4F-5-140000, 4F-6-017400		0-N1907	VB [DG]	
3.0 TDI quattro	03/05-10/08	ASB, BMK	2967	ch.→4F-5-140000, 4F-6-017400		0-N1907	VB [DG]	
3.0 TDI quattro	03/05-08/11	BNG	2967			0-N1918	VB [BT]	S
3.0 TDI quattro	03/05-08/11	CDYB	2967	→ 09/2010		0-N1918	VB [BT]	S
3.0 TDI quattro	03/05-08/11	BNG	2967			0-N1955	VB [BT]	S
3.0 TDI quattro	10/08-08/11	CDYA, CDYC	2967	→ 09/2010		0-N1918	VB [BT]	S
3.0 TDi, 3.0 TDI quattro	03/05-08/11	ASB, BMK, BNG, CDYB	2967	Rippenanzahl: 6		0-N1431	VB [DG]	
3.0 TDi, 3.0 TDI quattro	03/05-08/11	ASB, BMK	2967	ch.4F-6-017401→		0-N1795	VB [DG]	
3.0 TDi, 3.0 TDI quattro	03/05-08/11	ASB, BMK	2967	ch.4F-5-000001, 4F-6-172454, 4F-7-029699→; 4F-6-100000, 4F-7-029698, 4F-8-250000;		0-N1918	VB [BT]	S
3.0 TDi, 3.0 TDI quattro	03/05-08/11	ASB, BMK	2967	ch.4F-6-100001, 4F-6-172454→; 4F-6-172453, 4F-7-029698;		0-N1955	VB [BT]	S
3.0 TFSI quattro	10/08-08/11	CAJA, CCAA	2995			0-N1830	VB [BT]	S
3.0 TFSI quattro	10/08-08/11	CAJA, CCAA	2995			0-N2199	VB [DG]	
3.0 TFSI quattro	10/08-08/11	CAJA, CCAA	2995			0-N2289	VB [BT]	S
3.0 TFSI quattro	10/08-08/11	CAJA, CCAA	2995			0-N2351	VB [DG]	
3.0, 3.0 quattro	03/05-05/06	BBJ	2976	ch.4F-5-000001→		0-N2407	VB [BT]	S
3.2 FSI, 3.2 FSI quattro	03/05-10/08	AUK	3123	ch.→4F-7-064000		0-N1830	VB [BT]	S
3.2 FSI, 3.2 FSI quattro	03/05-10/08	AUK	3123			0-N2199	VB [DG]	
4.2 FSI quattro	06/06-08/11	BVJ	4163			0-N1830	VB [BT]	S

A6 (4G2, C7, 4GC)

2.0 TDI	03/11-	CGLC, CMGB, CGLD, CGLE, CSUE	1968	25x160		SK-1695	BTK	
2.0 TDI	03/11-	CGLC, CMGB, CGLD	1968	25x160		SK-1695AQ1	BTKW	
2.0 TDI	03/11-	CGLC, CMGB, CGLD, CGLE, CSUE	1968	25x160		SK-1727AQ2	BTKW	
2.0 TDI	01/12-	CGLE	1968	25x160		SK-1695AQ1	BTKW	
2.0 TDI	03/11-	CGLC, CMGB, CGLD, CGLE, CSUE	1968			0-N131	TB [DG]	
2.0 TDI	03/11-	CGLC, CMGB	1968			0-N2025	TB [DG]	
2.0 TDI	03/11-	CGLD	1968			0-N2025	TB [DG]	
2.0 TDI	03/11-	CGLC, CMGB, CGLD, CGLE, CSUE	1968			0-N2061	TB [TE]	
2.0 TDI	03/11-	CGLC, CMGB, CGLD, CGLE, CSUE	1968			0-N2200	TB [DG]	
2.0 TDI	03/11-	CGLC, CMGB, CGLD, CGLE, CSUE	1968			0-N1534	VB [BT]	S
2.0 TDI	03/11-	CGLC, CMGB, CGLD, CGLE, CSUE	1968			0-N1907	VB [DG]	
2.0 TDI	11/13-	CNHA, CZJA	1968			0-N2288	VB [BT]	S
2.0 TDI	09/14-	CSUD	1968			0-N2288	VB [BT]	S



CM³



Art. Nr.



A6 (4G2, C7, 4GC)								
2.8 FSI, 2.8 FSI quattro	11/10-04/15	CHVA	2773			0-N1830	VB [BT]	S
3.0 TDI, 3.0 TDI quattro	11/10-	CDUC, CDUD, CKVB, CKVC, CGQB, CLAA, CLAB, CPNB	2967			0-N2287	VB [BT]	S
3.0 TFSI quattro	11/10-05/12	CGWB, CGWD, CGXB, CTUA	2995			0-N1830	VB [BT]	S
3.0 TFSI quattro	11/10-05/12	CGWB, CGWD, CGXB, CTUA	2995			0-N2199	VB [DG]	
3.0 TFSI quattro	11/10-05/12	CGWB, CGWD, CGXB, CTUA	2995	ch.4G-B-000 001→		0-N2289	VB [BT]	S
3.0 TFSI quattro	11/10-05/12	CGWB, CGWD, CGXB, CTUA	2995			0-N2351	VB [DG]	
A6 Allroad (4GH, 4GJ)								
3.0 TDI quattro	01/12-	CDUD, CKVC	2967			0-N1795	VB [DG]	
3.0 TDI quattro	01/12-	CGQB	2967			0-N1795	VB [DG]	
3.0 TDI quattro	01/12-	CLAA	2967			0-N1795	VB [DG]	
3.0 TDI quattro	01/12-	CDUD, CKVC, CGQB, CLAA	2967			0-N2287	VB [BT]	S
3.0 TFSI quattro	01/12-	CGWD	2995			0-N1830	VB [BT]	S
3.0 TFSI quattro	01/12-	CGWD	2995			0-N2199	VB [DG]	
3.0 TFSI quattro	01/12-	CGWD	2995			0-N2289	VB [BT]	S
3.0 TFSI quattro	01/12-	CGWD	2995			0-N2351	VB [DG]	
A6 Avant (4G5, C7, 4GD)								
2.0 TDI	05/11-	CGLC, CMGB, CGLD, CGLE, CSUE	1968	25x160		SK-1695	BTK	
2.0 TDI	05/11-	CGLC, CMGB, CGLD, CGLE, CSUE	1968	25x160		SK-1695AQ1	BTKW	
2.0 TDI	05/11-	CGLC, CMGB, CGLD, CGLE, CSUE	1968	25x160		SK-1727AQ2	BTKW	
2.0 TDI	05/11-	CGLC, CMGB, CGLD, CGLE, CSUE	1968			0-N131	TB [DG]	
2.0 TDI	05/11-	CGLC, CMGB	1968			0-N2025	TB [DG]	
2.0 TDI	05/11-	CGLD	1968			0-N2025	TB [DG]	
2.0 TDI	05/11-	CGLC, CMGB, CGLD	1968			0-N2061	TB [TE]	
2.0 TDI	05/11-	CGLC, CMGB, CGLD, CGLE, CSUE	1968			0-N2200	TB [DG]	
2.0 TDI	05/11-	CGLC, CMGB, CGLD, CGLE, CSUE	1968			0-N1534	VB [BT]	S
2.0 TDI	05/11-	CGLC, CMGB, CGLD, CGLE, CSUE	1968			0-N1907	VB [DG]	
2.0 TDI	11/13-	CNHA, CZJA	1968			0-N2288	VB [BT]	S
2.0 TDI	09/14-	CSUD	1968	✳		0-N2288	VB [BT]	S
2.8 FSI, 2.8 FSI quattro	05/11-04/15	CHVA	2773			0-N1830	VB [BT]	S
3.0 TDI, 3.0 TDI quattro	05/11-	CDUC, CDUD, CKVB, CKVC, CGQB, CLAA, CLAB	2967			0-N2287	VB [BT]	S
3.0 TFSI quattro	05/11-05/12	CGWB, CGWD	2995			0-N1830	VB [BT]	S
3.0 TFSI quattro	05/11-05/12	CGWB, CGWD	2995			0-N2199	VB [DG]	
3.0 TFSI quattro	05/11-05/12	CGWB, CGWD	2995	ch.4G-B-000 001→		0-N2289	VB [BT]	S
3.0 TFSI quattro	05/11-05/12	CGWB, CGWD	2995			0-N2351	VB [DG]	
A7 Sportback (4GA, 4GF)								
2.5 FSI	02/14-	CLXB	2498			0-N1830	VB [BT]	S
2.8 FSI, 2.8 FSI quattro	10/10-	CHVA, CHVA, CNYA	2773			0-N1830	VB [BT]	S
3.0 TDI, 3.0 TDI quattro	10/10-	CDUC, CDUD, CKVB, CKVC, CGQB, CLAA, CLAB, CPNB	2967			0-N2287	VB [BT]	S
3.0 TFSI quattro	10/10-	CGWB, CHMA, CGWD, CGXB, CTTA, CTUA	2995			0-N1830	VB [BT]	S
3.0 TFSI quattro	10/10-	CGWB, CHMA, CGWD, CGXB, CTTA, CTUA	2995			0-N2199	VB [DG]	
3.0 TFSI quattro	10/10-	CGWB, CHMA, CGWD, CGXB, CTTA, CTUA	2995			0-N2289	VB [BT]	S
3.0 TFSI quattro	10/10-	CGWB, CHMA, CGWD, CGXB, CTTA, CTUA	2995			0-N2351	VB [DG]	
A8 (4D2, 4D8)								
2.5 TDI	01/97-04/00	AFB, AKN	2496	32x207; 24x87; 06/1997 →; ohne Spanndämpfer, Spannrolle; mit Zubehör; Baumuster: 4D2		SK-1375	BTK	
2.5 TDI	01/97-04/00	AFB, AKN	2496	32x207; 24x87; 06/1997 →; mit Spanndämpfer, Spannrolle; mit Zubehör		SK-1633	BTK	
2.5 TDI quattro	07/97-04/00	AFB, AKN	2496	32x207; 24x87; ohne Spanndämpfer, Spannrolle; mit Zubehör; Baumuster: 4D2		SK-1375	BTK	
2.5 TDI quattro	07/97-04/00	AFB, AKN	2496	32x207; 24x87; mit Spanndämpfer, Spannrolle; mit Zubehör		SK-1633	BTK	
2.5 TDI, 2.5 TDI quattro	01/97-09/02	AFB, AKN, AKE	2496	30x207; 24x87; mit Spanndämpfer, Spannrolle; mit Zubehör		SK-1621AQ1	BTKW	
2.5 TDI, 2.5 TDI quattro	01/97-04/00	AKN	2496	32x207; 24x87; ch.4D-X-005501→; mit Spanndämpfer, Spannrolle; mit Zubehör		SK-1633AQ1	BTKW	
2.5 TDI, 2.5 TDI quattro	09/00-09/02	AKE	2496	30x207; 24x87; ohne Spanndämpfer, Spannrolle; mit Zubehör; Baumuster: 4D2		SK-1619	BTK	
2.5 TDI, 2.5 TDI quattro	09/00-09/02	AKE	2496	30x207; 24x87; nur in Verbindung mit: 078 121 113 F; mit Zubehör		SK-1619AQ2	BTKW	



CM³



Art. Nr.



A8 (4D2, 4D8)

2.5 TDI, 2.5 TDI quattro	09/00-09/02	AKE	2496	30x207; 24x87; mit Spanndämpfer, Spannrolle; mit Zubehör; Baumuster: 4D2	SK-1621	BTK
2.5 TDI, 2.5 TDI quattro	09/00-09/02	AKE	2496	32x207; 24x87; mit Spanndämpfer, Spannrolle; mit Zubehör	SK-1633AQ1	BTKW
2.8	04/96-09/02	ACK, ALG, AMX, APR, AQD	2771	30x253; mit Spanndämpfer, Spannrolle; mit Zubehör	SK-1377	BTK
2.8	04/96-09/02	ALG, AMX, APR, AQD	2771	30x253; ohne Spanndämpfer, Spannrolle; mit Zubehör	SK-1383	BTK
2.8 quattro	03/94-03/96	AAH	2771	25x239; ch.→4D-S-000496; 09/1994 →; Baumuster: 4D2	SK-1343	BTK
2.8 quattro	04/96-09/02	ACK, AMX, APR, AQD	2771	30x253; mit Spanndämpfer, Spannrolle; mit Zubehör	SK-1377	BTK
2.8 quattro	04/96-09/02	AMX, APR, AQD	2771	30x253; ohne Spanndämpfer, Spannrolle; mit Zubehör	SK-1383	BTK
2.8, 2.8 quattro	03/94-03/96	AAH, AEJ	2771	25x239; ch.→4D-S-000496; Baumuster: 4D2	SK-1343	BTK
2.8, 2.8 quattro	03/94-03/96	AAH, AEJ	2771	25x239; ch.→4D-S-000496	SK-1343AQ1	BTKW
2.8, 2.8 quattro	03/94-03/96	AAH, AEJ	2771	25x239; ch.4D-S-000497→; mit Zubehör	SK-1376	BTK
2.8, 2.8 quattro	03/94-03/96	AAH, AEJ	2771	25x239; ch.4D-S-000497→	SK-1376AQ1	BTKW
2.8, 2.8 quattro	04/96-09/02	ACK	2771	30x253; ch.4D-V-011001→; mit Spanndämpfer, Spannrolle; mit Zubehör	SK-1377	BTK
2.8, 2.8 quattro	04/96-09/02	ACK	2771	30x253; ch.4D-V-011001→; mit Spanndämpfer, Spannrolle; mit Zubehör	SK-1377AQ1	BTKW
2.8, 2.8 quattro	04/96-09/02	ALG, AMX, APR, AQD	2771	30x253; mit Spanndämpfer, Spannrolle; mit Zubehör	SK-1377AQ1	BTKW
2.8, 2.8 quattro	04/96-09/02	ACK, ALG, APR, AQD	2771	30x253; ch.4D-V-011001→; 4D-X-009500; mit Zubehör	SK-1383AQ1	BTKW
2.8, 2.8 quattro	04/96-09/02	ACK	2771	30x253; ch.→4D-V-011000; mit Spanndämpfer, Spannrolle; mit Zubehör	SK-1636	BTK
3.7, 3.7 quattro	11/98-09/02	AKC, AQQ	3697	30x253; ch.4D-Y-016501→	SK-1386AQ1	BTKW
3.7, 3.7 quattro	11/98-09/02	AKC, AQQ	3697	30x253; ch.→4D-Y-016500	SK-1687	BTK
3.7, 3.7 quattro	11/98-09/02	AKC, AQQ	3697	30x253; ch.4D-Y-016501→	SK-1688	BTK
4.2 quattro	11/98-09/02	AQF, AUW	4172	30x253; ch.4D-Y-016501→	SK-1386AQ1	BTKW
4.2 quattro	02/99-04/00	ARU	4172	30x253; ch.4D-Y-016501→	SK-1386AQ1	BTKW
4.2 quattro, S 8 quattro	11/98-09/02	AQF, AUW, AUX, AQH, AVP, ARU	4172	30x253; ch.→4D-Y-016500	SK-1687	BTK
4.2 quattro, S 8 quattro	11/98-09/02	AQF, AUW, AUX, AQH, AVP, ARU	4172	30x253; ch.4D-Y-016501→	SK-1688	BTK
S 8 quattro	06/99-09/02	AQH, AVP	4172	30x253; ch.4D-Y-016501→	SK-1386AQ1	BTKW
2.5 TDI, 2.5 TDI quattro	01/97-09/02	AFB, AKN, AKE	2496		0-N1266	TB [TE]
2.5 TDI, 2.5 TDI quattro	01/97-09/02	AFB, AKN, AKE	2496		0-N1363	TB [TE]
2.5 TDI, 2.5 TDI quattro	01/97-09/02	AFB, AKN, AKE	2496		0-N1364	TB [BT]
2.5 TDI, 2.5 TDI quattro	01/97-09/02	AFB, AKN, AKE	2496		0-N168	TB [DG]
2.5 TDI, 2.5 TDI quattro	01/97-09/02	AFB, AKN, AKE	2496		0-N201	TB [BT]
2.8, 2.8 quattro	03/94-03/96	AAH, AEJ	2771	ch.4D-S-000497→	0-N160	TB [TE]
2.8, 2.8 quattro	03/94-03/96	AAH, AEJ	2771	ch.4D-S-000497→	0-N200	TB [DG]
2.8, 2.8 quattro	03/94-03/96	AAH, AEJ	2771	ch.→4D-S-000496	0-N940	TB [TE]
2.8, 2.8 quattro	03/94-03/96	AAH, AEJ	2771	ch.→4D-S-000496	0-N941	TB [DG]
2.8, 2.8 quattro	04/96-09/02	ACK, ALG, AMX, APR, AQD, ACK, AMX, APR, AQD	2771		0-N1238	TB [TE]
2.8, 2.8 quattro	04/96-09/02	ALG, AMX, APR, AQD	2771		0-N1275	TB [BT]
2.8, 2.8 quattro	04/96-09/02	ACK	2771	ch.4D-V-011001→	0-N1275	TB [BT]
2.8, 2.8 quattro	04/96-09/02	ACK, ALG, AMX, APR, AQD, ACK, AMX, APR, AQD	2771		0-N1371	TB [TE]
2.8, 2.8 quattro	04/96-09/02	ACK	2771	ch.→4D-V-011000	0-N1372	TB [BT]
2.8, 2.8 quattro	04/96-09/02	ACK, ALG, AMX, APR, AQD, ACK, AMX, APR, AQD	2771		0-N2001	TB [DG]
3.3 TDI quattro	06/00-09/02	AKF	3328		0-N1275	TB [BT]
3.3 TDI quattro	06/00-09/02	AKF	3328		0-N1969	TB [TE]
3.3 TDI quattro	06/00-09/02	AKF	3328		0-N1978	TB [BT]
3.7, 3.7 quattro	07/95-12/98	AEW, AEW, AKJ	3697		0-N2414	TB [VD]
3.7, 3.7 quattro	11/98-09/02	AKC, AQQ	3697	ch.→4D-Y-016500	0-N1364	TB [BT]
3.7, 3.7 quattro	11/98-09/02	AKC, AQQ	3697		0-N1568	TB [TE]
3.7, 3.7 quattro	11/98-09/02	AKC, AQQ	3697		0-N1569	TB [BT]
3.7, 3.7 quattro	11/98-09/02	AKC, AQQ	3697		0-N1570	TB [DG]
3.7, 3.7 quattro	11/98-09/02	AKC, AQQ	3697		0-N169	TB [DG]
4.2 quattro, S 8 quattro	03/94-12/99	ABZ, ABZ, AKG, AEM, AHC, AKH	4172		0-N2414	TB [VD]
4.2 quattro, S 8 quattro	11/98-09/02	AQF, AUW, AUX, AQH, AVP, ARU	4172	ch.→4D-Y-016500	0-N1364	TB [BT]
4.2 quattro, S 8 quattro	11/98-09/02	AQF, AUW, AUX, AQH, AVP, ARU	4172		0-N1568	TB [TE]
4.2 quattro, S 8 quattro	11/98-09/02	AQF, AUW, AUX, AQH, AVP, ARU	4172		0-N1569	TB [BT]
4.2 quattro, S 8 quattro	11/98-09/02	AQF, AUW, AUX, AQH, AVP, ARU	4172		0-N1570	TB [DG]
4.2 quattro, S 8 quattro	11/98-09/02	AQF, AUW, AUX, AQH, AVP, ARU	4172		0-N169	TB [DG]

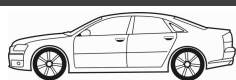

CM³



Art. Nr.

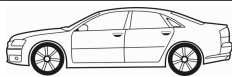

A8 (4D2, 4D8)							
2.5 TDI, 2.5 TDI quattro	01/97-09/02	AFB, AKN, AKE	2496		0-N1005	VB [TE]	
2.5 TDI, 2.5 TDI quattro	01/97-09/02	AFB, AKN, AKE	2496		0-N1308	VB [TE]	
2.5 TDI, 2.5 TDI quattro	01/97-09/02	AFB, AKN, AKE	2496		0-N1315	VB [DG]	
2.5 TDI, 2.5 TDI quattro	01/97-09/02	AFB, AKN, AKE	2496	Rippenanzahl: 6	0-N1431	VB [DG]	
2.5 TDI, 2.5 TDI quattro	01/97-09/02	AFB, AKN, AKE	2496		0-N1947	VB [VD]	
2.5 TDI, 2.5 TDI quattro	01/97-09/02	AFB, AKN, AKE	2496		0-N2196	VB [BT]	
2.5 TDI, 2.5 TDI quattro	01/97-09/02	AFB, AKN, AKE	2496		0-N2258	VB [BT]	
2.5 TDI, 2.5 TDI quattro	01/97-09/02	AFB, AKN, AKE	2496		0-N2417	VB [BT]	
2.8, 2.8 quattro	03/94-09/02	AAH, ACK, ALG, AMX, APR, AQD, ACK, AMX, APR, AQD, AEJ	2771		0-N1083	VB [BT]	S
2.8, 2.8 quattro	03/94-03/96	AAH	2771		0-N1414	VB [DG]	
3.3 TDI quattro	06/00-09/02	AKF	3328		0-N1632	VB [DG]	
3.7, 3.7 quattro	07/95-09/02	AEW, AEW, AKJ, AKC, AQG	3697		0-N1632	VB [DG]	
3.7, 3.7 quattro	07/95-12/98	AEW, AEW, AKJ	3697		0-N1967	VB [VD]	
3.7, 3.7 quattro	11/98-09/02	AKC, AQG	3697		0-N1889	VB [BT]	S
4.2 quattro, S 8 quattro	03/94-09/02	ABZ, AKG, AEM, AHC, AKH, AQF, AUW, AUX, AQH, AVP, ARU	4172		0-N1632	VB [DG]	
4.2 quattro, S 8 quattro	03/94-06/99	ABZ, AKG, AEM, AHC, AKH	4172		0-N1967	VB [VD]	
6.0 W12 quattro	01/01-09/02	AZC	5998	Rippenanzahl: 7	0-N2127	VB [DG]	
6.0 W12 quattro	01/01-09/02	AZC	5998		0-N2346	VB [DG]	
A8 (4E_)							
3.0	07/03-05/06	ASN, BBJ	2976	30x281; ohne Spanndämpfer, Spannrolle	SK-1538	BTK	
3.0	07/03-05/06	ASN, BBJ	2976	30x281; mit Spanndämpfer, Spannrolle	SK-1601	BTK	
3.0 TDI quattro	08/03-07/10	ASB	2967	24x83; 02/2004 →; mit Zubehör	SK-1597	BTK	
3.0 TDI quattro	11/03-07/10	BNG	2967	24x83; mit Zubehör	SK-1597	BTK	
3.7 quattro	10/02-05/06	BFL	3697	30x253	SK-1386	BTK	
3.7 quattro	10/02-05/06	BFL	3697	30x253	SK-1386AQ1	BTKW	
4.2 quattro	10/02-07/10	BFM	4172	30x253	SK-1386AQ1	BTKW	
4.2 quattro	10/02-07/10	BFM	4172	30x253	SK-1688	BTK	
3.0	07/03-05/06	ASN, BBJ	2976		0-N1053	TB [DG]	
3.0	07/03-05/06	ASN, BBJ	2976		0-N1054	TB [TE]	
3.0 TDI quattro	08/03-07/10	ASB, BNG	2967		0-N1337	TB [TE]	
3.0, 3.0 quattro	07/03-05/06	ASN, BBJ	2976		0-N1052	TB [DG]	
3.0, 3.0 quattro	07/03-05/06	ASN, BBJ	2976		0-N1342	TB [BT]	
3.7 quattro	10/02-05/06	BFL	3697		0-N1568	TB [TE]	
3.7 quattro	10/02-05/06	BFL	3697		0-N1569	TB [BT]	
3.7 quattro	10/02-05/06	BFL	3697		0-N1570	TB [DG]	
3.7 quattro	10/02-05/06	BFL	3697		0-N169	TB [DG]	
4.0 TDI quattro	05/03-07/05	ASE	3936		0-N1268	TB [DG]	
4.2 FSI quattro	06/06-07/10	BVJ	4163		0-N1569	TB [BT]	
4.2 FSI quattro	06/06-07/10	BVJ	4163		0-N1570	TB [DG]	
4.2 quattro	10/02-07/10	BFM	4172		0-N1568	TB [TE]	
4.2 quattro	10/02-07/10	BFM	4172		0-N1569	TB [BT]	
4.2 quattro	10/02-07/10	BFM	4172		0-N1570	TB [DG]	
4.2 quattro	10/02-07/10	BFM	4172		0-N169	TB [DG]	
2.8 FSI	08/07-07/10	BDX, CJBA	2773		0-N1830	VB [BT]	S
2.8 FSI	08/07-07/10	BDX, CJBA	2773		0-N2199	VB [DG]	
3.0 TDI quattro	08/03-07/10	ASB, BNG	2967	Rippenanzahl: 6	0-N1431	VB [DG]	
3.0 TDI quattro	08/03-07/10	ASB, BNG	2967	01/2008 →	0-N1795	VB [DG]	
3.0 TDI quattro	08/03-07/10	ASB, BNG	2967	ch.4E-6-003070→; 4E-7-030000	0-N1795	VB [DG]	
3.0 TDI quattro	08/03-07/10	ASB	2967	ch.→4E-6-003069; 02/2004 →	0-N1907	VB [DG]	
3.0 TDI quattro	08/03-07/10	ASB, BNG	2967	ch.4E-7-003343→; 4E-6-020000	0-N1918	VB [BT]	S
3.0 TDI quattro	08/03-07/10	ASB, BNG	2967	ch.4E-6-020001→; 4E-7-003342	0-N1955	VB [BT]	S
3.0 TDI quattro	11/03-07/10	BNG	2967	ch.→4E-6-003069	0-N1907	VB [DG]	
3.0, 3.0 quattro	07/03-05/06	ASN, BBJ	2976		0-N1537	VB [BT]	S
3.0, 3.0 quattro	07/03-05/06	ASN, BBJ	2976		0-N2407	VB [BT]	S
3.2 FSI, 3.2 FSI quattro	06/05-07/10	BPK	3123		0-N1830	VB [BT]	S
3.2 FSI, 3.2 FSI quattro	06/05-07/10	BPK	3123		0-N2199	VB [DG]	
3.7 quattro	10/02-05/06	BFL	3697		0-N2134	VB [DG]	
3.7 quattro	10/02-05/06	BFL	3697		0-N2137	VB [TE]	S
4.2 quattro	10/02-07/10	BFM	4172		0-N2134	VB [DG]	
4.2 quattro	10/02-07/10	BFM	4172		0-N2137	VB [TE]	S
4.2 TDI quattro	01/05-07/10	BMC, BVN	4134		0-N1795	VB [DG]	
6.0 W12 quattro	12/03-07/10	BHT, BSB, BTE	5998	Rippenanzahl: 7	0-N2127	VB [DG]	

CM³

Art. Nr.

**A8 (4H_)**

2.5 TFSI	07/12-	CPAA, CVBA	2498		0-N1830	VB [BT]	S
3.0 TDI, 3.0 TDI quattro	07/10-	CDTA, CDTC, CMHA, CDTB, CTBB, CLAB, CPNA, CTBA	2967		0-N2287	VB [BT]	S
3.0 TFSI quattro	06/10-	CGWA, CGXA, CREG, CGWD, CREA, CGXC, CMDA, CREC, CTDA, CTUB	2995		0-N1830	VB [BT]	S
3.0 TFSI quattro	06/10-	CGWA, CGXA, CREG, CGWD, CREA, CGXC, CMDA, CREC, CTDA, CTUB	2995		0-N2199	VB [DG]	
3.0 TFSI quattro	06/10-	CGWA, CGXA, CREG, CGWD, CREA, CGXC, CMDA, CREC, CTDA, CTUB	2995		0-N2289	VB [BT]	S
3.0 TFSI quattro	06/10-	CGWA, CGXA, CREG, CGWD, CREA, CGXC, CMDA, CREC, CTDA, CTUB	2995		0-N2351	VB [DG]	

ALLROAD (4BH, C5)

2.5 TDI quattro	05/00-08/05	AKE, BAU	2496	30x207; 24x87; ohne Spanndämpfer, Spannrolle; mit Zubehör; Baumuster: 4BH	SK-1619	BTK	
2.5 TDI quattro	05/00-08/05	AKE, BAU, BCZ	2496	30x207; 24x87; nur in Verbindung mit: 078 121 113 F; mit Zubehör	SK-1619AQ2	BTKW	
2.5 TDI quattro	05/00-08/05	AKE, BAU	2496	30x207; 24x87; mit Spanndämpfer, Spannrolle; mit Zubehör; Baumuster: 4BH	SK-1621	BTK	
2.5 TDI quattro	05/00-08/05	AKE, BAU, BCZ	2496	30x207; 24x87; mit Spanndämpfer, Spannrolle; mit Zubehör	SK-1621AQ1	BTKW	
2.5 TDI quattro	05/00-08/05	AKE, BAU, BCZ	2496	32x207; 24x87; mit Spanndämpfer, Spannrolle; mit Zubehör	SK-1633AQ1	BTKW	
2.5 TDI quattro	05/03-08/05	BCZ	2496	30x207; 24x87; ohne Spanndämpfer, Spannrolle; mit Zubehör; Baumuster: 4BH	SK-1619	BTK	
2.5 TDI quattro	05/03-08/05	BCZ	2496	30x207; 24x87; mit Spanndämpfer, Spannrolle; mit Zubehör; Baumuster: 4BH	SK-1621	BTK	
2.7 quattro	09/00-08/05	APB, BEL	2671	30x253; mit Spanndämpfer, Spannrolle; mit Zubehör	SK-1377	BTK	
2.7 T quattro	05/00-08/05	ARE, BES	2671	30x253; mit Spanndämpfer, Spannrolle; mit Zubehör; Baumuster: 4BH	SK-1377	BTK	
2.7 T quattro	05/00-08/05	ARE, BES	2671	30x253; ohne Spanndämpfer, Spannrolle; mit Zubehör	SK-1383	BTK	
2.5 TDI quattro	05/00-08/05	AKE, BAU, BCZ	2496		0-N1266	TB [TE]	
2.5 TDI quattro	05/00-08/05	AKE, BAU, BCZ	2496		0-N1363	TB [TE]	
2.5 TDI quattro	05/00-08/05	AKE, BAU, BCZ	2496		0-N1364	TB [BT]	
2.5 TDI quattro	05/00-08/05	AKE, BAU, BCZ	2496		0-N168	TB [DG]	
2.5 TDI quattro	05/00-08/05	AKE, BAU, BCZ	2496		0-N201	TB [BT]	
2.7 T quattro	05/00-08/05	ARE, BES	2671		0-N1238	TB [TE]	
2.7 T quattro	05/00-08/05	ARE, BES	2671		0-N1275	TB [BT]	
2.7 T quattro	05/00-08/05	ARE, BES	2671		0-N1371	TB [TE]	
2.7 T quattro	05/00-08/05	ARE, BES	2671		0-N2001	TB [DG]	
2.5 TDI quattro	05/00-08/05	AKE, BAU, BCZ	2496		0-N1005	VB [TE]	
2.5 TDI quattro	05/00-08/05	AKE, BAU, BCZ	2496		0-N1308	VB [TE]	
2.5 TDI quattro	05/00-08/05	AKE, BAU, BCZ	2496		0-N1315	VB [DG]	
2.5 TDI quattro	05/00-08/05	AKE, BAU, BCZ	2496	Rippenanzahl: 6	0-N1431	VB [DG]	
2.5 TDI quattro	05/00-08/05	AKE, BAU, BCZ	2496		0-N1947	VB [VD]	
2.5 TDI quattro	05/00-08/05	AKE, BAU, BCZ	2496		0-N2196	VB [BT]	
2.5 TDI quattro	05/00-08/05	AKE, BAU, BCZ	2496		0-N2258	VB [BT]	
2.5 TDI quattro	05/00-08/05	AKE, BAU, BCZ	2496		0-N2417	VB [BT]	
2.7 T quattro	05/00-08/05	ARE, BES	2671		0-N1083	VB [BT]	S

CABRIOLET (8G7, B4)

1.8	01/97-08/00	ADR	1781	25x153; mit Zubehör; Baumuster: 8G7, B4	SK-1346	BTK	
1.8	01/97-08/00	ADR	1781	25x153; 04/1997 →; mit Spanndämpfer, Spannrolle; mit Zubehör	SK-1638	BTK	
1.9 TDI	06/95-08/00	1Z, AHU	1896	25x137; mit Zubehör	SK-1098	BTK	
2.0 16V	06/95-07/96	ACE	1984	25x147	SK-1124	BTK	
2.0 E	01/93-07/98	ABK	1984	18x124; ch.→8G-S-002743	SK-1119	BTK	
2.0 E	01/93-07/98	ABK	1984	18x124; 01/1995 →	SK-1261	BTK	
2.3 E	05/91-07/94	NG	2309	19x147	SK-1130	BTK	
2.6	06/93-08/00	ABC, ACZ	2598	25x239; ch.→8G-S-001302; Baumuster: 8G7, B4	SK-1343	BTK	
2.6	06/93-08/00	ABC, ACZ	2598	25x239; ch.→8G-S-001302	SK-1343AQ1	BTKW	
2.6	06/93-08/00	ABC	2598	25x239; ch.8G-S-001303→; mit Zubehör	SK-1376	BTK	
2.6	06/93-08/00	ABC	2598	25x239; ch.8G-S-001303→	SK-1376AQ1	BTKW	
2.8	11/92-08/00	AAH	2771	25x239; ch.→8G-S-001302; Baumuster: 8G7, B4	SK-1343	BTK	
2.8	11/92-08/00	AAH	2771	25x239; ch.→8G-S-001302	SK-1343AQ1	BTKW	
2.8	11/92-08/00	AAH	2771	25x239; ch.8G-S-001303→; mit Zubehör	SK-1376	BTK	
2.8	11/92-08/00	AAH	2771	25x239; ch.8G-S-001303→	SK-1376AQ1	BTKW	



CM³



Art. Nr.



ohne Halter

CABRIOLET (8G7, B4)

1.8	01/97-08/00	ADR	1781		0-N1236	TB [TE]	
1.8	01/97-08/00	ADR	1781		0-N1276	TB [BT]	
1.8	01/97-08/00	ADR	1781		0-N131	TB [DG]	
1.8	01/97-08/00	ADR	1781		0-N1822	TB [BT]	S
1.9 TDI	06/95-08/00	1Z, AHU	1896		0-N104	TB [TE]	
1.9 TDI	06/95-08/00	1Z, AHU	1896		0-N128	TB [DG]	
2.0 16V	06/95-07/96	ACE	1984		0-N129	TB [TE]	
2.0 E	01/93-07/98	ABK	1984	ch.8G-S-002744→	0-N132	TB [TE]	
2.0 E	01/93-07/98	ABK	1984	ch.→8G-S-002743	0-N922	TB [TE]	
2.3 E	05/91-07/94	NG	2309	ch.→8B-M-033000	0-N923	TB [TE]	
2.3 E	05/91-07/94	NG	2309	ch.8B-M-033001→	0-N939	TB [TE]	
2.6	06/93-08/00	ABC, ACZ	2598	ch.8G-S-001303→	0-N160	TB [TE]	
2.6	06/93-08/00	ABC, ACZ	2598	ch.8G-S-001303→	0-N2000	TB [DG]	
2.6	06/93-08/00	ABC	2598	ch.→8G-S-001302	0-N940	TB [TE]	
2.6	06/93-08/00	ABC	2598	ch.→8G-S-001302	0-N941	TB [DG]	
2.8	11/92-08/00	AAH	2771	ch.8G-S-001303→	0-N160	TB [TE]	
2.8	11/92-08/00	AAH	2771	ch.8G-S-001303→	0-N2000	TB [DG]	
2.8	11/92-08/00	AAH	2771	ch.→8G-S-001302	0-N940	TB [TE]	
2.8	11/92-08/00	AAH	2771	ch.→8G-S-001302	0-N941	TB [DG]	
1.8	01/97-08/00	ADR	1781	Rippenanzahl: 4	0-N1317	VB [TE]	S
1.9 TDI	06/95-08/00	1Z, AHU	1896		0-N1417	VB [TE]	
1.9 TDI	06/95-08/00	1Z, AHU	1896		0-N1609	VB [BT]	
2.0 16V	06/95-07/96	ACE	1984		0-N2345	VB [DG]	
2.6	06/93-08/00	ABC	2598	ch.8G-S-003001→	0-N1083	VB [BT]	S
2.6	06/93-08/00	ABC	2598		0-N1414	VB [DG]	
2.8	11/92-08/00	AAH	2771	ch.8G-S-003001→	0-N1083	VB [BT]	S
2.8	11/92-08/00	AAH	2771		0-N1414	VB [DG]	

COUPE (81, 85)

1.6	07/80-08/81	YN	1588	18x121; mit Zubehör	SK-1026	BTK	
1.8, 1.8 GT, 1.8 GT quattro	08/81-10/88	DD, DS, JN, NE, DS, JV, JV, DZ, JN, PV, SF	1781	18x121; mit Zubehör	SK-1026	BTK	
2.3 quattro	01/87-10/88	NG	2309	19x142; ch.→8B-M-033000	SK-1126	BTK	
2.3 quattro	01/87-10/88	NG	2309	19x142; ch.→8B-M-033000	SK-1126AQ1	BTKW	
2.3 quattro	01/87-10/88	NG	2309	19x147; ch.8B-M-033001→	SK-1130	BTK	
1.6	07/80-08/81	YN	1588		0-N805	TB [TE]	
1.8 GT quattro	09/85-10/88	DS, JN	1781		0-N805	TB [TE]	
1.8, 1.8 GT, 1.8 GT quattro	08/81-10/88	DD, DS, JV, JV, DZ, JN, PV, SF	1781		0-N805	TB [TE]	
1.9	08/80-07/83	WN	1921		0-N807	TB [DG]	
2.0	09/83-04/88	HP, HP, JS, SK	1994		0-N807	TB [DG]	
2.1 GT	09/82-10/87	KE, KL, KL	2144		0-N807	TB [DG]	
2.2 GT, 2.2 quattro	07/81-10/88	HY, KV, JT, KV, KX	2226		0-N807	TB [DG]	
2.3, 2.3 quattro	01/87-10/88	NG	2309		0-N807	TB [DG]	

COUPE (89, 8B)

1.8	08/89-07/91	DZ	1781	18x121; mit Zubehör	SK-1026	BTK	
2.0	05/89-03/90	3A	1984	18x121; mit Zubehör	SK-1026	BTK	
2.0	05/89-12/96	AAD, ABK	1984	18x124; ch.→8B-S-001503	SK-1119	BTK	
2.0	05/89-12/96	AAD, ABK	1984	18x124; 01/1995 →	SK-1261	BTK	
2.0 16 V	01/92-12/96	6A, ACE	1984	25x147; ⁽⁸⁹⁾ :→017139	SK-1047	BTK	
2.0 16 V	01/92-07/92	6A	1984	25x147; ⁽⁸⁹⁾ :017140→; Baumuster: 8B	SK-1124	BTK	
2.0 16 V	08/92-12/96	ACE	1984	25x147; → 06/1996; ⁽⁸⁹⁾ :017140→; Baumuster: 8B	SK-1124	BTK	
2.0 20 V, 2.0 20 V quattro	08/89-07/91	NM	1994	19x147	SK-1127	BTK	
2.2 quattro	11/88-07/91	KV	2226	19x142; ch.8B-K-000001→	SK-1126	BTK	
2.2 quattro	11/88-07/91	KV	2226	19x142; ch.89-J-394743→	SK-1126AQ1	BTKW	
2.3 20V, 2.3 20V quattro	11/88-07/91	7A	2309	19x147	SK-1127	BTK	
2.3, 2.3 quattro	10/88-12/96	NG	2309	19x142; ch.→8B-M-033000	SK-1126	BTK	
2.3, 2.3 quattro	10/88-12/96	NG	2309	19x142; ch.→8B-M-033000	SK-1126AQ1	BTKW	
2.3, 2.3 quattro	10/88-12/96	NG	2309	19x147; ch.8B-M-033001→	SK-1130	BTK	
2.6	08/92-12/96	ABC	2598	25x239; ch.→8B-S-000544; → 05/1996; Baumuster: 8B	SK-1343	BTK	
2.6 quattro	08/92-12/96	ABC	2598	25x239; ch.→8B-S-000544; → 04/1995; Baumuster: 8B	SK-1343	BTK	
2.6, 2.6 quattro	08/92-12/96	ABC	2598	25x239; ch.→8B-S-000544	SK-1343AQ1	BTKW	
2.6, 2.6 quattro	08/92-12/96	ABC	2598	25x239; ch.8B-S-000545→; mit Zubehör	SK-1376	BTK	
2.6, 2.6 quattro	08/92-12/96	ABC	2598	25x239; ch.8B-S-000545→	SK-1376AQ1	BTKW	



CM³



Art. Nr.



COUPE (89, 8B)

2.8	09/91-12/96	AAH	2771	25x239; ch.→8B-S-000544; → 05/1996; Baumuster: 8B	SK-1343	BTK	
2.8 quattro	08/91-12/96	AAH	2771	25x239; ch.→8B-S-000544; Baumuster: 8B	SK-1343	BTK	
2.8, 2.8 quattro	08/91-12/96	AAH	2771	25x239; ch.→8B-S-000544	SK-1343AQ1	BTKW	
2.8, 2.8 quattro	08/91-12/96	AAH	2771	25x239; ch.8B-S-000545→; mit Zubehör	SK-1376	BTK	
2.8, 2.8 quattro	08/91-12/96	AAH	2771	25x239; ch.8B-S-000545→	SK-1376AQ1	BTKW	
S2 quattro	09/90-09/92	3B	2226	19x147	SK-1127	BTK	
1.8	08/89-07/91	DZ	1781		0-N805	TB [TE]	
2.0	05/89-12/96	ABK	1984	ch.8B-S-001504→	0-N132	TB [TE]	
2.0	05/89-07/90	3A	1984		0-N805	TB [TE]	
2.0	05/89-12/96	ABK	1984	ch.→8B-S-001503	0-N922	TB [TE]	
2.0 16 V	01/92-07/92	6A	1984		0-N808	TB [TE]	
2.0 16 V	08/92-12/96	ACE	1984	ENGINE:017140→	0-N129	TB [TE]	
2.0 16 V	08/92-12/96	ACE	1984	ENGINE:→017139	0-N808	TB [TE]	
2.0 20 V, 2.0 20 V quattro	08/89-07/91	NM	1994		0-N807	TB [DG]	
2.2 quattro	11/88-07/91	KV	2226		0-N923	TB [TE]	
2.3 20V, 2.3 20V quattro	11/88-12/96	7A	2309		0-N807	TB [DG]	
2.3, 2.3 quattro	10/88-12/96	NG	2309	ch.→89-J-394742	0-N807	TB [DG]	
2.3, 2.3 quattro	10/88-12/96	NG	2309	ch.89-J-394743→; 8B-M-033000	0-N923	TB [TE]	
2.3, 2.3 quattro	10/88-12/96	NG	2309	ch.8B-M-033001→	0-N939	TB [TE]	
2.6, 2.6 quattro	08/92-12/96	ABC	2598	ch.8B-S-000545→	0-N160	TB [TE]	
2.6, 2.6 quattro	08/92-12/96	ABC	2598	ch.8B-S-000545→	0-N2000	TB [DG]	
2.6, 2.6 quattro	08/92-12/96	ABC	2598	ch.→8B-S-000544	0-N940	TB [TE]	
2.6, 2.6 quattro	08/92-12/96	ABC	2598	ch.→8B-S-000544	0-N941	TB [DG]	
2.8, 2.8 quattro	08/91-12/96	AAH	2771	ch.8B-S-000545→	0-N160	TB [TE]	
2.8, 2.8 quattro	08/91-12/96	AAH	2771	ch.8B-S-000545→	0-N2000	TB [DG]	
2.8, 2.8 quattro	08/91-12/96	AAH	2771	ch.→8B-S-000544	0-N940	TB [TE]	
2.8, 2.8 quattro	08/91-12/96	AAH	2771	ch.→8B-S-000544	0-N941	TB [DG]	
S2 quattro	09/90-09/92	3B	2226		0-N807	TB [DG]	
S2 quattro	10/92-12/96	ABY	2226		0-N941	TB [DG]	
2.0 16 V	08/92-12/96	ACE	1984		0-N2345	VB [DG]	
2.6, 2.6 quattro	08/92-12/96	ABC	2598	ch.8B-S-000545→	0-N1083	VB [BT]	S
2.6, 2.6 quattro	08/92-12/96	ABC	2598		0-N1414	VB [DG]	
2.8, 2.8 quattro	08/91-12/96	AAH	2771	ch.8B-S-000545→	0-N1083	VB [BT]	S
2.8, 2.8 quattro	08/91-12/96	AAH	2771		0-N1414	VB [DG]	

Q3 (8U)

2.0 TDI	05/13-	CFGC	1968	25x160	SK-1695AQ1	BTKW	
2.0 TDI quattro	06/11-	CFGC, CLLB	1968	25x160	SK-1727AQ2	BTKW	
2.0 TDI, 2.0 TDI quattro	06/11-	CFFA, CFFB, CFFB, CLJA, CFGC, CLLB, CFGD	1968	25x160	SK-1727	BTK	
2.0 TDI, 2.0 TDI quattro	09/11-	CFFA, CFFB	1968	25x160	SK-1727AQ2	BTKW	
1.4 TFSI	10/13-	CHPB, CZDA, CZEA	1395		0-N2313	TB [TE]	
1.4 TFSI	10/13-	CHPB, CZDA, CZEA	1395		0-N2381	TB [DG]	
2.0 TDI, 2.0 TDI quattro	06/11-	CFFA, CFFB, CFFB, CLJA, CFGC, CLLB, CFGD	1968		0-N131	TB [DG]	
2.0 TDI, 2.0 TDI quattro	06/11-	CFFA, CFFB, CFFB, CLJA, CFGC, CLLB, CFGD	1968		0-N2061	TB [TE]	
2.0 TDI, 2.0 TDI quattro	06/11-	CFFA, CFFB, CFFB, CLJA, CFGC, CLLB, CFGD	1968		0-N2200	TB [DG]	
2.0 TDI, 2.0 TDI quattro	06/11-	CFFA, CFFB, CFFB, CLJA, CFGC, CLLB, CFGD	1968		0-N1534	VB [BT]	S
2.0 TFSI quattro	06/11-	CCZC	1984		0-N1832	VB [BT]	S

Q5 (8R)

2.0 TDI	11/10-	CJCA, CJCB, CSUB	1968	30x160	SK-1694	BTK	
2.0 TDI	11/10-	CJCA, CJCB, CSUB	1968	30x160	SK-1694AQ2	BTKW	
2.0 TDI quattro	11/08-	CAHA	1968	30x160	SK-1694	BTK	
2.0 TDI quattro	11/08-	CAHB	1968	30x160	SK-1694	BTK	
2.0 TDI quattro	11/08-	CAHA	1968	30x160	SK-1694AQ2	BTKW	
2.0 TDI quattro	11/08-	CAHB	1968	30x160	SK-1694AQ2	BTKW	
2.0 TDI quattro	11/08-	CGLA	1968	25x160	SK-1695	BTK	
2.0 TDI quattro	11/08-	CGLB, CMGA	1968	25x160; → 09/2012	SK-1695	BTK	
2.0 TDI quattro	11/08-	CGLA	1968	25x160	SK-1695AQ1	BTKW	
2.0 TDI quattro	11/08-	CGLB, CMGA	1968	25x160	SK-1695AQ1	BTKW	
2.0 TDI quattro	11/08-	CGLA, CGLB, CGLC, CGLD	1968	25x160	SK-1727AQ2	BTKW	
2.0 TDI quattro	11/08-	CGLA, CGLB, CMGA	1968	25x160	SK-1727AQ2	BTKW	
2.0 TDI quattro	08/09-	CAGA	1968	30x160	SK-1694	BTK	



CM³



Art. Nr.



Q5 (8R)							
2.0 TDI quattro	08/09-	CAGB	1968	30x160	SK-1694	BTK	
2.0 TDI quattro	08/09-	CAGA	1968	30x160	SK-1694AQ2	BTKW	
2.0 TDI quattro	08/09-	CAGB	1968	30x160	SK-1694AQ2	BTKW	
2.0 TDI quattro	08/09-	CJCA	1968	25x160	SK-1695	BTK	
2.0 TDI quattro	08/09-	CJCB	1968	25x160	SK-1695	BTK	
2.0 TDI quattro	08/09-	CJCA	1968	25x160	SK-1695AQ1	BTKW	
2.0 TDI quattro	06/12-	CGLC, CMGB	1968	25x160	SK-1727AQ2	BTKW	
2.0 TDI quattro	05/13-	CJCD	1968	25x160	SK-1695AQ1	BTKW	
2.0 TDI, 2.0 TDI quattro	08/09-	CJCB	1968	25x160	SK-1695AQ1	BTKW	
2.0 TDI, 2.0 TDI quattro	08/09-	CJCA, CJCB	1968	25x160	SK-1727AQ2	BTKW	
2.0 TDI, 2.0 TDI quattro	11/10-	CGLC, CMGB, CJCA, CJCB, CSUB, CJCD, CSUA	1968	25x160	SK-1695	BTK	
2.0 TDI, 2.0 TDI quattro	11/10-	CGLC, CMGB, CJCA, CJCD, CSUA	1968	25x160	SK-1695AQ1	BTKW	
3.0 TDI quattro	11/08-	CCWA, CPNB, CCWB	2967	24x82	SK-1720	BTK	
2.0 TDI	11/10-	CJCA, CJCB, CSUB	1968		0-N2061	TB [TE]	
2.0 TDI	11/10-	CJCA, CJCB, CSUB	1968		0-N2200	TB [DG]	
2.0 TDI quattro	11/08-	CAHA	1968		0-N1046	TB [DG]	
2.0 TDI quattro	11/08-	CAHB	1968		0-N1046	TB [DG]	
2.0 TDI quattro	11/08-	CGLA	1968	→ 10/2010	0-N1046	TB [DG]	
2.0 TDI quattro	11/08-	CGLB, CMGA	1968	→ 11/2010	0-N1046	TB [DG]	
2.0 TDI quattro	11/08-	CAHA	1968		0-N1268	TB [DG]	
2.0 TDI quattro	11/08-	CAHB	1968		0-N1268	TB [DG]	
2.0 TDI quattro	11/08-	CGLA	1968		0-N131	TB [DG]	
2.0 TDI quattro	11/08-	CGLB, CMGA	1968		0-N131	TB [DG]	
2.0 TDI quattro	11/08-	CAHA	1968		0-N1336	TB [DG]	
2.0 TDI quattro	11/08-	CAHB	1968		0-N1336	TB [DG]	
2.0 TDI quattro	11/08-	CAHA	1968		0-N1905	TB [BT]	
2.0 TDI quattro	11/08-	CAHB	1968		0-N1905	TB [BT]	
2.0 TDI quattro	11/08-	CGLA	1968		0-N2025	TB [DG]	
2.0 TDI quattro	11/08-	CGLB	1968		0-N2025	TB [DG]	
2.0 TDI quattro	11/08-	CGLA	1968		0-N2061	TB [TE]	
2.0 TDI quattro	11/08-	CGLB, CMGA	1968		0-N2061	TB [TE]	
2.0 TDI quattro	11/08-	CGLA	1968	12/2010 →	0-N2200	TB [DG]	
2.0 TDI quattro	11/08-	CGLB, CMGA	1968	12/2010 →	0-N2200	TB [DG]	
2.0 TDI quattro	08/09-	CAGA	1968		0-N1046	TB [DG]	
2.0 TDI quattro	08/09-	CAGB	1968		0-N1046	TB [DG]	
2.0 TDI quattro	08/09-	CJCA	1968	→ 10/2010	0-N1046	TB [DG]	
2.0 TDI quattro	08/09-	CAGA	1968		0-N1268	TB [DG]	
2.0 TDI quattro	08/09-	CAGB	1968		0-N1268	TB [DG]	
2.0 TDI quattro	08/09-	CJCA	1968		0-N131	TB [DG]	
2.0 TDI quattro	08/09-	CJCB	1968		0-N131	TB [DG]	
2.0 TDI quattro	08/09-	CAGA	1968		0-N1336	TB [DG]	
2.0 TDI quattro	08/09-	CAGB	1968		0-N1336	TB [DG]	
2.0 TDI quattro	08/09-	CAGA	1968		0-N1905	TB [BT]	
2.0 TDI quattro	08/09-	CAGB	1968		0-N1905	TB [BT]	
2.0 TDI quattro	08/09-	CJCA	1968		0-N2025	TB [DG]	
2.0 TDI quattro	08/09-	CJCB	1968		0-N2025	TB [DG]	
2.0 TDI quattro	08/09-	CJCA	1968		0-N2061	TB [TE]	
2.0 TDI quattro	08/09-	CJCB	1968		0-N2061	TB [TE]	
2.0 TDI quattro	08/09-	CJCB	1968		0-N2200	TB [DG]	
2.0 TDI quattro	08/09-	CJCA	1968	12/2010 →	0-N2200	TB [DG]	
2.0 TDI, 2.0 TDI quattro	11/10-	CGLC, CMGB, CJCA, CJCB, CSUB, CJCD, CSUA	1968		0-N131	TB [DG]	
3.0 TDI quattro	11/08-	CCWA, CPNB, CCWB	2967		0-N1337	TB [TE]	
2.0 TDI quattro	11/08-	CBAA	1968		0-N1534	VB [BT]	S
2.0 TDI quattro	11/08-	CAHA, CGLB	1968		0-N1738	VB [DG]	
2.0 TDI quattro	11/08-	CAHB, CGLA	1968		0-N1738	VB [DG]	
2.0 TDI quattro	11/13-	CNHA	1968		0-N2288	VB [BT]	S
2.0 TDI, 2.0 TDI quattro	08/09-	CAGA, CJCA, CAGB, CJCB, CSUB, CJCA	1968		0-N1738	VB [DG]	
2.0 TDI, 2.0 TDI quattro	11/10-	CGLC, CMGB, CJCA, CJCB, CSUB, CJCD, CSUA	1968		0-N1534	VB [BT]	S
2.0 TFSI quattro	11/08-	CAEB, CDNC, CPMA, CDNB, CNCB	1984		0-N2026	VB [TE]	S
2.0 TFSI quattro	11/08-	CAEB, CDNC, CPMA, CDNB, CNCB	1984		0-N2027	VB [DG]	
3.0 TDI quattro	11/08-	CCWB	2967	Rippenanzahl: 6	0-N1431	VB [DG]	
3.0 TDI quattro	11/08-	CCWA, CPNB, CCWB	2967		0-N1795	VB [DG]	
3.0 TDI quattro	11/08-	CCWB	2967		0-N1918	VB [BT]	S



CM³



Art. Nr.



Q5 (8R)

3.0 TDI quattro	11/08-	CCWA, CPNB	2967	→ 09/2010	0-N1918	VB [BT]	S
3.0 TDI quattro, SQ5 quattro	06/12-	CDUD, CGQB, CVUC, CTBA, CTBC	2967		0-N2287	VB [BT]	S
3.0 TFSI quattro	06/12-	CTUC, CTVA	2995		0-N1830	VB [BT]	S
3.0 TFSI quattro	06/12-	CTUC, CTVA	2995		0-N2289	VB [BT]	S
3.0 TFSI quattro	06/12-	CTUC, CTVA	2995		0-N2351	VB [DG]	
3.2 FSI quattro	11/08-	CALB	3197		0-N1830	VB [BT]	S
3.2 FSI quattro	11/08-	CALB	3197		0-N2199	VB [DG]	

Q7 (4L)

3.0 TDI	03/06-05/08	BUG	2967	24x83; mit Zubehör	SK-1597	BTK	
3.0 TDI	03/06-05/10	BUN	2967	24x83; mit Zubehör	SK-1597	BTK	
3.0 TDI	03/06-05/10	CASB	2967	24x82	SK-1720	BTK	
3.0 TDI	11/07-08/15	CASA, CCMA	2967	24x82	SK-1720	BTK	
3.0 TDI	06/09-05/12	CATA	2967	24x82	SK-1720	BTK	
3.0 TDI	03/06-05/10	CASB	2967		0-N131	TB [DG]	
3.0 TDI	03/06-05/10	BUG, BUN, CASB	2967		0-N1337	TB [TE]	
3.0 TDI	11/07-08/15	CASA, CCMA, CJGA, CNRB, CATA	2967		0-N131	TB [DG]	
3.0 TDI	03/06-05/10	BUG, BUN, CASB	2967	Rippenanzahl: 6	0-N1431	VB [DG]	
3.0 TDI	03/06-08/15	BUG, BUN, CASB, CASA, CCMA, CJGA, CNRB, CATA, CJGC, CJMA, CJGD, CLZB, CRCA	2967		0-N1795	VB [DG]	
3.0 TDI	03/06-05/10	BUG, BUN, CASB	2967	ch.4L-7-034592→	0-N1918	VB [BT]	S
3.0 TDI	03/06-05/10	BUG, BUN, CASB	2967	ch.→4L-7-034591	0-N1955	VB [BT]	S
3.0 TDI	11/07-08/15	CASA	2967	ch.4L-7-034592→	0-N1918	VB [BT]	S
3.0 TDI	11/07-08/15	CASA	2967	ch.→4L-7-034591	0-N1955	VB [BT]	S
3.0 TDI	11/07-08/15	CNRB, CJGA	2967		0-N2287	VB [BT]	S
3.0 TDI	06/09-05/12	CATA	2967	→ 09/2010	0-N1918	VB [BT]	S
3.0 TDI	05/10-08/15	CJGC, CJMA, CJGD, CLZB, CRCA	2967		0-N2287	VB [BT]	S
3.0 TFSI	05/10-08/15	CJTB, CJWB, CNA, CTWA, CJTC, CJWC, CJWE, CTWB	2995		0-N1830	VB [BT]	S
3.0 TFSI	05/10-08/15	CJTB, CJWB, CNA, CTWA, CJTC, CJWC, CJWE, CTWB	2995		0-N2199	VB [DG]	
3.0 TFSI	05/10-08/15	CJTB, CJWB, CNA, CTWA, CJTC, CJWC, CJWE, CTWB	2995		0-N2289	VB [BT]	S
3.0 TFSI	05/10-08/15	CJTB, CJWB, CNA, CTWA, CJTC, CJWC, CJWE, CTWB	2995		0-N2351	VB [DG]	
3.6 FSI	08/06-05/10	BHK	3597		0-N1676	VB [BT]	S
3.6 FSI	08/06-05/10	BHK	3597		0-N2110	VB [DG]	
4.2 TDI	03/07-06/09	BTR	4134		0-N1795	VB [DG]	

QUATTRO (85)

2.1 20V Turbo	05/84-07/87	KW	2144	19x147	SK-1127	BTK	
2.1 quattro, 2.1 Turbo	07/80-07/89	GV, WR, WX	2144	19x142; ch.85-J-900644→	SK-1126	BTK	
2.1 quattro, 2.1 Turbo	07/80-07/89	GV, WR, WX	2144	19x142; ch.85-J-900644→	SK-1126AQ1	BTKW	
2.2 20V	08/89-07/91	RR	2226	19x147	SK-1127	BTK	
2.2 Turbo	08/87-07/89	MB, MB	2226	19x142	SK-1126	BTK	
2.2 Turbo	08/87-07/89	MB, MB	2226	19x142; ch.85-J-900644→	SK-1126AQ1	BTKW	
2.1 20V Turbo, 2.1 Turbo	07/80-07/87	GV, WR, KW	2144	ch.→85-J-900643	0-N807	TB [DG]	
2.1 20V Turbo, 2.1 Turbo	07/80-07/87	GV, WR, KW	2144	ch.85-J-900644→	0-N923	TB [TE]	
2.2 20V, 2.2 quattro	12/84-07/91	HY, KV, JT, RR	2226		0-N807	TB [DG]	
2.2 Turbo	08/87-07/89	MB, MB	2226	:→001570	0-N807	TB [DG]	
2.2 Turbo	08/87-07/89	MB, MB	2226	:001571→	0-N923	TB [TE]	

TT (8N3)

1.8 T, 1.8 T quattro	10/98-06/06	AJQ, APP, ATC, AUQ, AJQ, ARY, AUQ, APX, BAM, AUM	1781	23x150; ch.→8N-Y-095000; mit Spanndämpfer, Spannrolle	SK-1337	BTK	
1.8 T, 1.8 T quattro	10/98-06/06	AJQ, APP, ATC, AUQ, AJQ, ARY, AUQ, APX, BAM, AUM	1781	23x150; ch.→8N-Y-095000; mit Spanndämpfer, Spannrolle	SK-1337AQ1	BTKW	
1.8 T, 1.8 T quattro	10/98-06/06	AJQ, APP, ATC, AUQ, AJQ, ARY, AUQ, APX, BAM, AUM	1781	23x150; ch.8N-Y-095001→	SK-1660	BTK	
1.8 T, 1.8 T quattro	10/98-06/06	AJQ, APP, ATC, AUQ, AJQ, ARY, AUQ, APX, BAM, AUM	1781	23x150; ch.8N-Y-095001→	SK-1660AQ1	BTKW	
1.8 T, 1.8 T quattro	10/98-06/06	AJQ, APP, ATC, AUQ, AJQ, ARY, AUQ, APX, BAM, AUM	1781	23x150; ch.→8N-Y-095000	SK-1709	BTK	
1.8 T, 1.8 T quattro	10/98-06/06	AJQ, APP, ATC, AUQ, AJQ, ARY, AUQ, APX, BAM, AUM	1781	23x150; ch.8N-Y-095001→	SK-1710	BTK	
1.8 T, 1.8 T quattro	03/05-06/06	BFV, BVP, BVR	1781	23x150	SK-1660	BTK	
1.8 T, 1.8 T quattro	03/05-06/06	BFV, BVP, BVR	1781	23x150	SK-1660AQ1	BTKW	
1.8 T, 1.8 T quattro	03/05-06/06	BFV, BVP, BVR	1781	23x150	SK-1710	BTK	
1.8 T, 1.8 T quattro	10/98-06/06	AJQ, APP, ATC, AUQ, AJQ, ARY, AUQ, APX, BAM, AUM	1781	ch.8N-Y-095001→	0-N1042	TB [TE]	



CM³



Art. Nr.



TT (8N3)								
1.8 T, 1.8 T quattro	10/98-06/06	AJQ, APP, ATC, AUQ, AJQ, ARY, AUQ, APX, BAM, AUM, BFV, BVP, BVR	1781			0-N1237	TB [BT]	
1.8 T, 1.8 T quattro	10/98-06/06	AJQ, APP, ATC, AUQ, AJQ, ARY, AUQ, APX, BAM, AUM, BFV, BVP, BVR	1781			0-N1316	TB [DG]	
1.8 T, 1.8 T quattro	10/98-06/06	AJQ, APP, ATC, AUQ, AJQ, ARY, AUQ, APX, BAM, AUM	1781	ch.→8N-Y-095000		0-N1654	TB [TE]	
1.8 T, 1.8 T quattro	03/05-06/06	BFV, BVP, BVR	1781			0-N1042	TB [TE]	
1.8 T	10/98-06/06	AJQ, APP	1781			0-N1041	VB [BT]	S
1.8 T quattro	10/98-06/06	AJQ	1781			0-N1041	VB [BT]	S
1.8 T quattro	10/98-06/06	APX	1781			0-N1041	VB [BT]	S
3.2 VR6 quattro	07/03-06/06	BHE, BPF, BPF, BPF, BPF	3189	Rippenanzahl: 6		0-N1496S	VB [TE]	

TT (FV3)								
2.0 TDI	07/14-	CUNA	1968	✳		0-N2288	VB [BT]	S

TT Roadster (8N9)								
1.8 T, 1.8 T quattro	10/99-06/06	AJQ, APP, ATC, AUQ, AJQ, ARY, AUQ, APX, BAM, AUM	1781	23x150; ch.→8N-Y-095000; mit Spanndämpfer, Spannrolle		SK-1337	BTK	
1.8 T, 1.8 T quattro	10/99-06/06	AJQ, APP, ATC, AUQ, AJQ, ARY, AUQ, APX, BAM, AUM	1781	23x150; ch.→8N-Y-095000; mit Spanndämpfer, Spannrolle		SK-1337AQ1	BTKW	
1.8 T, 1.8 T quattro	10/99-06/06	AJQ, APP, ATC, AUQ, AJQ, ARY, AUQ, APX, BAM, AUM	1781	23x150; ch.8N-Y-095001→		SK-1660	BTK	
1.8 T, 1.8 T quattro	10/99-06/06	AJQ, APP, ATC, AUQ, AJQ, ARY, AUQ, APX, BAM, AUM	1781	23x150; ch.8N-Y-095001→		SK-1660AQ1	BTKW	
1.8 T, 1.8 T quattro	10/99-06/06	AJQ, APP, ATC, AUQ, AJQ, ARY, AUQ, APX, BAM, AUM	1781	23x150; ch.→8N-Y-095000		SK-1709	BTK	
1.8 T, 1.8 T quattro	10/99-06/06	AJQ, APP, ATC, AUQ, AJQ, ARY, AUQ, APX, BAM, AUM	1781	23x150; ch.8N-Y-095001→		SK-1710	BTK	
1.8 T, 1.8 T quattro	09/05-06/06	BVP, BVR	1781	23x150		SK-1660	BTK	
1.8 T, 1.8 T quattro	09/05-06/06	BVP, BVR	1781	23x150		SK-1660AQ1	BTKW	
1.8 T, 1.8 T quattro	09/05-06/06	BVP, BVR	1781	23x150		SK-1710	BTK	
1.8 T, 1.8 T quattro	10/99-06/06	AJQ, APP, ATC, AUQ, AJQ, ARY, AUQ, APX, BAM, AUM	1781	ch.8N-Y-095001→		0-N1042	TB [TE]	
1.8 T, 1.8 T quattro	10/99-06/06	AJQ, APP, ATC, AUQ, AJQ, ARY, AUQ, APX, BAM, AUM, BVP, BVR	1781			0-N1237	TB [BT]	
1.8 T, 1.8 T quattro	10/99-06/06	AJQ, APP, ATC, AUQ, AJQ, ARY, AUQ, APX, BAM, AUM, BVP, BVR	1781			0-N1316	TB [DG]	
1.8 T, 1.8 T quattro	10/99-06/06	AJQ, APP, ATC, AUQ, AJQ, ARY, AUQ, APX, BAM, AUM	1781	ch.→8N-Y-095000		0-N1654	TB [TE]	
1.8 T, 1.8 T quattro	09/05-06/06	BVP, BVR	1781			0-N1042	TB [TE]	
1.8 T	10/99-06/06	AJQ, APP	1781			0-N1041	VB [BT]	S
1.8 T quattro	10/99-06/06	APX	1781			0-N1041	VB [BT]	S
1.8 T quattro	02/00-06/06	AJQ	1781			0-N1041	VB [BT]	S
3.2 VR6 quattro	07/03-06/06	BHE, BPF, BPF, BPF, BPF	3189	Rippenanzahl: 6		0-N1496S	VB [TE]	

TT Roadster (FV9)								
2.0 TDI	11/14-	CUNA	1968	✳		0-N2288	VB [BT]	S

TT (8J3)								
2.0 quattro, 2.0 TFSI quattro	05/08-06/14	CDLA, CDMA, CDLB	1984	23x148		SK-1724	BTK	
2.0 quattro, 2.0 TFSI quattro	05/08-06/14	CDLA, CDMA, CDLB	1984	23x148		SK-1724AQ1	BTKW	
2.0 TDI quattro	06/08-06/14	CBBB	1968	30x160		SK-1694	BTK	
2.0 TDI quattro	06/08-06/14	CBBB	1968	30x160		SK-1694AQ2	BTKW	
2.0 TDI quattro	06/08-06/14	CFGB	1968	25x160		SK-1695	BTK	
2.0 TDI quattro	06/08-06/14	CFGB	1968	25x160		SK-1695AQ1	BTKW	
2.0 TDI quattro	06/08-06/14	CFGB	1968	25x160		SK-1727AQ2	BTKW	
2.0 TFSI	08/06-06/10	BPY, BWA	1984	23x148		SK-1724	BTK	
2.0 TFSI	08/06-06/10	BPY, BWA	1984	23x148		SK-1724AQ1	BTKW	
2.0 quattro, 2.0 TFSI quattro	05/08-06/14	CDLA, CDMA, CDLB	1984			0-N1316	TB [DG]	
2.0 quattro, 2.0 TFSI quattro	05/08-06/14	CDLA, CDMA, CDLB	1984			0-N1346	TB [DG]	
2.0 quattro, 2.0 TFSI, 2.0 TFSI quattro	08/06-06/14	BPY, BWA, CCTA, CDLA, CDMA, CDLB	1984			0-N2208	TB [TE]	
2.0 TDI quattro	06/08-06/14	CBBB	1968			0-N1046	TB [DG]	
2.0 TDI quattro	06/08-06/14	CFGB	1968	→ 10/2010		0-N1046	TB [DG]	
2.0 TDI quattro	06/08-06/14	CBBB	1968			0-N1268	TB [DG]	
2.0 TDI quattro	06/08-06/14	CFGB	1968			0-N131	TB [DG]	
2.0 TDI quattro	06/08-06/14	CBBB	1968			0-N1336	TB [DG]	
2.0 TDI quattro	06/08-06/14	CBBB	1968			0-N1905	TB [BT]	
2.0 TDI quattro	06/08-06/14	CFGB	1968			0-N2025	TB [DG]	
2.0 TDI quattro	06/08-06/14	CFGB	1968			0-N2061	TB [TE]	
2.0 TDI quattro	06/08-06/14	CFGB	1968	12/2010 →		0-N2200	TB [DG]	
2.0 TFSI	08/06-06/10	BPY, BWA	1984			0-N1316	TB [DG]	



CM³



Art. Nr.



ohne Halter

TT (8J3)

2.0 TFSI	08/06-06/10	BPY, BWA	1984		0-N1346	TB [DG]	
1.8 TFSI	06/08-06/14	CDAA	1798		0-N1832	VB [BT]	S
2.0 quattro, 2.0 TFSI quattro	05/08-06/14	CDLA, CDMA, CDLB	1984		0-N1656	VB [BT]	S
2.0 TDI quattro	06/08-06/14	CBAA	1968		0-N1534	VB [BT]	S
2.0 TFSI	08/06-06/10	BPY, BWA	1984		0-N1656	VB [BT]	S
2.0 TFSI	08/06-06/10	CCTA	1984		0-N1832	VB [BT]	S
2.0 TFSI, 2.0 TFSI quattro	06/08-06/14	BWA, CCZA, CESA, CESA, CETA	1984		0-N1832	VB [BT]	S
2.5 TFSI quattro	07/09-06/14	CEPA, CEPB	2480		0-N1892	VB [BT]	S
2.5 TFSI quattro	07/09-06/14	CEPA, CEPB	2480		0-N1893	VB [BT]	S
3.2 V6 quattro	08/06-06/10	BUB	3189		0-N1715	VB [DG]	
3.2 V6 quattro	08/06-06/10	BUB	3189		0-N2209	VB [BT]	S

TT Roadster (8J9)

2.0 quattro, 2.0 TFSI quattro	05/08-06/14	CDLA, CDMA, CDLB	1984	23x148	SK-1724	BTK	
2.0 quattro, 2.0 TFSI quattro	05/08-06/14	CDLA, CDMA, CDLB	1984	23x148	SK-1724AQ1	BTKW	
2.0 TDI quattro	06/08-06/14	CBBB	1968	30x160	SK-1694	BTK	
2.0 TDI quattro	06/08-06/14	CBBB	1968	30x160	SK-1694AQ2	BTKW	
2.0 TDI quattro	06/08-06/14	CFGB	1968	25x160	SK-1695	BTK	
2.0 TDI quattro	06/08-06/14	CFGB	1968	25x160	SK-1695AQ1	BTKW	
2.0 TDI quattro	06/08-06/14	CFGB	1968	25x160	SK-1727AQ2	BTKW	
2.0 TFSI	03/07-06/10	BPY, BWA	1984	23x148	SK-1724	BTK	
2.0 TFSI	03/07-06/10	BPY, BWA	1984	23x148	SK-1724AQ1	BTKW	
2.0 quattro, 2.0 TFSI quattro	05/08-06/14	CDLA, CDMA, CDLB	1984		0-N1316	TB [DG]	
2.0 quattro, 2.0 TFSI quattro	05/08-06/14	CDLA, CDMA, CDLB	1984		0-N1346	TB [DG]	
2.0 quattro, 2.0 TFSI, 2.0 TFSI quattro	03/07-06/14	BPY, BWA, CCTA, CDLA, CDMA, CDLB	1984		0-N2208	TB [TE]	
2.0 TDI quattro	06/08-06/14	CBBB	1968		0-N1046	TB [DG]	
2.0 TDI quattro	06/08-06/14	CFGB	1968	→ 11/2010	0-N1046	TB [DG]	
2.0 TDI quattro	06/08-06/14	CBBB	1968		0-N1268	TB [DG]	
2.0 TDI quattro	06/08-06/14	CFGB	1968		0-N131	TB [DG]	
2.0 TDI quattro	06/08-06/14	CBBB	1968		0-N1336	TB [DG]	
2.0 TDI quattro	06/08-06/14	CBBB	1968		0-N1905	TB [BT]	
2.0 TDI quattro	06/08-06/14	CFGB	1968		0-N2025	TB [DG]	
2.0 TDI quattro	06/08-06/14	CFGB	1968		0-N2061	TB [TE]	
2.0 TDI quattro	06/08-06/14	CFGB	1968	12/2010 →	0-N2200	TB [DG]	
2.0 TFSI	03/07-06/10	BPY, BWA	1984		0-N1316	TB [DG]	
2.0 TFSI	03/07-06/10	BPY, BWA	1984		0-N1346	TB [DG]	
1.8 TFSI	06/08-06/14	CDAA	1798		0-N1832	VB [BT]	S
2.0 quattro, 2.0 TFSI quattro	05/08-06/14	CDLA, CDMA, CDLB	1984		0-N1656	VB [BT]	S
2.0 TDI quattro	06/08-06/14	CBAA	1968		0-N1534	VB [BT]	S
2.0 TFSI	03/07-06/10	BPY, BWA	1984		0-N1656	VB [BT]	S
2.0 TFSI	03/07-06/10	CCTA	1984		0-N1832	VB [BT]	S
2.0 TFSI, 2.0 TFSI quattro	06/08-06/14	CCZA, CESA, CESA, CETA	1984		0-N1832	VB [BT]	S
2.5 TFSI quattro	07/09-06/14	CEPA, CEPB	2480		0-N1892	VB [BT]	S
2.5 TFSI quattro	07/09-06/14	CEPA, CEPB	2480		0-N1893	VB [BT]	S
3.2 V6 quattro	03/07-06/10	BUB	3189		0-N1715	VB [DG]	
3.2 V6 quattro	03/07-06/10	BUB	3189		0-N2209	VB [BT]	S

V8 (44_, 4C_)

3.6 quattro	10/88-02/94	PT	3562		0-N2414	TB [VD]	
4.2 quattro	10/91-02/94	ABH	4172		0-N2414	TB [VD]	
3.6 quattro	10/88-02/94	PT	3562		0-N1632	VB [DG]	
3.6 quattro	10/88-02/94	PT	3562		0-N1967	VB [VD]	
4.2 quattro	10/91-02/94	ABH	4172		0-N1632	VB [DG]	
4.2 quattro	10/91-02/94	ABH	4172		0-N1967	VB [VD]	

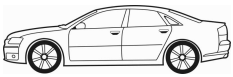

CM³



Art. Nr.



ohne Halter

200 (447)

1.8 Turbo	05/98-09/99	ANZ	1800		0-N131	TB [DG]	
-----------	-------------	-----	------	--	--------	---------	--

A4 Stufenheck (8E2, B6)

1.8 TURBO	02/03-07/05	BFB, BKB	1781	23x150; mit Zubehör	SK-1726	BTK	
1.8 TURBO	02/03-07/05	BFB, BKB	1781		0-N1316	TB [DG]	

A4 Stufenheck (8EC, B7)

1.8 TURBO	07/05-09/08	BKB	1781	23x150; mit Zubehör	SK-1726	BTK	
1.8 TURBO	07/05-09/08	BKB	1781		0-N1316	TB [DG]	
2.0 TURBO	07/05-09/08	BGB, BWE	1984		0-N2208	TB [TE]	

A6L Stufenheck (4B5, C5)

1.8, 1.8 T	01/00-12/05	ADR, ANQ, AWL, BGC	1781	23x150; mit Zubehör	SK-1726	BTK	
1.8, 1.8 T	01/00-12/05	ADR, ANQ, AWL, BGC	1781		0-N1316	TB [DG]	

A6L Stufenheck (4F2, C6)

2.7 TDI	08/09-12/11	CANA	2699	24x82	SK-1720	BTK	
---------	-------------	------	------	-------	---------	-----	--



CM³



Art. Nr.



ohne Halter

MAESTRO (XC)

2.0 EFI	10/84-08/90	20 HA50AA, 20 HC51AA, 20 HC81	1994	17x104; 01/1986 →	SK-1176	BTK	
---------	-------------	-------------------------------	------	-------------------	----------------	-----	--

MONTEGO (XE)

2.0 Turbo	04/84-08/88	20 HC85	1994	17x104; 01/1986 →	SK-1176	BTK	
-----------	-------------	---------	------	-------------------	----------------	-----	--

MONTEGO Kombi (XE)

2.0	10/84-08/91	20 H, 20 HSC	1994	17x104; 01/1986 →	SK-1176	BTK	
-----	-------------	--------------	------	-------------------	----------------	-----	--



CM³



Art. Nr.



ohne Halter

Y10

1.0, 1.0 4WD, 1.0 KAT	03/85-10/95	156A2.000, 156A2.246, 156A3.000	999	15x104	SK-1023	BTK	
1.1, 1.1 4WD, 1.1 i.e. KAT	06/89-10/95	156C.000, 156C.046	1108	15x104	SK-1023	BTK	



CM³



Art. Nr.



ohne Halter

ASTRA VAN Kombi

1.6	09/84-08/91	16 SV	1598	17x111; :02J22350→; mit Zubehör	SK-1162	BTK	
1.6	09/84-08/91	16 SV	1598	17x111; :02J22350→; mit Zubehör	SK-1162AQ1	BTKW	
1.6 D	09/85-08/89	16 D, 16 DA	1598	24x146; :14498631→;	SK-1037	BTK	
1.6 D	09/85-08/89	16 D, 16 DA	1598	24x146; :14503757→;	SK-1037	BTK	
1.6 D	09/85-08/89	16 D, 16 DA	1598	24x146; :14498631→;	SK-1037AQ1	BTKW	
1.6 D	09/85-08/89	16 D, 16 DA	1598	24x146; :14503757→;	SK-1037AQ1	BTKW	
1.6 D	09/85-08/89	16 D, 16 DA	1598	24x147; →14498630;	SK-1056	BTK	
1.6 D	09/85-08/89	16 D, 16 DA	1598	24x147; →14503756;	SK-1056	BTK	
1.7 D	09/88-08/91	17 D	1699	24x176; :14363651→	SK-1038	BTK	
1.7 D	09/88-08/91	17 D	1699	24x176; :14363651→	SK-1038AQ1	BTKW	

ASTRA VAN Kombi

1.6 D	07/82-08/84	16 D	1598	24x147	SK-1056	BTK	
-------	-------------	------	------	--------	----------------	-----	--

ASTRAMAX Kombi

1.7 D	09/88-06/90	17 D	1699	24x176; :14363651→	SK-1038	BTK	
1.7 D	09/88-06/90	17 D	1699	24x176; :14363651→	SK-1038AQ1	BTKW	



CM³



Art. Nr.



1 (E81)							
116 d, 116d, 118 d, 120 d, 123 d	09/06-09/12	N47 D20 A, N47 D20 C, N47 D20 B, N47 D20 D	1995			0-N1950	VB [DG]
116 d, 116d, 118 d, 120 d, 123 d	09/06-09/12	N47 D20 A, N47 D20 C, N47 D20 B, N47 D20 D	1995			0-N1958	VB [BT] S
116 d, 120 d, 123 d	09/06-09/12	N47 D20 A, N47 D20 C, N47 D20 B, N47 D20 D	1995	für Fahrzeuge ohne elektrische Servolenkung		0-N2130	VB [DG]
116 i	03/07-09/12	N45 B16 A, N45 B16 A	1596	☼		0-N1505S	VB [DG]
116 i	03/07-09/12	N43 B16 A, N45 B16 A	1599	☼		0-N1505S	VB [DG]
116 i	03/07-09/12	N45 B16 A	1596			0-N1794	VB [BT] S
116 i	03/07-09/12	N45 B16 A	1599			0-N1794	VB [BT] S
116 i	03/07-09/12	N43 B16 A	1596			0-N2130	VB [DG]
116 i	03/07-09/12	N43 B16 A	1599			0-N2130	VB [DG]
116 i	11/08-09/12	N43 B20 A	1995	☼		0-N2130	VB [DG]
116 i, 118 i, 120 i	09/06-09/12	N43 B20 A, N43 B20 A, N46 B20 B, N43 B20 A, N46 B20 B, N46 B20 C	1995	für Fahrzeuge ohne Aktivlenkung		0-N2031	VB [BT] S
118 d	09/06-09/12	M47 D20 (204D4), N47 D20 A, N47 D20 C	1995			0-N1793	VB [BT] S
118 d	09/06-09/12	M47 D20 (204D4), N47 D20 A, N47 D20 C	1995			0-N1871	VB [DG]
118 d, 120 d	09/06-09/12	N47 D20	1995			0-N1950	VB [DG]
118 d, 120 d	09/06-09/12	N47 D20	1995			0-N1958	VB [BT] S
118 d, 120 d	09/06-09/12	N47 D20	1995	für Fahrzeuge ohne elektrische Servolenkung		0-N2130	VB [DG]
118 i	09/06-09/12	N43 B20 A	1995			0-N2130	VB [DG]
118 i, 120 i	09/06-09/12	N43 B20 A, N46 B20 B, N43 B20 A, N46 B20 B, N46 B20 C	1995	☼		0-N1505S	VB [DG]
118 i, 120 i	09/06-09/12	N46 B20	1995			0-N1794	VB [BT] S
118 i, 120 i	09/06-09/12	N43 B20	1995	☼		0-N2130	VB [DG]
120 d	03/07-09/12	M47N	1995			0-N1793	VB [BT] S
120 d	03/07-09/12	M47	1995			0-N1871	VB [DG]
120 i	09/06-09/12	N43	1995	für Fahrzeuge ohne Aktivlenkung		0-N2031	VB [BT] S
120 i	09/06-09/12	N43 B20 A, N46 B20 B, N46 B20 C	1995	für Fahrzeuge mit Aktivlenkung		0-N2212	VB [BT] S
130 i	09/06-09/12	N52 B30 A, N52 B30 B, N52 B30 BF	2996			0-N1788	VB [BT] S
130 i	09/06-09/12	N52 B30 A, N52 B30 B, N52 B30 BF	2996			0-N2128	VB [DG]
1 Coupe (E82)							
118 d, 120 d	10/07-10/13	N47 D20 A, N47 D20 C, N47 D20 C	1995	für Fahrzeuge mit elektrischer Servolenkung, ☼		0-N2130	VB [DG]
118 d, 120 d	10/07-10/13	N47 D20 A, N47 D20 C, N47 D20 C	1995	für Fahrzeuge mit elektrischer Servolenkung, ☼		0-N2130	VB [DG]
118 d, 120 d	10/07-10/13	N47 D20 A, N47 D20 C, N47 D20 C	1995	für Fahrzeuge mit Servolenkung, ☼		0-N2130	VB [DG]
118 d, 120 d, 123 d	10/07-10/13	N47 D20 A, N47 D20 C, N47 D20 B, N47 D20 D, N47 D20 C	1995			0-N1950	VB [DG]
118 d, 120 d, 123 d	10/07-10/13	N47 D20 A, N47 D20 C, N47 D20 B, N47 D20 D, N47 D20 C	1995			0-N1958	VB [BT] S
120 i	10/07-10/13	N43 B20 A, N46 B20 B	1995			0-N2031	VB [BT] S
120 i	10/07-10/13	N43 B20 A, N46 B20 B	1995	☼		0-N2130	VB [DG]
123 d	10/07-10/13	N47 D20 B, N47 D20 D	1995	☼		0-N2130	VB [DG]
125 i	10/07-10/13	N52 B30 A	2996			0-N1788	VB [BT] S
125 i	10/07-10/13	N52 B30 A	2996			0-N2128	VB [DG]
135 i	10/07-10/13	N54	2979			0-N1621	VB [BT] S
135 i	10/07-10/13	N54 B30 A, N55 B30 A	2979			0-N2129	VB [DG]
135 i	10/07-10/13	N55	2979			0-N2372	VB [DG]
135 i	10/07-10/13	N55	2979			0-N2373	VB [DG]
135 i, M	10/07-10/13	N54 B30 A, N54 B30 A, N55 B30 A	2979			0-N2130	VB [DG]
M	04/11-06/12	N54 B30 A	2979			0-N1621	VB [BT] S
125i [USA]							
125i	01/09-12/09	N54	2979			0-N1621	VB [BT] S
1 (E87)							
116 d, 116d, 123 d	03/07-09/12	N47 D20 A, N47 D20 B, N47 D20 C, N47 D20 D, N47 D20 C	1995			0-N1950	VB [DG]
116 d, 116d, 123 d	03/07-09/12	N47 D20 A, N47 D20 B, N47 D20 C, N47 D20 D, N47 D20 C	1995			0-N1958	VB [BT] S
116 d, 123 d	03/07-09/12	N47 D20 A, N47 D20 B, N47 D20 C, N47 D20 D	1995	für Fahrzeuge ohne elektrische Servolenkung		0-N2130	VB [DG]
116 i	11/03-09/12	N43 B16 A, N45 B16 A	1596	☼		0-N1505S	VB [DG]
116 i	11/03-09/12	N45 B16 A	1596			0-N1794	VB [BT] S
116 i	11/03-09/12	N43 B20 A	1995			0-N1794	VB [BT] S
116 i	11/03-09/12	N43 B16 A	1596			0-N2130	VB [DG]
116 i	11/03-09/12	N43 B20 A	1995			0-N2130	VB [DG]
116 i	09/07-09/12	N43 B16 A, N45 B16 A	1599	☼		0-N1505S	VB [DG]

CM³

Art. Nr.

**1 (E87)**

116 i	09/07-09/12	N45 B16 A	1599		0-N1794	VB [BT]	S
116 i	09/07-09/12	N43 B16 A	1599		0-N2130	VB [DG]	
116 i, 118 i, 120 i	11/03-09/12	N43 B20 A, N43 B20 A, N46 B20 B, N43 B20 A, N46 B20 B, N46 B20 BD, N46 B20 C, N46 B20 CC, N46 B20 CD	1995	für Fahrzeuge ohne Aktivlenkung	0-N2031	VB [BT]	S
118 d	11/03-09/12	M47 D20 (204D4), N47 D20 A, N47 D20 C	1995		0-N1871	VB [DG]	
118 d, 120 d	11/03-09/12	M47 D20 (204D4), N47 D20 A, N47 D20 C	1995		0-N1793	VB [BT]	S
118 d, 120 d	11/03-09/12	M47	1995		0-N1871	VB [DG]	
118 d, 120 d	11/03-09/12	N47 D20	1995		0-N1950	VB [DG]	
118 d, 120 d	11/03-09/12	N47 D20	1995		0-N1958	VB [BT]	S
118 d, 120 d	11/03-09/12	N47 D20	1995	für Fahrzeuge ohne elektrische Servolenkung	0-N2130	VB [DG]	
118 i, 120 i	11/03-09/12	N43 B20 A, N46 B20 B, N46 B20 B, N46 B20 BD, N46 B20 C, N46 B20 CC, N46 B20 CD, N46 B20 CD	1995	☼	0-N1505S	VB [DG]	
118 i, 120 i	11/03-09/12	N46 B20	1995		0-N1794	VB [BT]	S
118 i, 120 i	11/03-09/12	N43 B20 A	1995		0-N2130	VB [DG]	
120 d	11/03-09/12	M47N	1995		0-N1793	VB [BT]	S
120 i	11/03-09/12	N43	1995	für Fahrzeuge ohne Aktivlenkung	0-N2031	VB [BT]	S
120 i	11/03-09/12	N43 B20 A, N46 B20 B, N46 B20 BD, N46 B20 C, N46 B20 CC, N46 B20 CD	1995	für Fahrzeuge mit Aktivlenkung	0-N2212	VB [BT]	S
130 i	03/05-09/12	N52 B30 A, N52 B30 AF, N52 B30 B, N52 B30 BF	2996		0-N1788	VB [BT]	S
130 i	03/05-09/12	N52 B30 A, N52 B30 AF, N52 B30 B, N52 B30 BF	2996		0-N2128	VB [DG]	

1 Cabriolet (E88)

118 d	09/08-12/13	N47	1995	für Fahrzeuge mit elektrischer Servolenkung, ☼	0-N2130	VB [DG]	
118 d	09/08-12/13	N47	1995	für Fahrzeuge mit elektrischer Servolenkung, ☼	0-N2130	VB [DG]	
118 d	09/08-12/13	N47	1995	für Fahrzeuge mit Servolenkung, ☼	0-N2130	VB [DG]	
118 d, 120 d	03/08-12/13	N47 D20 A, N47 D20 C	1995	für Fahrzeuge mit elektrischer Servolenkung, ☼	0-N2130	VB [DG]	
118 d, 120 d	03/08-12/13	N47 D20 A, N47 D20 C	1995	für Fahrzeuge mit elektrischer Servolenkung, ☼	0-N2130	VB [DG]	
118 d, 120 d	03/08-12/13	N47 D20 A, N47 D20 C	1995	für Fahrzeuge mit Servolenkung, ☼	0-N2130	VB [DG]	
118 d, 120 d, 123 d	03/08-12/13	N47 D20 A, N47 D20 C, N47 D20 B, N47 D20 D, N47 D20 C	1995		0-N1950	VB [DG]	
118 d, 120 d, 123 d	03/08-12/13	N47 D20 A, N47 D20 C, N47 D20 B, N47 D20 D, N47 D20 C	1995		0-N1958	VB [BT]	S
118 i, 120 i	03/08-12/13	N43 B20 A	1995	für Fahrzeuge ohne Aktivlenkung	0-N2031	VB [BT]	S
118 i, 120 i	03/08-12/13	N43 B20 A	1995	☼	0-N2130	VB [DG]	
120 d	03/08-12/13	N47 D20 C	1995	für Fahrzeuge ohne elektrische Servolenkung	0-N2130	VB [DG]	
120 i	03/08-12/13	N46 B20 B, N46 B20 C, N46 B20 E	1995		0-N1794	VB [BT]	S
120 i	03/08-12/13	N43 B20 A	1995	für Fahrzeuge mit Aktivlenkung	0-N2212	VB [BT]	S
123 d	09/08-12/13	N47 D20 B, N47 D20 D	1995	☼	0-N2130	VB [DG]	
125 i	03/08-12/13	N52 B30 A	2996		0-N1788	VB [BT]	S
125 i	03/08-12/13	N52 B30 A	2996		0-N2128	VB [DG]	
135 i	03/08-12/13	N54	2979		0-N1621	VB [BT]	S
135 i	03/08-12/13	N54 B30 A, N55 B30 A	2979		0-N2129	VB [DG]	
135 i	03/08-12/13	N54 B30 A, N55 B30 A	2979		0-N2130	VB [DG]	
135 i	03/08-12/13	N55	2979		0-N2372	VB [DG]	
135 i	03/08-12/13	N55 B30 A	2979		0-N2372	VB [DG]	
135 i	03/08-12/13	N55	2979		0-N2373	VB [DG]	
135 i	03/08-12/13	N55 B30 A	2979		0-N2373	VB [DG]	

1 (F20)

114 d, 116 d	10/12-	N47 D16 A	1598		0-N2216	VB [BT]	
114 d, 116 d	10/12-	N47 D16 A	1598		0-N2216S1	VB [DG]	
114 d, 116 d	10/12-	N47 D16 A	1598		0-N2216S2	VB [DG]	
114 i, 116 i, 118 i	11/10-	N13 B16 A	1598		0-N2215	VB [BT]	S
114 i, 116 i, 118 i	11/10-	N13 B16 A	1598	für OE: 11 28 7 598 832, 11 28 7 598 833	0-N2237	VB [DG]	
116 d, 118 d, 118 d xDrive, 120 d, 120 d xDrive, 125 d	12/10-	N47 D20 C, N47 D20 D	1995		0-N2216	VB [BT]	
116 d, 118 d, 118 d xDrive, 120 d, 120 d xDrive, 125 d	12/10-	N47 D20 C, N47 D20 D	1995		0-N2216S1	VB [DG]	
116 d, 118 d, 118 d xDrive, 120 d, 120 d xDrive, 125 d	12/10-	N47 D20 C, N47 D20 D	1995		0-N2216S2	VB [DG]	
116 i, 118 i	11/10-	N13 B16 A	1598	mit Elektronik	0-N2264	VB [BT]	



CM³



Art. Nr.



1 (F20)							
M 135 i, M 135 i xDrive	11/11-	N55 B30 A	2979			0-N2370	VB [DG]
1 (F21)							
114 d, 116 d	12/11-	N47 D16 A	1598			0-N2216	VB [BT]
114 d, 116 d	12/11-	N47 D16 A	1598			0-N2216S1	VB [DG]
114 d, 116 d	12/11-	N47 D16 A	1598			0-N2216S2	VB [DG]
114 i, 116 i, 118 i	12/11-	N13 B16 A	1598			0-N2215	VB [BT] S
114 i, 116 i, 118 i	12/11-	N13 B16 A	1598	für OE: 11 28 7 598 832, 11 28 7 598 833		0-N2237	VB [DG]
116 d, 118 d, 118 d xDrive, 120 d, 120 d xDrive, 125 d	12/11-	N47 D20 C, N47 D20 D	1995			0-N2216	VB [BT]
116 d, 118 d, 118 d xDrive, 120 d, 120 d xDrive, 125 d	12/11-	N47 D20 C, N47 D20 D	1995			0-N2216S1	VB [DG]
116 d, 118 d, 118 d xDrive, 120 d, 120 d xDrive, 125 d	12/11-	N47 D20 C, N47 D20 D	1995			0-N2216S2	VB [DG]
M 135 i, M 135 i xDrive	12/11-	N55 B30 A	2979			0-N2370	VB [DG]
2 Coupe (F22, F87)							
218 d, 220 d, 225 d	10/13-	N47 D20 C, N47 D20 D	1995			0-N2216	VB [BT]
218 d, 220 d, 225 d	10/13-	N47 D20 C, N47 D20 D	1995			0-N2216S1	VB [DG]
218 d, 220 d, 225 d	10/13-	N47 D20 C, N47 D20 D	1995			0-N2216S2	VB [DG]
M 235 i, M 235 i xDrive	10/13-	N55 B30 A	2979			0-N2370	VB [DG]
3 (E21)							
320/6	09/77-08/82	M20 B20 (206VA), M20 B20 (206VA)	1990			0-N809	TB [TE]
323 i	01/78-08/82	M20 B23 (236EA)	2316			0-N809	TB [TE]
3 (E30)							
316 i	09/87-06/91	M40 B16 (164E1)	1596	21x110; 05/1988 → 08/1990		SK-1059	BTK
316 i	07/88-06/91	M40 B16 (164E1)	1596	21x110; → 08/1990		SK-1059	BTK
318 i	09/87-06/91	M40 B18 (184E1)	1796	21x110; → 11/1990		SK-1059	BTK
324 d, 324 td	09/85-08/91	M21 D24 (246DA), M21 D24, M21 D24 (246TB)	2443	28.5x138		SK-1064	BTK
316 i	09/87-06/91	M40 B16 (164E1)	1596			0-N866	TB [DG]
316 i	09/87-06/91	M40 B16 (164E1)	1596			0-N867	TB [DG]
316 i	09/87-06/91	M40 B16 (164E1)	1596			0-N954	TB [TE]
318 i	09/87-06/91	M40 B18 (184E1)	1796			0-N866	TB [DG]
318 i	09/87-06/91	M40 B18 (184E1)	1796			0-N867	TB [DG]
318 i	09/87-06/91	M40 B18 (184E1)	1796			0-N954	TB [TE]
320 i	09/82-06/90	M20 B20 (206EB), M20 B20 (206KA)	1990			0-N809	TB [TE]
320 i	12/85-06/91	M20 B20 (206KA)	1991			0-N809	TB [TE]
323 i	09/82-08/86	M20 B23 (236EC)	2316			0-N809	TB [TE]
324 d, 324 td	09/85-08/91	M21 D24 (246DA), M21 D24, M21 D24 (246TB)	2443			0-N925	TB [TE]
325 e 2.7	10/83-12/88	M20 B27 (276KA), M20 B27 (276KA), M20 B27 (276KB), M20 B27 (276KB)	2693			0-N809	TB [TE]
325 i, 325 i X	09/83-08/91	M20 B25 (256E1), M20 B25 (256E1), M20 B25 (256E2), M20 B25 (256EX), M20 B25 (256K1), M20 B25 (256E1), M20 B25 (256E2), M20 B25 (256EX), M20 B25 (256EX), M20 B25 (256K1), M20 B25 (256E2)	2494			0-N809	TB [TE]
318 is	09/89-08/91	M42 B18 (184S1)	1796			0-N1927	FB [TE]
3 Cabriolet (E30)							
318 i	06/88-10/93	M40 B18 (184E1), M40 B18 C	1796	21x110		SK-1059	BTK
318 i	09/90-10/93	M40 B18 (184E1)	1796			0-N866	TB [DG]
318 i	09/90-10/93	M40 B18 (184E1)	1796			0-N867	TB [DG]
318 i	09/90-10/93	M40 B18 (184E1)	1796			0-N954	TB [TE]
320 i	04/86-10/93	M20 B20, M20 B20 (206KA)	1990			0-N809	TB [TE]
325 i	12/85-10/93	M20 B25 (256E2), M20 B25 (256E2), M20 B25 (256EX), M20 B25 (256EX), M20 B25 (256K1)	2494			0-N809	TB [TE]
3 Touring (E30)							
316 i	09/91-06/94	M40 B16 (164E1)	1596	21x110		SK-1059	BTK
318 i	09/87-06/91	M40 B18 (184E1)	1796	21x110; 09/1988 →		SK-1059	BTK
318 i	04/89-06/94	M40 B18 (184E1)	1796	21x110		SK-1059	BTK
324 td	01/88-06/93	M21 D24, M21 D24 (246TB)	2443	28.5x138		SK-1064	BTK
316 i	09/91-06/94	M40 B16 (164E1)	1596			0-N866	TB [DG]
316 i	09/91-06/94	M40 B16 (164E1)	1596			0-N867	TB [DG]
316 i	09/91-06/94	M40 B16 (164E1)	1596			0-N954	TB [TE]
318 i	09/87-06/94	M40 B18 (184E1)	1796			0-N866	TB [DG]



CM³



Art. Nr.



3 Touring (E30)

318 i	09/87-06/94	M40 B18 (184E1)	1796		0-N867	TB [DG]	
318 i	09/87-06/94	M40 B18 (184E1)	1796		0-N954	TB [TE]	
320 i	01/88-12/91	M20 B20 (206KA)	1991		0-N809	TB [TE]	
324 td	01/88-06/93	M21 D24, M21 D24 (246TB)	2443		0-N925	TB [TE]	
325 i, 325 i X	07/87-10/93	M20 B25 (256K1)	2494		0-N809	TB [TE]	

3 (E36)

316 i	09/90-02/98	M40 B16 (164E1), M40 B16, M43 B16 (164E2), M43 B16, M43 B16 (164E2)	1596	21x110		SK-1060	BTK	
318 i	12/90-10/93	M40 B18 (184E1)	1796	21x110		SK-1060	BTK	
316 i	09/90-09/93	M40 B16	1596			0-N866	TB [DG]	
316 i	09/90-09/93	M40 B16 (164E1)	1596			0-N866	TB [DG]	
316 i	09/90-09/93	M40 B16	1596			0-N867	TB [DG]	
316 i	09/90-09/93	M40 B16 (164E1)	1596			0-N867	TB [DG]	
316 i	09/90-09/93	M40 B16 (164E1), M43 B16, M43 B16 (164E2)	1596			0-N955	TB [TE]	
318 i	12/90-10/93	M40 B18 (184E1)	1796			0-N866	TB [DG]	
318 i	12/90-10/93	M40 B18 (184E1)	1796			0-N867	TB [DG]	
318 i	12/90-10/93	M40 B18 (184E1)	1796			0-N955	TB [TE]	
316 i	09/90-09/93	M43 B16	1596			0-N1294	VB [BT]	S
316 i	09/90-02/98	M40 B16, M43 B16 (164E2), M43 B16, M43 B16 (164E2)	1596			0-N1301	VB [TE]	
316 i	07/93-02/98	M40 B16, M43 B16 (164E2)	1596	mechanisch		0-N1294	VB [BT]	S
316 i	07/93-02/98	M40 B16, M43 B16 (164E2)	1596	Generator-Ladestrom [A]: 70; hydraulisch		0-N1298	VB [DG]	
316 i	07/93-02/98	M40 B16, M43 B16 (164E2)	1596			0-N1306	VB [TE]	
316 i	07/93-02/98	M40 B16, M43 B16 (164E2)	1596	hydraulisch; mit Dämpfung		0-N1511	VB [BT]	
316 i	07/93-02/98	M40 B16, M43 B16 (164E2)	1596	hydraulisch		0-N1758	VB [VD]	
318 i	10/93-02/98	M43 B18 (184E2)	1796	mechanisch		0-N1294	VB [BT]	S
318 i	10/93-02/98	M43 B18 (184E2)	1796	Generator-Ladestrom [A]: 70; hydraulisch		0-N1298	VB [DG]	
318 i	10/93-02/98	M43 B18 (184E2)	1796	hydraulisch; mit Dämpfung		0-N1511	VB [BT]	
318 i	10/93-02/98	M43 B18 (184E2)	1796	hydraulisch		0-N1758	VB [VD]	
318 i, 318 is	03/93-02/98	M42 B18 (184S1), M43 B18 (184E2)	1796			0-N1301	VB [TE]	
318 i, 318 is	03/93-02/98	M42 B18 (184S1), M43 B18 (184E2)	1796			0-N1306	VB [TE]	
318 is	03/93-02/98	M42 B18 (184S1)	1796			0-N1298	VB [DG]	
318 is	03/93-02/98	M42 B18 (184S1)	1796	mit Dämpfung		0-N1511	VB [BT]	
318 is	03/93-02/98	M42 B18 (184S1)	1796			0-N1758	VB [VD]	
318 is	09/95-02/98	M44 B19 (194S1), M44 B19 (194S1)	1895			0-N1294	VB [BT]	S
318 is	09/95-02/98	M44 B19 (194S1), M44 B19 (194S1)	1895			0-N1301	VB [TE]	
318 is	09/95-02/98	M44 B19 (194S1), M44 B19 (194S1)	1895			0-N1306	VB [TE]	
318 tds	01/95-02/98	M41 D17 (174T1)	1665			0-N1303	VB [VD]	
318 tds	01/95-02/98	M41 D17 (174T1)	1665			0-N1304	VB [TE]	
318 tds	01/95-02/98	M41 D17 (174T1)	1665			0-N1305	VB [DG]	
318 tds	01/95-02/98	M41 D17 (174T1)	1665	✳		0-N1514	VB [BT]	S
320 i	09/90-02/98	M50 B20, M50 B20 (206S1), M50 B20 (206S1), M50 B20 (206S2), M50 B20 (206S2), M50 B20 TU, M52 B20, M52 B20 (206S3)	1991			0-N1290	VB [BT]	S
320 i	09/90-02/98	M50 B20, M50 B20 (206S1), M50 B20 (206S1), M50 B20 (206S2), M50 B20 (206S2), M50 B20 TU, M52 B20, M52 B20 (206S3)	1991			0-N1293	VB [VD]	
320 i	09/90-02/98	M50 B20, M50 B20 (206S1), M50 B20 (206S1), M50 B20 (206S2), M50 B20 (206S2), M50 B20 TU, M52 B20, M52 B20 (206S3)	1991	hydraulisch		0-N1298	VB [DG]	
320 i	09/90-02/98	M50 B20, M50 B20 (206S1), M50 B20 (206S1), M50 B20 (206S2), M50 B20 (206S2), M50 B20 TU, M52 B20, M52 B20 (206S3)	1991			0-N1301	VB [TE]	
320 i	09/90-02/98	M50 B20, M50 B20 (206S1), M50 B20 (206S1), M50 B20 (206S2), M50 B20 (206S2), M50 B20 TU, M52 B20, M52 B20 (206S3)	1991			0-N1559S	VB [TE]	
320 i	09/90-02/98	M50 B20, M50 B20 (206S1), M50 B20 (206S1), M50 B20 (206S2), M50 B20 (206S2), M50 B20 TU, M52 B20, M52 B20 (206S3)	1991			0-N1919	VB [BT]	S
320 i	09/90-02/98	M50 B20, M50 B20 (206S1), M50 B20 (206S1), M50 B20 (206S2), M50 B20 (206S2), M50 B20 TU, M52 B20, M52 B20 (206S3)	1991			0-N1974	VB [VD]	

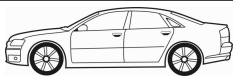

CM³



Art. Nr.



3 (E36)							
320 i	09/90-02/98	M50 B20, M50 B20 (206S1), M50 B20 (206S1), M50 B20 (206S2), M50 B20 (206S2), M50 B20 TU, M52 B20, M52 B20 (206S3)	1991	hydraulisch		0-N2135	VB [BT]
323 i 2.5, 325 i	09/90-02/98	M50 B25 (256S1), M50 B25 (256S1), M50 B25 (256S2), M50 B25 (256S2), M50 B25 TU, M52 B25 (256S3)	2494			0-N1290	VB [BT] S
323 i 2.5, 325 i	09/90-02/98	M50 B25 (256S1), M50 B25 (256S1), M50 B25 (256S2), M50 B25 (256S2), M50 B25 TU, M52 B25 (256S3)	2494			0-N1293	VB [VD]
323 i 2.5, 325 i	09/90-02/98	M50 B25 (256S1), M50 B25 (256S1), M50 B25 (256S2), M50 B25 (256S2), M50 B25 TU, M52 B25 (256S3)	2494	hydraulisch		0-N1298	VB [DG]
323 i 2.5, 325 i	09/90-02/98	M50 B25 (256S1), M50 B25 (256S1), M50 B25 (256S2), M50 B25 (256S2), M50 B25 TU, M52 B25 (256S3)	2494			0-N1301	VB [TE]
323 i 2.5, 325 i	09/90-02/98	M50 B25 (256S1), M50 B25 (256S1), M50 B25 (256S2), M50 B25 (256S2), M50 B25 TU, M52 B25 (256S3)	2494			0-N1559S	VB [TE]
323 i 2.5, 325 i	09/90-02/98	M50 B25 (256S1), M50 B25 (256S1), M50 B25 (256S2), M50 B25 (256S2), M50 B25 TU, M52 B25 (256S3)	2494			0-N1919	VB [BT] S
323 i 2.5, 325 i	09/90-02/98	M50 B25 (256S1), M50 B25 (256S1), M50 B25 (256S2), M50 B25 (256S2), M50 B25 TU, M52 B25 (256S3)	2494			0-N1974	VB [VD]
323 i 2.5, 325 i	09/90-02/98	M50 B25 (256S1), M50 B25 (256S1), M50 B25 (256S2), M50 B25 (256S2), M50 B25 TU, M52 B25 (256S3)	2494	hydraulisch		0-N2135	VB [BT]
325 td	09/91-02/98	M51 D25 (256T1)	2497			0-N1303	VB [VD]
325 td	09/91-02/98	M51 D25 (256T1)	2497			0-N1304	VB [TE]
325 td	09/91-02/98	M51 D25 (256T1)	2497			0-N1305	VB [DG]
325 td	09/91-02/98	M51 D25 (256T1)	2497			0-N1306	VB [TE]
325 tds	05/93-02/98	M51 D25 (256T1)	2503			0-N1303	VB [VD]
325 tds	05/93-02/98	M51 D25 (256T1)	2503			0-N1304	VB [TE]
325 tds	05/93-02/98	M51 D25 (256T1)	2503			0-N1305	VB [DG]
325 tds	05/93-02/98	M51 D25 (256T1)	2503			0-N1306	VB [TE]
328 i	01/95-02/98	M52 B28 (286S1), M52 B28 (286S1), M52 B28 TU	2793			0-N1290	VB [BT] S
328 i	01/95-02/98	M52 B28 (286S1), M52 B28 (286S1), M52 B28 TU	2793			0-N1293	VB [VD]
328 i	01/95-02/98	M52 B28 (286S1), M52 B28 (286S1), M52 B28 TU	2793	hydraulisch		0-N1298	VB [DG]
328 i	01/95-02/98	M52 B28 (286S1), M52 B28 (286S1), M52 B28 TU	2793			0-N1301	VB [TE]
328 i	01/95-02/98	M52 B28 (286S1), M52 B28 (286S1), M52 B28 TU	2793			0-N1559S	VB [TE]
328 i	01/95-02/98	M52 B28 (286S1), M52 B28 (286S1), M52 B28 TU	2793			0-N1919	VB [BT] S
328 i	01/95-02/98	M52 B28 (286S1), M52 B28 (286S1), M52 B28 TU	2793			0-N1974	VB [VD]
328 i	01/95-02/98	M52 B28 (286S1), M52 B28 (286S1), M52 B28 TU	2793	hydraulisch		0-N2135	VB [BT]
M3 3.0	08/94-09/95	S50 B30 (306S1)	2990			0-N1293	VB [VD]
M3 3.0	08/94-09/95	S50 B30 (306S1)	2990			0-N1298	VB [DG]
M3 3.0	08/94-09/95	S50 B30 (306S1)	2990			0-N1301	VB [TE]
M3 3.0	08/94-09/95	S50 B30 (306S1)	2990			0-N1306	VB [TE]
M3 3.0	08/94-09/95	S50 B30 (306S1)	2990			0-N1919	VB [BT] S
M3 3.0	08/94-09/95	S50 B30 (306S1)	2990			0-N2135	VB [BT]
M3 3.2	09/95-02/98	S50 B32 (326S1)	3201			0-N1293	VB [VD]
M3 3.2	09/95-02/98	S50 B32 (326S1)	3201			0-N1298	VB [DG]
M3 3.2	09/95-02/98	S50 B32 (326S1)	3201			0-N1301	VB [TE]
M3 3.2	09/95-02/98	S50 B32 (326S1)	3201			0-N1306	VB [TE]
M3 3.2	09/95-02/98	S50 B32 (326S1)	3201			0-N1919	VB [BT] S
M3 3.2	09/95-02/98	S50 B32 (326S1)	3201			0-N2135	VB [BT]
3 Cabriolet (E36)							
318 i	01/94-04/99	M43 B18 (184E2)	1796	mechanisch		0-N1294	VB [BT] S
318 i	01/94-04/99	M43 B18 (184E2)	1796	Generator-Ladestrom [A]: 70; hydraulisch		0-N1298	VB [DG]
318 i	01/94-04/99	M43 B18 (184E2)	1796			0-N1301	VB [TE]
318 i	01/94-04/99	M43 B18 (184E2)	1796			0-N1306	VB [TE]
318 i	01/94-04/99	M43 B18 (184E2)	1796	hydraulisch; mit Dämpfung		0-N1511	VB [BT]
318 i	01/94-04/99	M43 B18 (184E2)	1796	hydraulisch		0-N1758	VB [VD]



OPTIMAL®

BMW



CM³



Art. Nr.



3 Cabriolet (E36)

320 i	12/93-04/99	M50 B20, M50 B20 (206S2), M50 B20 TU, M52 B20, M52 B20 (206S3)	1991		0-N1290	VB [BT]	S
320 i	12/93-04/99	M50 B20, M50 B20 (206S2), M50 B20 TU, M52 B20, M52 B20 (206S3)	1991		0-N1293	VB [VD]	
320 i	12/93-04/99	M 50	1991		0-N1294	VB [BT]	S
320 i	12/93-04/99	M 52	1991		0-N1294	VB [BT]	S
320 i	12/93-04/99	M50 B20, M50 B20 (206S2), M50 B20 TU, M52 B20, M52 B20 (206S3)	1991	hydraulisch	0-N1298	VB [DG]	
320 i	12/93-04/99	M50 B20, M50 B20 (206S2), M50 B20 TU, M52 B20, M52 B20 (206S3)	1991		0-N1301	VB [TE]	
320 i	12/93-04/99	M50 B20, M50 B20 (206S2), M50 B20 TU, M52 B20, M52 B20 (206S3)	1991		0-N1559S	VB [TE]	
320 i	12/93-04/99	M50 B20, M50 B20 (206S2), M50 B20 TU, M52 B20, M52 B20 (206S3)	1991		0-N1919	VB [BT]	S
320 i	12/93-04/99	M50 B20, M50 B20 (206S2), M50 B20 TU, M52 B20, M52 B20 (206S3)	1991		0-N1974	VB [VD]	
320 i	12/93-04/99	M50 B20, M50 B20 (206S2), M50 B20 TU, M52 B20, M52 B20 (206S3)	1991	hydraulisch	0-N2135	VB [BT]	
323 i, 325 i	03/93-04/99	M50 B25 (256S2), M50 B25 TU, M52 B25 (256S3), M52 B25 (256S3)	2494		0-N1290	VB [BT]	S
323 i, 325 i	03/93-04/99	M50 B25 (256S2), M50 B25 TU, M52 B25 (256S3), M52 B25 (256S3)	2494		0-N1293	VB [VD]	
323 i, 325 i	03/93-04/99	M50 B25 (256S2), M50 B25 TU, M52 B25 (256S3), M52 B25 (256S3)	2494	hydraulisch	0-N1298	VB [DG]	
323 i, 325 i	03/93-04/99	M50 B25 (256S2), M50 B25 TU, M52 B25 (256S3), M52 B25 (256S3)	2494		0-N1301	VB [TE]	
323 i, 325 i	03/93-04/99	M50 B25 (256S2), M50 B25 TU, M52 B25 (256S3), M52 B25 (256S3)	2494		0-N1559S	VB [TE]	
323 i, 325 i	03/93-04/99	M50 B25 (256S2), M50 B25 TU, M52 B25 (256S3), M52 B25 (256S3)	2494		0-N1919	VB [BT]	S
323 i, 325 i	03/93-04/99	M50 B25 (256S2), M50 B25 TU, M52 B25 (256S3), M52 B25 (256S3)	2494		0-N1974	VB [VD]	
323 i, 325 i	03/93-04/99	M50 B25 (256S2), M50 B25 TU, M52 B25 (256S3), M52 B25 (256S3)	2494	hydraulisch	0-N2135	VB [BT]	
328 i	03/95-04/99	M52 B28 (286S1), M52 B28 (286S1), M52 B28 TU	2793		0-N1290	VB [BT]	S
328 i	03/95-04/99	M52 B28 (286S1), M52 B28 (286S1), M52 B28 TU	2793		0-N1293	VB [VD]	
328 i	03/95-04/99	M52 B28 (286S1), M52 B28 (286S1), M52 B28 TU	2793	hydraulisch	0-N1298	VB [DG]	
328 i	03/95-04/99	M52 B28 (286S1), M52 B28 (286S1), M52 B28 TU	2793		0-N1301	VB [TE]	
328 i	03/95-04/99	M52 B28 (286S1), M52 B28 (286S1), M52 B28 TU	2793		0-N1559S	VB [TE]	
328 i	03/95-04/99	M52 B28 (286S1), M52 B28 (286S1), M52 B28 TU	2793		0-N1919	VB [BT]	S
328 i	03/95-04/99	M52 B28 (286S1), M52 B28 (286S1), M52 B28 TU	2793		0-N1974	VB [VD]	
328 i	03/95-04/99	M52 B28 (286S1), M52 B28 (286S1), M52 B28 TU	2793	hydraulisch	0-N2135	VB [BT]	
M3 3.0	01/94-10/95	S50 B30 (306S1)	2990		0-N1293	VB [VD]	
M3 3.0	01/94-10/95	S50 B30 (306S1)	2990		0-N1298	VB [DG]	
M3 3.0	01/94-10/95	S50 B30 (306S1)	2990		0-N1301	VB [TE]	
M3 3.0	01/94-10/95	S50 B30 (306S1)	2990		0-N1306	VB [TE]	
M3 3.0	01/94-10/95	S50 B30 (306S1)	2990		0-N1919	VB [BT]	S
M3 3.0	01/94-10/95	S50 B30 (306S1)	2990		0-N2135	VB [BT]	
M3 3.2	10/95-04/99	S50 B32 (326S1)	3201		0-N1293	VB [VD]	
M3 3.2	10/95-04/99	S50 B32 (326S1)	3201		0-N1298	VB [DG]	
M3 3.2	10/95-04/99	S50 B32 (326S1)	3201		0-N1301	VB [TE]	
M3 3.2	10/95-04/99	S50 B32 (326S1)	3201		0-N1306	VB [TE]	
M3 3.2	10/95-04/99	S50 B32 (326S1)	3201		0-N1919	VB [BT]	S
M3 3.2	10/95-04/99	S50 B32 (326S1)	3201		0-N2135	VB [BT]	

3 Compact (E36)

316 g	03/94-08/00	M43 B16 (164E2)	1596		0-N1294	VB [BT]	S
316 g, 316 i	03/94-08/00	M43 B16 (164E2)	1596		0-N1301	VB [TE]	
316 g, 316 i	03/94-08/00	M43 B16 (164E2)	1596		0-N1306	VB [TE]	
316 i	03/94-08/00	M43 B16 (164E2)	1596	mechanisch	0-N1294	VB [BT]	S
316 i	03/94-08/00	M43 B16 (164E2)	1596	Generator-Ladestrom [A]: 70; hydraulisch	0-N1298	VB [DG]	
316 i	03/94-08/00	M43 B16 (164E2)	1596	hydraulisch; mit Dämpfung	0-N1511	VB [BT]	
316 i	03/94-08/00	M43 B16 (164E2)	1596	hydraulisch	0-N1758	VB [VD]	
316 i, 318 ti	07/95-08/00	M43 B19 (194E1), M44 B19 (194S1), M44 B19 (194S1)	1895		0-N1294	VB [BT]	S



CM³



Art. Nr.



3 Compact (E36)

316 i, 318 ti	07/95-08/00	M43 B19 (194E1), M44 B19 (194S1), M44 B19 (194S1)	1895		0-N1306	VB [TE]	
318 tds	01/95-08/00	M41 D17 (174T1)	1665		0-N1303	VB [VD]	
318 tds	01/95-08/00	M41 D17 (174T1)	1665		0-N1304	VB [TE]	
318 tds	01/95-08/00	M41 D17 (174T1)	1665		0-N1305	VB [DG]	
318 tds	01/95-08/00	M41 D17 (174T1)	1665	☼	0-N1514	VB [BT]	S
318 ti	11/94-08/95	M42 B18 (184S1)	1796		0-N1298	VB [DG]	
318 ti	11/94-08/95	M42 B18 (184S1)	1796		0-N1301	VB [TE]	
318 ti	11/94-08/95	M42 B18 (184S1)	1796		0-N1306	VB [TE]	
318 ti	11/94-08/95	M42 B18 (184S1)	1796	mit Dämpfung	0-N1511	VB [BT]	
318 ti	11/94-08/95	M42 B18 (184S1)	1796		0-N1758	VB [VD]	
318 ti	07/95-08/00	M44 B19 (194S1), M44 B19 (194S1)	1895		0-N1301	VB [TE]	
323 ti	08/97-08/00	M52 B25 (256S3)	2494		0-N1290	VB [BT]	S
323 ti	08/97-08/00	M52 B25 (256S3)	2494		0-N1293	VB [VD]	
323 ti	08/97-08/00	M52 B25 (256S3)	2494	hydraulisch	0-N1298	VB [DG]	
323 ti	08/97-08/00	M52 B25 (256S3)	2494		0-N1301	VB [TE]	
323 ti	08/97-08/00	M52 B25 (256S3)	2494		0-N1559S	VB [TE]	
323 ti	08/97-08/00	M52 B25 (256S3)	2494		0-N1919	VB [BT]	S
323 ti	08/97-08/00	M52 B25 (256S3)	2494		0-N1974	VB [VD]	
323 ti	08/97-08/00	M52 B25 (256S3)	2494	hydraulisch	0-N2135	VB [BT]	

3 Coupe (E36)

316 i	09/93-04/99	M43 B16 (164E2)	1596	mechanisch	0-N1294	VB [BT]	S
316 i	09/93-04/99	M43 B16 (164E2)	1596	Generator-Ladestrom [A]: 70; hydraulisch	0-N1298	VB [DG]	
316 i	09/93-04/99	M43 B16 (164E2)	1596		0-N1301	VB [TE]	
316 i	09/93-04/99	M43 B16 (164E2)	1596		0-N1306	VB [TE]	
316 i	09/93-04/99	M43 B16 (164E2)	1596	hydraulisch; mit Dämpfung	0-N1511	VB [BT]	
316 i	09/93-04/99	M43 B16 (164E2)	1596	hydraulisch	0-N1758	VB [VD]	
318 is	03/92-10/95	M42 B18 (184S1)	1796		0-N1298	VB [DG]	
318 is	03/92-10/95	M42 B18 (184S1)	1796		0-N1301	VB [TE]	
318 is	03/92-10/95	M42 B18 (184S1)	1796		0-N1306	VB [TE]	
318 is	03/92-10/95	M42 B18 (184S1)	1796	mit Dämpfung	0-N1511	VB [BT]	
318 is	03/92-10/95	M42 B18 (184S1)	1796		0-N1758	VB [VD]	
318 is	09/95-04/99	M44 B19 (194S1), M44 B19 (194S1)	1895		0-N1294	VB [BT]	S
318 is	09/95-04/99	M44 B19 (194S1), M44 B19 (194S1)	1895		0-N1301	VB [TE]	
318 is	09/95-04/99	M44 B19 (194S1), M44 B19 (194S1)	1895		0-N1306	VB [TE]	
320 i	03/92-04/99	M50 B20, M50 B20 (206S1), M50 B20 (206S2), M50 B20 TU, M52 B20, M52 B20 (206S3)	1991		0-N1290	VB [BT]	S
320 i	03/92-04/99	M50 B20, M50 B20 (206S1), M50 B20 (206S2), M50 B20 TU, M52 B20, M52 B20 (206S3)	1991		0-N1293	VB [VD]	
320 i	03/92-04/99	M50 B20, M50 B20 (206S1), M50 B20 (206S2), M50 B20 TU, M52 B20, M52 B20 (206S3)	1991	hydraulisch	0-N1298	VB [DG]	
320 i	03/92-04/99	M50 B20, M50 B20 (206S1), M50 B20 (206S2), M50 B20 TU, M52 B20, M52 B20 (206S3)	1991		0-N1301	VB [TE]	
320 i	03/92-04/99	M50 B20, M50 B20 (206S1), M50 B20 (206S2), M50 B20 TU, M52 B20, M52 B20 (206S3)	1991		0-N1559S	VB [TE]	
320 i	03/92-04/99	M50 B20, M50 B20 (206S1), M50 B20 (206S2), M50 B20 TU, M52 B20, M52 B20 (206S3)	1991		0-N1919	VB [BT]	S
320 i	03/92-04/99	M50 B20, M50 B20 (206S1), M50 B20 (206S2), M50 B20 TU, M52 B20, M52 B20 (206S3)	1991		0-N1974	VB [VD]	
320 i	03/92-04/99	M50 B20, M50 B20 (206S1), M50 B20 (206S2), M50 B20 TU, M52 B20, M52 B20 (206S3)	1991	hydraulisch	0-N2135	VB [BT]	
323 i, 325 i	03/92-04/99	M50 B25 (256S1), M50 B25 (256S1), M50 B25 (256S2), M50 B25 (256S2), M50 B25 TU, M52 B25 (256S3), M52 B25 (256S3)	2494		0-N1290	VB [BT]	S
323 i, 325 i	03/92-04/99	M50 B25 (256S1), M50 B25 (256S1), M50 B25 (256S2), M50 B25 (256S2), M50 B25 TU, M52 B25 (256S3), M52 B25 (256S3)	2494		0-N1293	VB [VD]	
323 i, 325 i	03/92-04/99	M50 B25 (256S1), M50 B25 (256S1), M50 B25 (256S2), M50 B25 (256S2), M50 B25 TU, M52 B25 (256S3), M52 B25 (256S3)	2494	hydraulisch	0-N1298	VB [DG]	
323 i, 325 i	03/92-04/99	M50 B25 (256S1), M50 B25 (256S1), M50 B25 (256S2), M50 B25 (256S2), M50 B25 TU, M52 B25 (256S3), M52 B25 (256S3)	2494		0-N1301	VB [TE]	



CM³



Art. Nr.



3 Coupe (E36)

323 i, 325 i	03/92-04/99	M50 B25 (256S1), M50 B25 (256S1), M50 B25 (256S2), M50 B25 (256S2), M50 B25 TU, M52 B25 (256S3), M52 B25 (256S3)	2494		0-N1559S	VB [TE]	
323 i, 325 i	03/92-04/99	M50 B25 (256S1), M50 B25 (256S1), M50 B25 (256S2), M50 B25 (256S2), M50 B25 TU, M52 B25 (256S3), M52 B25 (256S3)	2494		0-N1919	VB [BT]	S
323 i, 325 i	03/92-04/99	M50 B25 (256S1), M50 B25 (256S1), M50 B25 (256S2), M50 B25 (256S2), M50 B25 TU, M52 B25 (256S3), M52 B25 (256S3)	2494		0-N1974	VB [VD]	
323 i, 325 i	03/92-04/99	M50 B25 (256S1), M50 B25 (256S1), M50 B25 (256S2), M50 B25 (256S2), M50 B25 TU, M52 B25 (256S3), M52 B25 (256S3)	2494	hydraulisch	0-N2135	VB [BT]	
328 i	01/95-04/99	M52 B28 (286S1), M52 B28 (286S1), M52 B28 TU	2793		0-N1290	VB [BT]	S
328 i	01/95-04/99	M52 B28 (286S1), M52 B28 (286S1), M52 B28 TU	2793		0-N1293	VB [VD]	
328 i	01/95-04/99	M52 B28 (286S1), M52 B28 (286S1), M52 B28 TU	2793	hydraulisch	0-N1298	VB [DG]	
328 i	01/95-04/99	M52 B28 (286S1), M52 B28 (286S1), M52 B28 TU	2793		0-N1301	VB [TE]	
328 i	01/95-04/99	M52 B28 (286S1), M52 B28 (286S1), M52 B28 TU	2793		0-N1559S	VB [TE]	
328 i	01/95-04/99	M52 B28 (286S1), M52 B28 (286S1), M52 B28 TU	2793		0-N1919	VB [BT]	S
328 i	01/95-04/99	M52 B28 (286S1), M52 B28 (286S1), M52 B28 TU	2793		0-N1974	VB [VD]	
328 i	01/95-04/99	M52 B28 (286S1), M52 B28 (286S1), M52 B28 TU	2793	hydraulisch	0-N2135	VB [BT]	
M3 3.0	10/92-10/95	S50 B30 (306S1)	2990		0-N1293	VB [VD]	
M3 3.0	10/92-10/95	S50 B30 (306S1)	2990		0-N1298	VB [DG]	
M3 3.0	10/92-10/95	S50 B30 (306S1)	2990		0-N1301	VB [TE]	
M3 3.0	10/92-10/95	S50 B30 (306S1)	2990		0-N1306	VB [TE]	
M3 3.0	10/92-10/95	S50 B30 (306S1)	2990		0-N1919	VB [BT]	S
M3 3.0	10/92-10/95	S50 B30 (306S1)	2990		0-N2135	VB [BT]	
M3 3.2	10/95-04/99	S50 B32 (326S1)	3201		0-N1293	VB [VD]	
M3 3.2	10/95-04/99	S50 B32 (326S1)	3201		0-N1298	VB [DG]	
M3 3.2	10/95-04/99	S50 B32 (326S1)	3201		0-N1301	VB [TE]	
M3 3.2	10/95-04/99	S50 B32 (326S1)	3201		0-N1306	VB [TE]	
M3 3.2	10/95-04/99	S50 B32 (326S1)	3201		0-N1919	VB [BT]	S
M3 3.2	10/95-04/99	S50 B32 (326S1)	3201		0-N2135	VB [BT]	

3 Touring (E36)

316 i	01/96-10/99	M43 B16 (164E2)	1596	mechanisch	0-N1294	VB [BT]	S
316 i	01/96-10/99	M43 B16 (164E2)	1596	Generator-Ladestrom [A]: 70; hydraulisch	0-N1298	VB [DG]	
316 i	01/96-10/99	M43 B16 (164E2)	1596		0-N1301	VB [TE]	
316 i	01/96-10/99	M43 B16 (164E2)	1596		0-N1306	VB [TE]	
316 i	01/96-10/99	M43 B16 (164E2)	1596	hydraulisch; mit Dämpfung	0-N1511	VB [BT]	
316 i	01/96-10/99	M43 B16 (164E2)	1596	hydraulisch	0-N1758	VB [VD]	
318 i	07/95-10/99	M43 B18 (184E2)	1796	mechanisch	0-N1294	VB [BT]	S
318 i	07/95-10/99	M43 B18 (184E2)	1796	Generator-Ladestrom [A]: 70; hydraulisch	0-N1298	VB [DG]	
318 i	07/95-10/99	M43 B18 (184E2)	1796		0-N1301	VB [TE]	
318 i	07/95-10/99	M43 B18 (184E2)	1796		0-N1306	VB [TE]	
318 i	07/95-10/99	M43 B18 (184E2)	1796	hydraulisch; mit Dämpfung	0-N1511	VB [BT]	
318 i	07/95-10/99	M43 B18 (184E2)	1796	hydraulisch	0-N1758	VB [VD]	
318 tds	01/95-10/99	M41 D17 (174T1)	1665		0-N1303	VB [VD]	
318 tds	01/95-10/99	M41 D17 (174T1)	1665		0-N1304	VB [TE]	
318 tds	01/95-10/99	M41 D17 (174T1)	1665		0-N1305	VB [DG]	
318 tds	01/95-10/99	M41 D17 (174T1)	1665	⚠	0-N1514	VB [BT]	S
320 i	01/95-10/99	M50 B20, M50 B20 TU, M52 B20, M52 B20 (206S3)	1991		0-N1290	VB [BT]	S
320 i	01/95-10/99	M50 B20, M50 B20 TU, M52 B20, M52 B20 (206S3)	1991		0-N1293	VB [VD]	
320 i	01/95-10/99	M50 B20, M50 B20 TU, M52 B20, M52 B20 (206S3)	1991	hydraulisch	0-N1298	VB [DG]	
320 i	01/95-10/99	M50 B20, M50 B20 TU, M52 B20, M52 B20 (206S3)	1991		0-N1301	VB [TE]	
320 i	01/95-10/99	M50 B20, M50 B20 TU, M52 B20, M52 B20 (206S3)	1991		0-N1559S	VB [TE]	
320 i	01/95-10/99	M50 B20, M50 B20 TU, M52 B20, M52 B20 (206S3)	1991		0-N1919	VB [BT]	S
320 i	01/95-10/99	M50 B20, M50 B20 TU, M52 B20, M52 B20 (206S3)	1991		0-N1974	VB [VD]	



CM³



Art. Nr.



3 Touring (E36)

320 i	01/95-10/99	M50 B20, M50 B20 TU, M52 B20, M52 B20 (206S3)	1991	hydraulisch	0-N2135	VB [BT]	
323 i	09/95-10/99	M52 B25 (256S3)	2494		0-N1290	VB [BT]	S
323 i	09/95-10/99	M52 B25 (256S3)	2494		0-N1293	VB [VD]	
323 i	09/95-10/99	M52 B25 (256S3)	2494	hydraulisch	0-N1298	VB [DG]	
323 i	09/95-10/99	M52 B25 (256S3)	2494		0-N1301	VB [TE]	
323 i	09/95-10/99	M52 B25 (256S3)	2494		0-N1559S	VB [TE]	
323 i	09/95-10/99	M52 B25 (256S3)	2494		0-N1919	VB [BT]	S
323 i	09/95-10/99	M52 B25 (256S3)	2494		0-N1974	VB [VD]	
323 i	09/95-10/99	M52 B25 (256S3)	2494	hydraulisch	0-N2135	VB [BT]	
325 tds	01/95-10/99	M51 D25 (256T1)	2503		0-N1303	VB [VD]	
325 tds	01/95-10/99	M51 D25 (256T1)	2503		0-N1304	VB [TE]	
325 tds	01/95-10/99	M51 D25 (256T1)	2503		0-N1305	VB [DG]	
325 tds	01/95-10/99	M51 D25 (256T1)	2503		0-N1306	VB [TE]	
328 i	01/95-10/99	M52 B28 (286S1), M52 B28 (286S1), M52 B28 TU	2793		0-N1290	VB [BT]	S
328 i	01/95-10/99	M52 B28 (286S1), M52 B28 (286S1), M52 B28 TU	2793		0-N1293	VB [VD]	
328 i	01/95-10/99	M52 B28 (286S1), M52 B28 (286S1), M52 B28 TU	2793	hydraulisch	0-N1298	VB [DG]	
328 i	01/95-10/99	M52 B28 (286S1), M52 B28 (286S1), M52 B28 TU	2793		0-N1301	VB [TE]	
328 i	01/95-10/99	M52 B28 (286S1), M52 B28 (286S1), M52 B28 TU	2793		0-N1559S	VB [TE]	
328 i	01/95-10/99	M52 B28 (286S1), M52 B28 (286S1), M52 B28 TU	2793		0-N1919	VB [BT]	S
328 i	01/95-10/99	M52 B28 (286S1), M52 B28 (286S1), M52 B28 TU	2793		0-N1974	VB [VD]	
328 i	01/95-10/99	M52 B28 (286S1), M52 B28 (286S1), M52 B28 TU	2793	hydraulisch	0-N2135	VB [BT]	

3 (E46)

316 i	04/00-02/05	M43 B16, M43 B16 (164E3)	1596		0-N1291	VB [BT]	S
316 i	04/00-02/05	M43 B16, M43 B16 (164E3)	1596		0-N1292	VB [DG]	
316 i	04/00-02/05	M43 B16, M43 B16 (164E3)	1596		0-N1294	VB [BT]	S
316 i	02/02-02/05	N42 B18 A, N46 B18, N46 B18 A	1796	☼	0-N1505S	VB [DG]	
316 i	02/02-02/05	N42 B18 A, N46 B18, N46 B18 A	1796		0-N1794	VB [BT]	S
316 i	02/02-02/05	N42 B18 A, N46 B18, N46 B18 A	1796	Rippenanzahl: 6	0-N2076	VB [DG]	S
316 i	06/02-02/05	N40 B16 A, N45 B16 A	1596	☼	0-N1505S	VB [DG]	
316 i	06/02-02/05	N40 B16 A, N45 B16 A	1596		0-N1794	VB [BT]	S
316 i, 318 i	02/98-02/05	M43 B19 (194E1), M43 B19 (194E1), M43 B19 TU	1895		0-N1291	VB [BT]	S
316 i, 318 i	02/98-02/05	M43 B19 (194E1), M43 B19 (194E1), M43 B19 TU	1895		0-N1292	VB [DG]	
316 i, 318 i	02/98-02/05	M43 B19 (194E1), M43 B19 (194E1), M43 B19 TU	1895		0-N1294	VB [BT]	S
318 d, 320 d	02/98-04/05	M47 204 D1, M47 D20 (204D1), M47 D20 (204D1), M47 D20, M47 D20 (204D1)	1951		0-N1396	VB [DG]	
318 d, 320 d	02/98-04/05	M47 204 D1, M47 D20 (204D1), M47 D20 (204D1), M47 D20, M47 D20 (204D1)	1951		0-N1913	VB [BT]	S
318 d, 320 d	02/98-04/05	M47 204 D1, M47 D20 (204D1), M47 D20 (204D1), M47 D20, M47 D20 (204D1)	1951		0-N1923	VB [BT]	
318 d, 320 d	02/98-04/05	M47 204 D1, M47 D20 (204D1), M47 D20 (204D1), M47 D20, M47 D20 (204D1)	1951		0-N1932	VB [VD]	
318 d, 320 d	04/98-03/03	M47 204 D1, M47 D20 (204D1), M47 D20, M47 D20 (204D1)	1951		0-N1304	VB [TE]	
318 d, 320 d	09/01-02/05	M47 D20 (204D4)	1995		0-N1523	VB [TE]	
318 d, 320 d	09/01-02/05	M47 D20 (204D4)	1995	→ 09/2004	0-N1524	VB [TE]	
318 d, 320 d	09/01-02/05	M47 D20 (204D4)	1995		0-N1790	VB [BT]	
318 d, 320 d	09/01-02/05	M47 D20 (204D4)	1995		0-N1792	VB [DG]	
318 d, 320 d	09/01-02/05	M47 D20 (204D4)	1995	→ 09/2004	0-N1961	VB [BT]	
318 i	09/01-02/05	N42 B20 A, N46 B20 A	1995	☼	0-N1505S	VB [DG]	
318 i	09/01-02/05	N42 B20 A, N46 B20 A	1995		0-N1794	VB [BT]	S
318 i	09/01-02/05	N42 B20	1995	→ 09/2001; Rippenanzahl: 6	0-N2076	VB [DG]	S
320 d	02/98-04/05	M47 D20 (204D1)	1951		0-N1291	VB [BT]	S
320 d	02/98-04/05	M47 D20 (204D1)	1951		0-N1292	VB [DG]	
320 i	03/98-09/00	M52 B20, M52 B20 (206S4)	1991		0-N1290	VB [BT]	S
320 i	03/98-09/00	M52 B20, M52 B20 (206S4)	1991		0-N1291	VB [BT]	S
320 i	03/98-09/00	M52 B20, M52 B20 (206S4)	1991		0-N1293	VB [VD]	
320 i	03/98-09/00	M52 B20, M52 B20 (206S4)	1991		0-N1298	VB [DG]	



OPTIMAL®

BMW



CM³



Art. Nr.



3 (E46)							
320 i	03/98-09/00	M52 B20, M52 B20 (206S4)	1991		0-N1301	VB [TE]	
320 i	03/98-09/00	M52 B20, M52 B20 (206S4)	1991		0-N1919	VB [BT]	S
320 i	03/98-09/00	M52 B20, M52 B20 (206S4)	1991	hydraulisch	0-N2135	VB [BT]	
320 i	09/00-02/05	M54 B22 (226S1)	2171		0-N1290	VB [BT]	S
320 i	09/00-02/05	M54 B22 (226S1)	2171	→ 09/2002	0-N1291	VB [BT]	S
320 i	09/00-02/05	M54 B22 (226S1)	2171		0-N1293	VB [VD]	
320 i	09/00-02/05	M54 B22 (226S1)	2171		0-N1298	VB [DG]	
320 i	09/00-02/05	M54 B22 (226S1)	2171		0-N1301	VB [TE]	
320 i	09/00-02/05	M54 B22 (226S1)	2171	09/2002 →	0-N1791	VB [BT]	S
320 i	09/00-02/05	M54 B22 (226S1)	2171		0-N1919	VB [BT]	S
320 i	09/00-02/05	M54 B22 (226S1)	2171	hydraulisch	0-N2135	VB [BT]	
323 i	03/98-09/00	M52 B25 (256S4), M52 B25 (256S4), M52 B25 TU	2494		0-N1291	VB [BT]	S
323 i, 325 i, 325 xi	03/98-02/05	M52 B25 (256S4), M52 B25 (256S4), M52 B25 TU, M54 B25 (256S5)	2494		0-N1290	VB [BT]	S
323 i, 325 i, 325 xi	03/98-02/05	M52 B25 (256S4), M52 B25 (256S4), M52 B25 TU, M54 B25 (256S5)	2494		0-N1293	VB [VD]	
323 i, 325 i, 325 xi	03/98-02/05	M52 B25 (256S4), M52 B25 (256S4), M52 B25 TU, M54 B25 (256S5)	2494		0-N1298	VB [DG]	
323 i, 325 i, 325 xi	03/98-02/05	M52 B25 (256S4), M52 B25 (256S4), M52 B25 TU, M54 B25 (256S5)	2494		0-N1301	VB [TE]	
323 i, 325 i, 325 xi	03/98-02/05	M52 B25 (256S4), M52 B25 (256S4), M52 B25 TU, M54 B25 (256S5)	2494		0-N1919	VB [BT]	S
323 i, 325 i, 325 xi	03/98-02/05	M52 B25 (256S4), M52 B25 (256S4), M52 B25 TU, M54 B25 (256S5)	2494	hydraulisch	0-N2135	VB [BT]	
325 i, 325 xi	09/00-02/05	M54 B25 (256S5)	2494	→ 09/2002	0-N1291	VB [BT]	S
325 i, 325 xi	09/00-02/05	M54 B25 (256S5)	2494	09/2002 →	0-N1791	VB [BT]	S
328 i	02/98-06/00	M52 B28 (286S2), M52 B28 (286S2)	2793		0-N1290	VB [BT]	S
328 i	02/98-06/00	M52 B28 (286S2), M52 B28 (286S2)	2793		0-N1291	VB [BT]	S
328 i	02/98-06/00	M52 B28 (286S2), M52 B28 (286S2)	2793		0-N1293	VB [VD]	
328 i	02/98-06/00	M52 B28 (286S2), M52 B28 (286S2)	2793		0-N1298	VB [DG]	
328 i	02/98-06/00	M52 B28 (286S2), M52 B28 (286S2)	2793		0-N1301	VB [TE]	
328 i	02/98-06/00	M52 B28 (286S2), M52 B28 (286S2)	2793		0-N1919	VB [BT]	S
328 i	02/98-06/00	M52 B28 (286S2), M52 B28 (286S2)	2793	hydraulisch	0-N2135	VB [BT]	
330 d	10/99-02/05	M57 D30 (306D1), M57 D30 (306D1)	2926	→ 10/2000	0-N1940	VB [BT]	S
330 d, 330 xd	10/99-02/05	M57 D30 (306D1), M57 D30 (306D1), M57 D30 (306D1)	2926		0-N1396	VB [DG]	
330 d, 330 xd	10/99-02/05	M57 D30 (306D1), M57 D30 (306D1), M57 D30 (306D1)	2926		0-N1834	VB [BT]	S
330 d, 330 xd	10/99-02/05	M57 D30 (306D1), M57 D30 (306D1), M57 D30 (306D1)	2926		0-N1900	VB [BT]	
330 d, 330 xd	10/99-02/05	M57 D30 (306D1), M57 D30 (306D1), M57 D30 (306D1)	2926		0-N1912	VB [BT]	S
330 d, 330 xd	10/99-02/05	M57 D30 (306D1), M57 D30 (306D1), M57 D30 (306D1)	2926		0-N1923	VB [BT]	
330 d, 330 xd	03/03-02/05	M57 D30 (306D2)	2993		0-N1523	VB [TE]	
330 d, 330 xd	03/03-02/05	M57 D30 (306D2)	2993		0-N1790	VB [BT]	
330 d, 330 xd	03/03-02/05	M57 D30 (306D2)	2993		0-N1792	VB [DG]	
330 d, 330 xd	03/03-02/05	M57 D30	2993	→ 09/2004	0-N2074	VB [TE]	S
330 d, 330 xd	03/03-02/05	M57 D30 (306D2)	2993	→ 09/2004	0-N2075	VB [BT]	
330 i, 330 xi	06/00-02/05	M54 B30 (306S3)	2979		0-N1290	VB [BT]	S
330 i, 330 xi	06/00-02/05	M54 B30 (306S3)	2979	→ 09/2002	0-N1291	VB [BT]	S
330 i, 330 xi	06/00-02/05	M54 B30 (306S3)	2979		0-N1293	VB [VD]	
330 i, 330 xi	06/00-02/05	M54 B30 (306S3)	2979		0-N1298	VB [DG]	
330 i, 330 xi	06/00-02/05	M54 B30 (306S3)	2979		0-N1301	VB [TE]	
330 i, 330 xi	06/00-02/05	M54 B30 (306S3)	2979	09/2002 →	0-N1791	VB [BT]	S
330 i, 330 xi	06/00-02/05	M54 B30 (306S3)	2979		0-N1919	VB [BT]	S
330 i, 330 xi	06/00-02/05	M54 B30 (306S3)	2979	hydraulisch	0-N2135	VB [BT]	
3 Cabriolet (E46)							
318 Ci	09/01-12/07	N42 B20 A, N46 B20 A, N46 B20 A, N46 B20 B	1995	☼	0-N1505S	VB [DG]	
318 Ci	09/01-12/07	N42 B20 A, N46 B20 A, N46 B20 A, N46 B20 B	1995		0-N1794	VB [BT]	S
318 Ci	09/01-12/07	N42 B20	1995	→ 09/2001; Rippenanzahl: 6	0-N2076	VB [DG]	S
320 Cd	02/05-12/07	M47 D20 (204D4)	1995		0-N1523	VB [TE]	
320 Cd	02/05-12/07	M47 D20 (204D4)	1995		0-N1524	VB [TE]	
320 Cd	02/05-12/07	M47 D20 (204D4)	1995		0-N1790	VB [BT]	
320 Cd	02/05-12/07	M47 D20 (204D4)	1995		0-N1792	VB [DG]	
320 Cd	02/05-12/07	M47 D20 (204D4)	1995		0-N1961	VB [BT]	



CM³



Art. Nr.



3 Cabriolet (E46)

320 Ci	09/00-12/07	M54 B22 (226S1)	2171		0-N1290	VB [BT]	S
320 Ci	09/00-12/07	M54 B22 (226S1)	2171	→ 09/2002	0-N1291	VB [BT]	S
320 Ci	09/00-12/07	M54 B22 (226S1)	2171		0-N1293	VB [VD]	
320 Ci	09/00-12/07	M54 B22 (226S1)	2171		0-N1298	VB [DG]	
320 Ci	09/00-12/07	M54 B22 (226S1)	2171		0-N1301	VB [TE]	
320 Ci	09/00-12/07	M54 B22 (226S1)	2171	09/2002 →	0-N1791	VB [BT]	S
320 Ci	09/00-12/07	M54 B22 (226S1)	2171		0-N1919	VB [BT]	S
320 Ci	09/00-12/07	M54 B22 (226S1)	2171	hydraulisch	0-N2135	VB [BT]	
323 Ci	04/00-09/00	M52 B25 (256S4)	2494		0-N1291	VB [BT]	S
323 Ci, 325 Ci	04/00-12/07	M52 B25 (256S4), M54 B25 (256S5)	2494		0-N1290	VB [BT]	S
323 Ci, 325 Ci	04/00-12/07	M52 B25 (256S4), M54 B25 (256S5)	2494		0-N1293	VB [VD]	
323 Ci, 325 Ci	04/00-12/07	M52 B25 (256S4), M54 B25 (256S5)	2494		0-N1298	VB [DG]	
323 Ci, 325 Ci	04/00-12/07	M52 B25 (256S4), M54 B25 (256S5)	2494		0-N1301	VB [TE]	
323 Ci, 325 Ci	04/00-12/07	M52 B25 (256S4), M54 B25 (256S5)	2494		0-N1919	VB [BT]	S
323 Ci, 325 Ci	04/00-12/07	M52 B25 (256S4), M54 B25 (256S5)	2494	hydraulisch	0-N2135	VB [BT]	
325 Ci	09/00-12/07	M54 B25 (256S5)	2494	→ 09/2002	0-N1291	VB [BT]	S
325 Ci	09/00-12/07	M54 B25 (256S5)	2494	09/2002 →	0-N1791	VB [BT]	S
330 Cd	08/05-12/07	M57 D30 (306D2)	2993		0-N1523	VB [TE]	
330 Cd	08/05-12/07	M57 D30 (306D2)	2993		0-N1790	VB [BT]	
330 Cd	08/05-12/07	M57 D30 (306D2)	2993		0-N1792	VB [DG]	
330 Ci	06/00-12/07	M54 B30 (306S3)	2979		0-N1290	VB [BT]	S
330 Ci	06/00-12/07	M54 B30 (306S3)	2979	→ 09/2002	0-N1291	VB [BT]	S
330 Ci	06/00-12/07	M54 B30 (306S3)	2979		0-N1293	VB [VD]	
330 Ci	06/00-12/07	M54 B30 (306S3)	2979		0-N1298	VB [DG]	
330 Ci	06/00-12/07	M54 B30 (306S3)	2979		0-N1301	VB [TE]	
330 Ci	06/00-12/07	M54 B30 (306S3)	2979	09/2002 →	0-N1791	VB [BT]	S
330 Ci	06/00-12/07	M54 B30 (306S3)	2979		0-N1919	VB [BT]	S
330 Ci	06/00-12/07	M54 B30 (306S3)	2979	hydraulisch	0-N2135	VB [BT]	
M3 3.2	04/01-12/07	S54 B32 (326S4)	3246		0-N1291	VB [BT]	S
M3 3.2	04/01-12/07	S54 B32 (326S4)	3246		0-N1293	VB [VD]	
M3 3.2	04/01-12/07	S54 B32 (326S4)	3246		0-N1298	VB [DG]	
M3 3.2	04/01-12/07	S54 B32 (326S4)	3246		0-N1301	VB [TE]	
M3 3.2	04/01-12/07	S54 B32 (326S4)	3246		0-N1919	VB [BT]	S
M3 3.2	04/01-12/07	S54 B32 (326S4)	3246		0-N2135	VB [BT]	

3 Compact (E46)

316 ti	06/01-02/05	N42 B18 A, N46 B18 A	1796	☼	0-N1505S	VB [DG]	
316 ti	06/01-02/05	N42 B18 A, N46 B18 A	1796		0-N1794	VB [BT]	S
316 ti	06/01-02/05	N42 B18 A, N46 B18 A	1796	→ 09/2001; Rippenanzahl: 6	0-N2076	VB [DG]	S
316 ti	06/02-02/05	N40	1596	☼	0-N1505S	VB [DG]	
316 ti	06/02-02/05	N40 B16 A	1596	☼	0-N1505S	VB [DG]	
316 ti	06/02-02/05	N40 B16 A, N45 B16 A	1596		0-N1794	VB [BT]	S
318 td, 320 td	09/01-02/05	M47 D20 (204D4)	1995		0-N1523	VB [TE]	
318 td, 320 td	09/01-02/05	M47 D20 (204D4)	1995	→ 09/2004	0-N1524	VB [TE]	
318 td, 320 td	09/01-02/05	M47 D20 (204D4)	1995		0-N1790	VB [BT]	
318 td, 320 td	09/01-02/05	M47 D20 (204D4)	1995		0-N1792	VB [DG]	
318 td, 320 td	09/01-02/05	M47 D20 (204D4)	1995	→ 09/2004	0-N1961	VB [BT]	
318 ti	09/01-02/05	N42 B20 A, N46 B20 A	1995	☼	0-N1505S	VB [DG]	
318 ti	09/01-02/05	N42 B20 A, N46 B20 A	1995		0-N1794	VB [BT]	S
318 ti	09/01-02/05	N42 B20	1995	→ 09/2001; Rippenanzahl: 6	0-N2076	VB [DG]	S
320 td	10/01-12/02	M47 D20 (204D1)	1951		0-N1523	VB [TE]	
325 ti	06/01-02/05	M54 B25 (256S5)	2494		0-N1290	VB [BT]	S
325 ti	06/01-02/05	M54 B25 (256S5)	2494	→ 09/2002	0-N1291	VB [BT]	S
325 ti	06/01-02/05	M54 B25 (256S5)	2494		0-N1293	VB [VD]	
325 ti	06/01-02/05	M54 B25 (256S5)	2494		0-N1298	VB [DG]	
325 ti	06/01-02/05	M54 B25 (256S5)	2494		0-N1301	VB [TE]	
325 ti	06/01-02/05	M54 B25 (256S5)	2494	09/2002 →	0-N1791	VB [BT]	S
325 ti	06/01-02/05	M54 B25 (256S5)	2494		0-N1919	VB [BT]	S
325 ti	06/01-02/05	M54 B25 (256S5)	2494	hydraulisch	0-N2135	VB [BT]	

3 Coupe (E46)

316 Ci	04/00-07/06	M43 B16 (164E3)	1596		0-N1291	VB [BT]	S
316 Ci	04/00-07/06	M43 B16 (164E3)	1596		0-N1292	VB [DG]	
316 Ci	04/00-07/06	M43 B16 (164E3)	1596		0-N1294	VB [BT]	S
316 Ci	06/02-07/06	N45 B16 A	1596	☼	0-N1505S	VB [DG]	
316 Ci	06/02-07/06	N45 B16 A	1596		0-N1794	VB [BT]	S



OPTIMAL®

BMW



CM³



Art. Nr.



3 Coupe (E46)							
318 Ci	11/99-09/01	M43 B19 (194E1)	1895			0-N1291	VB [BT] S
318 Ci	11/99-09/01	M43 B19 (194E1)	1895			0-N1292	VB [DG]
318 Ci	11/99-09/01	M43 B19 (194E1)	1895			0-N1294	VB [BT] S
318 Ci	09/01-07/06	N42 B20 A, N46 B20 A, N46 B20 A	1995	✳		0-N1505S	VB [DG]
318 Ci	09/01-07/06	N42 B20 A, N46 B20 A, N46 B20 A	1995			0-N1794	VB [BT] S
318 Ci	09/01-07/06	N42 B20	1995	→ 09/2001; Rippenanzahl: 6; ✳		0-N2076	VB [DG] S
320 Cd	11/03-07/06	M47 D20 (204D4)	1995			0-N1523	VB [TE]
320 Cd	11/03-07/06	M47 D20 (204D4)	1995	→ 09/2004		0-N1524	VB [TE]
320 Cd	11/03-07/06	M47 D20 (204D4)	1995			0-N1790	VB [BT]
320 Cd	11/03-07/06	M47 D20 (204D4)	1995			0-N1792	VB [DG]
320 Cd	11/03-07/06	M47 D20 (204D4)	1995	→ 09/2004		0-N1961	VB [BT]
320 Ci	08/99-09/00	M52 B20 (206S4)	1991			0-N1290	VB [BT] S
320 Ci	08/99-09/00	M52 B20 (206S4)	1991			0-N1291	VB [BT] S
320 Ci	08/99-09/00	M52 B20 (206S4)	1991			0-N1293	VB [VD]
320 Ci	08/99-09/00	M52 B20 (206S4)	1991			0-N1298	VB [DG]
320 Ci	08/99-09/00	M52 B20 (206S4)	1991			0-N1301	VB [TE]
320 Ci	08/99-09/00	M52 B20 (206S4)	1991			0-N1919	VB [BT] S
320 Ci	08/99-09/00	M52 B20 (206S4)	1991	hydraulisch		0-N2135	VB [BT]
320 Ci	09/00-07/06	M54 B22 (226S1)	2171			0-N1290	VB [BT] S
320 Ci	09/00-07/06	M54 B22 (226S1)	2171	→ 09/2002		0-N1291	VB [BT] S
320 Ci	09/00-07/06	M54 B22 (226S1)	2171			0-N1293	VB [VD]
320 Ci	09/00-07/06	M54 B22 (226S1)	2171			0-N1298	VB [DG]
320 Ci	09/00-07/06	M54 B22 (226S1)	2171			0-N1301	VB [TE]
320 Ci	09/00-07/06	M54 B22 (226S1)	2171	09/2002 →		0-N1791	VB [BT] S
320 Ci	09/00-07/06	M54 B22 (226S1)	2171			0-N1919	VB [BT] S
320 Ci	09/00-07/06	M54 B22 (226S1)	2171	hydraulisch		0-N2135	VB [BT]
323 Ci	04/99-09/00	M52 B25 (256S4)	2494			0-N1291	VB [BT] S
323 Ci, 325 Ci	04/99-07/06	M52 B25 (256S4), M54 B25 (256S5)	2494			0-N1290	VB [BT] S
323 Ci, 325 Ci	04/99-07/06	M52 B25 (256S4), M54 B25 (256S5)	2494			0-N1293	VB [VD]
323 Ci, 325 Ci	04/99-07/06	M52 B25 (256S4), M54 B25 (256S5)	2494			0-N1298	VB [DG]
323 Ci, 325 Ci	04/99-07/06	M52 B25 (256S4), M54 B25 (256S5)	2494			0-N1301	VB [TE]
323 Ci, 325 Ci	04/99-07/06	M52 B25 (256S4), M54 B25 (256S5)	2494			0-N1919	VB [BT] S
323 Ci, 325 Ci	04/99-07/06	M52 B25 (256S4), M54 B25 (256S5)	2494	hydraulisch		0-N2135	VB [BT]
325 Ci	09/00-07/06	M54 B25 (256S5)	2494	→ 09/2002		0-N1291	VB [BT] S
325 Ci	09/00-07/06	M54 B25 (256S5)	2494	09/2002 →		0-N1791	VB [BT] S
328 Ci	04/99-06/00	M52 B28 (286S2), M52 B28 (286S2)	2793			0-N1290	VB [BT] S
328 Ci	04/99-06/00	M52 B28 (286S2), M52 B28 (286S2)	2793			0-N1291	VB [BT] S
328 Ci	04/99-06/00	M52 B28 (286S2), M52 B28 (286S2)	2793			0-N1293	VB [VD]
328 Ci	04/99-06/00	M52 B28 (286S2), M52 B28 (286S2)	2793			0-N1298	VB [DG]
328 Ci	04/99-06/00	M52 B28 (286S2), M52 B28 (286S2)	2793			0-N1301	VB [TE]
328 Ci	04/99-06/00	M52 B28 (286S2), M52 B28 (286S2)	2793			0-N1919	VB [BT] S
328 Ci	04/99-06/00	M52 B28 (286S2), M52 B28 (286S2)	2793	hydraulisch		0-N2135	VB [BT]
330 Cd	03/03-07/06	M57 D30 (306D2)	2993			0-N1523	VB [TE]
330 Cd	03/03-07/06	M57 D30 (306D2)	2993			0-N1790	VB [BT]
330 Cd	03/03-07/06	M57 D30 (306D2)	2993			0-N1792	VB [DG]
330 Cd	03/03-07/06	M57 D30 (306D2)	2993	→ 09/2004		0-N2074	VB [TE] S
330 Cd	03/03-07/06	M57 D30 (306D2)	2993	→ 09/2004		0-N2075	VB [BT]
330 Ci, 330 xi	06/00-07/06	M54 B30 (306S3)	2979			0-N1290	VB [BT] S
330 Ci, 330 xi	06/00-07/06	M54 B30 (306S3)	2979	→ 09/2002		0-N1291	VB [BT] S
330 Ci, 330 xi	06/00-07/06	M54 B30 (306S3)	2979			0-N1293	VB [VD]
330 Ci, 330 xi	06/00-07/06	M54 B30 (306S3)	2979			0-N1298	VB [DG]
330 Ci, 330 xi	06/00-07/06	M54 B30 (306S3)	2979			0-N1301	VB [TE]
330 Ci, 330 xi	06/00-07/06	M54 B30 (306S3)	2979	09/2002 →		0-N1791	VB [BT] S
330 Ci, 330 xi	06/00-07/06	M54 B30 (306S3)	2979			0-N1919	VB [BT] S
330 Ci, 330 xi	06/00-07/06	M54 B30 (306S3)	2979	hydraulisch		0-N2135	VB [BT]
M3 3.2, M3 CSL	06/00-07/06	S54 B32 (326S4), S54 B32, S54 B32 (326S4)	3246			0-N1291	VB [BT] S
M3 3.2, M3 CSL	06/00-07/06	S54 B32 (326S4), S54 B32, S54 B32 (326S4)	3246			0-N1293	VB [VD]
M3 3.2, M3 CSL	06/00-07/06	S54 B32 (326S4), S54 B32, S54 B32 (326S4)	3246			0-N1298	VB [DG]
M3 3.2, M3 CSL	06/00-07/06	S54 B32 (326S4), S54 B32, S54 B32 (326S4)	3246			0-N1301	VB [TE]
M3 3.2, M3 CSL	06/00-07/06	S54 B32 (326S4), S54 B32, S54 B32 (326S4)	3246			0-N1919	VB [BT] S
M3 3.2, M3 CSL	06/00-07/06	S54 B32 (326S4), S54 B32, S54 B32 (326S4)	3246			0-N2135	VB [BT]



CM³



Art. Nr.



3 Touring (E46)

316 i	03/02-02/05	N42 B18 A, N46 B18, N46 B18 A	1796	✳		0-N1505S	VB [DG]	
316 i	03/02-02/05	N42 B18 A, N46 B18, N46 B18 A	1796			0-N1794	VB [BT]	S
316 i	06/02-02/05	N45 B16, N45 B16 A	1596	✳		0-N1505S	VB [DG]	
316 i	06/02-02/05	N45 B16, N45 B16 A	1596			0-N1794	VB [BT]	S
318 d, 320 d	03/00-02/05	M47 204 D1, M47 D20 (204D1), M47 D20, M47 D20 (204D1)	1951			0-N1304	VB [TE]	
318 d, 320 d	03/00-02/05	M47 204 D1, M47 D20 (204D1), M47 D20, M47 D20 (204D1)	1951			0-N1396	VB [DG]	
318 d, 320 d	03/00-02/05	M47 204 D1, M47 D20 (204D1), M47 D20, M47 D20 (204D1)	1951			0-N1913	VB [BT]	S
318 d, 320 d	03/00-02/05	M47 204 D1, M47 D20 (204D1), M47 D20, M47 D20 (204D1)	1951			0-N1923	VB [BT]	
318 d, 320 d	03/00-02/05	M47 204 D1, M47 D20 (204D1), M47 D20, M47 D20 (204D1)	1951			0-N1932	VB [VD]	
318 d, 320 d	09/01-02/05	M47 D20 (204D4)	1995			0-N1523	VB [TE]	
318 d, 320 d	09/01-02/05	M47 D20 (204D4)	1995	→ 09/2004		0-N1524	VB [TE]	
318 d, 320 d	09/01-02/05	M47 D20 (204D4)	1995			0-N1790	VB [BT]	
318 d, 320 d	09/01-02/05	M47 D20 (204D4)	1995			0-N1792	VB [DG]	
318 d, 320 d	09/01-02/05	M47 D20 (204D4)	1995	→ 09/2004		0-N1961	VB [BT]	
318 i	10/99-09/01	M43 B19 (194E1), M43 B19 (194E1), M43 B19 TU	1895			0-N1291	VB [BT]	S
318 i	10/99-09/01	M43 B19 (194E1), M43 B19 (194E1), M43 B19 TU	1895			0-N1292	VB [DG]	
318 i	10/99-09/01	M43 B19 (194E1), M43 B19 (194E1), M43 B19 TU	1895			0-N1294	VB [BT]	S
318 i	10/99-09/01	M43 B19 (194E1)	1895			0-N1794	VB [BT]	S
318 i	09/01-02/05	N42 B20 A, N46 B20, N46 B20 A	1995	✳		0-N1505S	VB [DG]	
318 i	09/01-02/05	N42 B20 A, N46 B20, N46 B20 A	1995			0-N1794	VB [BT]	S
318 i	09/01-02/05	N42 B20	1995	→ 09/2001; Rippenanzahl: 6		0-N2076	VB [DG]	S
320 i	10/99-09/00	M52 B20, M52 B20 (206S4)	1991			0-N1290	VB [BT]	S
320 i	10/99-09/00	M52 B20, M52 B20 (206S4)	1991			0-N1291	VB [BT]	S
320 i	10/99-09/00	M52 B20, M52 B20 (206S4)	1991			0-N1293	VB [VD]	
320 i	10/99-09/00	M52 B20, M52 B20 (206S4)	1991			0-N1298	VB [DG]	
320 i	10/99-09/00	M52 B20, M52 B20 (206S4)	1991			0-N1301	VB [TE]	
320 i	10/99-09/00	M52 B20, M52 B20 (206S4)	1991			0-N1919	VB [BT]	S
320 i	10/99-09/00	M52 B20, M52 B20 (206S4)	1991	hydraulisch		0-N2135	VB [BT]	
320 i	09/00-02/05	M54 B22 (226S1)	2171			0-N1290	VB [BT]	S
320 i	09/00-02/05	M54 B22 (226S1)	2171	→ 09/2002		0-N1291	VB [BT]	S
320 i	09/00-02/05	M54 B22 (226S1)	2171			0-N1293	VB [VD]	
320 i	09/00-02/05	M54 B22 (226S1)	2171			0-N1298	VB [DG]	
320 i	09/00-02/05	M54 B22 (226S1)	2171			0-N1301	VB [TE]	
320 i	09/00-02/05	M54 B22 (226S1)	2171	09/2002 →		0-N1791	VB [BT]	S
320 i	09/00-02/05	M54 B22 (226S1)	2171			0-N1919	VB [BT]	S
320 i	09/00-02/05	M54 B22 (226S1)	2171	hydraulisch		0-N2135	VB [BT]	
325 i, 325 xi	09/00-02/05	M54 B25 (256S5)	2494			0-N1290	VB [BT]	S
325 i, 325 xi	09/00-02/05	M54 B25 (256S5)	2494	→ 09/2002		0-N1291	VB [BT]	S
325 i, 325 xi	09/00-02/05	M54 B25 (256S5)	2494			0-N1293	VB [VD]	
325 i, 325 xi	09/00-02/05	M54 B25 (256S5)	2494			0-N1298	VB [DG]	
325 i, 325 xi	09/00-02/05	M54 B25 (256S5)	2494			0-N1301	VB [TE]	
325 i, 325 xi	09/00-02/05	M54 B25 (256S5)	2494	09/2002 →		0-N1791	VB [BT]	S
325 i, 325 xi	09/00-02/05	M54 B25 (256S5)	2494			0-N1919	VB [BT]	S
325 i, 325 xi	09/00-02/05	M54 B25 (256S5)	2494	hydraulisch		0-N2135	VB [BT]	
328 i	10/99-06/00	M52 B28 (286S2), M52 B28 (286S2)	2793			0-N1290	VB [BT]	S
328 i	10/99-06/00	M52 B28 (286S2), M52 B28 (286S2)	2793			0-N1291	VB [BT]	S
328 i	10/99-06/00	M52 B28 (286S2), M52 B28 (286S2)	2793			0-N1293	VB [VD]	
328 i	10/99-06/00	M52 B28 (286S2), M52 B28 (286S2)	2793			0-N1298	VB [DG]	
328 i	10/99-06/00	M52 B28 (286S2), M52 B28 (286S2)	2793			0-N1301	VB [TE]	
328 i	10/99-06/00	M52 B28 (286S2), M52 B28 (286S2)	2793			0-N1919	VB [BT]	S
328 i	10/99-06/00	M52 B28 (286S2), M52 B28 (286S2)	2793	hydraulisch		0-N2135	VB [BT]	
330 d	10/99-02/05	M57 D30 (306D1), M57 D30 (306D1)	2926	→ 10/2000		0-N1940	VB [BT]	S
330 d, 330 xd	10/99-02/05	M57 D30 (306D1), M57 D30 (306D1), M57 D30 (306D1)	2926			0-N1396	VB [DG]	
330 d, 330 xd	10/99-02/05	M57 D30 (306D1), M57 D30 (306D1), M57 D30 (306D1)	2926			0-N1834	VB [BT]	S
330 d, 330 xd	10/99-02/05	M57 D30 (306D1), M57 D30 (306D1), M57 D30 (306D1)	2926			0-N1900	VB [BT]	
330 d, 330 xd	10/99-02/05	M57 D30 (306D1), M57 D30 (306D1), M57 D30 (306D1)	2926			0-N1912	VB [BT]	S



CM³



Art. Nr.



3 Touring (E46)

330 d, 330 xd	10/99-02/05	M57 D30 (306D1), M57 D30 (306D1), M57 D30 (306D1)	2926		0-N1923	VB [BT]	
330 d, 330 xd	03/03-02/05	M57 D30 (306D2)	2993		0-N1523	VB [TE]	
330 d, 330 xd	03/03-02/05	M57 D30 (306D2)	2993		0-N1790	VB [BT]	
330 d, 330 xd	03/03-02/05	M57 D30 (306D2)	2993		0-N1792	VB [DG]	
330 d, 330 xd	03/03-02/05	M57 D30 (306D2)	2993	→ 09/2004	0-N2074	VB [TE]	S
330 d, 330 xd	03/03-02/05	M57 D30 (306D2)	2993	→ 09/2004	0-N2075	VB [BT]	
330 i, 330 xi	06/00-02/05	M54 B30 (306S3)	2979		0-N1290	VB [BT]	S
330 i, 330 xi	06/00-02/05	M54 B30 (306S3)	2979	→ 09/2002	0-N1291	VB [BT]	S
330 i, 330 xi	06/00-02/05	M54 B30 (306S3)	2979		0-N1293	VB [VD]	
330 i, 330 xi	06/00-02/05	M54 B30 (306S3)	2979		0-N1298	VB [DG]	
330 i, 330 xi	06/00-02/05	M54 B30 (306S3)	2979		0-N1301	VB [TE]	
330 i, 330 xi	06/00-02/05	M54 B30 (306S3)	2979	09/2002 →	0-N1791	VB [BT]	S
330 i, 330 xi	06/00-02/05	M54 B30 (306S3)	2979		0-N1919	VB [BT]	S
330 i, 330 xi	06/00-02/05	M54 B30 (306S3)	2979	hydraulisch	0-N2135	VB [BT]	

3 (E90)

316 d	07/09-12/11	N47N	1995	02/2010 →; für Fahrzeuge mit elektrischer Servolenkung	0-N2216	VB [BT]	
316 d	07/09-12/11	N47N	1995	02/2010 →; für Fahrzeuge mit elektrischer Servolenkung	0-N2216S1	VB [DG]	
316 d	07/09-12/11	N47N	1995	02/2010 →; für Fahrzeuge mit elektrischer Servolenkung	0-N2216S2	VB [DG]	
316 d	07/09-12/11	N47N	1995	02/2010 →	0-N2217	VB [BT]	
316 d	07/09-12/11	N47N	1995	02/2010 →	0-N2217S1	VB [DG]	
316 d	07/09-12/11	N47N	1995	02/2010 →	0-N2217S2	VB [DG]	
316 d, 318 d, 320 d, 320 d xDrive	07/07-12/11	N47 D20 C	1995	für Fahrzeuge mit elektrischer Servolenkung	0-N2130	VB [DG]	
316 d, 318 d, 320 d, 320 d xDrive, 320 xd	09/05-12/11	N47 D20 A, N47 D20 C, N47 D20 C	1995		0-N1950	VB [DG]	
316 d, 318 d, 320 d, 320 d xDrive, 320 xd	09/05-12/11	N47 D20 A, N47 D20 C, N47 D20 C	1995		0-N1958	VB [BT]	S
316 i	02/06-12/11	N45 B16, N45 B16 A, N45 B16 TU2	1596	⊛	0-N1505S	VB [DG]	
316 i	02/06-12/11	N45 B16, N45 B16 A, N45 B16 TU2	1596		0-N1794	VB [BT]	S
316 i	09/07-12/11	N43 B16 A	1599	für Fahrzeuge ohne Aktivlenkung	0-N2031	VB [BT]	S
316 i	09/07-12/11	N43 B16 A	1599		0-N2130	VB [DG]	
318 d	09/05-12/11	N47N	1995	12/2009 →; für Fahrzeuge mit elektrischer Servolenkung	0-N2216	VB [BT]	
318 d	09/05-12/11	N47N	1995	12/2009 →; für Fahrzeuge mit elektrischer Servolenkung	0-N2216S1	VB [DG]	
318 d	09/05-12/11	N47N	1995	12/2009 →; für Fahrzeuge mit elektrischer Servolenkung	0-N2216S2	VB [DG]	
318 d	09/05-12/11	N47N	1995	12/2009 →	0-N2217	VB [BT]	
318 d	09/05-12/11	N47N	1995	12/2009 →	0-N2217S1	VB [DG]	
318 d	09/05-12/11	N47N	1995	12/2009 →	0-N2217S2	VB [DG]	
318 d, 320 d	01/05-12/11	M47 D20 (204D4), M47 D20 (204D4), N47 D20 C	1995		0-N1793	VB [BT]	S
318 d, 320 d	01/05-12/11	M47 D20 (204D4), M47 D20 (204D4), N47 D20 C	1995		0-N1871	VB [DG]	
318 d, 320 d	09/05-12/11	N47 D20 A, N47 D20 C	1995	für Fahrzeuge mit elektrischer Servolenkung, ⊛	0-N2130	VB [DG]	
318 i	09/07-12/11	N46	1995	⊛	0-N1505S	VB [DG]	
318 i	09/07-12/11	N46	1995		0-N1794	VB [BT]	S
318 i	09/07-12/11	N43	1995		0-N2031	VB [BT]	S
318 i	09/07-12/11	N43	1995	⊛	0-N2130	VB [DG]	
318 i, 320 i	01/05-03/07	N46 B20 A, N46 B20 B, N46 B20 C, N46 B20, N46 B20 B	1995	⊛	0-N1505S	VB [DG]	
318 i, 320 i	01/05-03/07	N46 B20 A, N46 B20 B, N46 B20 C, N46 B20, N46 B20 B	1995		0-N1794	VB [BT]	S
320 d	01/05-12/11	N47 D20 C	1995		0-N1950	VB [DG]	
320 d	01/05-12/11	N47 D20 C	1995		0-N1958	VB [BT]	S
320 d	01/05-12/11	N47 D20 C	1995	für Fahrzeuge mit elektrischer Servolenkung	0-N2130	VB [DG]	
320 d	01/05-12/11	N47N	1995	09/2009 →	0-N2216	VB [BT]	
320 d	01/05-12/11	N47N	1995	09/2009 →	0-N2216S1	VB [DG]	
320 d	01/05-12/11	N47N	1995	09/2009 →	0-N2216S2	VB [DG]	
320 d	01/05-12/11	N47N	1995	09/2009 →	0-N2217	VB [BT]	
320 d	01/05-12/11	N47N	1995	09/2009 →	0-N2217S1	VB [DG]	
320 d	01/05-12/11	N47N	1995	09/2009 →	0-N2217S2	VB [DG]	
320 d	01/10-12/11	N47N	1995		0-N2217	VB [BT]	
320 d	01/10-12/11	N47N	1995		0-N2217S1	VB [DG]	
320 d	01/10-12/11	N47N	1995		0-N2217S2	VB [DG]	



CM³



Art. Nr.



3 (E90)							
320 d xDrive, 320 xd	09/07-12/11	N47N	1995	09/2009 →; für Fahrzeuge mit elektrischer Servolenkung	0-N2216	VB [BT]	
320 d xDrive, 320 xd	09/07-12/11	N47N	1995	09/2009 →; für Fahrzeuge mit elektrischer Servolenkung	0-N2216S1	VB [DG]	
320 d xDrive, 320 xd	09/07-12/11	N47N	1995	09/2009 →; für Fahrzeuge mit elektrischer Servolenkung	0-N2216S2	VB [DG]	
320 d xDrive, 320 xd	09/07-12/11	N47N	1995	02/2009 →	0-N2217	VB [BT]	
320 d xDrive, 320 xd	09/07-12/11	N47N	1995	02/2009 →	0-N2217S1	VB [DG]	
320 d xDrive, 320 xd	09/07-12/11	N47N	1995	02/2009 →	0-N2217S2	VB [DG]	
320 d, 320 d xDrive	09/07-12/11	N47N	1995	02/2009 →; für Fahrzeuge mit elektrischer Servolenkung	0-N2216	VB [BT]	
320 d, 320 d xDrive	09/07-12/11	N47N	1995	02/2009 →; für Fahrzeuge mit elektrischer Servolenkung	0-N2216S1	VB [DG]	
320 d, 320 d xDrive	09/07-12/11	N47N	1995	02/2009 →; für Fahrzeuge mit elektrischer Servolenkung	0-N2216S2	VB [DG]	
320 d, 320 d xDrive	01/10-12/11	N47N	1995	für Fahrzeuge mit elektrischer Servolenkung	0-N2216	VB [BT]	
320 d, 320 d xDrive	01/10-12/11	N47N	1995	für Fahrzeuge mit elektrischer Servolenkung	0-N2216S1	VB [DG]	
320 d, 320 d xDrive	01/10-12/11	N47N	1995	für Fahrzeuge mit elektrischer Servolenkung	0-N2216S2	VB [DG]	
320 i	03/07-12/11	N43 B20 A, N46 B20 B, N46 B20 C, N46 B20 CC, N46 B20 CD, N46 B20 E	1995	für Fahrzeuge ohne Aktivlenkung	0-N2031	VB [BT]	S
320 i	03/07-12/11	N46 B20 B, N46 B20 C, N46 B20 CC, N46 B20 CD, N46 B20 E	1995		0-N2130	VB [DG]	
320 i	03/07-12/11	N43 B20 A, N46 B20 B, N46 B20 C, N46 B20 CC, N46 B20 CD, N46 B20 E	1995	für Fahrzeuge mit Aktivlenkung	0-N2212	VB [BT]	S
320 i	09/07-12/11	N43 B20 A	1995	✳	0-N2130	VB [DG]	
320 si	05/06-12/11	N45 B20 A	1997	✳	0-N1505S	VB [DG]	
320 si	05/06-12/11	N45 B20 A	1997		0-N1794	VB [BT]	S
323 i, 325 i, 325 xi	01/05-12/11	N52 B25 A, N52 B25 A, N52N B25 A, N52 B25, N52 B25 A	2497		0-N1788	VB [BT]	S
323 i, 325 i, 325 xi	01/05-12/11	N52 B25 A, N52 B25 A, N52N B25 A, N52 B25, N52 B25 A	2497		0-N2128	VB [DG]	
325 d, 330 d xDrive	01/09-12/11	N57 D30 A	2993		0-N1950	VB [DG]	
325 d, 330 d xDrive	01/09-12/11	N57 D30 A	2993		0-N1958	VB [BT]	S
325 d, 330 d xDrive	01/09-12/11	N57 D30 A	2993	für Fahrzeuge mit elektrischer Servolenkung	0-N2130	VB [DG]	
325 d, 330 d, 330 xd	09/05-12/11	M57 D30 (306D3), M57 D30 (306D3), M57 D30 TU2, M57N2 306 D3, N57 D30 A	2993		0-N1793	VB [BT]	S
325 d, 330 d, 330 xd, 335 d	09/05-12/11	M57 D30 (306D3), M57 D30 (306D3), M57 D30 TU2, M57 D30 (306D5)	2993		0-N1871	VB [DG]	
325 i xDrive	09/08-12/11	N53	2996		0-N1788	VB [BT]	S
325 i, 325 i xDrive, 325 xi, 328 i, 330 i, 330 i xDrive, 330 xi	01/05-12/11	N52 B30 A, N52 B30 A, N52 B30 B, N52 B30 BF, N52 B30 A, N53 B30 A, N52N B30 A, N53 B30 A, N53 B30, N53 B30 A	2996		0-N2128	VB [DG]	
325 i, 325 xi, 328 i, 330 i, 330 i xDrive, 330 xi	01/05-12/11	N52 B30 A, N52 B30 A, N53 B30 A, N52N B30 A, N53 B30 A, N53 B30, N53 B30 A	2996		0-N1788	VB [BT]	S
330 d	01/09-12/11	M57N2 306D3	2993		0-N1871	VB [DG]	
330 d	01/09-12/11	N57 D30 A	2993		0-N1950	VB [DG]	
330 d	01/09-12/11	N57 D30 A	2993		0-N1958	VB [BT]	S
330 d	01/09-12/11	N57 D30 A	2993	für Fahrzeuge mit elektrischer Servolenkung	0-N2130	VB [DG]	
335 d	09/06-12/11	M57 D30 (306D5)	2993		0-N1523	VB [TE]	
335 d	09/06-12/11	M57 D30 (306D5)	2993		0-N1790	VB [BT]	
335 i	10/06-12/11	N54	2979		0-N2129	VB [DG]	
335 i, 335 i xDrive	10/06-12/11	N54	2979		0-N2130	VB [DG]	
335 i, 335 i xDrive, 335 xi	09/06-12/11	N54	2979		0-N1621	VB [BT]	S
335 i, 335 i xDrive, 335 xi	09/06-12/11	N54 B30 A, N55 B30 A	2979		0-N2129	VB [DG]	
335 i, 335 i xDrive, 335 xi	09/06-12/11	N55	2979		0-N2372	VB [DG]	
335 i, 335 i xDrive, 335 xi	09/06-12/11	N55	2979		0-N2373	VB [DG]	
335 i, 335 xi	09/06-12/11	N54 B30 A, N55 B30 A	2979		0-N2130	VB [DG]	
335 xi, 335i	09/07-12/11	N54 B30 A	2979		0-N1621	VB [BT]	S
M3 4.0	03/07-12/11	S65 B40 A	3999		0-N1298	VB [DG]	
3 Cabriolet (E93)							
318 i, 320 d	01/10-12/13	N43 B20 A, N47 D20 C	1995		0-N2130	VB [DG]	
320 d	03/07-12/13	N47 D20 A, N47 D20 C, N47 D20 C	1995		0-N1950	VB [DG]	
320 d	03/07-12/13	N47 D20 A, N47 D20 C, N47 D20 C	1995		0-N1958	VB [BT]	S
320 d	03/07-12/13	N47 D20 A, N47 D20 C	1995	für Fahrzeuge mit elektrischer Servolenkung, ✳	0-N2130	VB [DG]	
320 d	03/07-12/13	N47N	1995	07/2009 →; für Fahrzeuge mit elektrischer Servolenkung	0-N2216	VB [BT]	
320 d	03/07-12/13	N47N	1995	07/2009 →; für Fahrzeuge mit elektrischer Servolenkung	0-N2216S1	VB [DG]	



CM³



Art. Nr.



3 Cabriolet (E93)

320 d	03/07-12/13	N47N	1995	07/2009 →; für Fahrzeuge mit elektrischer Servolenkung	0-N2216S2	VB [DG]	
320 d	01/08-12/13	N47 D20 C	1995	→ 02/2010	0-N1950	VB [DG]	
320 d	01/08-12/13	N47 D20 C	1995	→ 02/2010	0-N1958	VB [BT]	S
320 d	01/10-12/13	N47 D20 C	1995	für Fahrzeuge mit elektrischer Servolenkung	0-N2216	VB [BT]	
320 d	01/10-12/13	N47 D20 C	1995	für Fahrzeuge mit elektrischer Servolenkung	0-N2216S1	VB [DG]	
320 d	01/10-12/13	N47 D20 C	1995	für Fahrzeuge mit elektrischer Servolenkung	0-N2216S2	VB [DG]	
320 d	01/10-12/13	N47 D20 C	1995		0-N2217	VB [BT]	
320 d	01/10-12/13	N47 D20 C	1995		0-N2217S1	VB [DG]	
320 d	01/10-12/13	N47 D20 C	1995		0-N2217S2	VB [DG]	
320 i	03/07-08/07	N46 B20, N46 B20 A	1995	⊛	0-N1505S	VB [DG]	
320 i	03/07-12/13	N46	1995		0-N1794	VB [BT]	S
320 i	03/07-12/13	N43 B20 A	1995	für Fahrzeuge ohne Aktivlenkung	0-N2031	VB [BT]	S
320 i	03/07-12/13	N43	1995	⊛	0-N2130	VB [DG]	
320 i	03/07-12/13	N43 B20 A	1995	für Fahrzeuge mit Aktivlenkung	0-N2212	VB [BT]	S
320 i	03/07-12/13	N46 B20 B, N46 B20 B	1995	für Fahrzeuge mit Niveauregulierung	0-N2212	VB [BT]	S
323 i, 325 i	03/07-12/13	N52 B25, N52 B25 A, N52N B25 A	2497		0-N1788	VB [BT]	S
323 i, 325 i	03/07-12/13	N52 B25, N52 B25 A, N52N B25 A	2497		0-N2128	VB [DG]	
325 d	03/07-12/13	N57	2993		0-N1950	VB [DG]	
325 d	03/07-12/13	N57	2993		0-N1958	VB [BT]	S
325 d	03/07-12/13	N57	2993	für Fahrzeuge mit elektrischer Servolenkung, ⊛	0-N2130	VB [DG]	
325 d, 330 d	03/07-12/13	M57	2993		0-N1793	VB [BT]	S
325 d, 330 d	03/07-12/13	M57	2993		0-N1871	VB [DG]	
325 d, 330 d	01/09-12/13	N57 D30 A	2993		0-N1950	VB [DG]	
325 d, 330 d	01/09-12/13	N57 D30 A	2993		0-N1958	VB [BT]	S
325 d, 330 d	01/09-12/13	N57 D30 A	2993	für Fahrzeuge mit elektrischer Servolenkung	0-N2130	VB [DG]	
325 i, 330 i	03/07-12/13	N51 B30 A, N51 B30 A, N53 B30 A, N52 B30 A, N52N B30 B, N52 B30 A, N53 B30 A	2996		0-N1788	VB [BT]	S
325 i, 330 i	03/07-12/13	N51 B30 A, N51 B30 A, N53 B30 A, N52 B30 A, N52N B30 B, N52 B30 A, N53 B30 A	2996		0-N2128	VB [DG]	
330 d	03/07-12/13	M57 D30 (306D3)	2993		0-N1950	VB [DG]	
330 d	03/07-12/13	M57 D30 (306D3)	2993		0-N1958	VB [BT]	S
330 d	03/07-12/13	M57 D30 (306D3)	2993	für Fahrzeuge mit elektrischer Servolenkung, ⊛	0-N2130	VB [DG]	
330 d	01/09-12/13	M57N2 306 D3, N57 D30 A	2993		0-N1793	VB [BT]	S
330 d	01/09-12/13	M57N2 306D3	2993		0-N1871	VB [DG]	
335 i	03/07-12/13	N54	2979		0-N1621	VB [BT]	S
335 i	03/07-12/13	N54 B30 A, N54 B30 B, N55 B30 A	2979		0-N2129	VB [DG]	
335 i	03/07-12/13	N54 B30 A, N54 B30 B, N55 B30 A	2979		0-N2130	VB [DG]	
335 i	03/07-12/13	N55	2979		0-N2372	VB [DG]	
335 i	03/07-12/13	N55	2979		0-N2373	VB [DG]	

3 Coupe (E92)

316 i	09/07-12/13	N43 B16 A	1599		0-N2130	VB [DG]	
318 i, 320 d, 320 d xDrive	01/10-12/13	N43 B20 A, N47 D20 C	1995		0-N2130	VB [DG]	
320 d	01/07-12/13	N47	1995	→ 02/2010	0-N1950	VB [DG]	
320 d	01/07-12/13	N47	1995	→ 02/2010	0-N1958	VB [BT]	S
320 d	01/10-12/13	N47 D20 C	1995	für Fahrzeuge mit elektrischer Servolenkung	0-N2216	VB [BT]	
320 d	01/10-12/13	N47 D20 C	1995	für Fahrzeuge mit elektrischer Servolenkung	0-N2216S1	VB [DG]	
320 d	01/10-12/13	N47 D20 C	1995	für Fahrzeuge mit elektrischer Servolenkung	0-N2216S2	VB [DG]	
320 d	01/10-12/13	N47 D20 C	1995		0-N2217	VB [BT]	
320 d	01/10-12/13	N47 D20 C	1995		0-N2217S1	VB [DG]	
320 d	01/10-12/13	N47 D20 C	1995		0-N2217S2	VB [DG]	
320 d xDrive	01/10-12/13	N47N	1995	für Fahrzeuge mit elektrischer Servolenkung	0-N2216	VB [BT]	
320 d xDrive	01/10-12/13	N47N	1995	für Fahrzeuge mit elektrischer Servolenkung	0-N2216S1	VB [DG]	
320 d xDrive	01/10-12/13	N47N	1995	für Fahrzeuge mit elektrischer Servolenkung	0-N2216S2	VB [DG]	
320 d, 320 d xDrive, 320 xd	01/07-12/13	N47N	1995	07/2009 →; für Fahrzeuge mit elektrischer Servolenkung	0-N2216	VB [BT]	
320 d, 320 d xDrive, 320 xd	01/07-12/13	N47N	1995	07/2009 →; für Fahrzeuge mit elektrischer Servolenkung	0-N2216S1	VB [DG]	
320 d, 320 d xDrive, 320 xd	01/07-12/13	N47N	1995	07/2009 →; für Fahrzeuge mit elektrischer Servolenkung	0-N2216S2	VB [DG]	
320 d, 320 d xDrive, 320 xd	03/07-12/13	N47 D20 A, N47 D20 C	1995		0-N1950	VB [DG]	
320 d, 320 d xDrive, 320 xd	03/07-12/13	N47 D20 A, N47 D20 C	1995		0-N1958	VB [BT]	S
320 d, 320 xd	03/07-12/13	N47 D20 A	1995	für Fahrzeuge mit elektrischer Servolenkung, ⊛	0-N2130	VB [DG]	
320 i	11/06-06/07	N46 B20 A, N46 B20 A	1995	⊛	0-N1505S	VB [DG]	



CM³



Art. Nr.



3 Coupe (E92)

320 i	11/06-06/07	N46 B20 A, N46 B20 A	1995		0-N1794	VB [BT]	S
320 i	01/07-12/13	N43 B20 A, N46 B20 B, N46 B20 B	1995	für Fahrzeuge mit Aktivlenkung	0-N2212	VB [BT]	S
320 i	03/07-12/13	N43 B20 A	1995	für Fahrzeuge ohne Aktivlenkung	0-N2031	VB [BT]	S
320 i	03/07-12/13	N43 B20 A	1995	☼	0-N2130	VB [DG]	
320 i	06/07-12/13	N43 B20 A	1995		0-N2130	VB [DG]	
323 i, 325 i, 325 xi	06/06-12/13	N52 B25 A, N52 B25 A, N52N B25 A	2497		0-N1788	VB [BT]	S
323 i, 325 i, 325 xi	06/06-12/13	N52 B25 A, N52 B25 A, N52N B25 A	2497		0-N2128	VB [DG]	
325 d	03/07-12/13	M57	2993		0-N1793	VB [BT]	S
325 d	03/07-12/13	M57	2993		0-N1871	VB [DG]	
325 d	03/07-12/13	M57 D30 (306D3)	2993	für Fahrzeuge mit elektrischer Servolenkung, ☼	0-N2130	VB [DG]	
325 d, 330 d xDrive	03/07-12/13	M57 D30 (306D3), N57 D30 A	2993		0-N1950	VB [DG]	
325 d, 330 d xDrive	03/07-12/13	M57 D30 (306D3), N57 D30 A	2993		0-N1958	VB [BT]	S
325 d, 330 d, 330 xd X	01/09-12/13	M57N2 306D3	2993		0-N1871	VB [DG]	
325 d, 330 d, 330 xd X	01/09-12/13	N57 D30 A	2993		0-N1950	VB [DG]	
325 d, 330 d, 330 xd X	01/09-12/13	N57 D30 A	2993		0-N1958	VB [BT]	S
325 d, 330 d, 330 xd X	01/09-12/13	N57 D30 A	2993	für Fahrzeuge mit elektrischer Servolenkung	0-N2130	VB [DG]	
325 d, 330 d, 330 xd, 330 xd X	09/06-12/13	M57 D30 (306D3), M57 D30 TU2, M57N2 306 D3, N57 D30 A	2993		0-N1793	VB [BT]	S
325 i, 325 i xDrive, 325 xi, 328 i, 330 i, 330 i xDrive, 330 xi	08/06-12/13	N51 B30 A, N51 B30 A, N53 B30 A, N51 B30 A, N53 B30 A, N52 B30 A, N52 B30 A, N52 B30 AF, N52 B30 B, N52 B30 BF, N52 B30 A, N53 B30 A, N52N B30 A, N53 B30 A	2996		0-N1788	VB [BT]	S
325 i, 325 i xDrive, 325 xi, 328 i, 330 i, 330 i xDrive, 330 xi	08/06-12/13	N51 B30 A, N51 B30 A, N53 B30 A, N51 B30 A, N53 B30 A, N52 B30 A, N52 B30 A, N52 B30 AF, N52 B30 B, N52 B30 BF, N52 B30 A, N53 B30 A, N52N B30 A, N53 B30 A	2996		0-N2128	VB [DG]	
330 d xDrive	01/09-12/13	N57 D30 A	2993	für Fahrzeuge mit elektrischer Servolenkung	0-N2130	VB [DG]	
330 d, 330 xd, 335 d	09/06-12/13	M57 D30 (306D3), M57 D30 TU2, M57 D30 (306D5)	2993		0-N1871	VB [DG]	
335 d	09/06-12/13	M57 D30 (306D5)	2993		0-N1523	VB [TE]	
335 d	09/06-12/13	M57 D30 (306D5)	2993		0-N1790	VB [BT]	
335 i, 335 i xDrive, 335 xi	09/06-12/13	N54	2979		0-N1621	VB [BT]	S
335 i, 335 i xDrive, 335 xi	09/06-12/13	N54 B30 A, N55 B30 A	2979		0-N2129	VB [DG]	
335 i, 335 i xDrive, 335 xi	09/06-12/13	N54 B30 A, N55 B30 A	2979		0-N2130	VB [DG]	
335 i, 335 i xDrive, 335 xi	09/06-12/13	N55	2979		0-N2372	VB [DG]	
335 i, 335 i xDrive, 335 xi	09/06-12/13	N55	2979		0-N2373	VB [DG]	

3 Touring (E91)

316 d, 320 d, 320 d xDrive	09/09-06/12	N47 D20 C	1995	für Fahrzeuge mit elektrischer Servolenkung	0-N2216	VB [BT]	
316 d, 320 d, 320 d xDrive	09/09-06/12	N47 D20 C	1995	für Fahrzeuge mit elektrischer Servolenkung	0-N2216S1	VB [DG]	
316 d, 320 d, 320 d xDrive	09/09-06/12	N47 D20 C	1995	für Fahrzeuge mit elektrischer Servolenkung	0-N2216S2	VB [DG]	
316 d, 320 d, 320 d xDrive	09/09-06/12	N47 D20 C	1995		0-N2217	VB [BT]	
316 d, 320 d, 320 d xDrive	09/09-06/12	N47 D20 C	1995		0-N2217S1	VB [DG]	
316 d, 320 d, 320 d xDrive	09/09-06/12	N47 D20 C	1995		0-N2217S2	VB [DG]	
316 i	05/08-05/12	N43 B16 A	1599	für Fahrzeuge ohne Aktivlenkung	0-N2031	VB [BT]	S
316 i	05/08-05/12	N43 B16 A	1599		0-N2130	VB [DG]	
318 d	09/05-06/12	M47 D20 (204D4)	1995		0-N1871	VB [DG]	
318 d	07/07-06/12	N47N	1995	12/2009 →; für Fahrzeuge mit elektrischer Servolenkung	0-N2216	VB [BT]	
318 d	07/07-06/12	N47N	1995	12/2009 →; für Fahrzeuge mit elektrischer Servolenkung	0-N2216S1	VB [DG]	
318 d	07/07-06/12	N47N	1995	12/2009 →; für Fahrzeuge mit elektrischer Servolenkung	0-N2216S2	VB [DG]	
318 d	07/07-06/12	N47N	1995	12/2009 →	0-N2217	VB [BT]	
318 d	07/07-06/12	N47N	1995	12/2009 →	0-N2217S1	VB [DG]	
318 d	07/07-06/12	N47N	1995	12/2009 →	0-N2217S2	VB [DG]	
318 d, 320 d	09/05-06/12	M47 D20 (204D4)	1995		0-N1793	VB [BT]	S
318 d, 320 d	09/07-06/12	N47 D20 A, N47 D20 C	1995	für Fahrzeuge mit elektrischer Servolenkung, ☼	0-N2130	VB [DG]	
318 d, 320 d xDrive	07/07-06/12	N47 D20 C	1995	für Fahrzeuge mit elektrischer Servolenkung	0-N2130	VB [DG]	
318 d, 320 d, 320 d xDrive, 320 xd, 320d xDrive	07/07-06/12	N47 D20 A, N47 D20 A, N47 D20 C, N47 D20 C	1995		0-N1950	VB [DG]	
318 d, 320 d, 320 d xDrive, 320 xd, 320d xDrive	07/07-06/12	N47 D20 A, N47 D20 A, N47 D20 C, N47 D20 C	1995		0-N1958	VB [BT]	S
318 i	09/07-06/12	N46	1995	☼	0-N1505S	VB [DG]	
318 i	09/07-06/12	N46 B20	1995		0-N1794	VB [BT]	S
318 i	09/07-06/12	N43	1995	für Fahrzeuge ohne Aktivlenkung	0-N2031	VB [BT]	S
318 i	09/07-06/12	N43	1995	☼	0-N2130	VB [DG]	



OPTIMAL®

BMW



CM³



Art. Nr.



3 Touring (E91)							
318 i, 320 i	09/05-06/12	N46 B20, N46 B20 A, N46 B20 C, N46 B20, N46 B20 B	1995	☼		0-N1505S	VB [DG]
318 i, 320 i	09/05-06/12	N46 B20, N46 B20 A, N46 B20 C, N46 B20, N46 B20 B	1995			0-N1794	VB [BT] S
320 d	09/05-06/12	M47N	1995			0-N1793	VB [BT] S
320 d	09/05-06/12	M47N	1995			0-N1871	VB [DG]
320 d	09/05-06/12	N47	1995			0-N1950	VB [DG]
320 d	09/05-06/12	N47	1995			0-N1958	VB [BT] S
320 d	09/05-06/12	N47	1995		für Fahrzeuge mit elektrischer Servolenkung, ☼	0-N2130	VB [DG]
320 d, 320 d xDrive, 320 xd, 320d xDrive	09/05-06/12	N47N	1995		09/2009 →; für Fahrzeuge mit elektrischer Servolenkung	0-N2216	VB [BT]
320 d, 320 d xDrive, 320 xd, 320d xDrive	09/05-06/12	N47N	1995		09/2009 →; für Fahrzeuge mit elektrischer Servolenkung	0-N2216S1	VB [DG]
320 d, 320 d xDrive, 320 xd, 320d xDrive	09/05-06/12	N47N	1995		09/2009 →; für Fahrzeuge mit elektrischer Servolenkung	0-N2216S2	VB [DG]
320 i	09/07-06/12	N43 B20 A	1995		für Fahrzeuge ohne Aktivlenkung	0-N2031	VB [BT] S
320 i	09/07-06/12	N43 B20 A	1995	☼		0-N2130	VB [DG]
320 i	09/07-06/12	N43 B20 A	1995		für Fahrzeuge mit Aktivlenkung	0-N2212	VB [BT] S
323 i, 325 i, 325 xi	09/05-06/12	N52 B25 A, N52 B25 A, N52 B25, N52 B25 A, N52 B25 A	2497			0-N1788	VB [BT] S
323 i, 325 i, 325 xi	09/05-06/12	N52 B25 A, N52 B25 A, N52 B25, N52 B25 A, N52 B25 A	2497			0-N2128	VB [DG]
325 d, 330 d, 330 xd	09/05-06/12	M57 D30 (306D3), M57 D30 (306D3), M57 D30 TU2, M57N2 306 D3, N57 D30 A, N57 D30 A	2993			0-N1793	VB [BT] S
325 d, 330 d, 330 xd	01/09-06/12	M57N2 306D3	2993			0-N1871	VB [DG]
325 d, 330 d, 330 xd	01/09-06/12	N57 D30 A	2993			0-N1950	VB [DG]
325 d, 330 d, 330 xd	01/09-06/12	N57 D30 A	2993			0-N1958	VB [BT] S
325 d, 330 d, 330 xd	01/09-06/12	N57 D30 A	2993		für Fahrzeuge mit elektrischer Servolenkung	0-N2130	VB [DG]
325 d, 330 d, 330 xd, 335 d	09/05-06/12	M57 D30 (306D3), M57 D30 (306D3), M57 D30 TU2, M57 D30 (306D5)	2993			0-N1871	VB [DG]
325 i, 325 i xDrive, 325 xi, 330 i, 330 i xDrive, 330 xi	09/05-06/12	N51 B30 A, N53 B30 A, N52 B30 A, N52 B30, N52 B30 A, N53 B30 A, N53 B30 A, N53 B30 A, N53 B30 A	2996			0-N1788	VB [BT] S
325 i, 325 i xDrive, 325 xi, 330 i, 330 i xDrive, 330 xi	09/05-06/12	N51 B30 A, N53 B30 A, N52 B30 A, N52 B30, N52 B30 A, N53 B30 A, N53 B30 A, N53 B30 A	2996			0-N2128	VB [DG]
335 d	09/06-06/12	M57 D30 (306D5)	2993			0-N1523	VB [TE]
335 d	09/06-06/12	M57 D30 (306D5)	2993			0-N1790	VB [BT]
335 i, 335 i xDrive, 335 xi	09/06-06/12	N54	2979			0-N1621	VB [BT] S
335 i, 335 i xDrive, 335 xi	09/06-06/12	N54 B30 A, N55 B30 A	2979			0-N2129	VB [DG]
335 i, 335 i xDrive, 335 xi	09/06-06/12	N54 B30 A, N55 B30 A	2979			0-N2130	VB [DG]
335 i, 335 i xDrive, 335 xi	09/06-06/12	N55	2979			0-N2372	VB [DG]
335 i, 335 i xDrive, 335 xi	09/06-06/12	N55	2979			0-N2373	VB [DG]
3 (F30, F35, F80)							
316 d, 318 d, 318d xDrive, 320 d, 320 d xDrive, 325d	10/11-07/15	B47 D20 A, N47 D20 C, N47 D20 C, N47 D20 D	1995			0-N2216	VB [BT]
316 d, 318 d, 318d xDrive, 320 d, 320 d xDrive, 325d	10/11-07/15	B47 D20 A, N47 D20 C, N47 D20 C, N47 D20 D	1995			0-N2216S1	VB [DG]
316 d, 318 d, 318d xDrive, 320 d, 320 d xDrive, 325d	10/11-07/15	B47 D20 A, N47 D20 C, N47 D20 C, N47 D20 D	1995			0-N2216S2	VB [DG]
316 i, 320i	02/12-	N13 B16 A	1598			0-N2215	VB [BT] S
316 i, 320i	02/12-	N13 B16 A	1598		für OE: 11 28 7 598 832, 11 28 7 598 833	0-N2237	VB [DG]
330d, 330d xDrive, 335 d xDrive	01/12-	N57 D30 A, N57 D30 B	2993			0-N2216	VB [BT]
330d, 330d xDrive, 335 d xDrive	01/12-	N57 D30 A, N57 D30 B	2993			0-N2216S1	VB [DG]
330d, 330d xDrive, 335 d xDrive	01/12-	N57 D30 A, N57 D30 B	2993			0-N2216S2	VB [DG]
335 i, 335 i xDrive, ActiveHybrid, M3	10/11-07/13	N55 B30 A, S55 B30 A	2979			0-N2370	VB [DG]
3 Touring (F31)							
316 d, 318 d, 318d xDrive, 320 d, 320 d xDrive, 320d, 320d xDrive, 325d	10/11-07/15	B47 D20 A, N47 D20 C, N47 D20 C, N47 D20 D	1995			0-N2216	VB [BT]
316 d, 318 d, 318d xDrive, 320 d, 320 d xDrive, 320d, 320d xDrive, 325d	10/11-07/15	B47 D20 A, N47 D20 C, N47 D20 C, N47 D20 D	1995			0-N2216S1	VB [DG]
316 d, 318 d, 318d xDrive, 320 d, 320 d xDrive, 320d, 320d xDrive, 325d	10/11-07/15	B47 D20 A, N47 D20 C, N47 D20 C, N47 D20 D	1995			0-N2216S2	VB [DG]
316i	03/13-	N13 B16 A	1598			0-N2215	VB [BT] S
316i	03/13-	N13 B16 A	1598		für OE: 11 28 7 598 832, 11 28 7 598 833	0-N2237	VB [DG]
330 d, 330d xDrive, 335 d xDrive	06/12-	N57 D30 A, N57 D30 B	2993			0-N2216	VB [BT]
330 d, 330d xDrive, 335 d xDrive	06/12-	N57 D30 A, N57 D30 B	2993			0-N2216S1	VB [DG]
330 d, 330d xDrive, 335 d xDrive	06/12-	N57 D30 A, N57 D30 B	2993			0-N2216S2	VB [DG]



CM³



Art. Nr.



3 Touring (F31)							
335i, 335i xDrive, 335i, 335i xDrive	01/12-07/13	N55 B30 A	2979			0-N2370	VB [DG]
323I [USA] Touring							
323i	01/00-12/00		2494			0-N1291	VB [BT] S
323i	01/00-12/00		2494			0-N1292	VB [DG]
325CI [USA] Cabriolet							
325 Ci	01/01-12/06		2494			0-N1291	VB [BT] S
325 Ci	01/01-12/06		2494			0-N1292	VB [DG]
325CI [USA] Coupe							
325 Ci	01/01-12/06		2494			0-N1291	VB [BT] S
325 Ci	01/01-12/06		2494			0-N1292	VB [DG]
325I [USA] Touring							
325i	01/01-12/05		2494			0-N1291	VB [BT] S
325i	01/01-12/05		2494			0-N1292	VB [DG]
3 GRAN TURISMO (F34)							
318 d, 320 d, 320 d xDrive, 320d xDrive, 325 d, 325d	03/13-07/15	N47 D20 C, N47 D20 D	1995			0-N2216	VB [BT]
318 d, 320 d, 320 d xDrive, 320d xDrive, 325 d, 325d	03/13-07/15	N47 D20 C, N47 D20 D	1995			0-N2216S1	VB [DG]
318 d, 320 d, 320 d xDrive, 320d xDrive, 325 d, 325d	03/13-07/15	N47 D20 C, N47 D20 D	1995			0-N2216S2	VB [DG]
330 d, 330 d xDrive, 335 d xDrive	01/14-	N57 D30 A, N57 D30 B	2993			0-N2216	VB [BT]
330 d, 330 d xDrive, 335 d xDrive	01/14-	N57 D30 A, N57 D30 B	2993			0-N2216S1	VB [DG]
330 d, 330 d xDrive, 335 d xDrive	01/14-	N57 D30 A, N57 D30 B	2993			0-N2216S2	VB [DG]
335i, 335i xDrive, 335i xDrive	03/13-03/14	N55 B30 A	2979			0-N2370	VB [DG]
4 Coupe (F32, F82)							
420 d, 420 d xDrive, 425 d	07/13-03/15	N47 D20 C, N47 D20 D	1995			0-N2216	VB [BT]
420 d, 420 d xDrive, 425 d	07/13-03/15	N47 D20 C, N47 D20 D	1995			0-N2216S1	VB [DG]
420 d, 420 d xDrive, 425 d	07/13-03/15	N47 D20 C, N47 D20 D	1995			0-N2216S2	VB [DG]
430 d, 430 d xDrive, 435 d xDrive	11/13-	N57 D30 A, N57 D30 B	2993			0-N2216	VB [BT]
430 d, 430 d xDrive, 435 d xDrive	11/13-	N57 D30 A, N57 D30 B	2993			0-N2216S1	VB [DG]
430 d, 430 d xDrive, 435 d xDrive	11/13-	N57 D30 A, N57 D30 B	2993			0-N2216S2	VB [DG]
435i, 435i xDrive, M4	07/13-	N54 B30 A, N55 B30 A, N55 B30 A, S55 B30 A	2979			0-N2370	VB [DG]
4 Cabriolet (F33, F83)							
420 d, 425 d	10/13-07/15	N47 D20 C, N47 D20 D	1995			0-N2216	VB [BT]
420 d, 425 d	10/13-07/15	N47 D20 C, N47 D20 D	1995			0-N2216S1	VB [DG]
420 d, 425 d	10/13-07/15	N47 D20 C, N47 D20 D	1995			0-N2216S2	VB [DG]
430 d, 435 d xDrive	07/14-	N57 D30 A, N57 D30 B	2993			0-N2216	VB [BT]
430 d, 435 d xDrive	07/14-	N57 D30 A, N57 D30 B	2993			0-N2216S1	VB [DG]
430 d, 435 d xDrive	07/14-	N57 D30 A, N57 D30 B	2993			0-N2216S2	VB [DG]
435i, 435i xDrive	10/13-	N55 B30 A	2979			0-N2370	VB [DG]
4 Gran Coupe (F36)							
418 d, 420 d, 420 d xDrive	03/14-03/15	N47 D20 C	1995			0-N2216	VB [BT]
418 d, 420 d, 420 d xDrive	03/14-03/15	N47 D20 C	1995			0-N2216S1	VB [DG]
418 d, 420 d, 420 d xDrive	03/14-03/15	N47 D20 C	1995			0-N2216S2	VB [DG]
430 d, 430 d xDrive, 435 d xDrive	07/14-	N57 D30 A, N57 D30 B	2993			0-N2216	VB [BT]
430 d, 430 d xDrive, 435 d xDrive	07/14-	N57 D30 A, N57 D30 B	2993			0-N2216S1	VB [DG]
430 d, 430 d xDrive, 435 d xDrive	07/14-	N57 D30 A, N57 D30 B	2993			0-N2216S2	VB [DG]
435i, 435i xDrive	03/14-	N55 B30 A	2979			0-N2370	VB [DG]
5 (E12)							
520/6	09/77-05/81	M20 B20 (206VA)	1990			0-N809	TB [TE]
5 (E28)							
524 d, 524 td	09/83-12/87	M21 D24 (246DA), M21 D24, M21 D24 (246TA), M21 D24 (246TA)	2443	28.5x138		SK-1064	BTK
520i	06/81-12/87	M20 B20 (206EA), M20 B20 (206KA)	1990			0-N809	TB [TE]
524 d, 524 td	09/83-12/87	M21 D24 (246DA), M21 D24, M21 D24 (246TA), M21 D24 (246TA)	2443			0-N925	TB [TE]
525e	09/81-12/87	M20 B27 (276EA), M20 B27 (276EB), M20 B27 (276KA), M20 B27 (276KB), M20 B27 (276KB)	2693			0-N809	TB [TE]
5 (E34)							
518i	08/89-09/95	M40 B18 (184E1)	1796	21x110; → 09/1991		SK-1059	BTK
518i	08/89-09/95	M40 B18 (184E1)	1796	21x110; 10/1991 →		SK-1060	BTK



OPTIMAL®

BMW



CM³



Art. Nr.



ohne Halter

5 (E34)

524 td	03/88-09/95	M21 D24, M21 D24 (246TB)	2443	28.5x138	SK-1064	BTK	
518 i	08/89-09/95	M40 B18 (184E1)	1796		0-N866	TB [DG]	
518 i	08/89-09/95	M40 B18 (184E1)	1796		0-N867	TB [DG]	
518 i	08/89-09/95	M40 B18 (184E1)	1796		0-N955	TB [TE]	
520 i	01/88-08/91	M20 B20 (206KA)	1990		0-N809	TB [TE]	
524 td	03/88-09/95	M21 D24, M21 D24 (246TB)	2443		0-N925	TB [TE]	
525 i	01/88-08/91	M20 B25 (256K1), M20 B25 (256K1)	2494		0-N809	TB [TE]	
518 i	08/89-09/95	M43 B18 (184E2)	1796		0-N1301	VB [TE]	
518 i	08/89-09/95	M43 B18 (184E2)	1796		0-N1306	VB [TE]	
518 i	08/89-09/95	M43 B18 (184E2)	1796	hydraulisch; mit Dämpfung	0-N1511	VB [BT]	
518 i	08/89-09/95	M43 B18 (184E2)	1796	hydraulisch	0-N1758	VB [VD]	
520 i 24V	09/89-09/95	M50 B20, M50 B20 (206S1), M50 B20 (206S2), M50 B20 TU	1991		0-N1290	VB [BT]	S
520 i 24V	09/89-09/95	M50 B20, M50 B20 (206S1), M50 B20 (206S2), M50 B20 TU	1991		0-N1293	VB [VD]	
520 i 24V	09/89-09/95	M50 B20, M50 B20 (206S1), M50 B20 (206S2), M50 B20 TU	1991	hydraulisch	0-N1298	VB [DG]	
520 i 24V	09/89-09/95	M50 B20, M50 B20 (206S1), M50 B20 (206S2), M50 B20 TU	1991		0-N1301	VB [TE]	
520 i 24V	09/89-09/95	M50 B20, M50 B20 (206S1), M50 B20 (206S2), M50 B20 TU	1991		0-N1559S	VB [TE]	
520 i 24V	09/89-09/95	M50 B20, M50 B20 (206S1), M50 B20 (206S2), M50 B20 TU	1991		0-N1919	VB [BT]	S
520 i 24V	09/89-09/95	M50 B20, M50 B20 (206S1), M50 B20 (206S2), M50 B20 TU	1991		0-N1974	VB [VD]	
520 i 24V	09/89-09/95	M50 B20, M50 B20 (206S1), M50 B20 (206S2), M50 B20 TU	1991	hydraulisch	0-N2135	VB [BT]	
525 i 24V, 525 iX 24V	09/89-09/95	M50 B25 (256S1), M50 B25 (256S2), M50 B25 (256S2), M50 B25 (256S2), M50 B25 TU, M52 B25 (Vanos)	2494		0-N1290	VB [BT]	S
525 i 24V, 525 iX 24V	09/89-09/95	M50 B25 (256S1), M50 B25 (256S2), M50 B25 (256S2), M50 B25 (256S2), M50 B25 TU, M52 B25 (Vanos)	2494		0-N1293	VB [VD]	
525 i 24V, 525 iX 24V	09/89-09/95	M50 B25 (256S1), M50 B25 (256S2), M50 B25 (256S2), M50 B25 (256S2), M50 B25 TU, M52 B25 (Vanos)	2494	hydraulisch	0-N1298	VB [DG]	
525 i 24V, 525 iX 24V	09/89-09/95	M50 B25 (256S1), M50 B25 (256S2), M50 B25 (256S2), M50 B25 (256S2), M50 B25 TU, M52 B25 (Vanos)	2494		0-N1301	VB [TE]	
525 i 24V, 525 iX 24V	09/89-09/95	M50 B25 (256S1), M50 B25 (256S2), M50 B25 (256S2), M50 B25 (256S2), M50 B25 TU, M52 B25 (Vanos)	2494		0-N1559S	VB [TE]	
525 i 24V, 525 iX 24V	09/89-09/95	M50 B25 (256S1), M50 B25 (256S2), M50 B25 (256S2), M50 B25 (256S2), M50 B25 TU, M52 B25 (Vanos)	2494		0-N1919	VB [BT]	S
525 i 24V, 525 iX 24V	09/89-09/95	M50 B25 (256S1), M50 B25 (256S2), M50 B25 (256S2), M50 B25 (256S2), M50 B25 TU, M52 B25 (Vanos)	2494		0-N1974	VB [VD]	
525 i 24V, 525 iX 24V	09/89-09/95	M50 B25 (256S1), M50 B25 (256S2), M50 B25 (256S2), M50 B25 (256S2), M50 B25 TU, M52 B25 (Vanos)	2494	hydraulisch	0-N2135	VB [BT]	
525 td	04/93-09/95	M51 D25 (256T1)	2497		0-N1303	VB [VD]	
525 td	04/93-09/95	M51 D25 (256T1)	2497		0-N1304	VB [TE]	
525 td	04/93-09/95	M51 D25 (256T1)	2497		0-N1305	VB [DG]	
525 td	04/93-09/95	M51 D25 (256T1)	2497		0-N1306	VB [TE]	
525 tds	09/91-09/95	M51 D25 (256T1)	2503		0-N1303	VB [VD]	
525 tds	09/91-09/95	M51 D25 (256T1)	2503		0-N1304	VB [TE]	
525 tds	09/91-09/95	M51 D25 (256T1)	2503		0-N1305	VB [DG]	
525 tds	09/91-09/95	M51 D25 (256T1)	2503		0-N1306	VB [TE]	
530 i	01/88-08/91	M30 B30 (306KA)	2986		0-N1297	VB [DG]	
530 i V8	09/92-09/95	M60 B30 (308S1), M60 B30 (308S1)	2997		0-N1296	VB [TE]	
530 i V8	09/92-09/95	M60 B30 (308S1), M60 B30 (308S1)	2997		0-N1297	VB [DG]	
530 i V8	09/92-09/95	M60 B30 (308S1), M60 B30 (308S1)	2997		0-N1585	VB [TE]	S
530 i V8	09/92-09/95	M60 B30 (308S1), M60 B30 (308S1)	2997		0-N2140	VB [TE]	
530 i V8	09/92-09/95	M60 B30 (308S1), M60 B30 (308S1)	2997		0-N2411	VB [VD]	
540 i V8	09/92-09/95	M60 B40 (408S1), M60 B40 (408S1)	3982		0-N1296	VB [TE]	
540 i V8	09/92-09/95	M60 B40 (408S1), M60 B40 (408S1)	3982		0-N1297	VB [DG]	
540 i V8	09/92-09/95	M60 B40 (408S1), M60 B40 (408S1)	3982		0-N1585	VB [TE]	S
540 i V8	09/92-09/95	M60 B40 (408S1), M60 B40 (408S1)	3982		0-N2140	VB [TE]	
540 i V8	09/92-09/95	M60 B40 (408S1), M60 B40 (408S1)	3982		0-N2411	VB [VD]	

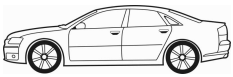

CM³



Art. Nr.



5 Touring (E34)

518 i	03/93-09/94	M43 B18 (184E2)	1796	21x110	SK-1060	BTK	
518 i	03/93-09/94	M43 B18 (184E2)	1796		0-N866	TB [DG]	
518 i	03/93-09/94	M43 B18 (184E2)	1796		0-N867	TB [DG]	
518 i	03/93-09/94	M43 B18 (184E2)	1796		0-N955	TB [TE]	
518 g, 518 i	09/94-01/97	M43 B18 (184E2)	1796		0-N1301	VB [TE]	
518 g, 518 i	09/94-01/97	M43 B18 (184E2)	1796		0-N1306	VB [TE]	
518 g, 518 i	09/94-01/97	M43 B18 (184E2)	1796	hydraulisch; mit Dämpfung	0-N1511	VB [BT]	
518 g, 518 i	09/94-01/97	M43 B18 (184E2)	1796	hydraulisch	0-N1758	VB [VD]	
520 i	11/91-01/97	M50 B20, M50 B20 (206S1), M50 B20 (206S2), M50 B20 TU	1991		0-N1290	VB [BT]	S
520 i	11/91-01/97	M50 B20, M50 B20 (206S1), M50 B20 (206S2), M50 B20 TU	1991		0-N1293	VB [VD]	
520 i	11/91-01/97	M50 B20, M50 B20 (206S1), M50 B20 (206S2), M50 B20 TU	1991	hydraulisch	0-N1298	VB [DG]	
520 i	11/91-01/97	M50 B20, M50 B20 (206S1), M50 B20 (206S2), M50 B20 TU	1991		0-N1301	VB [TE]	
520 i	11/91-01/97	M50 B20, M50 B20 (206S1), M50 B20 (206S2), M50 B20 TU	1991		0-N1559S	VB [TE]	
520 i	11/91-01/97	M50 B20, M50 B20 (206S1), M50 B20 (206S2), M50 B20 TU	1991		0-N1919	VB [BT]	S
520 i	11/91-01/97	M50 B20, M50 B20 (206S1), M50 B20 (206S2), M50 B20 TU	1991		0-N1974	VB [VD]	
520 i	11/91-01/97	M50 B20, M50 B20 (206S1), M50 B20 (206S2), M50 B20 TU	1991	hydraulisch	0-N2135	VB [BT]	
525 i	11/91-01/97	M50 B25 (256S1), M50 B25 (256S1), M50 B25 (256S2), M50 B25 (256S2)	2494	hydraulisch	0-N1298	VB [DG]	
525 i, 525 ix	11/91-01/97	M50 B25 (256S1), M50 B25 (256S1), M50 B25 (256S2), M50 B25 (256S2), M50 B25 (256S1), M50 B25 (256S2)	2494		0-N1290	VB [BT]	S
525 i, 525 ix	11/91-01/97	M50 B25 (256S1), M50 B25 (256S1), M50 B25 (256S2), M50 B25 (256S2), M50 B25 (256S1), M50 B25 (256S2)	2494		0-N1293	VB [VD]	
525 i, 525 ix	11/91-01/97	M50 B25 (256S1), M50 B25 (256S1), M50 B25 (256S2), M50 B25 (256S2), M50 B25 (256S1), M50 B25 (256S2)	2494		0-N1301	VB [TE]	
525 i, 525 ix	11/91-01/97	M50 B25 (256S1), M50 B25 (256S1), M50 B25 (256S2), M50 B25 (256S2), M50 B25 (256S1), M50 B25 (256S2)	2494		0-N1559S	VB [TE]	
525 i, 525 ix	11/91-01/97	M50 B25 (256S1), M50 B25 (256S1), M50 B25 (256S2), M50 B25 (256S2), M50 B25 (256S1), M50 B25 (256S2)	2494		0-N1919	VB [BT]	S
525 i, 525 ix	11/91-01/97	M50 B25 (256S1), M50 B25 (256S1), M50 B25 (256S2), M50 B25 (256S2), M50 B25 (256S1), M50 B25 (256S2)	2494		0-N1974	VB [VD]	
525 i, 525 ix	11/91-01/97	M50 B25 (256S1), M50 B25 (256S1), M50 B25 (256S2), M50 B25 (256S2), M50 B25 (256S1), M50 B25 (256S2)	2494	hydraulisch	0-N2135	VB [BT]	
525 ix	02/92-01/97	M50 B25 (256S1), M50 B25 (256S2)	2494		0-N1298	VB [DG]	
525 td	03/93-01/97	M51 D25 (256T1)	2497		0-N1303	VB [VD]	
525 td	03/93-01/97	M51 D25 (256T1)	2497		0-N1304	VB [TE]	
525 td	03/93-01/97	M51 D25 (256T1)	2497		0-N1305	VB [DG]	
525 td	03/93-01/97	M51 D25 (256T1)	2497		0-N1306	VB [TE]	
525 tds	12/91-01/97	M51 D25 (256T1)	2503		0-N1303	VB [VD]	
525 tds	12/91-01/97	M51 D25 (256T1)	2503		0-N1304	VB [TE]	
525 tds	12/91-01/97	M51 D25 (256T1)	2503		0-N1305	VB [DG]	
525 tds	12/91-01/97	M51 D25 (256T1)	2503		0-N1306	VB [TE]	
530 i V8	09/92-01/97	M60 B30 (308S1), M60 B30 (308S1)	2997		0-N1296	VB [TE]	
530 i V8	09/92-01/97	M60 B30 (308S1), M60 B30 (308S1)	2997		0-N1297	VB [DG]	
530 i V8	09/92-01/97	M60 B30 (308S1), M60 B30 (308S1)	2997		0-N1585	VB [TE]	S
530 i V8	09/92-01/97	M60 B30 (308S1), M60 B30 (308S1)	2997		0-N2140	VB [TE]	
530 i V8	09/92-01/97	M60 B30 (308S1), M60 B30 (308S1)	2997		0-N2411	VB [VD]	
540 i	09/93-01/97	M60 B40 (408S1)	3982		0-N1296	VB [TE]	
540 i	09/93-01/97	M60 B40 (408S1)	3982		0-N1297	VB [DG]	
540 i	09/93-01/97	M60 B40 (408S1)	3982		0-N1585	VB [TE]	S
540 i	09/93-01/97	M60 B40 (408S1)	3982		0-N2140	VB [TE]	
540 i	09/93-01/97	M60 B40 (408S1)	3982		0-N2411	VB [VD]	

5 (E39)

520 d	02/00-06/03	M47 204 D1, M47 D20 (204D1)	1951		0-N1304	VB [TE]	
520 d	02/00-06/03	M47 204 D1, M47 D20 (204D1)	1951		0-N1396	VB [DG]	
520 d	02/00-06/03	M47 204 D1, M47 D20 (204D1)	1951		0-N1913	VB [BT]	S
520 d	02/00-06/03	M47 204 D1, M47 D20 (204D1)	1951		0-N1923	VB [BT]	

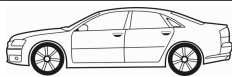

CM³



Art. Nr.



5 (E39)							
520 d	02/00-06/03	M47 204 D1, M47 D20 (204D1)	1951			0-N1932	VB [VD]
520 i	01/96-06/03	M52 B(20 6 S4), M52 B20, M52 B20 (206S3), M52 B20 (206S3)	1991			0-N1290	VB [BT] S
520 i	01/96-09/00	M52 B(20 6 S4), M52 B20, M52 B20 (206S3)	1991	04/1998 →		0-N1291	VB [BT] S
520 i	01/96-06/03	M52 B(20 6 S4), M52 B20, M52 B20 (206S3), M52 B20 (206S3)	1991			0-N1293	VB [VD]
520 i	01/96-09/00	M52 B(20 6 S4), M52 B20, M52 B20 (206S3)	1991	hydraulisch		0-N1298	VB [DG]
520 i	01/96-06/03	M52 B(20 6 S4), M52 B20, M52 B20 (206S3), M52 B20 (206S3)	1991			0-N1301	VB [TE]
520 i	01/96-09/00	M52 B(20 6 S4), M52 B20, M52 B20 (206S3)	1991	→ 03/1998		0-N1559S	VB [TE]
520 i	01/96-06/03	M52 B(20 6 S4), M52 B20, M52 B20 (206S3), M52 B20 (206S3)	1991			0-N1919	VB [BT] S
520 i	01/96-09/00	M52 B(20 6 S4), M52 B20, M52 B20 (206S3)	1991	→ 03/1998		0-N1974	VB [VD]
520 i	04/99-06/03	M52 B20 (206S3)	1991	→ 09/2002		0-N1291	VB [BT] S
520 i	04/99-06/03	M52 B20 (206S3)	1991			0-N1298	VB [DG]
520 i	04/99-06/03	M52 B20 (206S3)	1991	09/2002 →		0-N1791	VB [BT] S
520 i	09/00-06/03	M54 B22 (226S1)	2171			0-N1290	VB [BT] S
520 i	09/00-06/03	M54 B22 (226S1)	2171	→ 09/2002		0-N1291	VB [BT] S
520 i	09/00-06/03	M54 B22 (226S1)	2171			0-N1293	VB [VD]
520 i	09/00-06/03	M54 B22 (226S1)	2171			0-N1298	VB [DG]
520 i	09/00-06/03	M54 B22 (226S1)	2171			0-N1301	VB [TE]
520 i	09/00-06/03	M54 B22 (226S1)	2171	09/2002 →		0-N1791	VB [BT] S
520 i	09/00-06/03	M54 B22 (226S1)	2171			0-N1919	VB [BT] S
523 i	11/95-09/00	M52 B25 (256S3), M52 B25 TU	2494	04/1998 →		0-N1291	VB [BT] S
523 i	11/95-09/00	M52 B25 (256S3), M52 B25 TU	2494	hydraulisch		0-N1298	VB [DG]
523 i	11/95-09/00	M52 B25 (256S3), M52 B25 TU	2494	→ 03/1998		0-N1559S	VB [TE]
523 i	11/95-09/00	M52 B25 (256S3), M52 B25 TU	2494	→ 03/1998		0-N1974	VB [VD]
523 i, 525 i	11/95-06/03	M52 B25 (256S3), M52 B25 TU, M54 B25, M54 B25 (256S5), M54 B25 (256S5)	2494			0-N1290	VB [BT] S
523 i, 525 i	11/95-06/03	M52 B25 (256S3), M52 B25 TU, M54 B25, M54 B25 (256S5), M54 B25 (256S5)	2494			0-N1293	VB [VD]
523 i, 525 i	11/95-06/03	M52 B25 (256S3), M52 B25 TU, M54 B25, M54 B25 (256S5), M54 B25 (256S5)	2494			0-N1301	VB [TE]
523 i, 525 i	11/95-06/03	M52 B25 (256S3), M52 B25 TU, M54 B25, M54 B25 (256S5), M54 B25 (256S5)	2494			0-N1919	VB [BT] S
523 i, 525 i	11/95-06/03	M52 B25 (256S3), M52 B25 TU, M54 B25, M54 B25 (256S5), M54 B25 (256S5)	2494	hydraulisch		0-N2135	VB [BT]
525 d	02/00-06/03	M57 D25 (256D1), M57 D25 (256D1)	2497			0-N1396	VB [DG]
525 d	02/00-06/03	M57 D25 (256D1), M57 D25 (256D1)	2497			0-N1834	VB [BT] S
525 d	02/00-06/03	M57 D25 (256D1), M57 D25 (256D1)	2497			0-N1900	VB [BT]
525 d	02/00-06/03	M57 D25 (256D1), M57 D25 (256D1)	2497			0-N1912	VB [BT] S
525 d	02/00-06/03	M57 D25 (256D1), M57 D25 (256D1)	2497	→ 10/2000		0-N1940	VB [BT] S
525 i	09/00-06/03	M54 B25, M54 B25 (256S5), M54 B25 (256S5)	2494	→ 09/2002		0-N1291	VB [BT] S
525 i	09/00-06/03	M54 B25, M54 B25 (256S5), M54 B25 (256S5)	2494			0-N1298	VB [DG]
525 i	09/00-06/03	M54 B25, M54 B25 (256S5), M54 B25 (256S5)	2494	09/2002 →		0-N1791	VB [BT] S
525 td	01/97-06/03	M51 D25 (256T1)	2497			0-N1303	VB [VD]
525 td	01/97-06/03	M51 D25 (256T1)	2497			0-N1304	VB [TE]
525 td	01/97-06/03	M51 D25 (256T1)	2497			0-N1305	VB [DG]
525 td	01/97-06/03	M51 D25 (256T1)	2497	⊛		0-N1514	VB [BT] S
525 tds	01/96-06/03	M51 D25 (256T1)	2503			0-N1303	VB [VD]
525 tds	01/96-06/03	M51 D25 (256T1)	2503			0-N1304	VB [TE]
525 tds	01/96-06/03	M51 D25 (256T1)	2503			0-N1305	VB [DG]
525 tds	01/96-06/03	M51 D25 (256T1)	2503	⊛		0-N1514	VB [BT] S
528 i	11/95-09/00	M52 B28 (286S1), M52 B28 (286S1), M52 B28 (286S2), M52 B28 (286S2)	2793			0-N1290	VB [BT] S
528 i	11/95-09/00	M52 B28 (286S1), M52 B28 (286S1), M52 B28 (286S2), M52 B28 (286S2)	2793	04/1998 →		0-N1291	VB [BT] S
528 i	11/95-09/00	M52 B28 (286S1), M52 B28 (286S1), M52 B28 (286S2), M52 B28 (286S2)	2793			0-N1293	VB [VD]
528 i	11/95-09/00	M52 B28 (286S1), M52 B28 (286S1), M52 B28 (286S2), M52 B28 (286S2)	2793	hydraulisch		0-N1298	VB [DG]
528 i	11/95-09/00	M52 B28 (286S1), M52 B28 (286S1), M52 B28 (286S2), M52 B28 (286S2)	2793			0-N1301	VB [TE]
528 i	11/95-09/00	M52 B28 (286S1), M52 B28 (286S1), M52 B28 (286S2), M52 B28 (286S2)	2793	→ 03/1998		0-N1559S	VB [TE]



CM³



Art. Nr.



5 (E39)								
528 i	11/95-09/00	M52 B28 (286S1), M52 B28 (286S1), M52 B28 (286S2), M52 B28 (286S2)	2793		0-N1919	VB [BT]	S	
528 i	11/95-09/00	M52 B28 (286S1), M52 B28 (286S1), M52 B28 (286S2), M52 B28 (286S2)	2793	→ 03/1998	0-N1974	VB [VD]		
528 i	11/95-09/00	M52 B28 (286S1), M52 B28 (286S1), M52 B28 (286S2), M52 B28 (286S2)	2793	hydraulisch	0-N2135	VB [BT]		
530 d	08/98-06/03	M57 D30 (306D1)	2926		0-N1396	VB [DG]		
530 d	08/98-06/03	M57 D30 (306D1)	2926		0-N1834	VB [BT]	S	
530 d	08/98-06/03	M57 D30 (306D1)	2926		0-N1900	VB [BT]		
530 d	08/98-06/03	M57 D30 (306D1)	2926		0-N1912	VB [BT]	S	
530 d	08/98-06/03	M57 D30 (306D1)	2926		0-N1923	VB [BT]		
530 d	08/98-09/00	M57 D30 (306D1)	2926		0-N1940	VB [BT]	S	
530 i	09/00-06/03	M54 B30, M54 B30 (306S3)	2979		0-N1290	VB [BT]	S	
530 i	09/00-06/03	M54 B30, M54 B30 (306S3)	2979	→ 09/2002	0-N1291	VB [BT]	S	
530 i	09/00-06/03	M54 B30, M54 B30 (306S3)	2979		0-N1293	VB [VD]		
530 i	09/00-06/03	M54 B30, M54 B30 (306S3)	2979		0-N1298	VB [DG]		
530 i	09/00-06/03	M54 B30, M54 B30 (306S3)	2979		0-N1301	VB [TE]		
530 i	09/00-06/03	M54 B30, M54 B30 (306S3)	2979	09/2002 →	0-N1791	VB [BT]	S	
530 i	09/00-06/03	M54 B30, M54 B30 (306S3)	2979		0-N1919	VB [BT]	S	
530 i	09/00-06/03	M54 B30, M54 B30 (306S3)	2979	hydraulisch	0-N2135	VB [BT]		
535 i	04/96-03/99	M62 B35 (358S1), M62 B35 (358S2)	3498		0-N1296	VB [TE]		
535 i	04/96-03/99	M62 B35 (358S1), M62 B35 (358S2)	3498	05/1997 → 04/1998	0-N1299	VB [BT]	S	
535 i	04/96-03/99	M62 B35 (358S1), M62 B35 (358S2)	3498	05/1997 →	0-N1300	VB [TE]	S	
535 i	04/96-03/99	M62 B35 (358S1), M62 B35 (358S2)	3498	05/1997 →	0-N1506	VB [BT]	S	
535 i	04/96-03/99	M62 B35	3498		0-N1527	VB [BT]	S	
535 i	04/96-03/99	M62 B35 (358S1), M62 B35 (358S2)	3498	→ 04/1997	0-N1585	VB [TE]	S	
535 i	04/96-03/99	M62 B35 (358S1), M62 B35 (358S2)	3498	→ 04/1997	0-N1586	VB [DG]		
535 i	04/96-03/99	M62 B35 (358S1), M62 B35 (358S2)	3498	→ 08/1997	0-N1640	VB [BT]	S	
535 i	04/96-03/99	M62 B35 (358S1), M62 B35 (358S2)	3498	09/1998 →	0-N1669	VB [BT]	S	
535 i	04/96-03/99	M62 B35 (358S1), M62 B35 (358S2)	3498	08/1997 →	0-N1787	VB [VD]		
535 i	04/96-03/99	M62 B35 (358S1), M62 B35 (358S2)	3498	09/1997 →	0-N2410	VB [VD]		
535 i	04/96-03/99	M62 B35 (358S1), M62 B35 (358S2)	3498	→ 08/1997	0-N2411	VB [VD]		
535 i	04/96-03/99	M62 B35 (358S1), M62 B35 (358S2)	3498	→ 09/1997	0-N2411	VB [VD]		
535 i	04/99-06/03	M62 B35 (358S2), M62 B35 TU	3498		0-N1299	VB [BT]	S	
535 i	04/99-06/03	M62 B35 (358S2), M62 B35 TU	3498		0-N1300	VB [TE]	S	
535 i	04/99-06/03	M62 B35 (358S2), M62 B35 TU	3498		0-N1506	VB [BT]	S	
535 i	04/99-06/03	M62 B35 (358S2), M62 B35 TU	3498		0-N1527	VB [BT]	S	
535 i	04/99-06/03	M62 B35 (358S2), M62 B35 TU	3498		0-N1669	VB [BT]	S	
535 i	04/99-06/03	M62 B35 (358S2), M62 B35 TU	3498		0-N1726	VB [DG]		
535 i	04/99-06/03	M62 B35 (358S2), M62 B35 TU	3498		0-N1787	VB [VD]		
535 i	04/99-06/03	M62 B35 (358S2), M62 B35 TU	3498		0-N2410	VB [VD]		
540 i	04/96-06/03	M62 B44 (448S1), M62 B44 (448S2)	4398		0-N1296	VB [TE]		
540 i	04/96-06/03	M62 B44 (448S1), M62 B44 (448S2)	4398	→ 04/1999	0-N1297	VB [DG]		
540 i	04/96-06/03	M62 B44 (448S1), M62 B44 (448S2)	4398	08/1997 →	0-N1299	VB [BT]	S	
540 i	04/96-06/03	M62 B44 (448S1), M62 B44 (448S2)	4398	09/1997 →	0-N1300	VB [TE]	S	
540 i	04/96-06/03	M62 B44 (448S1), M62 B44 (448S2)	4398	09/1997 →	0-N1506	VB [BT]	S	
540 i	04/96-06/03	M62 448 S2	4398		0-N1527	VB [BT]	S	
540 i	04/96-06/03	M62 B44 (448S1), M62 B44 (448S2)	4398	→ 09/1997	0-N1585	VB [TE]	S	
540 i	04/96-06/03	M62 B44 (448S1), M62 B44 (448S2)	4398	→ 08/1997	0-N1586	VB [DG]		
540 i	04/96-06/03	M62 B44 (448S1), M62 B44 (448S2)	4398	→ 08/1997	0-N1640	VB [BT]	S	
540 i	04/96-06/03	M62 B44 (448S1), M62 B44 (448S2)	4398	05/1999 →	0-N1726	VB [DG]		
540 i	04/96-06/03	M62 B44 (448S1), M62 B44 (448S2)	4398	08/1997 →	0-N1787	VB [VD]		
540 i	04/96-06/03	M62 B44 (448S1), M62 B44 (448S2)	4398	09/1997 →	0-N2410	VB [VD]		
540 i	04/96-06/03	M62 B44 (448S1), M62 B44 (448S2)	4398	→ 08/1997	0-N2411	VB [VD]		
540 i	04/96-06/03	M62 B44 (448S1), M62 B44 (448S2)	4398	→ 09/1997	0-N2411	VB [VD]		
M 4.9	10/98-06/03	S62 B50, S62 B50 (508S1)	4941		0-N1300	VB [TE]	S	
M 4.9	10/98-06/03	S62 B50, S62 B50 (508S1)	4941		0-N1787	VB [VD]		
M 4.9	10/98-06/03	S62 B50, S62 B50 (508S1)	4941		0-N2410	VB [VD]		
5 Touring (E39)								
520 d	02/00-09/03	M47 204 D1, M47 D20 (204D1)	1951		0-N1304	VB [TE]		
520 d	02/00-09/03	M47 204 D1, M47 D20 (204D1)	1951		0-N1396	VB [DG]		
520 d	02/00-09/03	M47 204 D1, M47 D20 (204D1)	1951		0-N1913	VB [BT]	S	
520 d	02/00-09/03	M47 204 D1, M47 D20 (204D1)	1951		0-N1923	VB [BT]		
520 d	02/00-09/03	M47 204 D1, M47 D20 (204D1)	1951		0-N1932	VB [VD]		
520 i	01/97-05/04	M52 B(20 6 S4), M52 B20, M52 B20 (206S3), M52 B20 (206S3)	1991		0-N1290	VB [BT]	S	



OPTIMAL®

BMW



CM³



Art. Nr.



5 Touring (E39)

520 i	01/97-09/00	M52 B(20 6 S4), M52 B20, M52 B20 (206S3)	1991	04/1998 →	0-N1291	VB [BT]	S
520 i	01/97-05/04	M52 B(20 6 S4), M52 B20, M52 B20 (206S3), M52 B20 (206S3)	1991		0-N1293	VB [VD]	
520 i	01/97-05/04	M52 B(20 6 S4), M52 B20, M52 B20 (206S3), M52 B20 (206S3)	1991		0-N1298	VB [DG]	
520 i	01/97-09/00	M52 B(20 6 S4), M52 B20, M52 B20 (206S3)	1991	hydraulisch	0-N1298	VB [DG]	
520 i	01/97-05/04	M52 B(20 6 S4), M52 B20, M52 B20 (206S3), M52 B20 (206S3)	1991		0-N1301	VB [TE]	
520 i	01/97-09/00	M52 B(20 6 S4), M52 B20, M52 B20 (206S3)	1991	→ 03/1998	0-N1559S	VB [TE]	
520 i	01/97-05/04	M52 B(20 6 S4), M52 B20, M52 B20 (206S3), M52 B20 (206S3)	1991		0-N1919	VB [BT]	S
520 i	01/97-09/00	M52 B(20 6 S4), M52 B20, M52 B20 (206S3)	1991	→ 03/1998	0-N1974	VB [VD]	
520 i	04/99-05/04	M52 B20 (206S3)	1991	→ 09/2002	0-N1291	VB [BT]	S
520 i	04/99-05/04	M52 B20 (206S3)	1991	09/2002 →	0-N1791	VB [BT]	S
520 i	09/00-05/04	M54 B22 (226S1)	2171		0-N1290	VB [BT]	S
520 i	09/00-05/04	M54 B22 (226S1)	2171	→ 09/2002	0-N1291	VB [BT]	S
520 i	09/00-05/04	M54 B22 (226S1)	2171		0-N1293	VB [VD]	
520 i	09/00-05/04	M54 B22 (226S1)	2171		0-N1298	VB [DG]	
520 i	09/00-05/04	M54 B22 (226S1)	2171		0-N1301	VB [TE]	
520 i	09/00-05/04	M54 B22 (226S1)	2171	09/2002 →	0-N1791	VB [BT]	S
520 i	09/00-05/04	M54 B22 (226S1)	2171		0-N1919	VB [BT]	S
523 i	01/97-09/00	M52 B25 (256S3), M52 B25 TU	2494	04/1998 →	0-N1291	VB [BT]	S
523 i	01/97-09/00	M52 B25 (256S3), M52 B25 TU	2494	hydraulisch	0-N1298	VB [DG]	
523 i	01/97-09/00	M52 B25 (256S3), M52 B25 TU	2494	→ 03/1998	0-N1559S	VB [TE]	
523 i	01/97-09/00	M52 B25 (256S3), M52 B25 TU	2494	→ 03/1998	0-N1974	VB [VD]	
523 i, 525 i	01/97-05/04	M52 B25 (256S3), M52 B25 TU, M54 B25 (256S5)	2494		0-N1290	VB [BT]	S
523 i, 525 i	01/97-05/04	M52 B25 (256S3), M52 B25 TU, M54 B25 (256S5)	2494		0-N1293	VB [VD]	
523 i, 525 i	01/97-05/04	M52 B25 (256S3), M52 B25 TU, M54 B25 (256S5)	2494		0-N1301	VB [TE]	
523 i, 525 i	01/97-05/04	M52 B25 (256S3), M52 B25 TU, M54 B25 (256S5)	2494		0-N1919	VB [BT]	S
523 i, 525 i	01/97-05/04	M52 B25 (256S3), M52 B25 TU, M54 B25 (256S5)	2494	hydraulisch	0-N2135	VB [BT]	
525 d	02/00-05/04	M57 D25 (256D1), M57 D25 (256D1)	2497		0-N1396	VB [DG]	
525 d	02/00-05/04	M57 D25 (256D1), M57 D25 (256D1)	2497		0-N1834	VB [BT]	S
525 d	02/00-05/04	M57 D25 (256D1), M57 D25 (256D1)	2497		0-N1900	VB [BT]	
525 d	02/00-05/04	M57 D25 (256D1), M57 D25 (256D1)	2497		0-N1912	VB [BT]	S
525 d	02/00-05/04	M57 D25 (256D1), M57 D25 (256D1)	2497		0-N1923	VB [BT]	
525 d	02/00-05/04	M57 D25 (256D1), M57 D25 (256D1)	2497	→ 10/2000	0-N1940	VB [BT]	S
525 i	09/00-05/04	M54 B25 (256S5)	2494	→ 09/2002	0-N1291	VB [BT]	S
525 i	09/00-05/04	M54 B25 (256S5)	2494		0-N1298	VB [DG]	
525 i	09/00-05/04	M54 B25 (256S5)	2494	09/2002 →	0-N1791	VB [BT]	S
525 tds	03/97-05/04	M51 D25 (256T1)	2503		0-N1303	VB [VD]	
525 tds	03/97-05/04	M51 D25 (256T1)	2503		0-N1304	VB [TE]	
525 tds	03/97-05/04	M51 D25 (256T1)	2503		0-N1305	VB [DG]	
525 tds	03/97-05/04	M51 D25 (256T1)	2503	✳	0-N1514	VB [BT]	S
528 i	01/97-09/00	M52 B28 (286S1), M52 B28 (286S1), M52 B28 (286S2), M52 B28 (286S2)	2793		0-N1290	VB [BT]	S
528 i	01/97-09/00	M52 B28 (286S1), M52 B28 (286S1), M52 B28 (286S2), M52 B28 (286S2)	2793	04/1998 →	0-N1291	VB [BT]	S
528 i	01/97-09/00	M52 B28 (286S1), M52 B28 (286S1), M52 B28 (286S2), M52 B28 (286S2)	2793		0-N1293	VB [VD]	
528 i	01/97-09/00	M52 B28 (286S1), M52 B28 (286S1), M52 B28 (286S2), M52 B28 (286S2)	2793	hydraulisch	0-N1298	VB [DG]	
528 i	01/97-09/00	M52 B28 (286S1), M52 B28 (286S1), M52 B28 (286S2), M52 B28 (286S2)	2793		0-N1301	VB [TE]	
528 i	01/97-09/00	M52 B28 (286S1), M52 B28 (286S1), M52 B28 (286S2), M52 B28 (286S2)	2793	→ 03/1998	0-N1559S	VB [TE]	
528 i	01/97-09/00	M52 B28 (286S1), M52 B28 (286S1), M52 B28 (286S2), M52 B28 (286S2)	2793		0-N1919	VB [BT]	S
528 i	01/97-09/00	M52 B28 (286S1), M52 B28 (286S1), M52 B28 (286S2), M52 B28 (286S2)	2793	→ 03/1998	0-N1974	VB [VD]	
528 i	01/97-09/00	M52 B28 (286S1), M52 B28 (286S1), M52 B28 (286S2), M52 B28 (286S2)	2793	hydraulisch	0-N2135	VB [BT]	
530 d	08/98-05/04	M57 D30 (306D1)	2926		0-N1396	VB [DG]	
530 d	08/98-05/04	M57 D30 (306D1)	2926		0-N1834	VB [BT]	S
530 d	08/98-05/04	M57 D30 (306D1)	2926		0-N1900	VB [BT]	
530 d	08/98-05/04	M57 D30 (306D1)	2926		0-N1912	VB [BT]	S



CM³



Art. Nr.



5 Touring (E39)

530 d	08/98-05/04	M57 D30 (306D1)	2926		0-N1923	VB [BT]	
530 d	08/98-09/00	M57 D30 (306D1)	2926		0-N1940	VB [BT]	S
530 i	09/00-05/04	M54 B30 (306S3)	2979		0-N1290	VB [BT]	S
530 i	09/00-05/04	M54 B30 (306S3)	2979	→ 09/2002	0-N1291	VB [BT]	S
530 i	09/00-05/04	M54 B30 (306S3)	2979		0-N1293	VB [VD]	
530 i	09/00-05/04	M54 B30 (306S3)	2979		0-N1298	VB [DG]	
530 i	09/00-05/04	M54 B30 (306S3)	2979		0-N1301	VB [TE]	
530 i	09/00-05/04	M54 B30 (306S3)	2979	09/2002 →	0-N1791	VB [BT]	S
530 i	09/00-05/04	M54 B30 (306S3)	2979		0-N1919	VB [BT]	S
530 i	09/00-05/04	M54 B30 (306S3)	2979	hydraulisch	0-N2135	VB [BT]	
540 i	01/97-05/04	M62 B44 (448S1), M62 B44 (448S2)	4398		0-N1296	VB [TE]	
540 i	01/97-05/04	M62 B44 (448S1), M62 B44 (448S2)	4398		0-N1297	VB [DG]	
540 i	01/97-05/04	M62 B44 (448S1), M62 B44 (448S2)	4398	08/1997 →	0-N1299	VB [BT]	S
540 i	01/97-05/04	M62 B44 (448S1), M62 B44 (448S2)	4398	09/1997 →	0-N1300	VB [TE]	S
540 i	01/97-05/04	M62 B44 (448S1), M62 B44 (448S2)	4398	09/1997 →	0-N1506	VB [BT]	S
540 i	01/97-05/04	M62 448 S2	4398		0-N1527	VB [BT]	S
540 i	01/97-05/04	M62 B44 (448S1), M62 B44 (448S2)	4398	→ 09/1997	0-N1585	VB [TE]	S
540 i	01/97-05/04	M62 B44 (448S1), M62 B44 (448S2)	4398	→ 08/1997	0-N1586	VB [DG]	
540 i	01/97-05/04	M62 B44 (448S1), M62 B44 (448S2)	4398	→ 08/1997	0-N1640	VB [BT]	S
540 i	01/97-05/04	M62 B44 (448S1), M62 B44 (448S2)	4398	09/1998 →	0-N1669	VB [BT]	S
540 i	01/97-05/04	M62 B44 (448S1), M62 B44 (448S2)	4398	05/1999 →	0-N1726	VB [DG]	
540 i	01/97-05/04	M62 B44 (448S1), M62 B44 (448S2)	4398	08/1997 →	0-N1787	VB [VD]	
540 i	01/97-05/04	M62 B44 (448S1), M62 B44 (448S2)	4398	09/1997 →	0-N2410	VB [VD]	
540 i	01/97-05/04	M62 B44 (448S1), M62 B44 (448S2)	4398	→ 08/1997	0-N2411	VB [VD]	
540 i	01/97-05/04	M62 B44 (448S1), M62 B44 (448S2)	4398	→ 09/1997	0-N2411	VB [VD]	

5 (E60)

520 d	07/05-03/10	M47	1995		0-N1523	VB [TE]	
520 d	07/05-03/10	M47	1995		0-N1790	VB [BT]	
520 d	07/05-03/10	M47	1995		0-N1792	VB [DG]	
520 d	07/05-03/10	N47	1995		0-N1950	VB [DG]	
520 d	07/05-03/10	N47	1995		0-N2084	VB [BT]	S
520 d	09/05-03/10	M47 D20 (204D4)	1995		0-N1523	VB [TE]	
520 d	09/05-03/10	M47 D20 (204D4)	1995		0-N1790	VB [BT]	
520 d	09/05-03/10	M47 D20 (204D4)	1995		0-N1792	VB [DG]	
520 d	09/07-03/10	M47N	1995		0-N1523	VB [TE]	
520 d	09/07-03/10	M47N	1995		0-N1792	VB [DG]	
520 i	07/03-03/10	M54 B22 (226S1)	2171		0-N1290	VB [BT]	S
520 i	07/03-03/10	M54 B22 (226S1)	2171		0-N1293	VB [VD]	
520 i	07/03-03/10	M54 B22 (226S1)	2171		0-N1301	VB [TE]	
520 i	07/03-03/10	M54 B22 (226S1)	2171	†	0-N1453	VB [DG]	
520 i	07/03-03/10	M54 B22 (226S1)	2171		0-N1791	VB [BT]	S
520 i	07/03-03/10	M54 B22 (226S1)	2171		0-N1919	VB [BT]	S
520 i	07/03-03/10	M54 B22 (226S1)	2171	hydraulisch	0-N2135	VB [BT]	
520 i	09/07-03/10	N43 B20 A	1995		0-N2130	VB [DG]	
520 i, 520i	12/06-03/10	N43 B20 A	1995		0-N2212	VB [BT]	S
523 i, 525 i, 525 xi	07/05-03/10	N52 B25 A, N52 B25 A, N52 B25 BE, N52 B25, N52 B25 A	2497		0-N1788	VB [BT]	S
523 i, 525 i, 525 xi	07/05-03/10	N52 B25 A, N52 B25 A, N52 B25 BE, N52 B25, N52 B25 A	2497		0-N2128	VB [DG]	
525 d	06/04-03/10	M57N	2497		0-N1523	VB [TE]	
525 d	06/04-03/10	M57 D25 (256D1), M57 D25 (256D2), M57 D25 TU	2497		0-N1790	VB [BT]	
525 d	06/04-03/10	M57N	2497		0-N1792	VB [DG]	
525 d	06/04-03/10	M57 D25 (256D1), M57 D25 (256D2), M57 D25 TU	2497	für Fahrzeuge ohne aktive Stabilisatorregelung; für Fahrzeuge ohne Niveauregulierung	0-N1944	VB [DG]	
525 d	06/04-03/10	M57 D25 TU	2497	→ 09/2004	0-N2074	VB [TE]	S
525 d	12/04-03/10	M57 D25 (256D1)	2497		0-N1523	VB [TE]	
525 d	12/04-03/10	M57 D25 (256D1)	2497		0-N1792	VB [DG]	
525 d xDrive, 530 d xDrive	09/08-03/10	M57	2993		0-N1523	VB [TE]	
525 d xDrive, 530 d xDrive	09/08-03/10	M57	2993		0-N1792	VB [DG]	
525 d, 525 d xDrive, 525 xd, 530 d, 530 d xDrive, 530 xd, 535 d	07/03-03/10	M57 D30 (306D2), M57 D30 (306D3), M57 D30 (306D4), M57 D30 (306D5)	2993		0-N1790	VB [BT]	
525 d, 525 xd, 530 d, 530 d xDrive, 530 xd, 535 d	07/03-03/10	M57 D30 (306D2), M57 D30 (306D3), M57 D30 (306D4), M57 D30 (306D5)	2993	für Fahrzeuge ohne aktive Stabilisatorregelung; für Fahrzeuge ohne Niveauregulierung	0-N1944	VB [DG]	



CM³



Art. Nr.



ohne Halter

5 (E60)							
525 d, 525 xd, 530 d, 530 xd, 535 d	07/03-03/10	M57 D30 (306D2), M57 D30 (306D3), M57 D30 (306D4), M57 D30 (306D5)	2993			0-N1523	VB [TE]
525 d, 525 xd, 530 d, 530 xd, 535 d	07/03-03/10	M57 D30 (306D2), M57 D30 (306D3), M57 D30 (306D4), M57 D30 (306D5)	2993			0-N1792	VB [DG]
525 i	09/03-03/10	M54 B25 (256S5)	2494			0-N1290	VB [BT] S
525 i	09/03-03/10	M54 B25 (256S5)	2494			0-N1293	VB [VD]
525 i	09/03-03/10	M54 B25 (256S5)	2494			0-N1301	VB [TE]
525 i	09/03-03/10	M54 B25 (256S5)	2494	†		0-N1453	VB [DG]
525 i	09/03-03/10	M54 B25 (256S5)	2494			0-N1791	VB [BT] S
525 i	09/03-03/10	M54 B25 (256S5)	2494			0-N1919	VB [BT] S
525 i	09/03-03/10	M54 B25 (256S5)	2494			0-N2128	VB [DG]
525 i	09/03-03/10	M54 B25 (256S5)	2494	hydraulisch		0-N2135	VB [BT]
525 i, 525 i xDrive, 525 xi, 530 i, 530 i xDrive, 530 xi	03/05-03/10	N52 B30 A, N52 B30 A, N52 B30 A, N52 B30 A, N53 B30 A, N52 B30, N52 B30 A, N53 B30 A, N53 B30 A	2996			0-N1788	VB [BT] S
525 i, 525 i xDrive, 525 xi, 530 i, 530 i xDrive, 530 xi	07/05-03/10	N52 B30 A, N52 B30 A, N52 B30 A, N52 B30 A, N53 B30 A, N52 B30, N52 B30 A, N53 B30 A, N53 B30 A	2996			0-N2128	VB [DG]
530 d	07/03-03/10	M57 D30 (306D2)	2993	→ 09/2004		0-N2074	VB [TE] S
530 d	07/03-03/10	M57 D30 (306D2), M57 D30 (306D3)	2993	→ 09/2004		0-N2075	VB [BT]
530 i	07/03-03/10	M54 B30 (306S3)	2979			0-N1290	VB [BT] S
530 i	07/03-03/10	M54 B30 (306S3)	2979			0-N1293	VB [VD]
530 i	07/03-03/10	M54 B30 (306S3)	2979			0-N1301	VB [TE]
530 i	07/03-03/10	M54 B30 (306S3)	2979	†		0-N1453	VB [DG]
530 i	07/03-03/10	M54 B30 (306S3)	2979			0-N1791	VB [BT] S
530 i	07/03-03/10	M54 B30 (306S3)	2979			0-N1919	VB [BT] S
530 i	07/03-03/10	M54 B30 (306S3)	2979	hydraulisch		0-N2135	VB [BT]
540 i	07/05-03/10	N62 B40 A	4000			0-N1507	VB [BT] S
540 i	07/05-03/10	N62 B40 A	4000			0-N1922	VB [BT]
540 i	08/05-03/10	N54 B30 A	2979			0-N1621	VB [BT] S
540 i	08/05-03/10	N54 B30 A	2979			0-N1922	VB [BT]
545 i	09/03-03/10	N62 B44 A	4398			0-N1507	VB [BT] S
545 i	09/03-03/10	N62 B44 A	4398			0-N1922	VB [BT]
550 i	07/05-03/10	N62 B48 A, N62 B48 B	4799			0-N1507	VB [BT] S
550 i	07/05-03/10	N62 B48 A, N62 B48 B	4799			0-N1922	VB [BT]
M	09/04-03/10	S85 B50 A	4999			0-N1298	VB [DG]
5 Touring (E61)							
520 d	07/05-12/10	M47N	1995			0-N1523	VB [TE]
520 d	07/05-12/10	M47	1995			0-N1790	VB [BT]
520 d	07/05-12/10	M47N	1995			0-N1792	VB [DG]
520 d	07/05-12/10	N47	1995			0-N1950	VB [DG]
520 d	07/05-12/10	N47	1995			0-N2084	VB [BT] S
520 d	09/05-12/10	M47 D20 (204D4), N47 D20 A, N47 D20 C	1995			0-N1523	VB [TE]
520 d	09/05-12/10	M47 D20 (204D4), N47 D20 A, N47 D20 C	1995			0-N1790	VB [BT]
520 d	09/05-12/10	M47 D20 (204D4), N47 D20 A, N47 D20 C	1995			0-N1792	VB [DG]
520 d	09/07-12/10	N47 D20 A, N47 D20 C	1995			0-N1950	VB [DG]
520 d	09/07-12/10	N47 D20 A, N47 D20 C	1995			0-N2084	VB [BT] S
520 i	09/07-12/10	N43 B20 A	1995			0-N2130	VB [DG]
520 i, 520i	07/07-12/10	N43 B20 A	1995			0-N2212	VB [BT] S
523 i, 525 i, 525 xi	07/05-12/10	N52 B25 A, N52 B25 A, N52 B25 B, N52 B25 BE, N52 B25 A, N53 B25 A, N52 B25, N52 B25 A	2497			0-N1788	VB [BT] S
523 i, 525 i, 525 xi	07/05-12/10	N52 B25 A, N52 B25 A, N52 B25 B, N52 B25 BE, N52 B25 A, N53 B25 A, N52 B25, N52 B25 A	2497			0-N2128	VB [DG]
525 d	06/04-12/10	M57 D25 (256D2), M57 D25 TU, M57N 256 D4	2497			0-N1523	VB [TE]
525 d	06/04-12/10	M57 D25 (256D2), M57 D25 TU, M57N 256 D4	2497			0-N1790	VB [BT]
525 d	06/04-12/10	M57 D25 (256D2), M57 D25 TU, M57N 256 D4	2497			0-N1792	VB [DG]
525 d	06/04-12/10	M57 D25 (256D2), M57 D25 TU, M57N 256 D4	2497		für Fahrzeuge ohne aktive Stabilisatorregelung; für Fahrzeuge ohne Niveauregulierung	0-N1944	VB [DG]
525 d	06/04-12/10	M57 D25 TU	2497	→ 09/2004		0-N2074	VB [TE] S
525 d, 525 d xDrive, 525 xd, 530 d xDrive	01/07-12/10	M57	2993			0-N1523	VB [TE]
525 d, 525 d xDrive, 525 xd, 530 d xDrive	01/07-12/10	M57	2993			0-N1792	VB [DG]



CM³



Art. Nr.



5 Touring (E61)

525 d, 525 d xDrive, 525 xd, 530 d, 530 d xDrive, 530 xd, 535 d	06/04-12/10	M57 D30 (306D2), M57 D30 (306D3), M57 D30 (306D4), M57 D30 (306D5)	2993		0-N1790	VB [BT]	
525 d, 525 xd, 530 d, 530 d xDrive, 530 xd, 535 d	09/04-12/10	M57 D30 (306D3), M57 D30 (306D4), M57 D30 (306D5)	2993	für Fahrzeuge ohne aktive Stabilisatorregelung; für Fahrzeuge ohne Niveauregulierung	0-N1944	VB [DG]	
525 i	06/04-12/10	M54 B25 (256S5)	2494		0-N1290	VB [BT]	S
525 i	06/04-12/10	M54 B25 (256S5)	2494		0-N1293	VB [VD]	
525 i	06/04-12/10	M54 B25 (256S5)	2494		0-N1301	VB [TE]	
525 i	06/04-12/10	M54 B25 (256S5)	2494	†	0-N1453	VB [DG]	
525 i	06/04-12/10	M54 B25 (256S5)	2494		0-N1788	VB [BT]	S
525 i	06/04-12/10	M54 B25 (256S5)	2494		0-N1791	VB [BT]	S
525 i	06/04-12/10	M54 B25 (256S5)	2494		0-N1919	VB [BT]	S
525 i	06/04-12/10	M54 B25 (256S5)	2494	hydraulisch	0-N2135	VB [BT]	
525 i, 525 i xDrive, 525 xi, 530 i, 530 i xDrive, 530 xi	07/05-12/10	N52 B30 A, N52 B30 A, N52 B30 A, N52 B30 A, N53 B30 A, N52 B30, N52 B30 A, N53 B30 A, N53 B30, N53 B30 A	2996		0-N1788	VB [BT]	S
525 i, 525 i xDrive, 525 xi, 530 i, 530 i xDrive, 530 xi	07/05-12/10	N52 B30 A, N52 B30 A, N52 B30 A, N52 B30 A, N53 B30 A, N52 B30, N52 B30 A, N53 B30 A, N53 B30, N53 B30 A	2996		0-N2128	VB [DG]	
530 d	06/04-12/10	M57 D30 (306D2)	2993	→ 09/2004	0-N2074	VB [TE]	S
530 d, 530 xd, 535 d	06/04-12/10	M57 D30 (306D2), M57 D30 (306D3), M57 D30 (306D4), M57 D30 (306D5)	2993		0-N1523	VB [TE]	
530 d, 530 xd, 535 d	06/04-12/10	M57 D30 (306D2), M57 D30 (306D3), M57 D30 (306D4), M57 D30 (306D5)	2993		0-N1792	VB [DG]	
530 i	06/04-	M54 306 S3	2979		0-N1293	VB [VD]	
530 i	06/04-	M54 306 S3	2979		0-N1301	VB [TE]	
530 i	06/04-	M54 306 S3	2979	†	0-N1453	VB [DG]	
530 i	06/04-	M54 306 S3	2979		0-N1791	VB [BT]	S
530 i	06/04-	M54 306 S3	2979		0-N1919	VB [BT]	S
530 i	06/04-	M54 306 S3	2979	hydraulisch	0-N2135	VB [BT]	
545 i	06/04-12/10	N62 B44 A	4398		0-N1507	VB [BT]	S
545 i	06/04-12/10	N62 B44 A	4398		0-N1922	VB [BT]	
550 i	07/05-12/10	N62 B48 A, N62 B48 B	4799		0-N1507	VB [BT]	S
550 i	07/05-12/10	N62 B48 A, N62 B48 B	4799		0-N1922	VB [BT]	
M	02/07-12/10	S85 B50 A	4999		0-N1298	VB [DG]	

5 (F10, F18)

518 d, 520 d, 520 d xDrive, 525 d, 525 d xDrive	03/10-	N47 D20 C, N47 D20 D	1995		0-N2216	VB [BT]	
518 d, 520 d, 520 d xDrive, 525 d, 525 d xDrive	03/10-	N47 D20 C, N47 D20 D	1995		0-N2216S1	VB [DG]	
518 d, 520 d, 520 d xDrive, 525 d, 525 d xDrive	03/10-	N47 D20 C, N47 D20 D	1995		0-N2216S2	VB [DG]	
523 i	03/10-	N52 B25 A, N52 B25 AF, N52 B25 B, N52 B25 BF	2497		0-N2252	VB [BT]	S
523 i, 528 i, 530 i	12/09-	N53 B30 A	2996		0-N2252	VB [BT]	S
525 d	09/11-	N47 D20 D	1995		0-N1950	VB [DG]	
525 d	09/11-	N47 D20 D	1995		0-N1958	VB [BT]	S
525 d	09/11-	N47 D20 D	1995	für Fahrzeuge mit elektrischer Servolenkung	0-N2130	VB [DG]	
525 d, 530 d, 530 d xDrive, 535 d	12/09-	N57 D30 A, N57 D30 B	2993		0-N1950	VB [DG]	
525 d, 530 d, 530 d xDrive, 535 d	12/09-	N57 D30 A, N57 D30 B	2993		0-N1958	VB [BT]	S
525 d, 530 d, 530 d xDrive, 535 d	12/09-	N57 D30 A, N57 D30 B	2993	für Fahrzeuge mit aktiver Stabilisatorregelung	0-N2084	VB [BT]	S
525 d, 530 d, 530 d xDrive, 535 d	12/09-	N57 D30 A, N57 D30 B	2993	für Fahrzeuge mit elektrischer Servolenkung	0-N2130	VB [DG]	
535 d	08/10-	N57 D30 B	2993	für Fahrzeuge mit elektrischer Servolenkung, ⚙	0-N2130	VB [DG]	
535 d	08/10-	N57Z	2993	06/2011 →	0-N2216	VB [BT]	
535 d	08/10-	N57Z	2993	06/2011 →	0-N2216S1	VB [DG]	
535 d	08/10-	N57Z	2993	06/2011 →	0-N2216S2	VB [DG]	
535 d	08/10-	N57Z	2993	für Fahrzeuge mit aktiver Stabilisatorregelung; 06/2011 →	0-N2217	VB [BT]	
535 d	08/10-	N57Z	2993	für Fahrzeuge mit aktiver Stabilisatorregelung; 06/2011 →	0-N2217S1	VB [DG]	
535 d	08/10-	N57Z	2993	für Fahrzeuge mit aktiver Stabilisatorregelung; 06/2011 →	0-N2217S2	VB [DG]	
535 d xDrive, M 550 d xDrive	09/11-	N57 D30 B, N57 D30 C	2993		0-N2217	VB [BT]	
535 d xDrive, M 550 d xDrive	09/11-	N57 D30 B, N57 D30 C	2993		0-N2217S1	VB [DG]	
535 d xDrive, M 550 d xDrive	09/11-	N57 D30 B, N57 D30 C	2993		0-N2217S2	VB [DG]	
535 i, 535 i xDrive	12/09-	N55 B30 A	2979		0-N2371	VB [DG]	
535 i, 535 i xDrive, ActiveHybrid	12/09-	N55 B30 A	2979		0-N2370	VB [DG]	



CM³



Art. Nr.



5 Touring (F11)

518 d, 520 d, 520 d xDrive, 525 d, 525 d xDrive	09/10-	N47 D20 C, N47 D20 D	1995		0-N2216	VB [BT]	
518 d, 520 d, 520 d xDrive, 525 d, 525 d xDrive	09/10-	N47 D20 C, N47 D20 D	1995		0-N2216S1	VB [DG]	
518 d, 520 d, 520 d xDrive, 525 d, 525 d xDrive	09/10-	N47 D20 C, N47 D20 D	1995		0-N2216S2	VB [DG]	
523 i, 528 i, 530 i	09/10-	N53 B30 A	2996		0-N2252	VB [BT]	S
525 d	09/11-	N47 D20 D	1995		0-N1950	VB [DG]	
525 d	09/11-	N47 D20 D	1995		0-N1958	VB [BT]	S
525 d	09/11-	N47 D20 D	1995	für Fahrzeuge mit aktiver Stabilisatorregelung	0-N2084	VB [BT]	S
525 d	09/11-	N47 D20 D	1995	für Fahrzeuge mit elektrischer Servolenkung	0-N2130	VB [DG]	
525 d, 530 d, 530 d xDrive, 535 d, 535 d xDrive	09/10-	N57 D30 A, N57 D30 B	2993		0-N1950	VB [DG]	
525 d, 530 d, 530 d xDrive, 535 d, 535 d xDrive	09/10-	N57 D30 A, N57 D30 B	2993	für Fahrzeuge mit aktiver Stabilisatorregelung	0-N2084	VB [BT]	S
525 d, 530 d, 535 d, 535 d xDrive	09/10-	N57 D30 A, N57 D30 B	2993		0-N1958	VB [BT]	S
525 d, 530 d, 535 d, 535 d xDrive	09/10-	N57 D30 A, N57 D30 B	2993	für Fahrzeuge mit elektrischer Servolenkung	0-N2130	VB [DG]	
530 d xDrive	09/11-	N57 D30 A	2993	für Fahrzeuge ohne aktive Stabilisatorregelung	0-N1958	VB [BT]	S
530 d xDrive, M 550 d xDrive	09/11-	N57 D30 A, N57 D30 C	2993		0-N2217	VB [BT]	
530 d xDrive, M 550 d xDrive	09/11-	N57 D30 A, N57 D30 C	2993		0-N2217S1	VB [DG]	
530 d xDrive, M 550 d xDrive	09/11-	N57 D30 A, N57 D30 C	2993		0-N2217S2	VB [DG]	
535 d	09/10-	N57 D30 B	2993	für Fahrzeuge mit elektrischer Servolenkung, ☼	0-N2130	VB [DG]	
535 d	09/10-	N57Z	2993	06/2011 →	0-N2216	VB [BT]	
535 d	09/10-	N57Z	2993	06/2011 →	0-N2216S1	VB [DG]	
535 d	09/10-	N57Z	2993	06/2011 →	0-N2216S2	VB [DG]	
535 d	09/10-	N57Z	2993	für Fahrzeuge mit aktiver Stabilisatorregelung; 06/2011 →	0-N2217	VB [BT]	
535 d	09/10-	N57Z	2993	für Fahrzeuge mit aktiver Stabilisatorregelung; 06/2011 →	0-N2217S1	VB [DG]	
535 d	09/10-	N57Z	2993	für Fahrzeuge mit aktiver Stabilisatorregelung; 06/2011 →	0-N2217S2	VB [DG]	
535 d, 535 d xDrive	09/11-	N57 D30 B	2993		0-N2216	VB [BT]	
535 d, 535 d xDrive	09/11-	N57 D30 B	2993		0-N2216S1	VB [DG]	
535 d, 535 d xDrive	09/11-	N57 D30 B	2993		0-N2216S2	VB [DG]	
535 d, 535 d xDrive	09/11-	N57 D30 B	2993	für Fahrzeuge mit aktiver Stabilisatorregelung	0-N2217	VB [BT]	
535 d, 535 d xDrive	09/11-	N57 D30 B	2993	für Fahrzeuge mit aktiver Stabilisatorregelung	0-N2217S1	VB [DG]	
535 d, 535 d xDrive	09/11-	N57 D30 B	2993	für Fahrzeuge mit aktiver Stabilisatorregelung	0-N2217S2	VB [DG]	
535 i, 535 i xDrive	09/10-	N55 B30 A	2979		0-N2370	VB [DG]	
535 i, 535 i xDrive	09/10-	N55 B30 A	2979		0-N2371	VB [DG]	

535xi [USA]

535 xi	01/08-12/10		2979		0-N1621	VB [BT]	S
--------	-------------	--	------	--	----------------	---------	----------

5 GRAN TURISMO (F07)

520 d	10/11-	N47 D20 C	1995		0-N2216	VB [BT]	
520 d	10/11-	N47 D20 C	1995		0-N2216S1	VB [DG]	
520 d	10/11-	N47 D20 C	1995		0-N2216S2	VB [DG]	
530 d xDrive	09/10-	N57 D30 A	2993	für Fahrzeuge mit elektrischer Servolenkung	0-N2130	VB [DG]	
530 d, 530 d xDrive, 535 d, 535 d xDrive	10/09-	N57 D30 A, N57 D30 B	2993		0-N1950	VB [DG]	
530 d, 530 d xDrive, 535 d, 535 d xDrive	10/09-	N57 D30 A, N57 D30 B	2993		0-N1958	VB [BT]	S
530 d, 530 d xDrive, 535 d, 535 d xDrive	10/09-	N57 D30 A, N57 D30 B	2993	für Fahrzeuge mit aktiver Stabilisatorregelung	0-N2084	VB [BT]	S
535 d	09/10-	N57Z	2993	06/2012 →	0-N2216	VB [BT]	
535 d	09/10-	N57Z	2993	06/2012 →	0-N2216S1	VB [DG]	
535 d	09/10-	N57Z	2993	06/2012 →	0-N2216S2	VB [DG]	
535 d	09/10-	N57 D30 B	2993	für Fahrzeuge mit aktiver Stabilisatorregelung	0-N2217	VB [BT]	
535 d	09/10-	N57 D30 B	2993	für Fahrzeuge mit aktiver Stabilisatorregelung	0-N2217S1	VB [DG]	
535 d	09/10-	N57 D30 B	2993	für Fahrzeuge mit aktiver Stabilisatorregelung	0-N2217S2	VB [DG]	
535 d	02/12-	N57 D30 B	2993	→ 06/2012	0-N1950	VB [DG]	
535 d	02/12-	N57 D30 B	2993	für Fahrzeuge ohne aktive Stabilisatorregelung; → 06/2012	0-N1958	VB [BT]	S
535 d	02/12-	N57S	2993	für Fahrzeuge mit aktiver Stabilisatorregelung; → 06/2012	0-N2084	VB [BT]	S

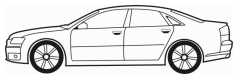

CM³



Art. Nr.



ohne Halter

5 GRAN TURISMO (F07)							
535 d	02/12-	N57Z	2993	06/2012 →		0-N2217	VB [BT]
535 d	02/12-	N57Z	2993	06/2012 →		0-N2217S1	VB [DG]
535 d	02/12-	N57Z	2993	06/2012 →		0-N2217S2	VB [DG]
535 d xDrive	09/10-	N57Z	2993	für Fahrzeuge mit aktiver Stabilisatorregelung; 01/2012 →		0-N2217	VB [BT]
535 d xDrive	09/10-	N57Z	2993	für Fahrzeuge mit aktiver Stabilisatorregelung; 01/2012 →		0-N2217S1	VB [DG]
535 d xDrive	09/10-	N57Z	2993	für Fahrzeuge mit aktiver Stabilisatorregelung; 01/2012 →		0-N2217S2	VB [DG]
535 d xDrive	02/12-	N57 D30 B	2993			0-N2217	VB [BT]
535 d xDrive	02/12-	N57 D30 B	2993			0-N2217S1	VB [DG]
535 d xDrive	02/12-	N57 D30 B	2993			0-N2217S2	VB [DG]
535 i, 535 i xDrive	10/09-	N55 B30 A	2979			0-N2370	VB [DG]
535 i, 535 i xDrive	10/09-	N55 B30 A	2979	für Fahrzeuge mit Stabilisator		0-N2371	VB [DG]
6 (E63)							
630 i	09/04-07/10	N52 B30 B, N52 B30 BF, N53 B30 A, N53 B30 A, N52 B30, N52 B30 A	2996			0-N1788	VB [BT] S
630 i	09/04-07/10	N52 B30 B, N52 B30 BF, N53 B30 A, N53 B30 A, N52 B30, N52 B30 A	2996			0-N2128	VB [DG]
635 d	07/07-07/10	M57	2993			0-N1523	VB [TE]
635 d	07/07-07/10	M57 D30 (306D5)	2993			0-N1790	VB [BT]
635 d	07/07-07/10	M57	2993			0-N1792	VB [DG]
635 d	07/07-07/10	M57 D30 (306D5)	2993	für Fahrzeuge ohne Niveauregulierung		0-N1944	VB [DG]
645 Ci	01/04-08/05	N62 B44 A, N62 B44 A	4398			0-N1507	VB [BT] S
645 Ci	01/04-08/05	N62 B44 A, N62 B44 A	4398			0-N1922	VB [BT]
650 i	07/05-07/10	N62 B48 B	4799			0-N1507	VB [BT] S
650 i	07/05-07/10	N62 B48 B	4799			0-N1922	VB [BT]
M	09/05-07/10	S85 B50 A	4999			0-N1298	VB [DG]
6 Cabriolet (E64)							
630 i	09/04-07/10	N52 B30 B, N52 B30 BF, N53 B30 A, N53 B30 A, N52 B30, N52 B30 A	2996			0-N1788	VB [BT] S
630 i	09/04-07/10	N52 B30 B, N52 B30 BF, N53 B30 A, N53 B30 A, N52 B30, N52 B30 A	2996			0-N2128	VB [DG]
635 d	07/07-07/10	M57 D30 (306D5)	2993			0-N1523	VB [TE]
635 d	07/07-07/10	M57 D30 (306D5)	2993			0-N1790	VB [BT]
635 d	07/07-07/10	M57 D30 (306D5)	2993			0-N1792	VB [DG]
635 d	07/07-07/10	M57 D30 (306D5)	2993	für Fahrzeuge ohne Niveauregulierung		0-N1944	VB [DG]
645 Ci	04/04-08/05	N62 B44 A, N62 B44 A	4398			0-N1507	VB [BT] S
645 Ci	04/04-08/05	N62 B44 A, N62 B44 A	4398			0-N1922	VB [BT]
650 i	07/05-07/10	N62 B48 B	4799			0-N1507	VB [BT] S
650 i	07/05-07/10	N62 B48 B	4799			0-N1922	VB [BT]
M	07/06-07/10	S85 B50 A	4999			0-N1298	VB [DG]
6 Cabriolet (F12)							
640 d	09/11-	N57 D30 B	2993			0-N2216	VB [BT]
640 d	09/11-	N57 D30 B	2993			0-N2216S1	VB [DG]
640 d	09/11-	N57 D30 B	2993			0-N2216S2	VB [DG]
640 d	09/11-	N57 D30 B	2993	für Fahrzeuge mit aktiver Stabilisatorregelung		0-N2217	VB [BT]
640 d	09/11-	N57 D30 B	2993	für Fahrzeuge mit aktiver Stabilisatorregelung		0-N2217S1	VB [DG]
640 d	09/11-	N57 D30 B	2993	für Fahrzeuge mit aktiver Stabilisatorregelung		0-N2217S2	VB [DG]
640 d xDrive	09/11-	N57 D30 B	2993			0-N2217	VB [BT]
640 d xDrive	09/11-	N57 D30 B	2993			0-N2217S1	VB [DG]
640 d xDrive	09/11-	N57 D30 B	2993			0-N2217S2	VB [DG]
640 i, 640 i xDrive	03/11-	N55 B30 A	2979			0-N2370	VB [DG]
640 i, 640 i xDrive	03/11-	N55 B30 A	2979	für Fahrzeuge mit Stabilisator		0-N2371	VB [DG]
6 Coupe (F13)							
640 d	11/10-	N57 D30 B	2993			0-N2216	VB [BT]
640 d	11/10-	N57 D30 B	2993			0-N2216S1	VB [DG]
640 d	11/10-	N57 D30 B	2993			0-N2216S2	VB [DG]
640 d	11/10-	N57 D30 B	2993	für Fahrzeuge mit aktiver Stabilisatorregelung		0-N2217	VB [BT]
640 d	11/10-	N57 D30 B	2993	für Fahrzeuge mit aktiver Stabilisatorregelung		0-N2217S1	VB [DG]
640 d	11/10-	N57 D30 B	2993	für Fahrzeuge mit aktiver Stabilisatorregelung		0-N2217S2	VB [DG]



CM³



Art. Nr.



ohne Halter

6 Coupe (F13)

640 d xDrive	09/11-	N57 D30 B	2993		0-N2217	VB [BT]	
640 d xDrive	09/11-	N57 D30 B	2993		0-N2217S1	VB [DG]	
640 d xDrive	09/11-	N57 D30 B	2993		0-N2217S2	VB [DG]	
640 i	11/10-	N55 B30 A	2979		0-N2370	VB [DG]	
640 i xDrive	01/13-	N55 B30 A	2979	für Fahrzeuge mit Stabilisator	0-N2370	VB [DG]	
640 i, 640 i xDrive	11/10-	N55 B30 A	2979	für Fahrzeuge mit Stabilisator	0-N2371	VB [DG]	

6 Gran Coupe (F06)

640 d	09/11-	N57 D30 B	2993		0-N2216	VB [BT]	
640 d	09/11-	N57 D30 B	2993		0-N2216S1	VB [DG]	
640 d	09/11-	N57 D30 B	2993		0-N2216S2	VB [DG]	
640 d	09/11-	N57 D30 B	2993	für Fahrzeuge mit aktiver Stabilisatorregelung	0-N2217	VB [BT]	
640 d	09/11-	N57 D30 B	2993	für Fahrzeuge mit aktiver Stabilisatorregelung	0-N2217S1	VB [DG]	
640 d	09/11-	N57 D30 B	2993	für Fahrzeuge mit aktiver Stabilisatorregelung	0-N2217S2	VB [DG]	
640 i, 640 i xDrive	09/11-	N55 B30 A	2979		0-N2370	VB [DG]	
640 i, 640 i xDrive	09/11-	N55 B30 A	2979	für Fahrzeuge mit Stabilisator	0-N2371	VB [DG]	

7 (E32)

730 i,iL	12/86-09/94	M30 B30 (306EA), M30 B30 (306KA)	2986		0-N1296	VB [TE]	
730 i,iL	12/86-09/94	M30 B30 (306EA), M30 B30 (306KA)	2986		0-N1297	VB [DG]	
730 i,iL	12/86-09/94	M30 B30 (306EA), M30 B30 (306KA)	2986		0-N1585	VB [TE]	S
730 i,iL V8	04/92-09/94	M60 B30 (308S1)	2997		0-N1296	VB [TE]	
730 i,iL V8	04/92-09/94	M60 B30 (308S1)	2997		0-N1297	VB [DG]	
730 i,iL V8	04/92-09/94	M60 B30 (308S1)	2997		0-N1585	VB [TE]	S
730 i,iL V8	04/92-09/94	M60 B30 (308S1)	2997		0-N2140	VB [TE]	
730 i,iL V8	04/92-09/94	M60 B30 (308S1)	2997		0-N2411	VB [VD]	
740 i,iL V8	04/92-09/94	M60 B40 (408S1), M60 B40 (408S1)	3982		0-N1296	VB [TE]	
740 i,iL V8	04/92-09/94	M60 B40 (408S1), M60 B40 (408S1)	3982		0-N1297	VB [DG]	
740 i,iL V8	04/92-09/94	M60 B40 (408S1), M60 B40 (408S1)	3982		0-N1585	VB [TE]	S
740 i,iL V8	04/92-09/94	M60 B40 (408S1), M60 B40 (408S1)	3982		0-N2140	VB [TE]	
740 i,iL V8	04/92-09/94	M60 B40 (408S1), M60 B40 (408S1)	3982		0-N2411	VB [VD]	
750 i,iL V12	09/87-09/94	M70 B50 (5012A), M70 B50 (5012A)	4988		0-N1295	VB [BT]	S
750 i,iL V12	09/87-09/94	M70 B50 (5012A), M70 B50 (5012A)	4988		0-N2409	VB [VD]	

7 (E38)

725 tds	04/96-11/01	M51 D25 (256T1)	2503		0-N1304	VB [TE]	
725 tds	04/96-11/01	M51 D25 (256T1)	2503		0-N1305	VB [DG]	
725 tds	04/96-11/01	M51 D25 (256T1)	2503	☼	0-N1514	VB [BT]	S
728 i,iL	08/95-11/01	M52 B28 (286S1), M52 B28 (286S1), M52 B28 (286S2), M52 B28 (286S2)	2793		0-N1293	VB [VD]	
728 i,iL	08/95-11/01	M52 B28 (286S1), M52 B28 (286S1), M52 B28 (286S2), M52 B28 (286S2)	2793	hydraulisch	0-N1298	VB [DG]	
728 i,iL	08/95-11/01	M52 B28 (286S1), M52 B28 (286S1), M52 B28 (286S2), M52 B28 (286S2)	2793		0-N1919	VB [BT]	S
728 i,iL	08/95-11/01	M52 B28 (286S1), M52 B28 (286S1), M52 B28 (286S2), M52 B28 (286S2)	2793	→ 04/1998	0-N1974	VB [VD]	
728 i,iL, 728i X	08/95-11/01	M52 B28 (286S1), M52 B28 (286S1), M52 B28 (286S2), M52 B28 (286S2), M52 B28 (286S1), M52 B28 TU	2793		0-N1290	VB [BT]	S
728 i,iL, 728i X	08/95-11/01	M52 B28 (286S1), M52 B28 (286S1), M52 B28 (286S2), M52 B28 (286S2), M52 B28 (286S1), M52 B28 TU	2793	05/1998 →	0-N1291	VB [BT]	S
728 i,iL, 728i X	08/95-11/01	M52 B28 (286S1), M52 B28 (286S1), M52 B28 (286S2), M52 B28 (286S2), M52 B28 (286S1), M52 B28 TU	2793	→ 04/1998	0-N1301	VB [TE]	
728 i,iL, 728i X	08/95-11/01	M52 B28 (286S1), M52 B28 (286S1), M52 B28 (286S2), M52 B28 (286S2), M52 B28 (286S1), M52 B28 TU	2793	→ 04/1998	0-N1559S	VB [TE]	
730 d	08/98-04/00	M57 D30 (306D1)	2926		0-N1396	VB [DG]	
730 d	08/98-11/01	M57 D30 (306D1)	2926		0-N1834	VB [BT]	S
730 d	08/98-04/00	M57 D30 (306D1)	2926		0-N1900	VB [BT]	
730 d	08/98-11/01	M57 D30 (306D1)	2926		0-N1912	VB [BT]	S
730 d	08/98-11/01	M57 D30 (306D1)	2926		0-N1923	VB [BT]	
730 d	08/98-04/00	M57 D30 (306D1)	2926		0-N1940	VB [BT]	S
730 d	04/00-11/01	M57 D30 (306D1)	2926	→ 10/2000	0-N1940	VB [BT]	S
730 i,iL	10/94-11/01	M60 B30 (308S1)	2997		0-N1296	VB [TE]	
730 i,iL	10/94-11/01	M60 B30 (308S1)	2997		0-N1297	VB [DG]	
730 i,iL	10/94-11/01	M60 B30 (308S1)	2997		0-N1585	VB [TE]	S



CM³



Art. Nr.



7 (E38)							
730 i,iL	10/94-11/01	M60 B30 (308S1)	2997			0-N2140	VB [TE]
730 i,iL	10/94-11/01	M60 B30 (308S1)	2997			0-N2411	VB [VD]
735 i,iL	01/96-11/01	M62 B35, M62 B35 (358S1)	3498			0-N1296	VB [TE]
735 i,iL	01/96-11/01	M62 B35, M62 B35 (358S1)	3498	05/1997 → 04/1998		0-N1299	VB [BT] S
735 i,iL	01/96-11/01	M62 B35, M62 B35 (358S1)	3498	05/1997 →		0-N1300	VB [TE] S
735 i,iL	01/96-11/01	M62 B35, M62 B35 (358S1)	3498	05/1997 →		0-N1506	VB [BT] S
735 i,iL	01/96-11/01	M62 B35	3498			0-N1527	VB [BT] S
735 i,iL	01/96-11/01	M62 B35, M62 B35 (358S1)	3498	→ 04/1997		0-N1585	VB [TE] S
735 i,iL	01/96-11/01	M62 B35, M62 B35 (358S1)	3498	→ 04/1997		0-N1586	VB [DG]
735 i,iL	01/96-11/01	M62 B35, M62 B35 (358S1)	3498	09/1998 →		0-N1669	VB [BT] S
735 i,iL	01/96-11/01	M62 B35, M62 B35 (358S1)	3498	05/1997 →		0-N1787	VB [VD]
735 i,iL	01/96-11/01	M62 B35, M62 B35 (358S1)	3498	05/1997 →		0-N2410	VB [VD]
740 d	05/99-11/01	M67 D39 (398D1)	3901			0-N1513	VB [BT] S
740 i,iL	10/94-11/01	M60 B40 (408S1), M60 B40 (408S1)	3982			0-N1296	VB [TE]
740 i,iL	10/94-11/01	M60 B40 (408S1), M60 B40 (408S1)	3982			0-N1297	VB [DG]
740 i,iL	10/94-11/01	M60 B40 (408S1), M60 B40 (408S1)	3982			0-N1585	VB [TE] S
740 i,iL	10/94-11/01	M60 B40 (408S1), M60 B40 (408S1)	3982			0-N2140	VB [TE]
740 i,iL	10/94-11/01	M60 B40 (408S1), M60 B40 (408S1)	3982			0-N2411	VB [VD]
740 i,iL	01/96-11/01	M62 B44 (448S1), M62 B44 (448S2)	4398			0-N1296	VB [TE]
740 i,iL	01/96-11/01	M62 B44 (448S1), M62 B44 (448S2)	4398			0-N1297	VB [DG]
740 i,iL	01/96-11/01	M62 B44 (448S1), M62 B44 (448S2)	4398	05/1997 → 04/1998		0-N1299	VB [BT] S
740 i,iL	01/96-11/01	M62 B44 (448S1), M62 B44 (448S2)	4398	05/1997 →		0-N1300	VB [TE] S
740 i,iL	01/96-11/01	M62 B44 (448S1), M62 B44 (448S2)	4398	05/1997 →		0-N1506	VB [BT] S
740 i,iL	01/96-11/01	M62 B44 (448S1), M62 B44 (448S2)	4398			0-N1527	VB [BT] S
740 i,iL	01/96-11/01	M62 B44 (448S1), M62 B44 (448S2)	4398	→ 04/1997		0-N1585	VB [TE] S
740 i,iL	01/96-11/01	M62 B44 (448S1), M62 B44 (448S2)	4398	→ 04/1997		0-N1586	VB [DG]
740 i,iL	01/96-11/01	M62 B44 (448S1), M62 B44 (448S2)	4398	09/1998 →		0-N1669	VB [BT] S
740 i,iL	01/96-11/01	M62 B44 (448S1), M62 B44 (448S2)	4398	05/1997 →		0-N1787	VB [VD]
740 i,iL	01/96-11/01	M62 B44 (448S1), M62 B44 (448S2)	4398	05/1997 →		0-N2410	VB [VD]
750 i,iL	12/94-11/01	M73 B54 (54121), M73 B54 (54122), M73 B54 (54122)	5379			0-N1295	VB [BT] S
750 i,iL	12/94-11/01	M73 B54 (54121), M73 B54 (54122), M73 B54 (54122)	5379			0-N1741	VB [BT] S
750 i,iL	12/94-11/01	M73 B54 (54121), M73 B54 (54122), M73 B54 (54122)	5379			0-N2411	VB [VD]
7 (E65, E66, E67)							
3.0 730 i, Li, 730 i, Li	03/05-07/08	N52 B30 A, N52 B30, N52 B30 A	2996			0-N1788	VB [BT] S
730 d	10/02-07/08	M57 D30 (306D2)	2993			0-N2075	VB [BT]
730 d, 730 Ld	10/02-12/09	M57 D30 (306D2), M57 D30 (306D3), M57 D30 (306D3), M57 D30 (306D3)	2993			0-N1523	VB [TE]
730 d, 730 Ld	10/02-12/09	M57 D30 (306D2), M57 D30 (306D3), M57 D30 (306D3), M57 D30 (306D3)	2993			0-N1790	VB [BT]
730 d, 730 Ld	10/02-12/09	M57 D30 (306D2), M57 D30 (306D3), M57 D30 (306D3), M57 D30 (306D3)	2993			0-N1792	VB [DG]
730 i, Li	03/03-07/08	M54 B30 (306S3)	2979			0-N1290	VB [BT] S
730 i, Li	03/03-07/08	M54 B30 (306S3)	2979			0-N1453	VB [DG]
730 i, Li	03/03-07/08	M54 B30 (306S3)	2979			0-N1791	VB [BT] S
730 i, Li	03/03-07/08	M54 B30 (306S3)	2979			0-N1919	VB [BT] S
730 i, Li	03/05-07/08	N52 B30, N52 B30 A	2996			0-N2128	VB [DG]
735 i	03/05-12/09	N62 B40 A	3999			0-N1507	VB [BT] S
735 i	03/05-12/09	N62 B40 A	3999			0-N1922	VB [BT]
735 i, Li	11/01-02/05	N62 B36 A	3600			0-N1507	VB [BT] S
735 i, Li	11/01-02/05	N62 B36 A	3600			0-N1512	VB [BT] S
735 i, Li	11/01-02/05	N62 B36 A	3600	→ 09/2003		0-N1668	VB [DG] S
735 i, Li	11/01-02/05	N62 B36 A	3600	09/2003 →		0-N1922	VB [BT]
740 d	10/02-02/05	M67 D39 (398D1)	3901			0-N1515	VB [BT] S
740 d	10/02-02/05	M67 D39 (398D1)	3901			0-N1516	VB [BT] S
740 d	10/02-02/05	M67 D39 (398D1)	3901			0-N1792	VB [DG]
740 d	10/02-02/05	M67 D39 (398D1)	3901			0-N2126	VB [DG]
740 i, Li	07/05-07/08	N62 B40 A	4000			0-N1507	VB [BT] S
740 i, Li	07/05-07/08	N62 B40 A	4000			0-N1922	VB [BT]
745 d	03/05-07/08	M67 D44 (448D1), M67 D44 (448D1), M67 D44 (448D1)	4423			0-N1792	VB [DG]
745 d	07/05-07/08	M67 D44 (448D1), M67 D44 (448D1)	4423			0-N1515	VB [BT] S
745 d	07/05-07/08	M67 D44 (448D1), M67 D44 (448D1)	4423			0-N1516	VB [BT] S
745 i, Li	11/01-07/08	N62 B44 A, N62 B44 A	4398			0-N1507	VB [BT] S
745 i, Li	11/01-07/08	N62 B44 A, N62 B44 A	4398			0-N1512	VB [BT] S

CM³

Art. Nr.

**7 (E65, E66, E67)**

745i, Li	11/01-07/08	N62 B44 A, N62 B44 A	4398	→ 09/2003	0-N1668	VB [DG]	S
745i, Li	11/01-07/08	N62 B44 A, N62 B44 A	4398	09/2003 →	0-N1922	VB [BT]	
750i, Li	07/05-07/08	N62 B48 B	4799		0-N1507	VB [BT]	S
750i, Li	07/05-07/08	N62 B48 B	4799		0-N1922	VB [BT]	
760i, Li	01/03-07/08	N73 B60, N73 B60 A	5972		0-N1507	VB [BT]	S
760i, Li	01/03-07/08	N73 B60, N73 B60 A	5972		0-N1512	VB [BT]	S
760i, Li	01/03-07/08	N73 B60, N73 B60 A	5972		0-N1668	VB [DG]	S

7 (F01, F02, F03, F04)

730 d	10/08-12/15	N57 D30 A	2993	für Fahrzeuge mit elektrischer Servolenkung	0-N2130	VB [DG]	
730 d	07/09-12/15	N57 D30 A	2993	für Fahrzeuge ohne aktive Stabilisatorregelung	0-N1958	VB [BT]	S
730 d, 730 d xDrive, 740 d	07/12-12/15	N57 D30 A, N57 D30 B	2993	für Fahrzeuge mit aktiver Stabilisatorregelung	0-N2217	VB [BT]	
730 d, 730 d xDrive, 740 d	07/12-12/15	N57 D30 A, N57 D30 B	2993	für Fahrzeuge mit aktiver Stabilisatorregelung	0-N2217S1	VB [DG]	
730 d, 730 d xDrive, 740 d	07/12-12/15	N57 D30 A, N57 D30 B	2993	für Fahrzeuge mit aktiver Stabilisatorregelung	0-N2217S2	VB [DG]	
730 d, 730 d xDrive, 740 d, 740 d xDrive	07/12-12/15	N57 D30 A, N57 D30 B	2993		0-N2216	VB [BT]	
730 d, 730 d xDrive, 740 d, 740 d xDrive	07/12-12/15	N57 D30 A, N57 D30 B	2993		0-N2216S1	VB [DG]	
730 d, 730 d xDrive, 740 d, 740 d xDrive	07/12-12/15	N57 D30 A, N57 D30 B	2993		0-N2216S2	VB [DG]	
730 d, 740 d, 740 d xDrive	10/08-12/15	N57 D30 A, N57 D30 B	2993		0-N1950	VB [DG]	
730 d, 740 d, 740 d xDrive	10/08-12/15	N57 D30 A, N57 D30 B	2993		0-N1958	VB [BT]	S
730 d, 740 d, 740 d xDrive	10/08-12/15	N57 D30 A, N57 D30 B	2993	für Fahrzeuge mit aktiver Stabilisatorregelung	0-N2084	VB [BT]	S
730 i	06/08-12/15	N52 B30 A, N52 B30 BF	2996		0-N2252	VB [BT]	S
730 i	06/08-12/15	N52 B30 A, N52 B30 BF	2996		0-N2278	VB [DG]	
740 d xDrive, 750 d xDrive	07/12-12/15	N57 D30 B, N57 D30 C	2993		0-N2217	VB [BT]	
740 d xDrive, 750 d xDrive	07/12-12/15	N57 D30 B, N57 D30 C	2993		0-N2217S1	VB [DG]	
740 d xDrive, 750 d xDrive	07/12-12/15	N57 D30 B, N57 D30 C	2993		0-N2217S2	VB [DG]	
740 i, 740 i, Li xDrive	07/12-12/15	N55 B30 A	2979	für Fahrzeuge mit Stabilisator	0-N2371	VB [DG]	
740 i, 740 i, Li xDrive, ActiveHybrid	07/12-12/15	N55 B30 A	2979		0-N2370	VB [DG]	

8 (E31)

840 Ci	01/96-12/99	M62 B44 (448S1), M62 B44 (448S1), M62 B44 TU	4398		0-N1296	VB [TE]	
840 Ci	01/96-12/99	M62 B44 (448S1), M62 B44 (448S1), M62 B44 TU	4398	05/1997 → 04/1998	0-N1299	VB [BT]	S
840 Ci	01/96-12/99	M62 B44 (448S1), M62 B44 (448S1), M62 B44 TU	4398	05/1997 →	0-N1300	VB [TE]	S
840 Ci	01/96-12/99	M62 B44 (448S1), M62 B44 (448S1), M62 B44 TU	4398	05/1997 →	0-N1506	VB [BT]	S
840 Ci	01/96-12/99	M62 B44 (448S1), M62 B44 (448S1), M62 B44 TU	4398	05/1997 → 04/1998	0-N1527	VB [BT]	S
840 Ci	01/96-12/99	M62 B44 (448S1), M62 B44 (448S1), M62 B44 TU	4398	→ 04/1997	0-N1585	VB [TE]	S
840 Ci	01/96-12/99	M62 B44 (448S1), M62 B44 (448S1), M62 B44 TU	4398	→ 04/1997	0-N1586	VB [DG]	
840 Ci	01/96-12/99	M62 B44 (448S1), M62 B44 (448S1), M62 B44 TU	4398	05/1997 →	0-N1787	VB [VD]	
840 Ci	01/96-12/99	M62 B44 (448S1), M62 B44 (448S1), M62 B44 TU	4398	05/1997 →	0-N2410	VB [VD]	
840 i	02/93-02/96	M60 B40 (408S1), M60 B40 (408S1)	3982		0-N1296	VB [TE]	
840 i	02/93-02/96	M60 B40 (408S1), M60 B40 (408S1)	3982		0-N1297	VB [DG]	
840 i	02/93-02/96	M60 B40 (408S1), M60 B40 (408S1)	3982		0-N1585	VB [TE]	S
840 i	02/93-02/96	M60 B40 (408S1), M60 B40 (408S1)	3982		0-N2140	VB [TE]	
840 i	02/93-02/96	M60 B40 (408S1), M60 B40 (408S1)	3982		0-N2411	VB [VD]	
850 Ci	09/94-12/99	M73 B54 (54121), M73 B54 (54121)	5379		0-N1295	VB [BT]	S
850 Ci	09/94-12/99	M73 B54 (54121), M73 B54 (54121)	5379		0-N1741	VB [BT]	S
850 Ci	09/94-12/99	M73 B54 (54121), M73 B54 (54121)	5379		0-N2411	VB [VD]	
850 CSi	04/93-12/96	S70 B56 (56121)	5576		0-N1295	VB [BT]	S
850 CSi	04/93-12/96	S70 B56 (56121)	5576		0-N2409	VB [VD]	
850 i, Ci	04/90-10/94	M70 B50 (5012A), M70 B50 (5012A)	4988		0-N1295	VB [BT]	S
850 i, Ci	04/90-10/94	M70 B50 (5012A), M70 B50 (5012A)	4988		0-N2409	VB [VD]	

X1 (E84)

sDrive 16 d, sDrive 20 d	04/12-06/15	N47 D20 C	1995		0-N2216	VB [BT]	
sDrive 16 d, sDrive 20 d	04/12-06/15	N47 D20 C	1995		0-N2216S1	VB [DG]	
sDrive 16 d, sDrive 20 d	04/12-06/15	N47 D20 C	1995		0-N2216S2	VB [DG]	
sDrive 18 d	03/09-06/15	N47N	1995	11/2011 →; für Fahrzeuge mit elektrischer Servolenkung	0-N2216	VB [BT]	



CM³



Art. Nr.



X1 (E84)							
sDrive 18 d	03/09-06/15	N47N	1995	11/2011 →; für Fahrzeuge mit elektrischer Servolenkung	0-N2216S1	VB [DG]	
sDrive 18 d	03/09-06/15	N47N	1995	11/2011 →; für Fahrzeuge mit elektrischer Servolenkung	0-N2216S2	VB [DG]	
sDrive 18 d, sDrive 20 d	10/09-06/15	N47N	1995	11/2011 →	0-N2216	VB [BT]	
sDrive 18 d, sDrive 20 d	10/09-06/15	N47N	1995	11/2011 →	0-N2216S1	VB [DG]	
sDrive 18 d, sDrive 20 d	10/09-06/15	N47N	1995	11/2011 →	0-N2216S2	VB [DG]	
sDrive 18 d, sDrive 20 d, xDrive 18 d, xDrive 20 d, xDrive 23 d	03/09-06/15	N47 D20 C, N47 D20 C, N47S D20 D	1995		0-N1950	VB [DG]	
sDrive 18 d, sDrive 20 d, xDrive 18 d, xDrive 20 d, xDrive 23 d	03/09-06/15	N47 D20 C, N47 D20 C, N47S D20 D	1995		0-N1958	VB [BT]	S
sDrive 18 i	01/10-06/15	N46 B20 B	1995		0-N1794	VB [BT]	S
xDrive 20 d, xDrive 25 d	10/09-06/15	N47 D20 C, N47 D20 D	1995		0-N2217	VB [BT]	
xDrive 20 d, xDrive 25 d	10/09-06/15	N47 D20 C, N47 D20 D	1995		0-N2217S1	VB [DG]	
xDrive 20 d, xDrive 25 d	10/09-06/15	N47 D20 C, N47 D20 D	1995		0-N2217S2	VB [DG]	
xDrive 25 i, xDrive 28 i	10/09-06/15	N52 B30 A	2996		0-N1788	VB [BT]	S
xDrive 25 i, xDrive 28 i	10/09-06/15	N52 B30 A	2996		0-N2128	VB [DG]	

X3 (E83)							
2.0 d	10/04-12/10	M47 D20 (204D4)	1995		0-N1523	VB [TE]	
2.0 d	10/04-12/10	M47 D20 (204D4)	1995		0-N1790	VB [BT]	
2.0 d	10/04-12/10	M47 D20 (204D4)	1995		0-N1792	VB [DG]	
2.0 d, xDrive 18 d, xDrive 20 d	09/07-12/11	N47 D20 A, N47 D20 C, N47 D20 C	1995		0-N1950	VB [DG]	
2.0 d, xDrive 18 d, xDrive 20 d	09/07-12/11	N47 D20 A, N47 D20 C, N47 D20 C	1995		0-N2084	VB [BT]	S
2.0 i	07/05-08/08	N46 B20 B, N46 B20 B	1995	*	0-N1505S	VB [DG]	
2.0 i, xDrive 20 i	07/05-08/11	N46 B20 B, N46 B20 B, N46 B20 B	1995		0-N1794	VB [BT]	S
2.5 i	01/04-08/06	M54 B25 (256S5)	2494		0-N1290	VB [BT]	S
2.5 i	01/04-08/06	M54 B25 (256S5)	2494		0-N1293	VB [VD]	
2.5 i	01/04-08/06	M54 B25 (256S5)	2494		0-N1301	VB [TE]	
2.5 i	01/04-08/06	M54 B25 (256S5)	2494	†	0-N1453	VB [DG]	
2.5 i	01/04-08/06	M54 B25 (256S5)	2494		0-N1791	VB [BT]	S
2.5 i	01/04-08/06	M54 B25 (256S5)	2494		0-N1919	VB [BT]	S
2.5 i	01/04-08/06	M54 B25 (256S5)	2494	hydraulisch	0-N2135	VB [BT]	
2.5 si, xDrive 25 i	09/06-12/11	N52 B25 A	2497		0-N1788	VB [BT]	S
2.5 si, xDrive 25 i	09/06-12/11	N52 B25 A	2497		0-N2128	VB [DG]	
3.0 d	01/04-08/08	M57 D30 (306D2), M57 D30 (306D3), M57 D30 (306D3)	2993	→ 09/2004	0-N2075	VB [BT]	
3.0 d, 3.0 sd, xDrive 30 d	01/04-04/11	M57 D30 (306D2), M57 D30 (306D3), M57 D30 (306D3), M57 D30 (306D3), M57 D30 (306D3), M57 D30 (306D5)	2993		0-N1790	VB [BT]	
3.0 d, 3.0 sd, xDrive 30 d	01/04-04/11	M57 D30 (306D2), M57 D30 (306D3), M57 D30 (306D3), M57 D30 (306D3), M57 D30 (306D3), M57 D30 (306D5)	2993		0-N1792	VB [DG]	
3.0 d, 3.0 sd, xDrive 30 d, xDrive 35 d	01/04-08/11	M57 D30 (306D2), M57 D30 (306D3), M57 D30 (306D3), M57 D30 (306D3), M57 D30 (306D5)	2993		0-N1523	VB [TE]	
3.0 i	01/04-08/06	M54 B30 (306S3)	2979		0-N1290	VB [BT]	S
3.0 i	01/04-08/06	M54 B30 (306S3)	2979		0-N1293	VB [VD]	
3.0 i	01/04-08/06	M54 B30 (306S3)	2979		0-N1301	VB [TE]	
3.0 i	01/04-08/06	M54 B30 (306S3)	2979	†	0-N1453	VB [DG]	
3.0 i	01/04-08/06	M54 B30 (306S3)	2979		0-N1791	VB [BT]	S
3.0 i	01/04-08/06	M54 B30 (306S3)	2979		0-N1919	VB [BT]	S
3.0 i	01/04-08/06	M54 B30 (306S3)	2979	hydraulisch	0-N2135	VB [BT]	
3.0 si, xDrive 30 i	09/06-12/11	N52 B30 A	2996		0-N1788	VB [BT]	S
3.0 si, xDrive 30 i	09/06-12/11	N52 B30 A	2996		0-N2128	VB [DG]	
xDrive 18 d	09/08-12/11	N47	1995		0-N1950	VB [DG]	

X3 (F25)							
sDrive 18 d, sDrive 18d, xDrive 20 d	09/10-	B47 D20 A, N47 D20 C	1995		0-N2216	VB [BT]	
sDrive 18 d, sDrive 18d, xDrive 20 d	09/10-	B47 D20 A, N47 D20 C	1995		0-N2216S1	VB [DG]	
sDrive 18 d, sDrive 18d, xDrive 20 d	09/10-	B47 D20 A, N47 D20 C	1995		0-N2216S2	VB [DG]	
xDrive 28 i	04/11-	N52 B30 A	2996		0-N2252	VB [BT]	S
xDrive 30 d, xDrive 35 d	05/11-	N57 D30 A, N57 D30 B	2993		0-N2216	VB [BT]	
xDrive 30 d, xDrive 35 d	05/11-	N57 D30 A, N57 D30 B	2993		0-N2216S1	VB [DG]	
xDrive 30 d, xDrive 35 d	05/11-	N57 D30 A, N57 D30 B	2993		0-N2216S2	VB [DG]	
xDrive 35 i	09/10-	N55 B30 A	2979		0-N2370	VB [DG]	

X4 (F26)							
xDrive 35 i	04/14-	N55 B30 A	2979		0-N2370	VB [DG]	



CM³



Art. Nr.



X5 (E53)							
3.0 d	05/01-12/03	M57 D30 (306D1)	2925			0-N1396	VB [DG]
3.0 d	05/01-12/03	M57 D30 (306D1)	2925			0-N1834	VB [BT] S
3.0 d	05/01-12/03	M57 D30 (306D1)	2925			0-N1900	VB [BT]
3.0 d	05/01-12/03	M57 D30 (306D1)	2925			0-N1912	VB [BT] S
3.0 d	05/01-12/03	M57 D30 (306D1)	2925			0-N1923	VB [BT]
3.0 d	09/03-12/06	M57 D30 (306D2), M57 D30 (306D2), M57 D30 (306D2)	2993			0-N1523	VB [TE]
3.0 d	09/03-12/06	M57N	2993			0-N1790	VB [BT]
3.0 d	09/03-12/06	M57N	2993			0-N1792	VB [DG]
3.0 d	09/03-12/06	M57 D30 (306D2)	2993			0-N2075	VB [BT]
3.0 d	12/03-12/06	M57 D30 (306D2), M57 D30 (306D2)	2993			0-N1790	VB [BT]
3.0 d	12/03-12/06	M57 D30 (306D2), M57 D30 (306D2)	2993			0-N1792	VB [DG]
3.0 d	12/03-12/06	M57 D30 (306D2), M57 D30 (306D2)	2993	→ 09/2004		0-N2074	VB [TE] S
3.0 d	12/03-12/06	M57 D30 (306D2), M57 D30 (306D2)	2993	→ 09/2004		0-N2075	VB [BT]
3.0 i	05/00-12/06	M54 B30 (306S3)	2979			0-N1290	VB [BT] S
3.0 i	05/00-12/06	M54 B30 (306S3)	2979	→ 09/2002		0-N1291	VB [BT] S
3.0 i	05/00-12/06	M54 B30 (306S3)	2979			0-N1293	VB [VD]
3.0 i	05/00-12/06	M54 B30 (306S3)	2979			0-N1298	VB [DG]
3.0 i	05/00-12/06	M54 B30 (306S3)	2979			0-N1301	VB [TE]
3.0 i	05/00-12/06	M54 B30 (306S3)	2979	09/2002 →		0-N1791	VB [BT] S
3.0 i	05/00-12/06	M54 B30 (306S3)	2979			0-N1919	VB [BT] S
4.4 i	05/00-12/03	M62 B44 (448S2), M62 B44 TU	4398			0-N1508	VB [BT] S
4.4 i	05/00-12/03	M62 B44 (448S2), M62 B44 TU	4398			0-N1669	VB [BT] S
4.4 i	05/00-12/03	M62 B44 (448S2), M62 B44 TU	4398	MS		0-N1726	VB [DG]
4.4 i	05/00-12/03	M62 B44 (448S2), M62 B44 TU	4398			0-N1787	VB [VD]
4.4 i	05/00-12/03	M62 B44 (448S2), M62 B44 TU	4398			0-N2410	VB [VD]
4.4 i	12/03-09/06	N62 B44, N62 B44 A	4398			0-N1507	VB [BT] S
4.4 i	12/03-09/06	N62 B44, N62 B44 A	4398			0-N1512	VB [BT] S
4.4 i	12/03-09/06	N62 B44, N62 B44 A	4398			0-N1922	VB [BT]
4.6 is	02/02-12/03	M62 B46 (468S1)	4619			0-N1508	VB [BT] S
4.6 is	02/02-12/03	M62 B46 (468S1)	4619			0-N1669	VB [BT] S
4.6 is	02/02-12/03	M62 B46 (468S1)	4619	MS		0-N1726	VB [DG]
4.6 is	02/02-12/03	M62 B46 (468S1)	4619			0-N1787	VB [VD]
4.6 is	02/02-12/03	M62 B46 (468S1)	4619			0-N2410	VB [VD]
4.8 is	04/04-09/06	N62 B48 A	4799			0-N1507	VB [BT] S
4.8 is	04/04-09/06	N62 B48 A	4799			0-N1512	VB [BT] S
4.8 is	04/04-09/06	N62 B48 A	4799			0-N1922	VB [BT]
X5 (E70)							
3.0 d, 3.0 sd, xDrive 35 d	02/07-06/13	M57 D30 (306D3), M57 D30 (306D5)	2993			0-N2082	VB [BT] S
3.0 d, 3.0 sd, xDrive 35 d	02/07-06/13	M57 D30 (306D3), M57 D30 (306D5)	2993			0-N2125	VB [DG]
3.0 si, xDrive 30 i	02/07-03/10	N52 B30 A, N52 B30, N52 B30 A	2996	MS		0-N1788	VB [BT] S
3.0 si, xDrive 30 i	02/07-03/10	N52 B30 A, N52 B30, N52 B30 A	2996			0-N2128	VB [DG]
3.0d xDrive	09/08-06/13	N57 D30 A	2993		für Fahrzeuge ohne aktive Stabilisatorregelung	0-N1958	VB [BT] S
3.0d xDrive , xDrive 30 d	09/08-06/13	N57 D30 A	2993		für Fahrzeuge mit aktiver Stabilisatorregelung	0-N2084	VB [BT] S
3.0d xDrive , xDrive 30 d, xDrive 40 d	09/08-06/13	N57 D30 A, N57 D30 B, N57 D30 B	2993			0-N1950	VB [DG]
M 50 d	08/11-06/13	N57 D30 C	2993			0-N2217	VB [BT]
M 50 d	08/11-06/13	N57 D30 C	2993			0-N2217S1	VB [DG]
M 50 d	08/11-06/13	N57 D30 C	2993			0-N2217S2	VB [DG]
xDrive 30 d	09/08-06/13	N57 D30 A	2993			0-N1958	VB [BT] S
xDrive 35 i	09/10-06/13	N55 B30 A	2979			0-N2370	VB [DG]
xDrive 35 i	09/10-06/13	N55 B30 A	2979			0-N2371	VB [DG]
xDrive 40 d	09/10-06/13	N57 D30 B, N57 D30 B	2993			0-N2084	VB [BT] S
X5 (F15, F85)							
sDrive 25 d, xDrive 25 d	11/13-	N47 D20 D	1995			0-N2216	VB [BT]
sDrive 25 d, xDrive 25 d	11/13-	N47 D20 D	1995			0-N2216S1	VB [DG]
sDrive 25 d, xDrive 25 d	11/13-	N47 D20 D	1995			0-N2216S2	VB [DG]
xDrive 30 d	07/13-	N57 D30 A	2993			0-N2216	VB [BT]
xDrive 30 d	07/13-	N57 D30 A	2993			0-N2216S1	VB [DG]
xDrive 30 d	07/13-	N57 D30 A	2993			0-N2216S2	VB [DG]
xDrive 30 d	07/13-	N57 D30 A	2993		für Fahrzeuge mit aktiver Stabilisatorregelung	0-N2217	VB [BT]
xDrive 30 d	07/13-	N57 D30 A	2993		für Fahrzeuge mit aktiver Stabilisatorregelung	0-N2217S1	VB [DG]



CM³



Art. Nr.



X5 (F15, F85)							
xDrive 30 d	07/13-	N57 D30 A	2993	für Fahrzeuge mit aktiver Stabilisatorregelung	0-N2217S2	VB [DG]	
xDrive 35 i	11/13-	N55 B30 A	2979		0-N2370	VB [DG]	
xDrive 35 i	11/13-	N55 B30 A	2979	für Fahrzeuge mit Stabilisator	0-N2371	VB [DG]	
X6 (E71, E72)							
30 d	05/08-08/08	M57 D30 (306D3)	2993		0-N2082	VB [BT]	S
30 d, 35 d, xDrive 35 d	05/08-06/14	M57	2993		0-N2125	VB [DG]	
30 d, xDrive 30 d, xDrive 40 d	05/08-06/14	M57 D30 (306D3), N57 D30 A, N57 D30 B	2993		0-N1950	VB [DG]	
35 d, xDrive 35 d	05/08-06/14	M57	2993		0-N2082	VB [BT]	S
35 i, xDrive 35 i	05/08-06/14	N54 B30 A, N54 B30 A, N55 B30 A, N55 B30 A	2979		0-N2370	VB [DG]	
M 50 d	08/11-06/14	N57 D30 C	2993		0-N2217	VB [BT]	
M 50 d	08/11-06/14	N57 D30 C	2993		0-N2217S1	VB [DG]	
M 50 d	08/11-06/14	N57 D30 C	2993		0-N2217S2	VB [DG]	
xDrive 30 d	09/10-06/14	N57 D30 A	2993		0-N1950	VB [DG]	
xDrive 30 d	09/10-06/14	N57 D30 A	2993		0-N1958	VB [BT]	S
xDrive 30 d	09/10-06/14	M57N2 306D3	2993		0-N2082	VB [BT]	S
xDrive 30 d	09/10-06/14	N57 D30 A	2993	für Fahrzeuge mit aktiver Stabilisatorregelung	0-N2084	VB [BT]	S
xDrive 30 d	09/10-06/14	M57N2 306D3	2993		0-N2125	VB [DG]	
xDrive 30 d, xDrive 40 d	09/08-06/14	N57 D30 A, N57 D30 B	2993		0-N1958	VB [BT]	S
xDrive 30 d, xDrive 40 d	09/08-06/14	N57 D30 A, N57 D30 B	2993	für Fahrzeuge mit aktiver Stabilisatorregelung	0-N2084	VB [BT]	S
xDrive 35 i	09/08-06/14	N55 B30 A	2979		0-N2371	VB [DG]	
X6 (F16, F86)							
xDrive 35 i	12/14-	N55 B30 A	2979	für Fahrzeuge mit Stabilisator	0-N2371	VB [DG]	
Z1							
2.5	06/88-06/91	M20 B25 (256K1)	2494		0-N809	TB [TE]	
Z3 (E36)							
1.8	10/95-10/98	M43 B18 (184E2)	1796	mechanisch	0-N1294	VB [BT]	S
1.8	10/95-10/98	M43 B18 (184E2)	1796		0-N1301	VB [TE]	
1.8	10/95-10/98	M43 B18 (184E2)	1796		0-N1306	VB [TE]	
1.9	10/95-01/03	M43 B19 (194E1), M44 B19 (194S1), M44 B19 (194S1)	1895		0-N1294	VB [BT]	S
1.9	10/95-01/03	M43 B19 (194E1), M44 B19 (194S1), M44 B19 (194S1)	1895		0-N1301	VB [TE]	
1.9	10/95-03/99	M44 B19 (194S1), M44 B19 (194S1)	1895		0-N1306	VB [TE]	
1.9	07/98-01/03	M43 B19 (194E1)	1895		0-N1292	VB [DG]	
1.9	07/98-01/03	M43 B19 (194E1)	1895	mechanisch	0-N1306	VB [TE]	
1.9	07/98-01/03	M43 B19 (194E1)	1895		0-N1974	VB [VD]	
2.0	04/99-01/03	M52 B20, M52 B20 (206S4)	1991		0-N1290	VB [BT]	S
2.0	04/99-01/03	M52 B20, M52 B20 (206S4)	1991		0-N1298	VB [DG]	
2.0	04/99-01/03	M52 B20, M52 B20 (206S4)	1991		0-N1301	VB [TE]	
2.0	04/99-01/03	M52 B20, M52 B20 (206S4)	1991		0-N1919	VB [BT]	S
2.0	04/99-01/03	M52 B20, M52 B20 (206S4)	1991		0-N1974	VB [VD]	
2.2	08/00-01/03	M54 B22 (226S1)	2171		0-N1290	VB [BT]	S
2.2	08/00-01/03	M54 B22 (226S1)	2171		0-N1291	VB [BT]	S
2.2	08/00-01/03	M54 B22 (226S1)	2171		0-N1298	VB [DG]	
2.2	08/00-01/03	M54 B22 (226S1)	2171		0-N1301	VB [TE]	
2.2	08/00-01/03	M54 B22 (226S1)	2171		0-N1919	VB [BT]	S
2.8	01/96-07/00	M52 B28 (286S1), M52 B28 (286S1), M52 B28 TU, M52 B28 (286S1), M52 B28 (286S2)	2793		0-N1290	VB [BT]	S
2.8	04/97-06/00	M52 B28 (286S1), M52 B28 (286S1), M52 B28 TU	2793		0-N1293	VB [VD]	
2.8	04/97-06/00	M52 B28 (286S1), M52 B28 (286S1), M52 B28 TU	2793	→ 09/1998; mechanisch	0-N1298	VB [DG]	
2.8	04/97-06/00	M52 B28 (286S1), M52 B28 (286S1), M52 B28 TU	2793	hydraulisch	0-N1298	VB [DG]	
2.8	04/97-06/00	M52 B28 (286S1), M52 B28 (286S1), M52 B28 TU	2793		0-N1301	VB [TE]	
2.8	04/97-06/00	M52 B28 (286S1), M52 B28 (286S1), M52 B28 TU	2793		0-N1559S	VB [TE]	
2.8	04/97-06/00	M52 B28 (286S1), M52 B28 (286S1), M52 B28 TU	2793		0-N1919	VB [BT]	S
2.8	04/97-06/00	M52 B28 (286S1), M52 B28 (286S1), M52 B28 TU	2793		0-N1974	VB [VD]	

CM³

Art. Nr.

**Z3 (E36)**

2.8	04/97-06/00	M52 B28 (286S1), M52 B28 (286S1), M52 B28 TU	2793	hydraulisch	0-N2135	VB [BT]	
3.0	06/00-01/03	M54 B30 (306S3)	2979		0-N1290	VB [BT]	S
3.0	06/00-01/03	M54 B30 (306S3)	2979		0-N1291	VB [BT]	S
3.0	06/00-01/03	M54 B30 (306S3)	2979		0-N1298	VB [DG]	
3.0	06/00-01/03	M54 B30 (306S3)	2979		0-N1301	VB [TE]	
3.0	06/00-01/03	M54 B30 (306S3)	2979		0-N1919	VB [BT]	S
M 3.2	03/97-06/01	S50 B32 (326S1)	3201		0-N1293	VB [VD]	
M 3.2	03/97-06/01	S50 B32 (326S1)	3201		0-N1298	VB [DG]	
M 3.2	03/97-06/01	S50 B32 (326S1)	3201		0-N1301	VB [TE]	
M 3.2	03/97-06/01	S50 B32 (326S1)	3201		0-N1306	VB [TE]	
M 3.2	03/97-06/01	S50 B32 (326S1)	3201		0-N1919	VB [BT]	S
M 3.2	03/97-06/01	S50 B32 (326S1)	3201		0-N2135	VB [BT]	
M 3.2	06/01-01/03	S54 B32, S54 B32 (326S4)	3246		0-N1291	VB [BT]	S
M 3.2	06/01-01/03	S54 B32, S54 B32 (326S4)	3246		0-N1293	VB [VD]	
M 3.2	06/01-01/03	S54 B32, S54 B32 (326S4)	3246		0-N1301	VB [TE]	

Z3 Coupe (E36)

2.8	07/97-06/00	M52 B28 (286S1), M52 B28 (286S1)	2793		0-N1290	VB [BT]	S
2.8	07/97-06/00	M52 B28 (286S1), M52 B28 (286S1)	2793		0-N1293	VB [VD]	
2.8	07/97-06/00	M52 B28 (286S1), M52 B28 (286S1)	2793	hydraulisch	0-N1298	VB [DG]	
2.8	07/97-06/00	M52 B28 (286S1), M52 B28 (286S1)	2793		0-N1301	VB [TE]	
2.8	07/97-06/00	M52 B28 (286S1), M52 B28 (286S1)	2793		0-N1559S	VB [TE]	
2.8	07/97-06/00	M52 B28 (286S1), M52 B28 (286S1)	2793		0-N1919	VB [BT]	S
2.8	07/97-06/00	M52 B28 (286S1), M52 B28 (286S1)	2793		0-N1974	VB [VD]	
2.8	07/97-06/00	M52 B28 (286S1), M52 B28 (286S1)	2793	hydraulisch	0-N2135	VB [BT]	
3.0	06/00-06/03	M54 B30 (306S3)	2979		0-N1290	VB [BT]	S
3.0	06/00-06/03	M54 B30 (306S3)	2979		0-N1291	VB [BT]	S
3.0	06/00-06/03	M54 B30 (306S3)	2979		0-N1298	VB [DG]	
3.0	06/00-06/03	M54 B30 (306S3)	2979		0-N1301	VB [TE]	
3.0	06/00-06/03	M54 B30 (306S3)	2979		0-N1919	VB [BT]	S
M	02/98-06/01	S50 B32 (326S1)	3201		0-N1293	VB [VD]	
M	02/98-06/01	S50 B32 (326S1)	3201		0-N1298	VB [DG]	
M	02/98-06/01	S50 B32 (326S1)	3201		0-N1301	VB [TE]	
M	02/98-06/01	S50 B32 (326S1)	3201		0-N1306	VB [TE]	
M	02/98-06/01	S50 B32 (326S1)	3201		0-N1919	VB [BT]	S
M	02/98-06/01	S50 B32 (326S1)	3201		0-N2135	VB [BT]	
M	06/01-06/03	S54 B32, S54 B32 (326S4)	3246		0-N1291	VB [BT]	S
M	06/01-06/03	S54 B32, S54 B32 (326S4)	3246		0-N1293	VB [VD]	
M	06/01-06/03	S54 B32, S54 B32 (326S4)	3246		0-N1298	VB [DG]	
M	06/01-06/03	S54 B32, S54 B32 (326S4)	3246		0-N1301	VB [TE]	
M	06/01-06/03	S54 B32, S54 B32 (326S4)	3246		0-N1919	VB [BT]	S
M	06/01-06/03	S54 B32, S54 B32 (326S4)	3246		0-N2135	VB [BT]	

Z4 (E85)

2.0 i	03/05-02/09	N46 B20 A, N46 B20 B	1995	☼	0-N1505S	VB [DG]	
2.0 i	03/05-02/09	N46 B20 A, N46 B20 B	1995		0-N1794	VB [BT]	S
2.2 i	10/03-10/05	M54 B22 (226S1)	2171		0-N1290	VB [BT]	S
2.2 i	10/03-10/05	M54 B22 (226S1)	2171		0-N1298	VB [DG]	
2.2 i	10/03-10/05	M54 B22 (226S1)	2171		0-N1301	VB [TE]	
2.2 i	10/03-10/05	M54 B22 (226S1)	2171	Rippenanzahl: 6	0-N1638	VB [DG]	
2.2 i	10/03-10/05	M54 B22 (226S1)	2171		0-N1791	VB [BT]	S
2.2 i	10/03-10/05	M54 B22 (226S1)	2171		0-N1919	VB [BT]	S
2.5 i	02/03-12/05	M54 B25 (256S5)	2494		0-N1290	VB [BT]	S
2.5 i	02/03-12/05	M54 B25 (256S5)	2494		0-N1298	VB [DG]	
2.5 i	02/03-12/05	M54 B25 (256S5)	2494		0-N1301	VB [TE]	
2.5 i	02/03-12/05	M54 B25 (256S5)	2494	Rippenanzahl: 6	0-N1638	VB [DG]	
2.5 i	02/03-12/05	M54 B25 (256S5)	2494		0-N1791	VB [BT]	S
2.5 i	02/03-12/05	M54 B25 (256S5)	2494		0-N1919	VB [BT]	S
2.5 i, 2.5 si	09/05-02/09	N52 B25 A	2497		0-N1788	VB [BT]	S
3.0 i	02/03-10/05	M54 B30 (306S3)	2979		0-N1290	VB [BT]	S
3.0 i	02/03-10/05	M54 B30 (306S3)	2979		0-N1298	VB [DG]	
3.0 i	02/03-10/05	M54 B30 (306S3)	2979		0-N1301	VB [TE]	
3.0 i	02/03-10/05	M54 B30 (306S3)	2979	Rippenanzahl: 6	0-N1638	VB [DG]	
3.0 i	02/03-10/05	M54 B30 (306S3)	2979		0-N1791	VB [BT]	S
3.0 i	02/03-10/05	M54 B30 (306S3)	2979		0-N1919	VB [BT]	S
3.0 si	01/06-12/08	N52 B30 A	2996		0-N1788	VB [BT]	S



CM³



Art. Nr.



ohne Halter

Z4 (E85)							
M	03/06-02/09	S54 B32 (326S4)	3246		0-N1293	VB [VD]	
M	03/06-02/09	S54 B32 (326S4)	3246		0-N1298	VB [DG]	
M	03/06-02/09	S54 B32 (326S4)	3246		0-N1301	VB [TE]	
M	03/06-02/09	S54 B32 (326S4)	3246		0-N1919	VB [BT]	S
M	03/06-02/09	S54 B32 (326S4)	3246		0-N2135	VB [BT]	
Z4 Coupe (E86)							
3.0 si	03/06-01/09	N52 B30 A	2996		0-N1788	VB [BT]	S
M	03/06-01/09	S54 B32 (326S4)	3246		0-N1293	VB [VD]	
M	03/06-01/09	S54 B32 (326S4)	3246		0-N1298	VB [DG]	
M	03/06-01/09	S54 B32 (326S4)	3246		0-N1301	VB [TE]	
M	03/06-01/09	S54 B32 (326S4)	3246		0-N1919	VB [BT]	S
M	03/06-01/09	S54 B32 (326S4)	3246		0-N2135	VB [BT]	
Z4 (E89)							
sDrive23i	05/09-	N52 B25 A	2497		0-N1788	VB [BT]	S
sDrive30i	05/09-	N52 B30 A	2996		0-N1788	VB [BT]	S
sDrive35i, sDrive35is	05/09-	N54 B30 A	2979		0-N2130	VB [DG]	
Z8 (E52)							
4.9	06/00-06/03	S62 B50, S62 B50 (508S1)	4941		0-N1447S	VB [DG]	



OPTIMAL®

BMW (BRILLIANCE)



CM³



Art. Nr.



ohne Halter

3 SERIES (E46)

318i	06/04-06/05	N42 B20 BZ, N46 B20 CA	1995	Rippenanzahl: 6	0-N2076	VB [DG]	S
------	-------------	------------------------	------	-----------------	----------------	---------	----------

5 SERIES (E60)

520i	05/04-12/06	M 54 B 22	2171	†	0-N1453	VB [DG]	
520i	05/04-12/06	M 54 B 22	2171		0-N1791	VB [BT]	S
520i	05/04-12/06	M 54 B 22	2171		0-N2135	VB [BT]	
523i	07/03-12/07	N52 B25	2494	†	0-N1453	VB [DG]	
523i	07/03-12/07	N52 B25	2494		0-N1791	VB [BT]	S
523i	07/03-12/07	N52 B25	2494		0-N2135	VB [BT]	
530i	10/03-06/05	M 54 B 30	2979	†	0-N1453	VB [DG]	
530i	10/03-06/05	M 54 B 30	2979		0-N1791	VB [BT]	S
530i	10/03-06/05	M 54 B 30	2979		0-N2135	VB [BT]	

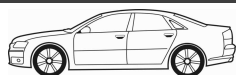

CM³



Art. Nr.



ohne Halter

CENTURY Stufenheck							
3.1	10/91-12/96	L82, LHO	3135		0-N1688	VB [DG]	
3.1	10/91-12/96	L82, LHO	3135		0-N1848	VB [BT]	S
CENTURY Kombi (4_35)							
3.1, 3.1 Special	10/91-12/96	L82, LHO	3135		0-N1688	VB [DG]	
3.1, 3.1 Special	10/91-12/96	L82, LHO	3135		0-N1848	VB [BT]	S
CENTURY Stufenheck							
3.1	10/96-02/05	L82	3135		0-N1684	VB [DG]	
ENCLAVE							
3.6, 3.6 AWD	04/07-12/08	LLT, LY7	3564		0-N2340	VB [DG]	
EXCELLE							
1.6	04/03-	F16D3	1598		0-N970	TB [TE]	
1.6	04/03-	F16D3	1598		0-N971	TB [DG]	
1.8	08/03-		1799		0-N100	TB [TE]	
1.8	08/03-		1799		0-N906	TB [DG]	
1.5	04/03-	A15SMS	1498		0-N948	TB [TE]	
1.6	04/03-	F16D3	1598		0-N1532	VB [BT]	S
1.6	04/03-	F16D3	1598	Rippenanzahl: 6; ✱	0-N1646	VB [DG]	
LA CROSSE Schrägheck							
2.4 VVTi	02/06-	LE5	2384		0-N2299	VB [BT]	S
LA CROSSE Stufenheck							
2.4 VVTi	02/06-12/09	LE5	2384		0-N2299	VB [BT]	S
LESABRE							
2.4	01/80-12/85		5735	01/2003 →	0-N1838S	TB [TE]	
LE SABRE							
3.8	10/86-09/87	LN3	3791		0-N1684	VB [DG]	
3.8	10/86-09/87	LN3	3791		0-N1687	VB [DG]	
LE SABRE							
3.8	10/95-09/99	L36	3791	→ 1999	0-N1685	VB [DG]	
3.8	10/95-09/99	L36	3791		0-N1692	VB [DG]	
LE SABRE							
3.8	01/99-	L36	3791		0-N1685	VB [DG]	
3.8	01/99-	L36	3791	10/1999 →	0-N1692	VB [DG]	
PARK AVENUE							
3.8, 3.8 Supercharged	10/96-12/05	L36, L67	3791		0-N1685	VB [DG]	
REGAL							
3.1	10/88-09/91	L82, LH0, LHO	3135		0-N1688	VB [DG]	
3.1	10/88-09/91	L82, LH0, LHO	3135		0-N1848	VB [BT]	S
REGAL							
3.1	10/91-09/97	L82, LH0, LHO	3135		0-N1688	VB [DG]	
3.1	10/91-09/97	L82, LH0, LHO	3135		0-N1848	VB [BT]	S
REGAL (4WF_)							
2.0	07/00-12/04		1998		0-N906	TB [DG]	
ROADMASTER Kombi							
5.0	10/90-09/92	LG2	4998		0-N1685	VB [DG]	
5.7	09/92-12/96	L05	5735		0-N1685	VB [DG]	
ROADMASTER Stufenheck							
5.7	10/92-09/93	L05	5733		0-N1685	VB [DG]	
5.7	10/93-09/96	LT1	5733		0-N1684	VB [DG]	
SAIL Kombi							
1.6	07/02-		1598		0-N1466	VB [BT]	S
1.6	07/02-		1598		0-N948	TB [TE]	
SAIL Stufenheck							
1.6	07/02-		1598		0-N1466	VB [BT]	S
1.6	07/02-		1598		0-N948	TB [TE]	
SKYLARK							
2.3, 2.3 Limited	09/92-09/95	L40, LD2, LD24	2260	✱	0-N1691	VB [DG]	
2.4	01/95-12/99	LD9	2392		0-N1422	VB [BT]	S
2.4	01/95-12/99	LD9	2392	10/1995 →	0-N1691	VB [DG]	



OPTIMAL®

BUICK



CM³



Art. Nr.



ohne Halter

SKYLARK

3.1	01/94-12/99	L82	3135	0-N1688	VB [DG]
-----	-------------	-----	------	---------	---------



CM³



Art. Nr.



ohne Halter

EXCELLE GT							
1.6, 1.6 T	06/10-	LDE, LLU	1598		0-N1347	TB [TE]	
1.8	06/10-	2H0	1796		0-N1347	TB [TE]	
EXCELLE HRV Schrägheck							
1.6	10/04-	F16D3, F16D3D	1598		0-N970	TB [TE]	
1.6	10/04-	F16D3, F16D3D	1598		0-N971	TB [DG]	
1.6	10/04-	F16D3, F16D3D	1598		0-N1532	VB [BT]	S
EXCELLE Stufenheck							
1.6	08/03-05/08	F16D3D	1598		0-N970	TB [TE]	
1.6	08/03-05/08	F16D3D	1598		0-N971	TB [DG]	
1.8	08/03-05/08	T18SED	1796		0-N100	TB [TE]	
1.8	08/03-05/08	T18SED	1796		0-N906	TB [DG]	
1.6	08/03-05/08	F16D3D	1598		0-N1532	VB [BT]	S
EXCELLE XT							
1.6, 1.6 T	01/10-	LDE, LLU	1598		0-N1347	TB [TE]	
1.6	01/10-	LDE	1598		0-N1799	VB [BT]	S
REGAL I							
2.0	02/03-12/08	L34	1998		0-N906	TB [DG]	
REGAL II							
1.6 Turbo	09/09-	LLU	1598		0-N1347	TB [TE]	

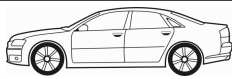
CM³

Art. Nr.



ohne Halter

ALLANTE Cabriolet

4.5	10/88-09/92	LQ6	4467	Baumuster: →I 1990	0-N1685	VB [DG]
4.6	10/92-09/93	L37	4565		0-N1684	VB [DG]
4.6	10/92-09/93	L37	4565		0-N1685	VB [DG]

ALLANTE Coupe

4.5	01/91-09/92	LQ6	4467		0-N1685	VB [DG]
-----	-------------	-----	------	--	---------	---------

BLS

1.9 D	04/06-	Z 19 DTR, Z19DTH	1910	24x199	SK-1586	BTK
1.9 D	04/06-	Z 19 DTR, Z19DTH	1910		0-N115	TB [TE]
1.9 D	04/06-	Z 19 DTR, Z19DTH	1910		0-N2149	TB [DG]
2.0 T Flexpower	12/07-	Z 20 LER	1998		0-N127	TB [DG]
2.0 T Flexpower	12/07-	Z 20 LER	1998		0-N1369	TB [TE]
2.0 T Flexpower	12/07-	Z 20 LER	1998		0-N1574	TB [DG]
1.9 D	04/06-	Z 19 DTR, Z19DTH	1910	: →71111927	0-N1503	VB [BT] S
1.9 D	04/06-	Z 19 DTR, Z19DTH	1910	: →71111927;	0-N1522	VB [DG]
1.9 D	04/06-	Z 19 DTR, Z19DTH	1910	Rippenanzahl: 6	0-N1667	VB [DG]
1.9 D	04/06-	Z 19 DTR, Z19DTH	1910	:71111928→	0-N2030	VB [BT] S
2.0 T Flexpower	12/07-	Z 20 LER	1998		0-N1422	VB [BT] S
2.0 T, 2.0 T AWD, 2.0 T Flexpower	04/06-	B207L, LK9, B207R, LK9, Z 20 LER	1998		0-N1588	VB [BT] S
2.8 T, 2.8 T AWD	04/06-	B284L, Z 28 NET	2792		0-N2194	VB [BT] S
2.8 T, 2.8 T AWD	04/06-	B284L, Z 28 NET	2792		0-N2340	VB [DG]

BLS Wagon

1.9 D	12/07-	Z 19 DTR, Z19DTH	1910	24x199	SK-1586	BTK
1.9 D	12/07-	Z 19 DTR, Z19DTH	1910		0-N115	TB [TE]
1.9 D	12/07-	Z 19 DTR, Z19DTH	1910		0-N2149	TB [DG]
2.0 T Flexpower	12/07-	Z 20 LER	1998		0-N127	TB [DG]
2.0 T Flexpower	12/07-	Z 20 LER	1998		0-N1369	TB [TE]
2.0 T Flexpower	12/07-	Z 20 LER	1998		0-N1574	TB [DG]
1.9 D	12/07-	Z 19 DTR, Z19DTH	1910	: →71111927	0-N1503	VB [BT] S
1.9 D	12/07-	Z 19 DTR, Z19DTH	1910	: →71111927;	0-N1522	VB [DG]
1.9 D	12/07-	Z 19 DTR, Z19DTH	1910	Rippenanzahl: 6	0-N1667	VB [DG]
1.9 D	12/07-	Z 19 DTR, Z19DTH	1910	:71111928→	0-N2030	VB [BT] S
2.0 T Flexpower	12/07-	Z 20 LER	1998		0-N1422	VB [BT] S
2.0 T, 2.0 T AWD, 2.0 T Flexpower	12/07-	B207R, Z 20 LER, Z 20 NER, Z 20 NET	1998		0-N1588	VB [BT] S
2.8 T, 2.8 T AWD	12/07-	B284R, Z 28 NET	2792		0-N2194	VB [BT] S
2.8 T, 2.8 T AWD	12/07-	B284R, Z 28 NET	2792		0-N2340	VB [DG]

CTS

2.8	03/05-09/07	LP1	2792		0-N2340	VB [DG]
3.2	03/02-09/07	LA3	3175		0-N1690	VB [DG]
3.6, 3.6 AWD, 3.6 VVTi	09/03-12/07	LLT, LY7	3564		0-N2340	VB [DG]
5.7 V8	03/05-09/07	LS6	5665		0-N1689	VB [DG]

CTS

2.8	01/08-	LP1	2792		0-N2340	VB [DG]
3.0, 3.0 AWD	01/08-	LF1	2997		0-N2340	VB [DG]
3.6, 3.6 AWD, 3.6 VVTi	01/08-	LLT, LY7	3564		0-N2340	VB [DG]

CTS Coupe

3.0, 3.0 AWD	01/10-	LF1	2997		0-N2340	VB [DG]
3.6, 3.6 AWD	01/08-	LLT	3564		0-N2340	VB [DG]

CTS Sport Wagon

3.0, 3.0 AWD	01/08-	LF1	2997		0-N2340	VB [DG]
3.6, 3.6 AWD	01/08-12/10	LLT	3564		0-N2340	VB [DG]

DEVILLE

4.6, 4.6 Concours, 4.6 DHS, 4.6 DTS	10/93-09/99	L37, LD8	4565		0-N1685	VB [DG]
-------------------------------------	-------------	----------	------	--	---------	---------

DEVILLE

4.6, 4.6 Concours, 4.6 DHS, 4.6 DTS	09/99-12/05	L37, LD8	4565		0-N1685	VB [DG]
-------------------------------------	-------------	----------	------	--	---------	---------

DTS

4.6	06/05-12/11	L37, LD8	4565		0-N1685	VB [DG]
4.6	06/05-12/11	L37, LD8	4565		0-N1696	VB [DG]
4.6	06/05-12/11	L37, LD8	4565		0-N1701	VB [DG]

ELDORADO Coupe

4.6	09/91-09/02	L37, L37, LD8	4565		0-N1684	VB [DG]
4.6	09/91-09/02	L37, L37, LD8	4565		0-N1685	VB [DG]

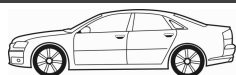

CM³



Art. Nr.



ohne Halter

ELDORADO Coupe							
4.6	09/94-09/02	L37, LD8	4565			0-N1696	VB [DG]
4.6	09/94-09/02	L37, LD8	4565			0-N1701	VB [DG]
ESCALADE							
5.8	10/98-10/06	LO5	5733			0-N1684	VB [DG]
5.8	10/98-10/06	LO5	5733			0-N1689	VB [DG]
5.8	10/98-10/06	LO5	5733			0-N1697	VB [BT] S
6.0	06/01-09/06	LQ9	5966			0-N1846	VB [BT] S
6.0 4x4	10/00-09/06	LQ9	5966	06/2001 →		0-N1846	VB [BT] S
ESCALADE							
6.2, 6.2 AWD	10/06-12/14	L92, L94, L92, L94, L9H	6162			0-N1684	VB [DG]
6.2, 6.2 AWD	10/06-12/14	L92, L94, L92, L94, L9H	6162			0-N1690	VB [DG]
6.2, 6.2 AWD	10/06-12/14	L92, L94, L92, L94, L9H	6162			0-N1846	VB [BT] S
SEVILLE							
4.6 STS V8	09/97-09/04	LH2	4565	10/2000 →		0-N1685	VB [DG]
4.6 STS V8	09/97-09/04	LH2	4565	10/2000 →		0-N1696	VB [DG]
4.6, 4.6 SLS V8	09/97-09/04	L37, LH2	4565			0-N1685	VB [DG]
4.6, 4.6 SLS V8	09/97-09/04	L37, LH2	4565			0-N1696	VB [DG]
SRX							
3.6, 3.6 AWD, 3.6 Heckantrieb	09/03-12/08	LY7	3564			0-N2340	VB [DG]
4.6, 4.6 Heckantrieb	09/03-12/09	LH2	4565			0-N1685	VB [DG]
SRX							
2.8, 2.8 AWD	01/09-	LAU	2792			0-N2340	VB [DG]
3.0 AWD	01/09-	LF1	2997			0-N2340	VB [DG]
3.0, 3.0 AWD	01/09-	LF1	2996			0-N2340	VB [DG]
STS							
3.6, 3.6 AWD, 3.6 VVT AWD	09/04-12/07	LLT, LY7	3564			0-N2340	VB [DG]
4.6, 4.6 Allrad, 4.6 AWD	09/04-12/07	LH2	4565			0-N1685	VB [DG]
STS							
3.6, 3.6 AWD, 3.6 VVT AWD	09/07-12/12	LLT, LY7	3564			0-N2340	VB [DG]
4.6, 4.6 Allrad, 4.6 AWD	09/07-12/10	LH2	4565			0-N1685	VB [DG]



OPTIMAL®

CHANGAN (CHANA)

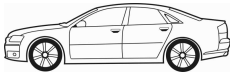

CM³



Art. Nr.



ohne Halter

SC Bus

1.0 6350 Star Wagon	02/99-06/01	JL472Q	993		0-N916	TB [TE]	
---------------------	-------------	--------	-----	--	---------------	---------	--

STAR Kasten

1.0	06/99-08/02	JL472Q	993		0-N916	TB [TE]	
-----	-------------	--------	-----	--	---------------	---------	--



CM³



Art. Nr.



ohne Halter

LIEBAO Geländewagen geschlossen

2.0 AWD	09/04-	4 G 63	1997		0-N056	TB [TE]	
3.0 AWD	09/04-	6 G 72 (12V)	2972		0-N185	TB [TE]	

LIEBAO Großraumlimousine

3.0, 3.0 AWD	01/99-01/10	6 G 72 (24V)	2972		0-N185	TB [TE]	
--------------	-------------	--------------	------	--	---------------	---------	--

PAJERO Geländewagen geschlossen

3.0 AWD	12/04-	6 G 72 (24V)	2972		0-N185	TB [TE]	
3.8 AWD	12/04-	6 G 75	3828		0-N185	TB [TE]	



OPTIMAL®

CHERY

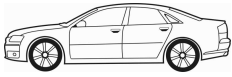

CM³



Art. Nr.



ohne Halter

A5

1.5	06/09-	SQR477F	1497		0-N1683	TB [DG]	
1.6	01/06-01/09	SQR481F	1597		0-N1683	TB [DG]	
1.8	09/07-	SQR481FC	1845		0-N1683	TB [DG]	
2.0	01/06-	SQR484F	1971		0-N1683	TB [DG]	



CM³



Art. Nr.



ohne Halter

ALERO								
2.2	12/01-09/04	L61	2198			0-N1588	VB [BT]	S
2.4 16V	03/99-09/04	LD9	2392			0-N1422	VB [BT]	S
3.4 V6	03/99-09/04	LA1	3350			0-N1658	VB [BT]	
3.4 V6	03/99-09/04	LA1	3350			0-N1685	VB [DG]	
3.4 V6	03/99-09/04	LA1	3350			0-N1690	VB [DG]	
ASTRA Schrägheck								
1.8	09/98-	C 18 NE, C 18 YE	1796	20x162; :02HL5118, 20041691→; mit Zubehör		SK-1355	BTK	
2.0	03/99-07/02	X 20 XEV	1998	24x168		SK-1478	BTK	
2.0	03/99-07/02	X 20 XEV	1998	24x168		SK-1478AQ1	BTKW	
2.0	08/02-	C 20 NE	1998	20x146; :14608701→		SK-1169	BTK	
2.0	08/02-	C 20 NE	1998	20x146; :14608701→		SK-1169AQ1	BTKW	
1.8	09/98-	C 18 NE, C 18 YE	1796			0-N102	TB [TE]	
1.8	09/98-	C 18 NE, C 18 YE	1796	:02HL5118, 20041691→; mit Anbaumaterial		0-N300	TB [DG]	
1.8	09/98-	C 18 NE, C 18 YE	1796	:→02HL5117, 20041690		0-N952	TB [DG]	
1.8	09/98-	C 18 NE, C 18 YE	1796			0-N953	TB [DG]	
2.0	03/99-07/02	C 20 SEL, X 20 XEV	1998			0-N100	TB [TE]	
2.0	03/99-07/02	C 20 SEL, X 20 XEV	1998			0-N906	TB [DG]	
2.0	08/02-	X 20 SE	1998			0-N101	TB [TE]	
1.8	09/98-	C 18 NE, C 18 YE	1796			0-N1466	VB [BT]	S
2.0	03/99-07/02	C 20 NE, C 20 SEL, X 20 XEV	1998			0-N1422	VB [BT]	S
2.0 DTi	08/02-	Y 20 DTH	1995	Rippenanzahl: 6		0-N1437	VB [DG]	
2.0 DTi	08/02-	Y 20 DTH	1995			0-N1485	VB [BT]	S
2.0 DTi	08/02-	Y 20 DTH	1995			0-N2169	VB [VD]	
ASTRA Stufenheck								
1.8	03/99-12/11	C 18 NE, C 18 YE	1796	20x162; :02HL5118, 20041691→; mit Zubehör		SK-1355	BTK	
2.0 GLS	03/99-07/02	X 20 XEV	1998	24x168		SK-1478	BTK	
2.0 GLS	03/99-07/02	X 20 XEV	1998	24x168		SK-1478AQ1	BTKW	
1.8	03/99-12/11	C 18 NE, C 18 YE	1796			0-N102	TB [TE]	
1.8	03/99-12/11	C 18 NE, C 18 YE	1796	:02HL5118, 20041691→; mit Anbaumaterial		0-N300	TB [DG]	
1.8	03/99-12/11	C 18 NE, C 18 YE	1796	:→02HL5117, 20041690		0-N952	TB [DG]	
1.8	03/99-12/11	C 18 NE, C 18 YE	1796			0-N953	TB [DG]	
2.0 GL	08/02-12/11	X 20 SE	1998			0-N101	TB [TE]	
2.0 GLS	03/99-12/11	C 20 SEL, X 20 XEV	1998			0-N100	TB [TE]	
2.0 GLS	03/99-12/11	C 20 SEL, X 20 XEV	1998			0-N906	TB [DG]	
1.8	03/99-12/11	C 18 NE, C 18 YE	1796			0-N1466	VB [BT]	S
2.0 DTi GLS	08/02-12/11	Y 20 DTH	1995	Rippenanzahl: 6		0-N1437	VB [DG]	
2.0 DTi GLS	08/02-12/11	Y 20 DTH	1995			0-N1485	VB [BT]	S
2.0 DTi GLS	08/02-12/11	Y 20 DTH	1995			0-N2169	VB [VD]	
2.0 GL, 2.0 GLS	03/99-12/11	C 20 SEL, X 20 XEV	1998			0-N1422	VB [BT]	S
AVALANCHE								
5.3, 5.3 AWD	10/00-09/06	LM7	5327	06/2001 → 04/2006		0-N1846	VB [BT]	S
AVEO Schrägheck (T200)								
1.2	01/04-05/08	F12S3	1150	25x109		SK-1685	BTK	
1.2	01/04-05/08	F12S3	1150	25x109		SK-1685AQ1	BTKW	
1.5	01/05-05/08	F15S3	1498	Rippenanzahl: 6;		0-N1646	VB [DG]	
AVEO Stufenheck (T200)								
1.6	09/03-	A16DMS, LXT, LXV	1598	25x127		SK-1273	BTK	
1.6	09/03-	A16DMS, LXT, LXV	1598	25x127		SK-1273AQ2	BTKW	
1.6	09/03-	A16DMS, LXT, LXV	1598			0-N970	TB [TE]	
1.6	09/03-	A16DMS, LXT, LXV	1598			0-N971	TB [DG]	
1.4	05/03-01/07	F14D3	1399	Rippenanzahl: 6;		0-N1646	VB [DG]	
1.6	09/03-	A16DMS, LXT, LXV	1598			0-N1532	VB [BT]	S
1.6	09/03-	A16DMS, LXT, LXV	1598	Rippenanzahl: 6;		0-N1646	VB [DG]	
AVEO Schrägheck (T250, T255)								
1.2	10/08-	F12S3	1150	25x109		SK-1685	BTK	
1.2	10/08-	F12S3	1150	25x109		SK-1685AQ1	BTKW	
1.4	04/08-	A 14 XER, F14D4, LDT	1399	24x146		SK-1607	BTK	
1.4	04/08-	A 14 XER, F14D4, LDT	1399			0-N1347	TB [TE]	
1.4	04/08-	A 14 XER, F14D4, LDT	1399			0-N1348	TB [DG]	
1.2	10/08-	F12S3	1150			0-N1532	VB [BT]	S

CM³

Art. Nr.



ohne Halter

AVEO Schrägheck (T250, T255)

1.2	10/08-	F12S3	1150	Rippenanzahl: 6; ☼	0-N1646	VB [DG]	
1.2	10/08-	F12S3	1150		0-N948	TB [TE]	
1.2, 1.2 LPG	04/08-	B12D1, LMU	1206	mit Anbaumaterial	0-N2274	VB [TE]	
1.4	04/08-	A 14 XER, F14D4, LDT	1399	Rippenanzahl: 6; ☼	0-N1646	VB [DG]	

AVEO Stufenheck (T250, T255)

1.2	03/06-12/07	F12S3	1150	25x109	SK-1685	BTK	
1.2	03/06-12/07	B12S1, F12S3, LY4	1150	25x109	SK-1685AQ1	BTKW	
1.4	03/06-12/07	F14D3, L14	1399	25x127; 02/2007 →	SK-1273	BTK	
1.4	03/06-12/07	F14D3, L14	1399	25x127	SK-1273AQ2	BTKW	
1.4	09/08-	F14D4	1399	24x146	SK-1607	BTK	
1.5	05/05-	F15S3	1498	17x111; mit Zubehör	SK-1162	BTK	
1.4	03/06-12/07	F14D3, L14	1399		0-N970	TB [TE]	
1.4	03/06-12/07	F14D3, L14	1399		0-N971	TB [DG]	
1.4	09/08-	F14D4	1399		0-N1347	TB [TE]	
1.4	09/08-	F14D4	1399		0-N1348	TB [DG]	
1.6	05/05-	F16D3, LXV	1598		0-N970	TB [TE]	
1.6	05/05-	F16D3, LXV	1598		0-N971	TB [DG]	
1.2	03/06-12/07	B12S1, F12S3, LY4	1150		0-N1532	VB [BT]	S
1.2	03/06-12/07	B12S1, F12S3, LY4	1150	Rippenanzahl: 6; ☼	0-N1646	VB [DG]	
1.2	03/06-12/07	B12S1, F12S3, LY4	1150		0-N948	TB [TE]	
1.2, 1.2 LPG	01/08-	B12D1, LMU	1206	mit Anbaumaterial	0-N2274	VB [TE]	
1.4	03/06-12/07	F14D3, L14	1399		0-N1532	VB [BT]	S
1.4	03/06-12/07	F14D3, L14, F14D4	1399	Rippenanzahl: 6; ☼	0-N1646	VB [DG]	
1.5	05/05-	F15S3, LX6	1498		0-N1532	VB [BT]	S
1.5	05/05-	F15S3, LX6	1498	Rippenanzahl: 6; ☼	0-N1646	VB [DG]	
1.5	05/05-	F15S3, LX6	1498		0-N948	TB [TE]	
1.6	05/05-	F16D3, LXV	1598		0-N1532	VB [BT]	S
1.6	05/05-	F16D3, LXV	1598	Rippenanzahl: 6; ☼	0-N1646	VB [DG]	

AVEO Schrägheck (T300)

1.6	03/11-	F16D4	1598	24x146; 06/2011 →	SK-1607	BTK	
1.4	12/12-	F14D4	1399		0-N1347	TB [TE]	
1.6	03/11-	F16D4	1598		0-N1347	TB [TE]	
1.6	03/11-	F16D4	1598		0-N1348	TB [DG]	
1.2, 1.2 LPG	03/11-	A 12 XEL, A 12 XER	1229		0-N2170	VB [BT]	S
1.2, 1.2 LPG	03/11-	A 12 XEL, A 12 XER	1229	☼	0-N2341	VB [DG]	
1.4	03/11-	A 14 XER	1398		0-N2170	VB [BT]	S
1.4	03/11-	A 14 XER	1398	☼	0-N2341	VB [DG]	
1.4	12/12-	F14D4	1399	Rippenanzahl: 6; ☼	0-N1646	VB [DG]	
1.4	12/12-	F14D4	1399		0-N1799	VB [BT]	S
1.4 Turbo	08/13-	LUJ, LUV	1364		0-N2170	VB [BT]	S
1.6	03/11-	F16D4	1598	Rippenanzahl: 6; ☼	0-N1646	VB [DG]	
1.6	03/11-	F16D4	1598		0-N1799	VB [BT]	S

AVEO Stufenheck (T300)

1.6	03/11-	F16D4	1598	24x146; 06/2011 →	SK-1607	BTK	
1.4	12/12-	F14D4	1399		0-N1347	TB [TE]	
1.6	03/11-	F16D4	1598		0-N1347	TB [TE]	
1.6	03/11-	F16D4	1598		0-N1348	TB [DG]	
1.2, 1.2 LPG	03/11-	A 12 XEL, A 12 XER	1229		0-N2170	VB [BT]	S
1.2, 1.2 LPG	03/11-	A 12 XEL, A 12 XER	1229	☼	0-N2341	VB [DG]	
1.4	07/11-	A 14 XER	1398		0-N2170	VB [BT]	S
1.4	07/11-	A 14 XER	1398	☼	0-N2341	VB [DG]	
1.4	12/12-	F14D4	1399	Rippenanzahl: 6; ☼	0-N1646	VB [DG]	
1.4	12/12-	F14D4	1399		0-N1799	VB [BT]	S
1.6	03/11-	F16D4	1598	Rippenanzahl: 6; ☼	0-N1646	VB [DG]	
1.6	03/11-	F16D4	1598		0-N1799	VB [BT]	S

BERETTA Coupe (1_37)

2.3	10/92-09/96	LGO	2260		0-N1691	VB [DG]	
2.8 GT	10/88-09/89	LB6	2838	☼	0-N1688	VB [DG]	
2.8 GT	10/88-09/89	LB6	2838	☼	0-N1690	VB [DG]	
2.8 GT	10/88-09/89	LB6	2838	☼	0-N1848	VB [BT]	S
3.1 LT, 3.1 V6	04/87-12/96	LHO	3135		0-N1848	VB [BT]	S
3.1, 3.1 Z26	10/93-09/96	L82	3135	☼	0-N1688	VB [DG]	
3.1, 3.1 Z26	10/93-09/96	L82	3135	☼	0-N1690	VB [DG]	
3.1, 3.1 Z26	10/93-09/96	L82	3135	☼	0-N1848	VB [BT]	S

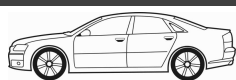

CM³



Art. Nr.



BLAZER S10							
4.3, 4.3 AWD	10/86-09/94	LB4	4300	Rippenanzahl: 6; ✱	0-N1646	VB [DG]	
4.3, 4.3 AWD	10/86-09/94	LB4	4300	✱	0-N1684	VB [DG]	
4.3, 4.3 AWD	10/86-12/94	LB4	4300	✱	0-N1685	VB [DG]	
4.3, 4.3 AWD	10/86-09/94	LB4	4300	✱	0-N1849S	VB [TE]	
BLAZER S10							
4.3	10/94-05/05	L35	4300	✱	0-N1689	VB [DG]	
4.3	10/94-05/05	L35	4300		0-N1697	VB [BT]	S
4.3 AWD	10/94-09/95	LB4	4300		0-N1849S	VB [TE]	
4.3, 4.3 AWD	10/94-05/05	L35, LB4	4300		0-N1684	VB [DG]	
4.3, 4.3 AWD	10/94-09/95	LB4	4300	✱	0-N1685	VB [DG]	
C1500 Pick-up							
4.3	10/91-09/96	LB4	4300		0-N1684	VB [DG]	
4.3	10/91-09/96	LB4	4300	✱	0-N1685	VB [DG]	
4.3	10/91-09/96	LB4	4300		0-N1849S	VB [TE]	
4.3	10/96-09/99	L35	4300	✱	0-N1689	VB [DG]	
4.3	10/96-09/99	L35	4300		0-N1697	VB [BT]	S
4.3, 4.3 AWD	10/91-09/99	L35, LB4	4300	Rippenanzahl: 6; ✱	0-N1646	VB [DG]	
C2500 Pick-up							
4.3	10/91-09/96	LB4	4300		0-N1684	VB [DG]	
4.3	10/91-09/96	LB4	4300	✱	0-N1685	VB [DG]	
4.3	10/91-09/96	LB4	4300		0-N1849S	VB [TE]	
4.3, 4.3 AWD	10/91-09/96	LB4	4300	Rippenanzahl: 6; ✱	0-N1646	VB [DG]	
CAMARO (FP_)							
5.0	10/87-09/92	LO3	5001		0-N1685	VB [DG]	
CAMARO							
3.4 V6	12/92-07/98	L32	3350	✱	0-N1684	VB [DG]	
3.4 V6	12/92-07/98	L32	3350	✱	0-N1690	VB [DG]	
3.8, 3.8 V6	10/95-12/02	L36	3791	Baumuster: → 1998	0-N1685	VB [DG]	
3.8, 3.8 V6	10/95-12/02	L36	3791	Baumuster: l-> 1998	0-N1685	VB [DG]	
5.7	07/98-12/02	LS1	5666		0-N1685	VB [DG]	
5.7	07/98-12/02	LS1	5666		0-N1689	VB [DG]	
5.7 V8	12/92-07/98	LT1 (5.7L)	5733	01/1996 →	0-N1684	VB [DG]	
5.7 V8	12/92-07/98	LT1 (5.7L)	5733	→ 12/1995	0-N1690	VB [DG]	
CAMARO Convertible							
3.4	10/92-09/95	L32	3350	✱	0-N1684	VB [DG]	
3.4	10/92-09/95	L32	3350	✱	0-N1690	VB [DG]	
3.8 V6	07/98-12/02	L36	3791	Baumuster: → 1998	0-N1685	VB [DG]	
3.8 V6	07/98-12/02	L36	3791	Baumuster: l-> 1998	0-N1685	VB [DG]	
5.7	10/92-09/97	LT1 (5.7L)	5733	01/1996 →	0-N1684	VB [DG]	
5.7	10/92-09/97	LT1 (5.7L)	5733	→ 12/1995	0-N1690	VB [DG]	
CAMARO							
3.6	09/09-	LFX, LLT	3564		0-N2340	VB [DG]	
CAMARO Convertible							
3.6	01/11-12/11	LFX, LLT	3564		0-N2340	VB [DG]	
CAPTIVA (C100, C140)							
2.0 D, 2.0 D 4WD	10/06-	Z 20 DMH, Z 20 S	1991	22x151; → 02/2011	SK-1723	BTK	
2.0 D, 2.0 D 4WD	10/06-	Z 20 S	1991	22x151; → 12/2009	SK-1723	BTK	
2.0 D, 2.0 D 4WD	10/06-	Z 20 DMH, Z 20 S, Z 20 S	1991	22x151	SK-1723AQ1	BTKW	
2.4, 2.4 4WD, 2.4 LPG, 2.4 LPG 4WD	06/06-	Z 24 SED	2405	24x171	SK-1644	BTK	
2.4, 2.4 4WD, 2.4 LPG, 2.4 LPG 4WD	06/06-	Z 24 SED	2405	24x171	SK-1644AQ1	BTKW	
2.0 D, 2.0 D 4WD	10/06-	Z 20 DMH, Z 20 S, Z 20 S	1991		0-N1952	TB [TE]	
2.0 D, 2.0 D 4WD	10/06-	Z 20 DMH, Z 20 S, Z 20 S	1991		0-N1960	TB [TE]	
2.4, 2.4 4WD, 2.4 LPG, 2.4 LPG 4WD	06/06-	Z 24 SED	2405		0-N906	TB [DG]	
2.0 D, 2.0 D 4WD	10/06-	Z 20 DMH, Z 20 S, Z 20 S	1991		0-N2171	VB [DG]	
2.0 D, 2.0 D 4WD	10/06-	Z 20 DMH, Z 20 S, Z 20 S	1991		0-N2197	VB [BT]	S
2.2 D, 2.2 D 4WD	03/11-	A 22 DMH, Z 22 D1, Z 22 D1	2231		0-N2420	VB [DG]	
2.2 D, 2.2 D 4WD	03/11-	A 22 DMH, Z 22 D1, Z 22 D1	2231		0-N2421	VB [DG]	
2.4, 2.4 4WD	03/11-	A 24 XE, LE5	2384		0-N2283	VB [DG]	
2.4, 2.4 4WD	03/11-	A 24 XE, LE5	2384		0-N2299	VB [BT]	S
2.4, 2.4 4WD, 2.4 LPG, 2.4 LPG 4WD	06/06-	Z 24 SED	2405		0-N1422	VB [BT]	S
3.0 4WD	01/10-	A 30 XH, LF1	2997		0-N2194	VB [BT]	S
3.2 4WD	06/06-	10 HM	3195		0-N2194	VB [BT]	S

CM³

Art. Nr.



CAVALIER Convertible									
3.1	10/89-09/91	LHO		3135			0-N1688	VB [DG]	
3.1	10/89-09/91	LHO		3135	✳		0-N1690	VB [DG]	
3.1	10/89-09/91	LHO		3135			0-N1848	VB [BT]	S
CAVALIER Coupe									
3.1, 3.1 Z24	10/89-09/94	LHO		3135			0-N1688	VB [DG]	
3.1, 3.1 Z24	10/89-09/94	LHO		3135	✳		0-N1690	VB [DG]	
3.1, 3.1 Z24	10/89-09/94	LHO		3135			0-N1848	VB [BT]	S
CORSA Stufenheck									
1.4 GLS	08/94-07/97	C 14 NZ		1389	17x111; mit Zubehör		SK-1162	BTK	
1.4 GLS	08/94-07/97	C 14 NZ		1389	17x111; ch.→Y4999999, Y6999999; mit Zubehör		SK-1162AQ1	BTKW	
1.6 GS	08/97-07/02	X 16 XE		1598	20x169; mit Zubehör		SK-1073	BTK	
1.6 GS	08/97-07/02	X 16 XE		1598	20x169; mit Zubehör		SK-1073AQ1	BTKW	
1.6 GS	08/97-07/02	X 16 XE		1598			0-N102	TB [TE]	
1.6 GS	08/97-07/02	X 16 XE		1598			0-N952	TB [DG]	
1.6 GS	08/97-07/02	X 16 XE		1598			0-N953	TB [DG]	
1.4 GLS	08/94-07/97	C 14 NZ		1389			0-N1322	VB [TE]	S
1.4 GLS	08/94-07/97	C 14 NZ		1389			0-N1422	VB [BT]	S
1.4 GLS	08/94-07/97	C 14 NZ		1389	Rippenanzahl: 6		0-N1439	VB [DG]	
1.4 GLS	08/94-07/97	C 14 NZ		1389	für Fahrzeuge ohne Servolenkung		0-N1464	VB [BT]	S
1.4 GLS	08/94-07/97	C 14 NZ		1389			0-N948	TB [TE]	
1.6 GS	08/97-07/02	X 16 XE		1598			0-N1322	VB [TE]	S
1.6 GS	08/97-07/02	X 16 XE		1598			0-N1422	VB [BT]	S
1.6 GS	08/97-07/02	X 16 XE		1598	Rippenanzahl: 6		0-N1439	VB [DG]	
1.6 GS	08/97-07/02	X 16 XE		1598	für Fahrzeuge ohne Servolenkung		0-N1464	VB [BT]	S
CORSA Kombi									
1.6 GS	08/97-07/02	X 16 XE		1598			0-N102	TB [TE]	
1.6 GS	08/97-07/02	X 16 XE		1598			0-N952	TB [DG]	
1.6 GS	08/97-07/02	X 16 XE		1598			0-N953	TB [DG]	
1.6 GS	08/97-07/02	X 16 XE		1598	Rippenanzahl: 6		0-N1439	VB [DG]	
1.6 GS	08/97-07/02	X 16 XE		1598	für Fahrzeuge ohne Servolenkung		0-N1464	VB [BT]	S
CORSA Pick-up									
1.4 GLS	08/94-07/97	C 14 NZ		1389	17x111; mit Zubehör		SK-1162	BTK	
1.4 GLS	08/94-07/97	C 14 NZ		1389	17x111; ch.→Y4999999, Y6999999; mit Zubehör		SK-1162AQ1	BTKW	
1.4 GLS	08/94-07/97	C 14 NZ		1389			0-N1322	VB [TE]	S
1.4 GLS	08/94-07/97	C 14 NZ		1389			0-N1422	VB [BT]	S
1.4 GLS	08/94-07/97	C 14 NZ		1389	Rippenanzahl: 6		0-N1439	VB [DG]	
1.4 GLS	08/94-07/97	C 14 NZ		1389	für Fahrzeuge ohne Servolenkung		0-N1464	VB [BT]	S
1.4 GLS	08/94-07/97	C 14 NZ		1389			0-N948	TB [TE]	
CORSA Pick-up									
1.7 DTi	08/01-	Y 17 DT		1686			0-N1085	TB [TE]	
1.7 DTi	08/01-	Y 17 DT		1686			0-N878	TB [DG]	
1.6	08/01-	Z 16 SE		1598			0-N1466	VB [BT]	S
1.6	08/01-	Z 16 SE		1598			0-N948	TB [TE]	
CORSICA (1_69)									
3.1	04/87-12/96	LHO		3135			0-N1848	VB [BT]	S
CORVETTE (C6)									
Z06 7.0	03/06-	LS7		7008			0-N1689	VB [DG]	
CORVETTE									
5.7	01/97-09/04	LS1		5665	05/1997 →		0-N1685	VB [DG]	
5.7	01/97-09/04	LS1		5665	05/1997 →		0-N1689	VB [DG]	
CORVETTE Convertible									
5.7	09/97-09/04	LS1		5665			0-N1685	VB [DG]	
5.7	09/97-09/04	LS1		5665			0-N1689	VB [DG]	
CRUZE (J300)									
1.6	05/09-	F16D3, LXT, LXV, F16D4, F16D4, LDE		1598	24x146		SK-1607	BTK	
1.8, 1.8 LPG	05/09-	2H0, F18D4		1796	24x146		SK-1607	BTK	
2.0 CDI	05/09-	Z 20 DMH, Z 20 S1		1991	22x151		SK-1723	BTK	
2.0 CDI	05/09-	Z 20 S1		1991	22x151; → 05/2011		SK-1723	BTK	
2.0 CDI	05/09-	Z 20 DMH, Z 20 S1, Z 20 S1		1991	22x151		SK-1723AQ1	BTKW	
1.6	05/09-	F16D4, F16D4, LDE		1598			0-N1347	TB [TE]	

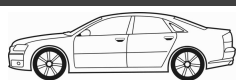

CM³



Art. Nr.



CRUZE (J300)							
1.6	05/09-	F16D4, F16D4, LDE	1598			0-N1348	TB [DG]
1.6	05/09-	F16D3, LXT, LXV	1598			0-N970	TB [TE]
1.6	05/09-	F16D3, LXT, LXV	1598			0-N971	TB [DG]
1.6	12/12-	F16D4	1598			0-N1347	TB [TE]
1.7 D	01/12-	LUD	1686			0-N1085	TB [TE]
1.7 D, 1.7 TD	01/12-	A 17 DTE, LUD	1686			0-N878	TB [DG]
1.8	11/09-	F18D4	1796			0-N1347	TB [TE]
1.8, 1.8 LPG	05/09-	2H0, F18D4	1796			0-N1347	TB [TE]
1.8, 1.8 LPG	05/09-	2H0, F18D4	1796			0-N1348	TB [DG]
2.0 CDI	05/09-	Z 20 DMH, Z 20 S1, Z 20 S1	1991			0-N1952	TB [TE]
2.0 CDI	05/09-	Z 20 DMH, Z 20 S1, Z 20 S1	1991			0-N1960	TB [TE]
1.4	07/13-	A 14 XER, LDD	1398			0-N2170	VB [BT] S
1.4	07/13-	A 14 XER, LDD	1398	☼		0-N2341	VB [DG]
1.6	05/09-	F16D3, LXT, LXV	1598			0-N1532	VB [BT] S
1.6	05/09-	F16D3, LXT, LXV, F16D4, F16D4, LDE	1598	Rippenanzahl: 6; ☼		0-N1646	VB [DG]
1.6	05/09-	F16D4, F16D4, LDE	1598			0-N1799	VB [BT] S
1.6	12/12-	F16D4	1598	Rippenanzahl: 6; ☼		0-N1646	VB [DG]
1.7 D, 1.7 TD	01/12-	A 17 DTE, LUD	1686	☼		0-N2341	VB [DG]
1.7 D, 1.7 TD	01/12-	A 17 DTE, LUD	1686			0-N2389	VB [BT] S
1.8	05/09-	2H0, F18D4	1796	Rippenanzahl: 6; ☼		0-N1646	VB [DG]
1.8	11/09-	F18D4	1796	Rippenanzahl: 6; ☼		0-N1646	VB [DG]
1.8 LPG	06/11-	2H0, F18D4	1796	Rippenanzahl: 6		0-N1646	VB [DG]
1.8, 1.8 LPG	05/09-	2H0, F18D4	1796			0-N1799	VB [BT] S
2.0 CDI	05/09-	Z 20 DMH, Z 20 S1, Z 20 S1	1991			0-N2171	VB [DG]
2.0 CDI	05/09-	Z 20 DMH, Z 20 S1, Z 20 S1	1991			0-N2197	VB [BT] S
2.0 CDI	08/10-	LNP, Z 20 D1	1998			0-N2420	VB [DG]
2.0 CDI	08/10-	LNP, Z 20 D1	1998			0-N2421	VB [DG]
CRUZE Schrägheck (J305)							
1.6	06/11-	F16D4	1598	24x146		SK-1607	BTK
1.6	01/12-	LXT	1598	25x127		SK-1273	BTK
1.6	01/12-	LXT	1598	25x127		SK-1273AQ2	BTKW
1.8, 1.8 LPG	06/11-	F18D4	1796	24x146		SK-1607	BTK
1.6	06/11-	F16D4	1598			0-N1347	TB [TE]
1.6	06/11-	F16D4	1598			0-N1348	TB [DG]
1.7 D	01/12-	LUD	1686			0-N1085	TB [TE]
1.7 D, 1.7 TD	01/12-	A 17 DTE, LUD	1686			0-N878	TB [DG]
1.8	12/12-	F18D4	1796			0-N1347	TB [TE]
1.8, 1.8 LPG	06/11-	F18D4	1796			0-N1347	TB [TE]
1.8, 1.8 LPG	06/11-	F18D4	1796			0-N1348	TB [DG]
1.4	06/12-	LUJ	1362			0-N2170	VB [BT] S
1.4	07/13-	A 14 XER, LDD	1398			0-N2170	VB [BT] S
1.4	07/13-	A 14 XER, LDD	1398	☼		0-N2341	VB [DG]
1.6	06/11-	F16D4, LXT	1598	Rippenanzahl: 6; ☼		0-N1646	VB [DG]
1.6	06/11-	F16D4	1598			0-N1799	VB [BT] S
1.7 D, 1.7 TD	01/12-	A 17 DTE, LUD	1686	☼		0-N2341	VB [DG]
1.7 D, 1.7 TD	01/12-	A 17 DTE, LUD	1686			0-N2389	VB [BT] S
1.8	12/12-	F18D4	1796	Rippenanzahl: 6; ☼		0-N1646	VB [DG]
1.8, 1.8 LPG	06/11-	F18D4	1796	Rippenanzahl: 6; ☼		0-N1646	VB [DG]
1.8, 1.8 LPG	06/11-	F18D4	1796			0-N1799	VB [BT] S
2.0 CDI	06/11-	Z 20 D1	1998			0-N2420	VB [DG]
2.0 CDI	06/11-	Z 20 D1	1998			0-N2421	VB [DG]
CRUZE Station Wagon (J308)							
1.6	08/12-	LDE	1598	24x146		SK-1607	BTK
1.8	08/12-	2H0	1796	24x146		SK-1607	BTK
1.6	08/12-	F16D4, LDE	1598			0-N1347	TB [TE]
1.6	08/12-	LDE	1598			0-N1348	TB [DG]
1.6	12/12-	F16D4	1598			0-N1347	TB [TE]
1.7 TD	08/12-	LUD	1686			0-N1085	TB [TE]
1.7 TD	08/12-	A 17 DTE, LUD	1686			0-N878	TB [DG]
1.8	08/12-	2H0	1796			0-N1347	TB [TE]
1.8	08/12-	2H0	1796			0-N1348	TB [DG]
1.8	12/12-	F18D4	1796			0-N1347	TB [TE]
1.4	08/12-	LUJ	1362			0-N2170	VB [BT] S
1.4	07/13-	A 14 XER, LDD	1398			0-N2170	VB [BT] S



OPTIMAL®

CHEVROLET



CM³



Art. Nr.



CRUZE Station Wagon (J308)

1.4	07/13-	A 14 XER, LDD	1398	☼	0-N2341	VB [DG]	
1.6	08/12-	LDE	1598	Rippenanzahl: 6	0-N1646	VB [DG]	
1.6	12/12-	F16D4	1598	Rippenanzahl: 6; ☼	0-N1646	VB [DG]	
1.7 TD	08/12-	A 17 DTE, LUD	1686	☼	0-N2341	VB [DG]	
1.7 TD	08/12-	A 17 DTE, LUD	1686		0-N2389	VB [BT]	S
1.8	08/12-	2H0	1796	Rippenanzahl: 6	0-N1646	VB [DG]	
1.8	08/12-	2H0	1796		0-N1799	VB [BT]	S
1.8	12/12-	F18D4	1796	Rippenanzahl: 6; ☼	0-N1646	VB [DG]	
2.0 TD	08/12-	LNP	1998		0-N2420	VB [DG]	
2.0 TD	08/12-	LNP	1998		0-N2421	VB [DG]	

EPICA (KL1_)

2.0	01/05-12/06	C 20 SED, C 20 SED, T20SED	1998	24x169	SK-1100	BTK	
2.0	01/05-12/06	C 20 SED, C 20 SED, T20SED	1998	24x169	SK-1100AQ1	BTKW	
2.0	06/06-	X 20 D1	1993	24x169	SK-1100	BTK	
2.0 D	01/07-	Z 20 S	1991	22x151	SK-1723	BTK	
2.0 D	01/07-	Z 20 S	1991	22x151	SK-1723AQ1	BTKW	
2.0	01/05-12/06	C 20 SED, C 20 SED, T20SED	1998		0-N100	TB [TE]	
2.0	01/05-12/06	C 20 SED, C 20 SED, T20SED	1998		0-N906	TB [DG]	
2.0	08/06-	X 20 SE	1998		0-N101	TB [TE]	
2.0 D	01/07-	Z 20 S	1991		0-N1952	TB [TE]	
2.0 D	01/07-	Z 20 S	1991		0-N1960	TB [TE]	
2.0	01/05-12/06	C 20 SED, C 20 SED, T20SED	1998		0-N1422	VB [BT]	S
2.0 D	01/07-	Z 20 S	1991		0-N2171	VB [DG]	
2.0 D	01/07-	Z 20 S	1991		0-N2197	VB [BT]	S

EVANDA

2.0	03/05-	X 20 SED	1998	24x169	SK-1100	BTK	
2.0	03/05-	X 20 SED	1998	24x169	SK-1100AQ1	BTKW	
2.0	03/05-	X 20 SED	1998		0-N100	TB [TE]	
2.0	03/05-	X 20 SED	1998		0-N906	TB [DG]	
2.0	03/05-	X 20 SED	1998		0-N1422	VB [BT]	S

HHR

2.4	01/06-12/11	LE5	2384		0-N2283	VB [DG]	
2.4	01/06-12/11	LE5	2384		0-N2299	VB [BT]	S
2.4	10/07-12/11	LE5	2384		0-N1588	VB [BT]	S

IMPALA Stufenheck

3.4 V6	01/99-12/05	LA1	3350	10/1999 →	0-N1684	VB [DG]	
3.4 V6	01/99-12/05	LA1	3350	10/1999 →	0-N1848	VB [BT]	S
3.8 V6	01/99-12/05	L36	3791	10/1999 →	0-N1685	VB [DG]	
3.8 V6	01/99-12/05	L36	3791	10/1999 →	0-N1688	VB [DG]	
3.8 V6	01/99-12/05	L36	3791	10/1999 →	0-N1690	VB [DG]	

KALOS

1.2	03/05-	B12S1	1150	25x109	SK-1685	BTK	
1.2	03/05-	B12S1	1150	25x109	SK-1685AQ1	BTKW	
1.4	03/05-	F14S3	1399	17x111; mit Zubehör	SK-1162	BTK	
1.4	03/05-	F14S3	1399	17x111	SK-1162AQ3	BTKW	
1.4 16V	03/05-	F14D3	1399	25x127	SK-1273	BTK	
1.4 16V	03/05-	F14D3	1399	25x127	SK-1273AQ2	BTKW	
1.2	03/05-	B12S1	1150		0-N973	TB [TE]	
1.4 16V	03/05-	F14D3	1399		0-N970	TB [TE]	
1.4 16V	03/05-	F14D3	1399		0-N971	TB [DG]	
1.6	06/06-05/08	L91	1598		0-N970	TB [TE]	
1.6	06/06-05/08	L91	1598		0-N971	TB [DG]	
1.4	03/05-	F14S3	1399		0-N948	TB [TE]	
1.4, 1.4 16V	03/05-	F14D3, F14S3	1399		0-N1532	VB [BT]	S
1.4, 1.4 16V	03/05-	F14D3, F14S3	1399	Rippenanzahl: 6; ☼	0-N1646	VB [DG]	
1.6	06/06-05/08	L91	1598		0-N1532	VB [BT]	S

KALOS Stufenheck

1.2	03/05-	F12S3	1150	25x109	SK-1685	BTK	
1.2	03/05-	F12S3	1150	25x109	SK-1685AQ1	BTKW	
1.4	03/05-	F14S3	1399	17x111; mit Zubehör	SK-1162	BTK	
1.4 16V	03/05-	F14D3	1399	25x127	SK-1273	BTK	
1.4 16V	03/05-	F14D3	1399	25x127	SK-1273AQ2	BTKW	
1.4 16V	03/05-	F14D3	1399		0-N970	TB [TE]	



CM³



Art. Nr.



KALOS Stufenheck							
1.4 16V	03/05-	F14D3	1399			0-N971	TB [DG]
1.2	03/05-	F12S3	1150			0-N1532	VB [BT] S
1.2	03/05-	F12S3	1150	Rippenanzahl: 6; ☼		0-N1646	VB [DG]
1.2	03/05-	F12S3	1150			0-N948	TB [TE]
1.4	03/05-	F14S3	1399			0-N948	TB [TE]
1.4, 1.4 16V	03/05-	F14D3, F14S3	1399			0-N1532	VB [BT] S
1.4, 1.4 16V	03/05-	F14D3, F14S3	1399	Rippenanzahl: 6; ☼		0-N1646	VB [DG]
LACETTI (J200)							
1.4 16V	03/05-	F14D3	1399	25x127		SK-1273	BTK
1.4 16V	03/05-	F14D3	1399	25x127		SK-1273AQ2	BTKW
1.6	03/05-	F16D3	1598	25x127		SK-1273	BTK
1.6	03/05-	F16D3	1598	25x127		SK-1273AQ2	BTKW
1.8	03/05-	T18SED	1799	24x169		SK-1100	BTK
1.8	03/05-	T18SED	1799	24x169		SK-1100AQ1	BTKW
1.8	08/05-	F18D3	1796	24x169		SK-1100	BTK
1.8	08/05-	F18D3	1796	20x162; mit Zubehör		SK-1355	BTK
2.0 D	01/07-	Z 20 DM	1991	22x151		SK-1723	BTK
2.0 D	01/07-	Z 20 DM	1991	22x151		SK-1723AQ1	BTKW
1.4 16V	03/05-	F14D3	1399			0-N970	TB [TE]
1.4 16V	03/05-	F14D3	1399			0-N971	TB [DG]
1.6	03/05-	F16D3	1598			0-N970	TB [TE]
1.6	03/05-	F16D3	1598			0-N971	TB [DG]
1.8	03/05-	T18SED	1799			0-N100	TB [TE]
1.8	03/05-	T18SED	1799			0-N906	TB [DG]
1.8	08/05-	F18D3	1796			0-N102	TB [TE]
1.8	08/05-	F18D3	1796	†; mit Anbaumaterial		0-N300	TB [DG]
1.8	08/05-	F18D3	1796			0-N953	TB [DG]
2.0 D	01/07-	Z 20 DM	1991			0-N1952	TB [TE]
2.0 D	01/07-	Z 20 DM	1991			0-N1960	TB [TE]
1.4 16V	03/05-	F14D3	1399			0-N1532	VB [BT] S
1.4 16V	03/05-	F14D3	1399	Rippenanzahl: 6; ☼		0-N1646	VB [DG]
1.6	03/05-	F16D3	1598			0-N1532	VB [BT] S
1.6	03/05-	F16D3	1598	Rippenanzahl: 6; ☼		0-N1646	VB [DG]
1.8	03/05-	T18SED	1799			0-N1422	VB [BT] S
1.8	08/05-	F18D3	1796			0-N1466	VB [BT] S
2.0 D	01/07-	Z 20 DM	1991			0-N2171	VB [DG]
2.0 D	01/07-	Z 20 DM	1991			0-N2197	VB [BT] S
LACETTI Kombi (J200)							
1.6	03/05-	F16D3	1598	Rippenanzahl: 6; ☼		0-N1646	VB [DG]
LANOS Schrägheck							
1.4	11/05-		1349	17x111; mit Zubehör; Baumuster: ATF48		SK-1162	BTK
1.5	11/05-	A15SMS	1498	17x111; mit Zubehör; Baumuster: ATF48		SK-1162	BTK
1.6 16V	11/05-	A16DMS	1598	25x127; Baumuster: ATA48, ATF48		SK-1273	BTK
1.6 16V	11/05-	A16DMS	1598	25x127		SK-1273AQ1	BTKW
1.6 16V	11/05-	A16DMS	1598			0-N970	TB [TE]
1.6 16V	11/05-	A16DMS	1598			0-N971	TB [DG]
1.4	11/05-		1349			0-N948	TB [TE]
1.5	11/05-	A15SMS	1498			0-N948	TB [TE]
1.6 16V	11/05-	A16DMS	1598			0-N1532	VB [BT] S
LANOS Stufenheck							
1.4	11/05-	A 13 SM	1349	17x111; mit Zubehör; Baumuster: ATF69		SK-1162	BTK
1.5	11/05-	A15SMS	1498	17x111; mit Zubehör; Baumuster: ATF69		SK-1162	BTK
1.6 16V	11/05-	A16DMS	1598	25x127; Baumuster: ATA69, ATF69		SK-1273	BTK
1.6 16V	11/05-	A16DMS	1598	25x127		SK-1273AQ1	BTKW
1.6 16V	11/05-	A16DMS	1598			0-N970	TB [TE]
1.6 16V	11/05-	A16DMS	1598			0-N971	TB [DG]
1.4	11/05-	A 13 SM	1349			0-N948	TB [TE]
1.5	11/05-	A15SMS	1498			0-N948	TB [TE]
1.6 16V	11/05-	A16DMS	1598			0-N1532	VB [BT] S
1.4	11/05-	A 13 SM	1349			0-N2097	FB [DG]
1.5	11/05-	A15SMS	1498			0-N2097	FB [DG]
1.6 16V	11/05-	A16DMS	1598			0-N2097	FB [DG]



CM³



Art. Nr.



LOVA									
1.4	08/05-	F14D3	1399			0-N970	TB [TE]		
1.4	08/05-	F14D3	1399			0-N971	TB [DG]		
1.6	08/05-	A16DMS	1598			0-N970	TB [TE]		
1.6	08/05-	A16DMS	1598			0-N971	TB [DG]		
1.4	08/05-	F14D3, F14S3	1399			0-N1532	VB [BT]		S
1.4	08/05-	F14D3, F14S3	1399	Rippenanzahl: 6;		0-N1646	VB [DG]		
1.4	08/05-	F14S3	1399			0-N948	TB [TE]		
1.6	08/05-	A16DMS	1598			0-N1532	VB [BT]		S
LUMINA Coupe									
3.1	10/89-09/94	LHO	3135			0-N1688	VB [DG]		
3.1	10/89-09/94	LHO	3135			0-N1690	VB [DG]		
3.1	10/89-09/94	LHO	3135			0-N1848	VB [BT]		S
LUMINA Stufenheck									
3.1	10/89-09/94	LHO	3135			0-N1690	VB [DG]		
3.1, 3.1 LS	10/89-09/94	L82, LHO	3135			0-N1688	VB [DG]		
3.1, 3.1 LS	10/89-09/94	L82, LHO	3135			0-N1848	VB [BT]		S
LUMINA Stufenheck									
3.1, 3.1 LS	10/94-09/97	L82	3135			0-N1684	VB [DG]		
3.1, 3.1 LS	10/94-09/97	L82, LHO	3135			0-N1688	VB [DG]		
3.1, 3.1 LS	10/94-09/97	L82, LHO	3135			0-N1848	VB [BT]		S
MALIBU (V300)									
2.0 D	04/12-	LBS	1956			0-N2149	TB [DG]		
2.0 D	04/12-	LBS	1956	für Fahrzeuge mit elektrischer Servolenkung		0-N2254	VB [DG]		
2.4	01/12-	LE9	2384			0-N1588	VB [BT]		S
2.4	01/12-	LE9	2384			0-N2283	VB [DG]		
2.4	01/12-	LE9	2384			0-N2299	VB [BT]		S
MATIZ (M200, M250)									
0.8, 0.8 LPG	03/05-	F8CV	796	25.4x107		SK-1183	BTK		
0.8, 0.8 LPG	03/05-	F8CV	796	25.4x107		SK-1183AQ1	BTKW		
1.0	03/05-	B10S1	995	25x109; Baumuster: Matiz		SK-1685AQ1	BTKW		
1.0	01/07-	LA2	995	25x109		SK-1685	BTK		
1.0, 1.0 LPG	03/05-	B10S, B10S1	995	25x109; Baumuster: M200		SK-1685	BTK		
1.0, 1.0 LPG	03/05-	B10S, B10S1, LA2	995	25x109		SK-1685AQ1	BTKW		
0.8, 0.8 LPG	03/05-	F8CV	796			0-N973	TB [TE]		
1.0, 1.0 LPG	03/05-	B10S, B10S1	995			0-N973	TB [TE]		
NIVA									
1.8 4x4	01/07-12/09	Z 18 XE	1796			0-N102	TB [TE]		
1.8 4x4	01/07-12/09	Z 18 XE	1796	†; mit Anbaumaterial		0-N300	TB [DG]		
1.8 4x4	01/07-12/09	Z 18 XE	1796			0-N953	TB [DG]		
1.8 4x4	01/07-12/09	Z 18 XE	1796			0-N1466	VB [BT]		S
NUBIRA Kombi									
1.6	03/05-	F16D3	1598	25x127		SK-1273	BTK		
1.6	03/05-	F16D3	1598	25x127		SK-1273AQ2	BTKW		
1.8	03/05-	T18SED	1799	24x169		SK-1100	BTK		
1.8	03/05-	T18SED	1799	24x169		SK-1100AQ1	BTKW		
1.8	03/05-	T18SED	1799	20x162; mit Zubehör		SK-1355	BTK		
1.8	08/05-	F18D3	1796	24x169		SK-1100	BTK		
1.8	08/05-	F18D3	1796	20x162; mit Zubehör		SK-1355	BTK		
2.0 D	01/07-	Z 20 DM, Z 20 S	1991	22x151		SK-1723	BTK		
2.0 D	01/07-	Z 20 DM, Z 20 S	1991	22x151		SK-1723AQ1	BTKW		
1.6	03/05-	F16D3	1598			0-N970	TB [TE]		
1.6	03/05-	F16D3	1598			0-N971	TB [DG]		
1.8	03/05-	T18SED	1799			0-N100	TB [TE]		
1.8	03/05-	T18SED	1799			0-N906	TB [DG]		
1.8	08/05-	F18D3	1796			0-N102	TB [TE]		
1.8	08/05-	F18D3	1796	†; mit Anbaumaterial		0-N300	TB [DG]		
1.8	08/05-	F18D3	1796			0-N953	TB [DG]		
2.0	01/05-		1998			0-N100	TB [TE]		
2.0	01/05-		1998			0-N906	TB [DG]		
2.0 D	01/07-	Z 20 DM, Z 20 S	1991			0-N1952	TB [TE]		
2.0 D	01/07-	Z 20 DM, Z 20 S	1991			0-N1960	TB [TE]		
1.5	01/05-		1498			0-N948	TB [TE]		
1.6	03/05-	F16D3	1598			0-N1532	VB [BT]		S



CM³



Art. Nr.



ohne Halter

NUBIRA Kombi							
1.6	03/05-	F16D3	1598	Rippenanzahl: 6; ☼	0-N1646	VB [DG]	
1.8	03/05-	T18SED	1799		0-N1422	VB [BT]	S
1.8	08/05-	F18D3	1796		0-N1466	VB [BT]	S
2.0 D	01/07-	Z 20 DM, Z 20 S	1991		0-N2171	VB [DG]	
2.0 D	01/07-	Z 20 DM, Z 20 S	1991		0-N2197	VB [BT]	S
NUBIRA Stufenheck							
1.4	01/05-	F14D3	1399	25x127	SK-1273	BTK	
1.4	01/05-	F14D3	1399	25x127	SK-1273AQ2	BTKW	
1.6	03/05-	F16D3	1598	25x127	SK-1273	BTK	
1.6	03/05-	F16D3	1598	25x127	SK-1273AQ2	BTKW	
1.8	03/05-	T18SED	1799	24x169	SK-1100	BTK	
1.8	03/05-	T18SED	1799	24x169	SK-1100AQ1	BTKW	
1.8	03/05-	T18SED	1799	20x162; mit Zubehör	SK-1355	BTK	
1.8	01/06-	F18D3	1796	20x162; mit Zubehör	SK-1355	BTK	
2.0 D	01/05-	Z 20 S	1991	22x151; 08/2006 →	SK-1723	BTK	
2.0 D	01/05-	Z 20 S	1991	22x151	SK-1723AQ1	BTKW	
1.4	01/05-	F14D3	1399		0-N970	TB [TE]	
1.4	01/05-	F14D3	1399		0-N971	TB [DG]	
1.6	03/05-	F16D3	1598		0-N970	TB [TE]	
1.6	03/05-	F16D3	1598		0-N971	TB [DG]	
1.8	03/05-	T18SED	1799		0-N100	TB [TE]	
1.8	03/05-	T18SED	1799		0-N906	TB [DG]	
1.8	01/06-	F18D3	1796		0-N102	TB [TE]	
1.8	01/06-	F18D3	1796	☼; mit Anbaumaterial	0-N300	TB [DG]	
1.8	01/06-	F18D3	1796		0-N953	TB [DG]	
2.0	01/05-	F 20 D2	1998		0-N100	TB [TE]	
2.0	01/05-	F 20 D2	1998		0-N906	TB [DG]	
2.0 D	01/05-	Z 20 S	1991		0-N1952	TB [TE]	
2.0 D	01/05-	Z 20 S	1991		0-N1960	TB [TE]	
1.4	01/05-	F14D3	1399		0-N1532	VB [BT]	S
1.4	01/05-	F14D3	1399	Rippenanzahl: 6; ☼	0-N1646	VB [DG]	
1.5	01/05-	F 15 D2	1498		0-N948	TB [TE]	
1.6	03/05-	F16D3	1598		0-N1532	VB [BT]	S
1.6	03/05-	F16D3	1598	Rippenanzahl: 6; ☼	0-N1646	VB [DG]	
1.8	03/05-	T18SED	1799		0-N1422	VB [BT]	S
1.8	01/06-	F18D3	1796		0-N1466	VB [BT]	S
2.0 D	01/05-	Z 20 S	1991		0-N2171	VB [DG]	
2.0 D	01/05-	Z 20 S	1991		0-N2197	VB [BT]	S
OPALA Stufenheck							
2.5 TDiC 4x4	01/71-12/81	LR8	2471		0-N2225	TB [TE]	
OPTRA							
2.0	06/99-07/03	X 20 SED	1998		0-N100	TB [TE]	
2.0	06/99-07/03	X 20 SED	1998		0-N906	TB [DG]	
OPTRA (1J_)							
1.6	08/03-12/08	LXT	1598	25x127	SK-1273	BTK	
1.6	08/03-12/08	LXT	1598	25x127	SK-1273AQ2	BTKW	
1.8	08/03-12/08	T18SED	1799	24x169	SK-1100	BTK	
1.8	08/03-12/08	T18SED	1799	24x169	SK-1100AQ1	BTKW	
1.6	08/03-12/08	F16D3, LXT	1598		0-N970	TB [TE]	
1.6	08/03-12/08	F16D3, LXT	1598		0-N971	TB [DG]	
1.8	08/03-12/08	T18SED	1799		0-N100	TB [TE]	
1.8	08/03-12/08	T18SED	1799		0-N906	TB [DG]	
1.6	08/03-12/08	F16D3, LXT	1598		0-N1532	VB [BT]	S
1.6	08/03-12/08	F16D3, LXT	1598	Rippenanzahl: 6; ☼	0-N1646	VB [DG]	
OPTRA Kombi							
1.6	06/06-12/08	F16D3	1598		0-N970	TB [TE]	
1.6	06/06-12/08	F16D3	1598		0-N971	TB [DG]	
1.6	06/06-12/08	F16D3	1598		0-N1532	VB [BT]	S
1.6	06/06-12/08	F16D3	1598	Rippenanzahl: 6; ☼	0-N1646	VB [DG]	
ORLANDO (J309)							
1.8, 1.8 LPG	02/11-	2H0, 2H0, F18D4	1796	24x146	SK-1607	BTK	
1.8, 1.8 LPG	02/11-	2H0, 2H0, F18D4	1796		0-N1347	TB [TE]	
1.8, 1.8 LPG	02/11-	2H0, 2H0, F18D4	1796		0-N1348	TB [DG]	

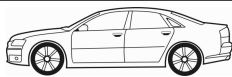
CM³

Art. Nr.



ohne Halter

ORLANDO (J309)

1.4	06/12-	LUJ	1362		0-N2170	VB [BT]	S
1.8, 1.8 LPG	02/11-	2H0, 2H0, F18D4	1796	Rippenanzahl: 6	0-N1646	VB [DG]	
1.8, 1.8 LPG	02/11-	2H0, 2H0, F18D4	1796		0-N1799	VB [BT]	S
2.0 D	02/11-	Z 20 D1	1998		0-N2420	VB [DG]	
2.0 D	02/11-	Z 20 D1	1998		0-N2421	VB [DG]	

REZZO

1.6	03/05-	A16DMS	1598	25x127	SK-1273	BTK	
1.6	03/05-	A16DMS	1598	25x127	SK-1273AQ2	BTKW	
2.0	03/05-	T20SED	1998	24x169	SK-1100	BTK	
2.0	03/05-	T20SED	1998	24x169	SK-1100AQ1	BTKW	
1.6	03/05-	A16DMS	1598		0-N970	TB [TE]	
1.6	03/05-	A16DMS	1598		0-N971	TB [DG]	
2.0	03/05-	T20SED	1998		0-N100	TB [TE]	
2.0	03/05-	T20SED	1998		0-N906	TB [DG]	
1.6	03/05-	A16DMS	1598		0-N1532	VB [BT]	S
2.0	03/05-	T20SED	1998		0-N1422	VB [BT]	S

SILVERADO 1500

5.3 AWD	10/99-	LM7	5324		0-N1846	VB [BT]	S
---------	--------	-----	------	--	---------	---------	---

SILVERADO 2500 HD

6.6 Di, 6.6 Di AWD	10/01-	LB7, LMM	6596		0-N1689	VB [DG]	
--------------------	--------	----------	------	--	---------	---------	--

SPARK

0.8	09/00-12/04	F8CV	796	25.4x107; 11/2002 →	SK-1183	BTK	
0.8	09/00-12/04	F8CV	796	25.4x107	SK-1183AQ1	BTKW	
1.0	11/02-12/04	G 10 CV	993	25x109	SK-1685	BTK	
1.0	11/02-12/04	G 10 CV	993	25x109	SK-1685AQ1	BTKW	
0.8	09/00-12/04	F8CV	796		0-N973	TB [TE]	

SPARK

0.8	05/05-	F8CV	796	25.4x107; 09/2005 →	SK-1183	BTK	
0.8	05/05-	F8CV	796	25.4x107	SK-1183AQ1	BTKW	
1.0 SX	05/05-	B10S, LA2, B10S1, LA2	995	25x109	SK-1685	BTK	
1.0 SX	05/05-	B10S1	995	25x109	SK-1685AQ1	BTKW	
0.8	05/05-	F8CV	796		0-N973	TB [TE]	
1.0 SX	05/05-	B10S, LA2, B10S1, LA2	995		0-N973	TB [TE]	

SPARK (M300)

1.0, 1.0 LPG	03/10-	B10D1	995	mit Anbaumaterial	0-N2274	VB [TE]	
1.2, 1.2 LPG	03/10-	B12D1, LMU	1206	mit Anbaumaterial	0-N2274	VB [TE]	

SUBURBAN

7.4 AWD	10/86-09/91	L19	7440	⊛	0-N1684	VB [DG]	
---------	-------------	-----	------	---	---------	---------	--

TAHOE (B2W)

4.8	05/00-12/06	LR4	4806	⊛	0-N1690	VB [DG]	
4.8	05/00-12/06	LR4	4806		0-N1846	VB [BT]	S
4.8 V8	12/99-12/06	LR4	4808	05/2000 →; ⊛	0-N1690	VB [DG]	
4.8 V8	12/99-12/06	LR4	4808	05/2000 →	0-N1846	VB [BT]	S
5.3 V8	12/99-12/06	LM7	5327	01/2000 →	0-N1846	VB [BT]	S
5.3, 5.3 AWD	05/00-12/06	L59, LM7	5327		0-N1846	VB [BT]	S
5.3, 5.3 V8	12/99-12/06	LM7	5327	⊛	0-N1690	VB [DG]	

TRAILBLAZER (KC_)

4.2 AWD	09/01-09/08	LL8	4157		0-N1685	VB [DG]	
4.2 AWD	09/01-09/08	LL8	4157		0-N1686	VB [DG]	
6.0 AWD	08/05-12/07	LS2	5967	09/2006 → 02/2008	0-N1846	VB [BT]	S

TRANS SPORT

3.4	08/96-09/05	LA1	3350		0-N1684	VB [DG]	
3.4, 3.4 V6, 3.4 V6 AWD	08/96-09/05	LA1	3350		0-N1658	VB [BT]	

TRAX

1.6	12/12-	F16D4, LDE	1598	24x146	SK-1607	BTK	
1.6	12/12-	F16D4, LDE	1598		0-N1347	TB [TE]	
1.6	12/12-	F16D4, LDE	1598		0-N1348	TB [DG]	
1.7 TD, 1.7 TD AWD	12/12-	LUD	1686		0-N878	TB [DG]	
1.8	03/13-	2H0, F18D4	1796		0-N1347	TB [TE]	
1.4, 1.4 AWD	12/12-	LUJ, LUJ, LUV	1364		0-N2170	VB [BT]	S
1.7 TD, 1.7 TD AWD	12/12-	LUD	1686	⊛	0-N2341	VB [DG]	



CM³



Art. Nr.



ohne Halter

TRAX								
1.7 TD, 1.7 TD AWD	12/12-	LUD	1686			0-N2389	VB [BT]	S
VECTRA								
2.0	03/96-12/05	20 NEJ, C 20 NE	1998	20x146		SK-1169	BTK	
2.2 GLS	05/98-12/05	C 22 SEL	2198	24x171		SK-1644AQ1	BTKW	
2.0	03/96-04/98	C 20 SEL	1998			0-N100	TB [TE]	
2.0	03/96-12/05	20 NEJ, C 20 NE	1998			0-N101	TB [TE]	
2.0	03/96-04/98	C 20 SEL	1998			0-N906	TB [DG]	
VECTRA								
2.8	11/05-09/06	Z 28 NET	2792			0-N2194	VB [BT]	S
VIVA								
1.8	09/03-03/08	Z 18 XE	1796	20x162; mit Zubehör		SK-1355	BTK	
1.8	09/03-03/08	Z 18 XE	1796	20x162; mit Zubehör		SK-1355AQ1	BTKW	
1.8	09/03-03/08	Z 18 XE	1796			0-N102	TB [TE]	
1.8	09/03-03/08	Z 18 XE	1796	EMARKING: 02HL5118, 20041691 →; †; mit Anbaumaterial		0-N300	TB [DG]	
1.8	09/03-03/08	Z 18 XE	1796	†; mit Anbaumaterial		0-N300	TB [DG]	
1.8	09/03-03/08	Z 18 XE	1796	EMARKING: →02HL5117, 20041690		0-N952	TB [DG]	
1.8	09/03-03/08	Z 18 XE	1796			0-N953	TB [DG]	
1.8	09/03-03/08	Z 18 XE	1796			0-N1466	VB [BT]	S
VIVANT								
1.6	08/01-	A16DMS	1598			0-N970	TB [TE]	
1.6	08/01-	A16DMS	1598			0-N971	TB [DG]	
2.0, 2.0 CX	08/00-	T20SED, X 20 SED	1998			0-N100	TB [TE]	
2.0, 2.0 CX	08/00-	T20SED, X 20 SED	1998			0-N906	TB [DG]	
1.6	08/01-	A16DMS	1598			0-N1532	VB [BT]	S
2.0, 2.0 CX	08/00-	T20SED, X 20 SED	1998	Rippenanzahl: 6; ✱		0-N1646	VB [DG]	
VIVANT								
1.6	01/05-	A16DMS	1598	25x127		SK-1273	BTK	
1.6	01/05-	A16DMS	1598	25x127		SK-1273AQ2	BTKW	
2.0 CX	01/05-	T20SED	1998	24x169		SK-1100	BTK	
2.0 CX	01/05-	T20SED	1998	24x169		SK-1100AQ1	BTKW	
1.6	01/05-	A16DMS	1598			0-N970	TB [TE]	
1.6	01/05-	A16DMS	1598			0-N971	TB [DG]	
2.0, 2.0 CX	01/05-	T20SED, X 20 SED	1998			0-N100	TB [TE]	
2.0, 2.0 CX	01/05-	T20SED, X 20 SED	1998			0-N906	TB [DG]	
1.6	01/05-	A16DMS	1598			0-N1532	VB [BT]	S
2.0, 2.0 CX	01/05-	T20SED, X 20 SED	1998	Rippenanzahl: 6; ✱		0-N1646	VB [DG]	
ZAFIRA (F75)								
1.8	07/00-06/05	Z 18 XE	1796			0-N102	TB [TE]	
1.8	07/00-06/05	Z 18 XE	1796	†; mit Anbaumaterial		0-N300	TB [DG]	
1.8	07/00-06/05	Z 18 XE	1796			0-N953	TB [DG]	
2.0	04/01-	C 20 SEL, X 20 XE	1998			0-N100	TB [TE]	
2.0	04/01-07/04	X 20 SE	1998			0-N101	TB [TE]	
2.0	04/01-	C 20 SEL, X 20 XE	1998			0-N906	TB [DG]	
1.8	07/00-06/05	Z 18 XE	1796			0-N1466	VB [BT]	S
2.0	04/01-07/04	C 20 NE, C 20 SEL, X 20 XE	1998			0-N1422	VB [BT]	S
2.0	08/04-	X 20 SED	1998	Rippenanzahl: 6; ✱		0-N1646	VB [DG]	
HHR [USA] Kombi								
2.4	01/06-12/08		2376			0-N2299	VB [BT]	S
SPIN								
1.2	01/12-	A 12 XER	1229	✱		0-N2341	VB [DG]	
1.3 D	01/12-	Z 13 DTJ	1248			0-N2390	VB [BT]	S
TRAVERSE [USA]								
3.6 AWD	01/09-12/11		3564			0-N2340	VB [DG]	

CM³

Art. Nr.



ohne Halter

AVEO (T250)

1.4	07/05-05/10	L95	1399		0-N970	TB [TE]	
1.4	07/05-05/10	L95	1399		0-N971	TB [DG]	
1.6	03/08-05/10	F16D3D	1598		0-N970	TB [TE]	
1.6	03/08-05/10	F16D3D	1598		0-N971	TB [DG]	
1.4	07/05-05/10	L95	1399		0-N1532	VB [BT]	S

BLAZER Geländewagen geschlossen

2.3 RWD	08/01-08/04	LG1	2290		0-N101	TB [TE]	
---------	-------------	-----	------	--	--------	---------	--

CRUZE Stufenheck

1.6	04/09-	LDE	1598		0-N1347	TB [TE]	
1.8	04/09-	2H0	1796		0-N1347	TB [TE]	
1.6	04/09-	LDE	1598		0-N1799	VB [BT]	S
1.8	04/09-	2H0	1796		0-N1799	VB [BT]	S

EPICA

1.8	10/09-	2H0	1797		0-N1347	TB [TE]	
2.0	04/06-09/09	L34, T20SED	1998		0-N100	TB [TE]	
2.0	04/06-09/09	L34, T20SED	1998		0-N906	TB [DG]	
1.8	10/09-	2H0	1797		0-N1799	VB [BT]	S

LOVA (T250)

1.4	03/06-07/11	L95	1399		0-N970	TB [TE]	
1.4	03/06-07/11	L95	1399		0-N971	TB [DG]	
1.6	03/06-03/11	F16D3D	1598		0-N970	TB [TE]	
1.6	03/06-03/11	F16D3D	1598		0-N971	TB [DG]	
1.4	03/06-07/11	L95	1399		0-N1532	VB [BT]	S
1.6	03/06-03/11	F16D3D	1598		0-N1532	VB [BT]	S

SAIL Kombi

1.6	02/05-12/07	L01	1598	Rippenanzahl: 6	0-N1439	VB [DG]	
1.6	02/05-12/07	L01	1598		0-N948	TB [TE]	

SAIL Stufenheck

1.6	02/05-12/07	L01	1598	Rippenanzahl: 6	0-N1439	VB [DG]	
1.6	02/05-12/07	L01	1598		0-N948	TB [TE]	



CM³



Art. Nr.



ohne Halter

SPARK							
0.8	12/03-03/09	F8CV	796		0-N973	TB [TE]	
1.0	12/04-04/10	B10S1	995		0-N973	TB [TE]	

CM³

Art. Nr.



ohne Halter

300 C (LX)

2.7	09/04-11/12	2.7FX, EER, EES	2736		0-N2233	VB [TE]	
3.0 CRD, 3.0 V6 CRD	09/05-11/12	EXL	2987		0-N1560	VB [DG]	
3.0 CRD, 3.0 V6 CRD	09/05-11/12	EXL	2987		0-N1902	VB [BT]	S
3.5	09/04-11/12	3.5CSP	3518	Rippenanzahl: 6	0-N1431	VB [DG]	
5.7 SRT8	09/04-12/08	EZB, EZD, EZH	5654		0-N1686	VB [DG]	
6.1 SRT8	06/05-11/12	ESF	6059		0-N1686	VB [DG]	
6.1 SRT8	06/05-11/12	ESF	6063		0-N1686	VB [DG]	

300 C Touring (LX)

2.7	09/04-12/10	2.7FX, EER, EES	2736		0-N2233	VB [TE]	
3.0 CRD	09/05-12/10	EXL	2987		0-N1560	VB [DG]	
3.0 CRD	09/05-12/10	EXL	2987		0-N1902	VB [BT]	S
5.7, 5.7 AWD	09/04-12/10	EZB, EZD, EZH, EZB, EZH	5654		0-N1686	VB [DG]	
6.1 SRT8	06/05-12/10	ESF	6059		0-N1686	VB [DG]	

300 M (LR)

3.5 V6 24V	07/98-09/04	EGG	3518		0-N2327	TB [TE]	
2.7 V6 24V	11/98-09/04	EER	2736		0-N2233	VB [TE]	

CIRRUS

2.4 LX	05/94-09/00	EDZ	2429	28x146	SK-1700	BTK	
2.4 LX	05/94-09/00	EDZ	2429	28x146	SK-1701	BTK	
2.4 LX	05/94-09/00	EDZ	2429		0-N1962	TB [DG]	
2.5 LX	10/94-09/00	EEB	2497		0-N185	TB [TE]	
2.5 LX	10/94-09/00	EEB	2497		0-N189	TB [DG]	

CIRRUS

2.4	09/00-04/07	EDZ	2429	→ 12/2001	0-N021	TB [TE]	
2.4	09/00-04/07	EDZ	2429	01/2003 →	0-N1838S	TB [TE]	

CIRRUS [USA] Stufenheck

2.5	01/95-12/97		2497		0-N185	TB [TE]	
-----	-------------	--	------	--	--------	---------	--

CONCORDE

3.3 LX	10/92-09/97	EGB	3301		0-N1698	VB [BT]	S
3.5 LX	10/92-09/97	EGE	3518		0-N1698	VB [BT]	S
3.3 LX	10/92-09/97	EGB	3301		0-N1693	FB [DG]	

CONCORDE

2.7 LX	10/97-09/03	EER	2736		0-N2233	VB [TE]	
--------	-------------	-----	------	--	---------	---------	--

CROSSFIRE

3.2, SRT-6	07/03-12/08	EGX, EGZ	3199		0-N1645	VB [BT]	S
3.2, SRT-6	07/03-12/08	EGX, EGZ	3199		0-N2142	VB [VD]	

CROSSFIRE Roadster

3.2, SRT-6	05/04-12/08	EGX, EGZ	3199		0-N1645	VB [BT]	S
3.2, SRT-6	05/04-12/08	EGX, EGZ	3199		0-N2142	VB [VD]	

DELTA

1.4, 1.4 16V	08/11-	198 A4.000, 198 A7.000	1368	22x124	SK-1412	BTK	
1.4, 1.4 16V	08/11-	198 A4.000, 198 A7.000	1368	22x124	SK-1412AQ2	BTKW	
1.6 D Multijet	08/11-	198 A2.000	1598	24x194	SK-1693	BTK	
1.6 D Multijet	08/11-	198 A2.000	1598	24x194	SK-1693AQ1	BTKW	
2.0 D Multijet	08/11-	198 A5.000	1956	24x199	SK-1586	BTK	
2.0 D Multijet	08/11-	198 A5.000	1956	24x199	SK-1586AQ1	BTKW	
1.4, 1.4 16V	08/11-	198 A4.000, 198 A7.000	1368		0-N195	TB [TE]	
1.6 D Multijet	08/11-	198 A2.000	1598		0-N2149	TB [DG]	
2.0 D Multijet	08/11-	198 A5.000	1956		0-N2149	TB [DG]	
1.6 D Multijet	08/11-	198 A2.000	1598	⊛	0-N1522	VB [DG]	
2.0 D Multijet	08/11-	198 A5.000	1956	⊛	0-N1522	VB [DG]	

GRAND VOYAGER V (RT)

2.8 CRD	10/07-		2768	25x171	SK-1734	BTK	
2.8 CRD	10/07-	ENS	2777	25x171	SK-1734	BTK	
2.8 CRD	10/07-	ENS	2777		0-N1612	TB [TE]	
2.8 CRD	10/07-	ENS	2768		0-N2329	TB [TE]	
2.8 CRD	10/07-	ENS	2777		0-N2329	TB [TE]	
2.8 CRD	10/07-	ENS	2777		0-N1423	VB [DG]	
2.8 CRD	10/07-		2768		0-N2048	VB [DG]	
2.8 CRD	10/07-	ENS	2768		0-N2203	VB [BT]	S
2.8 CRD	10/07-	ENS	2777		0-N2203	VB [BT]	S

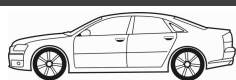

CM³



Art. Nr.



ohne Halter

DAYTONA Coupe							
2.5 i Turbo	01/89-10/92	EDT	2501			0-N1693	FB [DG]
LE BARON Stufenheck							
3.0 i V6	01/90-12/94	EFA	2972	25.4x149		SK-1308	BTK
3.0 i V6	01/90-12/94	EFA	2972			0-N064	TB [TE]
LE BARON Cabriolet							
3.0 i V6	01/90-12/96	6G72	2972	25.4x149		SK-1308	BTK
3.0 i V6	01/90-12/96	6G72	2972			0-N064	TB [TE]
LE BARON Coupe							
3.0 i V6	01/90-12/93	EFA	2972	25.4x149		SK-1308	BTK
NEON (PL)							
2.0 16V	06/94-08/99	ECC	1996			0-N1835	TB [BT]
NEON II							
2.0 16V, 2.0 16V R/T	10/01-12/06	ECB, ECH	1996			0-N1835	TB [BT]
1.6	11/01-12/06	EJD	1598			0-N1492	VB [BT] S
2.0 16V	08/99-12/06	420H, ECB	1996	12/1999 → 12/2000; ohne Grundträger		0-N1836	VB [BT]
2.0 16V	10/02-12/06	ECB	1996	ohne Grundträger		0-N1836	VB [BT]
2.0 16V R/T	10/01-12/06	ECH	1996	01/2002 →; ohne Grundträger		0-N1836	VB [BT]
PT CRUISER (PT_)							
2.0	06/00-12/10	ECC	1996	29x150; 01/2003 →		SK-1699	BTK
2.0	10/04-12/10	ECC	1996	29x150		SK-1699	BTK
2.4	06/00-12/10	EDZ	2429	28x146; → 09/2010		SK-1701	BTK
2.4, GT 2.4	06/00-12/10	EDV, EDZ	2429	28x146		SK-1700	BTK
2.0	06/00-12/10	ECC	1996			0-N1835	TB [BT]
2.4	06/00-12/10	EDZ	2429	01/2002 →		0-N1838S	TB [TE]
2.4	06/00-12/10	EDZ	2429	→ 12/2002		0-N2059	TB [TE]
2.4, GT 2.4	06/00-12/10	EDV, EDZ	2429			0-N1962	TB [DG]
2.4, GT 2.4	08/03-12/10	EDV, EDZ	2429			0-N1838S	TB [TE]
2.0	06/00-12/10	ECC	1996			0-N1509	VB [BT] S
2.0	06/00-12/10	ECC	1996	01/2003 →; ohne Grundträger		0-N1836	VB [BT]
2.0	10/04-12/10	ECC	1996	ohne Grundträger		0-N1836	VB [BT]
2.2 CRD	03/02-12/10	EDJ	2148			0-N1510	VB [BT] S
2.2 CRD	03/02-12/10	EDJ	2148			0-N1680	VB [DG]
2.4, GT 2.4	06/00-12/10	EDV, EDZ	2429			0-N1555	VB [BT] S
PT CRUISER Cabriolet							
2.4, 2.4 GT	03/04-03/08	EDV, EDZ	2429	28x146; 05/2004 →		SK-1700	BTK
2.4, 2.4 GT	03/04-03/08	EDV, EDZ	2429			0-N1838S	TB [TE]
2.4, 2.4 GT	03/04-03/08	EDV, EDZ	2429			0-N1962	TB [DG]
2.4, 2.4 GT	03/04-03/08	EDV, EDZ	2429			0-N1555	VB [BT] S
SARATOGA							
3.0	09/89-12/95	6G72	2972	25.4x149		SK-1308	BTK
3.0	09/89-12/95	6G72	2972			0-N064	TB [TE]
SEBRING Coupe (FJ)							
2.5 LE	05/95-12/96	EEB	2497			0-N185	TB [TE]
SEBRING (JR)							
2.0	04/01-06/07	ECC	1996	29x150; 01/2004 →		SK-1699	BTK
2.4	04/01-06/07	EDZ	2429	28x146		SK-1700	BTK
2.4	04/01-06/07	EDZ	2429	28x146		SK-1701	BTK
2.0	04/01-06/07	ECC	1996			0-N1835	TB [BT]
2.4	04/01-06/07	EDZ	2429			0-N1838S	TB [TE]
2.4	04/01-06/07	EDZ	2429	01/2003 →		0-N1838S	TB [TE]
2.4	04/01-06/07	EDZ	2429			0-N1962	TB [DG]
2.4	04/01-06/07	EDZ	2429			0-N2059	TB [TE]
2.0	04/01-06/07	ECC	1996			0-N1509	VB [BT] S
2.0	04/01-06/07	ECC	1996	01/2004 →; ohne Grundträger		0-N1836	VB [BT]
2.4	04/01-06/07	EDZ	2429			0-N1509	VB [BT] S
2.7 V6 24V	04/01-06/07	EER, EES	2736			0-N2233	VB [TE]
SEBRING Cabriolet (JR)							
2.0	04/01-06/07	ECC	1996	29x150; 01/2004 →		SK-1699	BTK
2.0	04/01-06/07	ECC	1996			0-N1835	TB [BT]
2.4	04/01-06/07	EDZ	2429			0-N1838S	TB [TE]
2.0	04/01-06/07	ECC	1996			0-N1509	VB [BT] S

CM³

Art. Nr.



ohne Halter

SEBRING Cabriolet (JR)

2.0	04/01-06/07	ECC	1996	01/2004 →; ohne Grundträger	0-N1836	VB [BT]	
2.4	04/01-06/07	EDZ	2429		0-N1509	VB [BT]	S
2.7 V6 24V	04/01-06/07	EES	2736		0-N2233	VB [TE]	

SEBRING (JS)

2.0 CRD	07/07-12/10	ECD	1968	30x141; → 09/2010; mit Zubehör	SK-1595	BTK	
2.0 CRD	07/07-12/10	ECD	1968	30x141; mit Zubehör	SK-1595AQ1	BTKW	
2.0 CRD	07/07-12/10	ECD	1968		0-N1046	TB [DG]	
2.0 CRD	07/07-12/10	ECD	1968		0-N1335	TB [TE]	
2.0 CRD	07/07-12/10	ECD	1968		0-N1336	TB [DG]	
2.0 CRD	07/07-12/10	ECD	1968		0-N2364	VB [DG]	
2.0 CRD	07/07-12/10	ECD	1968		0-N2397	VB [BT]	S
2.0 VVT	07/07-12/10	ECN	1998		0-N2048	VB [DG]	
2.0 VVT	07/07-12/10	ECN	1998		0-N2112	VB [BT]	S
2.4 VVT	07/07-12/10	ED3, EDG	2360		0-N2048	VB [DG]	
2.4 VVT	07/07-12/10	ED3, EDG	2360		0-N2112	VB [BT]	S
2.7 VVT	09/06-12/10	EER	2736		0-N2232	VB [BT]	S

SEBRING Cabriolet (JS)

2.0 CRD	07/07-12/10	ECD	1968	30x141; → 09/2010; mit Zubehör	SK-1595	BTK	
2.0 CRD	07/07-12/10	ECD	1968	30x141; mit Zubehör	SK-1595AQ1	BTKW	
2.0 CRD	07/07-12/10	ECD	1968		0-N1046	TB [DG]	
2.0 CRD	07/07-12/10	ECD	1968		0-N1335	TB [TE]	
2.0 CRD	07/07-12/10	ECD	1968		0-N1336	TB [DG]	
2.0 CRD	07/07-12/10	ECD	1968		0-N2364	VB [DG]	
2.0 CRD	07/07-12/10	ECD	1968		0-N2397	VB [BT]	S
2.4 VVT	07/07-12/10	ED3	2360		0-N2048	VB [DG]	
2.4 VVT	07/07-12/10	ED3	2360		0-N2112	VB [BT]	S
2.7, 2.7 VVT	07/07-12/10	EER	2736		0-N2232	VB [BT]	S

STRATUS (JA)

2.5 LX V6, 2.5 V6	12/95-04/01	EEB, H00, H00	2497		0-N185	TB [TE]	
2.5 LX V6, 2.5 V6	12/95-04/01	EEB, H00, H00	2497		0-N189	TB [DG]	
2.0 16V, 2.0 LE	12/95-04/01	C00, ECB	1996		0-N1555	VB [BT]	S
2.0 16V, 2.0 LE	12/95-04/01	C00, ECB	1996	12/1999 →; ohne Grundträger	0-N1836	VB [BT]	
2.4 16 V, 2.4 16V	12/95-04/01	EDZ	2429		0-N1555	VB [BT]	S

STRATUS Cabriolet (JX)

2.5 LX	04/96-04/01	625H	2499		0-N185	TB [TE]	
2.5 LX	04/96-04/01	625H	2499		0-N189	TB [DG]	
2.0 LE	06/96-04/01	420X	1996		0-N1555	VB [BT]	S

TOWN & COUNTRY

3.3	10/00-08/07	EGM	3301		0-N1698	VB [BT]	S
3.3	10/00-08/07	EGM	3301		0-N2406	VB [BT]	S
3.8 AWD	10/00-08/07	EGH	3778		0-N1698	VB [BT]	S
3.8 AWD	10/00-08/07	EGH	3778		0-N2406	VB [BT]	S

VOYAGER I (AS)

3.0	10/87-09/90	EFA	2972	25.4x149	SK-1308	BTK	
3.0	10/87-09/90	EFA	2972		0-N064	TB [TE]	
3.3	10/89-09/90	EGA	3301		0-N1695	VB [DG]	
3.3	10/89-09/90	EGA	3301		0-N1698	VB [BT]	S
3.0	10/87-09/90	EFA	2972		0-N1693	FB [DG]	

VOYAGER II (ES)

3.0, 3.0 i	10/90-09/95	300, 6G72, EFA	2972	25.4x149	SK-1308	BTK	
3.0, 3.0 i	10/90-09/95	300, 6G72, EFA	2972		0-N064	TB [TE]	
2.5 TD	01/92-09/95	09B, M00	2500		0-N2157	VB [VD]	
3.3 i, 3.3 i AWD	08/90-09/95	EGA, R00	3301		0-N1695	VB [DG]	
3.3 i, 3.3 i AWD	08/90-09/95	EGA, R00	3301		0-N1698	VB [BT]	S

VOYAGER III (GS)

2.4 AWD	02/97-03/01	EDZ	2429	28x146; → 09/2000	SK-1700	BTK	
2.4 AWD	02/97-03/01	EDZ	2429	28x146; → 09/2000	SK-1701	BTK	
2.4 i	01/95-03/01	B00	2429	28x146; 10/1995 → 09/2000	SK-1700	BTK	
2.4 i	01/95-03/01	B00	2429	28x146	SK-1701	BTK	
3.0	01/95-03/01	EFA	2972	25.4x149	SK-1308	BTK	
2.4 AWD, 2.4 i	01/95-03/01	B00, EDZ	2429		0-N1962	TB [DG]	
2.4 i	01/95-03/01	B00	2429	01/1997 → 12/1998	0-N2059	TB [TE]	



CM³



Art. Nr.



ohne Halter

VOYAGER III (GS)							
3.0	01/95-03/01	EFA	2972			0-N064	TB [TE]
2.0 i	01/95-03/01	C00	1995	12/1999 → 12/2000; ohne Grundträger		0-N1836	VB [BT]
2.5 TD	01/95-03/01	425 CLIRS/X, ENC	2499			0-N1644	VB [DG]
2.5 TD	01/95-03/01	ENC	2499			0-N2256	VB [DG]
2.5 TD, 2.5 TDiC AWD	01/95-03/01	425 CLIRS/X, ENC, ENC	2499			0-N1546	VB [DG]
3.0	01/95-03/01	EFA	2972	10/1995 → 09/2000		0-N1699	VB [BT] S
3.3 i	01/95-03/01	R00	3301	10/1995 →;		0-N1695	VB [DG]
3.3 i	01/95-03/01	R00	3301			0-N1698	VB [BT] S
3.8 i AWD	01/95-03/01	L00	3778	10/1995 →;		0-N1695	VB [DG]
3.8 i AWD	01/95-03/01	EGH	3778	10/1997 →;		0-N1695	VB [DG]
3.8 i AWD	01/95-03/01	EGH, L00	3778			0-N1698	VB [BT] S
3.0	01/95-03/01	EFA	2972	10/1995 → 09/2000		0-N1693	FB [DG]
VOYAGER IV (RG, RS)							
2.4	02/00-12/08	EDZ	2429	28x146		SK-1700	BTK
2.4	02/00-12/08	EDZ	2429	28x146; → 02/2008		SK-1701	BTK
2.5 CRD	02/00-12/08	ENJ	2499	28x220; 10/2000 →		SK-1673	BTK
2.5 CRD	08/05-12/08	EDK	2499	28x220		SK-1673	BTK
2.8 CRD	06/04-12/08	ENR	2776	28x220		SK-1673	BTK
2.4	02/00-12/08	EDZ	2429	01/2003 →		0-N1838S	TB [TE]
2.4	02/00-12/08	EDZ	2429			0-N1962	TB [DG]
2.4	02/00-12/08	EDZ	2429	→ 12/2002		0-N2059	TB [TE]
2.5 CRD	02/00-12/08	EDK, ENJ	2499			0-N1411	TB [DG]
2.5 CRD	02/00-12/08	EDK, ENJ	2499			0-N1612	TB [TE]
2.8 CRD	06/04-12/08	ENR	2776			0-N1411	TB [DG]
2.8 CRD	06/04-12/08	ENR	2776			0-N1612	TB [TE]
2.5 CRD	02/00-12/08	EDK, ENJ	2499			0-N1423	VB [DG]
2.5 CRD	02/00-12/08	ENJ	2499	→ 01/2004		0-N2151	VB [BT] S
2.5 CRD	02/00-12/08	ENJ	2499	01/2004 →		0-N2203	VB [BT] S
2.5 CRD	08/05-12/08	EDK	2499			0-N2203	VB [BT] S
2.8 CRD	06/04-12/08	ENR	2776			0-N1423	VB [DG]
2.8 CRD	06/04-12/08	ENR	2776			0-N2203	VB [BT] S
3.3, 3.3 AWD	02/00-12/08	EGA, EGA, EGM	3301			0-N1698	VB [BT] S
3.3, 3.3 AWD, 3.3 Flex-Fuel	02/00-12/08	EGA, EGA, EGM, EGM	3301			0-N2406	VB [BT] S
3.8, 3.8 AWD	02/00-12/08	EGH	3778			0-N2406	VB [BT] S
YPSILON							
1.2	05/11-	169 A4.000	1242	22x129; 09/2011 →		SK-1677	BTK
1.2	05/11-	169 A4.000	1242			0-N1616	TB [TE]
SEBRING Cabriolet							
2.5	01/96-12/98		2497			0-N185	TB [TE]
VOYAGER [USA] Mini Passenger Van							
3.3, 3.3 Flexfuel	01/00-12/01		3294			0-N2406	VB [BT] S
PT CRUISER [USA] Cabriolet							
2.4	01/05-12/08		2429			0-N1838S	TB [TE]

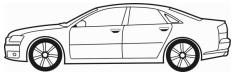

CM³



Art. Nr.



ohne Halter

SEBRING

2.0	03/08-12/08	ECN	1998		0-N2048	VB [DG]
2.4	03/08-12/08	ED3	2360		0-N2048	VB [DG]

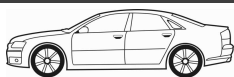

CM³



Art. Nr.



ohne Halter

AMI							
10 Super	03/73-12/77	G10	1015			0-N822	TB [TE]
AMI Break							
10 Super	03/73-12/77	G10	1015			0-N822	TB [TE]
AX (ZA-)							
1.3 Sport	04/87-12/88	M4A	1294	17x104		SK-1003	BTK
1.3 Sport	04/87-12/88	M4A	1294	17x104		SK-1003AQ1	BTKW
1.4 4x4, 1.4 Allure, 14	09/86-04/97	K1F, K1G, K2A, K2A, K2B, KAY (TU3CP), KDX (TU3M/Z), KDY (TU3FM), KDY (TU3M), KDZ (TU3M/Z)	1360	17x108		SK-1004	BTK
1.4 4x4, 1.4 GTi, 14 4x4, 14 GT	01/89-12/96	K1F, KDX (TU3M/Z), KDY (TU3FM), KDY (TU3M), KDZ (TU3M/Z), KDZ (TU3M/Z), KFZ (TU3FJ2)	1360	17x101		SK-1020	BTK
1.4 4x4, 1.4 GTi, 14 4x4, 14 GT	01/89-12/96	K1F, KDX (TU3M/Z), KDY (TU3FM), KDY (TU3M), KDZ (TU3M/Z), KDZ (TU3M/Z), KFY (TU3FJ2), KFZ (TU3FJ2)	1360	17x101		SK-1020AQ1	BTKW
1.4 Allure, 14	12/86-04/94	K1F, K1G, K2A, K2A, K2B, KAY (TU3CP)	1360	17x108		SK-1004AQ1	BTKW
1.4 GTi	08/91-12/96	KFY (TU3FJ2)	1360	17x101; 08/1992 →		SK-1020	BTK
10, 10 E	07/86-12/98	C1A, C3A, CDY (TU9M), CDZ (TU9M)	954	17x104		SK-1003	BTK
10, 10 E	07/86-12/98	C1A, C3A, CDY (TU9M), CDZ (TU9M)	954	17x104		SK-1003AQ1	BTKW
11 4x4	06/91-07/92	H1A	1124	17x104		SK-1003	BTK
11, 11 4x4, 11 KAT	09/86-12/97	H1A, H1A, H1B, H1B, HDZ (TU1M), HAZ (TU1CP)	1124	17x104		SK-1003AQ1	BTKW
11, 11 KAT	09/86-12/97	H1A, H1B, H1B, HDZ (TU1M), HAZ (TU1CP)	1124	17x104		SK-1003	BTK
14	04/87-04/97	TU3FM	1360	17x101		SK-1020	BTK
14 4x4	08/91-12/96	KDX (TU3M/Z), KDY (TU3FM), KDY (TU3M), KDZ (TU3M/Z)	1360	17x108; → 05/1995		SK-1004	BTK
14 D	09/88-12/97	K9A (TUD3), K9Y (TUD3Y)	1360	25x143		SK-1005	BTK
14, 14 4x4	04/87-04/97	TU3M	1360	17x108; → 01/1993		SK-1004AQ1	BTKW
15 D	08/94-12/97	VJY (TUD5), VJY (TUD5), VJZ (TUD5)	1527	25.4x136		SK-1040	BTK
15 D	08/94-12/97	VJY (TUD5), VJY (TUD5), VJZ (TUD5)	1527	25.4x136		SK-1040AQ1	BTKW
1.3 Sport	04/87-12/88	M4A	1294			0-N811	TB [TE]
1.4 4x4, 1.4 Allure, 1.4 GTi, 14, 14 4x4, 14 GT	09/86-04/97	K1F, K1G, K2A, K2A, K2B, KAY (TU3CP), KDX (TU3M/Z), KDY (TU3FM), KDY (TU3M), KDZ (TU3M/Z), KDZ (TU3M/Z), KFY (TU3FJ2), KFZ (TU3FJ2)	1360			0-N811	TB [TE]
1.4 D 4x4, 14 D	09/88-12/97	K9A (TUD3), K9Y (TUD3Y)	1360			0-N861	TB [TE]
1.4 D 4x4, 14 D	09/88-12/97	K9A (TUD3), K9Y (TUD3Y)	1360			0-N862	TB [DG]
10, 10 E	07/86-12/98	C1A, C3A, CDY (TU9M), CDZ (TU9M)	954			0-N811	TB [TE]
11, 11 4x4, 11 KAT	09/86-12/97	H1A, H1A, H1B, H1B, HDZ (TU1M), HAZ (TU1CP)	1124			0-N811	TB [TE]
15 D	08/94-12/97	VJY (TUD5), VJY (TUD5), VJZ (TUD5)	1527			0-N861	TB [TE]
15 D	08/94-12/97	VJY (TUD5), VJY (TUD5), VJZ (TUD5)	1527			0-N862	TB [DG]
1.3 Sport	04/87-12/88	M4A	1294			0-N125	VB [TE] S
1.4 D 4x4, 14 D	09/88-12/97	K9A (TUD3), K9Y (TUD3Y)	1360			0-N133	VB [TE]
1.4 GTi, 14, 14 4x4	12/86-04/97	K1F, K2A, K2B, KAY (TU3CP), KDX (TU3M/Z), KDY (TU3FM), KDY (TU3M), KDZ (TU3M/Z), KFY (TU3FJ2), KFZ (TU3FJ2)	1360			0-N125	VB [TE] S
10, 10 E	07/86-12/98	C1A, C3A, CDY (TU9M), CDZ (TU9M)	954			0-N125	VB [TE] S
11, 11 4x4, 11 KAT	09/86-12/97	H1A, H1A, H1B, H1B, HDZ (TU1M), HAZ (TU1CP)	1124			0-N125	VB [TE] S
15 D	08/94-12/97	VJY (TUD5), VJY (TUD5), VJZ (TUD5)	1527			0-N133	VB [TE]
15 D	08/94-12/97	VJY (TUD5)	1527			0-N2015	VB [BT]
15 D	08/94-12/97	VJY (TUD5), VJY (TUD5), VJZ (TUD5)	1527	✳		0-N2174	VB [TE]
AXEL							
11	01/84-03/91	G11/631	1129			0-N822	TB [TE]
11	01/84-03/91		1299			0-N822	TB [TE]
BERLINGO (MF)							
1.1 i	07/96-	HDZ (TU1M), HFX (TU1JP)	1124	17x104; →3762433		SK-1003	BTK
1.1 i	07/96-	TU1M	1124	17x104; Orga.→08700		SK-1003AQ1	BTKW
1.1 i	07/96-	TU1JP	1124	17x104; →3762433		SK-1003AQ1	BTKW
1.1 i	07/96-	HDZ (TU1M), HFX (TU1JP)	1124	17x100; :3762434 →		SK-1353	BTK
1.1 i	07/96-	HDZ (TU1M), HFX (TU1JP)	1124	17x100; :3762434 →		SK-1353AQ1	BTKW
1.4 i	07/96-	KFW (TU3JP), KFX (TU3JP)	1360	17x108; →3666765		SK-1004	BTK
1.4 i	07/96-	KFW (TU3JP), KFX (TU3JP)	1360	17x108; →3666765		SK-1004AQ1	BTKW
1.4 i	07/96-	KFW (TU3JP), KFX (TU3JP)	1360	17x104; :3666766 →		SK-1354	BTK
1.4 i	07/96-	KFW (TU3JP), KFX (TU3JP)	1360	17x104; :3666767 →		SK-1354AQ1	BTKW



CM³



Art. Nr.



BERLINGO (MF)

1.4, 1.4 bivalent, 1.4 Hybrid, 1.4 i bivalent	11/02-10/05	KFW (TU3JP)	1360	17x104	SK-1354	BTK
1.4, 1.4 bivalent, 1.4 Hybrid, 1.4 i bivalent	11/02-10/05	KFW (TU3JP)	1360	17x104	SK-1354AQ1	BTKW
1.6 16V	10/00-	NFU (TU5JP4)	1587	25.4x134; → 05/2008; → 1806404; mit Zubehör	SK-1392	BTK
1.6 16V	10/00-	NFU (TU5JP4)	1587	25.4x134; → 08/2007; mit Zubehör	SK-1392	BTK
1.6 16V	10/00-	NFU (TU5JP4)	1587	25.4x134; → 08/2007; mit Zubehör	SK-1392AQ1	BTKW
1.6 16V	10/00-	NFU (TU5JP4)	1587	25.4x134; → 1806404; mit Zubehör	SK-1392AQ1	BTKW
1.6 16V	10/00-	NFU (TU5JP4)	1587	25.4x134; → 05/2008; :1806405→	SK-1615	BTK
1.6 16V	10/00-	NFU (TU5JP4)	1587	25.4x134; Orga.1125478→	SK-1615AQ1	BTKW
1.6 16V	11/02-	NFU (TU5JP4)	1587	25.4x134; :1806405→	SK-1615AQ1	BTKW
1.6 HDI 110, 1.6 HDI 75, 1.6 HDI 90	07/05-	9HW (DV6BTED4), DV6B, 9HX (DV6ATED4), 9HZ (DV6TED4)	1560	25x137	SK-1424	BTK
1.6 HDI 110, 1.6 HDI 75, 1.6 HDI 90	07/05-	9HW (DV6BTED4), DV6B, 9HX (DV6ATED4), 9HZ (DV6TED4)	1560	25x137	SK-1424AQ1	BTKW
1.8 D	07/98-	A9A (XUD7)	1769	25.4x136; Baumuster: A9A	SK-1022	BTK
1.8 D	07/98-	A9A (XUD7)	1769	25.4x136	SK-1022AQ2	BTKW
1.8 i, 1.8 i 4WD	04/97-	LFX (XU7JB)	1761	17x114	SK-1019	BTK
1.9 D	07/96-	D9B (XUD9A/L), DJY (XUD9A)	1905	25.4x136	SK-1022	BTK
1.9 D	07/96-	D9B (XUD9A/L), DJY (XUD9A)	1905	25.4x136	SK-1022AQ2	BTKW
1.9 D	07/96-10/99	DW8	1905	25.4x140	SK-1086AQ1	BTKW
1.9 D	07/98-10/05	WJY (DW8B), WJZ (DW8)	1868	25.4x140; Baumuster: WJY, WJZ	SK-1086	BTK
1.9 D	07/98-10/05	WJY (DW8B), WJZ (DW8)	1868	25.4x140	SK-1086AQ1	BTKW
1.9 D 4WD	07/98-	WJY (DW8B), WJZ (DW8)	1868	25.4x140	SK-1086	BTK
1.9 D 4WD	07/98-	DW8	1868	25.4x140	SK-1086AQ1	BTKW
2.0 HDi 4x4	11/02-10/05	RHY (DW10TD)	1997	25x141; mit Zubehör	SK-1085	BTK
2.0 HDi 90	12/99-	RHY (DW10TD)	1997	25x141; → 10/2000; Orga.→8735; mit Zubehör	SK-1085	BTK
2.0 HDi 90	12/99-	RHY (DW10TD)	1997	25.4x141; mit Zubehör	SK-1085AQ1	BTKW
1.1 i	07/96-	TU1JP	1124	:3762434→	0-N1277	TB [TE]
1.1 i	07/96-	TU1M	1124		0-N811	TB [TE]
1.1 i	07/96-	TU1JP	1124	:→3762433	0-N811	TB [TE]
1.4 i	07/96-	KFW (TU3JP), KFX (TU3JP)	1360	:3666766→	0-N1277	TB [TE]
1.4 i	07/96-	KFW (TU3JP), KFX (TU3JP)	1360	:→3666765	0-N811	TB [TE]
1.4, 1.4 bivalent, 1.4 GNC, 1.4 Hybrid, 1.4 i bivalent	11/02-10/05	KFW (TU3JP)	1360		0-N1277	TB [TE]
1.6 16V	10/00-	NFU (TU5JP4)	1587	:→1806404	0-N1061	TB [TE]
1.6 16V	10/00-	NFU (TU5JP4)	1587	:→1806404	0-N122	TB [DG]
1.6 16V	10/00-	NFU (TU5JP4)	1587	:1806405→	0-N1359	TB [TE]
1.6 16V	10/00-	NFU (TU5JP4)	1587	:1806405→	0-N1360	TB [DG]
1.6 HDI 110, 1.6 HDI 75, 1.6 HDI 90	07/05-	9HW (DV6BTED4), DV6B, 9HX (DV6ATED4), 9HZ (DV6TED4)	1560		0-N1062	TB [TE]
1.6 HDI 110, 1.6 HDI 75, 1.6 HDI 90	07/05-	9HW (DV6BTED4), DV6B, 9HX (DV6ATED4), 9HZ (DV6TED4)	1560		0-N1066	TB [DG]
1.6 HDI 75	07/05-	9HW (DV6BTED4), DV6B	1560		0-N2224	TB [TE]
1.6 HDI 75	07/05-	9HW (DV6BTED4), DV6B	1560		0-N2382	TB [DG]
1.8 D	07/98-	A9A (XUD7)	1769		0-N900	TB [DG]
1.8 D	07/98-	A9A (XUD7)	1769		0-N901	TB [TE]
1.8 i, 1.8 i 4WD	04/97-	LFX (XU7JB)	1761		0-N811	TB [TE]
1.9 D	07/96-10/99	D9B (XUD9A/L), DJY (XUD9A), DJY (XUD9A)	1905		0-N900	TB [DG]
1.9 D	07/96-10/99	D9B (XUD9A/L), DJY (XUD9A), DJY (XUD9A)	1905		0-N901	TB [TE]
1.9 D, 1.9 D 4WD	07/98-10/05	WJY (DW8B), WJZ (DW8)	1868		0-N118P	TB [TE]
1.9 D, 1.9 D 4WD	07/98-10/05	WJY (DW8B), WJZ (DW8)	1868		0-N1381	TB [DG]
2.0 HDi 4x4, 2.0 HDi 90	12/99-10/05	RHY (DW10TD)	1997	Orga.→08735	0-N118P	TB [TE]
2.0 HDi 4x4, 2.0 HDi 90	12/99-10/05	RHY (DW10TD)	1997	Orga.→08735	0-N119P	TB [DG]
2.0 HDi 4x4, 2.0 HDi 90	12/99-10/05	RHY (DW10TD)	1997	Orga.08736→	0-N1381	TB [DG]
1.1 i	07/96-	HDZ (TU1M), HFX (TU1JP)	1124	→ 12/2001	0-N125	VB [TE] S
1.1 i	07/96-	HDZ (TU1M), HFX (TU1JP)	1124	01/2002 →;	0-N1419	VB [DG]
1.1 i	07/96-	HDZ (TU1M), HFX (TU1JP)	1124	01/2002 →;	0-N1620	VB [BT] S
1.1 i	07/96-	HDZ (TU1M), HFX (TU1JP)	1124	01/2002 →	0-N1949	VB [TE]
1.4 bivalent, 1.4 i bivalent	11/02-	KFW (TU3JP)	1360		0-N1949	VB [TE]
1.4 i	07/96-	KFW (TU3JP), KFX (TU3JP)	1360	→ 12/2001	0-N125	VB [TE] S
1.4 i	07/96-	KFW (TU3JP), KFX (TU3JP)	1360	01/2002 →;	0-N1419	VB [DG]
1.4 i	07/96-	KFW (TU3JP), KFX (TU3JP)	1360	01/2002 →	0-N1620	VB [BT] S
1.4 i	07/96-	KFW (TU3JP), KFX (TU3JP)	1360	01/2002 →	0-N1949	VB [TE]
1.4, 1.4 bivalent, 1.4 GNC, 1.4 Hybrid, 1.4 i bivalent	11/02-10/05	KFW (TU3JP)	1360		0-N1419	VB [DG]



CM³



Art. Nr.



BERLINGO (MF)

1.4, 1.4 bivalent, 1.4 Hybrid, 1.4 i bivalent	11/02-10/05	KFW (TU3JP)	1360	☼		0-N1620	VB [BT]	S
1.6 16V	10/00-	NFU (TU5JP4)	1587	Orga.→12110; ☼		0-N1419	VB [DG]	
1.6 16V	10/00-	NFU (TU5JP4)	1587	☼		0-N1620	VB [BT]	S
1.6 16V	10/00-	NFU (TU5JP4)	1587	Orga.12110→; ☼		0-N1874	VB [BT]	S
1.6 16V	10/00-	NFU (TU5JP4)	1587			0-N1949	VB [TE]	
1.6 16V	10/00-	NFU (TU5JP4)	1587	Orga.12110→; ☼		0-N2191	VB [DG]	
1.6 HDI 110	08/05-	9HZ (DV6TED4)	1560			0-N1502	VB [BT]	S
1.6 HDI 110, 1.6 HDI 75, 1.6 HDI 90	07/05-	9HW (DV6BTE4), DV6B, 9HX (DV6ATED4), 9HZ (DV6TED4)	1560	Orga.→10570		0-N1418	VB [DG]	
1.6 HDI 110, 1.6 HDI 75, 1.6 HDI 90	07/05-	9HW (DV6BTE4), DV6B, 9HX (DV6ATED4), 9HZ (DV6TED4)	1560	Orga.→10570; ☼		0-N1420	VB [DG]	
1.6 HDI 110, 1.6 HDI 75, 1.6 HDI 90	07/05-	9HW (DV6BTE4), DV6B, 9HX (DV6ATED4), 9HZ (DV6TED4)	1560	Orga.→10570		0-N1636	VB [BT]	S
1.6 HDI 110, 1.6 HDI 75, 1.6 HDI 90	07/05-	9HW (DV6BTE4), DV6B, 9HX (DV6ATED4), 9HZ (DV6TED4)	1560	Orga.10571→		0-N1807	VB [DG]	
1.6 HDI 110, 1.6 HDI 75, 1.6 HDI 90	07/05-	9HW (DV6BTE4), DV6B, 9HX (DV6ATED4), 9HZ (DV6TED4)	1560	Orga.10571→		0-N1808	VB [BT]	S
1.8 D	07/98-	A9A (XUD7)	1769			0-N1320	VB [TE]	
1.8 D	07/98-	A9A (XUD7)	1769			0-N1472	VB [BT]	S
1.8 D	07/98-	A9A (XUD7)	1769			0-N1747	VB [VD]	
1.8 D	07/98-	A9A (XUD7)	1769			0-N931	VB [TE]	
1.8 i, 1.8 i 4WD	04/97-	LFX (XU7JB)	1761	Orga.07510FV, 08028FL→		0-N124	VB [TE]	
1.8 i, 1.8 i 4WD	04/97-	LFX (XU7JB)	1761	Generator-Ladestrom [A]: 90; ☼		0-N1402	VB [DG]	S
1.8 i, 1.8 i 4WD	04/97-	LFX (XU7JB)	1761	Generator-Ladestrom [A]: 120; ☼		0-N1465S	VB [DG]	
1.8 i, 1.8 i 4WD	04/97-	LFX (XU7JB)	1761	☼		0-N1484	VB [BT]	S
1.8 i, 1.8 i 4WD	04/97-	LFX (XU7JB)	1761	Orga.0812077→; ☼		0-N1722	VB [DG]	
1.9 D	07/96-10/99	D9B (XUD9A/L), DJY (XUD9A), DJY (XUD9A)	1905			0-N1320	VB [TE]	
1.9 D	07/96-10/99	D9B (XUD9A/L), DJY (XUD9A), DJY (XUD9A)	1905			0-N1472	VB [BT]	S
1.9 D	07/96-10/99	D9B (XUD9A/L), DJY (XUD9A), DJY (XUD9A)	1905			0-N1747	VB [VD]	
1.9 D	07/96-	D9B (XUD9A/L), DJY (XUD9A)	1905			0-N931	VB [TE]	
1.9 D	07/98-10/05	DW8B	1868	für Fahrzeuge mit Servolenkung		0-N1309	VB [DG]	
1.9 D	07/98-10/05	DW8	1868	Orga.08400→; für Fahrzeuge mit Servolenkung		0-N1309	VB [DG]	
1.9 D	07/98-10/05	DW8	1868	Orga.→08399		0-N1455	VB [TE]	
1.9 D	07/98-10/05	DW8, DW8B	1868	Orga.08400→; für Fahrzeuge mit Servolenkung, ☼		0-N1471	VB [BT]	S
1.9 D, 1.9 D 4WD	07/98-10/05	WJY (DW8B), WJZ (DW8)	1868			0-N1320	VB [TE]	
1.9 D, 1.9 D 4WD	07/98-10/05	WJY (DW8B), WJZ (DW8)	1868	Orga.→09610; ☼, für Fahrzeuge mit Servolenkung		0-N1472	VB [BT]	S
1.9 D, 1.9 D 4WD	07/98-10/05	WJY (DW8B), WJZ (DW8)	1868			0-N1545	VB [DG]	
1.9 D, 1.9 D 4WD	07/98-10/05	WJY (DW8B), WJZ (DW8)	1868	☼, ☼, für Fahrzeuge ohne Servolenkung		0-N1681	VB [BT]	
1.9 D, 1.9 D 4WD	07/98-10/05	WJY (DW8B), WJZ (DW8)	1868	Orga.→09610; ☼, für Fahrzeuge mit Servolenkung		0-N1747	VB [VD]	
1.9 D, 1.9 D 4WD	07/98-10/05	WJY (DW8B), WJZ (DW8)	1868	Orga.09611→; ☼, für Fahrzeuge mit Servolenkung		0-N1945	VB [BT]	S
1.9 D 4WD	07/98-	WJY (DW8B), WJZ (DW8)	1868	Orga.08375→; für Fahrzeuge mit Servolenkung		0-N1309	VB [DG]	
1.9 D 4WD	07/98-	WJY (DW8B), WJZ (DW8)	1868	Orga.→08374		0-N1455	VB [TE]	
1.9 D 4WD	07/98-	WJY (DW8B), WJZ (DW8)	1868	Orga.08375→; für Fahrzeuge mit Servolenkung, ☼		0-N1471	VB [BT]	S
2.0 HDi 4x4	11/02-10/05	RHY (DW10TD)	1997	☼		0-N1320	VB [TE]	
2.0 HDi 4x4, 2.0 HDi 90	12/99-10/05	RHY (DW10TD)	1997			0-N1493	VB [BT]	S
2.0 HDi 4x4, 2.0 HDi 90	12/99-10/05	RHY (DW10TD)	1997	☼		0-N151	VB [DG]	
2.0 HDi 4x4, 2.0 HDi 90	12/99-10/05	RHY (DW10TD)	1997	☼		0-N1748	VB [BT]	
2.0 HDi 90	12/99-	RHY (DW10TD)	1997			0-N1320	VB [TE]	

BERLINGO Kasten (M_)

1.1 i	07/96-	HDZ (TU1M), HFX (TU1JP)	1124	17x104; ☼ →3762433		SK-1003	BTK	
1.1 i	07/96-	TU1M	1124	17x104; Orga.→08700		SK-1003AQ1	BTKW	
1.1 i	07/96-	TU1JP	1124	17x104; ☼ →3762433		SK-1003AQ1	BTKW	
1.1 i	07/96-	HDZ (TU1M), HFX (TU1JP)	1124	17x100; ☼:3762434→		SK-1353	BTK	
1.1 i	07/96-	HDZ (TU1M), HFX (TU1JP)	1124	17x100; ☼:3762434→		SK-1353AQ1	BTKW	
1.4 bivalent, 1.4 i bivalent	11/02-	KFW (TU3JP)	1360	17x104		SK-1354	BTK	
1.4 bivalent, 1.4 i bivalent	11/02-	KFW (TU3JP)	1360	17x104		SK-1354AQ1	BTKW	
1.4 i	07/96-	KFW (TU3JP), KFX (TU3JP)	1360	17x108; ☼ →3666765		SK-1004	BTK	
1.4 i	07/96-	KFW (TU3JP), KFX (TU3JP)	1360	17x108; ☼ →3666765		SK-1004AQ1	BTKW	
1.4 i	07/96-	KFW (TU3JP), KFX (TU3JP)	1360	17x104; ☼:3666766→		SK-1354	BTK	

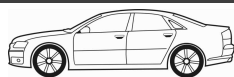

CM³



Art. Nr.



BERLINGO Kasten (M_)

1.4 i	07/96-	KFW (TU3JP), KFX (TU3JP)	1360	17x104; :3666767→	SK-1354AQ1	BTkW	
1.6 16V	10/00-	NFU (TU5JP4)	1587	25.4x134; → 03/2008; :→1806404; mit Zubehör	SK-1392	BTK	
1.6 16V	10/00-	NFU (TU5JP4)	1587	25.4x134; → 08/2007; mit Zubehör	SK-1392	BTK	
1.6 16V	10/00-	NFU (TU5JP4)	1587	25.4x134; :→1806404; mit Zubehör	SK-1392AQ1	BTkW	
1.6 16V	10/00-	NFU (TU5JP4)	1587	25.4x134; → 03/2008; :1806405→	SK-1615	BTK	
1.6 16V	10/00-	NFU (TU5JP4)	1587	25.4x134; Orga.1125478→	SK-1615AQ1	BTkW	
1.6 HDI 75 , 1.6 HDI 90	07/05-	9HW (DV6BTED4), DV6B, 9HX (DV6ATED4)	1560	25x137	SK-1424	BTK	
1.6 HDI 75 , 1.6 HDI 90	07/05-	9HW (DV6BTED4), DV6B, 9HX (DV6ATED4)	1560	25x137	SK-1424AQ1	BTkW	
1.8 D	07/96-	A9A (XUD7)	1769	25.4x136; Baumuster: A9A	SK-1022	BTK	
1.8 D	07/96-	A9A (XUD7)	1769	25.4x136	SK-1022AQ2	BTkW	
1.8 i	08/99-10/02	LFX (XU7JB)	1761	17x114	SK-1019	BTK	
1.9 D	07/96-	DJY (XUD9A)	1905	25.4x136	SK-1022	BTK	
1.9 D	07/96-	DJY (XUD9A)	1905	25.4x136	SK-1022AQ2	BTkW	
1.9 D 70 , 1.9 D 70 4WD	07/98-	WJY (DW8B), WJZ (DW8)	1868	25.4x140; Baumuster: WJY, WJZ	SK-1086	BTK	
1.9 D 70 , 1.9 D 70 4WD	07/98-	DW8	1868	25.4x140	SK-1086AQ1	BTkW	
2.0 HDI 90	12/99-	RHY (DW10TD)	1997	25x141; → 10/2000; Orga.→8735; mit Zubehör	SK-1085	BTK	
2.0 HDI 90 , 2.0 HDI 90 4WD	12/99-	RHY (DW10TD)	1997	25.4x141; mit Zubehör	SK-1085AQ1	BTkW	
2.0 HDI 90 4WD	11/00-	RHY (DW10TD)	1997	25x141; mit Zubehör	SK-1085	BTK	
1.1 i	07/96-	HDZ (TU1M), HFX (TU1JP)	1124		0-N811	TB [TE]	
1.4 i	07/96-	KFW (TU3JP), KFX (TU3JP)	1360	:3666766→	0-N1277	TB [TE]	
1.4 i	07/96-	KFW (TU3JP), KFX (TU3JP)	1360	:→3666765	0-N811	TB [TE]	
1.4, 1.4 bivalent, 1.4 i bivalent	11/02-	KFW (TU3JP)	1360		0-N1277	TB [TE]	
1.6 16V	10/00-	NFU (TU5JP4)	1587	:→1806404	0-N1061	TB [TE]	
1.6 16V	10/00-	NFU (TU5JP4)	1587	:→1806404	0-N122	TB [DG]	
1.6 16V	10/00-	NFU (TU5JP4)	1587	:1806405→	0-N1359	TB [TE]	
1.6 16V	10/00-	NFU (TU5JP4)	1587	:1806405→	0-N1360	TB [DG]	
1.6 HDI 75	07/05-	9HW (DV6BTED4), DV6B	1560		0-N2224	TB [TE]	
1.6 HDI 75	07/05-	9HW (DV6BTED4), DV6B	1560		0-N2382	TB [DG]	
1.6 HDI 75 , 1.6 HDI 90	07/05-	9HW (DV6BTED4), DV6B, 9HX (DV6ATED4)	1560		0-N1062	TB [TE]	
1.6 HDI 75 , 1.6 HDI 90	07/05-	9HW (DV6BTED4), DV6B, 9HX (DV6ATED4)	1560		0-N1066	TB [DG]	
1.8 D	07/96-	A9A (XUD7)	1769		0-N900	TB [DG]	
1.8 D	07/96-	A9A (XUD7)	1769		0-N901	TB [TE]	
1.8 i	08/99-10/02	LFX (XU7JB)	1761		0-N811	TB [TE]	
1.9 D	07/96-	DJY (XUD9A)	1905		0-N900	TB [DG]	
1.9 D	07/96-	DJY (XUD9A)	1905		0-N901	TB [TE]	
1.9 D 70 , 1.9 D 70 4WD	07/98-	WJY (DW8B), WJZ (DW8)	1868		0-N118P	TB [TE]	
1.9 D 70 , 1.9 D 70 4WD	07/98-	WJY (DW8B), WJZ (DW8)	1868		0-N1381	TB [DG]	
2.0 HDI 90 , 2.0 HDI 90 4WD	12/99-	RHY (DW10TD)	1997	Orga.→08735	0-N118P	TB [TE]	
2.0 HDI 90 , 2.0 HDI 90 4WD	12/99-	RHY (DW10TD)	1997	Orga.→08735	0-N119P	TB [DG]	
2.0 HDI 90 , 2.0 HDI 90 4WD	12/99-	RHY (DW10TD)	1997	Orga.08736→	0-N1381	TB [DG]	
1.1 i	07/96-	HDZ (TU1M), HFX (TU1JP)	1124	→ 12/2001	0-N125	VB [TE]	S
1.1 i	07/96-	HDZ (TU1M), HFX (TU1JP)	1124	01/2002 →; ☼	0-N1419	VB [DG]	
1.1 i	07/96-	HDZ (TU1M), HFX (TU1JP)	1124	01/2002 →; ☼	0-N1620	VB [BT]	S
1.1 i	07/96-	HDZ (TU1M), HFX (TU1JP)	1124	01/2002 →	0-N1949	VB [TE]	
1.4 bivalent, 1.4 i bivalent	11/02-	KFW (TU3JP)	1360		0-N1949	VB [TE]	
1.4 i	07/96-	KFW (TU3JP), KFX (TU3JP)	1360	→ 12/2001	0-N125	VB [TE]	S
1.4 i	07/96-	KFW (TU3JP), KFX (TU3JP)	1360	01/2002 →; ☼	0-N1419	VB [DG]	
1.4 i	07/96-	KFW (TU3JP), KFX (TU3JP)	1360	01/2002 →; ☼	0-N1620	VB [BT]	S
1.4 i	07/96-	KFW (TU3JP), KFX (TU3JP)	1360	01/2002 →	0-N1949	VB [TE]	
1.4, 1.4 bivalent, 1.4 i bivalent	11/02-	KFW (TU3JP)	1360	☼	0-N1419	VB [DG]	
1.4, 1.4 bivalent, 1.4 i bivalent	11/02-	KFW (TU3JP)	1360	☼	0-N1620	VB [BT]	S
1.6 16V	10/00-	NFU (TU5JP4)	1587	Orga.→12110; ☼	0-N1419	VB [DG]	
1.6 16V	10/00-	NFU (TU5JP4)	1587	☼	0-N1620	VB [BT]	S
1.6 16V	10/00-	NFU (TU5JP4)	1587	Orga.12110→; ☼	0-N1874	VB [BT]	S
1.6 16V	10/00-	NFU (TU5JP4)	1587		0-N1949	VB [TE]	
1.6 16V	10/00-	NFU (TU5JP4)	1587	Orga.12110→; ☼	0-N2191	VB [DG]	
1.6 HDI 75 , 1.6 HDI 90	07/05-	9HW (DV6BTED4), DV6B, 9HX (DV6ATED4)	1560	Orga.→10570	0-N1418	VB [DG]	
1.6 HDI 75 , 1.6 HDI 90	07/05-	9HW (DV6BTED4), DV6B, 9HX (DV6ATED4)	1560	Orga.→10570; ☼	0-N1420	VB [DG]	
1.6 HDI 75 , 1.6 HDI 90	07/05-	9HW (DV6BTED4), DV6B, 9HX (DV6ATED4)	1560	Orga.→10570	0-N1636	VB [BT]	S



CM³



Art. Nr.



ohne Halter

BERLINGO Kasten (M_)							
1.6 HDI 75 , 1.6 HDI 90	07/05-	9HW (DV6BTED4), DV6B, 9HX (DV6ATED4)	1560	Orga.10571→		0-N1807	VB [DG]
1.6 HDI 75 , 1.6 HDI 90	07/05-	9HW (DV6BTED4), DV6B, 9HX (DV6ATED4)	1560	Orga.10571→		0-N1808	VB [BT] S
1.8 D	07/96-	A9A (XUD7)	1769			0-N1320	VB [TE]
1.8 D	07/96-	A9A (XUD7)	1769			0-N1472	VB [BT] S
1.8 D	07/96-	A9A (XUD7)	1769			0-N1747	VB [VD]
1.8 D	07/96-	A9A (XUD7)	1769			0-N931	VB [TE]
1.8 i	08/99-10/02	LFX (XU7JB)	1761	Orga.07510FV, 08028FL→		0-N124	VB [TE]
1.8 i	08/99-10/02	LFX (XU7JB)	1761	Generator-Ladestrom [A]: 90; ⚡		0-N1402	VB [DG] S
1.8 i	08/99-10/02	LFX (XU7JB)	1761	Generator-Ladestrom [A]: 120; ⚡		0-N1465S	VB [DG]
1.8 i	08/99-10/02	LFX (XU7JB)	1761	⚡		0-N1484	VB [BT] S
1.8 i	08/99-10/02	LFX (XU7JB)	1761	Orga.0812077→; ⚡		0-N1722	VB [DG]
1.9 D	07/96-	DJY (XUD9A)	1905			0-N1320	VB [TE]
1.9 D	07/96-	DJY (XUD9A)	1905			0-N1472	VB [BT] S
1.9 D	07/96-	DJY (XUD9A)	1905			0-N1747	VB [VD]
1.9 D	07/96-	DJY (XUD9A)	1905			0-N931	VB [TE]
1.9 D 70 , 1.9 D 70 4WD	07/98-	WJY (DW8B), WJZ (DW8)	1868	Orga.08375→; für Fahrzeuge mit Servolenkung		0-N1309	VB [DG]
1.9 D 70 , 1.9 D 70 4WD	07/98-	WJY (DW8B), WJZ (DW8)	1868			0-N1320	VB [TE]
1.9 D 70 , 1.9 D 70 4WD	07/98-	WJY (DW8B), WJZ (DW8)	1868	Orga.→08374		0-N1455	VB [TE]
1.9 D 70 , 1.9 D 70 4WD	07/98-	WJY (DW8B), WJZ (DW8)	1868	Orga.08375→; für Fahrzeuge mit Servolenkung; ⚡		0-N1471	VB [BT] S
1.9 D 70 , 1.9 D 70 4WD	07/98-	WJY (DW8B), WJZ (DW8)	1868	Orga.→09610; ⚡, für Fahrzeuge mit Servolenkung		0-N1472	VB [BT] S
1.9 D 70 , 1.9 D 70 4WD	07/98-	WJY (DW8B), WJZ (DW8)	1868			0-N1545	VB [DG]
1.9 D 70 , 1.9 D 70 4WD	07/98-	WJY (DW8B), WJZ (DW8)	1868	⚡, ⚡, für Fahrzeuge ohne Servolenkung		0-N1681	VB [BT]
1.9 D 70 , 1.9 D 70 4WD	07/98-	WJY (DW8B), WJZ (DW8)	1868	Orga.→09610; ⚡, für Fahrzeuge mit Servolenkung		0-N1747	VB [VD]
1.9 D 70 , 1.9 D 70 4WD	07/98-	WJY (DW8B), WJZ (DW8)	1868	Orga.09611→; ⚡, für Fahrzeuge mit Servolenkung		0-N1945	VB [BT] S
2.0 HDI 90 , 2.0 HDI 90 4WD	12/99-	RHY (DW10TD)	1997			0-N1320	VB [TE]
2.0 HDI 90 , 2.0 HDI 90 4WD	12/99-	RHY (DW10TD)	1997			0-N1493	VB [BT] S
2.0 HDI 90 , 2.0 HDI 90 4WD	12/99-	RHY (DW10TD)	1997	⚡		0-N151	VB [DG]
2.0 HDI 90 , 2.0 HDI 90 4WD	12/99-	RHY (DW10TD)	1997	⚡		0-N1748	VB [BT]
BERLINGO (B9)							
1.4	03/09-	KFW (TU3JP)	1360	17x108; ⚡:→3666765		SK-1004	BTK
1.4	03/09-	KFW (TU3JP)	1360	17x108; ⚡:→3666765		SK-1004AQ1	BTKW
1.4	03/09-	KFW (TU3JP)	1360	17x104; ⚡:3666766→		SK-1354	BTK
1.4	03/09-	KFW (TU3JP)	1360	17x104; ⚡:3666766→		SK-1354AQ1	BTKW
1.6	04/08-	NFR (TU5JP4B), NFU (TU5JP4)	1587	25.4x134		SK-1615	BTK
1.6	04/08-	NFR (TU5JP4B), NFU (TU5JP4)	1587	25.4x134		SK-1615AQ1	BTKW
1.6 BlueHdi 75	04/15-	DV6ETED, DV6ETEDM	1560	25x141		SK-1728	BTK
1.6 BlueHdi 75	04/15-	DV6ETED, DV6ETEDM	1560	25x141		SK-1728AQ1	BTKW
1.6 HDi 110, 1.6 HDi 115, 1.6 HDi 90	07/10-	9HL (DV6C), 9HR (DV6C), 9HP (DV6DTE), 9HX (DV6ATED4), 9HR (DV6C)	1560	25x141		SK-1728	BTK
1.6 HDi 110, 1.6 HDi 115, 1.6 HDi 90	07/10-	9HL (DV6C), 9HR (DV6C), 9HP (DV6DTE), 9HX (DV6ATED4), 9HR (DV6C)	1560	25x141		SK-1728AQ1	BTKW
1.6 HDi 110, 1.6 HDi 75, 1.6 HDi 90	04/08-	9HN (DV6ETED4), 9HT (DV6BTED4), 9HX (DV6ATED4), 9HZ (DV6TED4)	1560	25x137		SK-1424	BTK
1.6 HDi 75, 1.6 HDi 90	04/08-	9HN (DV6ETED4), 9HT (DV6BTED4), 9HX (DV6ATED4)	1560	25x137		SK-1424AQ1	BTKW
1.6	04/08-	NFR (TU5JP4B), NFU (TU5JP4)	1587			0-N1359	TB [TE]
1.6	04/08-	NFR (TU5JP4B), NFU (TU5JP4)	1587			0-N1360	TB [DG]
1.6 BlueHdi 100, 1.6 BlueHdi 120, 1.6 HDi 110, 1.6 HDi 115	07/10-	9HL (DV6C), 9HR (DV6C), 9HP (DV6DTE), 9HX (DV6ATED4), 9HR (DV6C)	1560			0-N2382	TB [DG]
1.6 HDi 110, 1.6 HDi 115, 1.6 HDi 90	07/10-	9HL (DV6C), 9HR (DV6C), 9HP (DV6DTE), 9HX (DV6ATED4), 9HR (DV6C)	1560			0-N2224	TB [TE]
1.6 HDi 110, 1.6 HDi 75, 1.6 HDi 90	04/08-	9HN (DV6ETED4), 9HT (DV6BTED4), 9HP (DV6DTE), 9HX (DV6ATED4), 9HX (DV6ATED4), 9HZ (DV6TED4)	1560			0-N1062	TB [TE]
1.6 HDi 110, 1.6 HDi 75, 1.6 HDi 90	04/08-	9HN (DV6ETED4), 9HT (DV6BTED4), 9HX (DV6ATED4), 9HZ (DV6TED4)	1560			0-N1066	TB [DG]
1.6 HDi 75	04/08-	9HN (DV6ETED4)	1560			0-N2224	TB [TE]
1.6 HDi 75	04/08-	9HN (DV6ETED4)	1560			0-N2382	TB [DG]
1.6	04/08-	NFR (TU5JP4B), NFU (TU5JP4)	1587			0-N1419	VB [DG]
1.6	04/08-	NFR (TU5JP4B), NFU (TU5JP4)	1587			0-N1874	VB [BT] S



CM³



Art. Nr.



ohne Halter

BERLINGO (B9)

1.6 HDi 110	04/08-	9HZ (DV6TED4)	1560		0-N1502	VB [BT]	S
1.6 HDi 110, 1.6 HDi 115	07/10-	9HL (DV6C), 9HR (DV6C), 9HR (DV6C)	1560	Rippenanzahl: 6; für Fahrzeuge mit Start-Stopp-Funktion, ☼	0-N2355	VB [DG]	
1.6 HDi 110, 1.6 HDi 115	07/10-	9HL (DV6C), 9HR (DV6C), 9HR (DV6C)	1560	für Fahrzeuge mit Start-Stopp-Funktion	0-N2392	VB [BT]	S
1.6 HDi 110, 1.6 HDi 115, 1.6 HDi 90	07/10-	9HL (DV6C), 9HR (DV6C), 9HP (DV6DTED), 9HX (DV6ATED4), 9HR (DV6C)	1560	für Fahrzeuge ohne Start-Stopp-Funktion	0-N1502	VB [BT]	S
1.6 HDi 75, 1.6 HDi 90	04/08-	9HN (DV6ETED4), 9HT (DV6BTED4), 9HP (DV6DTED), 9HX (DV6ATED4), 9HX (DV6ATED4)	1560		0-N1807	VB [DG]	
1.6 HDi 75, 1.6 HDi 90	04/08-	9HN (DV6ETED4), 9HT (DV6BTED4), 9HX (DV6ATED4)	1560		0-N1808	VB [BT]	S
1.6 HDi 90	04/08-	DV6TED4B	1560	→ 11/2010; Orga.→12417; ☼	0-N1502	VB [BT]	S
1.6 HDi 90	04/08-	DV6TED4B	1560	☼	0-N1502	VB [BT]	S
1.6 VTi 120, 1.6 VTi 95	11/09-	5FK (EP6CB), 5FS (EP6C)	1598	☼	0-N2055	VB [BT]	S
1.6 VTi 120, 1.6 VTi 95	11/09-	5FK (EP6CB), 5FS (EP6C)	1598	für OE: 11 28 7 598 832, 11 28 7 598 833	0-N2237	VB [DG]	

BERLINGO Kasten (B9)

1.6	04/08-	NFR (TU5JP4B), NFU (TU5JP4)	1587	25.4x134	SK-1615	BTK	
1.6	04/08-	NFR (TU5JP4B), NFU (TU5JP4)	1587	25.4x134	SK-1615AQ1	BTKW	
1.6 BlueHDi 75	04/15-	DV6ETED, DV6ETED4	1560	25x141	SK-1728	BTK	
1.6 BlueHDi 75	04/15-	DV6ETED, DV6ETED4	1560	25x141	SK-1728AQ1	BTKW	
1.6 HDi 110, 1.6 HDi 115, 1.6 HDi 90	07/10-	9HL (DV6C), 9HL (DV6C), 9HR (DV6C), 9HP (DV6DTED)	1560	25x141	SK-1728	BTK	
1.6 HDi 110, 1.6 HDi 115, 1.6 HDi 90	07/10-	9HL (DV6C), 9HL (DV6C), 9HR (DV6C), 9HP (DV6DTED)	1560	25x141	SK-1728AQ1	BTKW	
1.6 HDi 110, 1.6 HDi 75, 1.6 HDi 90	04/08-	9HN (DV6ETED4), 9HT (DV6BUTED4), 9HS (DV6TED4BU), 9HX (DV6ATED4), 9HZ (DV6TED4)	1560	25x137	SK-1424	BTK	
1.6 HDi 110, 1.6 HDi 75, 1.6 HDi 90	04/08-	9HN (DV6ETED4), 9HT (DV6BUTED4), 9HS (DV6TED4BU), 9HX (DV6ATED4), 9HZ (DV6TED4)	1560	25x137	SK-1424AQ1	BTKW	
1.6 VTi 120	11/09-	5FS (EP6C)	1598	25.4x134	SK-1615	BTK	
1.6 VTi 120	11/09-	5FS (EP6C)	1598	25.4x134	SK-1615AQ1	BTKW	
1.6	04/08-	NFR (TU5JP4B), NFU (TU5JP4)	1587		0-N1359	TB [TE]	
1.6	04/08-	NFR (TU5JP4B), NFU (TU5JP4)	1587		0-N1360	TB [DG]	
1.6 BlueHDi 100, 1.6 BlueHDi 120, 1.6 HDi 110, 1.6 HDi 115, 1.6 HDi 90	07/10-	9HL (DV6C), 9HL (DV6C), 9HR (DV6C), 9HP (DV6DTED), BHY (DV6FD), BHZ (DV6FC)	1560		0-N2382	TB [DG]	
1.6 HDi 110, 1.6 HDi 115	07/10-	9HL (DV6C), 9HL (DV6C), 9HR (DV6C)	1560		0-N2224	TB [TE]	
1.6 HDi 110, 1.6 HDi 75, 1.6 HDi 90	04/08-	9HN (DV6ETED4), 9HT (DV6BUTED4), 9HS (DV6TED4BU), 9HX (DV6ATED4), 9HZ (DV6TED4)	1560		0-N1062	TB [TE]	
1.6 HDi 110, 1.6 HDi 75, 1.6 HDi 90	04/08-	9HN (DV6ETED4), 9HT (DV6BUTED4), 9HS (DV6TED4BU), 9HX (DV6ATED4), 9HZ (DV6TED4)	1560		0-N1066	TB [DG]	
1.6 HDi 75	04/08-	9HN (DV6ETED4)	1560		0-N2224	TB [TE]	
1.6 HDi 75	04/08-	9HN (DV6ETED4)	1560		0-N2382	TB [DG]	
1.6 HDi 90	07/10-	DV6DTED	1560		0-N2224	TB [TE]	
1.6	04/08-	NFR (TU5JP4B), NFU (TU5JP4)	1587		0-N1419	VB [DG]	
1.6	04/08-	NFR (TU5JP4B), NFU (TU5JP4)	1587		0-N1874	VB [BT]	S
1.6 HDi 110	04/08-	9HZ (DV6TED4)	1560		0-N1502	VB [BT]	S
1.6 HDi 110, 1.6 HDi 115, 1.6 HDi 90	07/10-	9HL (DV6C), 9HL (DV6C), 9HR (DV6C), 9HP (DV6DTED)	1560	Rippenanzahl: 6; für Fahrzeuge mit Start-Stopp-Funktion, ☼	0-N2355	VB [DG]	
1.6 HDi 110, 1.6 HDi 115, 1.6 HDi 90	07/10-	9HL (DV6C), 9HL (DV6C), 9HR (DV6C), 9HP (DV6DTED)	1560	für Fahrzeuge mit Start-Stopp-Funktion	0-N2392	VB [BT]	S
1.6 HDi 110, 1.6 HDi 90	07/10-	9HL (DV6C), 9HR (DV6C), 9HP (DV6DTED)	1560	für Fahrzeuge ohne Start-Stopp-Funktion	0-N1502	VB [BT]	S
1.6 HDi 115	07/10-	DV6C	1560	für Fahrzeuge ohne Start-Stopp-Funktion	0-N1502	VB [BT]	S
1.6 HDi 75, 1.6 HDi 90	04/08-	9HN (DV6ETED4), 9HT (DV6BUTED4), 9HS (DV6TED4BU), 9HX (DV6ATED4)	1560		0-N1807	VB [DG]	
1.6 HDi 75, 1.6 HDi 90	04/08-	9HN (DV6ETED4), 9HT (DV6BUTED4), 9HS (DV6TED4BU), 9HX (DV6ATED4)	1560		0-N1808	VB [BT]	S
1.6 HDi 90	04/08-	DV6TED4BU	1560	→ 11/2010; Orga.→12417; ☼	0-N1502	VB [BT]	S
1.6 HDi 90	04/08-	DV6TED4BU	1560	☼	0-N1502	VB [BT]	S
1.6 HDi 90	04/08-	9HP (DV6DTED), 9HS (DV6TED4BU), 9HX (DV6ATED4)	1560	11/2010 →; ☼	0-N2115	VB [BT]	S
1.6 VTi 120, 1.6 VTi 95	11/09-	5FK (EP6CB), 5FS (EP6C)	1598	☼	0-N2055	VB [BT]	S
1.6 VTi 120, 1.6 VTi 95	11/09-	5FK (EP6CB), 5FS (EP6C)	1598	für OE: 11 28 7 598 832, 11 28 7 598 833	0-N2237	VB [DG]	

BERLINGO Pritsche/Fahrgestell (B9)

1.6 HDi 90	04/08-	9HX (DV6ATED4)	1560	25x137	SK-1424	BTK	
1.6 HDi 90	04/08-	9HX (DV6ATED4)	1560	25x137	SK-1424AQ1	BTKW	



CM³



Art. Nr.



ohne Halter

BERLINGO Pritsche/Fahrgestell (B9)							
1.6 HDi 90	04/08-	9HX (DV6ATED4)	1560			0-N1062	TB [TE]
1.6 HDi 90	04/08-	9HX (DV6ATED4)	1560	✱		0-N1502	VB [BT] S
1.6 HDi 90	04/08-	9HX	1560	✱		0-N1807	VB [DG]
1.6 HDi 90	04/08-	9HX (DV6ATED4)	1560	✱		0-N1807	VB [DG]
BX (XB-_)							
1.6	01/87-01/92	B6D, B6E	1580	17x113; Orga.→5545		SK-1006	BTK
1.8 D	10/85-09/93	161 (XUD7)	1769	25.39x136		SK-1007	BTK
1.8 D	10/85-09/93	161 (XUD7)	1769	25.4x136; 09/1986 →; Orga.03584→		SK-1007AQ1	BTKW
11	10/86-06/92	H1A	1124	17x104; 05/1988 →; Orga.04193→		SK-1003	BTK
11	10/86-06/92	H1A, HDZ (TU1M)	1124	17x104; Orga.4193→		SK-1003AQ1	BTKW
11	10/88-06/92	HDZ (TU1M)	1124	17x104; Orga.04193→		SK-1003	BTK
14	01/89-02/93	K1H (TU3A), KDY (TU3M), KDZ (TU3M/Z)	1360	17x108		SK-1004	BTK
14	01/89-02/93	KDY (TU3M), KDZ (TU3M/Z)	1360	17x108; → 12/1991; Orga.4193→		SK-1004AQ1	BTKW
14	01/89-12/89	K1H (TU3A)	1360	17x108; Orga.4193→		SK-1004AQ1	BTKW
14 E	10/82-02/93	150A, 150C, 150C, K1G, 150F	1360	17x108; 05/1988 →; Orga.04193→		SK-1004	BTK
14 E	04/83-02/93	150C	1360	17x108; 05/1985 → 12/1991; Orga.4193→		SK-1004AQ1	BTKW
14 E	09/85-02/93	150F	1360	17x108; 05/1988 → 12/1991; Orga.4193→		SK-1004AQ1	BTKW
14 E	10/85-05/89		1360	17x108; 05/1988 →; Orga.4193→		SK-1004AQ1	BTKW
14, 14 E	10/82-12/89	150A, 150C, K1G, K1H (TU3A)	1360	17x101; Orga.05440→		SK-1020	BTK
14, 14 E	10/82-02/93	150F, KDY (TU3M), KDZ (TU3M/Z)	1360	17x101; 10/1991 →; Orga.05440→		SK-1020AQ1	BTKW
14, 14 E	04/83-02/93	150C, 150F, KDY (TU3M), KDZ (TU3M/Z)	1360	17x101; 10/1991 →; Orga.05440→		SK-1020	BTK
15, 16, 16 E	10/82-02/93	171D, 180Z, B1A (XU51C/K), B1E (XU51C), BAY (XU5CP), BAZ (XU5CP), BDY (XU5M), BDZ (XU5M), XU52C	1580	17x113; → 01/1992; Orga.→5545		SK-1006	BTK
15, 16, 16 E	10/82-02/93	171D, 180Z, B1A (XU51C/K), B1E (XU51C), BAY (XU5CP), BAZ (XU5CP), BDY (XU5M), BDZ (XU5M), XU52C	1580	17x114; 01/1992 →; Orga.5546→		SK-1019	BTK
16	10/82-06/88	171A, 171B, 171C	1580	17x113		SK-1006	BTK
19	07/86-05/89	D2A (XU92C)	1905	17x113		SK-1006	BTK
19	07/86-11/89	159A, D2C (XU92C)	1905	17x113; Orga.→5545		SK-1006	BTK
19 D	09/83-09/93	162 (XUD9), D9A (XUD9), DJZ (XUD9Y), D9B (XUD9A/U)	1905	25.39x136		SK-1007	BTK
19 D	09/83-09/93	162 (XUD9), D9A (XUD9), DJZ (XUD9Y), D9B (XUD9A/U)	1905	25.4x136; Orga.3584→		SK-1007AQ1	BTKW
19 E	06/88-02/93	DDZ (XU9M)	1905	17x114; 02/1992 →		SK-1019	BTK
19 E 4x4	04/89-02/93	D2F	1905	25.4x136; → 01/1992; Orga.→5409		SK-1007AQ1	BTKW
19 E 4x4, 19 GTi, 19 GTi 4x4	07/86-02/93	D2F, D6A (XU9J2), DKZ (XU9JA)	1905	17x114; 01/1992 →; Orga.5546→		SK-1019	BTK
19 E, 19 E 4x4, 19 GTi	07/86-02/93	D2F, D6A (XU9J2), DDZ (XU9M), DKZ (XU9JA)	1905	17x113; → 01/1992; Orga.→5545		SK-1006	BTK
19 GTi 16V	09/87-02/93	D6C (XU9J4), DFW (XU9J4)	1905	25x133		SK-1157	BTK
19 GTi 4x4	06/88-02/93	DKZ (XU9JA)	1905	17x113; 09/1988 → 01/1992; Orga.→5545		SK-1006	BTK
TRD Turbo	03/88-02/93	A8A	1769	25.39x136		SK-1007	BTK
TRD Turbo	03/88-02/93	A8A (XUD7TE), AJZ (XUD7TE)	1769	25.4x136		SK-1007AQ1	BTKW
1.8 D, TRD Turbo	10/85-09/93	161 (XUD7), A8A (XUD7TE), AJZ (XUD7TE)	1769			0-N813	TB [TE]
1.8 D, TRD Turbo	10/85-09/93	161 (XUD7), A8A (XUD7TE), AJZ (XUD7TE)	1769			0-N814	TB [DG]
1.9 Allrad	02/92-06/94		1905			0-N811	TB [TE]
1.9 RD 4x4, 19 D	09/83-09/93	162 (XUD9), D9A (XUD9), DJZ (XUD9Y), D9B (XUD9A/U)	1905			0-N813	TB [TE]
1.9 RD 4x4, 19 D	09/83-09/93	162 (XUD9), D9A (XUD9), DJZ (XUD9Y), D9B (XUD9A/U)	1905			0-N814	TB [DG]
11	10/86-06/92	H1A	1124	05/1988 →		0-N811	TB [TE]
11	10/88-06/92	HDZ (TU1M)	1124			0-N811	TB [TE]
14	01/89-02/93	K1H (TU3A), KDY (TU3M), KDZ (TU3M/Z)	1360			0-N811	TB [TE]
14 E	04/83-02/93	150C, 150F	1360	05/1988 →		0-N811	TB [TE]
15, 16, 16 E	10/82-02/93	171D, 180Z, B1A (XU51C/K), B1E (XU51C), BAY (XU5CP), BAZ (XU5CP), BDY (XU5M), BDZ (XU5M), XU52C	1580	02/1992 →		0-N811	TB [TE]
15, 16, 16 E	10/82-02/93	171D, 180Z, B1E (XU51C), BAY (XU5CP), BAZ (XU5CP), BDY (XU5M), BDZ (XU5M), XU52C	1580	→ 01/1992		0-N812	TB [TE]
16	10/82-06/88	171A, 171B, 171C	1580			0-N812	TB [TE]
19	07/86-11/89	159A, D2A (XU92C), D2C (XU92C)	1905			0-N812	TB [TE]
19 E, 19 E 4x4, 19 GTi, 19 GTi 4x4	07/86-02/93	D2F, D6A (XU9J2), DDZ (XU9M), DKZ (XU9JA)	1905	02/1992 →		0-N811	TB [TE]
19 E, 19 E 4x4, 19 GTi, 19 GTi 4x4	07/86-02/93	D2F, D6A (XU9J2), DDZ (XU9M), DKZ (XU9JA)	1905	→ 01/1992		0-N812	TB [TE]
19 GTi 16V	09/87-02/93	D6C (XU9J4), DFW (XU9J4)	1905			0-N869	TB [TE]
1.8 D, TRD Turbo	10/85-09/93	161 (XUD7), A8A (XUD7TE), AJZ (XUD7TE)	1769			0-N1682	VB [BT]
1.8 D, TRD Turbo	10/85-09/93	161 (XUD7), A8A (XUD7TE), AJZ (XUD7TE)	1769			0-N2349	VB [DG]



CM³



Art. Nr.



ohne Halter

BX (XB-)

1.9 RD 4x4, 19 D	09/83-09/93	162 (XUD9), D9A (XUD9), DJZ (XUD9Y), D9B (XUD9A/U)	1905		0-N1682	VB [BT]
1.9 RD 4x4, 19 D	09/83-09/93	162 (XUD9), D9A (XUD9), DJZ (XUD9Y), D9B (XUD9A/U)	1905		0-N2349	VB [DG]
15, 16, 16 E	10/82-02/93	171D, 180Z, B1E (XU51C), BAY (XU5CP), BAZ (XU5CP), BDY (XU5M), BDZ (XU5M), XU52C	1580	→ 02/1992	0-N849	VB [TE]
16	10/82-06/88	171A, 171B, 171C	1580		0-N849	VB [TE]
19	07/86-11/89	159A, D2A (XU92C), D2C (XU92C)	1905		0-N849	VB [TE]
19 E, 19 E 4x4, 19 GTi, 19 GTi 4x4	07/86-02/93	D2F, D6A (XU9J2), DDZ (XU9M), DKZ (XU9JA)	1905	→ 02/1992	0-N849	VB [TE]

BX Break (XB-)

1.4, 14	01/86-02/93	150C	1360	17x108; 05/1988 →; Orga.04193→	SK-1004	BTK
1.4, 14	01/86-02/93	150C, KDY (TU3M)	1360	17x101; 10/1991 →; Orga.05440→	SK-1020	BTK
1.4, 14	01/86-02/93	150C, KDY (TU3M)	1360	17x101; 10/1991 →; Orga.05440→	SK-1020AQ1	BTKW
1.6, 16	04/83-01/92	171C, B6D, B6E	1580	17x113; Orga.→5545	SK-1006	BTK
1.9 D, 1.9 DT TXD	01/87-12/94		1905	25.4x136	SK-1007AQ1	BTKW
1.9 D, 1.9 DT TXD, 19 D	09/83-12/94	162 (XUD9), D9A (XUD9), DJZ (XUD9Y), D9B (XUD9A/U)	1905	25.39x136	SK-1007	BTK
14	01/86-02/93	150C	1360	17x108; 05/1988 → 12/1991; Orga.4193→	SK-1004AQ1	BTKW
14	01/89-02/93	KDY (TU3M)	1360	17x108; Orga.04193→	SK-1004	BTK
14	01/89-12/89	K1H (TU3A)	1360	17x108	SK-1004	BTK
14	01/89-02/93	KDY (TU3M)	1360	17x108; → 12/1991; Orga.4193→	SK-1004AQ1	BTKW
14	01/89-12/89	K1H (TU3A)	1360	17x108; Orga.4193→	SK-1004AQ1	BTKW
15, 16	07/85-12/94	171D, 180Z, B1E (XU51C), BAY (XU5CP), BAZ (XU5CP), BDY (XU5M), BDZ (XU5M)	1580	17x114; 01/1992 →; Orga.5546→	SK-1019	BTK
15, 16	03/86-12/94	180Z, B1E (XU51C), BAY (XU5CP), BAZ (XU5CP), BDY (XU5M), BDZ (XU5M)	1580	17x113; → 01/1992; Orga.→5545	SK-1006	BTK
16	06/85-06/88	171A, 171B, 171C	1580	17x113	SK-1006	BTK
16	07/85-12/94	171D	1580	17x113; 01/1987 → 01/1992; Orga.→5545	SK-1006	BTK
18 D	10/85-09/93	161A (XUD7)	1769	25.39x136	SK-1007	BTK
18 D	10/85-09/93	161A (XUD7)	1769	25.4x136; 09/1986 →; Orga.03584→	SK-1007AQ1	BTKW
19 D	09/83-12/94	162 (XUD9), D9A (XUD9), DJZ (XUD9Y), D9B (XUD9A/U)	1905	25.4x136; Orga.3584→	SK-1007AQ1	BTKW
19, 19 4x4	12/87-05/91	D2C (XU92C), D2E, DDZ (XU9M)	1905	17x113; Orga.→5545	SK-1006	BTK
19, 19 KAT	07/86-12/94	D2A (XU92C), DDZ (XU9M), DFZ (XU9J1), DKZ (XU9JA)	1905	17x113; → 01/1992; Orga.→5545	SK-1006	BTK
19, 19 KAT	07/86-12/94	D2A (XU92C), DDZ (XU9M), DFZ (XU9J1), DKZ (XU9JA)	1905	17x114; 01/1992 →; Orga.5546→	SK-1019	BTK
TRD Turbo	03/88-12/94	A8A	1769	25.39x136	SK-1007	BTK
TRD Turbo	03/88-12/94	A8A (XUD7TE), AJZ (XUD7TE)	1769	25.4x136	SK-1007AQ1	BTKW
1.4, 14	01/86-02/93	150C	1360	05/1988 →	0-N811	TB [TE]
1.9 D, 1.9 DT TXD, 19 D	09/83-12/94	162 (XUD9), D9A (XUD9), DJZ (XUD9Y), D9B (XUD9A/U)	1905		0-N813	TB [TE]
1.9 D, 1.9 DT TXD, 19 D	09/83-12/94	162 (XUD9), D9A (XUD9), DJZ (XUD9Y), D9B (XUD9A/U)	1905		0-N814	TB [DG]
1.9 GTi 4x4, 1.9 TZI	02/92-12/94	D6A (XU9J2)	1905		0-N811	TB [TE]
14	01/89-02/93	K1H (TU3A), KDY (TU3M)	1360		0-N811	TB [TE]
15, 16	07/85-12/94	171D, 180Z, B1E (XU51C), BAY (XU5CP), BAZ (XU5CP), BDY (XU5M), BDZ (XU5M)	1580	02/1992 →	0-N811	TB [TE]
15, 16	07/85-12/94	171D, 180Z, B1E (XU51C), BDY (XU5M), BDZ (XU5M)	1580	→ 01/1992	0-N812	TB [TE]
16	04/83-01/92	171A, 171B, 171C, 171C	1580		0-N812	TB [TE]
18 D, TRD Turbo	10/85-12/94	161A (XUD7), A8A (XUD7TE), AJZ (XUD7TE)	1769		0-N813	TB [TE]
18 D, TRD Turbo	10/85-12/94	161A (XUD7), A8A (XUD7TE), AJZ (XUD7TE)	1769		0-N814	TB [DG]
19, 19 4x4	12/87-05/91	D2C (XU92C), D2E, DDZ (XU9M)	1905		0-N812	TB [TE]
19, 19 KAT	07/86-12/94	D2A (XU92C), DDZ (XU9M), DFZ (XU9J1), DKZ (XU9JA)	1905	02/1992 →	0-N811	TB [TE]
19, 19 KAT	07/86-12/94	D2A (XU92C), DDZ (XU9M), DFZ (XU9J1), DKZ (XU9JA)	1905	→ 01/1992	0-N812	TB [TE]
1.9 D, 1.9 DT TXD, 19 D	09/83-12/94	162 (XUD9), D9A (XUD9), DJZ (XUD9Y), D9B (XUD9A/U)	1905		0-N1682	VB [BT]
1.9 D, 1.9 DT TXD, 19 D	09/83-12/94	162 (XUD9), D9A (XUD9), DJZ (XUD9Y), D9B (XUD9A/U)	1905		0-N2349	VB [DG]
15, 16	07/85-12/94	171D, 180Z, B1E (XU51C), BDY (XU5M), BDZ (XU5M)	1580	→ 02/1992	0-N849	VB [TE]
16	04/83-01/92	171A, 171B, 171C, 171C	1580		0-N849	VB [TE]
18 D, TRD Turbo	10/85-12/94	161A (XUD7), A8A (XUD7TE), AJZ (XUD7TE)	1769		0-N1682	VB [BT]

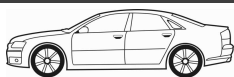

CM³



Art. Nr.



ohne Halter

BX Break (XB-)							
18 D, TRD Turbo	10/85-12/94	161A (XUD7), A8A (XUD7TE), AJZ (XUD7TE)	1769			0-N2349	VB [DG]
19, 19 4x4	07/86-12/94	D2A (XU92C), D2C (XU92C), D2E, DDZ (XU9M)	1905			0-N849	VB [TE]
19, 19 KAT	07/86-12/94	DDZ (XU9M), DFZ (XU9J1), DKZ (XU9JA)	1905	→ 02/1992		0-N849	VB [TE]
C1 (PM_, PN_)							
1.4 HDi	06/05-	8HT (DV4TD), 8HT (DV4TD)	1398	25.4x144		SK-1391	BTK
1.4 HDi	06/05-	8HT (DV4TD), 8HT (DV4TD)	1398	25.4x144		SK-1391AQ1	BTKW
1.4 HDi	06/05-	8HT (DV4TD), 8HT (DV4TD)	1398			0-N1062	TB [TE]
1.4 HDi	06/05-	8HT (DV4TD), 8HT (DV4TD)	1398			0-N1066	TB [DG]
1.4 HDi	06/05-	8HT (DV4TD), 8HT (DV4TD)	1398			0-N1339	VB [BT] S
1.4 HDi	06/05-	8HT (DV4TD), 8HT (DV4TD)	1398			0-N1418	VB [DG]
C1 II							
1.2 VTi 82	04/14-	HMT (EB2D)	1199			0-N2424	TB [DG]
C2 (JM_)							
1.1	09/03-	HFX (TU1JP)	1124	17x100		SK-1353	BTK
1.1	09/03-	HFX (TU1JP)	1124	17x100		SK-1353AQ1	BTKW
1.4	09/03-	KFV (TU3JP)	1360	17x104; 11/2007 →		SK-1354	BTK
1.4	09/03-	KFV (TU3JP)	1360	17x104		SK-1354AQ1	BTKW
1.4	10/06-	KFV (TU3JP)	1360	17x104		SK-1354	BTK
1.4 16V	06/06-	KFU (ET3J4)	1360	25x135		SK-1598	BTK
1.4 16V	06/06-	KFU (ET3J4)	1360	25x135		SK-1598AQ1	BTKW
1.4 HDi	09/03-	8HX (DV4TD), 8HZ (DV4TD)	1398	25.4x144		SK-1391	BTK
1.4 HDi	09/03-	8HX (DV4TD), 8HZ (DV4TD)	1398	25.4x144		SK-1391AQ1	BTKW
1.6 HDi	09/05-	9HZ (DV6TED4)	1560	25x137		SK-1424	BTK
1.6 HDi	09/05-	9HZ (DV6TED4)	1560	25x137		SK-1424AQ1	BTKW
1.6, 1.6 VTS	09/03-	NFS (TU5JP4S), NFU (TU5JP4)	1587	25.4x134		SK-1615	BTK
1.6, 1.6 VTS	09/03-	NFS (TU5JP4S), NFU (TU5JP4)	1587	25.4x134		SK-1615AQ1	BTKW
1.1	09/03-	HFX (TU1JP)	1124			0-N1277	TB [TE]
1.4	09/03-	KFV (TU3JP)	1360			0-N1277	TB [TE]
1.4 16V	06/06-	KFU (ET3J4)	1360			0-N1338	TB [TE]
1.4 16V	06/06-	KFU (ET3J4)	1360			0-N1456	TB [DG]
1.4 16V	06/06-	KFU (ET3J4)	1360	für Fahrzeuge mit Start-Stopp-Funktion		0-N2095S1	TB [VD]
1.4 HDi	09/03-	8HX (DV4TD), 8HZ (DV4TD)	1398			0-N1062	TB [TE]
1.4 HDi	09/03-	8HX (DV4TD), 8HZ (DV4TD)	1398			0-N1066	TB [DG]
1.6 HDi	09/05-	9HZ (DV6TED4)	1560			0-N1062	TB [TE]
1.6 HDi	09/05-	9HZ (DV6TED4)	1560			0-N1066	TB [DG]
1.6, 1.6 VTS	09/03-	NFS (TU5JP4S), NFU (TU5JP4)	1587			0-N1359	TB [TE]
1.6, 1.6 VTS	09/03-	NFS (TU5JP4S), NFU (TU5JP4)	1587			0-N1360	TB [DG]
1.1	09/03-	HFX (TU1JP)	1124	Orga.→09884		0-N1455	VB [TE]
1.1	09/03-	HFX (TU1JP)	1124	Orga.09885→		0-N1673	VB [BT] S
1.4	09/03-	KFV (TU3JP)	1360	Orga.→09884		0-N1455	VB [TE]
1.4	09/03-	KFV (TU3JP)	1360	Orga.09885→		0-N1673	VB [BT] S
1.4	10/06-	KFV (TU3JP)	1360			0-N1673	VB [BT] S
1.4 16V	06/06-	KFU (ET3J4)	1360	für Fahrzeuge mit Start-Stopp-Funktion		0-N2095	VB [BT] S
1.4 HDi	09/03-	8HX (DV4TD), 8HZ (DV4TD)	1398	→ 05/2005; Orga.→10426		0-N1339	VB [BT] S
1.4 HDi	09/03-	8HX (DV4TD), 8HZ (DV4TD)	1398	Orga.→10426		0-N1418	VB [DG]
1.4 HDi	09/03-	8HX (DV4TD), 8HZ (DV4TD)	1398	Orga.10427→11073		0-N1807	VB [DG]
1.4 HDi	09/03-	8HX (DV4TD), 8HZ (DV4TD)	1398	Orga.10536→11073; ⚡		0-N1924	VB [DG]
1.6	09/03-	NFU (TU5JP4)	1587	Orga.→09884		0-N1455	VB [TE]
1.6	09/03-	NFU (TU5JP4)	1587	Orga.09885→		0-N1673	VB [BT] S
1.6 HDi	09/05-	9HZ (DV6TED4)	1560			0-N1502	VB [BT] S
1.6 VTS	01/05-	NFS (TU5JP4S)	1587			0-N1673	VB [BT] S
C2 ENTERPRISE							
1.4 HDi	04/09-	8HX (DV4TD)	1398	25.4x144		SK-1391	BTK
1.4 HDi	04/09-	8HX (DV4TD)	1398	25.4x144		SK-1391AQ1	BTKW
1.4 HDi	04/09-	8HX (DV4TD)	1398			0-N1062	TB [TE]
1.4 HDi	04/09-	8HX (DV4TD)	1398			0-N1066	TB [DG]
1.4 HDi	04/09-	8HX (DV4TD)	1398	Orga.→10426; ⚡		0-N1418	VB [DG]
1.4 HDi	04/09-	8HX	1398	Orga.10427→11073; ⚡		0-N1807	VB [DG]
C3 I (FC_)							
1.1 i	02/02-	HFX (TU1A), HFX (TU1JP)	1124	17x100		SK-1353	BTK
1.1 i	02/02-	HFX (TU1A), HFX (TU1JP)	1124	17x100		SK-1353AQ1	BTKW
1.4 16V	12/03-	KFU (ET3J4)	1360	25x135		SK-1598	BTK

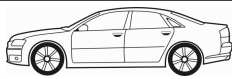

CM³



Art. Nr.



ohne Halter

C3 I (FC_)

1.4 16V	12/03-	KFU (ET3J4)	1360	25x135	SK-1598AQ1	BTkW	
1.4 16V HDi	02/02-	8HY (DV4TED4)	1398	25.4x135	SK-1577	BTK	
1.4 HDi	02/02-	8HX (DV4TD)	1398	25.4x144	SK-1391	BTK	
1.4 HDi	02/02-	8HX (DV4TD)	1398	25.4x144	SK-1391AQ1	BTkW	
1.4 HDi	02/02-	8HX (DV4TD)	1398	25.4x135; → 05/2010	SK-1577AQ1	BTkW	
1.4 i, 1.4 i Bivalent	02/02-	KFV (TU3A), KFV (TU3JP), KFV (TU3JP)	1360	17x104	SK-1354	BTK	
1.4 i, 1.4 i Bivalent	02/02-	KFV (TU3A), KFV (TU3JP), KFV (TU3JP)	1360	17x104	SK-1354AQ1	BTkW	
1.6 16V	02/02-	NFU (TU5JP4)	1587	25.4x134; :→1806404; mit Zubehör	SK-1392	BTK	
1.6 16V	02/02-	NFU (TU5JP4)	1587	25.4x134; :→1806404; mit Zubehör	SK-1392AQ1	BTkW	
1.6 16V	02/02-	NFU (TU5JP4)	1587	25.4x134; → 08/2007; :1806405→11253	SK-1615	BTK	
1.6 16V	02/02-	NFU (TU5JP4)	1587	25.4x134; :1806405→	SK-1615AQ1	BTkW	
1.6 16V HDi	09/05-	9HX (DV6ATED4), 9HZ (DV6TED4)	1560	25x137	SK-1424	BTK	
1.6 16V HDi	09/05-	9HX (DV6ATED4), 9HZ (DV6TED4)	1560	25x137	SK-1424AQ1	BTkW	
1.1 i	02/02-	HFX (TU1A), HFX (TU1JP)	1124		0-N1277	TB [TE]	
1.4 16V	12/03-	KFU (ET3J4)	1360		0-N1338	TB [TE]	
1.4 16V	12/03-	KFU (ET3J4)	1360		0-N1456	TB [DG]	
1.4 16V	12/03-	KFU (ET3J4)	1360	für Fahrzeuge mit Start-Stopp-Funktion	0-N2095S1	TB [VD]	
1.4 16V HDi, 1.4 HDi	02/02-	8HX (DV4TD), 8HY (DV4TED4), 8HZ (DV4TD)	1398		0-N1062	TB [TE]	
1.4 16V HDi, 1.4 HDi	02/02-	8HX (DV4TD), 8HY (DV4TED4), 8HZ (DV4TD)	1398		0-N1066	TB [DG]	
1.4 i, 1.4 i Bivalent	02/02-	KFV (TU3A), KFV (TU3JP), KFV (TU3JP)	1360		0-N1277	TB [TE]	
1.6 16V	02/02-	NFU (TU5JP4)	1587	:→1806404	0-N1061	TB [TE]	
1.6 16V	02/02-	NFU (TU5JP4)	1587	:→1806404	0-N122	TB [DG]	
1.6 16V HDi	09/05-	9HX (DV6ATED4), 9HZ (DV6TED4)	1560		0-N1062	TB [TE]	
1.6 16V HDi	09/05-	9HX (DV6ATED4), 9HZ (DV6TED4)	1560		0-N1066	TB [DG]	
1.6 16V, 1.6 Bioflex	02/02-	NFU (TU5JP4)	1587	:1806405→	0-N1359	TB [TE]	
1.6 16V, 1.6 Bioflex	02/02-	NFU (TU5JP4)	1587	:1806405→	0-N1360	TB [DG]	
1.1 i	02/02-	HFX (TU1A), HFX (TU1JP)	1124	Orga.→09884	0-N1455	VB [TE]	
1.1 i	02/02-	HFX (TU1A), HFX (TU1JP)	1124	Orga.09885→;	0-N1673	VB [BT]	S
1.4 16V	12/03-	KFU (ET3J4)	1360	für Fahrzeuge mit Start-Stopp-Funktion	0-N2095	VB [BT]	S
1.4 16V HDi	02/02-	8HY (DV4TED4)	1398	03/2007 →	0-N1502	VB [BT]	S
1.4 16V HDi, 1.4 HDi	02/02-	8HX (DV4TD), 8HY (DV4TED4)	1398	→ 10/2005; Orga.→10555	0-N1339	VB [BT]	S
1.4 16V HDi, 1.4 HDi	02/02-	8HX (DV4TD), 8HY (DV4TED4)	1398	Orga.→10555	0-N1418	VB [DG]	
1.4 16V HDi, 1.4 HDi	02/02-	8HX (DV4TD), 8HY (DV4TED4)	1398	Orga.10556→11073	0-N1807	VB [DG]	
1.4 16V HDi, 1.4 HDi	02/02-	8HX (DV4TD), 8HY (DV4TED4)	1398	Orga.10556→11073;	0-N1924	VB [DG]	
1.4 16V, 1.4 i, 1.4 i Bivalent	02/02-	KFU (ET3J4), KFV (TU3A), KFV (TU3JP), KFV (TU3JP)	1360	Orga.→09884	0-N1455	VB [TE]	
1.4 16V, 1.4 i, 1.4 i Bivalent	02/02-	KFU (ET3J4), KFV (TU3A), KFV (TU3JP), KFV (TU3JP)	1360	Orga.09885→;	0-N1673	VB [BT]	S
1.4 HDi	02/02-	8HX (DV4TD)	1398	03/2007 →; Orga.11074→	0-N1502	VB [BT]	S
1.4 HDi	07/03-	DV4TD	1398	Orga.→10555;	0-N1418	VB [DG]	
1.4 HDi	07/03-	DV4TD	1398	Orga.10556→11073;	0-N1807	VB [DG]	
1.6 16V	02/02-	NFU (TU5JP4)	1587	Orga.→09884	0-N1455	VB [TE]	
1.6 16V HDi	09/05-	9HX (DV6ATED4), 9HZ (DV6TED4)	1560	→ 10/2005; Orga.→10555	0-N1339	VB [BT]	S
1.6 16V HDi	09/05-	9HZ (DV6TED4)	1560	Orga.→10555	0-N1418	VB [DG]	
1.6 16V HDi	09/05-	9HX (DV6ATED4), 9HZ (DV6TED4)	1560	03/2007 →; Orga.11074→	0-N1502	VB [BT]	S
1.6 16V HDi	09/05-	9HZ (DV6TED4)	1560	Orga.10556→	0-N1807	VB [DG]	
1.6 16V HDi	09/05-	9HZ (DV6TED4)	1560	Orga.10556→11073;	0-N1924	VB [DG]	
1.6 16V HDi	10/05-	9HX (DV6ATED4)	1560		0-N1418	VB [DG]	
1.6 16V HDi	10/05-	9HX (DV6ATED4)	1560		0-N1420	VB [DG]	
1.6 16V HDi	10/05-	9HX (DV6ATED4)	1560		0-N1636	VB [BT]	S
1.6 16V, 1.6 Bioflex	02/02-	NFU (TU5JP4)	1587	Orga.09885→;	0-N1673	VB [BT]	S

C3 Pluriel (HB_)

1.4 HDi	04/04-	8HX (DV4TD)	1398	25.4x144; 05/2004 →	SK-1391	BTK	
1.4 HDi	04/04-	8HX (DV4TD)	1398	25.4x144; 05/2004 →	SK-1391AQ1	BTkW	
1.4, 1.4 Hybrid	05/03-	KFV (TU3JP)	1360	17x104	SK-1354	BTK	
1.4, 1.4 Hybrid	05/03-	KFV (TU3JP)	1360	17x104	SK-1354AQ1	BTkW	
1.6	05/03-	NFU (TU5JP4)	1587	25.4x134; :→1806404; mit Zubehör	SK-1392	BTK	
1.6	05/03-	NFU (TU5JP4)	1587	25.4x134	SK-1615	BTK	
1.6	05/03-	NFU (TU5JP4)	1587	25.4x134; :1806405→	SK-1615AQ1	BTkW	
1.4 HDi	04/04-	8HX (DV4TD)	1398		0-N1062	TB [TE]	
1.4 HDi	04/04-	8HX (DV4TD)	1398		0-N1066	TB [DG]	
1.4, 1.4 Hybrid	05/03-	KFV (TU3JP)	1360		0-N1277	TB [TE]	
1.6	05/03-	NFU (TU5JP4)	1587	:→1806404	0-N1061	TB [TE]	
1.6	05/03-	NFU (TU5JP4)	1587	:→1806404	0-N122	TB [DG]	



CM³



Art. Nr.



C3 Pluriel (HB_)							
1.6	05/03-	NFU (TU5JP4)	1587	1806405→	0-N1359	TB [TE]	
1.6	05/03-	NFU (TU5JP4)	1587	1806405→	0-N1360	TB [DG]	
1.4	05/03-	KFV (TU3JP)	1360	Orga.→09884	0-N1455	VB [TE]	
1.4 HDi	04/04-	8HX (DV4TD)	1398	→ 10/2005; Orga.→10555	0-N1339	VB [BT]	S
1.4 HDi	04/04-	8HX (DV4TD)	1398	Orga.→10555	0-N1418	VB [DG]	
1.4 HDi	04/04-	8HX (DV4TD)	1398	03/2007 →; Orga.11074→	0-N1502	VB [BT]	S
1.4 HDi	04/04-	8HX (DV4TD)	1398	Orga.10556→11073	0-N1807	VB [DG]	
1.4 HDi	04/04-	8HX (DV4TD)	1398	Orga.10556→11073; *	0-N1924	VB [DG]	
1.4, 1.4 Hybrid	05/03-	KFV (TU3JP)	1360	Abgasnorm: Euro 3 (D3)	0-N1673	VB [BT]	S
1.6	05/03-	NFU (TU5JP4)	1587	Orga.→09884	0-N1455	VB [TE]	
1.6	05/03-	NFU (TU5JP4)	1587	Orga.09883→; *	0-N1673	VB [BT]	S
C3 II							
1.1	11/09-	HFX (TU1JP)	1124	17x100	SK-1353AQ1	BTKW	
1.1, 1.1 BiFuel	11/09-	HFX (TU1A), HFX (TU1JP)	1124	17x100	SK-1353	BTK	
1.4	11/09-	KFT (TU3A), KFV (TU3A)	1360	17x104	SK-1354	BTK	
1.4	11/09-	KFT (TU3A), KFV (TU3A)	1360	17x104	SK-1354AQ1	BTKW	
1.4 HDi 70	11/09-	DV4TD	1398	25.4x144; 01/2010 →	SK-1391	BTK	
1.4 HDi 70	11/09-	DV4TD	1398	25.4x144; 01/2010 →	SK-1391AQ1	BTKW	
1.4 HDi 70	11/09-	DV4C	1398	25.4x139; 06/2011 →; Orga.12630→	SK-1732	BTK	
1.4 HDi 70	11/09-	DV4C	1398	25.4x139; 06/2011 →; Orga.12630→	SK-1732AQ1	BTKW	
1.6 HDi 90	11/09-	9HX (DV6ATED4)	1560	25x137	SK-1424	BTK	
1.6 HDi 90	11/09-	9HX (DV6ATED4)	1560	25x137	SK-1424AQ1	BTKW	
1.6 HDi, 1.6 HDi 110, 1.6 HDi 115	11/09-	9HD (DV6C), 9HP (DV6DTED), 9HR (DV6C)	1560	25x141	SK-1728	BTK	
1.6 HDi, 1.6 HDi 110, 1.6 HDi 115	11/09-	9HD (DV6C), 9HP (DV6DTED), 9HR (DV6C)	1560	25x141	SK-1728AQ1	BTKW	
1.0 VTi 68	08/12-	ZMZ (EB0)	999		0-N2424	TB [DG]	
1.1, 1.1 BiFuel	11/09-	HFX (TU1A), HFX (TU1JP)	1124		0-N1277	TB [TE]	
1.2 VTi 110, 1.2 VTi 82	06/12-	HMZ (EB2F), HNZ (EB2DT)	1199		0-N2424	TB [DG]	
1.4	11/09-	KFT (TU3A), KFV (TU3A)	1360		0-N1277	TB [TE]	
1.4 HDi 70	11/09-	8HR (DV4C), 8HZ (DV4TD)	1398		0-N1062	TB [TE]	
1.4 HDi 70	11/09-	8HZ	1398		0-N1066	TB [DG]	
1.4 HDi 70	11/09-	8HR	1398		0-N2224	TB [TE]	
1.4 HDi 70	11/09-	DV4C	1398		0-N2382	TB [DG]	
1.4 VTi 95	11/09-	8FP (EP3)	1397		0-N1338	TB [TE]	
1.4 VTi 95	11/09-	8FP (EP3)	1397		0-N1456	TB [DG]	
1.6 HDi 115	09/12-	DV6C	1560		0-N2224	TB [TE]	
1.6 HDi 115	09/12-	DV6C	1560		0-N2382	TB [DG]	
1.6 HDi 90	11/09-	9HX (DV6ATED4)	1560		0-N1062	TB [TE]	
1.6 HDi 90	11/09-	9HX (DV6ATED4)	1560		0-N1066	TB [DG]	
1.6 HDi, 1.6 HDi 110	11/09-	9HP (DV6DTED), 9HR (DV6C)	1560		0-N2224	TB [TE]	
1.6 HDi, 1.6 HDi 110	11/09-	9HP (DV6DTED), 9HR (DV6C)	1560		0-N2382	TB [DG]	
1.1, 1.1 BiFuel	11/09-	HFX (TU1A), HFX (TU1JP)	1124		0-N1673	VB [BT]	S
1.4	11/09-	KFT (TU3A), KFV (TU3A)	1360		0-N1673	VB [BT]	S
1.4 HDi 70	11/09-	8HZ	1398	Orga.→10555	0-N1418	VB [DG]	
1.4 HDi 70	11/09-	8HR (DV4C), 8HZ (DV4TD)	1398	für Fahrzeuge ohne Start-Stopp-Funktion	0-N1502	VB [BT]	S
1.4 HDi 70	11/09-	8HZ	1398	Orga.10556→11073	0-N1807	VB [DG]	
1.4 HDi 70	11/09-	8HZ	1398	Orga.10556→11073; *	0-N1924	VB [DG]	
1.4 HDi 70	11/09-	8HR (DV4C), 8HZ (DV4TD)	1398	Rippenanzahl: 6; für Fahrzeuge mit Start-Stopp-Funktion, *	0-N2355	VB [DG]	
1.4 HDi 70	11/09-	8HR	1398	für Fahrzeuge mit Start-Stopp-Funktion	0-N2392	VB [BT]	S
1.4 LPG, 1.4 VTi 95	11/09-	8FN (EP3), 8FP (EP3)	1397	für OE: 11 28 7 598 832, 11 28 7 598 833	0-N2237	VB [DG]	
1.4 VTi 95	11/09-	8FP (EP3)	1397	*, für Fahrzeuge ohne Start-Stopp-Funktion	0-N1673	VB [BT]	S
1.4 VTi 95	11/09-	8FP (EP3)	1397		0-N2055	VB [BT]	S
1.6 HDi 90	11/09-	9HX (DV6ATED4)	1560	Orga.→10555	0-N1418	VB [DG]	
1.6 HDi 90	11/09-	9HX (DV6ATED4)	1560	Orga.10556→11073	0-N1807	VB [DG]	
1.6 HDi 90	11/09-	9HX (DV6ATED4)	1560	Orga.10556→11073; *	0-N1924	VB [DG]	
1.6 HDi, 1.6 HDi 110	11/09-	9HP (DV6DTED), 9HR (DV6C)	1560	Rippenanzahl: 6; für Fahrzeuge mit Start-Stopp-Funktion, *	0-N2355	VB [DG]	
1.6 HDi, 1.6 HDi 110	11/09-	9HP (DV6DTED), 9HR (DV6C)	1560	für Fahrzeuge mit Start-Stopp-Funktion	0-N2392	VB [BT]	S
1.6 HDi, 1.6 HDi 110, 1.6 HDi 115, 1.6 HDi 90	11/09-	9HD (DV6C), 9HP (DV6DTED), 9HR (DV6C), 9HX (DV6ATED4)	1560	für Fahrzeuge ohne Start-Stopp-Funktion	0-N1502	VB [BT]	S
1.6 VTi 120	11/09-	5FS (EP6C)	1598	*	0-N1673	VB [BT]	S
1.6 VTi 120	11/09-	5FS (EP6C)	1598	*	0-N2055	VB [BT]	S
1.6 VTi 120	11/09-	5FS (EP6C)	1598	für OE: 11 28 7 598 832, 11 28 7 598 833	0-N2237	VB [DG]	
C3 Picasso							
1.6 HDi	02/09-	9HX (DV6ATED4), 9HZ (DV6TED4)	1560	25x137	SK-1424	BTK	



CM³



Art. Nr.



C3 Picasso

1.6 HDi	02/09-	9HX (DV6ATED4), 9HZ (DV6TED4)	1560	25x137	SK-1424AQ1	BTKW	
1.6 HDi 110, 1.6 HDi 115, 1.6 HDi 90	05/10-	9HD (DV6C), 9HP (DV6DTEd), 9HR (DV6C)	1560	25x141	SK-1728	BTK	
1.6 HDi 110, 1.6 HDi 115, 1.6 HDi 90	05/10-	9HD (DV6C), 9HP (DV6DTEd), 9HR (DV6C)	1560	25x141	SK-1728AQ1	BTKW	
1.2 THP 110	01/15-	HNZ (EB2DT)	1199		0-N2424	TB [DG]	
1.6 BlueHDi 100, 1.6 HDi 110, 1.6 HDi 115, 1.6 HDi 90	05/10-	9HD (DV6C), 9HP (DV6DTEd), 9HR (DV6C), BHY (DV6FD)	1560		0-N2382	TB [DG]	
1.6 HDi	02/09-	9HX (DV6ATED4), 9HZ (DV6TED4)	1560		0-N1062	TB [TE]	
1.6 HDi	02/09-	9HX (DV6ATED4), 9HZ (DV6TED4)	1560		0-N1066	TB [DG]	
1.6 HDi 110, 1.6 HDi 115, 1.6 HDi 90	05/10-	9HD (DV6C), 9HP (DV6DTEd), 9HR (DV6C)	1560		0-N2224	TB [TE]	
1.4 VTi 95	02/09-	8FN (EP3), 8FP (EP3), 8FS (EP3)	1397	✳	0-N2055	VB [BT]	S
1.4 VTi 95, 1.4 VTi 95 LPG	02/09-	8FN (EP3), 8FN (EP3), 8FP (EP3), 8FS (EP3)	1397	für OE: 11 28 7 598 832, 11 28 7 598 833	0-N2237	VB [DG]	
1.6 HDi	02/09-	9HZ (DV6TED4)	1560		0-N1502	VB [BT]	S
1.6 HDi 110, 1.6 HDi 115	05/10-	9HD (DV6C), 9HR (DV6C)	1560	✳	0-N1502	VB [BT]	S
1.6 HDi 110, 1.6 HDi 115, 1.6 HDi 90	05/10-	9HD (DV6C), 9HP (DV6DTEd), 9HR (DV6C)	1560	Rippenanzahl: 6; für Fahrzeuge mit Start-Stopp-Funktion, ✳	0-N2355	VB [DG]	
1.6 HDi 110, 1.6 HDi 115, 1.6 HDi 90	05/10-	9HD (DV6C), 9HP (DV6DTEd), 9HR (DV6C)	1560	für Fahrzeuge mit Start-Stopp-Funktion	0-N2392	VB [BT]	S
1.6 HDi, 1.6 HDi 90	02/09-	9HP (DV6DTEd), 9HX (DV6ATED4)	1560	für Fahrzeuge ohne Start-Stopp-Funktion	0-N1502	VB [BT]	S
1.6 VTi 120	02/09-	5FS (EP6C), 5FW (EP6)	1598	✳	0-N2055	VB [BT]	S
1.6 VTi 120	02/09-	5FS (EP6C), 5FW (EP6)	1598	für OE: 11 28 7 598 832, 11 28 7 598 833	0-N2237	VB [DG]	

C4 I (LC_)

1.4 16V	11/04-07/11	KFU (ET3J4)	1360	25x135	SK-1598	BTK	
1.4 16V	11/04-07/11	KFU (ET3J4)	1360	25x135	SK-1598AQ1	BTKW	
1.6 16V	11/04-07/11	NFU (TU5JP4)	1587	25.4x134; → 08/2007; Orga.→11253	SK-1615	BTK	
1.6 16V	11/04-07/11	NFU (TU5JP4)	1587	25.4x134	SK-1615AQ1	BTKW	
1.6 16V Bio-Flex	09/07-07/08	NFU (TU5JP4)	1587	25.4x134	SK-1615	BTK	
1.6 16V Bio-Flex	09/07-07/08	NFU (TU5JP4)	1587	25.4x134; → 07/2008	SK-1615AQ1	BTKW	
1.6 HDi	11/04-07/11	9HX (DV6ATED4), 9HY (DV6TED4), 9HZ (DV6TED4)	1560	25x137	SK-1424	BTK	
1.6 HDi	11/04-07/11	9HX (DV6ATED4), 9HY (DV6TED4), 9HZ (DV6TED4)	1560	25x137	SK-1424AQ1	BTKW	
2.0 16V	11/04-07/07	RFN (EW10J4)	1997	25.4x153	SK-1482	BTK	
2.0 16V	11/04-07/07	RFN (EW10J4)	1997	25.4x153	SK-1482AQ1	BTKW	
2.0 16V	11/04-07/08	RFK (EW10J4S)	1997	25x153; 02/2005 →	SK-1596	BTK	
2.0 16V	11/04-07/08	RFK (EW10J4S)	1997	25x153	SK-1596AQ1	BTKW	
2.0 16V	11/04-07/11	RFJ (EW10A)	1997	25x153	SK-1600	BTK	
2.0 16V	11/04-07/11	RFJ (EW10A)	1997	25x153	SK-1600AQ1	BTKW	
2.0 HDi	11/04-07/11	RHF (DW10BTED4), RHR (DW10BTED4)	1997	25.4x116	SK-1594	BTK	
2.0 HDi	11/04-07/11	RHF (DW10BTED4), RHR (DW10BTED4)	1997	25.4x116	SK-1594AQ1	BTKW	
2.0 HDi	07/08-07/11	RHF (DW10BTED4)	1997	25x116	SK-1714	BTK	
1.4 16V	11/04-07/11	KFU (ET3J4)	1360		0-N1338	TB [TE]	
1.4 16V	11/04-07/11	KFU (ET3J4)	1360		0-N1456	TB [DG]	
1.6 16V, 1.6 16V Bio-Flex, 1.6 Flex	11/04-07/11	NFU (TU5JP4)	1587		0-N1359	TB [TE]	
1.6 16V, 1.6 16V Bio-Flex, 1.6 Flex	11/04-07/11	NFU (TU5JP4)	1587		0-N1360	TB [DG]	
1.6 HDi	11/04-07/11	9HX (DV6ATED4), 9HY (DV6TED4), 9HZ (DV6TED4)	1560		0-N1062	TB [TE]	
1.6 HDi	11/04-07/11	9HX (DV6ATED4), 9HY (DV6TED4), 9HZ (DV6TED4)	1560		0-N1066	TB [DG]	
2.0 16V	11/04-07/08	RFK (EW10J4S), RFN (EW10J4)	1997		0-N1057	TB [TE]	
2.0 16V	11/04-07/11	RFJ (EW10A), RFK (EW10J4S), RFN (EW10J4)	1997		0-N1065	TB [DG]	
2.0 16V	11/04-07/11	RFJ (EW10A)	1997		0-N1343	TB [TE]	
2.0 HDi	11/04-07/11	RHF (DW10BTED4), RHR (DW10BTED4)	1997		0-N1334	TB [DG]	
2.0 HDi	07/08-07/11	RHF (DW10BTED4)	1997		0-N2063	TB [TE]	
1.4 16V	11/04-07/11	KFU (ET3J4)	1360	✳	0-N1673	VB [BT]	S
1.6 16V, 1.6 16V Bio-Flex	11/04-07/11	NFU (TU5JP4)	1587	Orga.→12620; ✳, für Fahrzeuge mit Servolenkung	0-N1874	VB [BT]	S
1.6 16V, 1.6 16V Bio-Flex, 1.6 Flex	11/04-07/11	NFU (TU5JP4)	1587	✳, für Fahrzeuge ohne elektrische Servolenkung	0-N1419	VB [DG]	
1.6 16V, 1.6 16V Bio-Flex, 1.6 Flex	11/04-07/11	NFU (TU5JP4)	1587	für Fahrzeuge mit elektrischer Servolenkung, ✳	0-N1673	VB [BT]	S
1.6 HDi	11/04-07/11	9HY (DV6TED4), 9HZ (DV6TED4)	1560	→ 10/2005; Orga.→10555	0-N1339	VB [BT]	S
1.6 HDi	11/04-07/11	DV6ATED4	1560	→ 10/2005; Orga.→10555	0-N1339	VB [BT]	S
1.6 HDi	11/04-07/11	9HX (DV6ATED4), 9HY (DV6TED4), 9HZ (DV6TED4)	1560	Orga.→10555	0-N1418	VB [DG]	
1.6 HDi	11/04-07/11	DV6TED4B	1560		0-N1502	VB [BT]	S
1.6 HDi	11/04-07/11	9HY (DV6TED4), 9HZ (DV6TED4)	1560	03/2007 →; Orga.11074→	0-N1502	VB [BT]	S
1.6 HDi	11/04-07/11	DV6ATED4	1560	03/2007 →; Orga.11074→	0-N1502	VB [BT]	S



CM³



Art. Nr.



ohne Halter

C4 I (LC_)							
1.6 HDi	11/04-07/11	9HX (DV6ATED4), 9HY (DV6TED4), 9HZ (DV6TED4)	1560	Orga.10556→11073	0-N1807	VB [DG]	
1.6 HDi	11/04-07/11	9HX (DV6ATED4), 9HY (DV6TED4), 9HZ (DV6TED4)	1560	Orga.10556→11073; ✱	0-N1924	VB [DG]	
1.6 THP 140, 1.6 THP 150, 1.6 VTi 120	07/08-07/11	5FT (EP6DT), 5FW (EP6), 5FX (EP6DT)	1598	✱	0-N2055	VB [BT]	S
1.6 THP 140, 1.6 THP 150, 1.6 VTi 120	07/08-07/11	5FT (EP6DT), 5FW (EP6), 5FX (EP6DT)	1598	für OE: 11 28 7 598 832, 11 28 7 598 833	0-N2237	VB [DG]	
1.6 THP 140, 1.6 THP 150, 1.6 VTi 120	07/08-07/11	5FT (EP6DT), 5FW (EP6), 5FX (EP6DT)	1598		0-N2263	VB [BT]	
2.0 16V	11/04-07/07	RFN (EW10J4)	1997		0-N1391	VB [BT]	S
2.0 16V	11/04-07/08	RFK (EW10J4S)	1997		0-N1556S	VB [TE]	
2.0 16V	11/04-07/07	RFN (EW10J4)	1997	✱	0-N1651	VB [DG]	S
2.0 16V	11/04-07/11	RFJ (EW10A)	1997		0-N1840	VB [BT]	S
2.0 16V	11/04-07/08	RFK (EW10J4S)	1997	Rippenanzahl: 6; ✱	0-N2094	VB [DG]	
2.0 16V	11/04-07/08	RFK (EW10J4S), RFN (EW10J4)	1997		0-N2276	VB [DG]	
2.0 HDi	11/04-07/11	RHR (DW10BTED4)	1997		0-N1327	VB [BT]	
2.0 HDi	11/04-07/11	RHR (DW10BTED4)	1997	Orga.→11318	0-N2037	VB [BT]	S
2.0 HDi	11/04-07/11	RHR (DW10BTED4)	1997	Orga.11319→	0-N2046	VB [BT]	S

C4 II (B7)							
1.6 HDi 110, 1.6 HDi 115, 1.6 HDi 90	11/09-	9HD (DV6C), 9HR (DV6C), 9HP (DV6DTED), 9HR (DV6C)	1560	25x141	SK-1728	BTK	
1.6 HDi 110, 1.6 HDi 115, 1.6 HDi 90	11/09-	9HD (DV6C), 9HR (DV6C), 9HP (DV6DTED), 9HR (DV6C)	1560	25x141	SK-1728AQ1	BTKW	
2.0 HDi 150	11/09-	RHE (DW10CTED4)	1997	25x116	SK-1714	BTK	
2.0 HDi 150	11/09-	RHE (DW10CTED4)	1997	25x116	SK-1714AQ1	BTKW	
1.2 THP 130	04/14-	HNY (EB2DTS)	1199		0-N2424	TB [DG]	
1.6 BlueHdi 120, 1.6 HDi 110, 1.6 HDi 115, 1.6 HDi 90	11/09-	9HD (DV6C), 9HR (DV6C), 9HP (DV6DTED), 9HR (DV6C), BHZ (DV6FC)	1560		0-N2382	TB [DG]	
1.6 HDi 110, 1.6 HDi 115, 1.6 HDi 90	11/09-	9HD (DV6C), 9HR (DV6C), 9HP (DV6DTED), 9HR (DV6C)	1560		0-N2224	TB [TE]	
2.0 HDi 150	11/09-	RHE (DW10CTED4)	1997		0-N1334	TB [DG]	
2.0 HDi 150	11/09-	RHE (DW10CTED4)	1997		0-N2063	TB [TE]	
1.4 VTi 95	11/09-	8FP (EP3)	1397	✱	0-N2055	VB [BT]	S
1.4 VTi 95	11/09-	8FP (EP3)	1397	für OE: 11 28 7 598 832, 11 28 7 598 833	0-N2237	VB [DG]	
1.6 HDi 110, 1.6 HDi 115, 1.6 HDi 90	11/09-	9HD (DV6C), 9HR (DV6C), 9HP (DV6DTED), 9HR (DV6C)	1560	für Fahrzeuge ohne Start-Stopp-Funktion	0-N1502	VB [BT]	S
1.6 HDi 110, 1.6 HDi 115, 1.6 HDi 90	11/09-	9HD (DV6C), 9HR (DV6C), 9HP (DV6DTED), 9HR (DV6C)	1560	Rippenanzahl: 6; für Fahrzeuge mit Start-Stopp-Funktion, ✱	0-N2355	VB [DG]	
1.6 HDi 110, 1.6 HDi 115, 1.6 HDi 90	11/09-	9HD (DV6C), 9HR (DV6C), 9HP (DV6DTED), 9HR (DV6C)	1560	für Fahrzeuge mit Start-Stopp-Funktion	0-N2392	VB [BT]	S
1.6 THP 155, 1.6 VTi 120, 1.6 VTi 120 LPG	11/09-	5FS (EP6C), 5FV (EP6CDT)	1598	✱	0-N2055	VB [BT]	S
1.6 THP 155, 1.6 VTi 120, 1.6 VTi 120 LPG	11/09-	5FS (EP6C), 5FV (EP6CDT)	1598	für OE: 11 28 7 598 832, 11 28 7 598 833	0-N2237	VB [DG]	
2.0 HDi 150	11/09-	DW10CTED4	1997		0-N2268	VB [BT]	S

C4 Stufenheck							
1.6 16V	07/06-07/11	NFU (TU5JP4)	1587	25.4x134; 04/2007 → 08/2007; Orga.→11253	SK-1615	BTK	
1.6 16V	07/06-07/11	NFU (TU5JP4)	1587	25.4x134; 04/2007 →	SK-1615AQ1	BTKW	
1.6 HDi	07/06-07/11	9HY (DV6TED4), 9HZ (DV6TED4)	1560	25x137	SK-1424	BTK	
1.6 HDi	07/06-07/11	9HY (DV6TED4), 9HZ (DV6TED4)	1560	25x137	SK-1424AQ1	BTKW	
1.6 16V	07/06-07/11	NFU (TU5JP4)	1587		0-N1359	TB [TE]	
1.6 16V	07/06-07/11	NFU (TU5JP4)	1587		0-N1360	TB [DG]	
1.6 HDi	07/06-07/11	9HY (DV6TED4), 9HZ (DV6TED4)	1560		0-N1062	TB [TE]	
1.6 HDi	07/06-07/11	9HY (DV6TED4), 9HZ (DV6TED4)	1560		0-N1066	TB [DG]	
2.0 16V	07/06-	RFJ (EW10A)	1997		0-N1065	TB [DG]	
2.0 16V	07/06-	RFJ (EW10A)	1997		0-N1343	TB [TE]	
1.6 16V	07/06-07/11	NFU (TU5JP4)	1587	✱, für Fahrzeuge ohne elektrische Servolenkung	0-N1419	VB [DG]	
1.6 16V	07/06-07/11	NFU (TU5JP4)	1587	für Fahrzeuge mit elektrischer Servolenkung, ✱	0-N1673	VB [BT]	S
1.6 16V	07/06-07/11	NFU (TU5JP4)	1587	Orga.→12620; ✱, für Fahrzeuge mit Servolenkung	0-N1874	VB [BT]	S
1.6 HDi	07/06-07/11	9HY (DV6TED4), 9HZ (DV6TED4)	1560	Orga.→10555	0-N1418	VB [DG]	
1.6 HDi	07/06-07/11	9HY (DV6TED4), 9HZ (DV6TED4)	1560	03/2007 →; Orga.11074→	0-N1502	VB [BT]	S
1.6 HDi	07/06-07/11	9HY (DV6TED4), 9HZ (DV6TED4)	1560	Orga.10556→11073	0-N1807	VB [DG]	
1.6 HDi	07/06-07/11	9HY (DV6TED4), 9HZ (DV6TED4)	1560	Orga.10556→11073; ✱	0-N1924	VB [DG]	
2.0 16V	07/06-	RFJ (EW10A)	1997		0-N1840	VB [BT]	S

C4 CACTUS							
1.6 HDi 90	09/14-	9HP (DV6DTED)	1560	25x141	SK-1728	BTK	

CM³

Art. Nr.

**C4 CACTUS**

1.6 HDi 90	09/14-	9HP (DV6DTEd)	1560	25x141	SK-1728AQ1	BTKW	
1.2 THP 110, 1.2 VTi 75, 1.2 VTi 82	09/14-	HMU (EB2D), HMZ (EB2F), HNZ (EB2DT)	1199		0-N2424	TB [DG]	
1.6 BlueHdi 100, 1.6 HDi 90	09/14-	9HP (DV6DTEd), BHY (DV6FD)	1560		0-N2382	TB [DG]	
1.6 HDi 90	09/14-	9HP (DV6DTEd)	1560	Rippenanzahl: 6; für Fahrzeuge mit Start-Stopp-Funktion, ⚡	0-N2355	VB [DG]	
1.6 HDi 90	09/14-	9HP (DV6DTEd)	1560	für Fahrzeuge mit Start-Stopp-Funktion	0-N2392	VB [BT]	S

C4 Coupe (LA_)

1.4 16V	11/04-07/11	KFU (ET3J4)	1360	25x135	SK-1598	BTK	
1.4 16V	11/04-07/11	KFU (ET3J4)	1360	25x135	SK-1598AQ1	BTKW	
1.6 16V	11/04-07/11	NFU (TU5JP4)	1587	25.4x134; → 08/2007; Orga.→11253	SK-1615	BTK	
1.6 16V	11/04-07/11	NFU (TU5JP4)	1587	25.4x134	SK-1615AQ1	BTKW	
1.6 HDi	11/04-07/11	9HX (DV6ATED4), 9HY (DV6TED4), 9HZ (DV6TED4)	1560	25x137	SK-1424	BTK	
1.6 HDi	11/04-07/11	9HX (DV6ATED4), 9HY (DV6TED4), 9HZ (DV6TED4)	1560	25x137	SK-1424AQ1	BTKW	
2.0 16V	11/04-07/07	RFN (EW10J4)	1997	25.4x153	SK-1482	BTK	
2.0 16V	11/04-07/07	RFN (EW10J4)	1997	25.4x153	SK-1482AQ1	BTKW	
2.0 16V	11/04-12/10	RFK (EW10J4S)	1997	25x153	SK-1596	BTK	
2.0 16V	11/04-12/10	RFK (EW10J4S)	1997	25x153	SK-1596AQ1	BTKW	
2.0 HDi	11/04-07/11	RHF (DW10BTED4), RHR (DW10BTED4)	1997	25.4x116	SK-1594	BTK	
2.0 HDi	11/04-07/11	RHF (DW10BTED4), RHR (DW10BTED4)	1997	25.4x116	SK-1594AQ1	BTKW	
2.0 HDi	07/08-07/11	RHF (DW10BTED4)	1997	25x116	SK-1714	BTK	
2.0 VTR	10/06-12/07	RFJ (EW10A)	1997	25x153	SK-1600	BTK	
2.0 VTR	10/06-12/07	RFJ (EW10A)	1997	25x153	SK-1600AQ1	BTKW	
1.4 16V	11/04-07/11	KFU (ET3J4)	1360		0-N1338	TB [TE]	
1.4 16V	11/04-07/11	KFU (ET3J4)	1360		0-N1456	TB [DG]	
1.6 16V	11/04-07/11	NFU (TU5JP4)	1587		0-N1359	TB [TE]	
1.6 16V	11/04-07/11	NFU (TU5JP4)	1587		0-N1360	TB [DG]	
1.6 HDi	11/04-07/11	9HX (DV6ATED4), 9HY (DV6TED4), 9HZ (DV6TED4)	1560		0-N1062	TB [TE]	
1.6 HDi	11/04-07/11	9HX (DV6ATED4), 9HY (DV6TED4), 9HZ (DV6TED4)	1560		0-N1066	TB [DG]	
2.0 16V	11/04-12/10	RFK (EW10J4S), RFN (EW10J4)	1997		0-N1057	TB [TE]	
2.0 16V	11/04-12/10	RFK (EW10J4S), RFN (EW10J4)	1997		0-N1065	TB [DG]	
2.0 HDi	11/04-07/11	RHF (DW10BTED4), RHR (DW10BTED4)	1997		0-N1334	TB [DG]	
2.0 HDi	07/08-07/11	RHF (DW10BTED4)	1997		0-N2063	TB [TE]	
1.4 16V	11/04-07/11	KFU (ET3J4)	1360	⚡	0-N1673	VB [BT]	S
1.6 16V	11/04-07/11	NFU (TU5JP4)	1587	⚡, für Fahrzeuge ohne elektrische Servolenkung	0-N1419	VB [DG]	
1.6 16V	11/04-07/11	NFU (TU5JP4)	1587	für Fahrzeuge mit elektrischer Servolenkung, ⚡	0-N1673	VB [BT]	S
1.6 16V	11/04-07/11	NFU (TU5JP4)	1587	Orga.→12620; ⚡, für Fahrzeuge mit Servolenkung	0-N1874	VB [BT]	S
1.6 HDi	11/04-07/11	9HY (DV6TED4), 9HZ (DV6TED4)	1560	→ 10/2005; Orga.→10555	0-N1339	VB [BT]	S
1.6 HDi	11/04-07/11	DV6ATED4	1560	→ 10/2005; Orga.→10555	0-N1339	VB [BT]	S
1.6 HDi	11/04-07/11	9HX (DV6ATED4), 9HY (DV6TED4), 9HZ (DV6TED4)	1560	Orga.→10555	0-N1418	VB [DG]	
1.6 HDi	11/04-07/11	DV6TED4B	1560		0-N1502	VB [BT]	S
1.6 HDi	11/04-07/11	9HY (DV6TED4), 9HZ (DV6TED4)	1560	03/2007 →; Orga.11074→	0-N1502	VB [BT]	S
1.6 HDi	11/04-07/11	DV6ATED4	1560	03/2007 →; Orga.11074→	0-N1502	VB [BT]	S
1.6 HDi	11/04-07/11	9HX (DV6ATED4), 9HY (DV6TED4), 9HZ (DV6TED4)	1560	Orga.10556→11073	0-N1807	VB [DG]	
1.6 HDi	11/04-07/11	9HX (DV6ATED4), 9HY (DV6TED4), 9HZ (DV6TED4)	1560	Orga.10556→11073; ⚡	0-N1924	VB [DG]	
1.6 THP 150, 1.6 VTi 120	07/08-07/11	5FW (EP6), 5FX (EP6DT)	1598	⚡	0-N2055	VB [BT]	S
1.6 THP 150, 1.6 VTi 120	07/08-07/11	5FW (EP6), 5FX (EP6DT)	1598	für OE: 11 28 7 598 832, 11 28 7 598 833	0-N2237	VB [DG]	
1.6 THP 150, 1.6 VTi 120	07/08-07/11	5FW (EP6), 5FX (EP6DT)	1598		0-N2263	VB [BT]	
2.0 16V	11/04-07/07	RFN (EW10J4)	1997		0-N1391	VB [BT]	S
2.0 16V	11/04-12/10	RFK (EW10J4S)	1997		0-N1556S	VB [TE]	
2.0 16V	11/04-07/07	RFN (EW10J4)	1997	⚡	0-N1651	VB [DG]	S
2.0 16V	11/04-12/10	RFK (EW10J4S)	1997	Rippenanzahl: 6; ⚡	0-N2094	VB [DG]	
2.0 16V	11/04-12/10	RFK (EW10J4S), RFN (EW10J4)	1997		0-N2276	VB [DG]	
2.0 HDi	11/04-12/10	RHR (DW10BTED4)	1997		0-N1327	VB [BT]	
2.0 HDi	11/04-12/10	RHR (DW10BTED4)	1997	Orga.→11318	0-N2037	VB [BT]	S
2.0 HDi	11/04-12/10	RHR (DW10BTED4)	1997	Orga.11319→	0-N2046	VB [BT]	S

C4 Picasso I (UD_)

1.6 HDi	02/07-08/13	9HY (DV6TED4), 9HZ (DV6TED4)	1560	25x137	SK-1424	BTK	
---------	-------------	------------------------------	------	--------	---------	-----	--



CM³



Art. Nr.



C4 Picasso I (UD_)							
1.6 HDi	02/07-08/13	9HY (DV6TED4), 9HZ (DV6TED4)	1560	25x137		SK-1424AQ1	BTKW
1.6 HDi 110	09/10-08/13	9HR (DV6C)	1560	25x141		SK-1728	BTK
1.6 HDi 110	09/10-08/13	9HR (DV6C)	1560	25x141		SK-1728AQ1	BTKW
1.8 i 16V	02/07-10/12	6FY (EW7A)	1749	25x153		SK-1600	BTK
1.8 i 16V	02/07-10/12	6FY (EW7A)	1749	25x153		SK-1600AQ1	BTKW
2.0 HDi 138	02/07-08/13	RHJ (DW10BTED4), RHR (DW10BTED4)	1997	25.4x116		SK-1594	BTK
2.0 HDi 138	02/07-08/13	RHJ (DW10BTED4), RHR (DW10BTED4)	1997	25.4x116		SK-1594AQ1	BTKW
2.0 HDi 138, 2.0 HDi 150, 2.0 HDi 165	02/07-08/13	RHE (DW10CTED4), RHH (DW10CTED4), RHJ (DW10BTED4), RHR (DW10BTED4)	1997	25x116		SK-1714	BTK
2.0 HDi 150, 2.0 HDi 165	07/09-08/13	RHE (DW10CTED4), RHH (DW10CTED4)	1997	25x116		SK-1714AQ1	BTKW
2.0 i 16V	02/07-08/13	RFJ (EW10A)	1997	25x153		SK-1600	BTK
2.0 i 16V	02/07-08/13	RFJ (EW10A)	1997	25x153		SK-1600AQ1	BTKW
1.6 e-HDi 110, 1.6 HDi 110	09/10-08/13	9HL (DV6C), 9HR (DV6C)	1560			0-N2224	TB [TE]
1.6 HDi	02/07-08/13	9HY (DV6TED4), 9HZ (DV6TED4)	1560			0-N1062	TB [TE]
1.6 HDi	02/07-08/13	9HY (DV6TED4), 9HZ (DV6TED4)	1560			0-N1066	TB [DG]
1.6 HDi 110	09/10-08/13	9HR (DV6C)	1560			0-N2382	TB [DG]
1.8 i 16V	02/07-10/12	6FY (EW7A)	1749			0-N1065	TB [DG]
1.8 i 16V	02/07-12/11	6FY (EW7A)	1749			0-N1343	TB [TE]
1.8 i 16V	01/09-10/12	6FY	1749			0-N1343	TB [TE]
2.0 HDi 138, 2.0 HDi 150, 2.0 HDi 165	02/07-08/13	RHE (DW10CTED4), RHH (DW10CTED4), RHJ (DW10BTED4), RHR (DW10BTED4)	1997			0-N1334	TB [DG]
2.0 HDi 150, 2.0 HDi 165	07/09-08/13	RHE (DW10CTED4), RHH (DW10CTED4)	1997			0-N2063	TB [TE]
2.0 i 16V	02/07-08/13	RFJ (EW10A)	1997			0-N1065	TB [DG]
2.0 i 16V	02/07-08/13	RFJ (EW10A)	1997			0-N1343	TB [TE]
1.6 16V, 1.6 THP 140, 1.6 THP 155, 1.6 VTi 120	07/08-08/13	5FT (EP6DT), 5FV (EP6CDT), 5FW (EP6), 5FX (EP6DT)	1598	☼		0-N2055	VB [BT] S
1.6 16V, 1.6 THP 140, 1.6 THP 155, 1.6 VTi 120	07/08-08/13	5FT (EP6DT), 5FV (EP6CDT), 5FW (EP6), 5FX (EP6DT)	1598		für OE: 11 28 7 598 832, 11 28 7 598 833	0-N2237	VB [DG]
1.6 HDi	02/07-08/13	9HY (DV6TED4), 9HZ (DV6TED4)	1560		Generator-Ladestrom [A]: 150	0-N1502	VB [BT] S
1.6 HDi	02/07-08/13	9HY (DV6TED4), 9HZ (DV6TED4)	1560			0-N1807	VB [DG]
1.6 HDi	02/07-08/13	9HY (DV6TED4), 9HZ (DV6TED4)	1560		Orga.→10948; ☼	0-N1924	VB [DG]
1.6 HDi	02/07-08/13	9HY (DV6TED4), 9HZ (DV6TED4)	1560			0-N2115	VB [BT] S
1.6 HDi 110	09/10-08/13	9HR (DV6C)	1560		☼, für Fahrzeuge ohne Start-Stopp-Funktion	0-N1502	VB [BT] S
1.6 HDi 110	09/10-08/13	9HR (DV6C)	1560		Rippenanzahl: 6; für Fahrzeuge mit Start-Stopp-Funktion, ☼	0-N2355	VB [DG]
1.6 HDi 110	09/10-08/13	9HR (DV6C)	1560		für Fahrzeuge mit Start-Stopp-Funktion	0-N2392	VB [BT] S
1.6 THP 140, 1.6 VTi 120	07/08-08/13	5FT (EP6DT), 5FW (EP6)	1598			0-N2263	VB [BT]
1.8 i 16V	02/07-12/11	6FY (EW7A)	1749			0-N1840	VB [BT] S
2.0 HDi 138	02/07-08/13	RHJ (DW10BTED4), RHR (DW10BTED4)	1997			0-N1327	VB [BT]
2.0 HDi 138	02/07-08/13	RHJ (DW10BTED4), RHR (DW10BTED4)	1997		Orga.→11318	0-N2037	VB [BT] S
2.0 HDi 138	02/07-08/13	RHJ (DW10BTED4), RHR (DW10BTED4)	1997		Orga.11319→	0-N2046	VB [BT] S
2.0 HDi 150	07/09-08/13	DW10CTED4	1997			0-N2268	VB [BT] S
2.0 HDi 165	09/10-08/13	RHH (DW10CTED4)	1997			0-N2268	VB [BT] S
2.0 i 16V	02/07-08/13	RFJ (EW10A)	1997			0-N1840	VB [BT] S
C4 Picasso II							
1.6 Hdi, 1.6 HDi 90	02/13-	9HC (DV6C), BHX (DV6FC), 9HP (DV6DTEd)	1560	25x141		SK-1728	BTK
1.6 Hdi, 1.6 HDi 90	02/13-	9HC (DV6C), BHX (DV6FC), 9HP (DV6DTEd)	1560	25x141		SK-1728AQ1	BTKW
1.2 THP 130	04/14-	HNY (EB2DTS)	1199			0-N2424	TB [DG]
1.6 BlueHdi 100, 1.6 BlueHdi 120, 1.6 HDi 90	02/13-	9HP (DV6DTEd), BHY (DV6FD), BHZ (DV6FC)	1560			0-N2382	TB [DG]
1.6 Hdi	02/13-	DV6C	1560			0-N2224	TB [TE]
1.6 Hdi	02/13-	DV6C	1560			0-N2382	TB [DG]
1.6 HDi 90	02/13-	9HP (DV6DTEd)	1560			0-N2224	TB [TE]
1.6 HDi 90	02/13-	9HP (DV6DTEd)	1560		Rippenanzahl: 6; für Fahrzeuge mit Start-Stopp-Funktion, ☼	0-N2355	VB [DG]
1.6 HDi 90	02/13-	9HP (DV6DTEd)	1560		für Fahrzeuge mit Start-Stopp-Funktion	0-N2392	VB [BT] S
1.6 Hdi, 1.6 HDi 90	02/13-	9HC (DV6C), BHX (DV6FC), 9HP (DV6DTEd)	1560		für Fahrzeuge ohne Start-Stopp-Funktion	0-N1502	VB [BT] S
1.6 THP, 1.6 VTi 120	02/13-	5FS (EP6C), 5FV (EP6CDT)	1598		für OE: 11 28 7 598 832, 11 28 7 598 833	0-N2237	VB [DG]
C4 Grand Picasso I (UA_)							
1.6 HDi	10/06-	9HY (DV6TED4), 9HZ (DV6TED4)	1560	25x137		SK-1424	BTK
1.6 HDi	10/06-	9HY (DV6TED4), 9HZ (DV6TED4)	1560	25x137		SK-1424AQ1	BTKW
1.6 HDi 110	09/10-	9HL (DV6C), 9HR (DV6C)	1560	25x141		SK-1728	BTK
1.6 HDi 110	09/10-	9HL (DV6C), 9HR (DV6C)	1560	25x141		SK-1728AQ1	BTKW
1.8 i 16V	10/06-	6FY (EW7A)	1749	25x153		SK-1600	BTK



OPTIMAL®

CITROËN



CM³



Art. Nr.



ohne Halter

C4 Grand Picasso I (UA_)

1.8 i 16V	10/06-	6FY (EW7A)	1749	25x153	SK-1600AQ1	BTKW	
2.0 HDi 138	10/06-	RHJ (DW10BTED4), RHR (DW10BTED4)	1997	25.4x116; 02/2007 →	SK-1594	BTK	
2.0 HDi 138	10/06-	RHJ (DW10BTED4), RHR (DW10BTED4)	1997	25.4x116	SK-1594AQ1	BTKW	
2.0 HDi 150, 2.0 HDi 165	07/09-	RHE (DW10CTED4), RHH (DW10CTED4)	1997	25x116	SK-1714	BTK	
2.0 HDi 150, 2.0 HDi 165	07/09-	RHE (DW10CTED4), RHH (DW10CTED4)	1997	25x116	SK-1714AQ1	BTKW	
2.0 i 16V	10/06-	RFJ (EW10A)	1997	25x153; 02/2007 →	SK-1600	BTK	
2.0 i 16V	10/06-	RFJ (EW10A)	1997	25x153	SK-1600AQ1	BTKW	
1.6 e-HDi 110, 1.6 HDi 110	09/10-	9HL (DV6C), 9HL (DV6C), 9HR (DV6C)	1560		0-N2224	TB [TE]	
1.6 HDi	10/06-	9HY (DV6TED4), 9HZ (DV6TED4)	1560		0-N1062	TB [TE]	
1.6 HDi	10/06-	9HY (DV6TED4), 9HZ (DV6TED4)	1560		0-N1066	TB [DG]	
1.6 HDi 110	09/10-	9HL (DV6C), 9HR (DV6C)	1560		0-N2382	TB [DG]	
1.8 i 16V	10/06-	6FY (EW7A)	1749		0-N1065	TB [DG]	
1.8 i 16V	10/06-	6FY (EW7A)	1749		0-N1343	TB [TE]	
2.0 HDi 138, 2.0 HDi 150, 2.0 HDi 165	10/06-	RHE (DW10CTED4), RHH (DW10CTED4), RHJ (DW10BTED4), RHR (DW10BTED4)	1997		0-N1334	TB [DG]	
2.0 HDi 150, 2.0 HDi 165	07/09-	RHE (DW10CTED4), RHH (DW10CTED4)	1997		0-N2063	TB [TE]	
2.0 i 16V	10/06-	RFJ (EW10A)	1997		0-N1065	TB [DG]	
2.0 i 16V	10/06-	RFJ (EW10A)	1997		0-N1343	TB [TE]	
1.6 16V, 1.6 THP 155, 1.6 VTi 120	07/08-	5FT (EP6DT), 5FV (EP6CDT), 5FW (EP6), 5FX (EP6DT)	1598	☼	0-N2055	VB [BT]	S
1.6 16V, 1.6 THP 155, 1.6 VTi 120	07/08-	5FT (EP6DT), 5FV (EP6CDT), 5FW (EP6), 5FX (EP6DT)	1598	für OE: 11 28 7 598 832, 11 28 7 598 833	0-N2237	VB [DG]	
1.6 HDi	10/06-	9HY (DV6TED4), 9HZ (DV6TED4)	1560	Generator-Ladestrom [A]: 150	0-N1502	VB [BT]	S
1.6 HDi	10/06-	9HY (DV6TED4), 9HZ (DV6TED4)	1560		0-N1807	VB [DG]	
1.6 HDi	10/06-	9HY (DV6TED4), 9HZ (DV6TED4)	1560	Orga. → 10948; ☼	0-N1924	VB [DG]	
1.6 HDi	10/06-	9HY (DV6TED4), 9HZ (DV6TED4)	1560		0-N2115	VB [BT]	S
1.6 HDi 110	09/10-	9HL (DV6C), 9HR (DV6C)	1560	☼, für Fahrzeuge ohne Start-Stopp-Funktion	0-N1502	VB [BT]	S
1.6 HDi 110	09/10-	9HL (DV6C), 9HR (DV6C)	1560	Rippenanzahl: 6; für Fahrzeuge mit Start-Stopp-Funktion, ☼	0-N2355	VB [DG]	
1.6 HDi 110	09/10-	9HL (DV6C), 9HR (DV6C)	1560	für Fahrzeuge mit Start-Stopp-Funktion	0-N2392	VB [BT]	S
1.6 VTi 120	07/08-	5FW (EP6)	1598		0-N2263	VB [BT]	
1.8 i 16V	10/06-	6FY (EW7A)	1749		0-N1840	VB [BT]	S
2.0 HDi 138	10/06-	RHJ (DW10BTED4), RHR (DW10BTED4)	1997		0-N1327	VB [BT]	
2.0 HDi 138	10/06-	RHJ (DW10BTED4), RHR (DW10BTED4)	1997	Orga. → 11318	0-N2037	VB [BT]	S
2.0 HDi 138	10/06-	RHJ (DW10BTED4), RHR (DW10BTED4)	1997	Orga. 11319 →	0-N2046	VB [BT]	S
2.0 HDi 150	07/09-	DW10CTED4	1997		0-N2268	VB [BT]	S
2.0 HDi 165	09/10-	RHH (DW10CTED4)	1997		0-N2268	VB [BT]	S
2.0 i 16V	10/06-	RFJ (EW10A)	1997		0-N1840	VB [BT]	S

C4 Grand Picasso II

1.6 HDi 115, 1.6 HDi 90	09/13-	9HC (DV6C), BHX (DV6FC), 9HP (DV6DTEd)	1560	25x141	SK-1728	BTK	
1.6 HDi 115, 1.6 HDi 90	09/13-	9HC (DV6C), BHX (DV6FC), 9HP (DV6DTEd)	1560	25x141	SK-1728AQ1	BTKW	
1.2 THP 130	04/14-	HNY (EB2DTS)	1199		0-N2424	TB [DG]	
1.6 BlueHDi 120, 1.6 HDi 115, 1.6 HDi 90	09/13-	9HC (DV6C), BHX (DV6FC), 9HP (DV6DTEd), BHZ (DV6FC)	1560		0-N2382	TB [DG]	
1.6 HDi 90	09/13-	9HP (DV6DTEd)	1560		0-N2224	TB [TE]	
1.6 HDi 115, 1.6 HDi 90	09/13-	9HC (DV6C), BHX (DV6FC), 9HP (DV6DTEd)	1560	für Fahrzeuge ohne Start-Stopp-Funktion	0-N1502	VB [BT]	S
1.6 HDi 90	09/13-	9HP (DV6DTEd)	1560	Rippenanzahl: 6; für Fahrzeuge mit Start-Stopp-Funktion, ☼	0-N2355	VB [DG]	
1.6 HDi 90	09/13-	9HP (DV6DTEd)	1560	für Fahrzeuge mit Start-Stopp-Funktion	0-N2392	VB [BT]	S

C4 AIRCROSS

Hdi 115, Hdi 115 AWC	04/12-	9HL (DV6C)	1560	25x141	SK-1728	BTK	
Hdi 115, Hdi 115 AWC	04/12-	9HL (DV6C)	1560	25x141	SK-1728AQ1	BTKW	
Hdi 115, Hdi 115 AWC	04/12-	9HL (DV6C)	1560		0-N2224	TB [TE]	
Hdi 115, Hdi 115 AWC	04/12-	9HL (DV6C)	1560		0-N2382	TB [DG]	
2.0, 2.0 AWC	04/12-	4B11	1998		0-N2048	VB [DG]	
2.0, 2.0 AWC	04/12-	4B11	1998	Orga. 13115 →	0-N2294	VB [DG]	
2.0, 2.0 AWC	04/12-	4B11	1998		0-N2354	VB [DG]	
Hdi 115, Hdi 115 AWC	04/12-	9HL (DV6C)	1560		0-N1502	VB [BT]	S

C5 I (DC_)

1.8 16V	03/01-08/04	6FZ (EW7J4)	1749	25.4x153	SK-1482	BTK	
1.8 16V	03/01-08/04	6FZ (EW7J4)	1749	25.4x153	SK-1482AQ1	BTKW	
2.0 16V	03/01-08/04	RFN (EW10J4)	1997	25.4x153	SK-1482	BTK	
2.0 16V	03/01-08/04	RFN (EW10J4)	1997	25.4x153	SK-1482AQ1	BTKW	
2.0 16V HPI	03/01-08/04	RLZ (EW10D)	1997	25.4x143	SK-1393	BTK	

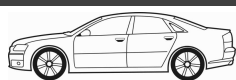

CM³



Art. Nr.



C5 I (DC_)							
2.0 HDi	03/01-08/04	RHS (DW10ATED), RHZ (DW10ATED), RHY (DW10TD), RHZ (DW10ATED)	1997	25x141; mit Zubehör	SK-1085	BTK	
2.0 HDi	03/01-08/04	RHS (DW10ATED), RHZ (DW10ATED), RHY (DW10TD), RHZ (DW10ATED)	1997	25.4x141; mit Zubehör	SK-1085AQ1	BTKW	
2.2 HDi	03/01-08/04	4HX (DW12TED4/FAP)	2179	25.4x146; → 04/2004; Orga.→10010	SK-1394	BTK	
2.2 HDi	03/01-08/04	4HX (DW12TED4/FAP)	2179	25.4x146; → 04/2004; Orga.→10010	SK-1394AQ1	BTKW	
2.2 HDi	03/01-08/04	4HX (DW12TED4/FAP)	2179	25.4x146; 04/2004 →; Orga.10011→; Baumuster: 4HX	SK-1614	BTK	
2.2 HDi	03/01-08/04	4HX (DW12TED4/FAP)	2179	25.4x146; 04/2004 →; Orga.10011→	SK-1614AQ1	BTKW	
3.0 V6	03/01-08/04	XFX (ES9J4S)	2946	32x259	SK-1483	BTK	
3.0 V6	03/01-08/04	XFX (ES9J4S)	2946	32x259	SK-1483AQ1	BTKW	
1.8 16V	03/01-08/04	6FZ (EW7J4)	1749		0-N1057	TB [TE]	
1.8 16V	03/01-08/04	6FZ (EW7J4)	1749		0-N1065	TB [DG]	
2.0 16V	03/01-08/04	RFN (EW10J4)	1997		0-N1057	TB [TE]	
2.0 16V , 2.0 16V HPI	03/01-08/04	RFN (EW10J4), RLZ (EW10D)	1997		0-N1065	TB [DG]	
2.0 16V HPI	03/01-08/04	RLZ (EW10D)	1997		0-N1060	TB [TE]	
2.0 HDi	03/01-08/04	RHS (DW10ATED), RHZ (DW10ATED), RHY (DW10TD), RHZ (DW10ATED)	1997	Orga.→08756	0-N118P	TB [TE]	
2.0 HDi	03/01-08/04	RHS (DW10ATED), RHZ (DW10ATED), RHY (DW10TD), RHZ (DW10ATED)	1997	Orga.→08756	0-N119P	TB [DG]	
2.0 HDi	03/01-08/04	RHS (DW10ATED), RHZ (DW10ATED), RHY (DW10TD), RHZ (DW10ATED)	1997	Orga.08757→	0-N1381	TB [DG]	
2.2 HDi	03/01-08/04	4HX (DW12TED4/FAP)	2179	Orga.→10010	0-N118P	TB [TE]	
2.2 HDi	03/01-08/04	4HX (DW12TED4/FAP)	2179	Orga.→10010	0-N119P	TB [DG]	
2.2 HDi	03/01-08/04	4HX (DW12TED4/FAP)	2179	Orga.10011→	0-N1357	TB [TE]	
2.2 HDi	03/01-08/04	4HX (DW12TED4/FAP)	2179	Orga.10011→	0-N1358	TB [DG]	
3.0 V6	03/01-08/04	XFX (ES9J4S)	2946		0-N1056	TB [TE]	
3.0 V6	03/01-08/04	XFX (ES9J4S)	2946		0-N170	TB [DG]	
3.0 V6	03/01-08/04	XFX (ES9J4S)	2946		0-N171	TB [DG]	
1.8 16V	03/01-08/04	6FZ (EW7J4)	1749		0-N1391	VB [BT]	S
1.8 16V	03/01-08/04	6FZ (EW7J4)	1749		0-N1416	VB [DG]	
2.0 16V , 2.0 16V HPI	03/01-08/04	RFN (EW10J4), RLZ (EW10D)	1997		0-N1391	VB [BT]	S
2.0 16V , 2.0 16V HPI	03/01-08/04	RFN (EW10J4), RLZ (EW10D)	1997		0-N1416	VB [DG]	
2.0 HDi	03/01-08/04	RHS (DW10ATED), RHZ (DW10ATED), RHY (DW10TD), RHZ (DW10ATED)	1997		0-N1320	VB [TE]	
2.0 HDi	03/01-08/04	RHS (DW10ATED), RHZ (DW10ATED), RHY (DW10TD), RHZ (DW10ATED)	1997		0-N1493	VB [BT]	S
2.0 HDi	03/01-08/04	RHS (DW10ATED), RHZ (DW10ATED), RHY (DW10TD), RHZ (DW10ATED)	1997	☞	0-N151	VB [DG]	
2.0 HDi	03/01-08/04	RHS (DW10ATED), RHZ (DW10ATED), RHY (DW10TD), RHZ (DW10ATED)	1997	☞	0-N1748	VB [BT]	
2.2 HDi	03/01-08/04	4HX (DW12TED4/FAP)	2179		0-N1413	VB [DG]	
2.2 HDi	03/01-08/04	4HX (DW12TED4/FAP)	2179		0-N1493	VB [BT]	S
3.0 V6	03/01-08/04	XFX (ES9J4S)	2946		0-N1449	VB [TE]	
3.0 V6	03/01-08/04	XFX (ES9J4S)	2946		0-N1473	VB [BT]	S
3.0 V6	03/01-08/04	XFX (ES9J4S)	2946		0-N1757	VB [VD]	
C5 I Break (DE_)							
1.8 16V	06/01-08/04	6FZ (EW7J4)	1749	25.4x153	SK-1482	BTK	
1.8 16V	06/01-08/04	6FZ (EW7J4)	1749	25.4x153	SK-1482AQ1	BTKW	
2.0 16V	06/01-08/04	RFN (EW10J4)	1997	25.4x153	SK-1482	BTK	
2.0 16V	06/01-08/04	RFN (EW10J4)	1997	25.4x153	SK-1482AQ1	BTKW	
2.0 16V HPI	06/01-08/04	RLZ (EW10D)	1997	25.4x143	SK-1393	BTK	
2.0 HDi	06/01-08/04	RHS (DW10ATED), RHZ (DW10ATED), RHY (DW10TD), RHZ (DW10ATED)	1997	25x141; mit Zubehör	SK-1085	BTK	
2.0 HDi	06/01-08/04	RHY (DW10TD), RHZ (DW10ATED)	1997	25.4x141; mit Zubehör	SK-1085AQ1	BTKW	
2.0 HDi	06/01-08/04	RHS (DW10ATED), RHZ (DW10ATED)	1997	25.4x141; Orga.→08756; mit Zubehör	SK-1085AQ1	BTKW	
2.2 HDi	06/01-08/04	4HX (DW12TED4/FAP)	2179	25.4x146; → 04/2004; Orga.→10010	SK-1394	BTK	
2.2 HDi	06/01-08/04	4HX (DW12TED4/FAP)	2179	25.4x146; → 04/2004; Orga.→10010	SK-1394AQ1	BTKW	
2.2 HDi	06/01-08/04	4HX (DW12TED4/FAP)	2179	25.4x146; 04/2004 →; Orga.10011→; Baumuster: 4HX	SK-1614	BTK	
2.2 HDi	06/01-08/04	4HX (DW12TED4/FAP)	2179	25.4x146; 04/2004 →; Orga.10011→	SK-1614AQ1	BTKW	
3.0 Carlsson, 3.0 V6	06/01-08/04	XFX (ES9J4S)	2946	32x259	SK-1483	BTK	
3.0 Carlsson, 3.0 V6	06/01-08/04	XFX (ES9J4S)	2946	32x259	SK-1483AQ1	BTKW	
1.8 16V	06/01-08/04	6FZ (EW7J4)	1749		0-N1057	TB [TE]	
1.8 16V	06/01-08/04	6FZ (EW7J4)	1749		0-N1065	TB [DG]	
2.0 16V	06/01-08/04	RFN (EW10J4)	1997		0-N1057	TB [TE]	
2.0 16V , 2.0 16V HPI	06/01-08/04	RFN (EW10J4), RLZ (EW10D)	1997		0-N1065	TB [DG]	
2.0 16V HPI	06/01-08/04	RLZ (EW10D)	1997		0-N1060	TB [TE]	



CM³



Art. Nr.



ohne Halter

C5 I Break (DE_)

2.0 HDi	06/01-08/04	RHS (DW10ATED), RHZ (DW10ATED), RHY (DW10TD), RHZ (DW10ATED)	1997	Orga.→08756	0-N118P	TB [TE]	
2.0 HDi	06/01-08/04	RHS (DW10ATED), RHZ (DW10ATED), RHY (DW10TD), RHZ (DW10ATED)	1997	Orga.→08756	0-N119P	TB [DG]	
2.0 HDi	06/01-08/04	RHS (DW10ATED), RHZ (DW10ATED), RHY (DW10TD), RHZ (DW10ATED)	1997	Orga.08757→	0-N1381	TB [DG]	
2.2 HDi	06/01-08/04	4HX (DW12TED4/FAP)	2179	Orga.→10010	0-N118P	TB [TE]	
2.2 HDi	06/01-08/04	4HX (DW12TED4/FAP)	2179	Orga.→10010	0-N119P	TB [DG]	
2.2 HDi	06/01-08/04	4HX (DW12TED4/FAP)	2179	Orga.10011→	0-N1357	TB [TE]	
2.2 HDi	06/01-08/04	4HX (DW12TED4/FAP)	2179	Orga.10011→	0-N1358	TB [DG]	
3.0 V6	06/01-08/04	XFJ (ES9J4S)	2946		0-N1056	TB [TE]	
3.0 V6	06/01-08/04	XFJ (ES9J4S)	2946		0-N170	TB [DG]	
3.0 V6	06/01-08/04	XFJ (ES9J4S)	2946		0-N171	TB [DG]	
1.8 16V	06/01-08/04	6FZ (EW7J4)	1749		0-N1391	VB [BT]	S
1.8 16V	06/01-08/04	6FZ (EW7J4)	1749		0-N1416	VB [DG]	
2.0 16V , 2.0 16V HPI	06/01-08/04	RFN (EW10J4), RLZ (EW10D)	1997		0-N1391	VB [BT]	S
2.0 16V , 2.0 16V HPI	06/01-08/04	RFN (EW10J4), RLZ (EW10D)	1997		0-N1416	VB [DG]	
2.0 HDi	06/01-08/04	RHS (DW10ATED), RHZ (DW10ATED), RHY (DW10TD), RHZ (DW10ATED)	1997		0-N1320	VB [TE]	
2.0 HDi	06/01-08/04	RHS (DW10ATED), RHZ (DW10ATED), RHY (DW10TD), RHZ (DW10ATED)	1997		0-N1493	VB [BT]	S
2.0 HDi	06/01-08/04	RHS (DW10ATED), RHZ (DW10ATED), RHY (DW10TD), RHZ (DW10ATED)	1997	✘	0-N151	VB [DG]	
2.0 HDi	06/01-08/04	RHS (DW10ATED), RHZ (DW10ATED), RHY (DW10TD), RHZ (DW10ATED)	1997	✘	0-N1748	VB [BT]	
2.2 HDi	06/01-08/04	4HX (DW12TED4/FAP)	2179		0-N1413	VB [DG]	
2.2 HDi	06/01-08/04	4HX (DW12TED4/FAP)	2179		0-N1493	VB [BT]	S
3.0 V6	06/01-08/04	XFJ (ES9J4S)	2946		0-N1449	VB [TE]	
3.0 V6	06/01-08/04	XFJ (ES9J4S)	2946		0-N1473	VB [BT]	S
3.0 V6	06/01-08/04	XFJ (ES9J4S)	2946		0-N1757	VB [VD]	

C5 II (RC_)

1.6 HDi	09/04-	9HY (DV6TED4), 9HZ (DV6TED4)	1560	25x137	SK-1424	BTK	
1.6 HDi	09/04-	9HY (DV6TED4), 9HZ (DV6TED4)	1560	25x137	SK-1424AQ1	BTKW	
1.8 16V	09/04-	6FZ (EW7J4)	1749	25.4x153	SK-1482	BTK	
1.8 16V	09/04-	6FZ (EW7J4)	1749	25.4x153	SK-1482AQ1	BTKW	
1.8 16V	09/05-	6FY (EW7A)	1749	25x153	SK-1600	BTK	
1.8 16V	09/05-	6FY (EW7A)	1749	25x153	SK-1600AQ1	BTKW	
2.0 16V	09/04-	RFJ (EW10A)	1997	25x153	SK-1600	BTK	
2.0 16V	09/04-	RFJ (EW10A)	1997	25x153	SK-1600AQ1	BTKW	
2.0 HDi	09/04-	RHR (DW10BTED4)	1997	25.4x116	SK-1594	BTK	
2.0 HDi	09/04-	RHR (DW10BTED4)	1997	25.4x116	SK-1594AQ1	BTKW	
2.2 HDi	09/04-	4HX (DW12TED4/FAP)	2179	25.4x146; Baumuster: 4HX	SK-1614	BTK	
2.2 HDi	09/04-	4HX (DW12TED4/FAP)	2179	25.4x146	SK-1614AQ1	BTKW	
2.2 HDi	04/06-	4HT (DW12BTED4)	2179	25.4x118; → 01/2008	SK-1588	BTK	
2.2 HDi	04/06-	4HT (DW12BTED4)	2179	25.4x118	SK-1692	BTK	
2.2 HDi	04/06-	4HT (DW12BTED4)	2179	25.4x118	SK-1692AQ1	BTKW	
3.0 Carlsson HP, 3.0 V6	09/04-	XFU (ES9A), XFJ (ES9A), XFX (ES9J4S)	2946	32x259	SK-1483	BTK	
3.0 V6	09/04-	XFU (ES9A), XFJ (ES9A), XFX (ES9J4S)	2946	32x259	SK-1483AQ1	BTKW	
1.6 HDi	09/04-	9HY (DV6TED4), 9HZ (DV6TED4)	1560		0-N1062	TB [TE]	
1.6 HDi	09/04-	9HY (DV6TED4), 9HZ (DV6TED4)	1560		0-N1066	TB [DG]	
1.8 16V	09/04-	6FZ (EW7J4)	1749		0-N1057	TB [TE]	
1.8 16V	09/04-	6FY (EW7A), 6FZ (EW7J4)	1749		0-N1065	TB [DG]	
1.8 16V	09/05-	6FY (EW7A)	1749		0-N1343	TB [TE]	
2.0 16V	09/04-	RFJ (EW10A)	1997		0-N1065	TB [DG]	
2.0 16V	09/04-	RFJ (EW10A)	1997		0-N1343	TB [TE]	
2.0 HDi	09/04-	RHR (DW10BTED4)	1997		0-N1334	TB [DG]	
2.2 HDi	09/04-	4HX (DW12TED4/FAP)	2179	Orga.→10010	0-N118P	TB [TE]	
2.2 HDi	09/04-	4HX (DW12TED4/FAP)	2179	Orga.→10010	0-N119P	TB [DG]	
2.2 HDi	09/04-	4HX (DW12TED4/FAP)	2179	Orga.10011→	0-N1357	TB [TE]	
2.2 HDi	09/04-	4HX (DW12TED4/FAP)	2179	Orga.10011→	0-N1358	TB [DG]	
2.2 HDi	04/06-	4HT (DW12BTED4)	2179		0-N1334	TB [DG]	
2.2 HDi	04/06-	4HT (DW12BTED4)	2179		0-N2018	TB [BT]	
3.0 V6	09/04-	XFU (ES9A), XFJ (ES9A), XFX (ES9J4S)	2946		0-N1056	TB [TE]	
3.0 V6	09/04-	XFU (ES9A), XFJ (ES9A), XFX (ES9J4S)	2946		0-N170	TB [DG]	
3.0 V6	09/04-	XFU (ES9A), XFJ (ES9A), XFX (ES9J4S)	2946		0-N171	TB [DG]	
1.6 HDi	09/04-	9HY (DV6TED4), 9HZ (DV6TED4)	1560		0-N1418	VB [DG]	
1.6 HDi	09/04-	9HY (DV6TED4), 9HZ (DV6TED4)	1560		0-N1636	VB [BT]	S



CM³



Art. Nr.



C5 II (RC_)							
1.8 16V	09/04-	6FZ (EW7J4)	1749			0-N1391	VB [BT] S
1.8 16V	09/04-	6FZ (EW7J4)	1749			0-N1416	VB [DG]
1.8 16V	09/05-	6FY (EW7A)	1749			0-N1840	VB [BT] S
2.0 16V	09/04-	RFJ (EW10A)	1997			0-N1840	VB [BT] S
2.0 HDi	09/04-	RHR (DW10BTED4)	1997			0-N1327	VB [BT]
2.0 HDi	09/04-	RHR (DW10BTED4)	1997	Orga.→11193		0-N2037	VB [BT] S
2.0 HDi	09/04-	RHR (DW10BTED4)	1997	Orga.11194→		0-N2046	VB [BT] S
2.2 HDi	09/04-	4HX (DW12TED4/FAP)	2179			0-N1413	VB [DG]
2.2 HDi	09/04-	4HX (DW12TED4/FAP)	2179			0-N1493	VB [BT] S
2.2 HDi	04/06-	4HT (DW12BTED4)	2179			0-N2042	VB [BT] S
3.0 V6	09/04-	XFU (ES9A), XFU (ES9A), XFX (ES9J4S)	2946	→ 02/2008		0-N1449	VB [TE]
3.0 V6	09/04-	XFU (ES9A), XFU (ES9A), XFX (ES9J4S)	2946			0-N1473	VB [BT] S
3.0 V6	09/04-	XFU (ES9A), XFU (ES9A), XFX (ES9J4S)	2946			0-N1757	VB [VD]
3.0 V6	09/04-	XFU (ES9A), XFU (ES9A), XFX (ES9J4S)	2946	02/2008 →		0-N1803	VB [DG]
C5 II Break (RE_)							
1.6 HDi	09/04-	9HY (DV6TED4), 9HZ (DV6TED4)	1560	25x137		SK-1424	BTK
1.6 HDi	09/04-	9HY (DV6TED4), 9HZ (DV6TED4)	1560	25x137		SK-1424AQ1	BTKW
1.8 16V	09/04-	6FZ (EW7J4)	1749	25.4x153		SK-1482	BTK
1.8 16V	09/04-	6FZ (EW7J4)	1749	25.4x153		SK-1482AQ1	BTKW
1.8 16V	09/05-	6FY (EW7A)	1749	25x153		SK-1600	BTK
1.8 16V	09/05-	6FY (EW7A)	1749	25x153		SK-1600AQ1	BTKW
2.0 16V	09/04-	RFJ (EW10A)	1997	25x153		SK-1600	BTK
2.0 16V	09/04-	RFJ (EW10A)	1997	25x153		SK-1600AQ1	BTKW
2.0 HDi	09/04-	RHR (DW10BTED4)	1997	25.4x116		SK-1594	BTK
2.0 HDi	09/04-	RHR (DW10BTED4)	1997	25.4x116		SK-1594AQ1	BTKW
2.2 HDi	09/04-	4HX (DW12TED4/FAP)	2179	25.4x146; Baumuster: 4HX		SK-1614	BTK
2.2 HDi	09/04-	4HX (DW12TED4/FAP)	2179	25.4x146		SK-1614AQ1	BTKW
2.2 HDi	04/06-	4HT (DW12BTED4)	2179	25.4x118; → 01/2008		SK-1588	BTK
2.2 HDi	04/06-	4HT (DW12BTED4)	2179	25.4x118		SK-1692	BTK
2.2 HDi	04/06-	4HP (DW12BTED4), 4HR (DW12BTED4), 4HT (DW12BTED4)	2179	25.4x118		SK-1692AQ1	BTKW
3.0, 3.0 V6	09/04-04/07	XFU (ES9A), XFU (ES9A), XFX (ES9J4S)	2946	32x259		SK-1483	BTK
3.0, 3.0 V6	09/04-04/07	XFU (ES9A), XFU (ES9A), XFX (ES9J4S)	2946	32x259		SK-1483AQ1	BTKW
1.6 HDi	09/04-	9HY (DV6TED4), 9HZ (DV6TED4)	1560			0-N1062	TB [TE]
1.6 HDi	09/04-	9HY (DV6TED4), 9HZ (DV6TED4)	1560			0-N1066	TB [DG]
1.8 16V	09/04-	6FZ (EW7J4)	1749			0-N1057	TB [TE]
1.8 16V	09/04-	6FY (EW7A), 6FZ (EW7J4)	1749			0-N1065	TB [DG]
1.8 16V	09/05-	6FY (EW7A)	1749			0-N1343	TB [TE]
2.0 16V	09/04-	RFJ (EW10A)	1997			0-N1065	TB [DG]
2.0 16V	09/04-	RFJ (EW10A)	1997			0-N1343	TB [TE]
2.0 HDi	09/04-	RHR (DW10BTED4)	1997			0-N1334	TB [DG]
2.2 HDi	09/04-	4HX (DW12TED4/FAP)	2179	Orga.→10010		0-N118P	TB [TE]
2.2 HDi	09/04-	4HX (DW12TED4/FAP)	2179	Orga.→10010		0-N119P	TB [DG]
2.2 HDi	09/04-	4HX (DW12TED4/FAP)	2179	Orga.10011→		0-N1357	TB [TE]
2.2 HDi	09/04-	4HX (DW12TED4/FAP)	2179	Orga.10011→		0-N1358	TB [DG]
2.2 HDi	04/06-	4HT (DW12BTED4)	2179			0-N1334	TB [DG]
2.2 HDi	04/06-	4HT (DW12BTED4)	2179			0-N2018	TB [BT]
3.0 V6	09/04-	XFU (ES9A), XFX (ES9A)	2946			0-N1056	TB [TE]
3.0 V6	09/04-	XFU (ES9A), XFX (ES9A)	2946			0-N170	TB [DG]
3.0 V6	09/04-	XFU (ES9A), XFX (ES9A)	2946			0-N171	TB [DG]
1.6 HDi	09/04-	9HY (DV6TED4), 9HZ (DV6TED4)	1560			0-N1418	VB [DG]
1.6 HDi	09/04-	9HY (DV6TED4), 9HZ (DV6TED4)	1560			0-N1636	VB [BT] S
1.8 16V	09/04-	6FZ (EW7J4)	1749			0-N1391	VB [BT] S
1.8 16V	09/04-	6FZ (EW7J4)	1749			0-N1416	VB [DG]
1.8 16V	09/05-	6FY (EW7A)	1749			0-N1840	VB [BT] S
2.0 16V	09/04-	RFJ (EW10A)	1997			0-N1840	VB [BT] S
2.0 HDi	09/04-	RHR (DW10BTED4)	1997			0-N1327	VB [BT]
2.0 HDi	09/04-	RHR (DW10BTED4)	1997	Orga.→11193		0-N2037	VB [BT] S
2.0 HDi	09/04-	RHR (DW10BTED4)	1997	Orga.11194→		0-N2046	VB [BT] S
2.2 HDi	09/04-	4HX (DW12TED4/FAP)	2179			0-N1413	VB [DG]
2.2 HDi	09/04-	4HX (DW12TED4/FAP)	2179			0-N1493	VB [BT] S
2.2 HDi	04/06-	4HT (DW12BTED4)	2179	→ 03/2008		0-N2042	VB [BT] S
3.0 V6	09/04-	XFU (ES9A), XFX (ES9A)	2946	→ 02/2008		0-N1449	VB [TE]
3.0 V6	09/04-	XFU (ES9A), XFX (ES9A)	2946			0-N1473	VB [BT] S



CM³



Art. Nr.



C5 II Break (RE_)

3.0 V6	09/04-	XFU (ES9A), XFV (ES9A)	2946		0-N1757	VB [VD]
3.0 V6	09/04-	XFU (ES9A), XFV (ES9A)	2946	02/2008 →	0-N1803	VB [DG]

C5 III (RD_)

1.6 HDi	02/08-	9HZ (DV6TED4)	1560	25x137	SK-1424	BTK
1.6 HDi	02/08-	9HZ (DV6TED4)	1560	25x137	SK-1424AQ1	BTKW
1.6 HDi 110, 1.6 HDi 115	07/10-	9HL (DV6C), 9HR (DV6C)	1560	25x141	SK-1728	BTK
1.6 HDi 110, 1.6 HDi 115	07/10-	9HL (DV6C), 9HR (DV6C)	1560	25x141	SK-1728AQ1	BTKW
1.8 16V	02/08-	6FY (EW7A)	1749	25x153	SK-1600	BTK
1.8 16V	02/08-	6FY (EW7A)	1749	25x153	SK-1600AQ1	BTKW
2.0 16V, 2.0 16V BioFlex	02/08-	RFJ (EW10A)	1997	25x153	SK-1600	BTK
2.0 16V, 2.0 16V BioFlex	02/08-	RFJ (EW10A)	1997	25x153	SK-1600AQ1	BTKW
2.0 HDi 165	04/09-	RHH (DW10CTED4)	1997	25x116	SK-1714AQ1	BTKW
2.0 HDi, 2.0 HDi 140	02/08-	RHF (DW10BTED4), RHF (DW10BTED4), RHR (DW10BTED4)	1997	25.4x116	SK-1594	BTK
2.0 HDi, 2.0 HDi 140	02/08-	RHF (DW10BTED4), RHF (DW10BTED4), RHR (DW10BTED4)	1997	25.4x116	SK-1594AQ1	BTKW
2.0 HDi, 2.0 HDi 165	02/08-	RHF (DW10BTED4), RHR (DW10BTED4), RHH (DW10CTED4)	1997	25x116	SK-1714	BTK
2.2 HDi, 2.2 HDi 200	02/08-	4HL (DW12C), 4HT (DW12BTED4)	2179	25.4x118	SK-1692	BTK
2.2 HDi, 2.2 HDi 200	02/08-	4HL (DW12C), 4HT (DW12BTED4)	2179	25.4x118	SK-1692AQ1	BTKW
2.7 HDi	02/08-	DT17ED4	2720	29x195; 20x85	SK-1675	BTK
2.7 HDi	02/08-	DT17ED4	2720	29x195	SK-1742	BTK
3.0 HDi 240	04/09-	DT20C	2992	29x195	SK-1742	BTK
3.0 V6	02/08-	XFU (ES9A)	2946	32x259	SK-1483	BTK
3.0 V6	02/08-	XFU (ES9A)	2946	32x259	SK-1483AQ1	BTKW
1.6 HDi	02/08-	9HZ (DV6TED4)	1560		0-N1062	TB [TE]
1.6 HDi	02/08-	9HZ (DV6TED4)	1560		0-N1066	TB [DG]
1.6 HDi 110, 1.6 HDi 115	07/10-	9HL (DV6C), 9HR (DV6C)	1560		0-N2224	TB [TE]
1.6 HDi 110, 1.6 HDi 115	07/10-	9HL (DV6C), 9HR (DV6C)	1560		0-N2382	TB [DG]
1.8 16V	02/08-	6FY (EW7A)	1749		0-N1065	TB [DG]
1.8 16V	02/08-	6FY (EW7A)	1749		0-N1343	TB [TE]
2.0 16V, 2.0 16V BioFlex	02/08-	RFJ (EW10A)	1997		0-N1065	TB [DG]
2.0 16V, 2.0 16V BioFlex	02/08-	RFJ (EW10A)	1997		0-N1343	TB [TE]
2.0 HDi 140, 2.0 HDi 165	04/09-	RHF (DW10BTED4), RHH (DW10CTED4)	1997		0-N2063	TB [TE]
2.0 HDi, 2.0 HDi 140, 2.0 HDi 165	02/08-	RHF (DW10BTED4), RHF (DW10BTED4), RHR (DW10BTED4), RHH (DW10CTED4)	1997		0-N1334	TB [DG]
2.2 HDi, 2.2 HDi 200	02/08-	4HL (DW12C), 4HT (DW12BTED4)	2179		0-N1334	TB [DG]
2.2 HDi, 2.2 HDi 200	02/08-	4HL (DW12C), 4HT (DW12BTED4)	2179		0-N2018	TB [BT]
2.7 HDi	02/08-	DT17ED4	2720		0-N1613	TB [TE]
2.7 HDi	02/08-	DT17ED4	2720		0-N1614	TB [TE]
2.7 HDi	02/08-	DT17ED4	2720		0-N1615	TB [DG]
3.0 HDi 240	04/09-	DT20C	2992		0-N1613	TB [TE]
3.0 HDi 240	04/09-	DT20C	2992		0-N1614	TB [TE]
3.0 HDi 240	04/09-	DT20C	2992		0-N1615	TB [DG]
3.0, 3.0 V6	02/08-	XFU (ES9A), XFV (ES9A)	2946		0-N1056	TB [TE]
3.0, 3.0 V6	02/08-	XFU (ES9A), XFV (ES9A)	2946		0-N170	TB [DG]
3.0, 3.0 V6	02/08-	XFU (ES9A), XFV (ES9A)	2946		0-N171	TB [DG]
1.6 HDi	02/08-	9HZ (DV6TED4)	1560	für Fahrzeuge mit elektrischer Servolenkung,	0-N1502	VB [BT] S
1.6 HDi	02/08-	9HZ (DV6TED4)	1560	für Fahrzeuge ohne elektrische Servolenkung	0-N1807	VB [DG]
1.6 HDi	02/08-	9HZ (DV6TED4)	1560	für Fahrzeuge ohne elektrische Servolenkung	0-N1808	VB [BT] S
1.6 HDi 110, 1.6 HDi 115	07/10-	9HL (DV6C), 9HR (DV6C)	1560	, für Fahrzeuge ohne Start-Stopp-Funktion	0-N1502	VB [BT] S
1.6 HDi 110, 1.6 HDi 115	07/10-	9HL (DV6C), 9HR (DV6C)	1560	Rippenanzahl: 6; für Fahrzeuge mit Start-Stopp-Funktion,	0-N2355	VB [DG]
1.6 HDi 110, 1.6 HDi 115	07/10-	9HL (DV6C), 9HR (DV6C)	1560	für Fahrzeuge mit Start-Stopp-Funktion	0-N2392	VB [BT] S
1.6 THP 155, 1.6 VTi 120	04/09-	5FS (EP6C), 5FV (EP6CDT)	1598		0-N2055	VB [BT] S
1.6 THP 155, 1.6 VTi 120	04/09-	5FS (EP6C), 5FV (EP6CDT)	1598	für OE: 11 28 7 598 832, 11 28 7 598 833	0-N2237	VB [DG]
1.8 16V	02/08-	6FY (EW7A)	1749		0-N1840	VB [BT] S
2.0 16V, 2.0 16V BioFlex	02/08-	RFJ (EW10A)	1997		0-N1840	VB [BT] S
2.0 HDi	02/08-	RHF (DW10BTED4), RHR (DW10BTED4)	1997		0-N1327	VB [BT]
2.0 HDi	02/08-	RHF (DW10BTED4), RHR (DW10BTED4)	1997	Orga. → 11193	0-N2037	VB [BT] S
2.0 HDi	02/08-	RHF (DW10BTED4), RHR (DW10BTED4)	1997	Orga. 11194 →	0-N2046	VB [BT] S
2.0 HDi 165	04/09-	RHH (DW10CTED4)	1997		0-N2268	VB [BT] S
2.2 HDi, 2.2 HDi 200	02/08-	4HL (DW12C), 4HT (DW12BTED4)	2179		0-N2042	VB [BT] S
3.0 V6	02/08-	XFU (ES9A)	2946		0-N1757	VB [VD]



CM³



Art. Nr.



ohne Halter

C5 III (RD_)							
3.0 V6	02/08-	XFU (ES9A)	2946			0-N1803	VB [DG]
3.0, 3.0 V6	02/08-	XFU (ES9A), XfV (ES9A)	2946			0-N1473	VB [BT] S
C5 III Break (TD_)							
1.6 HDi	02/08-	9HZ (DV6TED4)	1560	25x137		SK-1424	BTK
1.6 HDi	02/08-	9HZ (DV6TED4)	1560	25x137		SK-1424AQ1	BTKW
1.6 HDi 110, 1.6 HDi 115	07/10-	9HL (DV6C), 9HR (DV6C)	1560	25x141		SK-1728	BTK
1.6 HDi 110, 1.6 HDi 115	07/10-	9HL (DV6C), 9HR (DV6C)	1560	25x141		SK-1728AQ1	BTKW
1.8 16V	02/08-	6FY (EW7A)	1749	25x153		SK-1600	BTK
1.8 16V	02/08-	6FY (EW7A)	1749	25x153		SK-1600AQ1	BTKW
2.0 16V, 2.0 16V BioFlex	02/08-	RFJ (EW10A)	1997	25x153		SK-1600	BTK
2.0 16V, 2.0 16V BioFlex	02/08-	RFJ (EW10A)	1997	25x153		SK-1600AQ1	BTKW
2.0 HDi 150, 2.0 HDi 165	04/09-	AHR (DW10FD), RHE (DW10CTED4), RHH (DW10CTED4)	1997	25x116		SK-1714AQ1	BTKW
2.0 HDi, 2.0 HDi 140	02/08-	RHF (DW10BTED4), RHR (DW10BTED4)	1997	25.4x116		SK-1594	BTK
2.0 HDi, 2.0 HDi 140	02/08-	RHF (DW10BTED4), RHR (DW10BTED4)	1997	25.4x116		SK-1594AQ1	BTKW
2.0 HDi, 2.0 HDi 150, 2.0 HDi 165	02/08-	AHR (DW10FD), RHE (DW10CTED4), RHH (DW10CTED4), RHR (DW10BTED4)	1997	25x116		SK-1714	BTK
2.2 HDi 165	02/08-	4HP (DW12BTED4)	2179	25x116		SK-1714	BTK
2.2 HDi 165	02/08-	4HP (DW12BTED4)	2179	25x116		SK-1714AQ1	BTKW
2.2 HDi, 2.2 HDi 165, 2.2 HDi 200	02/08-	4HL (DW12C), 4HP (DW12BTED4), 4HT (DW12BTED4)	2179	25.4x118		SK-1692	BTK
2.2 HDi, 2.2 HDi 165, 2.2 HDi 200	02/08-	4HL (DW12C), 4HP (DW12BTED4), 4HT (DW12BTED4)	2179	25.4x118		SK-1692AQ1	BTKW
2.7 HDi	02/08-	DT17ED4, UHZ (DT17BTED4)	2720	29x195; 20x85		SK-1675	BTK
2.7 HDi	02/08-	DT17ED4, UHZ (DT17BTED4)	2720	29x195		SK-1742	BTK
3.0 HDi 240	04/09-	DT20C	2992	29x195		SK-1742	BTK
3.0 V6	02/08-	XFU (ES9A)	2946	32x259		SK-1483	BTK
3.0 V6	02/08-	XFU (ES9A)	2946	32x259		SK-1483AQ1	BTKW
1.6 HDi	02/08-	9HZ (DV6TED4)	1560			0-N1062	TB [TE]
1.6 HDi	02/08-	9HZ (DV6TED4)	1560			0-N1066	TB [DG]
1.6 HDi 110, 1.6 HDi 115	07/10-	9HL (DV6C), 9HR (DV6C)	1560			0-N2224	TB [TE]
1.6 HDi 110, 1.6 HDi 115	07/10-	9HL (DV6C), 9HR (DV6C)	1560			0-N2382	TB [DG]
1.8 16V	02/08-	6FY (EW7A)	1749			0-N1065	TB [DG]
1.8 16V	02/08-	6FY (EW7A)	1749			0-N1343	TB [TE]
2.0 16V, 2.0 16V BioFlex	02/08-	RFJ (EW10A)	1997			0-N1065	TB [DG]
2.0 16V, 2.0 16V BioFlex	02/08-	RFJ (EW10A)	1997			0-N1343	TB [TE]
2.0 HDi 140, 2.0 HDi 165	04/09-	RHF (DW10BTED4), RHH (DW10CTED4)	1997			0-N2063	TB [TE]
2.0 HDi, 2.0 HDi 140, 2.0 HDi 165	02/08-	RHF (DW10BTED4), RHH (DW10CTED4), RHR (DW10BTED4)	1997			0-N1334	TB [DG]
2.2 HDi, 2.2 HDi 200	02/08-	4HL (DW12C), 4HT (DW12BTED4)	2179			0-N1334	TB [DG]
2.2 HDi, 2.2 HDi 200	02/08-	4HL (DW12C), 4HT (DW12BTED4)	2179			0-N2018	TB [BT]
2.7 HDi	02/08-	DT17ED4, UHZ (DT17BTED4)	2720			0-N1613	TB [TE]
2.7 HDi	02/08-	DT17ED4, UHZ (DT17BTED4)	2720			0-N1614	TB [TE]
2.7 HDi	02/08-	DT17ED4, UHZ (DT17BTED4)	2720			0-N1615	TB [DG]
3.0	02/08-	ES9A	2946			0-N170	TB [DG]
3.0	02/08-	ES9A	2946			0-N171	TB [DG]
3.0 HDi 240	04/09-	DT20C	2992			0-N1613	TB [TE]
3.0 HDi 240	04/09-	DT20C	2992			0-N1614	TB [TE]
3.0 HDi 240	04/09-	DT20C	2992			0-N1615	TB [DG]
3.0 V6	02/08-	XFU (ES9A)	2946			0-N170	TB [DG]
3.0 V6	02/08-	XFU (ES9A)	2946			0-N171	TB [DG]
3.0, 3.0 V6	02/08-	XFU (ES9A), XfX (ES9J4S)	2946			0-N1056	TB [TE]
1.6 HDi	02/08-	9HZ (DV6TED4)	1560		für Fahrzeuge mit elektrischer Servolenkung, *	0-N1502	VB [BT] S
1.6 HDi	02/08-	9HZ (DV6TED4)	1560		für Fahrzeuge ohne elektrische Servolenkung	0-N1807	VB [DG]
1.6 HDi	02/08-	9HZ (DV6TED4)	1560		für Fahrzeuge ohne elektrische Servolenkung	0-N1808	VB [BT] S
1.6 HDi 110, 1.6 HDi 115	07/10-	9HL (DV6C), 9HR (DV6C)	1560		*, für Fahrzeuge ohne Start-Stopp-Funktion	0-N1502	VB [BT] S
1.6 HDi 110, 1.6 HDi 115	07/10-	9HL (DV6C), 9HR (DV6C)	1560		Rippenanzahl: 6; für Fahrzeuge mit Start-Stopp-Funktion, *	0-N2355	VB [DG]
1.6 HDi 110, 1.6 HDi 115	07/10-	9HL (DV6C), 9HR (DV6C)	1560		für Fahrzeuge mit Start-Stopp-Funktion	0-N2392	VB [BT] S
1.6 THP 150, 1.6 THP 155, 1.6 VTI 120	04/09-	5FN (EP6CDT), 5FS (EP6C), 5FV (EP6CDT)	1598		für OE: 11 28 7 598 832, 11 28 7 598 833	0-N2237	VB [DG]
1.6 THP 155, 1.6 VTI 120	04/09-	5FS (EP6C), 5FV (EP6CDT)	1598		*	0-N2055	VB [BT] S
1.8 16V	02/08-	6FY (EW7A)	1749			0-N1840	VB [BT] S
2.0 16V	02/08-	RFJ (EW10A)	1997			0-N1840	VB [BT] S
2.0 HDi	02/08-	RHR (DW10BTED4)	1997			0-N1327	VB [BT]

CM³

Art. Nr.



ohne Halter

C5 III Break (TD_)

2.0 HDi	02/08-	RHR (DW10BTED4)	1997	Orga.→11193	0-N2037	VB [BT]	S
2.0 HDi	02/08-	RHR (DW10BTED4)	1997	Orga.11194→	0-N2046	VB [BT]	S
2.0 HDi 150	04/09-	DW10CTED4	1997		0-N2268	VB [BT]	S
2.0 HDi 165	04/09-	RHH (DW10CTED4)	1997		0-N2268	VB [BT]	S
2.2 HDi 165	02/08-	DW10CTED4	2179		0-N2268	VB [BT]	S
2.2 HDi, 2.2 HDi 200	02/08-	4HL (DW12C), 4HT (DW12BTED4)	2179		0-N2042	VB [BT]	S
3.0 V6	02/08-	XFU (ES9A)	2946		0-N1757	VB [VD]	
3.0 V6	02/08-	XFU (ES9A)	2946		0-N1803	VB [DG]	
3.0, 3.0 V6	02/08-	XFU (ES9A), XFX (ES9J4S)	2946		0-N1473	VB [BT]	S

C6 (TD_)

2.2 HDi	06/06-	4HT (DW12BTED4)	2179	25.4x118; → 01/2007; Orga.→11024	SK-1588	BTK	
2.2 HDi	06/06-	4HP (DW12BTED4), 4HT (DW12BTED4)	2179	25.4x118	SK-1692	BTK	
2.2 HDi	06/06-	4HP (DW12BTED4), 4HT (DW12BTED4)	2179	25.4x118	SK-1692AQ1	BTKW	
2.7 HDi	09/05-	DT17ED4, UHZ (DT17BTED4)	2720	29x195; 20x85	SK-1675	BTK	
2.7 HDi	09/05-	DT17ED4, UHZ (DT17BTED4)	2720	29x195	SK-1742	BTK	
3.0 HDi	04/09-	DT20C	2992	29x195	SK-1742	BTK	
3.0 V6	09/05-	XFV (ES9A), XFX (ES9J4S)	2946	32x259	SK-1483	BTK	
3.0 V6	09/05-	XFV (ES9A), XFX (ES9J4S)	2946	32x259	SK-1483AQ1	BTKW	
2.2 HDi	06/06-	4HT (DW12BTED4)	2179		0-N1334	TB [DG]	
2.2 HDi	06/06-	4HT (DW12BTED4)	2179		0-N2018	TB [BT]	
2.7 HDi	09/05-	DT17ED4, UHZ (DT17BTED4)	2720		0-N1613	TB [TE]	
2.7 HDi	09/05-	DT17ED4, UHZ (DT17BTED4)	2720		0-N1614	TB [TE]	
2.7 HDi	09/05-	DT17ED4, UHZ (DT17BTED4)	2720		0-N1615	TB [DG]	
3.0 HDi	04/09-	DT20C	2992		0-N1613	TB [TE]	
3.0 HDi	04/09-	DT20C	2992		0-N1614	TB [TE]	
3.0 HDi	04/09-	DT20C	2992		0-N1615	TB [DG]	
3.0 V6	09/05-	XFV (ES9A), XFX (ES9J4S)	2946		0-N1056	TB [TE]	
3.0 V6	09/05-	XFV (ES9A), XFX (ES9J4S)	2946		0-N170	TB [DG]	
3.0 V6	09/05-	XFV (ES9A), XFX (ES9J4S)	2946		0-N171	TB [DG]	
2.2 HDi	06/06-	4HT (DW12BTED4)	2179		0-N2042	VB [BT]	S
3.0 V6	09/05-	XFV (ES9A), XFX (ES9J4S)	2946		0-N1473	VB [BT]	S
3.0 V6	09/05-	XFV (ES9A), XFX (ES9J4S)	2946		0-N1757	VB [VD]	
3.0 V6	09/05-	XFV (ES9A), XFX (ES9J4S)	2946		0-N1803	VB [DG]	

C8 (EA_, EB_)

2.0 16V	09/05-	RFJ (EW10A)	1997	25x153	SK-1600	BTK	
2.0 16V	09/05-	RFJ (EW10A)	1997	25x153	SK-1600AQ1	BTKW	
2.0 HDi	07/02-	RHM (DW10ATED4), RHM (DW10ATED4), RHT (DW10ATED4)	1997	25.4x144	SK-1534	BTK	
2.0 HDi	07/02-	RHM (DW10ATED4), RHM (DW10ATED4), RHT (DW10ATED4)	1997	25.4x144	SK-1534AQ1	BTKW	
2.0 HDi	07/02-	RHK (DW10UTED4), RHW (DW10ATED4)	1997	25.4x116	SK-1594AQ1	BTKW	
2.0 HDi 135	03/06-	DW10BTED4	1997	25.4x116	SK-1594AQ1	BTKW	
2.0 HDi 135	03/06-	RHD (DW10CB), RHD (DW10CTED4), RHR (DW10BTED4)	1997	25x116	SK-1714	BTK	
2.0 HDi 135	03/06-	DW10CTED4	1997	25x116	SK-1714AQ1	BTKW	
2.0 HDi 165	03/06-	RHE (DW10CTED4), RHH (DW10CTED4)	1997	25x116; 04/2010 →	SK-1714	BTK	
2.0 HDi 165	03/06-	RHE (DW10CTED4), RHH (DW10CTED4)	1997	25x116	SK-1714AQ1	BTKW	
2.0 HDi, 2.0 HDi 135	07/02-	RHD (DW10CB), RHD (DW10CTED4), RHR (DW10BTED4), RHK (DW10UTED4), RHW (DW10ATED4)	1997	25.4x116	SK-1594	BTK	
2.0, 2.0 16V	07/02-	RFJ (EW10A), RFN (EW10J4)	1997	25.4x153	SK-1482	BTK	
2.0, 2.0 16V	07/02-	RFJ (EW10A), RFN (EW10J4)	1997	25.4x153	SK-1482AQ1	BTKW	
2.2	07/02-	3FZ (EW12J4)	2230	25.4x153	SK-1482	BTK	
2.2	07/02-	3FZ (EW12J4)	2230	25.4x153	SK-1482AQ1	BTKW	
2.2 HDi	07/02-	4HW (DW12TED4)	2179	25.4x146; → 04/2004; Orga.→10010	SK-1394	BTK	
2.2 HDi	07/02-	4HW (DW12TED4)	2179	25.4x146; → 04/2004; Orga.→10010	SK-1394AQ1	BTKW	
2.2 HDi	07/02-	4HW (DW12TED4)	2179	25.4x146; 04/2004 →; Orga.10011→; Baumuster: 4HW	SK-1614	BTK	
2.2 HDi	07/02-	4HW (DW12TED4)	2179	25.4x146; 04/2004 →; Orga.10011→	SK-1614AQ1	BTKW	
2.2 HDi	06/06-	4HP (DW12BTED4), 4HR (DW12BTED4), 4HT (DW12BTED4)	2179	25.4x118	SK-1692	BTK	
2.2 HDi	06/06-	4HP (DW12BTED4), 4HR (DW12BTED4), 4HT (DW12BTED4)	2179	25.4x118	SK-1692AQ1	BTKW	
3.0 V6	07/02-	XFX (ES9J4S)	2946	32x259; 10/2002 →	SK-1483	BTK	
3.0 V6	07/02-	XFX (ES9J4S)	2946	32x259	SK-1483AQ1	BTKW	
2.0	07/02-	RFN (EW10J4)	1997		0-N1057	TB [TE]	
2.0 16V	09/05-	RFJ (EW10A)	1997		0-N1343	TB [TE]	



CM³



Art. Nr.



C8 (EA_, EB_)							
2.0 HDi	07/02-	RHM (DW10ATED4), RHM (DW10ATED4), RHT (DW10ATED4)	1997			0-N118P	TB [TE]
2.0 HDi	07/02-	RHM (DW10ATED4), RHM (DW10ATED4), RHT (DW10ATED4)	1997			0-N119P	TB [DG]
2.0 HDi 165	03/06-	RHE (DW10CTED4), RHH (DW10CTED4)	1997			0-N2063	TB [TE]
2.0 HDi, 2.0 HDi 135, 2.0 HDi 165	03/06-	RHD (DW10CB), RHD (DW10CTED4), RHR (DW10BTED4), RHE (DW10CTED4), RHH (DW10CTED4), RHK (DW10UTED4)	1997			0-N1334	TB [DG]
2.0, 2.0 16V	07/02-	RFJ (EW10A), RFN (EW10J4)	1997			0-N1065	TB [DG]
2.2	07/02-	3FZ (EW12J4)	2230			0-N1057	TB [TE]
2.2	07/02-	3FZ (EW12J4)	2230			0-N1065	TB [DG]
2.2 HDi	07/02-	4HW (DW12TED4)	2179	Orga.→10010		0-N118P	TB [TE]
2.2 HDi	07/02-	4HW (DW12TED4)	2179	Orga.→10010		0-N119P	TB [DG]
2.2 HDi	07/02-	4HW (DW12TED4)	2179	Orga.10011→		0-N1357	TB [TE]
2.2 HDi	07/02-	4HW (DW12TED4)	2179	Orga.10011→		0-N1358	TB [DG]
2.2 HDi	06/06-	4HT (DW12BTED4)	2179			0-N1334	TB [DG]
2.2 HDi	06/06-	4HT (DW12BTED4)	2179			0-N2018	TB [BT]
3.0 V6	07/02-	XFJ (ES9J4S)	2946			0-N1056	TB [TE]
3.0 V6	07/02-	XFJ (ES9J4S)	2946			0-N170	TB [DG]
3.0 V6	07/02-	XFJ (ES9J4S)	2946			0-N171	TB [DG]
2.0	07/02-	RFN (EW10J4)	1997	Orga.→10247		0-N1391	VB [BT] S
2.0	07/02-	RFN (EW10J4)	1997	Orga.→10247		0-N1416	VB [DG]
2.0	07/02-	RFN (EW10J4)	1997	Orga.10248→		0-N2276	VB [DG]
2.0 16V	09/05-	RFJ (EW10A)	1997			0-N1840	VB [BT] S
2.0 HDi	07/02-	RHM (DW10ATED4), RHM (DW10ATED4), RHT (DW10ATED4), RHW (DW10ATED4)	1997			0-N1320	VB [TE]
2.0 HDi	07/02-	RHM (DW10ATED4), RHM (DW10ATED4), RHT (DW10ATED4)	1997			0-N1493	VB [BT] S
2.0 HDi 165	03/06-	RHE (DW10CTED4), RHH (DW10CTED4)	1997			0-N2268	VB [BT] S
2.0 HDi, 2.0 HDi 135	03/06-	RHD (DW10CB), RHD (DW10CTED4), RHR (DW10BTED4), RHK (DW10UTED4)	1997			0-N1327	VB [BT]
2.0 HDi, 2.0 HDi 135	03/06-	RHD (DW10CB), RHD (DW10CTED4), RHR (DW10BTED4), RHK (DW10UTED4)	1997	Orga.→11193		0-N2037	VB [BT] S
2.0 HDi, 2.0 HDi 135	03/06-	RHD (DW10CB), RHD (DW10CTED4), RHR (DW10BTED4), RHK (DW10UTED4)	1997	Orga.11194→		0-N2046	VB [BT] S
2.2	07/02-	3FZ (EW12J4)	2230			0-N1391	VB [BT] S
2.2	07/02-	3FZ (EW12J4)	2230	Orga.→10247		0-N1416	VB [DG]
2.2	07/02-	3FZ (EW12J4)	2230	Orga.10248→		0-N2276	VB [DG]
2.2 HDi	07/02-	4HW (DW12TED4)	2179			0-N1413	VB [DG]
2.2 HDi	07/02-	4HW (DW12TED4)	2179			0-N1493	VB [BT] S
2.2 HDi	06/06-	4HT (DW12BTED4)	2179			0-N2042	VB [BT] S
3.0 V6	07/02-	XFJ (ES9J4S)	2946			0-N1449	VB [TE]
3.0 V6	07/02-	XFJ (ES9J4S)	2946			0-N1473	VB [BT] S
3.0 V6	07/02-	XFJ (ES9J4S)	2946			0-N1757	VB [VD]
C15 (VD_-)							
1.0	10/84-12/97	TU9, XV8	954	17x104; 05/1988 →; Orga.4196→		SK-1003	BTK
1.0	10/84-12/97	TU9, XV8	954	17x104; 05/1988 →; Orga.4196→		SK-1003AQ1	BTKW
1.0 E	11/92-07/96	TU9K	954	17x104		SK-1003	BTK
1.0 E	11/92-07/96	TU9K	954	17x104		SK-1003AQ1	BTKW
1.1	10/84-12/96	109K, E1A	1124	17x104; 05/1988 →; Orga.4196→		SK-1003	BTK
1.1	10/84-12/96	109K, E1A	1124	17x104; 05/1988 →; Orga.4196→		SK-1003AQ1	BTKW
1.1	11/88-07/96	H1A	1124	17x104; Orga.04222→		SK-1003	BTK
1.1	11/88-07/96	H1A	1124	17x104; Orga.04222→		SK-1003AQ1	BTKW
1.1 i	07/88-12/96	HDZ (TU1M)	1124	17x104		SK-1003	BTK
1.1 i	07/88-12/96	HDZ (TU1M)	1124	17x104; Orga.4196→		SK-1003AQ1	BTKW
1.4 E	07/87-12/96	K3A	1360	17x108; 05/1988 → 12/1991; Orga.4196→		SK-1004AQ1	BTKW
1.4 i	05/91-12/96	KDY (TU3FM), KDY (TU3M)	1360	17x108; 11/1992 →; Orga.4196→		SK-1004	BTK
1.4 i	05/91-12/96	TU3M	1360	17x108; Orga.4196→		SK-1004AQ1	BTKW
1.4 i	05/91-12/96	KDY (TU3FM), KDY (TU3M)	1360	17x101; 11/1992 →; Orga.4196→		SK-1020	BTK
1.4 i	05/91-12/96	KDY (TU3FM), KDY (TU3M)	1360	17x101; Orga.4196→		SK-1020AQ1	BTKW
1.4, 1.4 E	05/87-12/96	150D (XY7), K1H (TU3A), K3A	1360	17x108; Orga.4196→		SK-1004	BTK
1.4, 1.4 E	05/87-12/96	150D (XY7), K1H (TU3A)	1360	17x108; Orga.4196→		SK-1004AQ1	BTKW
1.4, 1.4 E	05/87-12/96	150D (XY7), K1H (TU3A), K3A	1360	17x101; Orga.4196→		SK-1020	BTK
1.4, 1.4 E	05/87-12/96	150D (XY7), K1H (TU3A), K3A	1360	17x101; 05/1988 →; Orga.4196→		SK-1020AQ1	BTKW
1.8 D	07/86-12/00	161A (XUD7)	1769	25.39x136; → 12/1993; Baumuster: 161A		SK-1007	BTK
1.8 D	07/86-12/00	161A (XUD7)	1769	25.4x136; → 02/1994; Orga.3584→		SK-1007AQ1	BTKW
1.8 D	07/86-12/00	161A (XUD7)	1769	25.4x136; 01/1994 →; Baumuster: 161A		SK-1022	BTK

CM³

Art. Nr.

**C15 (VD-)**

1.9 D	12/00-12/05	WJX (DW8B)	1868	25.4x140	SK-1086	BTK	
1.9 D	12/00-12/05	WJX (DW8B)	1868	25.4x140	SK-1086AQ1	BTKW	
1.0	10/84-12/97	TU9, XV8	954		0-N811	TB [TE]	
1.1	10/84-12/96	109K, E1A	1124	05/1988 →	0-N811	TB [TE]	
1.1 i	07/88-12/96	HDZ (TU1M)	1124		0-N811	TB [TE]	
1.4, 1.4 E, 1.4 i	05/87-12/96	150D (XY7), K1H (TU3A), K3A, KDY (TU3FM), KDY (TU3M)	1360		0-N811	TB [TE]	
1.8 D	07/86-12/00	161A (XUD7)	1769	→ 02/1994	0-N813	TB [TE]	
1.8 D	07/86-12/00	161A (XUD7)	1769	→ 02/1994	0-N814	TB [DG]	
1.8 D	07/86-12/00	161A (XUD7)	1769	03/1994 →	0-N900	TB [DG]	
1.8 D	07/86-12/00	161A (XUD7)	1769	03/1994 →	0-N901	TB [TE]	
1.9 D	12/00-12/05	WJX (DW8B)	1868		0-N118P	TB [TE]	
1.9 D	12/00-12/05	WJX (DW8B)	1868		0-N1381	TB [DG]	
1.1, 1.1 i	10/84-12/96	109K, E1A, HDZ (TU1M)	1124		0-N125	VB [TE]	S
1.4, 1.4 i	07/87-12/96	K1H (TU3A), KDY (TU3FM), KDY (TU3M)	1360		0-N125	VB [TE]	S
1.8 D	07/86-12/00	161A (XUD7)	1769		0-N1624	VB [BT]	S
1.9 D	12/00-12/05	WJX (DW8B)	1868		0-N1624	VB [BT]	S

C15 Kombi

1.1	08/88-07/96	HDZ (TU1M)	1124	17x104	SK-1003	BTK	
1.1	08/88-07/96	HDZ (TU1M)	1124	17x104	SK-1003AQ1	BTKW	
1.4	05/87-07/96	150D (XY7), KDY (TU3M)	1360	17x108; Orga.4196→	SK-1004	BTK	
1.4	05/87-07/96	150D (XY7), KDY (TU3M)	1360	17x101; Orga.4196→	SK-1020	BTK	
1.4	05/87-10/92	150D (XY7)	1360	17x101; 05/1988 →; Orga.4196→	SK-1020AQ1	BTKW	
1.4	05/91-07/96	KDY (TU3M)	1360	17x101; Orga.4196→	SK-1020AQ1	BTKW	
1.8 D	04/87-08/00	161A (XUD7)	1769	25.39x136; → 12/1993; Baumuster: 161A	SK-1007	BTK	
1.8 D	04/87-08/00	161A (XUD7)	1769	25.4x136; → 12/1993	SK-1007AQ1	BTKW	
1.8 D	04/87-08/00	161A (XUD7)	1769	25.4x136; 01/1994 →; Baumuster: 161A	SK-1022	BTK	
1.1	08/88-07/96	HDZ (TU1M)	1124		0-N811	TB [TE]	
1.4	05/87-07/96	150D (XY7), KDY (TU3M)	1360		0-N811	TB [TE]	
1.8 D	04/87-08/00	161A (XUD7)	1769	→ 02/1994	0-N813	TB [TE]	
1.8 D	04/87-08/00	161A (XUD7)	1769	→ 02/1994	0-N814	TB [DG]	
1.8 D	04/87-08/00	161A (XUD7)	1769	03/1994 →	0-N900	TB [DG]	
1.8 D	04/87-08/00	161A (XUD7)	1769	03/1994 →	0-N901	TB [TE]	
1.1	08/88-07/96	HDZ (TU1M)	1124		0-N125	VB [TE]	S
1.4	05/91-07/96	KDY (TU3M)	1360		0-N125	VB [TE]	S
1.8 D	04/87-08/00	161A (XUD7)	1769		0-N1624	VB [BT]	S

C25 Bus (280_, 290_)

1.9 D	07/87-02/94	D9B (XUD9A/U)	1905	25.39x136; 01/1988 →	SK-1007	BTK	
1.9 D	07/87-02/94	D9B (XUD9A/U)	1905	25.4x136	SK-1007AQ1	BTKW	
1.9 TD	04/92-02/94	M705	1930	25x173	SK-1144	BTK	
2.5 D	11/81-01/94		2498	32x118; 10/1983 →	SK-1018S	BTK	
2.5 D, 2.5 D 4x4, 2.5 D Turbo, 2.5 D Turbo 4x4	10/85-02/94	CRD93L (U25-661), CRD93LS (U25-673)	2500	32x118	SK-1018S	BTK	
1.9 D	07/87-02/94	D9B (XUD9A/U)	1905		0-N813	TB [TE]	
1.9 D	07/87-02/94	D9B (XUD9A/U)	1905		0-N814	TB [DG]	
1.9 TD	04/92-02/94	M705	1930		0-N835	TB [TE]	
2.5 D	11/81-01/94		2498		0-N822	TB [TE]	
2.5 D, 2.5 D 4x4, 2.5 D Turbo, 2.5 D Turbo 4x4	10/85-02/94	CRD93L (U25-661), CRD93LS (U25-673)	2500		0-N815	TB [TE]	
2.5 D, 2.5 D 4x4, 2.5 D Turbo, 2.5 D Turbo 4x4	10/85-02/94	CRD93L (U25-661), CRD93LS (U25-673)	2500		0-N822	TB [TE]	

C25 Kasten (280_, 290_)

1.9 D 1400, 1.9 D 4x4	01/88-01/94	DJY (XUD9A)	1905	25.39x136	SK-1007	BTK	
1.9 D 1400, 1.9 D 4x4	01/88-01/94	DJY (XUD9A)	1905	25.4x136	SK-1007AQ1	BTKW	
1.9 DT	10/91-01/94	M705	1929	25x173	SK-1144	BTK	
2.5 D	11/81-01/94	CRD93L (U25-661)	2498	32x118; 10/1983 →	SK-1018S	BTK	
2.5 D 4x4, 2.5 DT, 2.5 DT 4x4	11/83-01/94	CRD93LS (U25-673)	2498	32x118	SK-1018S	BTK	
1.9 D 1400, 1.9 D 4x4	01/88-01/94	DJY (XUD9A)	1905		0-N813	TB [TE]	
1.9 D 1400, 1.9 D 4x4	01/88-01/94	DJY (XUD9A)	1905		0-N814	TB [DG]	
1.9 DT	10/91-01/94	M705	1929		0-N835	TB [TE]	
2.5 D 4x4	11/83-12/86		2498		0-N815	TB [TE]	
2.5 D, 2.5 D 4x4, 2.5 DT, 2.5 DT 4x4	11/81-01/94	CRD93L (U25-661), CRD93LS (U25-673)	2498		0-N822	TB [TE]	

C25 Pritsche/Fahrgestell (280_, 290_)

1.9	01/88-01/94	DJY (XUD9A)	1905	25.39x136	SK-1007	BTK	
1.9	01/88-01/94	DJY (XUD9A)	1905	25.4x136	SK-1007AQ1	BTKW	

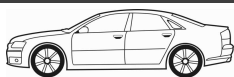

CM³



Art. Nr.



C25 Pritsche/Fahrgestell (280_, 290_)

1.9 DT	10/91-01/94		1929	25x173	SK-1144	BTK	
2.5 D, 2.5 DT	11/83-01/94	CRD93L (U25-661), CRD93LS (U25-673)	2498	32x118	SK-1018S	BTK	
1.9	01/88-01/94	DJY (XUD9A)	1905		0-N813	TB [TE]	
1.9	01/88-01/94	DJY (XUD9A)	1905		0-N814	TB [DG]	
1.9 DT	10/91-01/94		1929		0-N835	TB [TE]	
2.5 D, 2.5 DT	11/83-01/94	CRD93L (U25-661), CRD93LS (U25-673)	2498		0-N822	TB [TE]	

C-CROSSER (EP_)

2.2 HDi	02/07-	4HN (DW12MTED4)	2179	25.4x118; 06/2007 →	SK-1692	BTK	
2.2 HDi	02/07-	4HN (DW12MTED4)	2179	25.4x118	SK-1692AQ1	BTKW	
2.2 HDi	02/07-	4HN (DW12MTED4)	2179		0-N1334	TB [DG]	
2.2 HDi	02/07-	4HN (DW12MTED4)	2179		0-N2018	TB [BT]	
2.0, 2.0 Allrad	11/10-	4B11	1998		0-N2048	VB [DG]	
2.0, 2.0 Allrad	11/10-	4B11	1998		0-N2112	VB [BT]	S
2.2 HDi	02/07-	4HN (DW12MTED4)	2179		0-N2019	VB [DG]	
2.2 HDi	02/07-	4HN (DW12MTED4)	2179		0-N2116	VB [BT]	S
2.4 16V	08/08-	SFZ (4B12-MMC)	2360		0-N2048	VB [DG]	
2.4 16V	08/08-	SFZ (4B12-MMC)	2360		0-N2112	VB [BT]	S

C-CROSSER ENTERPRISE

2.2 HDi	01/09-	4HN (DW12MTED4)	2179	25.4x118	SK-1692	BTK	
2.2 HDi	01/09-	4HN (DW12MTED4)	2179	25.4x118	SK-1692AQ1	BTKW	
2.2 HDi	01/09-	4HN (DW12MTED4)	2179		0-N1334	TB [DG]	
2.2 HDi	01/09-	4HN (DW12MTED4)	2179		0-N2018	TB [BT]	
2.2 HDi	01/09-	4HN (DW12MTED4)	2179		0-N2019	VB [DG]	
2.2 HDi	01/09-	4HN (DW12MTED4)	2179		0-N2116	VB [BT]	S
2.4 16V	01/09-	4B12	2360		0-N2048	VB [DG]	
2.4 16V	01/09-	4B12	2360		0-N2112	VB [BT]	S

C-ELYSEE

1.6 HDi 92	11/12-	9HJ (DV6DTEDM), 9HP (DV6DTE)	1560	25x141	SK-1728	BTK	
1.6 HDi 92	11/12-	9HJ (DV6DTEDM), 9HP (DV6DTE)	1560	25x141	SK-1728AQ1	BTKW	
1.6 VTi 115	11/12-	NFP (EC5)	1587	25.4x134	SK-1615	BTK	
1.2 VTi 72	11/12-	HMY (EB2M)	1199		0-N2424	TB [DG]	
1.6 HDi 92	11/12-	9HJ (DV6DTEDM), 9HP (DV6DTE)	1560		0-N2224	TB [TE]	
1.6 HDi 92	11/12-	DV6DTE	1560		0-N2382	TB [DG]	
1.6 VTi 115	11/12-	NFP (EC5)	1587		0-N1359	TB [TE]	
1.6 VTi 115	11/12-	NFP (EC5)	1587		0-N1360	TB [DG]	
1.2 VTi 72	11/12-	HMY (EB2M)	1199	⊗	0-N1419	VB [DG]	
1.6 HDi 92	11/12-	9HJ (DV6DTEDM), 9HP (DV6DTE)	1560		0-N1502	VB [BT]	S
1.6 VTi 115	11/12-	NFP (EC5)	1587	⊗	0-N1673	VB [BT]	S

CX I (MA)

2000	06/79-08/85	829 A5	1995	19x116; 10/1983 →	SK-1091	BTK	
2200	09/74-07/76	M22-617	2175	19x118	SK-1092	BTK	
2200	06/81-08/85	J6T A500	2165	19x118	SK-1092	BTK	
25 D Turbo, 2500 D	02/78-08/85	M25-629, M25-648	2500	32x118	SK-1018S	BTK	
2000	09/74-05/79	M20-616	1985		0-N882	TB [TE]	
2000	06/79-08/85	829 A5	1995		0-N882	TB [TE]	
2200	06/81-08/85	J6T A500	2165		0-N882	TB [TE]	
25 D Turbo, 25 GTi Turbo 2, 25 TRi, 2500 D	02/78-08/85	M25-629, M25-648, M25-659, M25-662	2500		0-N815	TB [TE]	
25 D Turbo, 25 GTi Turbo 2, 25 TRi, 2500 D	02/78-08/85	M25-629, M25-648, M25-659, M25-662	2500		0-N822	TB [TE]	

CX I Break (MA)

2000	06/79-08/85	829 A5	1995	19x116; 10/1983 →	SK-1091	BTK	
2200	06/81-08/85	J6T A500	2165	19x118	SK-1092	BTK	
2500 D, 2500 D Turbo	02/78-08/85	M25-629, M25-648	2500	32x118	SK-1018S	BTK	
2000	09/75-05/79	M20-616	1985		0-N882	TB [TE]	
2000	06/79-08/85	829 A5	1995		0-N882	TB [TE]	
2200	06/81-08/85	J6T A500	2165		0-N882	TB [TE]	
25 TRi, 2500 D, 2500 D Turbo	02/78-08/85	M25-629, M25-648, M25-659	2500		0-N815	TB [TE]	
25 TRi, 2500 D, 2500 D Turbo	02/78-08/85	M25-629, M25-648, M25-659	2500		0-N822	TB [TE]	

CX II

20 RE	08/85-12/92	829 A5	1995	19x116	SK-1091	BTK	
22 TRS	07/85-07/89	J6T A500	2165	19x118	SK-1092	BTK	
22 TRS	07/85-12/92	J6T A500	2165	19x118; 01/1991 →	SK-1092	BTK	

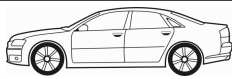
CM³

Art. Nr.



CX II							
25 D, 25 D Turbo	08/85-12/92	M25-648, M25-660, M25-669	2500	32x118		SK-1018S	BTK
20 RE	08/85-12/92	829 A5	1995			0-N882	TB [TE]
22 TRS	07/85-12/92	J6T A500	2165			0-N882	TB [TE]
25 D, 25 D Turbo	08/85-12/92	M25-648, M25-660, M25-669	2500			0-N815	TB [TE]
25 D, 25 D Turbo	08/85-12/92	M25-648, M25-660, M25-669	2500			0-N822	TB [TE]

CX II Break							
20	08/85-08/86	829 A5	1995	19x116		SK-1091	BTK
22 TRS	07/85-12/92	J6T A500	2165	19x118; 01/1991 →		SK-1092	BTK
22TRS	07/85-07/89	J6T A500	2165	19x118		SK-1092	BTK
25 D, 25 D Turbo 2, 2500 D Turbo	08/85-12/92	M25-648, M25-660, M25-669	2500	32x118		SK-1018S	BTK
20	08/85-08/86	829 A5	1995			0-N882	TB [TE]
22 TRS, 22TRS	07/85-12/92	J6T A500	2165			0-N882	TB [TE]
25 D, 25 D Turbo 2, 2500 D Turbo	08/85-12/92	M25-648, M25-660, M25-669	2500			0-N815	TB [TE]
25 D, 25 D Turbo 2, 2500 D Turbo	08/85-12/92	M25-648, M25-660, M25-669	2500			0-N822	TB [TE]

DS3							
1.4 HDi 70	04/10-07/15	8HR (DV4C)	1398	25.4x139; 06/2011 →		SK-1732	BTK
1.4 HDi 70	04/10-07/15	8HR (DV4C)	1398	25.4x139; 06/2011 →		SK-1732AQ1	BTKW
1.6 HDi 110, 1.6 HDi 115, 1.6 HDi 90	11/09-07/15	9HD (DV6C), 9HL (DV6C), 9HP (DV6DTE), 9HR (DV6C)	1560	25x141		SK-1728	BTK
1.6 HDi 110, 1.6 HDi 115, 1.6 HDi 90	11/09-07/15	9HD (DV6C), 9HL (DV6C), 9HP (DV6DTE), 9HR (DV6C)	1560	25x141		SK-1728AQ1	BTKW
1.2 VTi 110, 1.2 VTi 82	01/13-03/15	HMZ (EB2F), HNZ (EB2DT)	1199			0-N2424	TB [DG]
1.4 HDi 70	04/10-07/15	8HR (DV4C)	1398			0-N2224	TB [TE]
1.4 HDi 70	04/10-07/15	8HR (DV4C)	1398			0-N2382	TB [DG]
1.6 HDi 100, 1.6 HDi 110, 1.6 HDi 115, 1.6 HDi 120, 1.6 HDi 90	11/09-07/15	9HD (DV6C), 9HL (DV6C), 9HP (DV6DTE), 9HR (DV6C), BHX (DV6FC), BHY (DV6FD), BHZ (DV6FC)	1560			0-N2382	TB [DG]
1.6 HDi 110, 1.6 HDi 115, 1.6 HDi 90	11/09-07/15	9HD (DV6C), 9HL (DV6C), 9HP (DV6DTE), 9HR (DV6C)	1560			0-N2224	TB [TE]
1.4 HDi 70	04/10-07/15	8HR (DV4C)	1398	für Fahrzeuge ohne Start-Stopp-Funktion		0-N1502	VB [BT] S
1.4 HDi 70	04/10-07/15	8HR (DV4C)	1398	Rippenanzahl: 6; für Fahrzeuge mit Start-Stopp-Funktion, ⚡		0-N2355	VB [DG]
1.4 HDi 70	04/10-07/15	8HR (DV4C)	1398	für Fahrzeuge mit Start-Stopp-Funktion		0-N2392	VB [BT] S
1.4 VTi 95	04/10-07/15	8FP (EP3)	1397	⚡		0-N2055	VB [BT] S
1.4 VTi 95, 1.4 VTi 95 LPG, 1.4 VTi 98	11/09-07/15	8FN (EP3), 8FP (EP3), 8FR (EP3)	1397	für OE: 11 28 7 598 832, 11 28 7 598 833		0-N2237	VB [DG]
1.6 HDi 110, 1.6 HDi 115, 1.6 HDi 90	11/09-07/15	9HD (DV6C), 9HL (DV6C), 9HP (DV6DTE), 9HR (DV6C)	1560	für Fahrzeuge ohne Start-Stopp-Funktion		0-N1502	VB [BT] S
1.6 HDi 110, 1.6 HDi 115, 1.6 HDi 90	11/09-07/15	9HD (DV6C), 9HL (DV6C), 9HP (DV6DTE), 9HR (DV6C)	1560	Rippenanzahl: 6; für Fahrzeuge mit Start-Stopp-Funktion, ⚡		0-N2355	VB [DG]
1.6 HDi 110, 1.6 HDi 115, 1.6 HDi 90	11/09-07/15	9HD (DV6C), 9HL (DV6C), 9HP (DV6DTE), 9HR (DV6C)	1560	für Fahrzeuge mit Start-Stopp-Funktion		0-N2392	VB [BT] S
1.6 Racing, 1.6 THP 150, 1.6 THP 155, 1.6 VTi 120	01/10-07/15	5FD (EP6DTS), 5FN (EP6CDT), 5FX (EP6DT), 5FR (EP6DT), 5FV (EP6CDT), 5FS (EP6C), 5FU (EP6CDTX)	1598	⚡		0-N2055	VB [BT] S
1.6 Racing, 1.6 THP 150, 1.6 THP 155, 1.6 VTi 120	01/10-07/15	5FD (EP6DTS), 5FN (EP6CDT), 5FX (EP6DT), 5FR (EP6DT), 5FV (EP6CDT), 5FS (EP6C), 5FU (EP6CDTX)	1598	für OE: 11 28 7 598 832, 11 28 7 598 833		0-N2237	VB [DG]

DS3 Cabriolet							
1.6 HDi 90	01/13-07/15	9HP (DV6DTE)	1560	25x141		SK-1728	BTK
1.6 HDi 90	01/13-07/15	9HP (DV6DTE)	1560	25x141		SK-1728AQ1	BTKW
1.2 VTi 110, 1.2 VTi 82	01/13-07/15	HMZ (EB2F), HNZ (EB2DT)	1199			0-N2424	TB [DG]
1.6 BlueHdi 100, 1.6 HDi 120, 1.6 HDi 90	01/13-07/15	9HP (DV6DTE), BHY (DV6FD), BHZ (DV6FC)	1560			0-N2382	TB [DG]
1.6 HDi 90	01/13-07/15	9HP (DV6DTE)	1560			0-N2224	TB [TE]
1.6 HDi 90	01/13-07/15	9HP (DV6DTE)	1560	für Fahrzeuge ohne Start-Stopp-Funktion		0-N1502	VB [BT] S
1.6 HDi 90	01/13-07/15	9HP (DV6DTE)	1560	Rippenanzahl: 6; für Fahrzeuge mit Start-Stopp-Funktion, ⚡		0-N2355	VB [DG]
1.6 HDi 90	01/13-07/15	9HP (DV6DTE)	1560	für Fahrzeuge mit Start-Stopp-Funktion		0-N2392	VB [BT] S
1.6 THP 150, 1.6 THP 155, 1.6 VTi 120	01/13-07/15	5FN (EP6CDT), 5FN (EP6DT), 5FR (EP6DT), 5FV (EP6CDT), 5FS (EP6C)	1598	für OE: 11 28 7 598 832, 11 28 7 598 833		0-N2237	VB [DG]

DS4							
1.6 HDi 110, 1.6 HDi 115, 1.6 HDi 90	04/11-07/15	9HD (DV6C), 9HL (DV6C), 9HP (DV6DTE), 9HR (DV6C)	1560	25x141		SK-1728	BTK
1.6 HDi 110, 1.6 HDi 115, 1.6 HDi 90	04/11-07/15	9HD (DV6C), 9HL (DV6C), 9HP (DV6DTE), 9HR (DV6C)	1560	25x141		SK-1728AQ1	BTKW
2.0 HDi 135, 2.0 HDi 165	04/11-07/15	RHE (DW10CTED4), RHH (DW10CTED4)	1997	25x116		SK-1714	BTK
2.0 HDi 135, 2.0 HDi 165	04/11-07/15	RHE (DW10CTED4), RHH (DW10CTED4)	1997	25x116		SK-1714AQ1	BTKW
1.2	07/14-07/15	HNY (EB2DTS)	1199			0-N2424	TB [DG]



CM³



Art. Nr.



ohne Halter

DS4										
1.6 BlueHdi 120, 1.6 HDi 110, 1.6 HDi 115, 1.6 HDi 90	04/11-07/15	9HD (DV6C), 9HL (DV6C), 9HP (DV6DTE), 9HR (DV6C), BHZ (DV6FC)	1560					0-N2382	TB [DG]	
1.6 HDi 110	04/11-07/15	DV6DTE	1560					0-N2382	TB [DG]	
1.6 HDi 110, 1.6 HDi 115, 1.6 HDi 90	04/11-07/15	9HD (DV6C), 9HL (DV6C), 9HP (DV6DTE), 9HR (DV6C)	1560					0-N2224	TB [TE]	
2.0 HDi 165	04/11-07/15	RHH (DW10CTED4)	1997					0-N1334	TB [DG]	
2.0 HDi 165	04/11-07/15	RHH (DW10CTED4)	1997					0-N2063	TB [TE]	
1.6 HDi 110, 1.6 HDi 115, 1.6 HDi 90	04/11-07/15	9HD (DV6C), 9HL (DV6C), 9HP (DV6DTE), 9HR (DV6C)	1560				☼, für Fahrzeuge ohne Start-Stopp-Funktion	0-N1502	VB [BT]	S
1.6 HDi 110, 1.6 HDi 115, 1.6 HDi 90	04/11-07/15	9HD (DV6C), 9HL (DV6C), 9HP (DV6DTE), 9HR (DV6C)	1560				Rippenanzahl: 6; für Fahrzeuge mit Start-Stopp-Funktion, ☼	0-N2355	VB [DG]	
1.6 HDi 110, 1.6 HDi 115, 1.6 HDi 90	04/11-07/15	9HD (DV6C), 9HL (DV6C), 9HP (DV6DTE), 9HR (DV6C)	1560				für Fahrzeuge mit Start-Stopp-Funktion	0-N2392	VB [BT]	S
1.6 THP 155, 1.6 THP 160, 1.6 THP 200, 1.6 VTi 120	04/11-07/15	5FM (EP6DT), 5FS (EP6C), 5FU (EP6DTX), 5FV (EP6CDT)	1598				für OE: 11 28 7 598 832, 11 28 7 598 833	0-N2237	VB [DG]	
1.6 THP 155, 1.6 THP 200, 1.6 VTi 120	04/11-07/15	5FS (EP6C), 5FU (EP6DTX), 5FV (EP6CDT)	1598					0-N2055	VB [BT]	S
2.0 HDi 135, 2.0 HDi 165	04/11-07/15	RHE (DW10CTED4), RHH (DW10CTED4)	1997					0-N2268	VB [BT]	S
DS5										
1.6 HDi 110	11/11-07/15	9HR (DV6C)	1560	25x141				SK-1728	BTK	
1.6 HDi 110	11/11-07/15	9HR (DV6C)	1560	25x141				SK-1728AQ1	BTKW	
1.6 HDi 115	06/12-07/15	DV6C	1560	25x141				SK-1728	BTK	
1.6 HDi 115	06/12-07/15	DV6C	1560	25x141				SK-1728AQ1	BTKW	
2.0 HDi 135, 2.0 HDi 165, 2.0 HDi 165 Hybrid4 4x4	11/11-07/15	RHC (DW10CTED4), RHD (DW10CB), RHH (DW10CTED4)	1997	25x116				SK-1714	BTK	
2.0 HDi 135, 2.0 HDi 165, 2.0 HDi 165 Hybrid4 4x4	11/11-07/15	RHC (DW10CTED4), RHD (DW10CB), RHH (DW10CTED4)	1997	25x116				SK-1714AQ1	BTKW	
1.6 BlueHdi 120, 1.6 HDi, 1.6 HDi 110	11/11-07/15	9HR (DV6C), BHZ (DV6FC), BHZ (DV6FC)	1560					0-N2382	TB [DG]	
1.6 HDi 110	11/11-07/15	9HR (DV6C)	1560					0-N2224	TB [TE]	
1.6 HDi 115	06/12-07/15	DV6C	1560					0-N2224	TB [TE]	
1.6 HDi 115	06/12-07/15	DV6C	1560					0-N2382	TB [DG]	
2.0 HDi 165, 2.0 HDi 165 Hybrid4 4x4	11/11-07/15	RHC (DW10CTED4), RHH (DW10CTED4)	1997					0-N1334	TB [DG]	
2.0 HDi 165, 2.0 HDi 165 Hybrid4 4x4	11/11-07/15	RHC (DW10CTED4), RHH (DW10CTED4)	1997					0-N2063	TB [TE]	
1.6 HDi 110	11/11-07/15	9HR (DV6C)	1560				Rippenanzahl: 6; für Fahrzeuge mit Start-Stopp-Funktion, ☼	0-N2355	VB [DG]	
1.6 HDi 110	11/11-07/15	9HR (DV6C)	1560				für Fahrzeuge mit Start-Stopp-Funktion	0-N2392	VB [BT]	S
1.6 THP 155, 1.6 THP 200	11/11-07/15	5FU (EP6DTX), 5FV (EP6CDT)	1598					0-N2055	VB [BT]	S
1.6 THP 155, 1.6 THP 200	11/11-07/15	5FU (EP6DTX), 5FV (EP6CDT)	1598				für OE: 11 28 7 598 832, 11 28 7 598 833	0-N2237	VB [DG]	
2.0 HDi 135, 2.0 HDi 135 Hybrid4 4x4, 2.0 HDi 165, 2.0 HDi 165 Hybrid4 4x4	11/11-07/15	RHC (DW10CTED4), RHD (DW10CB), RHH (DW10CTED4)	1997					0-N2268	VB [BT]	S
EVASION (22, U6)										
1.8	05/97-07/02	LFZ (XU7JP)	1761	17x114				SK-1019	BTK	
1.9 TD	11/94-07/02	D8B (XUD9TF), DHX (XUD9TF/BTF)	1905	25.4x136; 10/1996 →				SK-1022	BTK	
1.9 TD	11/94-07/02	D8B (XUD9TF), D8B (XUD9TF), DHX (XUD9TF/BTF)	1905	25.4x136				SK-1022AQ2	BTKW	
1.9 TD	10/95-12/98	D8B (XUD9TF)	1905	25.4x136				SK-1022	BTK	
2.0 16V	05/98-04/00	RFV (XU10J4R)	1998	25x136				SK-1082	BTK	
2.0 16V	05/98-04/00	RFV (XU10J4R)	1998	25x136; Baumuster: Evasion				SK-1082AQ2	BTKW	
2.0 16V	05/98-04/00	RFV (XU10J4R)	1998	25x136; Baumuster: Synergie				SK-1082AQ2	BTKW	
2.0 16V	05/00-07/02	RFN (EW10J4)	1997	25.4x153; 09/2000 →				SK-1482	BTK	
2.0 16V	05/00-07/02	RFN (EW10J4)	1997	25.4x153				SK-1482AQ1	BTKW	
2.0 HDi	08/99-07/02	RHZ (DW10ATED)	1997	25x141; → 04/2000; Orga.→08560; mit Zubehör				SK-1085	BTK	
2.0 HDi 16V	09/99-07/02	RHW (DW10ATED4)	1997	25.4x144				SK-1534AQ1	BTKW	
2.0 HDi, 2.0 HDi 16V	08/99-07/02	RHW (DW10ATED4), RHZ (DW10ATED)	1997	25.4x141; mit Zubehör				SK-1085AQ1	BTKW	
2.0 HDi, 2.0 HDi 16V	08/99-07/02	RHW (DW10ATED4), RHZ (DW10ATED)	1997	25.4x144				SK-1534	BTK	
2.0, 2.0 Turbo C.T.	06/94-07/02	RFU (XU10J2/C), RGX (XU10J2TE)	1998	17x114				SK-1019	BTK	
2.1 TD	05/96-07/02	P8C (XUD11BTE)	2088	25.4x149				SK-1017	BTK	
2.1 TD	05/96-07/02	P8C (XUD11BTE)	2088	25x149				SK-1017AQ1	BTKW	
1.8	02/96-07/02	LFZ (XU7JP)	1761					0-N811	TB [TE]	
1.9 TD	11/94-07/02	D8B (XUD9TF), D8B (XUD9TF), DHX (XUD9TF/BTF)	1905					0-N900	TB [DG]	
1.9 TD	11/94-07/02	D8B (XUD9TF), D8B (XUD9TF), DHX (XUD9TF/BTF)	1905					0-N901	TB [TE]	
2.0 16V	05/98-04/00	RFV (XU10J4R)	1998					0-N862	TB [DG]	
2.0 16V	05/98-04/00	RFV (XU10J4R)	1998					0-N943	TB [TE]	
2.0 16V	05/00-07/02	RFN (EW10J4)	1997					0-N1057	TB [TE]	
2.0 16V	05/00-07/02	RFN (EW10J4)	1997					0-N1065	TB [DG]	
2.0 HDi	08/99-07/02	RHZ (DW10ATED)	1997	Orga.→08560				0-N118P	TB [TE]	

CM³

Art. Nr.



ohne Halter

EVASION (22, U6)

2.0 HDI	08/99-07/02	RHZ (DW10ATED)	1997	Orga.→08560	0-N119P	TB [DG]	
2.0 HDI	08/99-07/02	RHZ (DW10ATED)	1997	Orga.08561→	0-N1381	TB [DG]	
2.0 HDI 16V	09/99-07/02	RHW (DW10ATED4)	1997		0-N118P	TB [TE]	
2.0 HDI 16V	09/99-07/02	RHW (DW10ATED4)	1997		0-N119P	TB [DG]	
2.0, 2.0 Turbo C.T.	06/94-07/02	RFU (XU10J2/C), RGX (XU10J2TE)	1998		0-N811	TB [TE]	
2.1 TD	05/96-07/02	P8C (XUD11BTE)	2088		0-N862	TB [DG]	
2.1 TD	05/96-07/02	P8C (XUD11BTE)	2088		0-N871	TB [TE]	
1.8	02/96-07/02	LFZ (XU7JP)	1761	☼	0-N1484	VB [BT]	S
1.8	05/97-07/02	LFZ (XU7JP)	1761	Orga.→7904	0-N124	VB [TE]	
1.8	05/97-07/02	LFZ (XU7JP)	1761	☼	0-N1405	VB [DG]	
1.8	05/97-07/02	LFZ (XU7JP)	1761	Orga.7905→; ☼	0-N1968	VB [BT]	
1.9 TD	11/94-07/02	D8B (XUD9TF), D8B (XUD9TF), DHX (XUD9TF/BTF)	1905		0-N1320	VB [TE]	
1.9 TD	11/94-07/02	D8B (XUD9TF), D8B (XUD9TF), DHX (XUD9TF/BTF)	1905		0-N931	VB [TE]	
2.0 16V	05/98-04/00	RFV (XU10J4R)	1998	☼	0-N1713	VB [BT]	
2.0 16V	05/98-04/00	RFV (XU10J4R)	1998	☼	0-N1722	VB [DG]	
2.0 16V	05/00-07/02	RFN (EW10J4)	1997		0-N1391	VB [BT]	S
2.0 16V	05/00-07/02	RFN (EW10J4)	1997		0-N1416	VB [DG]	
2.0 HDI	08/99-07/02	RHZ (DW10ATED)	1997		0-N151	VB [DG]	
2.0 HDI 16V	09/99-07/02	RHW (DW10ATED4)	1997	☼	0-N151	VB [DG]	
2.0 HDI, 2.0 HDI 16V	08/99-07/02	RHW (DW10ATED4), RHZ (DW10ATED)	1997		0-N1320	VB [TE]	
2.0 HDI, 2.0 HDI 16V	08/99-07/02	RHW (DW10ATED4), RHZ (DW10ATED)	1997		0-N1493	VB [BT]	S
2.0 HDI, 2.0 HDI 16V	08/99-07/02	RHW (DW10ATED4), RHZ (DW10ATED)	1997	☼	0-N1748	VB [BT]	
2.0, 2.0 Turbo C.T.	06/94-07/02	RFU (XU10J2/C), RGX (XU10J2TE)	1998		0-N124	VB [TE]	
2.0, 2.0 Turbo C.T.	06/94-07/02	RFU (XU10J2/C), RGX (XU10J2TE)	1998	☼	0-N1405	VB [DG]	
2.0, 2.0 Turbo C.T.	06/94-07/02	RFU (XU10J2/C), RGX (XU10J2TE)	1998	☼	0-N1484	VB [BT]	S
2.1 TD	05/96-07/02	P8C (XUD11BTE)	2088		0-N1320	VB [TE]	
2.1 TD	05/96-07/02	P8C (XUD11BTE)	2088		0-N1472	VB [BT]	S
2.1 TD	05/96-07/02	P8C (XUD11BTE)	2088		0-N1747	VB [VD]	
2.1 TD	05/96-07/02	P8C (XUD11BTE)	2088		0-N931	VB [TE]	

GS

1.0	09/70-09/77	G10/612	1015		0-N822	TB [TE]	
1.1	09/77-07/81	G11/631	1129		0-N822	TB [TE]	
1.2, X 2	04/73-07/79	G12/611, G12/612, G12/619	1222		0-N822	TB [TE]	
A 1.3	09/79-07/86	G13/625, G13/646	1299		0-N822	TB [TE]	

GS Break

1.0	07/71-09/77	G10	1015		0-N822	TB [TE]	
1.1, A Spezial	09/77-05/82	G11/631	1129		0-N822	TB [TE]	
A 1.2	04/73-06/79	G12/611, G12/612	1222		0-N822	TB [TE]	
A 1.3	09/79-07/86	G13/625, G13/646	1299		0-N822	TB [TE]	

JUMPER Bus (230P)

1.9 D	01/99-04/02	D9B (XUD9A/U)	1905	25.4x136; Baumuster: 27	SK-1022	BTK	
1.9 D	01/99-04/02	D9B (XUD9A/U)	1905	25.4x136	SK-1022AQ1	BTKW	
1.9 TD	08/94-04/02	D8C (XUD9UTF)	1905	25.4x136; Baumuster: 27, 31	SK-1022	BTK	
1.9 TD, 1.9 TD 4x4	02/94-04/02	D8C (XUD9UTF)	1905	25.4x136; Baumuster: 31	SK-1022	BTK	
1.9 TD, 1.9 TD 4x4	02/94-04/02	D8C (XUD9UTF)	1905	25.4x136; 02/1997 →	SK-1022AQ1	BTKW	
1.9 TD, 1.9 TD 4x4	02/94-04/02	D8C (XUD9UTF)	1905	25.4x136; → 01/1997	SK-1022AQ2	BTKW	
2.0, 2.0 4x4	02/94-04/02	RFW (XU10J2U)	1998	25.4x114	SK-1079	BTK	
2.5 D 4x4, 2.5 TD 4x4	08/96-04/02	T8A (DJ5T), T9A (DJ5)	2446	28x141; Baumuster: 35	SK-1034	BTK	
2.5 D, 2.5 D 4x4, 2.5 TD 4x4	08/94-04/02	T8A (DJ5T), T9A (DJ5)	2446	28x141; Baumuster: 31	SK-1034	BTK	
2.5 D, 2.5 TD	08/94-04/02	T8A (DJ5T), T9A (DJ5)	2446	28x141; 06/1995 →; Nutzlast [kg]: 1800; Baumuster: 35	SK-1034	BTK	
2.5 TD	08/94-04/02	T8A (DJ5T)	2446	28x141; Baumuster: 27, 31	SK-1034	BTK	
2.5 TDi, 2.5 TDi 4x4	12/96-11/00	THX (DJ5TED)	2446	32x147	SK-1087	BTK	
2.8 D	01/99-02/02	8140.63 (F28D)	2798	30x153; 12/2000 →; Nutzlast [kg]: 1800	SK-1046	BTK	
2.8 D	01/99-02/02	8140.63 (F28D)	2798	mit Spanndämpfer, Spannrolle	SK-1679	BTK	
2.8 HDi, 2.8 HDi 4x4	09/00-04/02	8140.43S	2798	30x152	SK-1035	BTK	
2.8 HDi, 2.8 HDi 4x4	09/00-04/02	8140.43S	2798	30x152; 10/2000 →; mit Spanndämpfer, Spannrolle	SK-1680	BTK	
1.9 D, 1.9 TD, 1.9 TD 4x4	02/94-04/02	D8C (XUD9UTF), D9B (XUD9A/U)	1905		0-N900	TB [DG]	
1.9 D, 1.9 TD, 1.9 TD 4x4	02/94-04/02	D8C (XUD9UTF), D9B (XUD9A/U)	1905		0-N901	TB [TE]	
2.0, 2.0 4x4	02/94-04/02	RFW (XU10J2U)	1998		0-N943	TB [TE]	
2.5 D, 2.5 D 4x4, 2.5 TD, 2.5 TD 4x4	08/94-04/02	T8A (DJ5T), T9A (DJ5)	2446		0-N944	TB [TE]	
2.5 D, 2.5 D 4x4, 2.5 TD, 2.5 TD 4x4	08/94-04/02	T8A (DJ5T), T9A (DJ5)	2446		0-N945	TB [DG]	



CM³



Art. Nr.



ohne Halter

JUMPER Bus (230P)							
2.5 TDi, 2.5 TDi 4x4	12/96-11/00	THX (DJ5TED)	2446			0-N214	TB [BT]
2.5 TDi, 2.5 TDi 4x4	12/96-11/00	THX (DJ5TED)	2446			0-N215	TB [TE]
2.8 D, 2.8 HDi, 2.8 HDi 4x4	01/99-04/02	8140.43S, 8140.63 (F28D)	2798			0-N1617	TB [BT]
2.8 D, 2.8 HDi, 2.8 HDi 4x4	01/99-04/02	8140.43S, 8140.63 (F28D)	2798			0-N816	TB [DG]
2.8 HDi, 2.8 HDi 4x4	09/00-04/02	8140.43S	2798			0-N821	TB [DG]
1.9 D, 1.9 TD, 1.9 TD 4x4	02/94-04/02	D8C (XUD9UTF), D9B (XUD9A/U)	1905			0-N931	VB [TE]
2.0, 2.0 4x4	02/94-04/02	RFW (XU10J2U)	1998			0-N124	VB [TE]
2.5 D, 2.5 D 4x4, 2.5 TD, 2.5 TD 4x4	08/94-04/02	T8A (DJ5T), T9A (DJ5)	2446			0-N1749	VB [BT] S
2.5 D, 2.5 D 4x4, 2.5 TD, 2.5 TD 4x4	08/94-04/02	T8A (DJ5T), T9A (DJ5)	2446	ch.→S15236900; ☼		0-N1899	VB [TE]
2.5 D, 2.5 D 4x4, 2.5 TD, 2.5 TD 4x4, 2.5 TDi, 2.5 TDi 4x4	08/94-04/02	T8A (DJ5T), T9A (DJ5), THX (DJ5TED)	2446			0-N095	VB [TE]
2.5 TDi, 2.5 TDi 4x4	12/96-11/00	THX (DJ5TED)	2446			0-N1750	VB [BT]
2.5 TDi, 2.5 TDi 4x4	12/96-11/00	THX (DJ5TED)	2446			0-N1904	VB [TE]
2.5 TDi, 2.5 TDi 4x4	12/96-11/00	THX (DJ5TED)	2446			0-N1975	VB [BT]
2.8 D	01/99-02/02	8140.63 (F28D)	2798	mit Anbaumaterial		0-N1711S	VB [TE]
2.8 HDi, 2.8 HDi 4x4	09/00-04/02	8140.43S	2798			0-N1387	VB [DG]
JUMPER Kasten (230L)							
1.9 D, 1.9 TD	02/94-04/02	D8C (XUD9UTF), D9B (XUD9A/U), DHX (XUD9TF/BTF), DJY (XUD9A)	1905	25.4x136; Baumuster: 27		SK-1022	BTK
1.9 D, 1.9 TD	02/94-04/02	D8C (XUD9UTF), D9B (XUD9A/U)	1905	25.4x136; 02/1997 →		SK-1022AQ1	BTKW
1.9 D, 1.9 TD	02/94-04/02	D8C (XUD9UTF), D9B (XUD9A/U), DHX (XUD9TF/BTF)	1905	25.4x136; → 01/1997		SK-1022AQ2	BTKW
1.9 D, 1.9 TD	03/94-04/02	DHX (XUD9TF/BTF), DJY (XUD9A)	1905	25.4x136		SK-1022AQ1	BTKW
2.0 HDI	11/01-04/02	RHV (DW10UTD)	1997	25x141; mit Zubehör; Baumuster: 31		SK-1085	BTK
2.0 HDI	11/01-04/02	RHV (DW10UTD)	1997	25.4x141; mit Zubehör		SK-1085AQ1	BTKW
2.0, 2.0 4x4	03/94-04/02	RFW (XU10J2U)	1998	25.4x114		SK-1079	BTK
2.5 D	03/94-04/02	T9A (DJ5)	2446	28x141; 03/1995 →; Baumuster: 27		SK-1034	BTK
2.5 D 4x4, 2.5 DT 4x4	10/96-04/02	T9A (DJ5), THZ (DJ5T)	2446	28x141; Baumuster: 31		SK-1034	BTK
2.5 D 4x4, 2.5 DT 4x4	10/96-04/02	T9A (DJ5), THZ (DJ5T)	2446	28x141; Baumuster: 35		SK-1034	BTK
2.5 D, 2.5 TD	03/94-04/02	T8A (DJ5T), T9A (DJ5)	2446	28x141; Nutzlast [kg]: 1800; Baumuster: 31, 35		SK-1034	BTK
2.5 TDi, 2.5 TDi 4x4	12/96-11/00	THX (DJ5TED)	2446	32x147		SK-1087	BTK
2.8 D	01/99-02/02	8140.63 (F28D)	2798	30x153; 12/2000 →; Nutzlast [kg]: 1800		SK-1046	BTK
2.8 D	01/99-02/02	8140.63 (F28D)	2798	mit Spanndämpfer, Spannrolle		SK-1679	BTK
2.8 HDi, 2.8 HDi 4x4	09/00-04/02	8140.43S	2798	30x152		SK-1035	BTK
2.8 HDi, 2.8 HDi 4x4	09/00-04/02	8140.43S	2798	30x152; 10/2000 →; mit Spanndämpfer, Spannrolle		SK-1680	BTK
1.9 D, 1.9 TD	02/94-04/02	D8C (XUD9UTF), D9B (XUD9A/U), DHX (XUD9TF/BTF), DJY (XUD9A)	1905			0-N900	TB [DG]
1.9 D, 1.9 TD	02/94-04/02	D8C (XUD9UTF), D9B (XUD9A/U), DHX (XUD9TF/BTF), DJY (XUD9A)	1905			0-N901	TB [TE]
2.0 HDI	11/01-04/02	RHV (DW10UTD)	1997			0-N118P	TB [TE]
2.0 HDI	11/01-04/02	RHV (DW10UTD)	1997			0-N119P	TB [DG]
2.0, 2.0 4x4	03/94-04/02	RFW (XU10J2U)	1998			0-N943	TB [TE]
2.5 D, 2.5 D 4x4, 2.5 DT 4x4, 2.5 TD	03/94-04/02	T8A (DJ5T), T9A (DJ5), THZ (DJ5T)	2446			0-N944	TB [TE]
2.5 D, 2.5 D 4x4, 2.5 DT 4x4, 2.5 TD	03/94-04/02	T8A (DJ5T), T9A (DJ5), THZ (DJ5T)	2446			0-N945	TB [DG]
2.5 TDi, 2.5 TDi 4x4	12/96-11/00	THX (DJ5TED)	2446			0-N214	TB [BT]
2.5 TDi, 2.5 TDi 4x4	12/96-11/00	THX (DJ5TED)	2446			0-N215	TB [TE]
2.8 D, 2.8 HDi, 2.8 HDi 4x4	01/99-04/02	8140.43S, 8140.63 (F28D)	2798			0-N1617	TB [BT]
2.8 D, 2.8 HDi, 2.8 HDi 4x4	01/99-04/02	8140.43S, 8140.63 (F28D)	2798			0-N816	TB [DG]
2.8 HDi, 2.8 HDi 4x4	09/00-04/02	8140.43S	2798			0-N821	TB [DG]
1.9 D, 1.9 TD	02/94-04/02	D8C (XUD9UTF), D9B (XUD9A/U), DHX (XUD9TF/BTF), DJY (XUD9A)	1905			0-N931	VB [TE]
2.0	03/94-04/02	RFW (XU10J2U)	1998			0-N124	VB [TE]
2.0 HDI	11/01-04/02	RHV (DW10UTD)	1997			0-N1421	VB [DG]
2.0 HDI	11/01-04/02	RHV (DW10UTD)	1997	☼		0-N1471	VB [BT] S
2.0 HDI	11/01-04/02	RHV (DW10UTD)	1997	☼		0-N1493	VB [BT] S
2.0 HDI	11/01-04/02	RHV (DW10UTD)	1997			0-N1748	VB [BT]
2.5 D, 2.5 D 4x4, 2.5 DT 4x4, 2.5 TD	03/94-04/02	T8A (DJ5T), T9A (DJ5), THZ (DJ5T)	2446			0-N1749	VB [BT] S
2.5 D, 2.5 D 4x4, 2.5 DT 4x4, 2.5 TD	03/94-04/02	T8A (DJ5T), T9A (DJ5), THZ (DJ5T)	2446	ch.→S15236900; ☼		0-N1899	VB [TE]
2.5 D, 2.5 D 4x4, 2.5 DT 4x4, 2.5 TD, 2.5 TDi, 2.5 TDi 4x4	03/94-04/02	T8A (DJ5T), T9A (DJ5), THX (DJ5TED), THZ (DJ5T)	2446			0-N095	VB [TE]
2.5 TDi, 2.5 TDi 4x4	12/96-11/00	THX (DJ5TED)	2446			0-N1750	VB [BT]
2.5 TDi, 2.5 TDi 4x4	12/96-11/00	THX (DJ5TED)	2446			0-N1904	VB [TE]
2.5 TDi, 2.5 TDi 4x4	12/96-11/00	THX (DJ5TED)	2446			0-N1975	VB [BT]
2.8 D	01/99-02/02	8140.63 (F28D)	2798	mit Anbaumaterial		0-N1711S	VB [TE]
2.8 HDi, 2.8 HDi 4x4	09/00-04/02	8140.43S	2798			0-N1387	VB [DG]



CM³



Art. Nr.



ohne Halter

JUMPER Pritsche/Fahrgestell (230)

1.9 TD	03/94-04/02	D8C (XUD9UTF), DHX (XUD9TF/BTF)	1905	25.4x136; Baumuster: 31	SK-1022	BTK
1.9 TD	03/94-04/02	D8C (XUD9UTF), DHX (XUD9TF/BTF)	1905	25.4x136; 02/1997 →	SK-1022AQ1	BTKW
1.9 TD	03/94-04/02	D8C (XUD9UTF), DHX (XUD9TF/BTF)	1905	25.4x136; → 01/1997	SK-1022AQ2	BTKW
2.0	03/94-04/02	RFW (XU10J2U)	1998	25.4x114	SK-1079	BTK
2.5 D	03/94-04/02	T9A (DJ5)	2446	28x141; Nutzlast [kg]: 1800; Baumuster: 31, 35	SK-1034	BTK
2.5 D 4x4, 2.5 TD	03/94-04/02	T8A (DJ5T), T9A (DJ5)	2446	28x141; Baumuster: 31, 35	SK-1034	BTK
2.5 TDi, 2.5 TDi 4x4	12/96-04/02	THX (DJ5TED)	2446	32x147	SK-1087	BTK
2.8 D	01/99-02/02	8140.63 (F28D)	2798	30x153; Baumuster: 35	SK-1046	BTK
2.8 D	01/99-02/02	8140.63 (F28D)	2798	mit Spanndämpfer, Spannrolle	SK-1679	BTK
2.8 HDi	09/00-04/02	8140.43S	2798	30x152	SK-1035	BTK
2.8 HDi	09/00-04/02	8140.43S	2798	30x152; 10/2000 →; mit Spanndämpfer, Spannrolle	SK-1680	BTK
2.8 HDi	10/00-01/02	8140.43S	2798	30x152; mit Spanndämpfer, Spannrolle	SK-1680	BTK
1.9 TD	03/94-04/02	D8C (XUD9UTF), DHX (XUD9TF/BTF)	1905		0-N900	TB [DG]
1.9 TD	03/94-04/02	D8C (XUD9UTF), DHX (XUD9TF/BTF)	1905		0-N901	TB [TE]
2.0	03/94-04/02	RFW (XU10J2U)	1998		0-N943	TB [TE]
2.5 D, 2.5 D 4x4, 2.5 TD	03/94-04/02	T8A (DJ5T), T9A (DJ5)	2446		0-N944	TB [TE]
2.5 D, 2.5 D 4x4, 2.5 TD	03/94-04/02	T8A (DJ5T), T9A (DJ5)	2446		0-N945	TB [DG]
2.5 TDi, 2.5 TDi 4x4	12/96-04/02	THX (DJ5TED)	2446		0-N214	TB [BT]
2.5 TDi, 2.5 TDi 4x4	12/96-04/02	THX (DJ5TED)	2446		0-N215	TB [TE]
2.8 D, 2.8 HDi	01/99-04/02	8140.43S, 8140.63 (F28D)	2798		0-N1617	TB [BT]
2.8 D, 2.8 HDi	01/99-04/02	8140.43S, 8140.63 (F28D)	2798		0-N816	TB [DG]
2.8 HDi	09/00-04/02	8140.43S	2798		0-N821	TB [DG]
1.9 TD	03/94-04/02	D8C (XUD9UTF), DHX (XUD9TF/BTF)	1905		0-N931	VB [TE]
2.0	03/94-04/02	RFW (XU10J2U)	1998		0-N124	VB [TE]
2.5 D, 2.5 D 4x4, 2.5 TD	03/94-04/02	T8A (DJ5T), T9A (DJ5)	2446		0-N1749	VB [BT] S
2.5 D, 2.5 D 4x4, 2.5 TD	03/94-04/02	T8A (DJ5T), T9A (DJ5)	2446	ch.→S15236900; ⚡	0-N1899	VB [TE]
2.5 D, 2.5 D 4x4, 2.5 TD, 2.5 TDi, 2.5 TDi 4x4	03/94-04/02	T8A (DJ5T), T9A (DJ5), THX (DJ5TED)	2446		0-N095	VB [TE]
2.5 TDi, 2.5 TDi 4x4	12/96-04/02	THX (DJ5TED)	2446		0-N1750	VB [BT]
2.5 TDi, 2.5 TDi 4x4	12/96-04/02	THX (DJ5TED)	2446		0-N1904	VB [TE]
2.5 TDi, 2.5 TDi 4x4	12/96-04/02	THX (DJ5TED)	2446		0-N1975	VB [BT]
2.8 D	01/99-02/02	8140.63 (F28D)	2798	mit Anbaumaterial	0-N1711S	VB [TE]
2.8 HDi	09/00-04/02	8140.43S	2798		0-N1387	VB [DG]

JUMPER Bus (244, Z_)

2.0 HDi	04/02-	RHV (DW10UTD)	1997	25x141; mit Zubehör	SK-1085	BTK
2.0 HDi	04/02-	RHV (DW10UTD)	1997	25.4x141; mit Zubehör	SK-1085AQ1	BTKW
2.0, 2.0 bivalent	04/02-	XU10J2	1998	25.4x114	SK-1079	BTK
2.2 HDi	04/02-	4HY (DW12UTED)	2179	25.4x143; → 04/2004	SK-1609	BTK
2.2 HDi	04/02-	4HY (DW12UTED)	2179	25.4x143; → 04/2004	SK-1609AQ1	BTKW
2.2 HDi	04/02-	4HY (DW12UTED)	2179	25.4x143; → 04/2004; Baumuster: Jumper	SK-1609AQ1	BTKW
2.2 HDi	04/02-	4HY (DW12UTED)	2179	25x143; 04/2004 → 06/2006	SK-1617	BTK
2.2 HDi	04/02-	4HY (DW12UTED)	2179	25x143; 04/2004 →	SK-1617AQ1	BTKW
2.2 HDi	04/02-	4HY (DW12UTED)	2179	25x143; 04/2004 →; Baumuster: Jumper	SK-1617AQ1	BTKW
2.8 HDi, 2.8 HDi Allrad	04/02-	8140.43S	2798	30x152	SK-1035	BTK
2.8 HDi, 2.8 HDi Allrad	04/02-	8140.43S	2798	30x152; mit Spanndämpfer, Spannrolle	SK-1680	BTK
2.0 HDi	04/02-	RHV (DW10UTD)	1997		0-N118P	TB [TE]
2.0 HDi	04/02-	RHV (DW10UTD)	1997		0-N119P	TB [DG]
2.0, 2.0 bivalent	04/02-	XU10J2	1998		0-N943	TB [TE]
2.2 HDi	04/02-	4HY (DW12UTED)	2179	→ 04/2004	0-N118P	TB [TE]
2.2 HDi	04/02-	4HY (DW12UTED)	2179	→ 04/2004	0-N119P	TB [DG]
2.2 HDi	04/02-	4HY (DW12UTED)	2179	04/2004 →	0-N1357	TB [TE]
2.2 HDi	04/02-	4HY (DW12UTED)	2179	04/2004 →	0-N1358	TB [DG]
2.8 HDi	04/02-	8140.43S	2798		0-N1617	TB [BT]
2.8 HDi, 2.8 HDi Allrad	04/02-	8140.43S	2798		0-N816	TB [DG]
2.8 HDi, 2.8 HDi Allrad	04/02-	8140.43S	2798		0-N821	TB [DG]
2.0 HDi	04/02-	RHV (DW10UTD)	1997	→ 05/2004; ⚡	0-N1421	VB [DG]
2.0 HDi	04/02-	RHV (DW10UTD)	1997	⚡	0-N1421	VB [DG]
2.0 HDi	04/02-	RHV (DW10UTD)	1997	05/2004 →; ⚡, ⚡	0-N1471	VB [BT] S
2.0 HDi	04/02-	RHV (DW10UTD)	1997	→ 05/2004; ⚡	0-N1493	VB [BT] S
2.0 HDi	04/02-	RHV (DW10UTD)	1997	→ 05/2004	0-N1748	VB [BT]
2.0, 2.0 bivalent	04/02-	XU10J2	1998		0-N124	VB [TE]
2.2 HDi	04/02-	4HY (DW12UTED)	2179	→ 04/2004; ⚡	0-N1421	VB [DG]
2.2 HDi	04/02-	4HY (DW12UTED)	2179	⚡	0-N1421	VB [DG]
2.2 HDi	04/02-	4HY (DW12UTED)	2179	04/2004 →; ⚡, ⚡	0-N1471	VB [BT] S



CM³



Art. Nr.



ohne Halter

JUMPER Bus (244, Z_)							
2.2 HDi	04/02-	4HY (DW12UTED)	2179	→ 04/2004; ⚠	0-N1493	VB [BT]	S
2.2 HDi	04/02-	4HY (DW12UTED)	2179	→ 04/2004	0-N1748	VB [BT]	
2.8 HDi, 2.8 HDi Allrad	04/02-	8140.43S	2798		0-N1387	VB [DG]	

JUMPER Kasten (244)							
2.0 HDi	04/02-	DW10TD	1997	25x141; mit Zubehör	SK-1085	BTK	
2.0 HDi	04/02-	RHV (DW10TD), RHV (DW10UTD)	1997	25.4x141; mit Zubehör	SK-1085AQ1	BTKW	
2.0, 2.0 bivalent	04/02-	XU10J2	1998	25.4x114	SK-1079	BTK	
2.2 HDi	04/02-	4HY (DW12UTED)	2179	25.4x143; → 04/2004	SK-1609	BTK	
2.2 HDi	04/02-	4HY (DW12UTED)	2179	25.4x143; → 04/2004	SK-1609AQ1	BTKW	
2.2 HDi	04/02-	4HY (DW12UTED)	2179	25.4x143; → 04/2004; Baumuster: Jumper	SK-1609AQ1	BTKW	
2.2 HDi	04/02-	4HY (DW12UTED)	2179	25x143; 04/2004 → 06/2006	SK-1617	BTK	
2.2 HDi	04/02-	4HY (DW12UTED)	2179	25x143; 04/2004 →	SK-1617AQ1	BTKW	
2.2 HDi	04/02-	4HY (DW12UTED)	2179	25x143; 04/2004 →; Baumuster: Jumper	SK-1617AQ1	BTKW	
2.8 HDi, 2.8 HDi 4x4	04/02-	8140.43N, 8140.43S	2798	30x152	SK-1035	BTK	
2.8 HDi, 2.8 HDi 4x4	04/02-	8140.43N, 8140.43S	2798	30x152; mit Spanndämpfer, Spannrolle	SK-1680	BTK	
2.0 HDi	04/02-	RHV (DW10TD), RHV (DW10UTD)	1997		0-N118P	TB [TE]	
2.0 HDi	04/02-	RHV (DW10TD), RHV (DW10UTD)	1997		0-N119P	TB [DG]	
2.0, 2.0 bivalent	04/02-	XU10J2	1998		0-N943	TB [TE]	
2.2 HDi	04/02-	4HY (DW12UTED)	2179	→ 04/2004	0-N118P	TB [TE]	
2.2 HDi	04/02-	4HY (DW12UTED)	2179	→ 04/2004	0-N119P	TB [DG]	
2.2 HDi	04/02-	4HY (DW12UTED)	2179	04/2004 →	0-N1357	TB [TE]	
2.2 HDi	04/02-	4HY (DW12UTED)	2179	04/2004 →	0-N1358	TB [DG]	
2.8 HDi, 2.8 HDi 4x4	04/02-	8140.43N, 8140.43S	2798		0-N1617	TB [BT]	
2.8 HDi, 2.8 HDi 4x4	04/02-	8140.43N, 8140.43S	2798		0-N816	TB [DG]	
2.8 HDi, 2.8 HDi 4x4	04/02-	8140.43N, 8140.43S	2798		0-N821	TB [DG]	
2.0 HDi	04/02-	RHV (DW10TD), RHV (DW10UTD)	1997	→ 05/2004; ⚠	0-N1421	VB [DG]	
2.0 HDi	04/02-	RHV (DW10TD), RHV (DW10UTD)	1997	⚠	0-N1421	VB [DG]	
2.0 HDi	04/02-	RHV (DW10TD), RHV (DW10UTD)	1997	05/2004 →; ⚠, ⚠	0-N1471	VB [BT]	S
2.0 HDi	04/02-	RHV (DW10TD), RHV (DW10UTD)	1997	→ 05/2004; ⚠	0-N1493	VB [BT]	S
2.0 HDi	04/02-	RHV (DW10TD), RHV (DW10UTD)	1997	→ 05/2004	0-N1748	VB [BT]	
2.0, 2.0 bivalent	04/02-	XU10J2	1998		0-N124	VB [TE]	
2.2 HDi	04/02-	4HY (DW12UTED)	2179	→ 04/2004; ⚠	0-N1421	VB [DG]	
2.2 HDi	04/02-	4HY (DW12UTED)	2179	⚠	0-N1421	VB [DG]	
2.2 HDi	04/02-	4HY (DW12UTED)	2179	04/2004 →; ⚠, ⚠	0-N1471	VB [BT]	S
2.2 HDi	04/02-	4HY (DW12UTED)	2179	→ 04/2004; ⚠	0-N1493	VB [BT]	S
2.2 HDi	04/02-	4HY (DW12UTED)	2179	→ 04/2004	0-N1748	VB [BT]	
2.8 HDi	05/04-	8140.43N	2798	†; mit Anbaumaterial	0-N1386	VB [TE]	
2.8 HDi	05/04-	8140.43N	2798	📄:3980847→; mit Anbaumaterial	0-N1711S	VB [TE]	
2.8 HDi, 2.8 HDi 4x4	04/02-	8140.43S	2798		0-N1387	VB [DG]	

JUMPER Pritsche/Fahrgestell (244)							
2.0 HDi	04/02-	RHV (DW10UTD)	1997	25x141; mit Zubehör	SK-1085	BTK	
2.0 HDi	04/02-	RHV (DW10UTD)	1997	25.4x141; mit Zubehör	SK-1085AQ1	BTKW	
2.2 HDi	02/02-06/06	4HY (DW12UTED)	2179	25x143; 04/2004 →	SK-1617	BTK	
2.2 HDi 16V	04/02-	4HY (DW12UTED)	2179	25x143; 04/2004 → 06/2006	SK-1617	BTK	
2.2 HDi, 2.2 HDi 16V	02/02-06/06	4HY (DW12UTED)	2179	25.4x143; → 04/2004	SK-1609	BTK	
2.2 HDi, 2.2 HDi 16V	02/02-06/06	4HY (DW12UTED)	2179	25.4x143; → 04/2004	SK-1609AQ1	BTKW	
2.2 HDi, 2.2 HDi 16V	02/02-06/06	4HY (DW12UTED)	2179	25x143; 04/2004 →	SK-1617AQ1	BTKW	
2.8 HDi	05/04-	8140.43N	2800	30x152	SK-1035	BTK	
2.8 HDi	05/04-	8140.43N	2800	30x152; mit Spanndämpfer, Spannrolle	SK-1680	BTK	
2.8 HDi, 2.8 HDi 4x4	02/02-06/06	8140.43S, F28TDCR	2798	30x152	SK-1035	BTK	
2.8 HDi, 2.8 HDi 4x4	02/02-06/06	8140.43S, F28TDCR	2798	30x152; mit Spanndämpfer, Spannrolle	SK-1680	BTK	
2.0 HDi	04/02-	RHV (DW10UTD)	1997		0-N118P	TB [TE]	
2.0 HDi	04/02-	RHV (DW10UTD)	1997		0-N119P	TB [DG]	
2.2 HDi, 2.2 HDi 16V	02/02-06/06	4HY (DW12UTED)	2179	→ 04/2004	0-N118P	TB [TE]	
2.2 HDi, 2.2 HDi 16V	02/02-06/06	4HY (DW12UTED)	2179	→ 04/2004	0-N119P	TB [DG]	
2.2 HDi, 2.2 HDi 16V	02/02-06/06	4HY (DW12UTED)	2179	04/2004 →	0-N1357	TB [TE]	
2.2 HDi, 2.2 HDi 16V	02/02-06/06	4HY (DW12UTED)	2179	04/2004 →	0-N1358	TB [DG]	
2.8 HDi	05/04-	8140.43N	2800		0-N1617	TB [BT]	
2.8 HDi	05/04-	8140.43N	2800		0-N816	TB [DG]	
2.8 HDi	05/04-	8140.43N	2800		0-N821	TB [DG]	
2.8 HDi, 2.8 HDi 4x4	02/02-06/06	8140.43S, F28TDCR	2798		0-N1617	TB [BT]	
2.8 HDi, 2.8 HDi 4x4	02/02-06/06	8140.43S, F28TDCR	2798		0-N816	TB [DG]	
2.8 HDi, 2.8 HDi 4x4	02/02-06/06	8140.43S, F28TDCR	2798		0-N821	TB [DG]	
2.0 HDi	04/02-	RHV (DW10UTD)	1997	→ 05/2004; ⚠	0-N1421	VB [DG]	



CM³



Art. Nr.



JUMPER Pritsche/Fahrgestell (244)							
2.0 HDi	04/02-	RHV (DW10UTD)	1997	☼		0-N1421	VB [DG]
2.0 HDi	04/02-	RHV (DW10UTD)	1997	05/2004 →; ☼, ☼		0-N1471	VB [BT] S
2.0 HDi	04/02-	RHV (DW10UTD)	1997	→ 05/2004; ☼		0-N1493	VB [BT] S
2.0 HDi	04/02-	RHV (DW10UTD)	1997	→ 05/2004		0-N1748	VB [BT]
2.2 HDi	02/02-06/06	4HY (DW12UTED)	2179			0-N1421	VB [DG]
2.2 HDi	02/02-06/06	4HY (DW12UTED)	2179	☼		0-N1471	VB [BT] S
2.2 HDi 16V	04/02-	4HY (DW12UTED)	2179	→ 04/2004; ☼		0-N1421	VB [DG]
2.2 HDi 16V	04/02-	4HY (DW12UTED)	2179	☼		0-N1421	VB [DG]
2.2 HDi 16V	04/02-	4HY (DW12UTED)	2179	04/2004 →; ☼, ☼		0-N1471	VB [BT] S
2.2 HDi, 2.2 HDi 16V	02/02-06/06	4HY (DW12UTED)	2179	→ 04/2004; ☼		0-N1493	VB [BT] S
2.2 HDi, 2.2 HDi 16V	02/02-06/06	4HY (DW12UTED)	2179	→ 04/2004		0-N1748	VB [BT]
2.8 HDi	05/04-	8140.43N	2800	☼ → 3980846; ☼; mit Anbaumaterial		0-N1386	VB [TE]
2.8 HDi	05/04-	8140.43N	2800	☼ → 3980847 →; mit Anbaumaterial		0-N1711S	VB [TE]
2.8 HDi, 2.8 HDi 4x4	02/02-06/06	8140.43S, F28TDCR	2798			0-N1387	VB [DG]
JUMPER Bus							
2.2 HDi 100, 2.2 HDi 110, 2.2 HDi 120, 2.2 HDi 130, 2.2 HDi 150	04/06-	4HG (P22DTE), 4HH (P22DTE), 4HJ (P22DTE), 4HU (P22DTE), 4HV (P22DTE)	2198			0-N1392	VB [DG]
2.2 HDi 100, 2.2 HDi 110, 2.2 HDi 120, 2.2 HDi 130, 2.2 HDi 150	04/06-	4HG (P22DTE), 4HH (P22DTE), 4HJ (P22DTE), 4HU (P22DTE), 4HV (P22DTE)	2198	Rippenanzahl: 6		0-N1460	VB [DG]
2.2 HDi 100, 2.2 HDi 110, 2.2 HDi 120, 2.2 HDi 130, 2.2 HDi 150	04/06-	4HG (P22DTE), 4HH (P22DTE), 4HJ (P22DTE), 4HU (P22DTE), 4HV (P22DTE)	2198			0-N2014	VB [BT] S
3.0 HDi 155, 3.0 HDi 160	09/06-	F1CE0481D (F30DT)	2999	mit Anbaumaterial		0-N1711S	VB [TE]
3.0 HDi 155, 3.0 HDi 160	09/06-	F1CE0481D (F30DT)	2999			0-N1714	VB [BT] S
3.0 HDi 180	07/11-	F30DT	2999	mit Anbaumaterial		0-N1711S	VB [TE]
JUMPER Kasten							
2.2 HDi 100, 2.2 HDi 110, 2.2 HDi 120, 2.2 HDi 130, 2.2 HDi 150	04/06-	4HG (P22DTE), 4HH (P22DTE), 4HJ (P22DTE), 4HU (P22DTE), 4HV (P22DTE)	2198			0-N1392	VB [DG]
2.2 HDi 100, 2.2 HDi 110, 2.2 HDi 120, 2.2 HDi 130, 2.2 HDi 150	04/06-	4HG (P22DTE), 4HH (P22DTE), 4HJ (P22DTE), 4HU (P22DTE), 4HV (P22DTE)	2198	Rippenanzahl: 6		0-N1460	VB [DG]
2.2 HDi 100, 2.2 HDi 110, 2.2 HDi 120, 2.2 HDi 130, 2.2 HDi 150	04/06-	4HG (P22DTE), 4HH (P22DTE), 4HJ (P22DTE), 4HU (P22DTE), 4HV (P22DTE)	2198			0-N2014	VB [BT] S
3.0 HDi 145, 3.0 HDi 155, 3.0 HDi 160	09/06-	F1CE0481D (F30DT), F1CE3481N	2999			0-N1714	VB [BT] S
3.0 HDi 145, 3.0 HDi 155, 3.0 HDi 180	07/10-	F30DT	2999	mit Anbaumaterial		0-N1711S	VB [TE]
3.0 HDi 160	09/06-	F1CE0481D (F30DT)	2999	mit Anbaumaterial		0-N1711S	VB [TE]
JUMPER Pritsche/Fahrgestell							
2.2 HDi 100, 2.2 HDi 110, 2.2 HDi 120, 2.2 HDi 130, 2.2 HDi 150	04/06-	4HG (P22DTE), 4HH (P22DTE), 4HJ (P22DTE), 4HU (P22DTE), 4HV (P22DTE)	2198			0-N1392	VB [DG]
2.2 HDi 100, 2.2 HDi 110, 2.2 HDi 120, 2.2 HDi 130, 2.2 HDi 150	04/06-	4HG (P22DTE), 4HH (P22DTE), 4HJ (P22DTE), 4HU (P22DTE), 4HV (P22DTE)	2198	Rippenanzahl: 6		0-N1460	VB [DG]
2.2 HDi 100, 2.2 HDi 110, 2.2 HDi 120, 2.2 HDi 130, 2.2 HDi 150	04/06-	4HG (P22DTE), 4HH (P22DTE), 4HJ (P22DTE), 4HU (P22DTE), 4HV (P22DTE)	2198			0-N2014	VB [BT] S
3.0 HDi 145, 3.0 HDi 160	09/06-	F1CE0481D (F30DT), F1CE3481N	2999			0-N1714	VB [BT] S
3.0 HDi 145, 3.0 HDi 180	07/10-	F30DT	2999	mit Anbaumaterial		0-N1711S	VB [TE]
3.0 HDi 160	09/06-	F1CE0481D (F30DT)	2999	mit Anbaumaterial		0-N1711S	VB [TE]
JUMPY							
1.6 HDi 90	01/07-	9HM (DV6UC), 9HU (DV6UTED4)	1560	25x137; Baumuster: Dispatch		SK-1424	BTK
1.6 HDi 90	01/07-	9HM (DV6UC), 9HU (DV6UTED4)	1560	25x137; Baumuster: Jumpy		SK-1424	BTK
1.6 HDi 90	01/07-	9HM (DV6UC), 9HU (DV6UTED4)	1560	25x137; Baumuster: Dispatch		SK-1424AQ1	BTKW
1.6 HDi 90	01/07-	9HM (DV6UC), 9HU (DV6UTED4)	1560	25x137; Baumuster: Jumpy		SK-1424AQ1	BTKW
1.6 HDi 90 8V	01/07-	9HH (DV6DUM), 9HM (DV6UC)	1560	25x141		SK-1728	BTK
1.6 HDi 90 8V	01/07-	9HH (DV6DUM), 9HM (DV6UC)	1560	25x141		SK-1728AQ1	BTKW
2.0 HDi 120, 2.0 HDi 140	01/07-	RHK (DW10UTED4), RHR (DW10BTED4)	1997	25.4x116		SK-1594	BTK
2.0 HDi 120, 2.0 HDi 140	01/07-	RHK (DW10UTED4), RHR (DW10BTED4)	1997	25.4x116; Baumuster: Dispatch		SK-1594AQ1	BTKW
2.0 HDi 120, 2.0 HDi 140	01/07-	RHK (DW10UTED4), RHR (DW10BTED4)	1997	25.4x116; Baumuster: Jumpy		SK-1594AQ1	BTKW
2.0 HDi 125, 2.0 HDi 140, 2.0 HDi 165, 2.0 HDi 95	01/07-	AHY (DW10CE), AHZ (DW10CD), RHH (DW10CTED4), RHR (DW10BTED4)	1997	25x116		SK-1714	BTK
2.0 HDi 125, 2.0 HDi 165, 2.0 HDi 95	07/10-	AHY (DW10CE), AHZ (DW10CD), RHH (DW10CTED4)	1997	25x116		SK-1714AQ1	BTKW
2.0 i	01/07-	RFH (EW10A)	1997	25x153		SK-1600	BTK
2.0 i	01/07-	RFH (EW10A)	1997	25x153; Baumuster: Dispatch		SK-1600AQ1	BTKW
2.0 i	01/07-	RFH (EW10A)	1997	25x153; Baumuster: Jumpy		SK-1600AQ1	BTKW
1.6 HDi 90	01/07-	9HM (DV6UC), 9HU (DV6UTED4)	1560			0-N1062	TB [TE]
1.6 HDi 90	01/07-	9HM (DV6UC), 9HU (DV6UTED4)	1560			0-N1066	TB [DG]
1.6 HDi 90 8V	01/07-	9HH (DV6DUM), 9HM (DV6UC)	1560			0-N2224	TB [TE]
1.6 HDi 90 8V	01/07-	9HH (DV6DUM), 9HM (DV6UC)	1560			0-N2382	TB [DG]



CM³



Art. Nr.



ohne Halter

JUMPY							
2.0 HDi 120, 2.0 HDi 125, 2.0 HDi 140, 2.0 HDi 165, 2.0 HDi 95	01/07-	AHY (DW10CE), AHZ (DW10CD), RHH (DW10CTED4), RHK (DW10UTED4), RHR (DW10BTED4)	1997			0-N1334	TB [DG]
2.0 HDi 125, 2.0 HDi 165, 2.0 HDi 95	07/10-	AHY (DW10CE), AHZ (DW10CD), RHH (DW10CTED4)	1997			0-N2063	TB [TE]
2.0 i	01/07-	RFH (EW10A)	1997			0-N1065	TB [DG]
2.0 i	01/07-	EW10A	1997			0-N1343	TB [TE]
1.6 HDi 90	01/07-	9HM (DV6UC), 9HU (DV6UTED4)	1560			0-N1808	VB [BT] S
1.6 HDi 90, 1.6 HDi 90 8V	01/07-	9HH (DV6DUM), 9HM (DV6UC), 9HM (DV6UC), 9HU (DV6UTED4)	1560			0-N1807	VB [DG]
2.0 HDi 120, 2.0 HDi 140	01/07-	RHK (DW10UTED4), RHR (DW10BTED4)	1997			0-N1327	VB [BT]
2.0 HDi 120, 2.0 HDi 140	01/07-	RHK (DW10UTED4), RHR (DW10BTED4)	1997	Orga. → 11193		0-N2037	VB [BT] S
2.0 HDi 120, 2.0 HDi 140	01/07-	RHK (DW10UTED4), RHR (DW10BTED4)	1997	Orga. 11194 →		0-N2046	VB [BT] S
2.0 HDi 125, 2.0 HDi 165, 2.0 HDi 95	07/10-	AHY (DW10CE), AHZ (DW10CD), RHH (DW10CTED4)	1997			0-N2268	VB [BT] S
2.0 i	01/07-	RFH (EW10A)	1997			0-N1840	VB [BT] S
JUMPY (U6U)							
1.6	10/95-08/00	1580 SPI, 220 A2.000, 220 A2.000	1581	15x138		SK-1031	BTK
1.9 D 70	04/98-	WJY (DW8B), WJZ (DW8)	1868	25.4x140		SK-1086	BTK
1.9 D 70	04/98-	DW8	1868	25.4x140		SK-1086AQ1	BTKW
1.9 D, 1.9 TD	10/95-04/98	D8B (XUD9TF), D9B (XUD9A/U), DHX (XUD9TF/BTF)	1905	25.4x136		SK-1022	BTK
1.9 D, 1.9 TD	10/95-04/98	D8B (XUD9TF), D9B (XUD9A/U), DHX (XUD9TF/BTF)	1905	25.4x136		SK-1022AQ2	BTKW
2.0 HDi 110	03/00-	RHZ (DW10ATED)	1997	25x141; → 04/2000; Orga. → 08560; mit Zubehör		SK-1085	BTK
2.0 HDi 110	03/00-	RHZ (DW10ATED)	1997	25x141; 12/2003 →; mit Zubehör		SK-1085	BTK
2.0 HDi 110	03/00-	RHZ (DW10ATED)	1997	25.4x141; mit Zubehör		SK-1085AQ1	BTKW
2.0 HDi 110	03/00-	RHW (DW10ATED4)	1997	25.4x144; für Fahrzeuge ohne Rußpartikelfilter; → 04/2004; Orga. → 10010		SK-1534	BTK
2.0 HDi 110	03/00-	RHW (DW10ATED4)	1997	25.4x144; → 04/2004; Orga. → 10010		SK-1534AQ1	BTKW
2.0 HDi 110	03/00-	RHW (DW10ATED4)	1997	25x144; für Fahrzeuge ohne Rußpartikelfilter; 04/2004 →; Orga. 10011 →		SK-1616	BTK
2.0 HDi 110, 2.0 HDi 95	10/99-	RHX (DW10BTED), RHZ (DW10ATED)	1997	25.4x144; Orga. → 10010		SK-1534	BTK
2.0 HDi 110, 2.0 HDi 95	10/99-	RHX (DW10BTED), RHZ (DW10ATED)	1997	25.4x144; Orga. → 10010		SK-1534AQ1	BTKW
2.0 HDi 95	10/99-	RHX (DW10BTED)	1997	25x141; Orga. → 09867; mit Zubehör		SK-1085	BTK
2.0 HDi 95	10/99-	RHX (DW10BTED)	1997	25x141; Orga. 08561 →; mit Zubehör		SK-1085	BTK
2.0 HDi 95	10/99-	RHX (DW10BTED)	1997	25.4x141; Orga. 09868 →; mit Zubehör		SK-1085AQ1	BTKW
2.0, 2.0 i 16V	03/00-12/06	RFN (EW10J4)	1997	25.4x153		SK-1482	BTK
2.0, 2.0 i 16V	03/00-12/06	RFN	1997	25.4x153		SK-1482AQ1	BTKW
1.6	10/95-08/00	1580 SPI, 220 A2.000, 220 A2.000	1581			0-N822	TB [TE]
1.9 D 70	04/98-	WJY (DW8B), WJZ (DW8)	1868			0-N118P	TB [TE]
1.9 D 70	04/98-	WJY (DW8B), WJZ (DW8)	1868			0-N1381	TB [DG]
1.9 D, 1.9 TD	10/95-04/98	D8B (XUD9TF), D9B (XUD9A/U), DHX (XUD9TF/BTF)	1905			0-N900	TB [DG]
1.9 D, 1.9 TD	10/95-04/98	D8B (XUD9TF), D9B (XUD9A/U), DHX (XUD9TF/BTF)	1905			0-N901	TB [TE]
2.0	04/00-12/06	RFN (EW10J4)	1997			0-N1057	TB [TE]
2.0	04/00-12/06	RFN (EW10J4)	1997			0-N1065	TB [DG]
2.0 HDi 110	03/00-	RHZ (DW10ATED)	1997	Orga. → 08560		0-N118P	TB [TE]
2.0 HDi 110	03/00-	RHW (DW10ATED4)	1997	Orga. → 10010		0-N118P	TB [TE]
2.0 HDi 110	03/00-	RHZ (DW10ATED)	1997	Orga. → 08560		0-N119P	TB [DG]
2.0 HDi 110	03/00-	RHW (DW10ATED4)	1997	Orga. → 10010		0-N119P	TB [DG]
2.0 HDi 110	03/00-	RHW (DW10ATED4)	1997	Orga. 10011 →		0-N1357	TB [TE]
2.0 HDi 110	03/00-	RHW (DW10ATED4)	1997	Orga. 10011 →		0-N1358	TB [DG]
2.0 HDi 110	03/00-	RHZ (DW10ATED)	1997	Orga. 08561 →		0-N1381	TB [DG]
2.0 HDi 95	10/99-	RHX (DW10BTED)	1997	Orga. 09868 →		0-N118P	TB [TE]
2.0 HDi 95	10/99-	RHX (DW10BTED)	1997	Orga. → 09867		0-N119P	TB [DG]
2.0 HDi 95	10/99-	RHX (DW10BTED)	1997	Orga. 09868 →		0-N1381	TB [DG]
2.0 i 16V	03/00-	RFN	1997			0-N1057	TB [TE]
2.0 i 16V	03/00-	RFN	1997			0-N1065	TB [DG]
2.2 HDi	12/03-10/06		2179	→ 04/2004		0-N118P	TB [TE]
2.2 HDi	12/03-10/06		2179	→ 04/2004		0-N119P	TB [DG]
1.9 D 70	04/98-	WJY (DW8B), WJZ (DW8)	1868	Orga. 08375 →; für Fahrzeuge mit Servolenkung		0-N1309	VB [DG]
1.9 D 70	04/98-	WJY (DW8B), WJZ (DW8)	1868			0-N1320	VB [TE]
1.9 D 70	04/98-	WJY (DW8B), WJZ (DW8)	1868	Orga. → 08374		0-N1455	VB [TE]
1.9 D 70	04/98-	WJY (DW8B), WJZ (DW8)	1868	Orga. 08375 →; für Fahrzeuge mit Servolenkung,		0-N1471	VB [BT] S

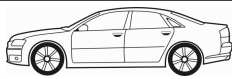

CM³



Art. Nr.



ohne Halter

JUMPY (U6U)							
1.9 D 70	04/98-	WJY (DW8B), WJZ (DW8)	1868	Orga.→09520; ⚠, für Fahrzeuge mit Servolenkung	0-N1472	VB [BT]	S
1.9 D 70	04/98-	WJY (DW8B), WJZ (DW8)	1868		0-N1545	VB [DG]	
1.9 D 70	04/98-	WJY (DW8B), WJZ (DW8)	1868	⚠, ⚠, für Fahrzeuge ohne Servolenkung	0-N1681	VB [BT]	
1.9 D 70	04/98-	WJY (DW8B), WJZ (DW8)	1868	Orga.→09520; ⚠, für Fahrzeuge mit Servolenkung	0-N1747	VB [VD]	
1.9 D 70	04/98-	WJY (DW8B), WJZ (DW8)	1868	Orga.09521→; ⚠, für Fahrzeuge mit Servolenkung	0-N1945	VB [BT]	S
1.9 D, 1.9 TD	10/95-04/98	D8B (XUD9TF), D9B (XUD9A/U), DHX (XUD9TF/BTF)	1905		0-N1320	VB [TE]	
1.9 D, 1.9 TD	10/95-04/98	D8B (XUD9TF), D9B (XUD9A/U), DHX (XUD9TF/BTF)	1905		0-N1472	VB [BT]	S
1.9 D, 1.9 TD	10/95-04/98	D8B (XUD9TF), D9B (XUD9A/U), DHX (XUD9TF/BTF)	1905		0-N1747	VB [VD]	
1.9 D, 1.9 TD	10/95-04/98	D8B (XUD9TF), D9B (XUD9A/U), DHX (XUD9TF/BTF)	1905		0-N931	VB [TE]	
2.0	04/00-12/06	RFN (EW10J4)	1997		0-N1391	VB [BT]	S
2.0	04/00-12/06	RFN (EW10J4)	1997	Orga.→10614	0-N1416	VB [DG]	
2.0	04/00-12/06	RFN (EW10J4)	1997	Orga.10614→	0-N2276	VB [DG]	
2.0 HDi 110, 2.0 HDi 95	10/99-	RHW (DW10ATED4), RHX (DW10BTED), RHZ (DW10ATED)	1997		0-N1320	VB [TE]	
2.0 HDi 110, 2.0 HDi 95	10/99-	RHX (DW10BTED), RHZ (DW10ATED)	1997		0-N1493	VB [BT]	S
2.0 HDi 110, 2.0 HDi 95	10/99-	RHX (DW10BTED), RHZ (DW10ATED)	1997	⚠	0-N151	VB [DG]	
2.0 HDi 110, 2.0 HDi 95	10/99-	RHX (DW10BTED), RHZ (DW10ATED)	1997	⚠	0-N1748	VB [BT]	
2.0 i 16V	03/00-	RFN	1997		0-N1391	VB [BT]	S
2.0 i 16V	03/00-	RFN	1997	Orga.→10614	0-N1416	VB [DG]	
2.2 HDi	12/03-10/06		2179		0-N1493	VB [BT]	S
2.2 HDi	12/03-10/06		2179		0-N1748	VB [BT]	

JUMPY Kasten (BS_, BT_, BY_, BZ_)							
1.6, 1.6 i	10/95-08/00	1580 SPI, 220 A2.000, 220 A2.000	1581	15x138	SK-1031	BTK	
1.9 D 70	04/98-	WJY (DW8B), WJZ (DW8)	1868	25.4x140	SK-1086	BTK	
1.9 D 70	04/98-	DW8	1868	25.4x140	SK-1086AQ1	BTKW	
1.9 D, 1.9 DT, 1.9 TD	10/95-08/00	D9B (XUD9A/U), DHX (XUD9TF/BTF)	1905	25.4x136	SK-1022	BTK	
1.9 TD	10/95-	DHX (XUD9TF/BTF)	1905	25.4x136	SK-1022AQ2	BTKW	
2.0 HDi 110	01/02-	RHZ (DW10ATED)	1997	25x141; 12/2003 →; mit Zubehör	SK-1085	BTK	
2.0 HDi 110	01/02-	RHZ (DW10ATED)	1997	25.4x141; mit Zubehör	SK-1085AQ1	BTKW	
2.0 HDi 110	01/02-	RHW (DW10ATED4)	1997	25.4x144; → 04/2004; Orga.→10010	SK-1534	BTK	
2.0 HDi 110	01/02-	RHW (DW10ATED4)	1997	25x144; 04/2004 →; Orga.10011→	SK-1616	BTK	
2.0 HDi 95	10/99-	RHX (DW10BTED)	1997	25x141; Orga.→09867; mit Zubehör	SK-1085	BTK	
2.0 HDi 95	10/99-	RHX (DW10BTED)	1997	25x141; Orga.08561→; mit Zubehör	SK-1085	BTK	
2.0 HDi 95	10/99-	RHX (DW10BTED)	1997	25.4x141; Orga.09868→; mit Zubehör	SK-1085AQ1	BTKW	
2.0 HDi 95	10/99-	RHX (DW10BTED)	1997	25.4x144; Orga.→10010	SK-1534	BTK	
2.0 HDi 95	10/99-	RHX (DW10BTED)	1997	25.4x144; Orga.→10010	SK-1534AQ1	BTKW	
2.0 i 16V	03/00-	RFN (EW10J4)	1997	25.4x153	SK-1482	BTK	
2.0 i 16V	03/00-	RFN	1997	25.4x153	SK-1482AQ1	BTKW	
1.6, 1.6 i	10/95-08/00	1580 SPI, 220 A2.000, 220 A2.000	1581		0-N822	TB [TE]	
1.9 D 70	04/98-	WJY (DW8B), WJZ (DW8)	1868		0-N118P	TB [TE]	
1.9 D 70	04/98-	WJY (DW8B), WJZ (DW8)	1868		0-N1381	TB [DG]	
1.9 D, 1.9 DT, 1.9 TD	10/95-08/00	D9B (XUD9A/U), DHX (XUD9TF/BTF)	1905		0-N900	TB [DG]	
1.9 D, 1.9 DT, 1.9 TD	10/95-08/00	D9B (XUD9A/U), DHX (XUD9TF/BTF)	1905		0-N901	TB [TE]	
2.0 HDi 110	01/02-	RHZ (DW10ATED)	1997	Orga.→08560	0-N118P	TB [TE]	
2.0 HDi 110	01/02-	RHW (DW10ATED4)	1997	Orga.→10010	0-N118P	TB [TE]	
2.0 HDi 110	01/02-	RHZ (DW10ATED)	1997	Orga.→08560	0-N119P	TB [DG]	
2.0 HDi 110	01/02-	RHW (DW10ATED4)	1997	Orga.→10010	0-N119P	TB [DG]	
2.0 HDi 110	01/02-	RHW (DW10ATED4)	1997	Orga.10011→	0-N1357	TB [TE]	
2.0 HDi 110	01/02-	RHW (DW10ATED4)	1997	Orga.10011→	0-N1358	TB [DG]	
2.0 HDi 110	01/02-	RHZ (DW10ATED)	1997	Orga.08561→	0-N1381	TB [DG]	
2.0 HDi 95	10/99-	RHX (DW10BTED)	1997	Orga.09868→	0-N118P	TB [TE]	
2.0 HDi 95	10/99-	RHX (DW10BTED)	1997	Orga.→09867	0-N119P	TB [DG]	
2.0 HDi 95	10/99-	RHX (DW10BTED)	1997	Orga.09868→	0-N1381	TB [DG]	
2.0 i 16V	03/00-	RFN	1997		0-N1057	TB [TE]	
2.0 i 16V	03/00-	RFN	1997		0-N1065	TB [DG]	
2.2 HDi	12/03-10/06		2179	→ 04/2004	0-N118P	TB [TE]	
2.2 HDi	12/03-10/06		2179	→ 04/2004	0-N119P	TB [DG]	
1.9 D	10/95-08/98	D9B	1905		0-N1320	VB [TE]	
1.9 D 70	04/98-	WJY (DW8B), WJZ (DW8)	1868	Orga.08375→; für Fahrzeuge mit Servolenkung	0-N1309	VB [DG]	



CM³



Art. Nr.



ohne Halter

JUMPY Kasten (BS_, BT_, BY_, BZ_)							
1.9 D 70	04/98-	WJY (DW8B), WJZ (DW8)	1868		0-N1320	VB [TE]	
1.9 D 70	04/98-	WJY (DW8B), WJZ (DW8)	1868	Orga.→08374	0-N1455	VB [TE]	
1.9 D 70	04/98-	WJY (DW8B), WJZ (DW8)	1868	Orga.08375→; für Fahrzeuge mit Servolenkung, ☼	0-N1471	VB [BT]	S
1.9 D 70	04/98-	WJY (DW8B), WJZ (DW8)	1868	Orga.→09520; ☼, für Fahrzeuge mit Servolenkung	0-N1472	VB [BT]	S
1.9 D 70	04/98-	WJY (DW8B), WJZ (DW8)	1868		0-N1545	VB [DG]	
1.9 D 70	04/98-	WJY (DW8B), WJZ (DW8)	1868	☼, ☼, für Fahrzeuge ohne Servolenkung	0-N1681	VB [BT]	
1.9 D 70	04/98-	WJY (DW8B), WJZ (DW8)	1868	Orga.→09520; ☼, für Fahrzeuge mit Servolenkung	0-N1747	VB [VD]	
1.9 D 70	04/98-	WJY (DW8B), WJZ (DW8)	1868	Orga.09521→; ☼, für Fahrzeuge mit Servolenkung	0-N1945	VB [BT]	S
1.9 D, 1.9 DT, 1.9 TD	10/95-08/00	D9B (XUD9A/U), DHX (XUD9TF/BTF)	1905		0-N1472	VB [BT]	S
1.9 D, 1.9 DT, 1.9 TD	10/95-08/00	D9B (XUD9A/U), DHX (XUD9TF/BTF)	1905		0-N1747	VB [VD]	
1.9 DT	10/95-08/00	XUD9TE	1905		0-N1320	VB [TE]	
1.9 TD	10/95-	DHX (XUD9TF/BTF)	1905		0-N1320	VB [TE]	
1.9 TD	10/95-	DHX (XUD9TF/BTF)	1905		0-N931	VB [TE]	
2.0 HDi 110, 2.0 HDi 95	10/99-	RHW (DW10ATED4), RHX (DW10BTED), RHZ (DW10ATED)	1997		0-N1320	VB [TE]	
2.0 HDi 110, 2.0 HDi 95	10/99-	RHX (DW10BTED), RHZ (DW10ATED)	1997		0-N1493	VB [BT]	S
2.0 HDi 110, 2.0 HDi 95	10/99-	RHX (DW10BTED), RHZ (DW10ATED)	1997	☼	0-N151	VB [DG]	
2.0 HDi 110, 2.0 HDi 95	10/99-	RHX (DW10BTED), RHZ (DW10ATED)	1997	☼	0-N1748	VB [BT]	
2.0 i 16V	03/00-	RFN	1997		0-N1391	VB [BT]	S
2.0 i 16V	03/00-	RFN	1997	Orga.→10614	0-N1416	VB [DG]	
2.0 i 16V	03/00-	RFN	1997	Orga.10614→	0-N2276	VB [DG]	
2.2 HDi	12/03-10/06		2179		0-N1493	VB [BT]	S
2.2 HDi	12/03-10/06		2179		0-N1748	VB [BT]	
JUMPY Pritsche/Fahrgestell (BU_, BV_, BW_, BX_)							
1.9 TD	10/99-	D8B (XUD9TF)	1905	25.4x136	SK-1022	BTK	
1.9 TD	10/99-	D8B (XUD9TF)	1905	25.4x136	SK-1022AQ2	BTKW	
2.0	12/03-10/06	RFN (EW10J4)	1997	25.4x153	SK-1482	BTK	
2.0	12/03-10/06	RFN	1997	25.4x153	SK-1482AQ1	BTKW	
2.0 HDi 110	12/03-10/06	RHW (DW10ATED4)	1997	25.4x144; für Fahrzeuge ohne Rußpartikelfilter; → 04/2004; Orga.→10010	SK-1534	BTK	
2.0 HDi 110	12/03-10/06	RHW (DW10ATED4)	1997	25x144; für Fahrzeuge ohne Rußpartikelfilter; 04/2004 →; Orga.10011→	SK-1616	BTK	
2.0 HDi 110 16V	12/03-10/06	RHZ (DW10ATED)	1997	25x141; mit Zubehör	SK-1085	BTK	
2.0 HDi 110 16V	12/03-10/06	RHZ (DW10ATED)	1997	25.4x141; mit Zubehör	SK-1085AQ1	BTKW	
2.0 HDi 95	10/99-	RHX (DW10BTED)	1997	25x141; Orga.→09867; mit Zubehör	SK-1085	BTK	
2.0 HDi 95	10/99-	RHX (DW10BTED)	1997	25x141; Orga.08561→; mit Zubehör	SK-1085	BTK	
2.0 HDi 95	10/99-	RHX (DW10BTED)	1997	25.4x141; Orga.09868→; mit Zubehör	SK-1085AQ1	BTKW	
2.0 HDi 95	10/99-	RHX (DW10BTED)	1997	25.4x144; Orga.→10010	SK-1534	BTK	
2.0 HDi 95	10/99-	RHX (DW10BTED)	1997	25.4x144; Orga.→10010	SK-1534AQ1	BTKW	
1.9 TD	10/99-	D8B (XUD9TF)	1905		0-N900	TB [DG]	
1.9 TD	10/99-	D8B (XUD9TF)	1905		0-N901	TB [TE]	
2.0	12/03-10/06	RFN (EW10J4)	1997		0-N1057	TB [TE]	
2.0	12/03-10/06	RFN (EW10J4)	1997		0-N1065	TB [DG]	
2.0 HDi 110	12/03-10/06	RHW (DW10ATED4)	1997	Orga.→10010	0-N118P	TB [TE]	
2.0 HDi 110	12/03-10/06	RHW (DW10ATED4)	1997	Orga.→10010	0-N119P	TB [DG]	
2.0 HDi 110	12/03-10/06	RHW (DW10ATED4)	1997	Orga.10011→	0-N1357	TB [TE]	
2.0 HDi 110	12/03-10/06	RHW (DW10ATED4)	1997	Orga.10011→	0-N1358	TB [DG]	
2.0 HDi 110 16V	12/03-10/06	RHZ (DW10ATED)	1997	Orga.→08560	0-N118P	TB [TE]	
2.0 HDi 110 16V	12/03-10/06	RHZ (DW10ATED)	1997	Orga.→08560	0-N119P	TB [DG]	
2.0 HDi 110 16V	12/03-10/06	RHZ (DW10ATED)	1997	Orga.08561→	0-N1381	TB [DG]	
2.0 HDi 95	10/99-	RHX (DW10BTED)	1997	Orga.09868→	0-N118P	TB [TE]	
2.0 HDi 95	10/99-	RHX (DW10BTED)	1997	Orga.→09867	0-N119P	TB [DG]	
2.0 HDi 95	10/99-	RHX (DW10BTED)	1997	Orga.09868→	0-N1381	TB [DG]	
1.9 TD	10/99-	D8B (XUD9TF)	1905		0-N1320	VB [TE]	
1.9 TD	10/99-	D8B (XUD9TF)	1905		0-N1472	VB [BT]	S
1.9 TD	10/99-	D8B (XUD9TF)	1905		0-N1747	VB [VD]	
1.9 TD	10/99-	D8B (XUD9TF)	1905		0-N931	VB [TE]	
2.0	12/03-10/06	RFN (EW10J4)	1997	Orga.→10614	0-N1416	VB [DG]	
2.0	12/03-10/06	RFN (EW10J4)	1997	Orga.10614→	0-N2276	VB [DG]	
2.0 HDi 110 16V, 2.0 HDi 95	10/99-10/06	RHX (DW10BTED), RHZ (DW10ATED)	1997		0-N1493	VB [BT]	S
2.0 HDi 110 16V, 2.0 HDi 95	10/99-10/06	RHX (DW10BTED), RHZ (DW10ATED)	1997	☼	0-N151	VB [DG]	
2.0 HDi 110 16V, 2.0 HDi 95	10/99-10/06	RHX (DW10BTED), RHZ (DW10ATED)	1997	☼	0-N1748	VB [BT]	



CM³



Art. Nr.



JUMPY Pritsche/Fahrgestell (BU_, BV_, BW_, BX_)

2.0 HDi 110, 2.0 HDi 110 16V, 2.0 HDi 95	10/99-10/06	RHW (DW10ATED4), RHX (DW10BTED), RHZ (DW10ATED)	1997			0-N1320	VB [TE]	
--	-------------	---	------	--	--	----------------	---------	--

JUMPY Kasten

1.6 HDi 90	01/07-	9HU (DV6UTED4)	1560	25x137; Baumuster: Dispatch		SK-1424	BTK	
1.6 HDi 90	01/07-	9HU (DV6UTED4)	1560	25x137; Baumuster: Jumpy		SK-1424	BTK	
1.6 HDi 90	01/07-	9HU (DV6UTED4)	1560	25x137; Baumuster: Dispatch		SK-1424AQ1	BTKW	
1.6 HDi 90	01/07-	9HU (DV6UTED4)	1560	25x137; Baumuster: Jumpy		SK-1424AQ1	BTKW	
1.6 HDi 90 8V	01/07-	9HH (DV6DUM), 9HM (DV6UC)	1560	25x141; Baumuster: Dispatch		SK-1728	BTK	
1.6 HDi 90 8V	01/07-	9HH (DV6DUM), 9HM (DV6UC)	1560	25x141; Baumuster: Jumpy		SK-1728	BTK	
1.6 HDi 90 8V	01/07-	9HH (DV6DUM), 9HM (DV6UC)	1560	25x141; Baumuster: Dispatch		SK-1728AQ1	BTKW	
1.6 HDi 90 8V	01/07-	9HH (DV6DUM), 9HM (DV6UC)	1560	25x141; Baumuster: Jumpy		SK-1728AQ1	BTKW	
2.0 HDi 120 4x4	01/10-	RHK (DW10UTED4)	1997	25.4x116		SK-1594AQ1	BTKW	
2.0 HDi 120, 2.0 HDi 120 4x4, 2.0 HDi 140	01/07-	RHK (DW10UTED4), RHR (DW10BTED4)	1997	25.4x116		SK-1594	BTK	
2.0 HDi 120, 2.0 HDi 140	01/07-	RHK (DW10UTED4), RHR (DW10BTED4)	1997	25.4x116; Baumuster: Dispatch		SK-1594AQ1	BTKW	
2.0 HDi 120, 2.0 HDi 140	01/07-	RHK (DW10UTED4), RHR (DW10BTED4)	1997	25.4x116; Baumuster: Jumpy		SK-1594AQ1	BTKW	
2.0 HDi 125, 2.0 HDi 140, 2.0 HDi 165, 2.0 HDi 95	01/07-	AHY (DW10CE), AHZ (DW10CD), RHH (DW10CTED4), RHR (DW10BTED4)	1997	25x116		SK-1714	BTK	
2.0 HDi 125, 2.0 HDi 165, 2.0 HDi 95	07/10-	AHY (DW10CE), AHZ (DW10CD), RHH (DW10CTED4)	1997	25x116		SK-1714AQ1	BTKW	
2.0 i	01/07-	RFH (EW10A)	1997	25x153		SK-1600	BTK	
2.0 i	01/07-	RFH (EW10A)	1997	25x153; Baumuster: Dispatch		SK-1600AQ1	BTKW	
2.0 i	01/07-	RFH (EW10A)	1997	25x153; Baumuster: Jumpy		SK-1600AQ1	BTKW	
1.6 HDi 90	01/07-	9HU (DV6UTED4)	1560			0-N1062	TB [TE]	
1.6 HDi 90	01/07-	9HU (DV6UTED4)	1560			0-N1066	TB [DG]	
1.6 HDi 90 8V	01/07-	9HH (DV6DUM), 9HM (DV6UC)	1560			0-N2224	TB [TE]	
1.6 HDi 90 8V	01/07-	9HH (DV6DUM), 9HM (DV6UC)	1560			0-N2382	TB [DG]	
2.0 HDi 120, 2.0 HDi 125, 2.0 HDi 140, 2.0 HDi 165, 2.0 HDi 95	01/07-	AHY (DW10CE), AHZ (DW10CD), RHH (DW10CTED4), RHK (DW10UTED4), RHR (DW10BTED4)	1997			0-N1334	TB [DG]	
2.0 HDi 125, 2.0 HDi 165, 2.0 HDi 95	07/10-	AHY (DW10CE), AHZ (DW10CD), RHH (DW10CTED4)	1997			0-N2063	TB [TE]	
2.0 i	01/07-	RFH (EW10A)	1997			0-N1065	TB [DG]	
2.0 i	01/07-	EW10A	1997			0-N1343	TB [TE]	
1.6 HDi 90	01/07-	9HU (DV6UTED4)	1560			0-N1808	VB [BT]	S
1.6 HDi 90, 1.6 HDi 90 8V	01/07-	9HH (DV6DUM), 9HM (DV6UC), 9HU (DV6UTED4)	1560			0-N1807	VB [DG]	
2.0 HDi 120, 2.0 HDi 140	01/07-	RHK (DW10UTED4), RHR (DW10BTED4)	1997			0-N1327	VB [BT]	
2.0 HDi 120, 2.0 HDi 140	01/07-	RHK (DW10UTED4), RHR (DW10BTED4)	1997	Orga. →11193		0-N2037	VB [BT]	S
2.0 HDi 120, 2.0 HDi 140	01/07-	RHK (DW10UTED4), RHR (DW10BTED4)	1997	Orga. 11194 →		0-N2046	VB [BT]	S
2.0 HDi 125, 2.0 HDi 165, 2.0 HDi 95	07/10-	AHY (DW10CE), AHZ (DW10CD), RHH (DW10CTED4)	1997			0-N2268	VB [BT]	S
2.0 i	01/07-	RFH (EW10A)	1997			0-N1840	VB [BT]	S

NEMO Kasten (AA_)

1.4	02/08-	KFV (TU3A)	1360	17x104		SK-1354	BTK	
1.4	02/08-	KFV (TU3A)	1360	17x104		SK-1354AQ1	BTKW	
1.4 HDi	02/08-	8HS (DV4TED)	1398	25.4x144		SK-1391	BTK	
1.4 HDi	02/08-	8HS (DV4TED)	1398	25.4x144		SK-1391AQ1	BTKW	
1.4	02/08-	KFV (TU3A)	1360			0-N1277	TB [TE]	
1.4 HDi	02/08-	8HS (DV4TED)	1398			0-N1062	TB [TE]	
1.4 HDi	02/08-	8HS (DV4TED)	1398			0-N1066	TB [DG]	
1.3 HDi 75	10/10-	FHZ (F13DTE5)	1248			0-N2390	VB [BT]	S
1.4	02/08-	KFV (TU3A)	1360			0-N1419	VB [DG]	
1.4	02/08-	KFV (TU3A)	1360			0-N1620	VB [BT]	S
1.4 HDi	02/08-	8HS (DV4TED)	1398			0-N1807	VB [DG]	
1.4 HDi	02/08-	8HS (DV4TED)	1398			0-N1808	VB [BT]	S

NEMO Kombi

1.4	04/09-	KFT (TU3A), KFV (TU3A)	1360	17x104		SK-1354	BTK	
1.4	04/09-	KFT (TU3A), KFV (TU3A)	1360	17x104		SK-1354AQ1	BTKW	
1.4 HDi	04/09-	8HS (DV4TED)	1399	25.4x144		SK-1391	BTK	
1.4 HDi	04/09-	8HS (DV4TED)	1399	25.4x144		SK-1391AQ1	BTKW	
1.4	04/09-	KFT (TU3A), KFV (TU3A)	1360			0-N1277	TB [TE]	
1.4 HDi	04/09-	8HS (DV4TED)	1399			0-N1062	TB [TE]	
1.4 HDi	04/09-	8HS (DV4TED)	1399			0-N1066	TB [DG]	
1.3 HDi 75	10/10-	FHZ (F13DTE5)	1248			0-N2390	VB [BT]	S
1.4	04/09-	KFT (TU3A), KFV (TU3A)	1360			0-N1419	VB [DG]	
1.4	04/09-	KFT (TU3A), KFV (TU3A)	1360			0-N1620	VB [BT]	S



CM³



Art. Nr.



ohne Halter

NEMO Kombi							
1.4 HDi	04/09-	8HS (DV4TED)	1399			0-N1807	VB [DG]
1.4 HDi	04/09-	8HS (DV4TED)	1399			0-N1808	VB [BT] S
SAXO (S0, S1)							
1.0 X	05/96-06/03	CDZ (TU9M)	954	17x104		SK-1003	BTK
1.0 X	05/96-06/03	CDZ (TU9M)	954	17x104		SK-1003AQ1	BTKW
1.1 X,SX	05/96-09/03	HDZ (TU1M)	1124	17x104		SK-1003	BTK
1.1 X,SX	05/96-09/03	TU1M	1124	17x104		SK-1003	BTK
1.1 X,SX	05/96-09/03	TU1JP	1124	17x104; :→3762433		SK-1003	BTK
1.1 X,SX	05/96-09/03	HDZ (TU1M), HDZ (TU1M), HFX (TU1JP)	1124	17x104; :→3762434		SK-1003AQ1	BTKW
1.1 X,SX	05/96-09/03	HDZ (TU1M)	1124	17x100; :3762434→		SK-1353	BTK
1.1 X,SX	05/96-09/03	TU1JP	1124	17x100; :3762434→		SK-1353	BTK
1.1 X,SX	05/96-09/03	TU1JP	1124	17x100; :3762434→		SK-1353AQ1	BTKW
1.4 VTS	05/96-06/03	KFW (TU3JP), KFX (TU3JP)	1360	17x108; :→3666765		SK-1004	BTK
1.4 VTS	05/96-06/03	KFW (TU3JP), KFX (TU3JP)	1360	17x108; :→3666765		SK-1004AQ1	BTKW
1.4 VTS	05/96-06/03	KFW (TU3JP), KFX (TU3JP)	1360	17x104; :3666766→		SK-1354	BTK
1.4 VTS	05/96-06/03	KFW (TU3JP), KFX (TU3JP)	1360	17x104; :3666767→		SK-1354AQ1	BTKW
1.5 D	09/96-04/04	VJY (TUD5), VJZ (TUD5)	1527	25.4x136		SK-1040	BTK
1.5 D	09/96-04/04	VJY (TUD5), VJZ (TUD5)	1527	25.4x136		SK-1040AQ1	BTKW
1.5 D	07/01-04/04		1527	25x136		SK-1642	BTK
1.5 D	07/01-04/04		1527	25x136		SK-1642AQ1	BTKW
1.6, 1.6 VTL,VTR, 1.6 VTS	02/96-04/04	NFT (TU5JP), NFZ (TU5JP)	1587	17x101		SK-1020	BTK
1.6, 1.6 VTL,VTR, 1.6 VTS	02/96-04/04	NFT (TU5JP), NFZ (TU5JP)	1587	17x101		SK-1020AQ1	BTKW
1.0 X	05/96-06/03	CDZ (TU9M)	954			0-N811	TB [TE]
1.1 X,SX	05/96-09/03	TU1JP	1124	:3762434→		0-N1277	TB [TE]
1.1 X,SX	05/96-09/03	HDZ (TU1M)	1124			0-N811	TB [TE]
1.1 X,SX	05/96-09/03	TU1M	1124			0-N811	TB [TE]
1.1 X,SX	05/96-09/03	TU1JP	1124	:→3762433		0-N811	TB [TE]
1.4 VTS	05/96-06/03	KFW (TU3JP), KFX (TU3JP)	1360	:3666766→		0-N1277	TB [TE]
1.4 VTS	05/96-06/03	KFW (TU3JP), KFX (TU3JP)	1360	:→3666765		0-N811	TB [TE]
1.5 D	09/96-04/04	VJY (TUD5), VJZ (TUD5)	1527			0-N861	TB [TE]
1.5 D	09/96-04/04	VJY (TUD5), VJZ (TUD5)	1527			0-N862	TB [DG]
1.5 D	07/01-04/04		1527			0-N1381	TB [DG]
1.6, 1.6 VTL,VTR, 1.6 VTS	02/96-04/04	NFT (TU5JP), NFZ (TU5JP)	1587			0-N811	TB [TE]
1.6, 1.6 VTS	02/96-04/04	NFX (TU5JP4)	1587			0-N121	TB [TE]
1.6, 1.6 VTS	02/96-04/04	NFX (TU5JP4)	1587			0-N122	TB [DG]
1.0 X	05/96-06/03	CDZ (TU9M)	954			0-N125	VB [TE] S
1.1 X,SX	05/96-09/03	HDZ (TU1M), HDZ (TU1M), HFX (TU1JP)	1124			0-N125	VB [TE] S
1.4 VTS	05/96-06/03	KFW (TU3JP), KFX (TU3JP)	1360			0-N125	VB [TE] S
1.5 D	09/96-04/04	VJY (TUD5), VJZ (TUD5)	1527			0-N133	VB [TE]
1.5 D	09/96-04/04	VJY (TUD5), VJZ (TUD5)	1527			0-N2015	VB [BT]
1.5 D	09/96-04/04	VJY (TUD5), VJZ (TUD5)	1527	✳		0-N2174	VB [TE]
1.6, 1.6 VTL,VTR, 1.6 VTS	02/96-04/04	NFT (TU5JP), NFX (TU5JP4), NFZ (TU5JP)	1587			0-N125	VB [TE] S
VISA							
16 GTI	01/85-03/91	180A (XU5J), B6D	1580	17x113		SK-1006	BTK
17 D	04/84-03/91	161A (XUD7)	1769	25.39x136		SK-1007	BTK
17 D	04/84-03/91	161A (XUD7)	1769	25.4x136; Orga.3584→		SK-1007AQ1	BTKW
14	07/84-03/91	150D (XY7)	1360			0-N811	TB [TE]
16 GTI	01/85-03/91	180A (XU5J), B6D	1580			0-N812	TB [TE]
17 D	04/84-03/91	161A (XUD7)	1769			0-N813	TB [TE]
17 D	04/84-03/91	161A (XUD7)	1769			0-N814	TB [DG]
16 GTI	01/85-03/91	180A (XU5J), B6D	1580			0-N849	VB [TE]
17 D	04/84-03/91	161A (XUD7)	1769			0-N1682	VB [BT]
17 D	04/84-03/91	161A (XUD7)	1769			0-N2349	VB [DG]
XANTIA (X1)							
1.6 i	03/93-01/98	BFZ (XU5JP)	1580	17x114		SK-1019	BTK
1.8 i	03/93-01/98	LFX (XU7JB), LFZ (XU7JP)	1761	17x114		SK-1019	BTK
1.8 i 16V	06/95-01/98	LFY (XU7JP4)	1761	25x136; mit Zubehör; Spannrollenbetätigung: automatisch		SK-1399	BTK
1.8 i 16V	06/95-01/98	LFY (XU7JP4)	1761	25x136; 01/1998 →; Abgasnorm: Euro 2; mit Zubehör; Spannrollenbetätigung: automatisch		SK-1399AQ1	BTKW
1.8 i 16V	06/95-01/98	LFY (XU7JP4)	1761	25x136; 01/1998 →; Abgasnorm: Euro 3 (D3); mit Zubehör; Spannrollenbetätigung: automatisch		SK-1399AQ1	BTKW
1.9 D, 1.9 Turbo D	06/94-01/98	D9B (XUD9A/L), DHX (XUD9TF/BTF), DHY (XUD9TE/Y), DJZ (XUD9Y)	1905	25.4x136; Orga.06265→		SK-1022	BTK



CM³



Art. Nr.



ohne Halter

XANTIA (X1)

1.9 D, 1.9 Turbo D	06/94-01/98	D9B (XUD9A/L), DHX (XUD9TF/BTF), DHY (XUD9TE/Y), DJZ (XUD9Y)	1905	25.4x136; Orga.06265→	SK-1022AQ2	BTKW	
1.9 SD	02/96-01/98	DHW (XUD9SD)	1905	25.4x136; 11/1996 →	SK-1022	BTK	
1.9 SD	02/96-01/98	DHW (XUD9SD)	1905	25.4x136; Orga.07390→	SK-1022AQ1	BTKW	
1.9 SD	02/96-01/98	DHW (XUD9SD)	1905	25.4x136; Orga.06265→07389	SK-1022AQ2	BTKW	
2.0 i 16V	03/93-01/98	RFT (XU10J4/Z), RFY (XU10J4/Z)	1998	25.4x134	SK-1158	BTK	
2.0 i 16V	06/95-01/98	RFV (XU10J4R)	1998	25x136	SK-1082	BTK	
2.0 i 16V	06/95-01/98	RFV (XU10J4R)	1998	25x136	SK-1082AQ2	BTKW	
2.0 i, 2.0 Turbo	03/93-01/98	RFX (XU10J2C), RGX (XU10J2TE)	1998	17x114	SK-1019	BTK	
2.1 Turbo D 12V	06/95-01/98	P8C (XUD11BTE)	2088	25.4x149	SK-1017	BTK	
2.1 Turbo D 12V	06/95-01/98	P8C (XUD11BTE)	2088	25x149	SK-1017AQ1	BTKW	
1.6 i	03/93-01/98	BFZ (XU5JP)	1580		0-N811	TB [TE]	
1.8 i	03/93-01/98	LFX (XU7JB), LFZ (XU7JP)	1761		0-N811	TB [TE]	
1.8 i 16V	06/95-01/98	LFY (XU7JP4)	1761		0-N1058	TB [TE]	
1.8 i 16V	06/95-01/98	LFY (XU7JP4)	1761		0-N862	TB [DG]	
1.9 D, 1.9 SD, 1.9 Turbo D	06/94-01/98	D9B (XUD9A/L), DHW (XUD9SD), DHX (XUD9TF/BTF), DHY (XUD9TE/Y), DJZ (XUD9Y)	1905		0-N900	TB [DG]	
1.9 D, 1.9 SD, 1.9 Turbo D	06/94-01/98	D9B (XUD9A/L), DHW (XUD9SD), DHX (XUD9TF/BTF), DHY (XUD9TE/Y), DJZ (XUD9Y)	1905		0-N901	TB [TE]	
2.0 i 16V	03/93-01/98	RFT (XU10J4/Z), RFY (XU10J4/Z)	1998		0-N869	TB [TE]	
2.0 i 16V	03/93-01/98	RFT (XU10J4/Z), RFY (XU10J4/Z)	1998		0-N911	TB [DG]	
2.0 i 16V	06/95-01/98	RFV (XU10J4R)	1998		0-N862	TB [DG]	
2.0 i 16V	06/95-01/98	RFV (XU10J4R)	1998		0-N943	TB [TE]	
2.0 i, 2.0 Turbo	03/93-01/98	RFX (XU10J2C), RGX (XU10J2TE)	1998		0-N811	TB [TE]	
2.1 Turbo D 12V	06/95-01/98	P8C (XUD11BTE)	2088		0-N862	TB [DG]	
2.1 Turbo D 12V	06/95-01/98	P8C (XUD11BTE)	2088		0-N871	TB [TE]	
3.0 i 24V	01/97-01/98	XFZ (ES9J4)	2946		0-N1056	TB [TE]	
3.0 i 24V	01/97-01/98	XFZ (ES9J4)	2946		0-N170	TB [DG]	
3.0 i 24V	01/97-01/98	XFZ (ES9J4)	2946		0-N171	TB [DG]	
1.6 i	03/93-01/98	BFZ (XU5JP)	1580		0-N124	VB [TE]	
1.6 i	03/93-01/98	BFZ (XU5JP)	1580	☼	0-N1405	VB [DG]	
1.6 i	03/93-01/98	BFZ (XU5JP)	1580	☼	0-N1484	VB [BT]	S
1.8 i	03/93-01/98	LFX (XU7JB), LFZ (XU7JP)	1761	☼	0-N1405	VB [DG]	
1.8 i 16V	06/95-01/98	LFY (XU7JP4)	1761	Generator-Ladestrom [A]: 90; ☼	0-N1402	VB [DG]	S
1.8 i 16V	06/95-01/98	LFY (XU7JP4)	1761	Generator-Ladestrom [A]: 120; ☼	0-N1465S	VB [DG]	
1.8 i, 1.8 i 16V	03/93-01/98	LFX (XU7JB), LFY (XU7JP4), LFZ (XU7JP)	1761	Orga.→7904	0-N124	VB [TE]	
1.8 i, 1.8 i 16V	03/93-01/98	LFX (XU7JB), LFY (XU7JP4), LFZ (XU7JP)	1761	☼	0-N1484	VB [BT]	S
1.8 i, 1.8 i 16V	03/93-01/98	LFX (XU7JB), LFY (XU7JP4), LFZ (XU7JP)	1761	Orga.7905→; ☼	0-N1968	VB [BT]	
1.9 D, 1.9 SD, 1.9 Turbo D	06/94-01/98	D9B (XUD9A/L), DHW (XUD9SD), DHX (XUD9TF/BTF), DHY (XUD9TE/Y), DJZ (XUD9Y)	1905		0-N931	VB [TE]	
1.9 D, 1.9 Turbo D	06/94-01/98	D9B (XUD9A/L), DHX (XUD9TF/BTF), DHY (XUD9TE/Y), DJZ (XUD9Y)	1905	07/1995 →	0-N1320	VB [TE]	
1.9 D, 1.9 Turbo D	06/94-01/98	D9B (XUD9A/L), DHX (XUD9TF/BTF), DHY (XUD9TE/Y), DJZ (XUD9Y)	1905	07/1995 →; ☼	0-N1472	VB [BT]	S
1.9 D, 1.9 Turbo D	06/94-01/98	D9B (XUD9A/L), DHX (XUD9TF/BTF), DHY (XUD9TE/Y), DJZ (XUD9Y)	1905	07/1995 →; ☼	0-N1747	VB [VD]	
1.9 D, 1.9 Turbo D	06/94-01/98	D9B (XUD9A/L), DHX (XUD9TF/BTF), DHY (XUD9TE/Y), DJZ (XUD9Y)	1905	→ 07/1995; ☼	0-N1751	VB [DG]	
1.9 D, 1.9 Turbo D	06/94-01/98	D9B (XUD9A/L), DHX (XUD9TF/BTF), DHY (XUD9TE/Y), DJZ (XUD9Y)	1905	→ 07/1995; ☼	0-N1756	VB [BT]	
1.9 SD	02/96-01/98	DHW (XUD9SD)	1905		0-N1320	VB [TE]	
1.9 SD	02/96-01/98	DHW (XUD9SD)	1905	☼	0-N1472	VB [BT]	S
1.9 SD	02/96-01/98	DHW (XUD9SD)	1905	☼	0-N1747	VB [VD]	
2.0 i 16V, 2.0 Turbo	06/95-01/98	RFV (XU10J4R), RGX (XU10J2TE)	1998	☼	0-N1713	VB [BT]	
2.0 i 16V, 2.0 Turbo	06/95-01/98	RFV (XU10J4R), RGX (XU10J2TE)	1998	☼	0-N1722	VB [DG]	
2.0 i, 2.0 i 16V	03/93-01/98	RFT (XU10J4/Z), RFX (XU10J2C), RFY (XU10J4/Z)	1998		0-N124	VB [TE]	
2.0 i, 2.0 i 16V, 2.0 Turbo	03/93-01/98	RFT (XU10J4/Z), RFV (XU10J4R), RFX (XU10J2C), RFY (XU10J4/Z), RGX (XU10J2TE)	1998	☼	0-N1405	VB [DG]	
2.0 i, 2.0 i 16V, 2.0 Turbo	03/93-01/98	RFT (XU10J4/Z), RFV (XU10J4R), RFX (XU10J2C), RFY (XU10J4/Z), RGX (XU10J2TE)	1998	☼	0-N1484	VB [BT]	S
2.1 Turbo D 12V	06/95-01/98	P8C (XUD11BTE)	2088		0-N1320	VB [TE]	
2.1 Turbo D 12V	06/95-01/98	P8C (XUD11BTE)	2088	☼	0-N1472	VB [BT]	S
2.1 Turbo D 12V	06/95-01/98	P8C (XUD11BTE)	2088	☼	0-N1747	VB [VD]	
2.1 Turbo D 12V	06/95-01/98	P8C (XUD11BTE)	2088		0-N931	VB [TE]	



CM³



Art. Nr.



ohne Halter

XANTIA (X1)							
3.0 i 24V	01/97-01/98	XFZ (ES9J4)	2946			0-N1449	VB [TE]
3.0 i 24V	01/97-01/98	XFZ (ES9J4)	2946			0-N1757	VB [VD]
3.0 i 24V	01/97-01/98	XFZ (ES9J4)	2946			0-N2175	VB [BT]
XANTIA Break (X1)							
1.8 i	06/95-01/98	LFX (XU7JB), LFZ (XU7JP)	1761	17x114		SK-1019	BTK
1.8 i 16V	06/95-01/98	LFY (XU7JP4)	1761	25x136; mit Zubehör; Spannrollenbetätigung: automatisch		SK-1399	BTK
1.8 i 16V	06/95-01/98	LFY (XU7JP4)	1761	25x136; 01/1998 →; Abgasnorm: Euro 2; mit Zubehör; Spannrollenbetätigung: automatisch		SK-1399AQ1	BTKW
1.8 i 16V	06/95-01/98	LFY (XU7JP4)	1761	25x136; 01/1998 →; Abgasnorm: Euro 3 (D3); mit Zubehör; Spannrollenbetätigung: automatisch		SK-1399AQ1	BTKW
1.9 SD	04/97-01/98	DHW (XUD9SD)	1905	25.4x136; Orga.07390→		SK-1022AQ1	BTKW
1.9 SD	04/97-01/98	DHW (XUD9SD)	1905	25.4x136; Orga.06265→07389		SK-1022AQ2	BTKW
1.9 SD, 1.9 Turbo D	06/95-01/98	D8B (XUD9TF), DHX (XUD9TF/BTF), DHY (XUD9TE/Y), DHW (XUD9SD)	1905	25.4x136		SK-1022	BTK
1.9 Turbo D	06/95-01/98	D8B (XUD9TF), DHX (XUD9TF/BTF), DHY (XUD9TE/Y)	1905	25.4x136; Orga.06265→		SK-1022AQ2	BTKW
2.0 i 16V	06/95-01/98	RFV (XU10J4R)	1998	25x136		SK-1082	BTK
2.0 i 16V	06/95-01/98	RFV (XU10J4R)	1998	25x136		SK-1082AQ2	BTKW
2.0 i, 2.0 Turbo	06/95-01/98	RFX (XU10J2C), RGX (XU10J2TE)	1998	17x114		SK-1019	BTK
2.1 Turbo D 12V	06/96-01/98	P8C (XUD11BTE)	2088	25.4x149		SK-1017	BTK
2.1 Turbo D 12V	06/96-01/98	P8C (XUD11BTE)	2088	25x149		SK-1017AQ1	BTKW
1.8 i	06/95-01/98	LFX (XU7JB), LFZ (XU7JP)	1761			0-N811	TB [TE]
1.8 i 16V	06/95-01/98	LFY (XU7JP4)	1761			0-N1058	TB [TE]
1.8 i 16V	06/95-01/98	LFY (XU7JP4)	1761			0-N862	TB [DG]
1.9 SD, 1.9 Turbo D	06/95-01/98	D8B (XUD9TF), DHX (XUD9TF/BTF), DHY (XUD9TE/Y), DHW (XUD9SD)	1905			0-N900	TB [DG]
1.9 SD, 1.9 Turbo D	06/95-01/98	D8B (XUD9TF), DHX (XUD9TF/BTF), DHY (XUD9TE/Y), DHW (XUD9SD)	1905			0-N901	TB [TE]
2.0 i 16V	06/95-01/98	RFV (XU10J4R)	1998			0-N862	TB [DG]
2.0 i 16V	06/95-01/98	RFV (XU10J4R)	1998			0-N943	TB [TE]
2.0 i, 2.0 Turbo	06/95-01/98	RFX (XU10J2C), RGX (XU10J2TE)	1998			0-N811	TB [TE]
2.1 Turbo D 12V	06/96-01/98	P8C (XUD11BTE)	2088			0-N862	TB [DG]
2.1 Turbo D 12V	06/96-01/98	P8C (XUD11BTE)	2088			0-N871	TB [TE]
1.8 i	06/95-01/98	LFX (XU7JB), LFZ (XU7JP)	1761	☼		0-N1405	VB [DG]
1.8 i 16V	06/95-01/98	LFY (XU7JP4)	1761	Generator-Ladestrom [A]: 90; ☼		0-N1402	VB [DG] S
1.8 i 16V	06/95-01/98	LFY (XU7JP4)	1761	Generator-Ladestrom [A]: 120; ☼		0-N1465S	VB [DG]
1.8 i, 1.8 i 16V	06/95-01/98	LFX (XU7JB), LFY (XU7JP4), LFZ (XU7JP)	1761	Orga.→7904		0-N124	VB [TE]
1.8 i, 1.8 i 16V	06/95-01/98	LFX (XU7JB), LFY (XU7JP4), LFZ (XU7JP)	1761	☼		0-N1484	VB [BT] S
1.8 i, 1.8 i 16V	06/95-01/98	LFX (XU7JB), LFY (XU7JP4), LFZ (XU7JP)	1761	Orga.7905→; ☼		0-N1968	VB [BT]
1.9 SD, 1.9 Turbo D	06/95-01/98	D8B (XUD9TF), DHX (XUD9TF/BTF), DHY (XUD9TE/Y), DHW (XUD9SD)	1905			0-N1320	VB [TE]
1.9 SD, 1.9 Turbo D	06/95-01/98	D8B (XUD9TF), DHX (XUD9TF/BTF), DHY (XUD9TE/Y), DHW (XUD9SD)	1905	☼		0-N1472	VB [BT] S
1.9 SD, 1.9 Turbo D	06/95-01/98	D8B (XUD9TF), DHX (XUD9TF/BTF), DHY (XUD9TE/Y), DHW (XUD9SD)	1905	☼		0-N1747	VB [VD]
1.9 SD, 1.9 Turbo D	06/95-01/98	D8B (XUD9TF), DHX (XUD9TF/BTF), DHY (XUD9TE/Y), DHW (XUD9SD)	1905			0-N931	VB [TE]
2.0 i	06/95-01/98	RFX (XU10J2C)	1998			0-N124	VB [TE]
2.0 i 16V, 2.0 Turbo	06/95-01/98	RFV (XU10J4R), RGX (XU10J2TE)	1998	☼		0-N1713	VB [BT]
2.0 i 16V, 2.0 Turbo	06/95-01/98	RFV (XU10J4R), RGX (XU10J2TE)	1998	☼		0-N1722	VB [DG]
2.0 i, 2.0 i 16V, 2.0 Turbo	06/95-01/98	RFV (XU10J4R), RFX (XU10J2C), RGX (XU10J2TE)	1998	☼		0-N1405	VB [DG]
2.0 i, 2.0 i 16V, 2.0 Turbo	06/95-01/98	RFV (XU10J4R), RFX (XU10J2C), RGX (XU10J2TE)	1998	☼		0-N1484	VB [BT] S
2.1 Turbo D 12V	06/96-01/98	P8C (XUD11BTE)	2088			0-N1320	VB [TE]
2.1 Turbo D 12V	06/96-01/98	P8C (XUD11BTE)	2088	☼		0-N1472	VB [BT] S
2.1 Turbo D 12V	06/96-01/98	P8C (XUD11BTE)	2088	☼		0-N1747	VB [VD]
2.1 Turbo D 12V	06/96-01/98	P8C (XUD11BTE)	2088			0-N931	VB [TE]
XANTIA (X2)							
1.6 i SX	01/98-03/01	BFZ (XU5JP)	1580	17x114		SK-1019	BTK
1.8 i	01/98-04/03	LFX (XU7JB)	1761	17x114		SK-1019	BTK
1.8 i 16V	01/98-04/03	LFY (XU7JP4)	1761	25x136; → 01/2000; Abgasnorm: Euro 3 (D3)		SK-1082	BTK
1.8 i 16V	01/98-04/03	LFY (XU7JP4)	1761	25x136; → 01/2000; Spannrollenbetätigung: manuell		SK-1082AQ1	BTKW



CM³



Art. Nr.



XANTIA (X2)

1.8 i 16V	01/98-04/03	LFY (XU7JP4)	1761	25x136; Abgasnorm: Euro 2; mit Zubehör; Spannrollenbetätigung: automatisch	SK-1399	BTK	
1.8 i 16V	01/98-04/03	LFY (XU7JP4)	1761	25x136; Abgasnorm: Euro 3 (D3); mit Zubehör; Spannrollenbetätigung: automatisch	SK-1399	BTK	
1.8 i 16V	01/98-04/03	LFY (XU7JP4)	1761	25x136; → 01/1998; mit Zubehör; Spannrollenbetätigung: automatisch	SK-1399AQ1	BTKW	
1.8 i 16V	01/98-04/03	LFY (XU7JP4)	1761	25x136; → 01/2000; Abgasnorm: Euro 3 (D3); mit Zubehör; Spannrollenbetätigung: automatisch	SK-1399AQ1	BTKW	
1.8 i 16V	01/98-04/03	LFY (XU7JP4)	1761	25x136; Abgasnorm: Euro 2; mit Zubehör; Spannrollenbetätigung: automatisch	SK-1399AQ1	BTKW	
1.9 SD	01/98-04/03	DHW (XUD9SD)	1905	25.4x136	SK-1022	BTK	
1.9 SD	01/98-04/03	DHW (XUD9SD)	1905	25.4x136; Orga.07390→	SK-1022AQ1	BTKW	
1.9 Turbo D	01/98-04/03	DHX (XUD9TF/BTF), DHY (XUD9TE/Y)	1905	25.4x136; Orga.06265→	SK-1022	BTK	
2.0 HDI 109, 2.0 HDI 90	02/99-04/03	RHY (DW10TD), RHZ (DW10ATED)	1997	25x141; mit Zubehör	SK-1085	BTK	
2.0 HDI 109, 2.0 HDI 90	02/99-04/03	RHY (DW10TD), RHZ (DW10ATED)	1997	25.4x141; mit Zubehör	SK-1085AQ1	BTKW	
2.0 i 16V	01/98-04/03	RFV (XU10J4R)	1998	25x136	SK-1082	BTK	
2.0 i 16V	01/98-04/03	RFV (XU10J4R)	1998	25x136	SK-1082AQ2	BTKW	
2.0 i, 2.0 Turbo	01/98-04/03	RFX (XU10J2C), RGX (XU10J2TE)	1998	17x114	SK-1019	BTK	
2.1 Turbo D 12V	01/98-02/99	P8C (XUD11BTE)	2088	25.4x149	SK-1017	BTK	
2.1 Turbo D 12V	01/98-02/99	P8C (XUD11BTE)	2088	25x149	SK-1017AQ1	BTKW	
3.0 V6	01/98-04/03	XFZ (ES9J4)	2946	32x259; 12/1999 →; Orga.08442→	SK-1483	BTK	
1.6 i SX	01/98-03/01	BFZ (XU5JP)	1580		0-N811	TB [TE]	
1.8 i	01/98-04/03	LFX (XU7JB)	1761		0-N811	TB [TE]	
1.8 i 16V	01/98-04/03	LFY (XU7JP4)	1761	Orga.08470→	0-N1058	TB [TE]	
1.8 i 16V	01/98-04/03	LFY (XU7JP4)	1761		0-N862	TB [DG]	
1.8 i 16V	01/98-04/03	LFY (XU7JP4)	1761	Orga.→08469	0-N943	TB [TE]	
1.9 SD, 1.9 Turbo D	01/98-04/03	DHW (XUD9SD), DHX (XUD9TF/BTF), DHY (XUD9TE/Y)	1905		0-N900	TB [DG]	
1.9 SD, 1.9 Turbo D	01/98-04/03	DHW (XUD9SD), DHX (XUD9TF/BTF), DHY (XUD9TE/Y)	1905		0-N901	TB [TE]	
2.0 HDI 109, 2.0 HDI 90	02/99-04/03	RHY (DW10TD), RHZ (DW10ATED)	1997		0-N118P	TB [TE]	
2.0 HDI 109, 2.0 HDI 90	02/99-04/03	RHY (DW10TD), RHZ (DW10ATED)	1997		0-N119P	TB [DG]	
2.0 i 16V	01/98-04/03	RFV (XU10J4R)	1998		0-N862	TB [DG]	
2.0 i 16V	01/98-04/03	RFV (XU10J4R)	1998		0-N943	TB [TE]	
2.0 i, 2.0 Turbo	01/98-04/03	RFX (XU10J2C), RGX (XU10J2TE)	1998		0-N811	TB [TE]	
2.1 Turbo D 12V	01/98-02/99	P8C (XUD11BTE)	2088		0-N862	TB [DG]	
2.1 Turbo D 12V	01/98-02/99	P8C (XUD11BTE)	2088		0-N871	TB [TE]	
3.0 V6	01/98-04/03	XFZ (ES9J4)	2946		0-N1056	TB [TE]	
3.0 V6	01/98-04/03	XFZ (ES9J4)	2946		0-N170	TB [DG]	
3.0 V6	01/98-04/03	XFZ (ES9J4)	2946		0-N171	TB [DG]	
1.8 i	01/98-04/03	LFX (XU7JB)	1761	☼	0-N1405	VB [DG]	
1.8 i 16V	01/98-04/03	LFY (XU7JP4)	1761	Generator-Ladestrom [A]: 90; ☼	0-N1402	VB [DG]	S
1.8 i 16V	01/98-04/03	LFY (XU7JP4)	1761	Generator-Ladestrom [A]: 120; ☼	0-N1465S	VB [DG]	
1.8 i, 1.8 i 16V	01/98-04/03	LFX (XU7JB), LFY (XU7JP4)	1761	Orga.→7904	0-N124	VB [TE]	
1.8 i, 1.8 i 16V	01/98-04/03	LFX (XU7JB), LFY (XU7JP4)	1761	☼	0-N1484	VB [BT]	S
1.8 i, 1.8 i 16V	01/98-04/03	LFX (XU7JB), LFY (XU7JP4)	1761	Orga.7905→; ☼	0-N1968	VB [BT]	
1.9 SD, 1.9 Turbo D	01/98-04/03	DHW (XUD9SD), DHX (XUD9TF/BTF), DHY (XUD9TE/Y)	1905		0-N1320	VB [TE]	
1.9 SD, 1.9 Turbo D	01/98-04/03	DHW (XUD9SD), DHX (XUD9TF/BTF), DHY (XUD9TE/Y)	1905	☼	0-N1472	VB [BT]	S
1.9 SD, 1.9 Turbo D	01/98-04/03	DHW (XUD9SD), DHX (XUD9TF/BTF), DHY (XUD9TE/Y)	1905	☼	0-N1747	VB [VD]	
1.9 SD, 1.9 Turbo D	01/98-04/03	DHW (XUD9SD), DHX (XUD9TF/BTF), DHY (XUD9TE/Y)	1905		0-N931	VB [TE]	
2.0 HDI 109, 2.0 HDI 90	02/99-04/03	RHY (DW10TD), RHZ (DW10ATED)	1997		0-N1320	VB [TE]	
2.0 HDI 109, 2.0 HDI 90	02/99-04/03	RHY (DW10TD), RHZ (DW10ATED)	1997		0-N1493	VB [BT]	S
2.0 HDI 109, 2.0 HDI 90	02/99-04/03	RHY (DW10TD), RHZ (DW10ATED)	1997	☼	0-N151	VB [DG]	
2.0 HDI 109, 2.0 HDI 90	02/99-04/03	RHY (DW10TD), RHZ (DW10ATED)	1997	☼	0-N1748	VB [BT]	
2.0 i	01/98-04/03	RFX (XU10J2C)	1998		0-N124	VB [TE]	
2.0 i 16V, 2.0 Turbo	01/98-04/03	RFV (XU10J4R), RGX (XU10J2TE)	1998	☼	0-N1713	VB [BT]	
2.0 i 16V, 2.0 Turbo	01/98-04/03	RFV (XU10J4R), RGX (XU10J2TE)	1998	☼	0-N1722	VB [DG]	
2.0 i, 2.0 i 16V, 2.0 Turbo	01/98-04/03	RFV (XU10J4R), RFX (XU10J2C), RGX (XU10J2TE)	1998	☼	0-N1405	VB [DG]	
2.0 i, 2.0 i 16V, 2.0 Turbo	01/98-04/03	RFV (XU10J4R), RFX (XU10J2C), RGX (XU10J2TE)	1998	☼	0-N1484	VB [BT]	S
2.1 Turbo D 12V	01/98-02/99	P8C (XUD11BTE)	2088		0-N1320	VB [TE]	
2.1 Turbo D 12V	01/98-02/99	P8C (XUD11BTE)	2088	☼	0-N1472	VB [BT]	S

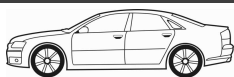

CM³



Art. Nr.



ohne Halter

XANTIA (X2)							
2.1 Turbo D 12V	01/98-02/99	P8C (XUD11BTE)	2088	☼		0-N1747	VB [VD]
2.1 Turbo D 12V	01/98-02/99	P8C (XUD11BTE)	2088			0-N931	VB [TE]
3.0 V6	01/98-04/03	XFZ (ES9J4)	2946			0-N1449	VB [TE]
3.0 V6	01/98-04/03	XFZ (ES9J4)	2946			0-N1757	VB [VD]
3.0 V6	01/98-04/03	XFZ (ES9J4)	2946			0-N2175	VB [BT]
XANTIA Break (X2)							
1.8 i	01/98-04/03	LFX (XU7JB)	1761	17x114		SK-1019	BTK
1.8 i 16V	01/98-04/03	LFY (XU7JP4)	1761	25x136; → 01/2000; Abgasnorm: Euro 3 (D3)		SK-1082	BTK
1.8 i 16V	01/98-04/03	LFY (XU7JP4)	1761	25x136; → 01/2000; Spannrollenbetätigung: manuell		SK-1082AQ1	BTKW
1.8 i 16V	01/98-04/03	LFY (XU7JP4)	1761	25x136; Abgasnorm: Euro 2; mit Zubehör; Spannrollenbetätigung: automatisch		SK-1399	BTK
1.8 i 16V	01/98-04/03	LFY (XU7JP4)	1761	25x136; → 01/1998; mit Zubehör; Spannrollenbetätigung: automatisch		SK-1399AQ1	BTKW
1.8 i 16V	01/98-04/03	LFY (XU7JP4)	1761	25x136; → 01/2000; Abgasnorm: Euro 3 (D3); mit Zubehör; Spannrollenbetätigung: automatisch		SK-1399AQ1	BTKW
1.8 i 16V	01/98-04/03	LFY (XU7JP4)	1761	25x136; Abgasnorm: Euro 2; mit Zubehör; Spannrollenbetätigung: automatisch		SK-1399AQ1	BTKW
1.9 SD	01/98-04/03	DHW (XUD9SD)	1905	25.4x136; Orga.07390→		SK-1022AQ1	BTKW
1.9 SD, 1.9 Turbo D	01/98-04/03	D8B (XUD9TF), DHX (XUD9TF/BTF), DHW (XUD9SD)	1905	25.4x136		SK-1022	BTK
1.9 Turbo D	01/98-04/03	D8B (XUD9TF), DHX (XUD9TF/BTF)	1905	25.4x136; Orga.06265→		SK-1022AQ2	BTKW
2.0 HDI 109, 2.0 HDI 90	02/99-04/03	RHY (DW10TD), RHZ (DW10ATED)	1997	25x141; mit Zubehör		SK-1085	BTK
2.0 HDI 109, 2.0 HDI 90	02/99-04/03	RHY (DW10TD), RHZ (DW10ATED)	1997	25.4x141; mit Zubehör		SK-1085AQ1	BTKW
2.0 i 16V	01/98-04/03	RFV (XU10J4R)	1998	25x136		SK-1082	BTK
2.0 i 16V	01/98-04/03	RFV (XU10J4R)	1998	25x136		SK-1082AQ2	BTKW
2.0 i, 2.0 Turbo	01/98-04/03	RFX (XU10J2C), RGX (XU10J2TE)	1998	17x114		SK-1019	BTK
2.1 Turbo D 12V	01/98-02/99	P8C (XUD11BTE)	2088	25.4x149		SK-1017	BTK
2.1 Turbo D 12V	01/98-02/99	P8C (XUD11BTE)	2088	25x149		SK-1017AQ1	BTKW
3.0 V6	01/98-04/03	XFZ (ES9J4)	2946	32x259; 12/1999 →; Orga.08442→		SK-1483	BTK
1.8 i	01/98-04/03	LFX (XU7JB)	1761			0-N811	TB [TE]
1.8 i 16V	01/98-04/03	LFY (XU7JP4)	1761	Orga.08470→		0-N1058	TB [TE]
1.8 i 16V	01/98-04/03	LFY (XU7JP4)	1761			0-N862	TB [DG]
1.8 i 16V	01/98-04/03	LFY (XU7JP4)	1761	Orga.→08469		0-N943	TB [TE]
1.9 SD, 1.9 Turbo D	01/98-04/03	D8B (XUD9TF), DHX (XUD9TF/BTF), DHW (XUD9SD)	1905			0-N900	TB [DG]
1.9 SD, 1.9 Turbo D	01/98-04/03	D8B (XUD9TF), DHX (XUD9TF/BTF), DHW (XUD9SD)	1905			0-N901	TB [TE]
2.0 HDI 109, 2.0 HDI 90	02/99-04/03	RHY (DW10TD), RHZ (DW10ATED)	1997			0-N118P	TB [TE]
2.0 HDI 109, 2.0 HDI 90	02/99-04/03	RHY (DW10TD), RHZ (DW10ATED)	1997			0-N119P	TB [DG]
2.0 i 16V	01/98-04/03	RFV (XU10J4R)	1998			0-N862	TB [DG]
2.0 i 16V	01/98-04/03	RFV (XU10J4R)	1998			0-N943	TB [TE]
2.0 i, 2.0 Turbo	01/98-04/03	RFX (XU10J2C), RGX (XU10J2TE)	1998			0-N811	TB [TE]
2.1 Turbo D 12V	01/98-02/99	P8C (XUD11BTE)	2088			0-N862	TB [DG]
2.1 Turbo D 12V	01/98-02/99	P8C (XUD11BTE)	2088			0-N871	TB [TE]
3.0 V6	01/98-04/03	XFZ (ES9J4)	2946			0-N1056	TB [TE]
3.0 V6	01/98-04/03	XFZ (ES9J4)	2946			0-N170	TB [DG]
3.0 V6	01/98-04/03	XFZ (ES9J4)	2946			0-N171	TB [DG]
1.8 i	01/98-04/03	LFX (XU7JB)	1761	☼		0-N1405	VB [DG]
1.8 i 16V	01/98-04/03	LFY (XU7JP4)	1761	Generator-Ladestrom [A]: 90; ☼		0-N1402	VB [DG] S
1.8 i 16V	01/98-04/03	LFY (XU7JP4)	1761	Generator-Ladestrom [A]: 120; ☼		0-N1465S	VB [DG]
1.8 i, 1.8 i 16V	01/98-04/03	LFX (XU7JB), LFY (XU7JP4)	1761	Orga.→7904		0-N124	VB [TE]
1.8 i, 1.8 i 16V	01/98-04/03	LFX (XU7JB), LFY (XU7JP4)	1761	☼		0-N1484	VB [BT] S
1.8 i, 1.8 i 16V	01/98-04/03	LFX (XU7JB), LFY (XU7JP4)	1761	Orga.7905→; ☼		0-N1968	VB [BT]
1.9 SD, 1.9 Turbo D	01/98-04/03	D8B (XUD9TF), DHX (XUD9TF/BTF), DHW (XUD9SD)	1905			0-N1320	VB [TE]
1.9 SD, 1.9 Turbo D	01/98-04/03	D8B (XUD9TF), DHX (XUD9TF/BTF), DHW (XUD9SD)	1905	☼		0-N1472	VB [BT] S
1.9 SD, 1.9 Turbo D	01/98-04/03	D8B (XUD9TF), DHX (XUD9TF/BTF), DHW (XUD9SD)	1905	☼		0-N1747	VB [VD]
1.9 SD, 1.9 Turbo D	01/98-04/03	D8B (XUD9TF), DHX (XUD9TF/BTF), DHW (XUD9SD)	1905			0-N931	VB [TE]
2.0 HDI 109, 2.0 HDI 90	02/99-04/03	RHY (DW10TD), RHZ (DW10ATED)	1997			0-N1320	VB [TE]
2.0 HDI 109, 2.0 HDI 90	02/99-04/03	RHY (DW10TD), RHZ (DW10ATED)	1997			0-N1493	VB [BT] S
2.0 HDI 109, 2.0 HDI 90	02/99-04/03	RHY (DW10TD), RHZ (DW10ATED)	1997	☼		0-N151	VB [DG]
2.0 HDI 109, 2.0 HDI 90	02/99-04/03	RHY (DW10TD), RHZ (DW10ATED)	1997	☼		0-N1748	VB [BT]
2.0 i	01/98-04/03	RFX (XU10J2C)	1998			0-N124	VB [TE]



OPTIMAL®

CITROËN



CM³



Art. Nr.



XANTIA Break (X2)						
2.0 i 16V, 2.0 Turbo	01/98-04/03	RFV (XU10J4R), RGX (XU10J2TE)	1998	☼	0-N1713	VB [BT]
2.0 i 16V, 2.0 Turbo	01/98-04/03	RFV (XU10J4R), RGX (XU10J2TE)	1998	☼	0-N1722	VB [DG]
2.0 i, 2.0 i 16V, 2.0 Turbo	01/98-04/03	RFV (XU10J4R), RFX (XU10J2C), RGX (XU10J2TE)	1998	☼	0-N1405	VB [DG]
2.0 i, 2.0 i 16V, 2.0 Turbo	01/98-04/03	RFV (XU10J4R), RFX (XU10J2C), RGX (XU10J2TE)	1998	☼	0-N1484	VB [BT] S
2.1 Turbo D 12V	01/98-02/99	P8C (XUD11BTE)	2088		0-N1320	VB [TE]
2.1 Turbo D 12V	01/98-02/99	P8C (XUD11BTE)	2088	☼	0-N1472	VB [BT] S
2.1 Turbo D 12V	01/98-02/99	P8C (XUD11BTE)	2088	☼	0-N1747	VB [VD]
2.1 Turbo D 12V	01/98-02/99	P8C (XUD11BTE)	2088		0-N931	VB [TE]
3.0 V6	01/98-04/03	XFZ (ES9J4)	2946		0-N1449	VB [TE]
3.0 V6	01/98-04/03	XFZ (ES9J4)	2946		0-N1757	VB [VD]
3.0 V6	01/98-04/03	XFZ (ES9J4)	2946		0-N2175	VB [BT]

XM (Y3)						
2.0	05/89-06/94	R6A	1998	17x114; → 01/1992	SK-1159	BTK
2.0 i Turbo	09/92-06/94	RGY (XU10J2TE/Z)	1998	17x114	SK-1019	BTK
2.0, 2.0 i	05/89-06/94	R6A, RDZ (XU10MZ), RFZ (XU10J2)	1998	17x114; 02/1992 →	SK-1019	BTK
2.0, 2.0 i	05/89-06/94	RDZ (XU10MZ), RFZ (XU10J2)	1998	17x114; → 12/1992	SK-1159	BTK
2.1 D 12V	05/89-06/94	P9A (XUD11A)	2138	25.4x144; mit Zubehör	SK-1016	BTK
2.1 TD 12V	05/89-06/94	P8A (XUD11ATE), PHZ (XUD11ATE), PJZ (XUD11ATE)	2088	25.4x149	SK-1017	BTK
2.1 TD 12V	05/89-06/94	P8A (XUD11ATE), PHZ (XUD11ATE), PJZ (XUD11ATE)	2088	25x149	SK-1017AQ1	BTKW
2.0 i Turbo	09/92-06/94	RGY (XU10J2TE/Z)	1998		0-N811	TB [TE]
2.0, 2.0 i	05/89-06/94	R6A, RDZ (XU10MZ), RFZ (XU10J2)	1998	07/1993 →	0-N811	TB [TE]
2.0, 2.0 i	05/89-06/94	R6A, RDZ (XU10MZ), RFZ (XU10J2)	1998	→ 06/1993	0-N870	TB [TE]
2.1 D 12V	05/89-06/94	P9A (XUD11A)	2138		0-N862	TB [DG]
2.1 D 12V	05/89-06/94	P9A (XUD11A)	2138		0-N871	TB [TE]
2.1 TD 12V	05/89-06/94	P8A (XUD11ATE), PHZ (XUD11ATE), PJZ (XUD11ATE)	2088		0-N862	TB [DG]
2.1 TD 12V	05/89-06/94	P8A (XUD11ATE), PHZ (XUD11ATE), PJZ (XUD11ATE)	2088		0-N871	TB [TE]
2.0, 2.0 i	05/89-06/94	R6A, RDZ (XU10MZ), RFZ (XU10J2)	1998		0-N124	VB [TE]
2.0, 2.0 i	05/89-04/94	RDZ (XU10MZ)	1998	☼	0-N2152	VB [DG]
2.0, 2.0 i	05/89-06/94	R6A, RFZ (XU10J2)	1998	→ 12/1992; ☼	0-N2152	VB [DG]
2.0, 2.0 i	05/89-06/94	R6A, RFZ (XU10J2)	1998	01/1993 →; ☼	0-N2153	VB [DG]
2.0, 2.0 i, 2.0 i Turbo	05/89-06/94	RDZ (XU10MZ), RGY (XU10J2TE/Z)	1998	☼	0-N2153	VB [DG]
2.1 D 12V	05/89-06/94	P9A (XUD11A)	2138		0-N1320	VB [TE]
2.1 D 12V	05/89-06/94	P9A (XUD11A)	2138	☼	0-N1472	VB [BT] S
2.1 D 12V	05/89-06/94	P9A (XUD11A)	2138		0-N1747	VB [VD]
2.1 D 12V	05/89-06/94	P9A (XUD11A)	2138	☼	0-N2152	VB [DG]
2.1 D 12V	05/89-06/94	P9A (XUD11A)	2138	☼	0-N2153	VB [DG]
2.1 TD 12V	05/89-06/94	P8A (XUD11ATE), PHZ (XUD11ATE), PJZ (XUD11ATE)	2088		0-N1320	VB [TE]
2.1 TD 12V	05/89-06/94	P8A (XUD11ATE), PHZ (XUD11ATE), PJZ (XUD11ATE)	2088		0-N1472	VB [BT] S
2.1 TD 12V	05/89-06/94	P8A (XUD11ATE), PHZ (XUD11ATE), PJZ (XUD11ATE)	2088		0-N1747	VB [VD]
2.1 TD 12V	05/89-06/94	P8A (XUD11ATE), PHZ (XUD11ATE), PJZ (XUD11ATE)	2088	☼	0-N2152	VB [DG]
2.1 TD 12V	05/89-06/94	P8A (XUD11ATE), PHZ (XUD11ATE), PJZ (XUD11ATE)	2088		0-N2153	VB [DG]
3.0	05/89-06/94	UFZ (ZPJ/Z)	2975	Rippenanzahl: 5; ☼	0-N2348	VB [DG]
3.0 V6, 3.0 V6 24V	05/89-06/94	SFZ (ZPJ/Z), UFZ (ZPJ/Z), SKZ (ZPJ4/Z), UKZ (ZPJ4/Z)	2963	☼	0-N1973	VB [DG]
3.0 V6, 3.0 V6 24V	05/89-06/94	SFZ (ZPJ/Z), UFZ (ZPJ/Z), SKZ (ZPJ4/Z), UKZ (ZPJ4/Z)	2963	Rippenanzahl: 5; ☼	0-N2348	VB [DG]

XM Break (Y3)						
2.0	05/89-06/94	R6A	1998	17x114; Orga.05898→	SK-1019	BTK
2.0 i	11/91-04/94	RDZ (XU10MZ), XU102C, RFZ (XU10J2)	1998	17x114; → 12/1992	SK-1159	BTK
2.0 i, 2.0 Turbo	11/91-04/94	RDZ (XU10MZ), XU102C, RFZ (XU10J2), RGY (XU10J2TE/Z)	1998	17x114	SK-1019	BTK
2.1 D 12V	11/91-04/94	P9A (XUD11A)	2138	25.4x144; mit Zubehör	SK-1016	BTK
2.1 TD 12V	11/91-04/94	P8A (XUD11ATE), P8C (XUD11BTE), PHZ (XUD11ATE), PJZ (XUD11ATE)	2088	25.4x149	SK-1017	BTK
2.1 TD 12V	11/91-04/94	P8A (XUD11ATE), P8C (XUD11BTE), PHZ (XUD11ATE), PJZ (XUD11ATE)	2088	25x149	SK-1017AQ1	BTKW
2.0 Turbo	09/92-04/94	RGY (XU10J2TE/Z)	1998		0-N811	TB [TE]



CM³



Art. Nr.



ohne Halter

XM Break (Y3)							
2.0, 2.0 i	05/89-07/94	R6A, RDZ (XU10MZ), XU102C, RFZ (XU10J2)	1998	07/1993 →		0-N811	TB [TE]
2.0, 2.0 i	05/89-06/94	R6A, RDZ (XU10MZ), XU102C, RFZ (XU10J2)	1998	→ 06/1993		0-N870	TB [TE]
2.1 D 12V	11/91-04/94	P9A (XUD11A)	2138			0-N862	TB [DG]
2.1 D 12V	11/91-04/94	P9A (XUD11A)	2138			0-N871	TB [TE]
2.1 TD 12V	11/91-04/94	P8A (XUD11ATE), P8C (XUD11BTE), PHZ (XUD11ATE), PJZ (XUD11ATE)	2088			0-N862	TB [DG]
2.1 TD 12V	11/91-04/94	P8A (XUD11ATE), P8C (XUD11BTE), PHZ (XUD11ATE), PJZ (XUD11ATE)	2088			0-N871	TB [TE]
2.0 i	11/91-04/94	RFZ (XU10J2)	1998	→ 12/1992; ☼		0-N2152	VB [DG]
2.0 i	11/91-04/94	RFZ (XU10J2)	1998	01/1993 →; ☼		0-N2153	VB [DG]
2.0, 2.0 i	05/89-06/94	R6A, RDZ (XU10MZ), XU102C, RFZ (XU10J2)	1998			0-N124	VB [TE]
2.0, 2.0 i	05/89-07/94	R6A, RDZ (XU10MZ), XU102C	1998	☼		0-N2152	VB [DG]
2.0, 2.0 i, 2.0 Turbo	05/89-07/94	R6A, RDZ (XU10MZ), XU102C, RGY (XU10J2TE/Z)	1998	☼		0-N2153	VB [DG]
2.1 D 12V	11/91-04/94	P9A (XUD11A)	2138			0-N1320	VB [TE]
2.1 D 12V	11/91-04/94	P9A (XUD11A)	2138			0-N1472	VB [BT] S
2.1 D 12V	11/91-04/94	P9A (XUD11A)	2138			0-N1747	VB [VD]
2.1 D 12V	11/91-04/94	P9A (XUD11A)	2138	☼		0-N2152	VB [DG]
2.1 D 12V	11/91-04/94	P9A (XUD11A)	2138	☼		0-N2153	VB [DG]
2.1 TD 12V	11/91-04/94	P8A (XUD11ATE), P8C (XUD11BTE), PHZ (XUD11ATE), PJZ (XUD11ATE)	2088			0-N1320	VB [TE]
2.1 TD 12V	11/91-04/94	P8A (XUD11ATE), P8C (XUD11BTE), PHZ (XUD11ATE), PJZ (XUD11ATE)	2088			0-N1472	VB [BT] S
2.1 TD 12V	11/91-04/94	P8A (XUD11ATE), P8C (XUD11BTE), PHZ (XUD11ATE), PJZ (XUD11ATE)	2088			0-N1747	VB [VD]
2.1 TD 12V	11/91-04/94	P8A (XUD11ATE), P8C (XUD11BTE), PHZ (XUD11ATE), PJZ (XUD11ATE)	2088	☼		0-N2152	VB [DG]
2.1 TD 12V	11/91-04/94	P8A (XUD11ATE), P8C (XUD11BTE), PHZ (XUD11ATE), PJZ (XUD11ATE)	2088			0-N2153	VB [DG]
3.0	05/89-07/94	ZPJ/Z	2975	Rippenanzahl: 5; ☼		0-N2348	VB [DG]
3.0 Pallas	01/90-07/94	ZPJ4/Z	2963	Rippenanzahl: 5; ☼		0-N2348	VB [DG]
3.0 Pullman	05/89-07/94	ZPJ4/Z	2975	Rippenanzahl: 5; ☼		0-N2348	VB [DG]
3.0 V6	11/91-04/94	SFZ (ZPJ/Z), UFZ (ZPJ/Z)	2963	☼		0-N1973	VB [DG]
3.0 V6	11/91-04/94	SFZ (ZPJ/Z), UFZ (ZPJ/Z)	2963	Rippenanzahl: 5; ☼		0-N2348	VB [DG]
XM (Y4)							
2.0 i 16V	05/94-10/00	RFV (XU10J4R)	1998	25x136; 08/1994 →		SK-1082	BTK
2.0 i 16V	05/94-10/00	RFV (XU10J4R)	1998	25x136		SK-1082AQ2	BTKW
2.0 Turbo	05/94-10/00	RGX (XU10J2TE)	1998	17x114		SK-1019	BTK
2.1 D12 VSX	03/96-08/96	P9A (XUD11A)	2138	25.4x144; mit Zubehör		SK-1016	BTK
2.1 TD 12V	05/94-10/00	P8A (XUD11ATE), P8C (XUD11BTE), PHZ (XUD11ATE), PJZ (XUD11ATE)	2088	25.4x149		SK-1017	BTK
2.1 TD 12V	05/94-10/00	P8A (XUD11ATE), P8C (XUD11BTE), PHZ (XUD11ATE), PJZ (XUD11ATE)	2088	25x149		SK-1017AQ1	BTKW
2.5 TD	05/94-10/00	THY (DK5ATE)	2446	28x141		SK-1034	BTK
2.5 TD	05/94-10/00	THY (DK5ATE)	2446	28x141; 19x106		SK-1683	BTK
3.0 V6	04/97-10/00	XFZ (ES9J4)	2946	32x259; 12/1999 →; Orga.08442→		SK-1483	BTK
2.0 i 16V	05/94-10/00	RFV (XU10J4R)	1998			0-N862	TB [DG]
2.0 i 16V	05/94-10/00	RFV (XU10J4R)	1998			0-N943	TB [TE]
2.0 Turbo	05/94-10/00	RGX (XU10J2TE)	1998			0-N811	TB [TE]
2.1 D12 VSX	03/96-08/96	P9A (XUD11A)	2138			0-N862	TB [DG]
2.1 D12 VSX	03/96-08/96	P9A (XUD11A)	2138			0-N871	TB [TE]
2.1 TD 12V	05/94-10/00	P8A (XUD11ATE), P8C (XUD11BTE), PHZ (XUD11ATE), PJZ (XUD11ATE)	2088			0-N862	TB [DG]
2.1 TD 12V	05/94-10/00	P8A (XUD11ATE), P8C (XUD11BTE), PHZ (XUD11ATE), PJZ (XUD11ATE)	2088			0-N871	TB [TE]
2.5 TD	05/94-10/00	THY (DK5ATE)	2446			0-N1222	TB [TE]
2.5 TD	05/94-10/00	THY (DK5ATE)	2446			0-N944	TB [TE]
2.5 TD	05/94-10/00	THY (DK5ATE)	2446			0-N945	TB [DG]
3.0 V6	04/97-10/00	XFZ (ES9J4)	2946			0-N1056	TB [TE]
3.0 V6	04/97-10/00	XFZ (ES9J4)	2946			0-N170	TB [DG]
3.0 V6	04/97-10/00	XFZ (ES9J4)	2946			0-N171	TB [DG]
2.0 i 16V	05/94-10/00	RFV (XU10J4R)	1998			0-N124	VB [TE]
2.0 i 16V	05/94-10/00	RFV (XU10J4R)	1998	☼		0-N1405	VB [DG]
2.0 Turbo	05/94-10/00	RGX (XU10J2TE)	1998	☼		0-N2153	VB [DG]
2.1 D12 VSX	03/96-08/96	P9A (XUD11A)	2138			0-N1320	VB [TE]
2.1 D12 VSX	03/96-08/96	P9A (XUD11A)	2138			0-N1472	VB [BT] S



CM³



Art. Nr.



XM (Y4)

2.1 D12 VSX	03/96-08/96	P9A (XUD11A)	2138		0-N1747	VB [VD]
2.1 D12 VSX	03/96-08/96	P9A (XUD11A)	2138	☼	0-N2152	VB [DG]
2.1 D12 VSX	03/96-08/96	P9A (XUD11A)	2138		0-N2153	VB [DG]
2.1 TD 12V	05/94-10/00	P8A (XUD11ATE), P8C (XUD11BTE), PHZ (XUD11ATE), PJZ (XUD11ATE)	2088		0-N1320	VB [TE]
2.1 TD 12V	05/94-10/00	P8A (XUD11ATE), P8C (XUD11BTE), PHZ (XUD11ATE), PJZ (XUD11ATE)	2088		0-N1472	VB [BT] S
2.1 TD 12V	05/94-10/00	P8A (XUD11ATE), P8C (XUD11BTE), PHZ (XUD11ATE), PJZ (XUD11ATE)	2088		0-N1747	VB [VD]
2.1 TD 12V	05/94-10/00	P8A (XUD11ATE), P8C (XUD11BTE), PHZ (XUD11ATE), PJZ (XUD11ATE)	2088	☼	0-N2152	VB [DG]
2.1 TD 12V	05/94-10/00	P8A (XUD11ATE), P8C (XUD11BTE), PHZ (XUD11ATE), PJZ (XUD11ATE)	2088		0-N2153	VB [DG]
2.5 TD	05/94-10/00	THY (DK5ATE)	2446		0-N1959	VB [VD]
2.5 TD	05/94-10/00	THY (DK5ATE)	2446		0-N2154	VB [TE]
2.5 TD	05/94-10/00	THY (DK5ATE)	2446	☼	0-N2172	VB [TE] S
2.5 TD	05/94-10/00	THY (DK5ATE)	2446		0-N2173	VB [DG]
3.0 V6	04/97-10/00	XFZ (ES9J4)	2946		0-N1449	VB [TE]
3.0 V6	04/97-10/00	XFZ (ES9J4)	2946		0-N1757	VB [VD]
3.0 V6	04/97-10/00	XFZ (ES9J4)	2946		0-N2175	VB [BT]
3.0 V6, 3.0 V6 24V	05/94-10/00	SFZ (ZPJZ), UFZ (ZPJZ), SKZ (ZPJ4Z), UKZ (ZPJ4Z)	2963	☼	0-N1973	VB [DG]
3.0 V6, 3.0 V6 24V	05/94-10/00	SFZ (ZPJZ), UFZ (ZPJZ), SKZ (ZPJ4Z), UKZ (ZPJ4Z)	2963	Rippenanzahl: 5; ☼	0-N2348	VB [DG]

XM Break (Y4)

2.0 i 16V	05/94-10/00	RFV (XU10J4R)	1998	25x136; 08/1994 →	SK-1082	BTK
2.0 i 16V	05/94-10/00	RFV (XU10J4R)	1998	25x136	SK-1082AQ2	BTKW
2.0 Turbo	05/94-10/00	RGX (XU10J2TE), RGY (XU10J2TE/Z)	1998	17x114	SK-1019	BTK
2.1 D12	07/94-06/96	P9A (XUD11A)	2138	25.4x144; mit Zubehör	SK-1016	BTK
2.1 TD 12V	05/94-10/00	P8C (XUD11BTE), PHZ (XUD11ATE), PJZ (XUD11ATE)	2088	25.4x149	SK-1017	BTK
2.1 TD 12V	05/94-10/00	P8C (XUD11BTE), PHZ (XUD11ATE), PJZ (XUD11ATE)	2088	25x149	SK-1017AQ1	BTKW
2.5 TD	05/94-10/00	THY (DK5ATE)	2446	28x141	SK-1034	BTK
2.5 TD	05/94-10/00	THY (DK5ATE)	2446	28x141; 19x106	SK-1683	BTK
3.0 V6	04/97-10/00	XFZ (ES9J4)	2946	32x259; 12/1999 →; Orga.08442→	SK-1483	BTK
2.0 i 16V	05/94-10/00	RFV (XU10J4R)	1998		0-N862	TB [DG]
2.0 i 16V	05/94-10/00	RFV (XU10J4R)	1998		0-N943	TB [TE]
2.0 Turbo	05/94-10/00	RGX (XU10J2TE), RGY (XU10J2TE/Z)	1998		0-N811	TB [TE]
2.1 D12	07/94-06/96	P9A (XUD11A)	2138		0-N862	TB [DG]
2.1 D12	07/94-06/96	P9A (XUD11A)	2138		0-N871	TB [TE]
2.1 TD 12V	05/94-10/00	P8C (XUD11BTE), PHZ (XUD11ATE), PJZ (XUD11ATE)	2088		0-N862	TB [DG]
2.1 TD 12V	05/94-10/00	P8C (XUD11BTE), PHZ (XUD11ATE), PJZ (XUD11ATE)	2088		0-N871	TB [TE]
2.5 TD	05/94-10/00	THY (DK5ATE)	2446		0-N1222	TB [TE]
2.5 TD	05/94-10/00	THY (DK5ATE)	2446		0-N944	TB [TE]
2.5 TD	05/94-10/00	THY (DK5ATE)	2446		0-N945	TB [DG]
3.0 V6	04/97-10/00	XFZ (ES9J4)	2946		0-N1056	TB [TE]
3.0 V6	04/97-10/00	XFZ (ES9J4)	2946		0-N170	TB [DG]
3.0 V6	04/97-10/00	XFZ (ES9J4)	2946		0-N171	TB [DG]
2.0 i 16V	05/94-10/00	RFV (XU10J4R)	1998		0-N124	VB [TE]
2.0 i 16V	05/94-10/00	RFV (XU10J4R)	1998	☼	0-N1405	VB [DG]
2.0 Turbo	05/94-10/00	RGX (XU10J2TE), RGY (XU10J2TE/Z)	1998	☼	0-N2153	VB [DG]
2.1 D12	07/94-06/96	P9A (XUD11A)	2138		0-N1320	VB [TE]
2.1 D12	07/94-06/96	P9A (XUD11A)	2138		0-N1472	VB [BT] S
2.1 D12	07/94-06/96	P9A (XUD11A)	2138		0-N1747	VB [VD]
2.1 D12	07/94-06/96	P9A (XUD11A)	2138	☼	0-N2152	VB [DG]
2.1 D12	07/94-06/96	P9A (XUD11A)	2138		0-N2153	VB [DG]
2.1 TD 12V	05/94-10/00	P8C (XUD11BTE), PHZ (XUD11ATE), PJZ (XUD11ATE)	2088		0-N1320	VB [TE]
2.1 TD 12V	05/94-10/00	P8C (XUD11BTE), PHZ (XUD11ATE), PJZ (XUD11ATE)	2088		0-N1472	VB [BT] S
2.1 TD 12V	05/94-10/00	P8C (XUD11BTE), PHZ (XUD11ATE), PJZ (XUD11ATE)	2088		0-N1747	VB [VD]
2.1 TD 12V	05/94-10/00	P8C (XUD11BTE), PHZ (XUD11ATE), PJZ (XUD11ATE)	2088	☼	0-N2152	VB [DG]
2.1 TD 12V	05/94-10/00	P8C (XUD11BTE), PHZ (XUD11ATE), PJZ (XUD11ATE)	2088		0-N2153	VB [DG]

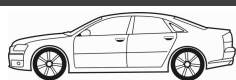

CM³



Art. Nr.



ohne Halter

XM Break (Y4)							
2.5 TD	05/94-10/00	THY (DK5ATE)	2446			0-N1959	VB [VD]
2.5 TD	05/94-10/00	THY (DK5ATE)	2446			0-N2154	VB [TE]
2.5 TD	05/94-10/00	THY (DK5ATE)	2446	✳		0-N2172	VB [TE] S
2.5 TD	05/94-10/00	THY (DK5ATE)	2446			0-N2173	VB [DG]
3.0 V6	05/94-10/00	SFZ (ZPJZ), UFZ (ZPJZ)	2963	✳		0-N1973	VB [DG]
3.0 V6	05/94-10/00	SFZ (ZPJZ), UFZ (ZPJZ)	2963	Rippenanzahl: 5; ✳		0-N2348	VB [DG]
3.0 V6	04/97-10/00	XFZ (ES9J4)	2946			0-N1449	VB [TE]
3.0 V6	04/97-10/00	XFZ (ES9J4)	2946			0-N1757	VB [VD]
3.0 V6	04/97-10/00	XFZ (ES9J4)	2946			0-N2175	VB [BT]

XSARA (N1)							
1.4 HDi	01/03-03/05	8HX (DV4TD)	1398	25.4x144		SK-1391	BTK
1.4 HDi	01/03-03/05	8HX (DV4TD)	1398	25.4x144		SK-1391AQ1	BTKW
1.4 i	04/97-03/05	KFW (TU3JP), KFX (TU3JP)	1360	17x108; :→3666765		SK-1004	BTK
1.4 i	04/97-03/05	KFW (TU3JP), KFX (TU3JP)	1360	17x108; :→3666765		SK-1004AQ1	BTKW
1.4 i	04/97-03/05	KFW (TU3JP), KFX (TU3JP)	1360	17x104; :3666766→		SK-1354	BTK
1.4 i	04/97-03/05	KFW (TU3JP), KFX (TU3JP)	1360	17x104; :3666766→		SK-1354AQ1	BTKW
1.5 D	04/97-09/00	VJZ (TUD5)	1527	25.4x136; 05/1998 →		SK-1040	BTK
1.5 D	04/97-09/00	VJZ (TUD5)	1527	25.4x136		SK-1040AQ1	BTKW
1.6 16V	09/00-03/05	NFU (TU5JP4)	1587	25.4x134; :→1806404; mit Zubehör		SK-1392	BTK
1.6 16V	09/00-03/05	NFU (TU5JP4)	1587	25.4x134; :→1806404; mit Zubehör		SK-1392AQ1	BTKW
1.6 16V	09/00-03/05	NFU (TU5JP4)	1587	25.4x134; :1806405→		SK-1615	BTK
1.6 16V	09/00-03/05	NFU (TU5JP4)	1587	25.4x134; :1806405→		SK-1615AQ1	BTKW
1.6 i	04/97-09/00	NFZ (TU5JP)	1587	17x101		SK-1020	BTK
1.6 i	04/97-09/00	NFZ (TU5JP)	1587	17x101		SK-1020AQ1	BTKW
1.8 D	04/97-09/00	161A (XUD7), A9A (XUD7)	1769	25.4x136; Baumuster: 161A, A9A		SK-1022	BTK
1.8 i 16V	04/97-09/00	LFY (XU7JP4)	1761	25x136; 07/1997 →; mit Zubehör; Spannrollenbetätigung: automatisch		SK-1399	BTK
1.8 i 16V	04/97-09/00	LFY (XU7JP4)	1761	25x136; mit Zubehör; Spannrollenbetätigung: automatisch		SK-1399AQ1	BTKW
1.8 i, 1.8 i Aut.	04/97-09/00	LFX (XU7JB), LFZ (XU7JP)	1761	17x114		SK-1019	BTK
1.8 TD	10/97-09/00		1761	25.4x136		SK-1022	BTK
1.8 TD	10/97-09/00		1761	25.4x136		SK-1022AQ2	BTKW
1.9 D	04/97-09/00	DJY (XUD9A)	1905	25.4x136; → 09/1998		SK-1022AQ2	BTKW
1.9 D	07/98-03/05	WJY (DW8B), WJZ (DW8)	1868	25.4x140		SK-1086	BTK
1.9 D	07/98-03/05	DW8	1868	25.4x140		SK-1086AQ1	BTKW
1.9 D, 1.9 SD, 1.9 TD	04/97-09/00	DHV (XUD9BSD), DHY (XUD9TE/Y), DJY (XUD9A)	1905	25.4x136		SK-1022	BTK
1.9 SD	01/98-09/00	DHV (XUD9BSD)	1905	25.4x136		SK-1022AQ1	BTKW
1.9 TD	04/97-09/00	DHY (XUD9TE/Y)	1905	25.4x136		SK-1022AQ2	BTKW
2.0 16V	04/97-09/00	RFS (XU10J4RS), RFV (XU10J4R)	1998	25x136		SK-1082	BTK
2.0 16V	04/97-09/00	RFS (XU10J4RS)	1998	25x136; → 03/2000; Orga.→8546		SK-1082AQ2	BTKW
2.0 16V	04/97-09/00	RFS (XU10J4RS)	1998	25.4x137; 04/2000 →; mit Zubehör		SK-1613	BTK
2.0 16V	07/98-09/00	RFV (XU10J4R)	1998	25x136		SK-1082AQ2	BTKW
2.0 16V	09/00-03/05	RFN (EW10J4)	1997	25.4x153		SK-1482	BTK
2.0 16V	09/00-03/05	RFN (EW10J4)	1997	25.4x153		SK-1482AQ1	BTKW
2.0 HDi 109	05/01-03/05	RHZ (DW10ATED)	1997	25x141; mit Zubehör		SK-1085	BTK
2.0 HDi 109, 2.0 HDi 90	02/99-03/05	RHY (DW10TD), RHZ (DW10ATED)	1997	25.4x141; mit Zubehör		SK-1085AQ1	BTKW
2.0 HDi 90	02/99-03/05	RHY (DW10TD)	1997	25x141; 09/1999 → 10/2000; Orga.→8735; mit Zubehör		SK-1085	BTK
1.4 HDi	01/03-03/05	8HX (DV4TD)	1398			0-N1062	TB [TE]
1.4 HDi	01/03-03/05	8HX (DV4TD)	1398			0-N1066	TB [DG]
1.4 i	04/97-03/05	KFW (TU3JP), KFX (TU3JP)	1360	:3666766→		0-N1277	TB [TE]
1.4 i	04/97-03/05	KFW (TU3JP), KFX (TU3JP)	1360	:→3666765		0-N811	TB [TE]
1.5 D	04/97-09/00	VJZ (TUD5)	1527			0-N861	TB [TE]
1.5 D	04/97-09/00	VJZ (TUD5)	1527			0-N862	TB [DG]
1.6 16V	09/00-03/05	NFU (TU5JP4)	1587	:→1806404		0-N1061	TB [TE]
1.6 16V	09/00-03/05	NFU (TU5JP4)	1587	:→1806404		0-N122	TB [DG]
1.6 16V	09/00-03/05	NFU (TU5JP4)	1587	:1806405→		0-N1359	TB [TE]
1.6 16V	09/00-03/05	NFU (TU5JP4)	1587	:1806405→		0-N1360	TB [DG]
1.6 i	04/97-09/00	NFZ (TU5JP)	1587			0-N811	TB [TE]
1.8 D	04/97-09/00	161A (XUD7), A9A (XUD7)	1769			0-N900	TB [DG]
1.8 D	04/97-09/00	161A (XUD7), A9A (XUD7)	1769			0-N901	TB [TE]
1.8 i 16V	04/97-09/00	LFY (XU7JP4)	1761			0-N1058	TB [TE]
1.8 i 16V	04/97-09/00	LFY (XU7JP4)	1761			0-N862	TB [DG]
1.8 i, 1.8 i Aut.	04/97-09/00	LFX (XU7JB), LFZ (XU7JP)	1761			0-N811	TB [TE]
1.8 TD	10/97-09/00		1761			0-N900	TB [DG]

CM³

Art. Nr.



XSARA (N1)

1.8 TD	10/97-09/00		1761			0-N901	TB [TE]	
1.8 VTS	09/00-10/04	6FZ (EW7J4)	1749			0-N1057	TB [TE]	
1.8 VTS	09/00-10/04	6FZ (EW7J4)	1749			0-N1065	TB [DG]	
1.9 D	07/98-03/05	WJY (DW8B), WJZ (DW8)	1868			0-N118P	TB [TE]	
1.9 D	07/98-03/05	WJY (DW8B), WJZ (DW8)	1868			0-N1381	TB [DG]	
1.9 D, 1.9 SD, 1.9 TD	04/97-09/00	DHV (XUD9BSD), DHY (XUD9TE/Y), DJY (XUD9A)	1905			0-N900	TB [DG]	
1.9 D, 1.9 SD, 1.9 TD	04/97-09/00	DHV (XUD9BSD), DHY (XUD9TE/Y), DJY (XUD9A)	1905			0-N901	TB [TE]	
2.0 16V	04/97-09/00	RFS (XU10J4RS)	1998	04/2000 →		0-N1356	TB [TE]	
2.0 16V	04/97-09/00	RFS (XU10J4RS), RFV (XU10J4R)	1998			0-N862	TB [DG]	
2.0 16V	04/97-09/00	RFS (XU10J4RS)	1998	Orga.→08546		0-N943	TB [TE]	
2.0 16V	07/98-09/00	RFV (XU10J4R)	1998			0-N943	TB [TE]	
2.0 16V	09/00-03/05	RFN (EW10J4)	1997			0-N1057	TB [TE]	
2.0 16V	09/00-03/05	RFN (EW10J4)	1997			0-N1065	TB [DG]	
2.0 HDi 109, 2.0 HDi 90	02/99-03/05	RHY (DW10TD), RHZ (DW10ATED)	1997	Orga.→08735		0-N118P	TB [TE]	
2.0 HDi 109, 2.0 HDi 90	02/99-03/05	RHY (DW10TD), RHZ (DW10ATED)	1997	Orga.→08735		0-N119P	TB [DG]	
2.0 HDi 109, 2.0 HDi 90	02/99-03/05	RHY (DW10TD), RHZ (DW10ATED)	1997	Orga.08736→		0-N1381	TB [DG]	
1.4 HDi	01/03-03/05	8HX (DV4TD)	1398			0-N1418	VB [DG]	
1.4 HDi	01/03-03/05	8HX (DV4TD)	1398	☼		0-N1420	VB [DG]	
1.4 HDi	01/03-03/05	8HX (DV4TD)	1398			0-N1636	VB [BT]	S
1.4 i	04/97-03/05	KFW (TU3JP), KFX (TU3JP)	1360	Orga.09156→; ☼		0-N1419	VB [DG]	
1.4 i	04/97-03/05	KFW (TU3JP), KFX (TU3JP)	1360	Orga.→09155; ☼		0-N1446	VB [DG]	
1.4 i	04/97-03/05	KFW (TU3JP), KFX (TU3JP)	1360	Orga.→09155; ☼		0-N1486	VB [BT]	S
1.4 i	04/97-03/05	KFW (TU3JP), KFX (TU3JP)	1360	Orga.09156→; ☼		0-N1620	VB [BT]	S
1.4 i	04/97-03/05	KFW (TU3JP), KFX (TU3JP)	1360	Orga.→09155; ☼		0-N1916	VB [BT]	
1.4 i	04/97-03/05	KFW (TU3JP), KFX (TU3JP)	1360			0-N1949	VB [TE]	
1.5 D	04/97-09/00	VJZ (TUD5)	1527			0-N2015	VB [BT]	
1.6 16V	09/00-03/05	NFU (TU5JP4)	1587	Orga.09156→; ☼		0-N1419	VB [DG]	
1.6 16V	09/00-03/05	NFU (TU5JP4)	1587	Orga.→09155; ☼		0-N1446	VB [DG]	
1.6 16V	09/00-03/05	NFU (TU5JP4)	1587	Orga.→09155; ☼		0-N1486	VB [BT]	S
1.6 16V	09/00-03/05	NFU (TU5JP4)	1587	Orga.09156→; ☼		0-N1620	VB [BT]	S
1.6 16V	09/00-03/05	NFU (TU5JP4)	1587	Orga.→09155; ☼		0-N1916	VB [BT]	
1.6 16V	09/00-03/05	NFU (TU5JP4)	1587			0-N1949	VB [TE]	
1.6 i	04/97-09/00	NFZ (TU5JP)	1587			0-N125	VB [TE]	S
1.8 D	04/97-09/00	161A (XUD7), A9A (XUD7)	1769			0-N1320	VB [TE]	
1.8 D	04/97-09/00	161A (XUD7), A9A (XUD7)	1769			0-N1747	VB [VD]	
1.8 D	04/97-09/00	161A (XUD7), A9A (XUD7)	1769			0-N931	VB [TE]	
1.8 i 16V	04/97-09/00	LFY (XU7JP4)	1761	Generator-Ladestrom [A]: 90; ☼		0-N1402	VB [DG]	S
1.8 i 16V	04/97-09/00	LFY (XU7JP4)	1761	Generator-Ladestrom [A]: 120; ☼		0-N1465S	VB [DG]	
1.8 i, 1.8 i 16V, 1.8 i Aut.	04/97-09/00	LFX (XU7JB), LFY (XU7JP4), LFZ (XU7JP)	1761	Orga.→7904		0-N124	VB [TE]	
1.8 i, 1.8 i 16V, 1.8 i Aut.	04/97-09/00	LFX (XU7JB), LFY (XU7JP4), LFZ (XU7JP)	1761	☼		0-N1484	VB [BT]	S
1.8 i, 1.8 i 16V, 1.8 i Aut.	04/97-09/00	LFX (XU7JB), LFY (XU7JP4), LFZ (XU7JP)	1761	Orga.7905→; ☼		0-N1968	VB [BT]	
1.8 i, 1.8 i Aut.	04/97-09/00	LFX (XU7JB), LFZ (XU7JP)	1761	☼		0-N1405	VB [DG]	
1.8 VTS	09/00-10/04	6FZ (EW7J4)	1749	Generator-Ladestrom [A]: 90; ☼		0-N1402	VB [DG]	S
1.8 VTS	09/00-10/04	6FZ (EW7J4)	1749	☼		0-N1416	VB [DG]	
1.9 D	07/98-03/05	DW8B	1868	für Fahrzeuge mit Servolenkung		0-N1309	VB [DG]	
1.9 D	07/98-03/05	DW8	1868	Orga.08375→; für Fahrzeuge mit Servolenkung		0-N1309	VB [DG]	
1.9 D	07/98-03/05	WJY (DW8B), WJZ (DW8)	1868			0-N1320	VB [TE]	
1.9 D	07/98-03/05	DW8	1868	Orga.→08374		0-N1455	VB [TE]	
1.9 D	07/98-03/05	DW8, DW8B	1868	Orga.08375→; für Fahrzeuge mit Servolenkung, ☼		0-N1471	VB [BT]	S
1.9 D	07/98-03/05	WJY (DW8B), WJZ (DW8)	1868	Orga.→09610; ☼, für Fahrzeuge mit Servolenkung		0-N1472	VB [BT]	S
1.9 D	07/98-03/05	WJY (DW8B), WJZ (DW8)	1868			0-N1545	VB [DG]	
1.9 D	07/98-03/05	WJY (DW8B), WJZ (DW8)	1868	☼, ☼, ☼, für Fahrzeuge ohne Servolenkung		0-N1681	VB [BT]	
1.9 D	07/98-03/05	WJY (DW8B), WJZ (DW8)	1868	Orga.→09610; ☼, für Fahrzeuge mit Servolenkung		0-N1747	VB [VD]	
1.9 D	07/98-03/05	WJY (DW8B), WJZ (DW8)	1868	Orga.09611→; ☼, für Fahrzeuge mit Servolenkung		0-N1945	VB [BT]	S
1.9 D, 1.9 SD, 1.9 TD	04/97-09/00	DHV (XUD9BSD), DHY (XUD9TE/Y), DJY (XUD9A)	1905			0-N1320	VB [TE]	
1.9 D, 1.9 SD, 1.9 TD	04/97-09/00	DHV (XUD9BSD), DHY (XUD9TE/Y), DJY (XUD9A)	1905			0-N1472	VB [BT]	S
1.9 D, 1.9 SD, 1.9 TD	04/97-09/00	DHV (XUD9BSD), DHY (XUD9TE/Y), DJY (XUD9A)	1905			0-N1747	VB [VD]	



CM³



Art. Nr.



ohne Halter

XSARA (N1)							
1.9 D, 1.9 SD, 1.9 TD	04/97-09/00	DHV (XUD9BSD), DHY (XUD9TE/Y), DJY (XUD9A)	1905			0-N931	VB [TE]
2.0 16V	04/97-09/00	RFS (XU10J4RS), RFV (XU10J4R)	1998			0-N1463S	VB [DG]
2.0 16V	04/97-09/00	RFS (XU10J4RS), RFV (XU10J4R)	1998			0-N1713	VB [BT]
2.0 16V	04/97-09/00	RFS (XU10J4RS), RFV (XU10J4R)	1998			0-N1722	VB [DG]
2.0 16V	09/00-03/05	RFN (EW10J4)	1997			0-N1391	VB [BT] S
2.0 16V	09/00-03/05	RFN (EW10J4)	1997			0-N1416	VB [DG]
2.0 HDi 109, 2.0 HDi 90	02/99-03/05	RHY (DW10TD), RHZ (DW10ATED)	1997			0-N1320	VB [TE]
2.0 HDi 109, 2.0 HDi 90	02/99-03/05	RHY (DW10TD), RHZ (DW10ATED)	1997			0-N1493	VB [BT] S
2.0 HDi 109, 2.0 HDi 90	02/99-03/05	RHY (DW10TD), RHZ (DW10ATED)	1997			0-N151	VB [DG]
2.0 HDi 109, 2.0 HDi 90	02/99-03/05	RHY (DW10TD), RHZ (DW10ATED)	1997			0-N1748	VB [BT]
XSARA Break (N2)							
1.4 HDi	01/03-08/05	8HX (DV4TD)	1398		25.4x144	SK-1391	BTK
1.4 HDi	01/03-08/05	8HX (DV4TD)	1398		25.4x144	SK-1391AQ1	BTKW
1.4 i	10/97-08/05	KFW (TU3JP), KFX (TU3JP)	1360		17x108; 05/1998 →; : →3666765	SK-1004	BTK
1.4 i	10/97-08/05	KFW (TU3JP), KFX (TU3JP)	1360		17x108; : →3666765	SK-1004AQ1	BTKW
1.4 i	10/97-08/05	KFW (TU3JP), KFX (TU3JP)	1360		17x104; 05/1998 →; :3666766→	SK-1354	BTK
1.4 i	10/97-08/05	KFW (TU3JP), KFX (TU3JP)	1360		17x104; :3666766→	SK-1354AQ1	BTKW
1.5 D	10/97-09/00	VJZ (TUD5)	1527		25.4x136	SK-1040	BTK
1.5 D	10/97-09/00	VJZ (TUD5)	1527		25.4x136	SK-1040AQ1	BTKW
1.6 16V	09/00-08/05	NFU (TU5JP4)	1587		25.4x134; : →1806404; mit Zubehör	SK-1392	BTK
1.6 16V	09/00-08/05	NFU (TU5JP4)	1587		25.4x134; : →1806404; mit Zubehör	SK-1392AQ1	BTKW
1.6 16V	09/00-08/05	NFU (TU5JP4)	1587		25.4x134; :1806405→	SK-1615	BTK
1.6 16V	09/00-08/05	NFU (TU5JP4)	1587		25.4x134; :1806405→	SK-1615AQ1	BTKW
1.6 i	10/97-09/00	NFZ (TU5JP)	1587		17x101; 05/1998 →	SK-1020	BTK
1.6 i	10/97-09/00	NFZ (TU5JP)	1587		17x101	SK-1020AQ1	BTKW
1.8 D	10/97-09/00	A9A (XUD7)	1769		25.4x136; Baumuster: A9A	SK-1022	BTK
1.8 i	10/97-09/00	LFX (XU7JB)	1761		17x114; 05/1998 →	SK-1019	BTK
1.8 i 16V	10/97-09/00	LFY (XU7JP4)	1761		25x136; 05/1998 →; mit Zubehör; Spannrollenbetätigung: automatisch	SK-1399	BTK
1.8 i 16V, 1.8 LPG	10/97-09/00	LFY (XU7JP4)	1761		25x136; mit Zubehör; Spannrollenbetätigung: automatisch	SK-1399AQ1	BTKW
1.8 i Aut.	10/97-09/00	LFZ (XU7JP)	1761		17x114	SK-1019	BTK
1.8 LPG	05/98-08/00	LFY (XU7JP4)	1761		25x136; mit Zubehör; Spannrollenbetätigung: automatisch	SK-1399	BTK
1.9 D	10/97-09/00	DHV (XUD9BSD), DJY (XUD9A)	1905		25.4x136	SK-1022	BTK
1.9 D	10/97-09/00	DJY (XUD9A)	1905		25.4x136; → 09/1998	SK-1022AQ2	BTKW
1.9 D	01/98-09/00	DHV (XUD9BSD)	1905		25.4x136	SK-1022AQ1	BTKW
1.9 D	07/98-08/05	WJY (DW8B), WJZ (DW8)	1868		25.4x140	SK-1086	BTK
1.9 D	07/98-08/05	DW8	1868		25.4x140	SK-1086AQ1	BTKW
1.9 TD	10/97-09/00	DHY (XUD9TE/Y)	1905		25.4x136; 05/1998 →	SK-1022	BTK
1.9 TD	10/97-09/00	DHY (XUD9TE/Y)	1905		25.4x136	SK-1022AQ2	BTKW
2.0 16V	07/98-09/00	RFV (XU10J4R)	1998		25x136	SK-1082	BTK
2.0 16V	07/98-09/00	RFV (XU10J4R)	1998		25x136	SK-1082AQ2	BTKW
2.0 16V	09/00-08/05	RFN (EW10J4)	1997		25.4x153	SK-1482	BTK
2.0 16V	09/00-08/05	RFN (EW10J4)	1997		25.4x153	SK-1482AQ1	BTKW
2.0 HDi 109	05/01-08/05	RHZ (DW10ATED)	1997		25x141; mit Zubehör	SK-1085	BTK
2.0 HDi 109, 2.0 HDi 90	02/99-08/05	RHY (DW10TD), RHZ (DW10ATED)	1997		25.4x141; mit Zubehör	SK-1085AQ1	BTKW
2.0 HDi 90	02/99-08/05	RHY (DW10TD)	1997		25x141; 06/1999 → 10/2000; Orga. →8735; mit Zubehör	SK-1085	BTK
1.4 HDi	01/03-08/05	8HX (DV4TD)	1398			0-N1062	TB [TE]
1.4 HDi	01/03-08/05	8HX (DV4TD)	1398			0-N1066	TB [DG]
1.4 i	10/97-08/05	KFW (TU3JP), KFX (TU3JP)	1360		:3666766→	0-N1277	TB [TE]
1.4 i	10/97-08/05	KFW (TU3JP), KFX (TU3JP)	1360		: →3666765	0-N811	TB [TE]
1.5 D	10/97-09/00	VJZ (TUD5)	1527			0-N861	TB [TE]
1.5 D	10/97-09/00	VJZ (TUD5)	1527			0-N862	TB [DG]
1.6 16V	09/00-08/05	NFU (TU5JP4)	1587		: →1806404	0-N1061	TB [TE]
1.6 16V	09/00-08/05	NFU (TU5JP4)	1587		: →1806404	0-N122	TB [DG]
1.6 16V	09/00-08/05	NFU (TU5JP4)	1587		:1806405→	0-N1359	TB [TE]
1.6 16V	09/00-08/05	NFU (TU5JP4)	1587		:1806405→	0-N1360	TB [DG]
1.6 i	10/97-09/00	NFZ (TU5JP)	1587			0-N811	TB [TE]
1.8 D	10/97-09/00	A9A (XUD7)	1769			0-N900	TB [DG]
1.8 D	10/97-09/00	A9A (XUD7)	1769			0-N901	TB [TE]
1.8 i 16V	10/97-09/00	LFY (XU7JP4)	1761			0-N1058	TB [TE]
1.8 i 16V	10/97-09/00	LFY (XU7JP4)	1761			0-N862	TB [DG]
1.8 i, 1.8 i Aut.	10/97-09/00	LFX (XU7JB), LFZ (XU7JP)	1761			0-N811	TB [TE]



OPTIMAL®

CITROËN



CM³



Art. Nr.



XSARA Break (N2)

1.9 D	07/98-08/05	WJY (DW8B), WJZ (DW8)	1868		0-N118P	TB [TE]	
1.9 D	07/98-08/05	WJY (DW8B), WJZ (DW8)	1868		0-N1381	TB [DG]	
1.9 D, 1.9 TD	10/97-09/00	DHV (XUD9BSD), DHY (XUD9TE/Y), DJY (XUD9A)	1905		0-N900	TB [DG]	
1.9 D, 1.9 TD	10/97-09/00	DHV (XUD9BSD), DHY (XUD9TE/Y), DJY (XUD9A)	1905		0-N901	TB [TE]	
2.0 16V	07/98-09/00	RFV (XU10J4R)	1998		0-N862	TB [DG]	
2.0 16V	07/98-09/00	RFV (XU10J4R)	1998		0-N943	TB [TE]	
2.0 16V	09/00-08/05	RFN (EW10J4)	1997		0-N1057	TB [TE]	
2.0 16V	09/00-08/05	RFN (EW10J4)	1997		0-N1065	TB [DG]	
2.0 HDi 109, 2.0 HDi 90	02/99-08/05	RHY (DW10TD), RHZ (DW10ATED)	1997	Orga.→08735	0-N118P	TB [TE]	
2.0 HDi 109, 2.0 HDi 90	02/99-08/05	RHY (DW10TD), RHZ (DW10ATED)	1997	Orga.→08735	0-N119P	TB [DG]	
2.0 HDi 109, 2.0 HDi 90	02/99-08/05	RHY (DW10TD), RHZ (DW10ATED)	1997	Orga.08736→	0-N1381	TB [DG]	
1.4 HDi	01/03-08/05	8HX (DV4TD)	1398		0-N1418	VB [DG]	
1.4 HDi	01/03-08/05	8HX (DV4TD)	1398	☞	0-N1420	VB [DG]	
1.4 HDi	01/03-08/05	8HX (DV4TD)	1398		0-N1636	VB [BT]	S
1.4 i	10/97-08/05	KFW (TU3JP), KFX (TU3JP)	1360	Orga.09156→; ☞	0-N1419	VB [DG]	
1.4 i	10/97-08/05	KFW (TU3JP), KFX (TU3JP)	1360	Orga.→09155; ☞	0-N1446	VB [DG]	
1.4 i	10/97-08/05	KFW (TU3JP), KFX (TU3JP)	1360	Orga.→09155; ☞	0-N1486	VB [BT]	S
1.4 i	10/97-08/05	KFW (TU3JP), KFX (TU3JP)	1360	Orga.09156→; ☞	0-N1620	VB [BT]	S
1.4 i	10/97-08/05	KFW (TU3JP), KFX (TU3JP)	1360	Orga.→09155; ☞	0-N1916	VB [BT]	
1.4 i	10/97-08/05	KFW (TU3JP), KFX (TU3JP)	1360		0-N1949	VB [TE]	
1.5 D	10/97-09/00	VJZ (TUD5)	1527		0-N2015	VB [BT]	
1.6 16V	09/00-08/05	NFU (TU5JP4)	1587	Orga.09156→; ☞	0-N1419	VB [DG]	
1.6 16V	09/00-08/05	NFU (TU5JP4)	1587	Orga.→09155; ☞	0-N1446	VB [DG]	
1.6 16V	09/00-08/05	NFU (TU5JP4)	1587	Orga.→09155; ☞	0-N1486	VB [BT]	S
1.6 16V	09/00-08/05	NFU (TU5JP4)	1587	Orga.09156→; ☞	0-N1620	VB [BT]	S
1.6 16V	09/00-08/05	NFU (TU5JP4)	1587	Orga.→09155; ☞	0-N1916	VB [BT]	
1.6 16V	09/00-08/05	NFU (TU5JP4)	1587		0-N1949	VB [TE]	
1.6 i	10/97-09/00	NFZ (TU5JP)	1587		0-N125	VB [TE]	S
1.8 D	10/97-09/00	A9A (XUD7)	1769		0-N1320	VB [TE]	
1.8 D	10/97-09/00	A9A (XUD7)	1769		0-N1747	VB [VD]	
1.8 D	10/97-09/00	A9A (XUD7)	1769		0-N931	VB [TE]	
1.8 i 16V	10/97-09/00	LFY (XU7JP4)	1761	Generator-Ladestrom [A]: 90; ☞	0-N1402	VB [DG]	S
1.8 i 16V	10/97-09/00	LFY (XU7JP4)	1761	Generator-Ladestrom [A]: 120; ☞	0-N1465S	VB [DG]	
1.8 i, 1.8 i 16V, 1.8 i Aut.	10/97-09/00	LFX (XU7JB), LFY (XU7JP4), LFZ (XU7JP)	1761	Orga.→7904	0-N124	VB [TE]	
1.8 i, 1.8 i 16V, 1.8 i Aut.	10/97-09/00	LFX (XU7JB), LFY (XU7JP4), LFZ (XU7JP)	1761	Orga.7905→; ☞	0-N1968	VB [BT]	
1.8 i, 1.8 i Aut.	10/97-09/00	LFX (XU7JB), LFZ (XU7JP)	1761	☞	0-N1405	VB [DG]	
1.8 i, 1.8 i Aut.	10/97-09/00	LFX (XU7JB), LFZ (XU7JP)	1761	☞	0-N1484	VB [BT]	S
1.9 D	07/98-08/05	DW8B	1868	für Fahrzeuge mit Servolenkung	0-N1309	VB [DG]	
1.9 D	07/98-08/05	DW8	1868	Orga.08375→; für Fahrzeuge mit Servolenkung	0-N1309	VB [DG]	
1.9 D	07/98-08/05	WJY (DW8B), WJZ (DW8)	1868		0-N1320	VB [TE]	
1.9 D	07/98-08/05	DW8	1868	Orga.→08374	0-N1455	VB [TE]	
1.9 D	07/98-08/05	DW8, DW8B	1868	Orga.08375→; für Fahrzeuge mit Servolenkung, ☞	0-N1471	VB [BT]	S
1.9 D	07/98-08/05	WJY (DW8B), WJZ (DW8)	1868	Orga.→09610; ☞, für Fahrzeuge mit Servolenkung	0-N1472	VB [BT]	S
1.9 D	07/98-08/05	WJY (DW8B), WJZ (DW8)	1868		0-N1545	VB [DG]	
1.9 D	07/98-08/05	WJY (DW8B), WJZ (DW8)	1868	☞, ☞, für Fahrzeuge ohne Servolenkung	0-N1681	VB [BT]	
1.9 D	07/98-08/05	WJY (DW8B), WJZ (DW8)	1868	Orga.→09610; ☞, für Fahrzeuge mit Servolenkung	0-N1747	VB [VD]	
1.9 D	07/98-08/05	WJY (DW8B), WJZ (DW8)	1868	Orga.09611→; ☞, für Fahrzeuge mit Servolenkung	0-N1945	VB [BT]	S
1.9 D, 1.9 TD	10/97-09/00	DHV (XUD9BSD), DHY (XUD9TE/Y), DJY (XUD9A)	1905		0-N1320	VB [TE]	
1.9 D, 1.9 TD	10/97-09/00	DHV (XUD9BSD), DHY (XUD9TE/Y), DJY (XUD9A)	1905		0-N1472	VB [BT]	S
1.9 D, 1.9 TD	10/97-09/00	DHV (XUD9BSD), DHY (XUD9TE/Y), DJY (XUD9A)	1905		0-N1747	VB [VD]	
1.9 D, 1.9 TD	10/97-09/00	DHV (XUD9BSD), DHY (XUD9TE/Y), DJY (XUD9A)	1905		0-N931	VB [TE]	
2.0 16V	07/98-09/00	RFV (XU10J4R)	1998	☞	0-N1463S	VB [DG]	
2.0 16V	07/98-09/00	RFV (XU10J4R)	1998	☞	0-N1713	VB [BT]	
2.0 16V	07/98-09/00	RFV (XU10J4R)	1998	☞	0-N1722	VB [DG]	
2.0 16V	09/00-08/05	RFN (EW10J4)	1997		0-N1391	VB [BT]	S
2.0 16V	09/00-08/05	RFN (EW10J4)	1997		0-N1416	VB [DG]	
2.0 HDi 109, 2.0 HDi 90	02/99-08/05	RHY (DW10TD), RHZ (DW10ATED)	1997		0-N1320	VB [TE]	



CM³



Art. Nr.



ohne Halter

XSARA Break (N2)							
2.0 HDi 109, 2.0 HDi 90	02/99-08/05	RHY (DW10TD), RHZ (DW10ATED)	1997			0-N1493	VB [BT] S
2.0 HDi 109, 2.0 HDi 90	02/99-08/05	RHY (DW10TD), RHZ (DW10ATED)	1997	☞		0-N151	VB [DG]
2.0 HDi 109, 2.0 HDi 90	02/99-08/05	RHY (DW10TD), RHZ (DW10ATED)	1997	☞		0-N1748	VB [BT]
XSARA Coupe (N0)							
1.4 HDi	01/03-03/05	8HX (DV4TD)	1398	25.4x144; 05/2003 →		SK-1391	BTK
1.4 HDi	01/03-03/05	8HX (DV4TD)	1398	25.4x144; 05/2003 →		SK-1391AQ1	BTKW
1.4 i	03/98-03/05	KFW (TU3JP), KFX (TU3JP)	1360	17x108; ☞:3666765		SK-1004	BTK
1.4 i	03/98-03/05	KFW (TU3JP), KFX (TU3JP)	1360	17x108; ☞:3666765		SK-1004AQ1	BTKW
1.4 i	03/98-03/05	KFW (TU3JP), KFX (TU3JP)	1360	17x104; ☞:3666766→		SK-1354	BTK
1.4 i	03/98-03/05	KFW (TU3JP), KFX (TU3JP)	1360	17x104; ☞:3666766→		SK-1354AQ1	BTKW
1.6 16V	09/00-03/05	NFU (TU5JP4)	1587	25.4x134; ☞:1806404; mit Zubehör		SK-1392	BTK
1.6 16V	09/00-03/05	NFU (TU5JP4)	1587	25.4x134; ☞:1806404; mit Zubehör		SK-1392AQ1	BTKW
1.6 16V	09/00-03/05	NFU (TU5JP4)	1587	25.4x134; ☞:1806405→		SK-1615	BTK
1.6 16V	09/00-03/05	NFU (TU5JP4)	1587	25.4x134; ☞:1806405→		SK-1615AQ1	BTKW
1.6 i	02/98-09/00	NFZ (TU5JP)	1587	17x101		SK-1020	BTK
1.6 i	02/98-09/00	NFZ (TU5JP)	1587	17x101		SK-1020AQ1	BTKW
1.8 i	02/98-09/00	LFX (XU7JB), LFZ (XU7JP)	1761	17x114		SK-1019	BTK
1.8 i 16V	02/98-09/00	LFY (XU7JP4)	1761	25x136; mit Zubehör; Spannrollenbetätigung: automatisch		SK-1399	BTK
1.8 i 16V	02/98-09/00	LFY (XU7JP4)	1761	25x136; mit Zubehör; Spannrollenbetätigung: automatisch		SK-1399AQ1	BTKW
1.9 D	02/99-03/05	WJY (DW8B), WJZ (DW8)	1868	25.4x140; 06/1999 →		SK-1086	BTK
1.9 D	02/99-03/05	DW8	1868	25.4x140		SK-1086AQ1	BTKW
1.9 D, 1.9 TD	02/98-09/00	DHY (XUD9TE/Y), DJY (XUD9A)	1905	25.4x136		SK-1022	BTK
1.9 D, 1.9 TD	02/98-09/00	DHY (XUD9TE/Y), DJY (XUD9A)	1905	25.4x136		SK-1022AQ2	BTKW
2.0 16V	09/00-03/05	RFN (EW10J4)	1997	25.4x153		SK-1482	BTK
2.0 16V	09/00-03/05	RFN (EW10J4)	1997	25.4x153		SK-1482AQ1	BTKW
2.0 HDi 109	05/01-03/05	RHZ (DW10ATED)	1997	25x141; mit Zubehör		SK-1085	BTK
2.0 HDi 109, 2.0 HDi 90	02/99-03/05	RHY (DW10TD), RHZ (DW10ATED)	1997	25.4x141; mit Zubehör		SK-1085AQ1	BTKW
2.0 HDi 90	02/99-03/05	RHY (DW10TD)	1997	25x141; 06/1999 → 10/2000; Orga.→8735; mit Zubehör		SK-1085	BTK
2.0 i 16V	02/98-03/05	RFS (XU10J4RS)	1998	25x136; → 03/2000; Orga.→8546		SK-1082	BTK
2.0 i 16V	02/98-03/05	RFS (XU10J4RS)	1998	25x136; → 03/2000; Orga.→8546		SK-1082AQ2	BTKW
2.0 i 16V	02/98-03/05	RFS (XU10J4RS)	1998	25.4x137; 04/2000 → 08/2000; mit Zubehör		SK-1613	BTK
1.4 HDi	01/03-03/05	8HX (DV4TD)	1398			0-N1062	TB [TE]
1.4 HDi	01/03-03/05	8HX (DV4TD)	1398			0-N1066	TB [DG]
1.4 i	03/98-03/05	KFW (TU3JP), KFX (TU3JP)	1360	☞:3666766→		0-N1277	TB [TE]
1.4 i	03/98-03/05	KFW (TU3JP), KFX (TU3JP)	1360	☞:3666765		0-N811	TB [TE]
1.6 16V	09/00-03/05	NFU (TU5JP4)	1587	☞:1806404		0-N1061	TB [TE]
1.6 16V	09/00-03/05	NFU (TU5JP4)	1587	☞:1806404		0-N122	TB [DG]
1.6 16V	09/00-03/05	NFU (TU5JP4)	1587	☞:1806405→		0-N1359	TB [TE]
1.6 16V	09/00-03/05	NFU (TU5JP4)	1587	☞:1806405→		0-N1360	TB [DG]
1.6 i	02/98-09/00	NFZ (TU5JP)	1587			0-N811	TB [TE]
1.8 i	02/98-09/00	LFX (XU7JB), LFZ (XU7JP)	1761			0-N811	TB [TE]
1.8 i 16V	02/98-09/00	LFY (XU7JP4)	1761			0-N1058	TB [TE]
1.8 i 16V	02/98-09/00	LFY (XU7JP4)	1761			0-N862	TB [DG]
1.8 VTS	09/00-10/04	6FZ (EW7J4)	1749			0-N1057	TB [TE]
1.8 VTS	09/00-10/04	6FZ (EW7J4)	1749			0-N1065	TB [DG]
1.9 D	02/99-03/05	WJY (DW8B), WJZ (DW8)	1868			0-N118P	TB [TE]
1.9 D	02/99-03/05	WJY (DW8B), WJZ (DW8)	1868			0-N1381	TB [DG]
1.9 D, 1.9 TD	02/98-09/00	DHY (XUD9TE/Y), DJY (XUD9A)	1905			0-N900	TB [DG]
1.9 D, 1.9 TD	02/98-09/00	DHY (XUD9TE/Y), DJY (XUD9A)	1905			0-N901	TB [TE]
2.0	08/98-08/00	RFV (XU10J4R)	1998			0-N943	TB [TE]
2.0 16V	09/00-03/05	RFN (EW10J4)	1997			0-N1057	TB [TE]
2.0 16V	09/00-03/05	RFN (EW10J4)	1997			0-N1065	TB [DG]
2.0 HDi 109, 2.0 HDi 90	02/99-03/05	RHY (DW10TD), RHZ (DW10ATED)	1997	Orga.→08735		0-N118P	TB [TE]
2.0 HDi 109, 2.0 HDi 90	02/99-03/05	RHY (DW10TD), RHZ (DW10ATED)	1997	Orga.→08735		0-N119P	TB [DG]
2.0 HDi 109, 2.0 HDi 90	02/99-03/05	RHY (DW10TD), RHZ (DW10ATED)	1997	Orga.08736→		0-N1381	TB [DG]
2.0 i 16V	02/98-03/05	RFS (XU10J4RS)	1998	04/2000 →		0-N1356	TB [TE]
2.0 i 16V	02/98-03/05	RFS (XU10J4RS)	1998	Orga.→08546		0-N943	TB [TE]
2.0, 2.0 i 16V	02/98-03/05	RFS (XU10J4RS), RFV (XU10J4R)	1998			0-N862	TB [DG]
1.4 HDi	01/03-03/05	8HX (DV4TD)	1398			0-N1418	VB [DG]
1.4 HDi	01/03-03/05	8HX (DV4TD)	1398	☞		0-N1420	VB [DG]
1.4 HDi	01/03-03/05	8HX (DV4TD)	1398			0-N1636	VB [BT] S
1.4 i	03/98-03/05	KFW (TU3JP), KFX (TU3JP)	1360	Orga.09156→; ☞		0-N1419	VB [DG]
1.4 i	03/98-03/05	KFW (TU3JP), KFX (TU3JP)	1360	Orga.→09155; ☞		0-N1446	VB [DG]



OPTIMAL®

CITROËN

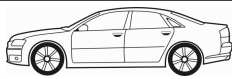

CM³



Art. Nr.



ohne Halter

XSARA Coupe (N0)

1.4 i	03/98-03/05	KFW (TU3JP), KFX (TU3JP)	1360	Orga.→09155; ⚡	0-N1486	VB [BT]	S
1.4 i	03/98-03/05	KFW (TU3JP), KFX (TU3JP)	1360	Orga.09156→; ⚡	0-N1620	VB [BT]	S
1.4 i	03/98-03/05	KFW (TU3JP), KFX (TU3JP)	1360	Orga.→09155; ⚡	0-N1916	VB [BT]	
1.4 i	03/98-03/05	KFW (TU3JP), KFX (TU3JP)	1360		0-N1949	VB [TE]	
1.6 16V	09/00-03/05	NFU (TU5JP4)	1587	Orga.09156→; ⚡	0-N1419	VB [DG]	
1.6 16V	09/00-03/05	NFU (TU5JP4)	1587	Orga.→09155; ⚡	0-N1446	VB [DG]	
1.6 16V	09/00-03/05	NFU (TU5JP4)	1587	Orga.→09155; ⚡	0-N1486	VB [BT]	S
1.6 16V	09/00-03/05	NFU (TU5JP4)	1587	Orga.09156→; ⚡	0-N1620	VB [BT]	S
1.6 16V	09/00-03/05	NFU (TU5JP4)	1587	Orga.→09155; ⚡	0-N1916	VB [BT]	
1.6 16V	09/00-03/05	NFU (TU5JP4)	1587		0-N1949	VB [TE]	
1.8 i	02/98-09/00	LFX (XU7JB)	1761	⚡	0-N1405	VB [DG]	
1.8 i	02/98-09/00	LFX (XU7JB), LFZ (XU7JP)	1761	⚡	0-N1484	VB [BT]	S
1.8 i 16V	02/98-09/00	LFY (XU7JP4)	1761	Generator-Ladestrom [A]: 90; ⚡	0-N1402	VB [DG]	S
1.8 i 16V	02/98-09/00	LFY (XU7JP4)	1761	Generator-Ladestrom [A]: 120; ⚡	0-N1465S	VB [DG]	
1.8 i, 1.8 i 16V	02/98-09/00	LFX (XU7JB), LFY (XU7JP4)	1761	Orga.→7904	0-N124	VB [TE]	
1.8 i, 1.8 i 16V	02/98-09/00	LFX (XU7JB), LFY (XU7JP4)	1761	Orga.7905→; ⚡	0-N1968	VB [BT]	
1.8 VTS	09/00-10/04	6FZ (EW7J4)	1749	Generator-Ladestrom [A]: 90; ⚡	0-N1402	VB [DG]	S
1.8 VTS	09/00-10/04	6FZ (EW7J4)	1749	⚡	0-N1416	VB [DG]	
1.9 D	02/98-05/99	XUD9	1905		0-N1320	VB [TE]	
1.9 D	02/99-03/05	DW8B	1868	für Fahrzeuge mit Servolenkung	0-N1309	VB [DG]	
1.9 D	02/99-03/05	DW8	1868	Orga.08375→; für Fahrzeuge mit Servolenkung	0-N1309	VB [DG]	
1.9 D	02/99-03/05	WJY (DW8B), WJZ (DW8)	1868		0-N1320	VB [TE]	
1.9 D	02/99-03/05	DW8	1868	Orga.→08374	0-N1455	VB [TE]	
1.9 D	02/99-03/05	DW8, DW8B	1868	Orga.08375→; für Fahrzeuge mit Servolenkung, ⚡	0-N1471	VB [BT]	S
1.9 D	02/99-03/05	WJY (DW8B), WJZ (DW8)	1868	Orga.→09610; ⚡, für Fahrzeuge mit Servolenkung	0-N1472	VB [BT]	S
1.9 D	02/99-03/05	WJY (DW8B), WJZ (DW8)	1868		0-N1545	VB [DG]	
1.9 D	02/99-03/05	WJY (DW8B), WJZ (DW8)	1868	⚡, ⚡, für Fahrzeuge ohne Servolenkung	0-N1681	VB [BT]	
1.9 D	02/99-03/05	WJY (DW8B), WJZ (DW8)	1868	Orga.→09610; ⚡, für Fahrzeuge mit Servolenkung	0-N1747	VB [VD]	
1.9 D	02/99-03/05	WJY (DW8B), WJZ (DW8)	1868	Orga.09611→; ⚡, für Fahrzeuge mit Servolenkung	0-N1945	VB [BT]	S
1.9 D, 1.9 TD	02/98-09/00	DHY (XUD9TE/Y), DJY (XUD9A)	1905		0-N1320	VB [TE]	
1.9 D, 1.9 TD	02/98-09/00	DHY (XUD9TE/Y), DJY (XUD9A)	1905		0-N1472	VB [BT]	S
1.9 D, 1.9 TD	02/98-09/00	DHY (XUD9TE/Y), DJY (XUD9A)	1905		0-N1747	VB [VD]	
1.9 D, 1.9 TD	02/98-09/00	DHY (XUD9TE/Y), DJY (XUD9A)	1905		0-N931	VB [TE]	
2.0 16V	09/00-03/05	RFN (EW10J4)	1997		0-N1391	VB [BT]	S
2.0 16V	09/00-03/05	RFN (EW10J4)	1997		0-N1416	VB [DG]	
2.0 HDi 109, 2.0 HDi 90	02/99-03/05	RHY (DW10TD), RHZ (DW10ATED)	1997		0-N1320	VB [TE]	
2.0 HDi 109, 2.0 HDi 90	02/99-03/05	RHY (DW10TD), RHZ (DW10ATED)	1997		0-N1493	VB [BT]	S
2.0 HDi 109, 2.0 HDi 90	02/99-03/05	RHY (DW10TD), RHZ (DW10ATED)	1997	⚡	0-N151	VB [DG]	
2.0 HDi 109, 2.0 HDi 90	02/99-03/05	RHY (DW10TD), RHZ (DW10ATED)	1997	⚡	0-N1748	VB [BT]	
2.0 i 16V	02/98-03/05	RFS (XU10J4RS)	1998	⚡	0-N1463S	VB [DG]	
2.0, 2.0 i 16V	02/98-03/05	RFS (XU10J4RS), RFV (XU10J4R)	1998	⚡	0-N1713	VB [BT]	
2.0, 2.0 i 16V	02/98-03/05	RFS (XU10J4RS), RFV (XU10J4R)	1998	⚡	0-N1722	VB [DG]	

XSARA Kasten

2.0 HDi	09/00-03/05	RHY (DW10TD)	1997	25x141; → 10/2000; Orga.→8735; mit Zubehör	SK-1085	BTK	
2.0 HDi	09/00-03/05	RHY (DW10TD)	1997	25.4x141; → 10/2000; Orga.→8735; mit Zubehör	SK-1085AQ1	BTKW	

XSARA PICASSO (N68)

1.6	12/99-	NFV (TU5JP)	1587	17x101; 09/2000 →	SK-1020	BTK	
1.6 16V	09/05-	NFU (TU5JP4)	1587	25.4x134	SK-1615	BTK	
1.6 16V	09/05-	NFU (TU5JP4)	1587	25.4x134	SK-1615AQ1	BTKW	
1.6 Chrono	04/01-10/04		1587	25.4x134; :1806405→	SK-1615AQ1	BTKW	
1.6 HDi	05/04-	9HX (DV6ATED4), 9HY (DV6TED4), 9HZ (DV6TED4)	1560	25x137	SK-1424	BTK	
1.6 HDi	05/04-	9HX (DV6ATED4), 9HY (DV6TED4), 9HZ (DV6TED4)	1560	25x137	SK-1424AQ1	BTKW	
1.6, 1.6 16V, 1.6 Chrono	12/99-10/04	NFU (TU5JP4), NFZ (TU5JP)	1587	17x101	SK-1020	BTK	
1.6, 1.6 Chrono	12/99-10/04	NFU (TU5JP4), NFZ (TU5JP)	1587	17x101	SK-1020AQ1	BTKW	
1.8 16V	02/00-	6FZ (EW7J4)	1749	25.4x153	SK-1482	BTK	
1.8 16V	02/00-	6FZ	1749	25.4x153	SK-1482AQ1	BTKW	
2.0 16V	01/03-	RFN (EW10J4)	1997	25.4x153	SK-1482	BTK	
2.0 16V	01/03-	RFN (EW10J4)	1997	25.4x153	SK-1482AQ1	BTKW	



CM³



Art. Nr.



ohne Halter

XSARA PICASSO (N68)

2.0 HDi	12/99-	RHY (DW10TD)	1997	25x141; → 10/2000; Orga.→08735; mit Zubehör	SK-1085	BTK	
2.0 HDi	12/99-	RHY (DW10TD)	1997	25.4x141; mit Zubehör	SK-1085AQ1	BTKW	
1.6 16V	09/05-	NFU (TU5JP4)	1587		0-N1359	TB [TE]	
1.6 16V	09/05-	NFU (TU5JP4)	1587		0-N1360	TB [DG]	
1.6 HDi	05/04-	9HX (DV6ATED4), 9HY (DV6TED4), 9HZ (DV6TED4)	1560		0-N1062	TB [TE]	
1.6 HDi	05/04-	9HX (DV6ATED4), 9HY (DV6TED4), 9HZ (DV6TED4)	1560		0-N1066	TB [DG]	
1.6, 1.6 Chrono	12/99-10/04	NFV (TU5JP), NFZ (TU5JP)	1587		0-N811	TB [TE]	
1.8 16V	02/00-	6FZ	1749		0-N1057	TB [TE]	
1.8 16V	02/00-	6FZ (EW7J4)	1749		0-N1058	TB [TE]	
1.8 16V	02/00-	6FZ	1749		0-N1065	TB [DG]	
1.8 16V	02/00-	6FZ (EW7J4)	1749		0-N862	TB [DG]	
1.8 SX	06/00-08/05		1761		0-N1057	TB [TE]	
1.8 SX	06/00-08/05		1761		0-N1065	TB [DG]	
2.0 16V	01/03-	RFN (EW10J4)	1997		0-N1057	TB [TE]	
2.0 16V	01/03-	RFN (EW10J4)	1997		0-N1065	TB [DG]	
2.0 HDi	12/99-	RHY (DW10TD)	1997	Orga.→08735	0-N118P	TB [TE]	
2.0 HDi	12/99-	RHY (DW10TD)	1997	Orga.→08735	0-N119P	TB [DG]	
2.0 HDi	12/99-	RHY (DW10TD)	1997	Orga.08736→	0-N1381	TB [DG]	
1.6	12/99-	NFV (TU5JP), NFZ (TU5JP)	1587	Orga.→09155; ☼	0-N1446	VB [DG]	
1.6 16V	09/05-	NFU (TU5JP4)	1587	Orga.→10927; für Fahrzeuge mit Servolenkung	0-N1309	VB [DG]	
1.6 16V	09/05-	NFU (TU5JP4)	1587	☼	0-N1620	VB [BT]	S
1.6 16V	09/05-	NFU (TU5JP4)	1587	☼	0-N1874	VB [BT]	S
1.6 16V	09/05-	NFU (TU5JP4)	1587	Orga.10928→; ☼	0-N2191	VB [DG]	
1.6 HDi	05/04-	9HY (DV6TED4), 9HZ (DV6TED4)	1560		0-N1418	VB [DG]	
1.6 HDi	05/04-	9HX (DV6ATED4), 9HY (DV6TED4), 9HZ (DV6TED4)	1560	☼	0-N1420	VB [DG]	
1.6 HDi	05/04-	9HX (DV6ATED4), 9HY (DV6TED4), 9HZ (DV6TED4)	1560		0-N1636	VB [BT]	S
1.6 HDi	09/05-	9HX (DV6ATED4)	1560		0-N1807	VB [DG]	
1.6 HDi	09/05-	9HX (DV6ATED4)	1560	☼	0-N1808	VB [BT]	S
1.6, 1.6 16V	12/99-	NFU (TU5JP4), NFV (TU5JP), NFZ (TU5JP)	1587		0-N1949	VB [TE]	
1.6, 1.6 Chrono	12/99-10/04	NFV (TU5JP), NFZ (TU5JP)	1587	Orga.09156→; ☼	0-N1419	VB [DG]	
1.6, 1.6 Chrono	12/99-10/04	NFV (TU5JP), NFZ (TU5JP)	1587	Orga.→09155; ☼	0-N1486	VB [BT]	S
1.6, 1.6 Chrono	12/99-10/04	NFV (TU5JP), NFZ (TU5JP)	1587	Orga.09156→; ☼	0-N1620	VB [BT]	S
1.6, 1.6 Chrono	12/99-10/04	NFV (TU5JP), NFZ (TU5JP)	1587	Orga.→09155; ☼	0-N1916	VB [BT]	
1.6, 1.6 Chrono	04/01-10/04	TU5JP	1587	Orga.→09155; ☼	0-N1446	VB [DG]	
1.8 16V	02/00-	6FZ (EW7J4)	1749		0-N124	VB [TE]	
1.8 16V	02/00-	6FZ	1749		0-N1391	VB [BT]	S
1.8 16V	02/00-	6FZ	1749	Generator-Ladestrom [A]: 90; ☼	0-N1402	VB [DG]	S
1.8 16V	02/00-	6FZ	1749	☼	0-N1416	VB [DG]	
1.8 16V	02/00-	6FZ (EW7J4)	1749	Generator-Ladestrom [A]: 120; ☼	0-N1465S	VB [DG]	
1.8 16V	02/00-	6FZ (EW7J4)	1749	Orga.7905→; ☼	0-N1968	VB [BT]	
1.8 SX	06/00-08/05		1761	Generator-Ladestrom [A]: 90; ☼	0-N1402	VB [DG]	S
1.8 SX	06/00-08/05		1761		0-N1416	VB [DG]	
2.0 16V	01/03-	RFN (EW10J4)	1997		0-N1391	VB [BT]	S
2.0 16V	01/03-	RFN (EW10J4)	1997		0-N2276	VB [DG]	
2.0 HDi	12/99-	RHY (DW10TD)	1997	Orga.→10767	0-N1320	VB [TE]	
2.0 HDi	12/99-	RHZ (DW10ATED)	1998	☼	0-N1320	VB [TE]	
2.0 HDi	12/99-	RHY (DW10TD)	1997		0-N1493	VB [BT]	S
2.0 HDi	12/99-	RHY (DW10TD)	1997	☼	0-N151	VB [DG]	
2.0 HDi	12/99-	RHY (DW10TD)	1997	☼	0-N1748	VB [BT]	
2.0 HDi	12/99-	RHY (DW10TD)	1997		0-N2019	VB [DG]	

ZX (N2)

1.1, 1.1	03/91-06/97	H1A, H1B, HDZ (TU1M)	1124	17x104	SK-1003	BTK	
1.1, 1.1	03/91-06/97	H1A, H1B, HDZ (TU1M)	1124	17x104	SK-1003AQ1	BTKW	
1.4	03/91-06/97	KDZ (TU3M/Z)	1360	17x108	SK-1004AQ1	BTKW	
1.4 D	07/94-10/97	K9Y (TUD3Y)	1360	25x143	SK-1005	BTK	
1.4 i	03/91-06/97	KFX	1360	17x108	SK-1004AQ1	BTKW	
1.4, 1.4 i	03/91-06/97	KDX (TU3M/Z), KDZ (TU3M/Z), KFX (TU3JP), KDZ (TU3M/Z)	1360	17x108	SK-1004	BTK	
1.6	07/94-10/97	BDY (XU5M), BFZ (XU5JP)	1580	17x114	SK-1019	BTK	
1.6 i	03/91-06/97	BDY (XU5M), BFZ (XU5JP)	1580	17x113	SK-1006	BTK	
1.6 i	03/91-06/97	BDY (XU5M), BFZ (XU5JP)	1580	17x114; 01/1992 →; Orga.5546→	SK-1019	BTK	

CM³

Art. Nr.



ohne Halter

ZX (N2)

1.8 D	06/93-06/97	161A (XUD7)	1769	25.39x136; → 01/1994; Orga.→06264	SK-1007	BTK	
1.8 D	06/93-06/97	161A (XUD7)	1769	25.4x136; → 09/1993; Orga.→06170	SK-1007AQ1	BTkW	
1.8 D	06/93-06/97	161A (XUD7)	1769	25.4x136; 01/1994 →; Orga.06265→; Baumuster: 161A	SK-1022	BTK	
1.8 D	06/93-06/97	161A (XUD7)	1769	25.4x136; Orga.07390→	SK-1022AQ1	BTkW	
1.8 D	06/93-06/97	161A (XUD7)	1769	25.4x136; Orga.06265→07389	SK-1022AQ2	BTkW	
1.8 i 16V	01/96-06/97	LFY (XU7JP4)	1761	25x136; beinhaltetete Rollen: 3	SK-1082AQ1	BTkW	
1.8, 1.8 i	07/92-10/97	LFZ (XU7JP)	1761	17x114	SK-1019	BTK	
1.8, 1.8 i 16V	01/96-10/97	LFY (XU7JP4)	1761	25x136; mit Zubehör; Spannrollenbetätigung: automatisch	SK-1399	BTK	
1.8, 1.8 i 16V	01/96-10/97	LFY (XU7JP4)	1761	25x136; mit Zubehör; Spannrollenbetätigung: automatisch	SK-1399AQ1	BTkW	
1.9	03/91-09/93	D6E (XU9JA)	1905	17x113; → 01/1992; Orga.→5545	SK-1006	BTK	
1.9 D	03/91-06/97	DJZ (XUD9Y)	1905	25.4x136; Orga.→06170	SK-1007AQ1	BTkW	
1.9 D	03/91-06/97	DJZ (XUD9Y)	1905	25.4x136; Orga.06265→07389	SK-1022AQ2	BTkW	
1.9 D	07/93-06/97	D9B (XUD9A/U), DJY (XUD9A)	1905	25.4x136; Orga.06171→07389	SK-1022AQ2	BTkW	
1.9 D, 1.9 DT	07/93-10/97	D9B (XUD9A/U), DJY (XUD9A)	1905	25.4x136	SK-1022	BTK	
1.9 D, 1.9 DT, 1.9 TD	03/91-06/97	DHY (XUD9TE/Y), DJZ (XUD9Y)	1905	25.4x136; 01/1994 →; Orga.06265→	SK-1022	BTK	
1.9 D, 1.9 TD	03/91-06/97	DHY (XUD9TE/Y), DJZ (XUD9Y)	1905	25.39x136; → 01/1994; Orga.→06264	SK-1007	BTK	
1.9 D, 1.9 TD	03/91-06/97	D9B (XUD9A/U), DJY (XUD9A), DHY (XUD9TE/Y), DJZ (XUD9Y)	1905	25.4x136; Orga.07390→	SK-1022AQ1	BTkW	
1.9 DT	06/92-06/94	DHY (XUD9TE/Y)	1905	25.39x136; → 01/1994; Orga.06264→	SK-1007	BTK	
1.9 DT	06/92-06/94	DHY (XUD9TE/Y)	1905	25.4x136; → 09/1993; Orga.→06170	SK-1007AQ1	BTkW	
1.9 DT	06/92-10/97	DHY (XUD9TE/Y)	1905	25.4x136	SK-1022AQ2	BTkW	
1.9 i	03/91-06/97	DKZ (XU9JA)	1905	17x113	SK-1006	BTK	
1.9 TD	07/92-06/97	DHY (XUD9TE/Y)	1905	25.4x136; → 02/1994	SK-1007AQ1	BTkW	
1.9 TD	07/92-06/97	DHY (XUD9TE/Y)	1905	25.4x136; 03/1994 →; Orga.06265→07389	SK-1022AQ2	BTkW	
1.9, 1.9 i	03/91-06/97	D6E (XU9JA), DKZ (XU9JA)	1905	17x114; 01/1992 →; Orga.5546→	SK-1019	BTK	
2.0 i 16V	07/92-06/97	RFT (XU10J4/Z), RFT (XU10J4/Z), RFY (XU10J4/Z)	1998	25.4x134	SK-1158	BTK	
2.0, 2.0 i	07/92-10/97	RFX (XU10J2C)	1998	17x114	SK-1019	BTK	
2.0, 2.0 i 16V	05/96-10/97	RFS (XU10J4RS)	1998	25x136	SK-1082	BTK	
2.0, 2.0 i 16V	05/96-10/97	RFS (XU10J4RS)	1998	25x136	SK-1082AQ2	BTkW	
1.1	03/91-06/97	HDZ (TU1M)	1124		0-N811	TB [TE]	
1.4 D	07/94-10/97	K9Y (TUD3Y)	1360		0-N861	TB [TE]	
1.4 D	07/94-10/97	K9Y (TUD3Y)	1360		0-N862	TB [DG]	
1.4, 1.4 i	03/91-06/97	KDX (TU3M/Z), KDZ (TU3M/Z), KFX (TU3JP), KDZ (TU3M/Z)	1360		0-N811	TB [TE]	
1.6 i	03/91-06/97	BDY (XU5M), BFZ (XU5JP)	1580	02/1992 →	0-N811	TB [TE]	
1.6 i	03/91-06/97	BDY (XU5M), BFZ (XU5JP)	1580	→ 01/1992	0-N812	TB [TE]	
1.8 D	06/93-06/97	161A (XUD7)	1769	Orga.→06170	0-N813	TB [TE]	
1.8 D	06/93-06/97	161A (XUD7)	1769	Orga.→06170	0-N814	TB [DG]	
1.8 D	06/93-06/97	161A (XUD7)	1769	Orga.06171→	0-N900	TB [DG]	
1.8 D	06/93-06/97	161A (XUD7)	1769	Orga.06171→	0-N901	TB [TE]	
1.8, 1.8 i	07/92-10/97	LFZ (XU7JP)	1761		0-N811	TB [TE]	
1.8, 1.8 i 16V	01/96-10/97	LFY (XU7JP4)	1761		0-N1058	TB [TE]	
1.8, 1.8 i 16V	01/96-10/97	LFY (XU7JP4)	1761		0-N862	TB [DG]	
1.9 D, 1.9 TD	03/91-06/97	D9B (XUD9A/U), DJY (XUD9A), DHY (XUD9TE/Y), DJZ (XUD9Y)	1905	Orga.→06170	0-N813	TB [TE]	
1.9 D, 1.9 TD	03/91-06/97	D9B (XUD9A/U), DJY (XUD9A), DHY (XUD9TE/Y), DJZ (XUD9Y)	1905	Orga.→06170	0-N814	TB [DG]	
1.9 D, 1.9 TD	03/91-06/97	D9B (XUD9A/U), DJY (XUD9A), DHY (XUD9TE/Y), DJZ (XUD9Y)	1905	Orga.06171→	0-N900	TB [DG]	
1.9 D, 1.9 TD	03/91-06/97	D9B (XUD9A/U), DJY (XUD9A), DHY (XUD9TE/Y), DJZ (XUD9Y)	1905	Orga.06171→	0-N901	TB [TE]	
1.9, 1.9 i	03/91-06/97	D6E (XU9JA), DKZ (XU9JA)	1905	02/1992 →	0-N811	TB [TE]	
1.9, 1.9 i	03/91-06/97	D6E (XU9JA), DKZ (XU9JA)	1905	→ 01/1992	0-N812	TB [TE]	
2.0 i	07/92-06/97	RFX (XU10J2C)	1998		0-N811	TB [TE]	
2.0 i 16V	07/92-06/97	RFT (XU10J4/Z), RFT (XU10J4/Z), RFY (XU10J4/Z)	1998		0-N869	TB [TE]	
2.0 i 16V	07/92-06/97	RFT (XU10J4/Z), RFT (XU10J4/Z), RFY (XU10J4/Z)	1998		0-N911	TB [DG]	
2.0 i 16V	05/96-06/97	RFS (XU10J4RS)	1998		0-N862	TB [DG]	
2.0 i 16V	05/96-06/97	RFS (XU10J4RS)	1998		0-N943	TB [TE]	
1.1	03/91-06/97	HDZ (TU1M)	1124		0-N125	VB [TE]	S
1.4, 1.4 i	03/91-06/97	KDX (TU3M/Z), KDZ (TU3M/Z), KFX (TU3JP), KDZ (TU3M/Z)	1360		0-N125	VB [TE]	S
1.6 i	03/91-06/97	XU5JP	1580		0-N124	VB [TE]	
1.6 i	03/91-06/97	XU5JP	1580	✱	0-N1405	VB [DG]	



CM³



Art. Nr.



ohne Halter

ZX (N2)							
1.6 i	03/91-06/97	XU5JP	1580	☼		0-N1484	VB [BT] S
1.6 i	03/91-06/97	XU5M	1580			0-N849	VB [TE]
1.8 D	06/93-06/97	161A (XUD7)	1769		01/1995 →	0-N1320	VB [TE]
1.8 D	06/93-06/97	161A (XUD7)	1769		01/1995 →; ☼	0-N1472	VB [BT] S
1.8 D	06/93-06/97	161A (XUD7)	1769		01/1995 →; ☼	0-N1747	VB [VD]
1.8 D	06/93-06/97	161A (XUD7)	1769		→ 01/1995; ☼	0-N1751	VB [DG]
1.8 D	06/93-06/97	161A (XUD7)	1769		→ 01/1995; ☼	0-N1756	VB [BT]
1.8 D	06/93-06/97	161A (XUD7)	1769			0-N931	VB [TE]
1.8 i	07/92-06/97	LFZ (XU7JP)	1761			0-N124	VB [TE]
1.8 i	07/92-06/97	LFZ (XU7JP)	1761	☼		0-N1405	VB [DG]
1.8 i	07/92-06/97	LFZ (XU7JP)	1761	☼		0-N1484	VB [BT] S
1.8 i 16V	01/96-06/97	LFY (XU7JP4)	1761		Orga.→7904	0-N124	VB [TE]
1.8 i 16V	01/96-06/97	LFY (XU7JP4)	1761		Generator-Ladestrom [A]: 120; ☼	0-N1465S	VB [DG]
1.8 i 16V	01/96-06/97	LFY (XU7JP4)	1761		Orga.7905→; ☼	0-N1968	VB [BT]
1.8, 1.8 i 16V	01/96-10/97	LFY (XU7JP4)	1761		Generator-Ladestrom [A]: 90; ☼	0-N1402	VB [DG] S
1.9 D, 1.9 TD	03/91-06/97	D9B (XUD9A/U), DJY (XUD9A), DHY (XUD9TE/Y), DJZ (XUD9Y)	1905		01/1995 →	0-N1320	VB [TE]
1.9 D, 1.9 TD	03/91-06/97	D9B (XUD9A/U), DJY (XUD9A), DHY (XUD9TE/Y), DJZ (XUD9Y)	1905		01/1995 →; ☼	0-N1472	VB [BT] S
1.9 D, 1.9 TD	03/91-06/97	D9B (XUD9A/U), DJY (XUD9A), DHY (XUD9TE/Y), DJZ (XUD9Y)	1905		01/1995 →; ☼	0-N1747	VB [VD]
1.9 D, 1.9 TD	03/91-06/97	D9B (XUD9A/U), DJY (XUD9A), DHY (XUD9TE/Y), DJZ (XUD9Y)	1905		→ 01/1995; ☼	0-N1751	VB [DG]
1.9 D, 1.9 TD	03/91-06/97	D9B (XUD9A/U), DJY (XUD9A), DHY (XUD9TE/Y), DJZ (XUD9Y)	1905		→ 01/1995; ☼	0-N1756	VB [BT]
1.9 D, 1.9 TD	03/91-06/97	D9B (XUD9A/U), DJY (XUD9A), DHY (XUD9TE/Y), DJZ (XUD9Y)	1905			0-N931	VB [TE]
1.9, 1.9 i	03/91-06/97	D6E (XU9JA), DKZ (XU9JA)	1905			0-N849	VB [TE]
2.0 i 16V	05/96-06/97	RFS (XU10J4RS)	1998	☼		0-N1713	VB [BT]
2.0 i 16V	05/96-06/97	RFS (XU10J4RS)	1998	☼		0-N1722	VB [DG]
2.0 i, 2.0 i 16V	07/92-06/97	RFT (XU10J4/Z), RFT (XU10J4/Z), RFY (XU10J4/Z), RFX (XU10J2C)	1998			0-N124	VB [TE]
2.0 i, 2.0 i 16V	07/92-06/97	RFT (XU10J4/Z), RFT (XU10J4/Z), RFY (XU10J4/Z), RFX (XU10J2C)	1998	☼		0-N1405	VB [DG]
2.0 i, 2.0 i 16V	07/92-06/97	RFT (XU10J4/Z), RFT (XU10J4/Z), RFY (XU10J4/Z), RFX (XU10J2C)	1998	☼		0-N1484	VB [BT] S
ZX Break (N2)							
1.4 i	10/93-10/97	KDX (TU3M/Z), KDY (TU3M), KFX (TU3JP)	1360		17x108; 07/1994 →	SK-1004	BTK
1.4 i	10/93-10/97	KFX	1360		17x108	SK-1004AQ1	BTKW
1.6 i	10/93-10/97	BDY (XU5M), BFZ (XU5JP)	1580		17x113	SK-1006	BTK
1.6 i	10/93-10/97	BDY (XU5M), BFZ (XU5JP)	1580		17x114; 07/1994 →	SK-1019	BTK
1.8 D	10/93-10/97	161A (XUD7)	1769		25.39x136; → 01/1994; Orga.→06264	SK-1007	BTK
1.8 D	10/93-10/97	161A (XUD7)	1769		25.4x136; → 12/1993; Orga.→06170	SK-1007AQ1	BTKW
1.8 D	10/93-10/97	161A (XUD7)	1769		25.4x136; Orga.06265→; Baumuster: 161A	SK-1022	BTK
1.8 D	10/93-10/97	161A (XUD7)	1769		25.4x136; Orga.07390→	SK-1022AQ1	BTKW
1.8 D	10/93-10/97	161A (XUD7)	1769		25.4x136; Orga.06265→07389	SK-1022AQ2	BTKW
1.8 i	10/93-10/97	LFZ (XU7JP)	1761		17x114; 07/1994 →	SK-1019	BTK
1.8 i 16V	01/96-02/98	LFY (XU7JP4)	1761		25x136; beinhaltetete Rollen: 3	SK-1082AQ1	BTKW
1.8 i 16V	01/96-02/98	LFY (XU7JP4)	1761		25x136; mit Zubehör; Spannrollenbetätigung: automatisch	SK-1399	BTK
1.8 i 16V	01/96-02/98	LFY (XU7JP4)	1761		25x136; mit Zubehör; Spannrollenbetätigung: automatisch	SK-1399AQ1	BTKW
1.9 D	10/93-10/97	DJZ (XUD9Y)	1905		25.39x136; → 01/1994; Orga.→06264	SK-1007	BTK
1.9 D	10/93-10/97	DJZ (XUD9Y)	1905		25.4x136; → 02/1994; Orga.→06170	SK-1007AQ1	BTKW
1.9 D	10/93-10/97	DJZ (XUD9Y)	1905		25.4x136; Orga.06265→	SK-1022	BTK
1.9 D	10/93-10/97	DJZ (XUD9Y)	1905		25.4x136; 03/1994 →; Orga.06265→07389	SK-1022AQ2	BTKW
1.9 D	06/94-10/97	D9B (XUD9A/U)	1905		25.4x136	SK-1022	BTK
1.9 D	06/94-10/97	D9B (XUD9A/U)	1905		25.4x136; Orga.06171→07389	SK-1022AQ2	BTKW
1.9 D, 1.9 TD	10/93-10/97	D9B (XUD9A/U), DHY (XUD9TE/Y), DJZ (XUD9Y)	1905		25.4x136; Orga.07390→	SK-1022AQ1	BTKW
1.9 TD	10/93-10/97	DHY (XUD9TE/Y)	1905		25.39x136; → 12/1993; Orga.→06264	SK-1007	BTK
1.9 TD	10/93-10/97	DHY (XUD9TE/Y)	1905		25.4x136; Orga.→6170	SK-1007AQ1	BTKW
1.9 TD	10/93-10/97	DHY (XUD9TE/Y)	1905		25.4x136; 07/1994 →	SK-1022	BTK
1.9 TD	10/93-10/97	DHY (XUD9TE/Y)	1905		25.4x136; Orga.06265→07389	SK-1022AQ2	BTKW
1.4 i	10/93-10/97	KDX (TU3M/Z), KDY (TU3M), KFX (TU3JP)	1360			0-N811	TB [TE]
1.6 i	10/93-10/97	BDY (XU5M), BFZ (XU5JP)	1580			0-N811	TB [TE]
1.8 D	10/93-10/97	161A (XUD7)	1769		Orga.→06170	0-N813	TB [TE]
1.8 D	10/93-10/97	161A (XUD7)	1769		Orga.→06170	0-N814	TB [DG]



CM³



Art. Nr.



ohne Halter

ZX Break (N2)

1.8 D	10/93-10/97	161A (XUD7)	1769	Orga.06171→	0-N900	TB [DG]	
1.8 D	10/93-10/97	161A (XUD7)	1769	Orga.06171→	0-N901	TB [TE]	
1.8 i	10/93-10/97	LFZ (XU7JP)	1761		0-N811	TB [TE]	
1.8 i 16V	01/96-02/98	LFY (XU7JP4)	1761		0-N1058	TB [TE]	
1.8 i 16V	01/96-02/98	LFY (XU7JP4)	1761		0-N862	TB [DG]	
1.9 D, 1.9 TD	10/93-10/97	D9B (XUD9A/U), DHY (XUD9TE/Y), DJZ (XUD9Y)	1905	Orga.→06170	0-N813	TB [TE]	
1.9 D, 1.9 TD	10/93-10/97	D9B (XUD9A/U), DHY (XUD9TE/Y), DJZ (XUD9Y)	1905	Orga.→06170	0-N814	TB [DG]	
1.9 D, 1.9 TD	10/93-10/97	D9B (XUD9A/U), DHY (XUD9TE/Y), DJZ (XUD9Y)	1905	Orga.06171→	0-N900	TB [DG]	
1.9 D, 1.9 TD	10/93-10/97	D9B (XUD9A/U), DHY (XUD9TE/Y), DJZ (XUD9Y)	1905	Orga.06171→	0-N901	TB [TE]	
1.4 i	10/93-10/97	KDX (TU3M/Z), KDY (TU3M), KFX (TU3JP)	1360		0-N125	VB [TE]	S
1.6 i	10/93-10/97	XU5JP	1580		0-N124	VB [TE]	
1.6 i	10/93-10/97	XU5JP	1580	☼	0-N1405	VB [DG]	
1.6 i	10/93-10/97	BFZ	1580	☼	0-N1484	VB [BT]	S
1.6 i	10/93-10/97	XU5M	1580		0-N849	VB [TE]	
1.8 D	10/93-10/97	161A (XUD7)	1769	01/1995 →	0-N1320	VB [TE]	
1.8 D	10/93-10/97	161A (XUD7)	1769	01/1995 →; ☼	0-N1472	VB [BT]	S
1.8 D	10/93-10/97	161A (XUD7)	1769	01/1995 →; ☼	0-N1747	VB [VD]	
1.8 D	10/93-10/97	161A (XUD7)	1769	→ 01/1995; ☼	0-N1751	VB [DG]	
1.8 D	10/93-10/97	161A (XUD7)	1769	→ 01/1995; ☼	0-N1756	VB [BT]	
1.8 D	10/93-10/97	161A (XUD7)	1769		0-N931	VB [TE]	
1.8 i	10/93-10/97	LFZ (XU7JP)	1761		0-N124	VB [TE]	
1.8 i	10/93-10/97	LFZ (XU7JP)	1761	☼	0-N1405	VB [DG]	
1.8 i	10/93-10/97	LFZ (XU7JP)	1761	☼	0-N1484	VB [BT]	S
1.8 i 16V	01/96-02/98	LFY (XU7JP4)	1761	Orga.→7904	0-N124	VB [TE]	
1.8 i 16V	01/96-02/98	LFY (XU7JP4)	1761	Generator-Ladestrom [A]: 90; ☼	0-N1402	VB [DG]	S
1.8 i 16V	01/96-02/98	LFY (XU7JP4)	1761	Generator-Ladestrom [A]: 120; ☼	0-N1465S	VB [DG]	
1.8 i 16V	01/96-02/98	LFY (XU7JP4)	1761	Orga.7905→; ☼	0-N1968	VB [BT]	
1.9 D, 1.9 TD	10/93-10/97	D9B (XUD9A/U), DHY (XUD9TE/Y), DJZ (XUD9Y)	1905	01/1995 →	0-N1320	VB [TE]	
1.9 D, 1.9 TD	10/93-10/97	D9B (XUD9A/U), DHY (XUD9TE/Y), DJZ (XUD9Y)	1905	01/1995 →; ☼	0-N1472	VB [BT]	S
1.9 D, 1.9 TD	10/93-10/97	D9B (XUD9A/U), DHY (XUD9TE/Y), DJZ (XUD9Y)	1905	01/1995 →; ☼	0-N1747	VB [VD]	
1.9 D, 1.9 TD	10/93-10/97	D9B (XUD9A/U), DHY (XUD9TE/Y), DJZ (XUD9Y)	1905	→ 01/1995; ☼	0-N1751	VB [DG]	
1.9 D, 1.9 TD	10/93-10/97	D9B (XUD9A/U), DHY (XUD9TE/Y), DJZ (XUD9Y)	1905	→ 01/1995; ☼	0-N1756	VB [BT]	
1.9 D, 1.9 TD	10/93-10/97	D9B (XUD9A/U), DHY (XUD9TE/Y), DJZ (XUD9Y)	1905		0-N931	VB [TE]	

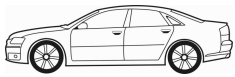

CM³



Art. Nr.



ohne Halter

C-QUATRE - SHI JIA							
2.0	10/08-	EW10A, RFN	1997	25x153	SK-1600	BTK	
C-QUATRE - SHI JIA Stufenheck							
2.0	06/09-	EW10A, RFN	1997	25x153	SK-1600	BTK	
ELYSEE (7B)							
1.6	06/02-04/08	TU5JPK	1587		0-N811	TB [TE]	
FUKANG Schrägheck							
1.4	02/92-12/05	TU3JPK, TU3MC2	1360		0-N811	TB [TE]	
1.6	02/97-12/05	TU5JPK	1587		0-N811	TB [TE]	
FUKANG Stufenheck							
1.4	02/92-08/01	TU3JPK	1360		0-N811	TB [TE]	
XSARA Stufenheck							
2.0	05/03-12/05	EW10J4	1997		0-N1065	TB [DG]	

CM³

Art. Nr.

**DOKKER**

1.5 dCi	11/12-	K9K 612	1461	27x119; Baumuster: Dokker	SK-1730	BTK	
1.5 dCi	11/12-	K9K 612	1461	27x119; Baumuster: Dokker	SK-1730AQ1	BTKW	
1.6 16V	11/12-	K7M 812, K7M 828	1598	17.3x96	SK-1704	BTK	
1.6 16V, 1.6 LPG	11/12-	K7M 812, K7M 828	1598	17.3x96	SK-1704AQ1	BTKW	
1.5 dCi	11/12-	K9K 612	1461		0-N2423	TB [TE]	
1.6 16V	11/12-	K7M 812, K7M 828	1598		0-N2062	TB [TE]	
1.2 TCe	11/12-	H5F 402	1197		0-N2308	VB [BT]	S
1.2 TCe	11/12-	H5F 402	1197	☼	0-N2344	VB [DG]	
1.5 dCi	11/12-	K9K 612	1461	☼	0-N2253	VB [DG]	

DOKKER Express

1.5 dCi	12/12-	K9K 612	1461	27x119	SK-1730	BTK	
1.5 dCi	12/12-	K9K 612	1461	27x119	SK-1730AQ1	BTKW	
1.6 16V	12/12-	K7M 812, K7M 828	1598	17.3x96	SK-1704	BTK	
1.6 16V, 1.6 LPG	12/12-	K7M 812, K7M 828	1598	17.3x96	SK-1704AQ1	BTKW	
1.5 dCi	12/12-	K9K 612	1461		0-N2423	TB [TE]	
1.6 16V	12/12-	K7M 812, K7M 828	1598		0-N2062	TB [TE]	
1.2 TCe 115	12/12-	H5F 402	1198		0-N2308	VB [BT]	S
1.5 dCi	12/12-	K9K 612	1461	☼	0-N2253	VB [DG]	

DUSTER

1.5 dCi	10/10-	K9K 884, K9K 892	1461	27x119	SK-1730	BTK	
1.5 dCi	10/10-	K9K 884, K9K 892	1461	27x119	SK-1730AQ1	BTKW	
1.5 dCi, 1.5 dCi 4x4	04/10-	K9K 796, K9K 830, K9K 884, K9K 892, K9K 884, K9K 894, K9K 896, K9K 898	1461	27x123; mit Zubehör	SK-1487	BTK	
1.5 dCi, 1.5 dCi 4x4	04/10-	K9K 796, K9K 830, K9K 896, K9K 898	1461	27x123; mit Zubehör	SK-1487AQ2	BTKW	
1.5 dCi, 1.5 dCi 4x4	06/10-	K9K 856, K9K 858, K9K 884, K9K 892, K9K 884, K9K 894, K9K 896, K9K 898	1461	27x123; mit Zubehör	SK-1487AQ3	BTKW	
1.6 16V, 1.6 16V 4x4, 1.6 16V Flexifuel	04/10-	K4M 606, K4M 690, K4M 696, K4M 696	1598	27x132; mit Zubehör	SK-1088AQ1	BTKW	
1.6 16V, 1.6 16V 4x4, 1.6 16V Flexifuel, 1.6 16V LPG	04/10-	K4M 606, K4M 690, K4M 696, K4M 696	1598	27x132; mit Zubehör	SK-1088	BTK	
1.5 dCi, 1.5 dCi 4x4	04/10-	K9K 796, K9K 830, K9K 884, K9K 892, K9K 884, K9K 894, K9K 896, K9K 898	1461		0-N1111	TB [TE]	
1.6 16V, 1.6 16V 4x4, 1.6 16V Flexifuel, 1.6 16V LPG	04/10-	K4M 606, K4M 690, K4M 696, K4M 696	1598		0-N198	TB [TE]	
1.6 16V, 1.6 16V 4x4, 1.6 16V Flexifuel, 1.6 16V LPG	04/10-	K4M 606, K4M 690, K4M 696, K4M 696	1598		0-N262	TB [DG]	
1.2 Tce	10/13-	H5F 404	1197		0-N2308	VB [BT]	S
1.5 dCi	10/10-	K9K 884, K9K 892	1461	☼	0-N2253	VB [DG]	
1.5 dCi, 1.5 dCi 4x4	04/10-	K9K 796, K9K 830, K9K 884, K9K 892, K9K 884, K9K 894, K9K 896, K9K 898	1461	☼	0-N1664	VB [BT]	S
1.6 16V	04/10-	K4M 690	1598	→ 06/2010; ☼	0-N1663	VB [BT]	S
1.6 16V	04/10-	K4M 690	1598		0-N1664	VB [BT]	S
1.6 16V	04/10-	K4M 696	1598		0-N1664	VB [BT]	S
1.6 16V	04/10-	K4M 690	1598	06/2010 →; ☼	0-N2265	VB [BT]	S
1.6 16V	04/10-	K4M 696	1598	☼	0-N2265	VB [BT]	S
1.6 16V	04/10-	K4M 690	1598	06/2010 →; ☼	0-N2275	VB [DG]	
1.6 16V	04/10-	K4M 696	1598	☼	0-N2275	VB [DG]	
1.6 16V 4x4	06/10-	K4M 606	1598		0-N1664	VB [BT]	S
1.6 16V 4x4, 1.6 16V Flexifuel, 1.6 16V LPG	06/10-	K4M 606, K4M 696	1598	☼	0-N2275	VB [DG]	
1.6 16V 4x4, 1.6 16V LPG	06/10-	K4M 606, K4M 696	1598	☼	0-N2265	VB [BT]	S
1.6 16V Flexifuel	08/10-	K4M 696	1598	☼, für Fahrzeuge mit Servolenkung	0-N2265	VB [BT]	S

LODGY

1.5 dCi	03/12-	K9K 612	1461	27x119	SK-1730	BTK	
1.5 dCi	03/12-	K9K 612	1461	27x119	SK-1730AQ1	BTKW	
1.5 dCi	01/13-	K9K 846	1461	27x123; mit Zubehör	SK-1487AQ3	BTKW	
1.6	03/12-	K7M 812, K7M 828	1598	17.3x96	SK-1704	BTK	
1.6, 1.6 LPG	03/12-	K7M 812, K7M 828	1598	17.3x96	SK-1704AQ1	BTKW	
1.6	03/12-	K7M 812, K7M 828	1598		0-N2062	TB [TE]	
1.2 TCe	03/12-	H5F 402	1197	☼	0-N2308	VB [BT]	S
1.2 TCe	03/12-	H5F 402	1197	☼	0-N2344	VB [DG]	
1.5 dCi	03/12-	K9K 612, K9K 846	1461	☼	0-N2253	VB [DG]	
1.6	03/12-	K7M 812, K7M 828	1598	☼, für Fahrzeuge mit Servolenkung	0-N2265	VB [BT]	S
1.6	03/12-	K7M 812, K7M 828	1598	☼, für Fahrzeuge mit Servolenkung	0-N2275	VB [DG]	

LOGAN (LS_)

1.2 16V	02/06-	D4F 732	1149	23.4x95; 06/2009 →	SK-1486	BTK	
1.4, 1.4 MPI LPG	09/04-	K7J 710, K7J 710, K7J 714	1390	17x96; → 11/2009	SK-1338	BTK	



CM³



Art. Nr.



LOGAN (LS_)

1.4, 1.4 MPI LPG	09/04-	K7J 710, K7J 710, K7J 714	1390	17x96; → 11/2009	SK-1338AQ2	BTKW	
1.4, 1.4 MPI LPG	09/04-	K7J 710, K7J 710, K7J 714	1390	17.3x96; 11/2009 →	SK-1704AQ1	BTKW	
1.4 MPI LPG	02/06-	K7J 710, K7J 714	1390	17.3x96; 11/2009 →	SK-1704	BTK	
1.5 dCi	09/05-	K9K 790, K9K 792, K9K 796, K9K 892	1461	27x123; mit Zubehör	SK-1487	BTK	
1.5 dCi	09/05-	K9K 790, K9K 792, K9K 796	1461	27x123; mit Zubehör	SK-1487AQ2	BTKW	
1.5 dCi	05/10-	K9K 892	1461	27x123; mit Zubehör	SK-1487AQ3	BTKW	
1.6	09/04-	K7M 710	1598	17x96; → 11/2009	SK-1338	BTK	
1.6	09/04-	K7M 710	1598	17x96; → 11/2009	SK-1338AQ2	BTKW	
1.6	09/04-	K7M 710	1598	17.3x96; 11/2009 →	SK-1704AQ1	BTKW	
1.6 16V, 1.6 16V Flexifuel	02/06-	K4M 690, K4M 696, K4M 696	1598	27x132; mit Zubehör	SK-1088	BTK	
1.6 16V, 1.6 16V Flexifuel	02/06-	K4M 690, K4M 696, K4M 696	1598	27x132; mit Zubehör	SK-1088AQ1	BTKW	
1.6 Bifuel, 1.6 MPI 85	05/10-	K7M 718, K7M 800	1598	17.3x96	SK-1704	BTK	
1.6 Bifuel, 1.6 MPI 85	05/10-	K7M 718, K7M 800	1598	17.3x96	SK-1704AQ1	BTKW	
1.4	09/04-	K7J 710	1390		0-N145	TB [TE]	
1.4, 1.4 MPI LPG	09/04-	K7J 710, K7J 710, K7J 714	1390	11/2009 →	0-N2062	TB [TE]	
1.5 dCi	09/05-	K9K 790, K9K 792, K9K 796, K9K 892	1461		0-N1111	TB [TE]	
1.6	09/04-	K7M 710	1598		0-N145	TB [TE]	
1.6	09/04-	K7M 710	1598	11/2009 →	0-N2062	TB [TE]	
1.6 16V, 1.6 16V Flexifuel	02/06-	K4M 690, K4M 696, K4M 696	1598		0-N198	TB [TE]	
1.6 16V, 1.6 16V Flexifuel	02/06-	K4M 690, K4M 696, K4M 696	1598		0-N262	TB [DG]	
1.6 Bifuel, 1.6 MPI 85	05/10-	K7M 718, K7M 800	1598		0-N2062	TB [TE]	
1.2 16V	02/06-	D4F 732	1149	☼, für Fahrzeuge mit Servolenkung	0-N1592	VB [DG]	
1.2 16V	02/06-	D4F 732	1149	☼, für Fahrzeuge ohne Servolenkung	0-N2222	VB [TE]	
1.4, 1.4 MPI LPG	09/04-	K7J 710, K7J 710, K7J 714	1390	→ 09/2009	0-N1307	VB [DG]	
1.4, 1.4 MPI LPG	09/04-	K7J 710, K7J 710, K7J 714	1390	→ 09/2009; für Fahrzeuge mit Servolenkung, ☼	0-N1314	VB [TE]	
1.4, 1.4 MPI LPG	09/04-	K7J 710, K7J 710, K7J 714	1390	→ 09/2009; ☼, für Fahrzeuge mit Servolenkung	0-N1663	VB [BT]	S
1.4, 1.4 MPI LPG	09/04-	K7J 710, K7J 710, K7J 714	1390	09/2009 →; ☼, für Fahrzeuge mit Servolenkung	0-N2265	VB [BT]	S
1.4, 1.4 MPI LPG	09/04-	K7J 710, K7J 710, K7J 714	1390	09/2009 →; ☼, für Fahrzeuge mit Servolenkung	0-N2275	VB [DG]	
1.5 dCi	09/05-	K9K 790, K9K 792, K9K 796	1461	☼	0-N1474	VB [BT]	
1.5 dCi	09/05-	K9K 790, K9K 792, K9K 796	1461	☼	0-N1664	VB [BT]	S
1.5 dCi	09/05-	K9K 790, K9K 792, K9K 796	1461	→ 12/2007; Rippenanzahl: 6; ☼	0-N1898	VB [BT]	S
1.5 dCi	09/05-	K9K 790, K9K 792, K9K 796	1461	12/2007 →; ☼, für Fahrzeuge ohne Servolenkung	0-N2253	VB [DG]	
1.5 dCi	05/10-	K9K 892	1461		0-N1664	VB [BT]	S
1.5 dCi	05/10-	K9K 892	1461	☼	0-N2253	VB [DG]	
1.6	09/04-	K7M 710	1598	→ 09/2009	0-N1307	VB [DG]	
1.6	09/04-	K7M 710	1598	→ 09/2009; für Fahrzeuge mit Servolenkung, ☼	0-N1314	VB [TE]	
1.6	09/04-	K7M 710	1598	→ 09/2009; ☼, für Fahrzeuge mit Servolenkung	0-N1663	VB [BT]	S
1.6	09/04-	K7M 710	1598	09/2009 →; ☼, für Fahrzeuge mit Servolenkung	0-N2265	VB [BT]	S
1.6	09/04-	K7M 710	1598	09/2009 →; ☼, für Fahrzeuge mit Servolenkung	0-N2275	VB [DG]	
1.6 16V	02/06-	K4M 690, K4M 696	1598	→ 10/2009	0-N1307	VB [DG]	
1.6 16V	02/06-	K4M 690, K4M 696	1598	→ 10/2009; ☼, für Fahrzeuge mit Servolenkung	0-N1663	VB [BT]	S
1.6 16V	02/06-	K4M 690, K4M 696	1598	☼	0-N1664	VB [BT]	S
1.6 16V	02/06-	K4M 690, K4M 696	1598	10/2009 →; ☼, für Fahrzeuge mit Servolenkung	0-N2265	VB [BT]	S
1.6 16V	02/06-	K4M 690, K4M 696	1598	10/2009 →; ☼, für Fahrzeuge mit Servolenkung	0-N2275	VB [DG]	
1.6 16V Flexifuel	07/10-	K4M 696	1598	☼, für Fahrzeuge mit Servolenkung	0-N2265	VB [BT]	S
1.6 16V Flexifuel	07/10-	K4M 696	1598	☼, für Fahrzeuge mit Servolenkung	0-N2275	VB [DG]	
1.6 Bifuel	05/10-	K7M 718	1598	☼	0-N2265	VB [BT]	S
1.6 Bifuel	05/10-	K7M 718	1598	☼	0-N2275	VB [DG]	

LOGAN EXPRESS (FS_)

1.4	03/09-	K7J 710	1390	17x96; → 11/2009	SK-1338	BTK	
1.4	03/09-	K7J 710	1390	17x96; → 11/2009	SK-1338AQ2	BTKW	
1.4	03/09-	K7J 710	1390	17.3x96; 11/2009 →	SK-1704AQ1	BTKW	
1.5 dCi	03/09-	K9K 792, K9K 796, K9K 892	1461	27x123; mit Zubehör	SK-1487	BTK	
1.5 dCi	03/09-	K9K 792, K9K 796	1461	27x123; mit Zubehör	SK-1487AQ2	BTKW	
1.5 dCi	05/10-	K9K 892	1461	27x123; mit Zubehör	SK-1487AQ3	BTKW	
1.6	03/09-	K7M 710	1598	17x96; → 11/2009	SK-1338	BTK	

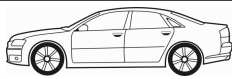

CM³



Art. Nr.



ohne Halter

LOGAN EXPRESS (FS_)

1.6	03/09-	K7M 710	1598	17x96; → 11/2009	SK-1338AQ2	BTKW	
1.6	03/09-	K7M 710	1598	17.3x96; 11/2009 →	SK-1704AQ1	BTKW	
1.6 MPI 85	05/10-	K7M 800	1598	17.3x96	SK-1704	BTK	
1.6 MPI 85	05/10-	K7M 800	1598	17.3x96	SK-1704AQ1	BTKW	
1.4	03/09-	K7J 710	1390		0-N145	TB [TE]	
1.4	03/09-	K7J 710	1390	11/2009 →	0-N2062	TB [TE]	
1.5 dCi	03/09-	K9K 792, K9K 796, K9K 892	1461		0-N1111	TB [TE]	
1.6	03/09-	K7M 710	1598		0-N145	TB [TE]	
1.6	03/09-	K7M 710	1598	11/2009 →	0-N2062	TB [TE]	
1.6 MPI 85	05/10-	K7M 800	1598		0-N2062	TB [TE]	
1.4	03/09-	K7J 710	1390	→ 09/2009	0-N1307	VB [DG]	
1.4	03/09-	K7J 710	1390	→ 09/2009; für Fahrzeuge mit Servolenkung,	0-N1314	VB [TE]	
1.4	03/09-	K7J 710	1390	→ 09/2009; , für Fahrzeuge mit Servolenkung	0-N1663	VB [BT]	S
1.4	03/09-	K7J 710	1390	09/2009 →; , für Fahrzeuge mit Servolenkung	0-N2265	VB [BT]	S
1.4	03/09-	K7J 710	1390	09/2009 →; , für Fahrzeuge mit Servolenkung	0-N2275	VB [DG]	
1.5 dCi	03/09-	K9K 792, K9K 796, K9K 892	1461		0-N1664	VB [BT]	S
1.5 dCi	03/09-	K9K 792, K9K 796	1461	, für Fahrzeuge ohne Servolenkung	0-N2253	VB [DG]	
1.5 dCi	05/10-	K9K 892	1461		0-N2253	VB [DG]	
1.6	03/09-	K7M 710	1598	→ 09/2009; für Fahrzeuge mit Servolenkung,	0-N1314	VB [TE]	
1.6	03/09-	K7M 710	1598	→ 09/2009; , für Fahrzeuge mit Servolenkung	0-N1663	VB [BT]	S
1.6	03/09-	K7M 710	1598	09/2009 →; , für Fahrzeuge mit Servolenkung	0-N2265	VB [BT]	S
1.6	03/09-	K7M 710	1598	09/2009 →; , für Fahrzeuge mit Servolenkung	0-N2275	VB [DG]	

LOGAN MCV (KS_)

1.4	02/07-	K7J 710	1390	17x96; → 11/2009	SK-1338	BTK	
1.4	02/07-	K7J 710	1390	17x96; → 11/2009	SK-1338AQ2	BTKW	
1.4	02/07-	K7J 710	1390	17.3x96; 11/2009 →	SK-1704AQ1	BTKW	
1.5 dCi	02/07-	K9K 792, K9K 796, K9K 892	1461	27x123; mit Zubehör	SK-1487	BTK	
1.5 dCi	02/07-	K9K 792, K9K 796	1461	27x123; mit Zubehör	SK-1487AQ2	BTKW	
1.5 dCi	05/10-	K9K 892	1461	27x123; mit Zubehör	SK-1487AQ3	BTKW	
1.6	02/07-	K7M 710	1598	17x96; → 11/2009	SK-1338AQ2	BTKW	
1.6 16V, 1.6 16V Flexifuel	02/07-	K4M 690, K4M 694, K4M 690, K4M 696	1598	27x132; mit Zubehör	SK-1088	BTK	
1.6 16V, 1.6 16V Flexifuel	02/07-	K4M 690, K4M 694, K4M 690, K4M 696	1598	27x132; mit Zubehör	SK-1088AQ1	BTKW	
1.6 Bifuel	11/08-	K7M 710	1598	17.3x96; 12/2009 →	SK-1704	BTK	
1.6 MPI 85	05/10-	K7M 800	1598	17.3x96	SK-1704	BTK	
1.6 MPI 85	05/10-	K7M 800	1598	17.3x96	SK-1704AQ1	BTKW	
1.6, 1.6 Bifuel	02/07-	K7M 710	1598	17x96; → 11/2009	SK-1338	BTK	
1.6, 1.6 Bifuel	02/07-	K7M 710	1598	17.3x96; 11/2009 →	SK-1704AQ1	BTKW	
1.4	02/07-	K7J 710	1390		0-N145	TB [TE]	
1.4	02/07-	K7J 710	1390	11/2009 →	0-N2062	TB [TE]	
1.5 dCi	02/07-	K9K 792, K9K 796, K9K 892	1461		0-N1111	TB [TE]	
1.6 16V, 1.6 16V Flexifuel	02/07-	K4M 690, K4M 694, K4M 690, K4M 696	1598		0-N198	TB [TE]	
1.6 16V, 1.6 16V Flexifuel	02/07-	K4M 690, K4M 694, K4M 690, K4M 696	1598		0-N262	TB [DG]	
1.6 MPI 85	05/10-	K7M 800	1598		0-N2062	TB [TE]	
1.6, 1.6 Bifuel	02/07-	K7M 710	1598		0-N145	TB [TE]	
1.6, 1.6 Bifuel	02/07-	K7M 710	1598	11/2009 →	0-N2062	TB [TE]	
1.4	02/07-	K7J 710	1390	→ 09/2009	0-N1307	VB [DG]	
1.4	02/07-	K7J 710	1390	→ 09/2009; für Fahrzeuge mit Servolenkung,	0-N1314	VB [TE]	
1.4	02/07-	K7J 710	1390	→ 09/2009; , für Fahrzeuge mit Servolenkung	0-N1663	VB [BT]	S
1.4	02/07-	K7J 710	1390	09/2009 →; , für Fahrzeuge mit Servolenkung	0-N2265	VB [BT]	S
1.4	02/07-	K7J 710	1390	09/2009 →; , für Fahrzeuge mit Servolenkung	0-N2275	VB [DG]	
1.5 dCi	02/07-	K9K 792, K9K 796	1461		0-N1474	VB [BT]	
1.5 dCi	02/07-	K9K 792, K9K 796, K9K 892	1461		0-N1664	VB [BT]	S
1.5 dCi	02/07-	K9K 792	1461	→ 12/2007; Rippenanzahl: 6;	0-N1898	VB [BT]	S
1.5 dCi	02/07-	K9K 792, K9K 796	1461	12/2007 →; , für Fahrzeuge ohne Servolenkung	0-N2253	VB [DG]	
1.5 dCi	09/07-	K9K 796	1461	→ 07/2012; Rippenanzahl: 6;	0-N1898	VB [BT]	S

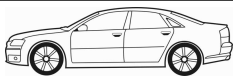

CM³



Art. Nr.



LOGAN MCV (KS_)

1.5 dCi	05/10-	K9K 892	1461	☼	0-N2253	VB [DG]	
1.6 16V	02/07-	K4M 690, K4M 696	1598	→ 10/2009	0-N1307	VB [DG]	
1.6 16V	02/07-	K4M 690, K4M 696	1598	→ 10/2009; ☼, für Fahrzeuge mit Servolenkung	0-N1663	VB [BT]	S
1.6 16V	02/07-	K4M 690, K4M 696	1598	☼	0-N1664	VB [BT]	S
1.6 16V	02/07-	K4M 690, K4M 696	1598	10/2009 →; ☼, für Fahrzeuge mit Servolenkung	0-N2265	VB [BT]	S
1.6 16V	02/07-	K4M 690, K4M 696	1598	10/2009 →; ☼, für Fahrzeuge mit Servolenkung	0-N2275	VB [DG]	
1.6 16V Flexifuel	11/09-	K4M 690, K4M 694	1598		0-N1307	VB [DG]	
1.6 16V Flexifuel	11/09-	K4M 690, K4M 694	1598	☼	0-N1663	VB [BT]	S
1.6 16V Flexifuel	11/09-	K4M 690	1598	☼, für Fahrzeuge mit Servolenkung	0-N2265	VB [BT]	S
1.6 16V Flexifuel	11/09-	K4M 690	1598	☼, für Fahrzeuge mit Servolenkung	0-N2275	VB [DG]	
1.6, 1.6 Bifuel	02/07-	K7M 710	1598	→ 09/2009; für Fahrzeuge mit Servolenkung, ☼	0-N1314	VB [TE]	
1.6, 1.6 Bifuel	02/07-	K7M 710	1598	→ 09/2009; ☼, für Fahrzeuge mit Servolenkung	0-N1663	VB [BT]	S
1.6, 1.6 Bifuel	02/07-	K7M 710	1598	09/2009 →; ☼, für Fahrzeuge mit Servolenkung	0-N2265	VB [BT]	S
1.6, 1.6 Bifuel	02/07-	K7M 710	1598	09/2009 →; ☼, für Fahrzeuge mit Servolenkung	0-N2275	VB [DG]	

LOGAN MCV II

1.5 dCi	02/13-	K9K 612	1461	27x119	SK-1730	BTK	
1.5 dCi	02/13-	K9K 612	1461	27x119	SK-1730AQ1	BTKW	
1.5 dCi	02/13-	K9K 612	1461		0-N2423	TB [TE]	
1.5 dCi	02/13-	K9K 612	1461	☼	0-N2253	VB [DG]	
TCe 90	02/13-	H4Bt400	898	☼	0-N2308	VB [BT]	S

LOGAN Pick-up (US_)

1.4	01/09-	K7J 710	1390	17x96; → 11/2009	SK-1338	BTK	
1.4	01/09-	K7J 710	1390	17x96; → 11/2009	SK-1338AQ2	BTKW	
1.4	01/09-	K7J 710	1390	17.3x96; 11/2009 →	SK-1704AQ1	BTKW	
1.5 dCi	03/08-	K9K 792, K9K 796, K9K 892	1461	27x123; mit Zubehör	SK-1487	BTK	
1.5 dCi	03/08-	K9K 792, K9K 796	1461	27x123; mit Zubehör	SK-1487AQ2	BTKW	
1.5 dCi	05/10-	K9K 892	1461	27x123; mit Zubehör	SK-1487AQ3	BTKW	
1.6	03/08-	K7M 710	1598	17x96; → 11/2009	SK-1338	BTK	
1.6	03/08-	K7M 710	1598	17x96; → 11/2009	SK-1338AQ2	BTKW	
1.6	03/08-	K7M 710	1598	17.3x96; 11/2009 →	SK-1704AQ1	BTKW	
1.6 Bifuel, 1.6 MPI 85	05/10-	K7M 800	1598	17.3x96	SK-1704	BTK	
1.6 Bifuel, 1.6 MPI 85	05/10-	K7M 800	1598	17.3x96	SK-1704AQ1	BTKW	
1.4	01/09-	K7J 710	1390	11/2009 →	0-N2062	TB [TE]	
1.5 dCi	03/08-	K9K 792, K9K 796, K9K 892	1461		0-N1111	TB [TE]	
1.6	03/08-	K7M 710	1598		0-N145	TB [TE]	
1.6	03/08-	K7M 710	1598	11/2009 →	0-N2062	TB [TE]	
1.6 Bifuel, 1.6 MPI 85	05/10-	K7M 800	1598		0-N2062	TB [TE]	
1.4	01/09-	K7J 710	1390	→ 09/2009	0-N1307	VB [DG]	
1.4	01/09-	K7J 710	1390	→ 09/2009; für Fahrzeuge mit Servolenkung, ☼	0-N1314	VB [TE]	
1.4	01/09-	K7J 710	1390	→ 09/2009; ☼, für Fahrzeuge mit Servolenkung	0-N1663	VB [BT]	S
1.4	01/09-	K7J 710	1390	09/2009 →; ☼, für Fahrzeuge mit Servolenkung	0-N2265	VB [BT]	S
1.4	01/09-	K7J 710	1390	09/2009 →; ☼, für Fahrzeuge mit Servolenkung	0-N2275	VB [DG]	
1.5 dCi	03/08-	K9K 792, K9K 796	1461		0-N1664	VB [BT]	S
1.5 dCi	03/08-	K9K 792, K9K 796	1461	☼, für Fahrzeuge ohne Servolenkung	0-N2253	VB [DG]	
1.5 dCi	05/10-	K9K 892	1461	☼	0-N2253	VB [DG]	
1.6	03/08-	K7M 710	1598	→ 09/2009; für Fahrzeuge mit Servolenkung, ☼	0-N1314	VB [TE]	
1.6	03/08-	K7M 710	1598	→ 09/2009; ☼, für Fahrzeuge mit Servolenkung	0-N1663	VB [BT]	S
1.6	03/08-	K7M 710	1598	09/2009 →; ☼, für Fahrzeuge mit Servolenkung	0-N2265	VB [BT]	S
1.6	03/08-	K7M 710	1598	09/2009 →; ☼, für Fahrzeuge mit Servolenkung	0-N2275	VB [DG]	

LOGAN II

1.5 dCi	10/12-	K9K 612	1461	27x119	SK-1730	BTK	
1.5 dCi	10/12-	K9K 612	1461	27x119	SK-1730AQ1	BTKW	
1.5 dCi	10/12-	K9K 612	1461		0-N2423	TB [TE]	



OPTIMAL®

DACIA



CM³



Art. Nr.



LOGAN II								
1.5 dCi	10/12-	K9K 612	1461	✱		0-N2253	VB [DG]	
TCe 90	10/12-	H4Bt400	898	✱		0-N2308	VB [BT]	S
SANDERO								
1.2 16V	11/08-	D4F 732	1149	23.4x95		SK-1486	BTK	
1.2 16V LPG	11/08-	D4F 732	1149	23.4x95; 01/2011 →		SK-1486	BTK	
1.2 16V LPG	11/08-	D4F 732	1149	23.4x95; 01/2011 →		SK-1486AQ1	BTKW	
1.4	06/08-	K7J 710	1390	17.3x96; 11/2009 →		SK-1704	BTK	
1.4 MPI LPG	01/09-	K7J 714	1390	17.3x96; 12/2009 →		SK-1704	BTK	
1.4, 1.4 MPI LPG	06/08-	K7J 710, K7J 714	1390	17x96; → 11/2009		SK-1338	BTK	
1.4, 1.4 MPI LPG	06/08-	K7J 710, K7J 714	1390	17x96; → 11/2009		SK-1338AQ2	BTKW	
1.4, 1.4 MPI LPG	06/08-	K7J 710, K7J 714	1390	17.3x96; 11/2009 →		SK-1704AQ1	BTKW	
1.5 dCi	11/08-	K9K 792	1461	27x123; mit Zubehör; Baumuster: BSOK		SK-1487	BTK	
1.5 dCi	11/08-	K9K 796	1461	27x123; mit Zubehör; Baumuster: BSOW		SK-1487	BTK	
1.5 dCi	11/08-	K9K 792, K9K 796	1461	27x123; mit Zubehör		SK-1487AQ2	BTKW	
1.5 dCi	05/10-	K9K 892	1461	27x123; mit Zubehör		SK-1487	BTK	
1.5 dCi	05/10-	K9K 892	1461	27x123; mit Zubehör		SK-1487AQ3	BTKW	
1.6	06/08-	K7M 710	1598	17x96; → 11/2009		SK-1338	BTK	
1.6	06/08-	K7M 710	1598	17x96; → 11/2009		SK-1338AQ2	BTKW	
1.6	06/08-	K7M 710	1598	17.3x96; 11/2009 →		SK-1704	BTK	
1.6	06/08-	K7M 710	1598	17.3x96; 11/2009 →		SK-1704AQ1	BTKW	
1.6	06/08-	K7M 710	1598	17.3x96; 11/2009 →; Baumuster: Sandero Stepway		SK-1704AQ1	BTKW	
1.6 16V Bifuel	01/11-	K4M 690, K4M 694, K4M 696	1598	27x132; mit Zubehör		SK-1088AQ1	BTKW	
1.6 16V, 1.6 16V Bifuel	01/11-	K4M 690, K4M 690, K4M 694, K4M 696	1598	27x132; mit Zubehör		SK-1088	BTK	
1.6 MPI 85	05/10-	K7M 800	1598	17.3x96; 01/2011 →		SK-1704	BTK	
1.6 MPI 85	05/10-	K7M 800	1598	17.3x96; Baumuster: Sandero Stepway		SK-1704AQ1	BTKW	
1.2 16V	11/08-	D4F 732	1149			0-N1112	TB [TE]	
1.4	06/08-	K7J 710	1390			0-N145	TB [TE]	
1.4, 1.4 MPI LPG	06/08-	K7J 710, K7J 714	1390	11/2009 →		0-N2062	TB [TE]	
1.5 dCi	11/08-	K9K 792, K9K 796, K9K 892	1461			0-N1111	TB [TE]	
1.6	06/08-	K7M 710	1598			0-N145	TB [TE]	
1.6	06/08-	K7M 710	1598	11/2009 →		0-N2062	TB [TE]	
1.6 16V Bifuel	01/11-	K4M 690, K4M 694, K4M 696	1598			0-N198	TB [TE]	
1.6 16V Bifuel	01/11-	K4M 690, K4M 694, K4M 696	1598			0-N262	TB [DG]	
1.6 MPI 85	05/10-	K7M 800	1598			0-N2062	TB [TE]	
1.2 16V, 1.2 16V LPG	11/08-	D4F 732	1149	✱, für Fahrzeuge mit Servolenkung		0-N1592	VB [DG]	
1.2 16V, 1.2 16V LPG	11/08-	D4F 732	1149	✱, für Fahrzeuge ohne Servolenkung		0-N2222	VB [TE]	
1.4, 1.4 MPI LPG	06/08-	K7J 710, K7J 714	1390	→ 09/2009		0-N1307	VB [DG]	
1.4, 1.4 MPI LPG	06/08-	K7J 710, K7J 714	1390	→ 09/2009; für Fahrzeuge mit Servolenkung, ✱		0-N1314	VB [TE]	
1.4, 1.4 MPI LPG	06/08-	K7J 710, K7J 714	1390	→ 09/2009; ✱, für Fahrzeuge mit Servolenkung		0-N1663	VB [BT]	S
1.4, 1.4 MPI LPG	06/08-	K7J 710, K7J 714	1390	09/2009 →; ✱, für Fahrzeuge mit Servolenkung		0-N2265	VB [BT]	S
1.4, 1.4 MPI LPG	06/08-	K7J 710, K7J 714	1390	09/2009 →; ✱, für Fahrzeuge mit Servolenkung		0-N2275	VB [DG]	
1.5 dCi	11/08-	K9K 792, K9K 796, K9K 892	1461			0-N1664	VB [BT]	S
1.5 dCi	11/08-	K9K 792, K9K 892	1461	✱		0-N2253	VB [DG]	
1.5 dCi	11/08-	K9K 796	1461	✱, für Fahrzeuge ohne Servolenkung		0-N2253	VB [DG]	
1.6	06/08-	K7M 710	1598	→ 09/2009; für Fahrzeuge mit Servolenkung, ✱		0-N1314	VB [TE]	
1.6	06/08-	K7M 710	1598	→ 09/2009; ✱, für Fahrzeuge mit Servolenkung		0-N1663	VB [BT]	S
1.6	06/08-	K7M 710	1598	09/2009 →; ✱, für Fahrzeuge mit Servolenkung		0-N2265	VB [BT]	S
1.6	06/08-	K7M 710	1598	09/2009 →; ✱, für Fahrzeuge mit Servolenkung		0-N2275	VB [DG]	
1.6 16V Bifuel	01/11-	K4M 690, K4M 694, K4M 696	1598	✱, für Fahrzeuge mit Servolenkung		0-N2265	VB [BT]	S
1.6 16V Bifuel	01/11-	K4M 690, K4M 694, K4M 696	1598	✱, für Fahrzeuge mit Servolenkung		0-N2275	VB [DG]	
SANDERO II								
1.2 LPG	10/12-	D4F 732	1149	23.4x95		SK-1486	BTK	
1.2 LPG	10/12-	D4F 732	1149	23.4x95		SK-1486AQ1	BTKW	
1.5 dCi	10/12-	K9K 612	1461	27x119; Baumuster: Sandero Stepway		SK-1730	BTK	
1.5 dCi	10/12-	K9K 612	1461	27x119; Baumuster: Sandero Stepway		SK-1730AQ1	BTKW	
1.5 dCi	10/12-	K9K 612	1461			0-N2423	TB [TE]	
1.5 dCi	10/12-	K9K 612	1461	✱		0-N2253	VB [DG]	
TCe 90	10/12-	H4Bt400	898	✱		0-N2308	VB [BT]	S



CM³



Art. Nr.



ohne Halter

SOLENZA

1.4	02/03-	K7J 710	1390	17x96	SK-1338	BTK	
1.4	02/03-	K7J 710	1390	17x96	SK-1338AQ1	BTKW	
1.9 D	02/03-	F8Q 630	1870	25.4x151; beinhaltetete Rollen: 3; mit Zahnrad	SK-1108	BTK	
1.9 D	02/03-	F8Q 630	1870	25.4x151; beinhaltetete Rollen: 2	SK-1108S	BTK	
1.4	02/03-	K7J 710	1390		0-N145	TB [TE]	
1.4	02/03-	K7J 710	1390	11/2009 →	0-N2062	TB [TE]	
1.4	02/03-	K7J 710	1390		0-N1307	VB [DG]	
1.4	02/03-	K7J 710	1390	→ 09/2009; für Fahrzeuge mit Servolenkung, ✳	0-N1314	VB [TE]	
1.4	02/03-	K7J 710	1390	→ 09/2009; ✳, für Fahrzeuge mit Servolenkung	0-N1663	VB [BT]	S
1.4	02/03-	K7J 710	1390	09/2009 →; ✳, für Fahrzeuge mit Servolenkung	0-N2265	VB [BT]	S
1.4	02/03-	K7J 710	1390	09/2009 →; ✳, für Fahrzeuge mit Servolenkung	0-N2275	VB [DG]	

SUPERNOVA

1.4	04/00-03/03		1390		0-N145	TB [TE]	
-----	-------------	--	------	--	---------------	---------	--

CM³

Art. Nr.



ohne Halter

ARANOS

1.5	01/95-11/97	V15L	1498	25x127	SK-1273	BTK	
1.5	01/95-11/97	V15L	1498	25x127	SK-1273AQ2	BTKW	
1.8	01/95-11/97	Y18L	1796	20x125	SK-1184	BTK	
2.0	01/95-11/97	C20LE	1998	20x125	SK-1184	BTK	

AVEO

1.5 SE	11/02-04/05		1498		0-N1532	VB [BT]	S
1.5 SE	11/02-04/05		1498		0-N948	TB [TE]	

CIELO

1.5	06/94-07/98	V15L	1498	25x127	SK-1273	BTK	
1.5	04/95-07/97	Y15L	1498	17x111; mit Zubehör	SK-1162	BTK	

DAMAS Bus

0.8 Luxe	03/95-07/98	F8B	797	25.4x107	SK-1183	BTK	
----------	-------------	-----	-----	----------	---------	-----	--

DAMAS Kasten

0.8	03/95-07/98	F8A	797	25.4x107	SK-1183	BTK	
-----	-------------	-----	-----	----------	---------	-----	--

ESPERO (KLEJ)

1.5 16V	10/93-06/99	A15MF	1498	25x127	SK-1273	BTK	
1.5 16V	10/93-06/99	A15MF	1498	25x127	SK-1273AQ1	BTKW	
1.5, 1.5 16V	10/93-09/99	A15MF, G15MF	1498	17x111; mit Zubehör	SK-1162	BTK	
1.8	02/95-09/99	C18LE	1796	20x125	SK-1184	BTK	
2.0	10/91-06/99	C20LE, C20LZ	1998	20x125	SK-1184	BTK	
1.5 16V	10/93-06/99	A15MF	1498		0-N970	TB [TE]	
1.5 16V	10/93-06/99	A15MF	1498		0-N971	TB [DG]	
1.8	02/95-09/99	C18LE	1796		0-N974	TB [TE]	
2.0	10/91-06/99	C20LE, C20LZ	1998		0-N974	TB [TE]	
1.5	10/97-09/99	G15MF	1498		0-N948	TB [TE]	

EVANDA (KLAL)

2.0	08/02-	L88, X 20 SED	1998	24x169	SK-1100	BTK	
2.0	08/02-	L88, X 20 SED	1998	24x169	SK-1100AQ1	BTKW	
2.0	08/02-	L88, X 20 SED	1998		0-N100	TB [TE]	
2.0	08/02-	L88, X 20 SED	1998		0-N906	TB [DG]	
2.0	08/02-	L88, X 20 SED	1998		0-N1422	VB [BT]	S

GENTRA Stufenheck

1.2 SE	11/02-04/05	B12S1	1150		0-N973	TB [TE]	
1.4, 1.4 SR	05/03-04/05	F14D3	1399		0-N970	TB [TE]	
1.4, 1.4 SR	05/03-04/05	F14D3	1399		0-N971	TB [DG]	
1.4, 1.4 SR	05/03-04/05	F14D3	1399		0-N1532	VB [BT]	S
1.4, 1.4 SR	05/03-04/05	F14D3	1399	Rippenanzahl: 6;	0-N1646	VB [DG]	
1.5 SE	11/02-04/05	A15SMS	1498		0-N1532	VB [BT]	S
1.5 SE	11/02-04/05	F15S3	1498	Rippenanzahl: 6;	0-N1646	VB [DG]	
1.5 SE	11/02-04/05	A15SMS	1498		0-N948	TB [TE]	

GENTRA Schrägheck

1.4	05/05-	F14D3	1399		0-N970	TB [TE]	
1.4	05/05-	F14D3	1399		0-N971	TB [DG]	
1.6 E-Tec LS	05/05-	F16D3	1598		0-N970	TB [TE]	
1.6 E-Tec LS	05/05-	F16D3	1598		0-N971	TB [DG]	
1.4	05/05-	F14D3	1399		0-N1532	VB [BT]	S
1.4	05/05-	F14D3	1399	Rippenanzahl: 6;	0-N1646	VB [DG]	
1.6 E-Tec LS	05/05-	F16D3	1598		0-N1532	VB [BT]	S
1.6 E-Tec LS	05/05-	F16D3	1598	Rippenanzahl: 6;	0-N1646	VB [DG]	

GENTRA Stufenheck

1.4, 1.4 SR	05/05-	F14D3	1399		0-N970	TB [TE]	
1.4, 1.4 SR	05/05-	F14D3	1399		0-N971	TB [DG]	
1.6 E-Tec LS	05/05-	F16D3	1598		0-N970	TB [TE]	
1.6 E-Tec LS	05/05-	F16D3	1598		0-N971	TB [DG]	
1.4, 1.4 SR	05/05-	F14D3	1399		0-N1532	VB [BT]	S
1.4, 1.4 SR	05/05-	F14D3	1399	Rippenanzahl: 6;	0-N1646	VB [DG]	
1.6 E-Tec LS	05/05-	F16D3	1598		0-N1532	VB [BT]	S
1.6 E-Tec LS	05/05-	F16D3	1598	Rippenanzahl: 6;	0-N1646	VB [DG]	

KALOS (KLAS)

1.2	04/03-	B12S1, F12S3, F12S3	1150	25x109	SK-1685	BTK	
1.2	04/03-	B12S1, F12S3, F12S3	1150	25x109	SK-1685AQ1	BTKW	

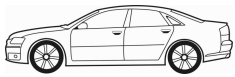

CM³



Art. Nr.



KALOS (KLAS)							
1.4	09/02-	F14S3	1399	17x111; mit Zubehör	SK-1162	BTK	
1.4	09/02-	F14S3	1399	17x111	SK-1162AQ3	BTKW	
1.4	09/02-	F14S3	1399	25x127; 08/2005 →	SK-1273	BTK	
1.4	09/02-	F14S3	1399	25x127; 08/2005 →	SK-1273AQ2	BTKW	
1.4 16V	04/03-	F14D3	1399	17x111; 08/2005 →; mit Zubehör	SK-1162	BTK	
1.4 16V	04/03-	F14D3	1399	25x127	SK-1273	BTK	
1.4 16V	04/03-	F14D3	1399	25x127; → 12/2004	SK-1273AQ2	BTKW	
1.5	11/02-12/04	F15S	1498	17x111; mit Zubehör	SK-1162	BTK	
1.2	04/03-	B12S1, F12S3, F12S3	1150		0-N973	TB [TE]	
1.4 16V	04/03-	F14D3	1399		0-N970	TB [TE]	
1.4 16V	04/03-	F14D3	1399		0-N971	TB [DG]	
1.4	09/02-	F14S3	1399		0-N948	TB [TE]	
1.4, 1.4 16V	09/02-	F14D3, F14S3	1399		0-N1532	VB [BT]	S
1.4, 1.4 16V	09/02-	F14D3, F14S3	1399	Rippenanzahl: 6;	0-N1646	VB [DG]	
1.5	11/02-12/04	F15S	1498		0-N1532	VB [BT]	S
1.5	11/02-12/04	F15S3	1498	Rippenanzahl: 6;	0-N1646	VB [DG]	
1.5	11/02-12/04	F15S	1498		0-N948	TB [TE]	
KALOS Stufenheck (KLAS)							
1.4	11/02-12/04	F14S3	1399	17x111; 05/2003 →; mit Zubehör	SK-1162	BTK	
1.4	05/03-12/04	F14D3	1399	25x127	SK-1273	BTK	
1.4	05/03-12/04	F14D3	1399	25x127	SK-1273AQ2	BTKW	
1.5	11/02-12/04	F15S	1498	17x111; 05/2003 →; mit Zubehör	SK-1162	BTK	
1.4	05/03-12/04	F14D3	1399		0-N970	TB [TE]	
1.4	05/03-12/04	F14D3	1399		0-N971	TB [DG]	
1.4	11/02-12/04	F14D3, F14S3	1399		0-N1532	VB [BT]	S
1.4	11/02-12/04	F14D3, F14S3	1399	Rippenanzahl: 6;	0-N1646	VB [DG]	
1.4	11/02-12/04	F14S3	1399		0-N948	TB [TE]	
1.5	11/02-12/04	F15S	1498		0-N1532	VB [BT]	S
1.5	11/02-12/04	F15S3	1498	Rippenanzahl: 6;	0-N1646	VB [DG]	
1.5	11/02-12/04	F15S	1498		0-N948	TB [TE]	
KORANDO (KJ)							
2.3	01/99-	M 161.970	2295		0-N1833	VB [TE]	
2.3	01/99-	M 161.970	2295		0-N2418	VB [BT]	
2.9 D	01/99-	MB-OM 662	2874	Rippenanzahl: 6	0-N1288	VB [DG]	
2.9 D	01/99-	MB-OM 662	2874	hydraulisch	0-N1926	VB [VD]	
KORANDO Cabrio (KJ)							
2.3	02/99-	M 161.970	2295		0-N1833	VB [TE]	
2.3	02/99-	M 161.970	2295		0-N2418	VB [BT]	
2.9 D	02/99-	MB-OM 662	2874	Rippenanzahl: 6	0-N1288	VB [DG]	
2.9 D	02/99-	MB-OM 662	2874	hydraulisch	0-N1926	VB [VD]	
LABO Pick-up							
0.8	03/95-07/98	F8A	797	25.4x107	SK-1183	BTK	
LACETTI Kombi							
1.5 SE	04/98-05/99	A15DMS	1498		0-N970	TB [TE]	
1.5 SE	04/98-05/99	A15DMS	1498		0-N971	TB [DG]	
1.5 SE	04/98-05/99	A15DMS	1498		0-N1532	VB [BT]	S
1.5 SX	04/97-05/99	A15SMS	1498		0-N948	TB [TE]	
LACETTI Stufenheck							
1.5 SE	04/98-05/99	A15DMS	1498		0-N970	TB [TE]	
1.5 SE	04/98-05/99	A15DMS	1498		0-N971	TB [DG]	
2.0	04/97-05/99	C20SED, X 20 SED	1998		0-N100	TB [TE]	
2.0	04/97-05/99	C20SED, X 20 SED	1998		0-N906	TB [DG]	
1.5 SE	04/98-05/99	A15DMS	1498		0-N1532	VB [BT]	S
1.5 SX	04/97-05/99	A15SMS	1498		0-N948	TB [TE]	
LACETTI Stufenheck							
1.6	06/99-07/03	A16DMS	1598	25x127; 06/2002 →	SK-1273	BTK	
1.6	06/99-07/03	A16DMS	1598	25x127; 06/2002 →	SK-1273AQ2	BTKW	
1.6	06/99-07/03	A16DMS	1598		0-N970	TB [TE]	
1.6	06/99-07/03	A16DMS	1598		0-N971	TB [DG]	
2.0	06/99-07/03	C20SED, X 20 SED	1998		0-N100	TB [TE]	
2.0	06/99-07/03	C20SED, X 20 SED	1998		0-N906	TB [DG]	
1.6	06/99-07/03	A16DMS	1598		0-N1532	VB [BT]	S

CM³

Art. Nr.

**LACETTI Stufenheck (J200)**

1.8 CDX	08/03-12/04	T18SED	1799	24x169	SK-1100	BTK
1.8 CDX	08/03-12/04	T18SED	1799	24x169	SK-1100AQ1	BTKW
1.8 CDX	08/03-12/04	T18SED	1799		0-N100	TB [TE]
1.8 CDX	08/03-12/04	T18SED	1799		0-N906	TB [DG]

LACETTI Schrägheck (KLAN)

1.4	02/04-	F14D3	1399	25x127	SK-1273	BTK
1.4	02/04-	F14D3	1399	25x127	SK-1273AQ2	BTKW
1.6	02/04-	F16D3	1598	25x127	SK-1273	BTK
1.6	02/04-	F16D3	1598	25x127	SK-1273AQ2	BTKW
1.8	02/04-	T18SED	1799	24x169	SK-1100	BTK
1.8	02/04-	T18SED	1799	24x169	SK-1100AQ1	BTKW
1.4	02/04-	F14D3	1399		0-N970	TB [TE]
1.4	02/04-	F14D3	1399		0-N971	TB [DG]
1.6	02/04-	F16D3	1598		0-N970	TB [TE]
1.6	02/04-	F16D3	1598		0-N971	TB [DG]
1.8	02/04-	T18SED	1799		0-N100	TB [TE]
1.8	02/04-	T18SED	1799		0-N906	TB [DG]
1.4	02/04-	F14D3	1399		0-N1532	VB [BT] S
1.4	02/04-	F14D3	1399	Rippenanzahl: 6;	0-N1646	VB [DG]
1.6	02/04-	F16D3	1598		0-N1532	VB [BT] S
1.6	02/04-	F16D3	1598	Rippenanzahl: 6;	0-N1646	VB [DG]
1.8	02/04-	T18SED	1799		0-N1422	VB [BT] S

LANOS (KLAT)

1.4	05/97-	A14SMS	1349	17x111; mit Zubehör	SK-1162	BTK
1.4	05/97-	A14SMS	1349	17x111	SK-1162AQ3	BTKW
1.5	05/97-	A15SMS	1498	17x111; mit Zubehör	SK-1162	BTK
1.5	05/97-	A15SMS	1498	17x111	SK-1162AQ3	BTKW
1.5	10/97-06/99	A15SMS	1498	17x111; mit Zubehör; Baumuster: ATF48	SK-1162	BTK
1.6 16V	05/97-	A16DMS	1598	25x127; Baumuster: ATA08, ATA48, ATF08	SK-1273	BTK
1.6 16V	05/97-	A16DMS	1598	25x127	SK-1273AQ1	BTKW
1.6 16V	05/97-	A16DMS	1598		0-N970	TB [TE]
1.6 16V	05/97-	A16DMS	1598		0-N971	TB [DG]
1.4	05/97-	A14SMS	1349		0-N948	TB [TE]
1.5	05/97-06/99	A15SMS	1498		0-N948	TB [TE]
1.5	10/97-06/99	A15SMS	1498		0-N1532	VB [BT] S
1.6 16V	05/97-	A16DMS	1598		0-N1532	VB [BT] S
1.4	05/97-	A14SMS	1349	→ 12/2002	0-N2097	FB [DG]
1.5	05/97-	A15SMS	1498	→ 12/2002	0-N2097	FB [DG]
1.5	10/97-06/99	A15SMS	1498		0-N2097	FB [DG]
1.6 16V	05/97-	A16DMS	1598	→ 12/2002	0-N2097	FB [DG]

LANOS Stufenheck (KLAT)

1.4	05/97-	A14SMS	1349	17x111; mit Zubehör	SK-1162	BTK
1.4	05/97-	A14SMS	1349	17x111	SK-1162AQ3	BTKW
1.5	05/97-	A15SMS	1498	17x111; mit Zubehör	SK-1162	BTK
1.5	05/97-	A15SMS	1498	17x111	SK-1162AQ3	BTKW
1.6 16V	05/97-	A16DMS	1598	25x127; Baumuster: ATA69, ATF69	SK-1273	BTK
1.6 16V	05/97-	A16DMS	1598	25x127	SK-1273AQ1	BTKW
1.6 16V	05/97-	A16DMS	1598		0-N970	TB [TE]
1.6 16V	05/97-	A16DMS	1598		0-N971	TB [DG]
1.4	05/97-	A14SMS	1349		0-N948	TB [TE]
1.5	05/97-	A15SMS	1498		0-N948	TB [TE]
1.5	10/97-06/99	Y15LS	1498		0-N1532	VB [BT] S
1.6 16V	05/97-	A16DMS	1598		0-N1532	VB [BT] S
1.4	05/97-	A14SMS	1349	→ 12/2002	0-N2097	FB [DG]
1.5	05/97-	A15SMS	1498	→ 12/2002	0-N2097	FB [DG]
1.5	10/97-06/99	Y15LS	1498		0-N2097	FB [DG]
1.6 16V	05/97-	A16DMS	1598	→ 12/2002	0-N2097	FB [DG]

LEGANZA (KLAV)

2.0 16V	06/97-12/02	X 20 SED	1998	24x169; 12/1998 →	SK-1100	BTK
2.0 16V	06/97-12/02	X 20 SED	1998	24x169; 12/1998 →	SK-1100AQ1	BTKW
2.0 16V	07/00-04/04	T20SED	1998	24x169	SK-1100	BTK
2.0 16V	07/00-04/04	T20SED	1998	24x169	SK-1100AQ1	BTKW
2.2 16V	04/99-12/02	T22SED	2198	24x171; Baumuster: AVA69, AVF69	SK-1644	BTK
2.2 16V	04/99-12/02	T22SED	2198	24x171	SK-1644AQ1	BTKW



CM³



Art. Nr.



ohne Halter

LEGANZA (KLAV)							
2.0 16V	06/97-04/04	T20SED, X 20 SED	1998			0-N100	TB [TE]
2.0 16V	06/97-04/04	T20SED, X 20 SED	1998			0-N906	TB [DG]
2.2 16V	04/99-12/02	T22SED	2198			0-N906	TB [DG]
2.0 16V	06/97-04/04	T20SED, X 20 SED	1998			0-N1422	VB [BT] S
LEMANS							
1.5	09/90-07/95	G15MG	1498	17x111; mit Zubehör		SK-1162	BTK
MAGNUS							
2.0	07/99-	X 20 SED	1998	24x169		SK-1100	BTK
2.0	07/99-	X 20 SED	1998	24x169		SK-1100AQ1	BTKW
2.0	07/99-	X 20 SED	1998			0-N100	TB [TE]
2.0	07/99-	X 20 SED	1998			0-N906	TB [DG]
MATIZ (KLYA)							
0.8	09/98-	F8CV	796	25.4x107		SK-1183	BTK
0.8	09/98-	F8CV	796	25.4x107		SK-1183AQ1	BTKW
1.0	01/03-	B10S	995	25x109		SK-1685	BTK
1.0	01/03-	B10S	995	25x109		SK-1685AQ1	BTKW
0.8	09/98-	F8CV	796			0-N973	TB [TE]
1.0	01/03-	B10S	995			0-N973	TB [TE]
MUSSO (FJ)							
2.3	01/99-	M 111.970	2295			0-N1833	VB [TE]
2.3	01/99-	M 111.970	2295			0-N2418	VB [BT]
2.9 D 4x4	01/99-09/99	MB-OM 662	2874	Rippenanzahl: 6		0-N1288	VB [DG]
2.9 D 4x4	01/99-09/99	MB-OM 662	2874	hydraulisch		0-N1926	VB [VD]
NEXIA (KLETN)							
1.5	02/95-08/97	G15MF	1498	17x111; mit Zubehör		SK-1162	BTK
1.5	02/95-08/97	G15MF	1498	17x111; mit Zubehör		SK-1162AQ1	BTKW
1.5 16V	02/95-08/97	A15MF	1498	25x127		SK-1273	BTK
1.5 16V	02/95-08/97	A15MF	1498	25x127		SK-1273AQ1	BTKW
1.5 16V	02/95-08/97	A15MF	1498			0-N970	TB [TE]
1.5 16V	02/95-08/97	A15MF	1498			0-N971	TB [DG]
1.5	02/95-08/97	G15MF	1498			0-N948	TB [TE]
NEXIA Stufenheck (KLETN)							
1.5	02/95-08/97	G15MF	1498	17x111; mit Zubehör		SK-1162	BTK
1.5	02/95-08/97	G15MF	1498	17x111; mit Zubehör		SK-1162AQ1	BTKW
1.5 16V	02/95-08/97	A15MF	1498	25x127		SK-1273	BTK
1.5 16V	02/95-08/97	A15MF	1498	25x127		SK-1273AQ1	BTKW
1.5 16V	02/95-08/97	A15MF	1498			0-N970	TB [TE]
1.5 16V	02/95-08/97	A15MF	1498			0-N971	TB [DG]
1.5	02/95-08/97	G15MF	1498			0-N948	TB [TE]
NEXIA Stufenheck							
1.6	07/08-	F16D3	1598	25x127		SK-1273	BTK
1.6	07/08-	F16D3	1598			0-N970	TB [TE]
1.6	07/08-	F16D3	1598			0-N971	TB [DG]
1.6	07/08-	F16D3	1598			0-N1532	VB [BT] S
1.6	07/08-	F16D3	1598	Rippenanzahl: 6; ✖		0-N1646	VB [DG]
1.5	07/08-	Y15L	1498			0-N2097	FB [DG]
NUBIRA (KLAJ)							
1.6	08/02-07/03	A16DMS	1598	25x127; Baumuster: AJA48, AJF48		SK-1273	BTK
1.6 16V	05/97-	A16DMS	1598	25x127		SK-1273	BTK
1.6, 1.6 16V	05/97-07/03	A16DMS	1598	25x127		SK-1273AQ2	BTKW
2.0 16V	05/97-	X 20 SED, Z20L, Z20L, Z20L, Z20L	1998	24x169; 06/1999 →		SK-1100	BTK
2.0 16V	05/97-	X 20 SED, Z20L, Z20L, Z20L, Z20L	1998	24x169; 06/1999 →		SK-1100AQ1	BTKW
2.0 CDX	08/02-07/03	T20SED	1998	24x169		SK-1100	BTK
2.0 CDX	08/02-07/03	T20SED	1998	24x169		SK-1100AQ1	BTKW
1.6, 1.6 16V	05/97-07/03	A16DMS	1598			0-N970	TB [TE]
1.6, 1.6 16V	05/97-07/03	A16DMS	1598			0-N971	TB [DG]
2.0 16V, 2.0 CDX	05/97-07/03	T20SED, X 20 SED, Z20L, Z20L, Z20L, Z20L	1998			0-N100	TB [TE]
2.0 16V, 2.0 CDX	05/97-07/03	T20SED, X 20 SED, Z20L, Z20L, Z20L, Z20L	1998			0-N906	TB [DG]
1.6, 1.6 16V	05/97-07/03	A16DMS	1598			0-N1532	VB [BT] S
2.0 16V	05/97-	X 20 SED, Z20L, Z20L, Z20L, Z20L	1998			0-N1422	VB [BT] S

CM³

Art. Nr.



ohne Halter

NUBIRA Stufenheck (KLAJ)

1.5 SE	06/99-07/03	A15DMS	1498	25x127	SK-1273	BTK	
1.6 16V	05/97-	A16DMS	1598	25x127	SK-1273	BTK	
1.6 16V	05/97-	A16DMS	1598	25x127	SK-1273AQ2	BTkW	
1.6 16V	07/00-	A16DMS	1598	25x127; 08/2002 →; Baumuster: AJA69, AJF69	SK-1273	BTK	
1.6 16V	07/00-	A16DMS	1598	25x127; 08/2002 →	SK-1273AQ2	BTkW	
2.0 16V	12/00-	T20SED	1998	24x169; 08/2002 →	SK-1100	BTK	
2.0 16V	12/00-	T20SED	1998	24x169; 08/2002 →	SK-1100AQ1	BTkW	
2.0, 2.0 16V	05/97-07/03	C20SED, X 20 SED	1998	24x169	SK-1100	BTK	
2.0, 2.0 16V	05/97-07/03	C20SED, X 20 SED	1998	24x169	SK-1100AQ1	BTkW	
1.5 SE	06/99-07/03	A15DMS	1498		0-N970	TB [TE]	
1.5 SE	06/99-07/03	A15DMS	1498		0-N971	TB [DG]	
1.6 16V	05/97-	A16DMS	1598		0-N970	TB [TE]	
1.6 16V	05/97-	A16DMS	1598		0-N971	TB [DG]	
2.0, 2.0 16V	05/97-07/03	C20SED, T20SED, X 20 SED	1998		0-N100	TB [TE]	
2.0, 2.0 16V	05/97-07/03	C20SED, T20SED, X 20 SED	1998		0-N906	TB [DG]	
1.5 SE	06/99-07/03	A15DMS	1498		0-N1532	VB [BT]	S
1.6 16V	05/97-	A16DMS	1598		0-N1532	VB [BT]	S
2.0 16V	05/97-	T20SED, X 20 SED	1998		0-N1422	VB [BT]	S

NUBIRA Wagon (KLAJ)

1.6 16V	05/97-	A16DMS, A16SMS	1598	25x127	SK-1273	BTK	
1.6 16V	05/97-	A16DMS, A16SMS	1598	25x127	SK-1273AQ2	BTkW	
1.6 16V	12/00-	A16DMS	1598	25x127; 08/2002 →; Baumuster: AJA35, AJF35	SK-1273	BTK	
1.6 16V	12/00-	A16DMS	1598	25x127; 08/2002 →	SK-1273AQ2	BTkW	
2.0 16V	05/97-	X 20 SED	1998	24x169; 06/1999 →	SK-1100	BTK	
2.0 16V	05/97-	X 20 SED	1998	24x169; 06/1999 →	SK-1100AQ1	BTkW	
2.0 16V	12/00-	T20SED	1998	24x169; 08/2002 →	SK-1100	BTK	
2.0 16V	12/00-	T20SED	1998	24x169; 08/2002 →	SK-1100AQ1	BTkW	
1.6 16V	05/97-	A16DMS, A16SMS	1598		0-N970	TB [TE]	
1.6 16V	05/97-	A16DMS, A16SMS	1598		0-N971	TB [DG]	
2.0 16V	05/97-	T20SED, X 20 SED	1998		0-N100	TB [TE]	
2.0 16V	05/97-	T20SED, X 20 SED	1998		0-N906	TB [DG]	
1.6 16V	05/97-	A16DMS, A16SMS	1598		0-N1532	VB [BT]	S
2.0 16V	05/97-	T20SED, X 20 SED	1998		0-N1422	VB [BT]	S

NUBIRA Stufenheck (KLAN)

1.4	10/03-12/04	F14D3	1399	25x127; Baumuster: ANF19	SK-1273	BTK	
1.4	10/03-12/04	F14D3	1399	25x127	SK-1273AQ2	BTkW	
1.6	07/03-	F16D3	1598	25x127; Baumuster: ANA19, ANF19	SK-1273	BTK	
1.6	07/03-	F16D3	1598	25x127	SK-1273AQ2	BTkW	
1.8	07/03-	T18SED	1799	24x169	SK-1100	BTK	
1.8	07/03-	T18SED	1799	24x169	SK-1100AQ1	BTkW	
1.4	10/03-12/04	F14D3	1399		0-N970	TB [TE]	
1.4	10/03-12/04	F14D3	1399		0-N971	TB [DG]	
1.6	07/03-	F16D3	1598		0-N970	TB [TE]	
1.6	07/03-	F16D3	1598		0-N971	TB [DG]	
1.8	07/03-	T18SED	1799		0-N100	TB [TE]	
1.8	07/03-	T18SED	1799		0-N906	TB [DG]	
1.4	10/03-12/04	F14D3	1399		0-N1532	VB [BT]	S
1.4	10/03-12/04	F14D3	1399	Rippenanzahl: 6;	0-N1646	VB [DG]	
1.6	07/03-	F16D3	1598		0-N1532	VB [BT]	S
1.6	07/03-	F16D3	1598	Rippenanzahl: 6;	0-N1646	VB [DG]	
1.8	07/03-	T18SED	1799		0-N1422	VB [BT]	S

NUBIRA Wagon (KLAN)

1.6	07/03-	F16D3	1598	25x127; Baumuster: ANA35, ANF35	SK-1273	BTK	
1.6	07/03-	F16D3	1598	25x127	SK-1273AQ2	BTkW	
1.8	07/03-	T18SED	1799	24x169	SK-1100	BTK	
1.8	07/03-	T18SED	1799	24x169	SK-1100AQ1	BTkW	
1.6	07/03-	F16D3	1598		0-N970	TB [TE]	
1.6	07/03-	F16D3	1598		0-N971	TB [DG]	
1.8	07/03-	T18SED	1799		0-N100	TB [TE]	
1.8	07/03-	T18SED	1799		0-N906	TB [DG]	
1.6	07/03-	F16D3	1598		0-N1532	VB [BT]	S
1.6	07/03-	F16D3	1598	Rippenanzahl: 6;	0-N1646	VB [DG]	
1.8	07/03-	T18SED	1799		0-N1422	VB [BT]	S



CM³



Art. Nr.



PRINCE (J19)							
2.0	08/92-07/95	C20LZ	1998	20x125	SK-1184	BTK	
1.8	08/90-08/97	S 18 NV	1796		0-N101	TB [TE]	
2.0	08/91-08/98	X 20 XEV	1998		0-N100	TB [TE]	
2.0	08/91-08/98	X 20 XEV	1998		0-N906	TB [DG]	
2.2	08/97-08/99	X 22 XE	2198		0-N906	TB [DG]	
3.0	08/94-07/97	C 30 NE	2969	EMSAE:01039675→; Rippenanzahl: 6	0-N1439	VB [DG]	
REXTON (GAB_)							
2.3 RX230 4x4	05/02-	M 161.974	2295		0-N2418	VB [BT]	
REZZO (KLAU)							
1.6	09/00-	A16DMS	1598	25x127; 02/2002 →	SK-1273	BTK	
1.6	09/00-	A16DMS	1598	25x127; 08/2001 →	SK-1273	BTK	
1.6	09/00-	A16DMS	1598	25x127; 08/2001 →	SK-1273AQ2	BTKW	
1.6 SX	08/01-12/04	A16SMS	1598	25x127	SK-1273	BTK	
1.6 SX	08/01-12/04	A16SMS	1598	25x127	SK-1273AQ2	BTKW	
2.0	09/00-	T20SED, X 20 SED	1998	24x169	SK-1100	BTK	
2.0	09/00-	T20SED, X 20 SED	1998	24x169	SK-1100AQ1	BTKW	
1.6	09/00-	A16DMS	1598		0-N970	TB [TE]	
1.6	09/00-	A16DMS	1598		0-N971	TB [DG]	
2.0	09/00-	T20SED, X 20 SED	1998		0-N100	TB [TE]	
2.0	09/00-	T20SED, X 20 SED	1998		0-N906	TB [DG]	
1.6	09/00-	A16DMS	1598		0-N1532	VB [BT]	S
2.0	09/00-	T20SED, X 20 SED	1998		0-N1422	VB [BT]	S
TICO (KLY3)							
0.8	02/95-12/00	F8C, F8CV	796	25.4x107	SK-1183	BTK	
0.8	02/95-12/00	F8C, F8CV	796		0-N973	TB [TE]	
TOSCA							
1.8	02/06-	T18SED	1799	24x169	SK-1100	BTK	
2.0 TDCi	02/06-	Z 20 DMH	1991	22x151	SK-1723	BTK	
2.0 TDCi	02/06-	Z 20 DMH	1991	22x151	SK-1723AQ1	BTKW	
1.8	02/06-	T18SED	1799		0-N100	TB [TE]	
1.8	02/06-	T18SED	1799		0-N906	TB [DG]	
2.0 TDCi	02/06-	Z 20 DMH	1991		0-N1952	TB [TE]	
2.0 TDCi	02/06-	Z 20 DMH	1991		0-N1960	TB [TE]	
2.0 TDCi	02/06-	Z 20 DMH	1991		0-N2171	VB [DG]	
2.0 TDCi	02/06-	Z 20 DMH	1991		0-N2197	VB [BT]	S



OPTIMAL®

DAIHATSU



CM³



Art. Nr.



APPLAUSE I (A101, A111)								
1.6 16V	06/89-07/97	HD, HD-E	1590	25x95	SK-1407	BTK		
1.6 16V 4WD	06/89-07/97	HD-E	1590	25x95; 09/1989 →	SK-1407	BTK		
1.6 16V , 1.6 16V 4WD	06/89-07/97	HD, HD-E	1590		0-N036	TB [TE]		
APPLAUSE II (A101)								
1.6 16V	07/97-05/00	HD-E	1590	25x95	SK-1407	BTK		
1.6 16V	07/97-05/00	HD-E	1590		0-N036	TB [TE]		
BEGO								
1.3 DVVT, 1.3 DVVT 4x4	11/05-	K3-VE	1298		0-N2229	VB [TE]		
1.5 DVVT 4x4	11/05-	3SZ-VE	1495		0-N2273	VB [TE]		
CERIA								
1.0 DVVT	06/05-	EJ-VE	989		0-N1764	TB [BT]		
CHARADE I (G10)								
1.0	10/77-02/83	CB 20, CB 20, CB 22	993		0-N037	TB [TE]		
1.0	10/77-02/83	CB 20, CB 20, CB 22	993		0-N041	TB [DG]		
CHARADE II (G11, G30)								
1.0 , 1.0 D , 1.0 TD , 1.0 Turbo	10/83-03/87	CB 20, CB 22, CB 60, CL 10, CL 60	993		0-N038	TB [TE]		
1.0 D , 1.0 TD	10/83-03/87	CL 10, CL 60	993		0-N2323	TB [TE]		
CHARADE III (G100, G101, G102)								
1.3	09/88-01/92	HC-C	1295	25x93	SK-1257	BTK		
1.3 i , 1.3 i 4WD	06/88-01/93	HCE	1296	25x93	SK-1257	BTK		
1.0 , 1.0 D , 1.0 TD , 1.0 Turbo	03/87-12/92	CB 23, CB 61, CB 90, CL 11, CL , CL 61	993		0-N038	TB [TE]		
1.0 D , 1.0 TD	03/87-12/92	CL 11, CL, CL 61	993		0-N2323	TB [TE]		
1.0 GTi	03/87-12/92	CB 80 T	993		0-N039	TB [TE]		
1.0 GTi	03/87-12/92	CB 80 T	993		0-N040	TB [DG]		
1.0 GTi	03/87-12/92	CB 80 T	993		0-N041	TB [DG]		
1.3 i , 1.3 i 4WD	06/88-01/93	HCE	1296		0-N036	TB [TE]		
CHARADE III Stufenheck (G102)								
1.3	11/90-02/93	HCE	1296	25x93	SK-1257	BTK		
1.3	11/90-02/93	HCE	1296		0-N036	TB [TE]		
CHARADE IV (G200, G202)								
1.3	09/96-11/99	HC	1296	25x93; 07/1997 →	SK-1257	BTK		
1.3 16V, 1.3 i 16V	01/93-09/00	HC, HCE, HCE	1296	25x93	SK-1257	BTK		
1.5 i 16V	01/97-11/99	HEE, HEEG, HEEG, HEEG, HEEG, HEEG, HEEG, HEEG	1499	25x95	SK-1407	BTK		
1.6 GTi	03/93-11/99	HD-E	1590	25x95	SK-1407	BTK		
1.3, 1.3 16V, 1.3 i 16V	01/93-09/00	HC, HC, HCE, HCE	1296		0-N036	TB [TE]		
1.5 i 16V	01/97-11/99	HEE, HEEG, HEEG, HEEG, HEEG, HEEG, HEEG, HEEG	1499		0-N036	TB [TE]		
1.6 GTi	03/93-11/99	HD-E	1590		0-N036	TB [TE]		
CHARADE IV Stufenheck (G203)								
1.5 16V, 1.5 i 16V	08/94-	HEE	1499	25x95	SK-1407	BTK		
1.5 16V, 1.5 i 16V	08/94-	HEE	1499		0-N036	TB [TE]		
CHARADE (L2_)								
1.0	03/03-	EJ-VE	989	25.4x111; 10/2003 →	SK-1690	BTK		
1.0	03/03-	EJ-VE	989		0-N1764	TB [BT]		
CHARADE								
1.33 16V	05/11-	1NR-FE	1329		0-N2198	VB [BT]		S
CHARMANT (A)								
1.6	08/83-07/87	4A	1587	19x88	SK-1650	BTK		
1.6	09/85-07/87	4A	1588	19x88	SK-1650	BTK		
1.3	11/81-07/87	4K	1290		0-N997	TB [TE]		
1.6	12/81-07/87	2T, 4A	1588		0-N997	TB [TE]		
1.6	08/83-07/87	4A	1587		0-N997	TB [TE]		
COO								
1.0	10/06-	EJ-DE, EJ-VE	989		0-N1764	TB [BT]		
1.3, 1.3 Turbo	10/06-	K3-VE, K3-VET	1298		0-N2229	VB [TE]		
1.5, 1.5 4x4	10/06-	3SZ-VE	1495		0-N2273	VB [TE]		
COPEN (L880_, L881_)								
1.3	03/06-09/12	K3-VE	1298		0-N2339	VB [TE]		

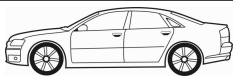

CM³



Art. Nr.



CUORE I (L55, L60)							
0.5	10/80-09/85	AB 30	547			0-N037	TB [TE]
0.6	08/82-09/85	AD 10	617			0-N037	TB [TE]
CUORE II (L80, L81)							
0.8	09/85-06/90	ED 10	847	→ 04/1989		0-N043	TB [TE]
0.8 4WD	09/86-10/88	ED 10	847			0-N043	TB [TE]
CUORE V (L7_)							
1.0 DVVT, 1.0 i	10/98-05/03	EJ-DE, EJ-VE, EJ-VE	989	25.4x111; 1		SK-1690	BTK
1.0, 1.0 DVVT, 1.0 i	10/98-05/03	EJ-DE, EJ-DE, EJ-VE, EJ-VE	989			0-N1764	TB [BT]
CUORE VI (L251, L250_, L260_)							
1.0	05/03-	EJ-VE	989	25.4x111; 1		SK-1690	BTK
1.0	05/03-	EJ-VE	989			0-N1764	TB [BT]
EXTOL Bus (S22_, S23_)							
1.3	07/00-11/11	K3-VE	1298	✳, für Fahrzeuge mit Servolenkung; Fahrzeugproduktionsland Japan		0-N1983	VB [DG]
1.3, 1.3 4x4, 1.3 L	07/00-11/11	K3-VE	1298			0-N2229	VB [TE]
FEROZA Hard Top (F300)							
1.6 16V, 1.6 i 16V	10/88-12/99	HDC, HD-E	1590	25x95		SK-1407	BTK
1.6 16V, 1.6 i 16V	10/88-12/99	HDC, HD-E	1590			0-N036	TB [TE]
FEROZA Soft Top (F300)							
1.6 16V, 1.6 i 16V	10/88-12/99	HDC, HD-E	1590	25x95		SK-1407	BTK
1.6 16V, 1.6 i 16V	10/88-12/99	HDC, HD-E	1590			0-N036	TB [TE]
GRAN MOVE (G3)							
1.5 16V	10/96-07/98	HEEG	1499	25x95		SK-1407	BTK
1.6 16V	05/98-	HDEP	1590	25x95		SK-1407	BTK
1.6 GLX, 1.6 GX	06/98-07/02	HDEP	1589	25x95		SK-1407	BTK
1.5 16V	10/96-07/98	HEEG	1499			0-N036	TB [TE]
1.6 16V	05/98-	HDEP	1590			0-N036	TB [TE]
HIJET Bus							
1.0	06/86-12/89	CB	993	19.05x91		SK-1255	BTK
0.8	06/86-12/89	CD	843			0-N043	TB [TE]
1.0	06/86-12/89	CB	993			0-N038	TB [TE]
HIJET Kasten							
1.0	06/86-12/89	CB	993	19.05x91		SK-1255	BTK
0.8	06/86-12/89	CD	843			0-N043	TB [TE]
1.0, 1.0 4x4	06/86-10/90	CB, CB 10	993			0-N038	TB [TE]
HIJET Bus (S85)							
1.0 i	07/94-05/98	CB42	993	19.05x91		SK-1255	BTK
1.0 i	07/94-05/98	CB42	993			0-N038	TB [TE]
HIJET Kasten (S85)							
1.0, 1.0 i	12/92-05/98	CB41, CB42	993	19.05x91		SK-1255	BTK
1.3 i 16V	05/98-	HCE	1295	25x93		SK-1257	BTK
1.0, 1.0 i	12/92-05/98	CB41, CB42	993			0-N038	TB [TE]
1.3 i 16V	05/98-	HCE	1295			0-N036	TB [TE]
HIJET Pick-up							
1.3	06/98-	HCE	1295	25x93		SK-1257	BTK
HIJET Pick-up (_U20)							
0.8	07/86-10/90	CD	843			0-N043	TB [TE]
1.0 Touring, 1.0 Touring 4x4	07/86-10/90	CB 10	993			0-N038	TB [TE]
HIJET Pick-up (_U60)							
1.0	12/92-05/98	CB41, CB42	993			0-N038	TB [TE]
LUXIO							
1.5 DVVT	03/09-	3SZ-VE	1495			0-N2273	VB [TE]
MATERIA (M4_)							
1.0, 1.0 DVVT	10/06-	EJ-DE, EJ-VE	989			0-N1764	TB [BT]
1.3	10/06-	K3-VE	1298	✳, für Fahrzeuge mit Servolenkung; Fahrzeugproduktionsland Japan		0-N1983	VB [DG]
1.3, 1.3 DVVT Turbo	10/06-	K3-VE, K3-VET	1298			0-N2229	VB [TE]
1.5, 1.5 ECO 4WD	10/06-	3SZ-VE	1495			0-N2273	VB [TE]
MOVE (L6_, L9_)							
1.0 i	10/98-09/02	EJ-DE	989	25.4x111; 08/2000 →		SK-1690	BTK

CM³

Art. Nr.



ohne Halter

MOVE (L6_, L9_)							
1.0 i	10/98-09/02	EJ-DE	989			0-N1764	TB [BT]
ROCKY Hard Top (F7, F8)							
2.8 D, 2.8 TD	02/85-12/98	DL, DL 51, DL 52, DLT, DL 52, DLT-C	2765	31.8x108		SK-1658	BTK
2.8 D, 2.8 TD	02/85-12/98	DL, DL 51, DL 52, DLT, DL 52, DLT-C	2765	mit Grundträger		0-N1562	TB [TE]
2.8 D, 2.8 TD	02/85-12/98	DL, DL 51, DL 52, DLT, DL 52, DLT-C	2765			0-N1563	TB [DG]
ROCKY Soft Top (F7, F8)							
2.8 D, 2.8 TD	02/85-12/98	DL, DL 51, DL 52	2765	31.8x108		SK-1658	BTK
2.8 D, 2.8 TD	02/85-12/98	DL, DL 51, DL 52	2765	mit Grundträger		0-N1562	TB [TE]
2.8 D, 2.8 TD	02/85-12/98	DL, DL 51, DL 52	2765			0-N1563	TB [DG]
RUSH							
1.3	11/05-	K3-VE	1298			0-N2229	VB [TE]
1.5, 1.5 4x4	11/05-	3SZ-VE	1495			0-N2273	VB [TE]
SIRION (M1)							
1.0 i, 1.0 i 4WD	04/98-01/05	EJ-DE, EJ-VE	989	25.4x111; 1		SK-1690	BTK
1.0, 1.0 i, 1.0 i 4WD	04/98-01/05	EJ-DE, EJ-VE	989			0-N1764	TB [BT]
1.3 Sport, 1.3 Sport 4WD	08/00-03/05	K3-VE2	1298			0-N2339	VB [TE]
SIRION (M3_)							
1.3, 1.3 4WD	01/05-	K3-VE	1298	✳, für Fahrzeuge mit Servolenkung; Fahrzeugproduktionsland Japan		0-N1983	VB [DG]
1.3, 1.3 4WD	01/05-	K3-VE	1298			0-N2229	VB [TE]
1.5, 1.5 4WD	05/06-10/08	3SZ-VE	1495			0-N2273	VB [TE]
SPARCAR Bus (S7_)							
0.8	09/83-05/86	CD	843			0-N043	TB [TE]
1.0	09/83-05/86	CB	993			0-N038	TB [TE]
SPARCAR Kasten (S7_)							
0.8	09/83-05/86	CD	843			0-N043	TB [TE]
1.0	09/83-05/86	CB	993			0-N038	TB [TE]
TAFT							
2.8 D 4x4	08/82-02/85	DL	2765	31.8x108		SK-1658	BTK
2.8 D 4x4	08/82-02/85	DL	2765	mit Grundträger		0-N1562	TB [TE]
2.8 D 4x4	08/82-02/85	DL	2765			0-N1563	TB [DG]
TERIOS (J1_)							
1.3 4WD	10/97-10/00	HCE, HC-EJ	1296	25x93		SK-1257	BTK
1.3 4WD	10/97-10/00	HCE, HC-EJ	1296			0-N036	TB [TE]
1.3, 1.3 4WD	10/00-10/05	K3-VE	1298	✳, für Fahrzeuge mit Servolenkung; Fahrzeugproduktionsland Japan		0-N1983	VB [DG]
1.3, 1.3 4WD, 1.3 DVVT FWD	10/00-10/05	K3-VE	1298			0-N2229	VB [TE]
TERIOS (J2_)							
1.3 DVVT 4x4	11/05-	K3-VE	1298	✳, für Fahrzeuge mit Servolenkung; Fahrzeugproduktionsland Japan		0-N1983	VB [DG]
1.3 DVVT 4x4	11/05-	K3-VE	1298			0-N2229	VB [TE]
1.5, 1.5 4WD, 1.5 DVVT	11/05-	3SZ-VE	1495			0-N2273	VB [TE]
TREVIS							
1.0	06/06-	EJ-VE	989	25.4x111; 1		SK-1690	BTK
1.0	06/06-	EJ-VE	989			0-N1764	TB [BT]
WILDCAT/ROCKY (F70)							
2.8 D, 2.8 TD	02/85-04/87	DL, DL 50	2765	31.8x108		SK-1658	BTK
2.8 D, 2.8 TD	02/85-04/87	DL, DL 50	2765	mit Grundträger		0-N1562	TB [TE]
2.8 D, 2.8 TD	02/85-04/87	DL, DL 50	2765			0-N1563	TB [DG]
WILDCAT/ROCKY (F75)							
2.8 D, 2.8 TD	02/85-04/87	DL, DL 50	2765	31.8x108		SK-1658	BTK
2.8 D, 2.8 TD	02/85-04/87	DL, DL 50	2765	mit Grundträger		0-N1562	TB [TE]
2.8 D, 2.8 TD	02/85-04/87	DL, DL 50	2765			0-N1563	TB [DG]
XENIA							
1.0	01/02-	EJ-DE	989			0-N1764	TB [BT]
1.3, 1.3 DVVT	01/02-	K3-VE	1298			0-N2229	VB [TE]
1.5	06/07-	3SZ-VE	1495			0-N2273	VB [TE]
YRV (M2)							
1.0	02/01-	EJ-VE	989	25.4x111; 1		SK-1690	BTK
1.0	02/01-	EJ-VE	989			0-N1764	TB [BT]
1.3, 1.3 4WD, 1.3 GTi	02/01-	K3-VE, K3-VET	1298			0-N2339	VB [TE]

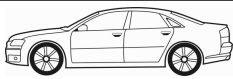

CM³



Art. Nr.



AVENGER							
2.0 CRD	06/07-	ECD	1968	30x141; mit Zubehör	SK-1595	BTK	
2.0 CRD	06/07-	ECD	1968	30x141; mit Zubehör	SK-1595AQ1	BTKW	
2.0 CRD	06/07-	ECD	1968		0-N1046	TB [DG]	
2.0 CRD	06/07-	ECD	1968		0-N1335	TB [TE]	
2.0 CRD	06/07-	ECD	1968		0-N1336	TB [DG]	
2.0	06/07-	ECN	1998		0-N2048	VB [DG]	
2.0	06/07-	ECN	1998		0-N2112	VB [BT]	S
2.0 CRD	06/07-	ECD	1968		0-N2364	VB [DG]	
2.0 CRD	06/07-	ECD	1968		0-N2397	VB [BT]	S
2.4	06/07-	ED3, EDG, EDG	2360		0-N2048	VB [DG]	
2.4	06/07-	ED3, EDG, EDG	2360		0-N2112	VB [BT]	S
2.7, 2.7 Flex-Fuel	06/07-	EER	2736		0-N2232	VB [BT]	S
AVENGER Coupe							
2.5	09/94-12/00	EEB	2497		0-N185	TB [TE]	
CALIBER							
2.0 CRD	06/06-	ECD	1968	30x141; mit Zubehör	SK-1595	BTK	
2.0 CRD	06/06-	ECE	1968	30x141; mit Zubehör	SK-1595	BTK	
2.0 CRD	06/06-	ECD, ECE	1968	30x141; mit Zubehör	SK-1595AQ1	BTKW	
2.0 CRD	06/06-	ECD, ECE	1968		0-N1046	TB [DG]	
2.0 CRD	06/06-	ECD, ECE	1968		0-N1335	TB [TE]	
2.0 CRD	06/06-	ECD, ECE	1968		0-N1336	TB [DG]	
1.8	06/06-	EBA	1798		0-N2048	VB [DG]	
1.8	06/06-	EBA	1798		0-N2112	VB [BT]	S
2.0	06/06-	ECN	1998		0-N2048	VB [DG]	
2.0	06/06-	ECN	1998		0-N2112	VB [BT]	S
2.0 CRD	06/06-	ECD, ECE	1968		0-N2364	VB [DG]	
2.0 CRD	06/06-	ECD, ECE	1968		0-N2397	VB [BT]	S
2.2 CRD	07/10-	ENE	2143		0-N2238	VB [DG]	
2.4 SRT4 AWD	10/06-	ED4	2360		0-N2048	VB [DG]	
2.4 SRT4 AWD	10/06-	ED4	2360		0-N2112	VB [BT]	S
2.4, 2.4 AWD, 2.4 Turbo	10/06-	ED3, ED4	2359		0-N2048	VB [DG]	
2.4, 2.4 Turbo	10/06-	ED3, ED4	2359		0-N2112	VB [BT]	S
CARAVAN							
3.3	10/89-09/90	EGA, EGP	3301	☼	0-N1695	VB [DG]	
3.3, 3.3 i	10/89-09/90	EGA, EGP	3301		0-N1698	VB [BT]	S
CARAVAN							
3.3	10/90-09/95	EGA, EGP	3301	☼	0-N1695	VB [DG]	
3.3, 3.3 i	10/90-09/95	EGA, EGP	3301		0-N1698	VB [BT]	S
CARAVAN							
2.4 i	01/95-03/01	EDZ	2429	28x146; 10/1995 →	SK-1701	BTK	
3.0	01/95-03/01	EFA	2972	25.4x149; 10/1995 →	SK-1308	BTK	
2.4 i	01/95-03/01	EDZ	2429	10/1995 →	0-N1962	TB [DG]	
3.3, 3.3 i	01/95-03/01	EGA, EGP	3301		0-N1698	VB [BT]	S
3.8 i, 3.8 i AWD	01/95-03/01	EGH	3778	10/1995 →; ☼	0-N1695	VB [DG]	
3.8 i, 3.8 i AWD	01/95-03/01	EGH	3778		0-N1698	VB [BT]	S
CARAVAN (RG_)							
2.4	02/00-12/07	EDZ	2429	28x146; 01/2001 →; Baumuster: 2003	SK-1700	BTK	
2.4	02/00-12/07	EDZ	2429	28x146; 01/2001 →	SK-1701	BTK	
2.4	02/00-12/07	EDZ	2429	01/2002 →	0-N1838S	TB [TE]	
2.4	02/00-12/07	EDZ	2429	01/2001 →	0-N1962	TB [DG]	
3.3, 3.3 AWD	02/00-12/07	EGA, EGM	3301		0-N1698	VB [BT]	S
3.3, 3.3 AWD	02/00-12/07	EGA, EGM	3301		0-N2406	VB [BT]	S
3.8, 3.8 AWD	02/00-12/07	EGH	3778	12/2000 →	0-N2406	VB [BT]	S
3.8, 3.8 AWD, 3.8 Turbo AWD	02/00-12/07	EGH	3778		0-N1698	VB [BT]	S
3.8, 3.8 AWD, 3.8 Turbo AWD	04/01-12/07	EGH	3778		0-N2406	VB [BT]	S
CARAVAN							
2.8 CRD	01/09-	ENS	2777		0-N1612	TB [TE]	
2.8 CRD	01/09-	ENS	2777		0-N2329	TB [TE]	
2.8 CRD	01/09-	ENS	2777		0-N2203	VB [BT]	S
CHARGER							
2.7	04/06-12/10	EER	2736		0-N2233	VB [TE]	
5.7 R/T	06/05-12/08	EZA	5654		0-N1686	VB [DG]	

CM³

Art. Nr.



CHARGER									
6.1	09/05-12/10	ESF	6059			0-N1686	VB [DG]		
COLT Stufenheck									
2.4	01/79-12/84		1410			0-N2299	VB [BT]	S	
DAKOTA									
3.9 AWD, 3.9 SLT	10/95-09/03	EHC	3908			0-N1839	VB [BT]	S	
5.2	10/95-09/00	ELN	5210			0-N1839	VB [BT]	S	
DART									
2.0	04/12-		1995			0-N2112	VB [BT]	S	
2.4	04/12-	ED6	2360			0-N2112	VB [BT]	S	
DURANGO									
4.7 AWD	11/03-12/06	EVA	4701			0-N1690	VB [DG]		
4.7 AWD	11/03-12/06	EVA	4701			0-N2257	VB [BT]		
4.7 AWD	11/03-12/06	EVA	4701			0-N2257S1	VB [DG]		
4.7 AWD	11/03-12/06	EVA	4701			0-N2257S2	VB [DG]		
GRAND CARAVAN									
3.3	06/07-	EGM	3301			0-N1698	VB [BT]	S	
3.3	06/07-	EGM	3301	→ 01/2008		0-N2406	VB [BT]	S	
3.8	06/07-	EGH	3778			0-N1698	VB [BT]	S	
GRAND CARAVAN Mini Cargo Van									
3.3	01/04-12/05		3294			0-N2406	VB [BT]	S	
GRAND CARAVAN Mini Passenger Van									
3.3 Flex, 3.3 Flexfuel AWD	01/98-12/03		3294			0-N2406	VB [BT]	S	
3.8, 3.8 AWD	01/94-12/97		3769			0-N2406	VB [BT]	S	
INTREPID									
3.3	10/92-12/98	EGB, EGD	3301			0-N1698	VB [BT]	S	
JOURNEY									
2.0 CRD	06/08-	ECE	1968	30x141; mit Zubehör		SK-1595	BTK		
2.0 CRD	06/08-	ECE	1968	30x141; mit Zubehör		SK-1595AQ1	BTKW		
2.0 CRD	06/08-	ECE	1968			0-N1046	TB [DG]		
2.0 CRD	06/08-	ECE	1968			0-N1335	TB [TE]		
2.0 CRD	06/08-	ECE	1968			0-N1336	TB [DG]		
2.0 CRD	06/08-	ECE	1968			0-N2364	VB [DG]		
2.0 CRD	06/08-	ECE	1968			0-N2397	VB [BT]	S	
2.4, 2.4 ECO+	09/08-	ED3, ED3, EDG, EDG	2360			0-N2048	VB [DG]		
2.4, 2.4 ECO+	09/08-	ED3, ED3, EDG, EDG	2360			0-N2112	VB [BT]	S	
2.7, 2.7 FLEXFUEL	01/09-	EER	2736			0-N2232	VB [BT]	S	
NEON II									
2.0 16V	08/99-	ECB, ECH	1996	01/2002 →; ohne Grundträger		0-N1836	VB [BT]		
NITRO									
2.8 CRD, 2.8 CRD 4WD	06/07-12/12	ENR, ENS	2777	25x171		SK-1734	BTK		
2.8 CRD, 2.8 CRD 4WD	06/07-12/12	ENR	2777			0-N1411	TB [DG]		
2.8 CRD, 2.8 CRD 4WD	06/07-12/12	ENR, ENS	2777			0-N1612	TB [TE]		
2.8 CRD, 2.8 CRD 4WD	06/07-12/12	ENS	2777			0-N2329	TB [TE]		
2.8 CRD 4WD	06/07-12/12	ENS	2777			0-N2048	VB [DG]		
2.8 CRD, 2.8 CRD 4WD	06/07-12/12	ENR, ENS	2777			0-N1423	VB [DG]		
2.8 CRD, 2.8 CRD 4WD	06/07-12/12	ENR, ENS	2777			0-N2203	VB [BT]	S	
3.7 V6 4WD	06/07-12/12	EKG	3700			0-N1684	VB [DG]		
3.7 V6 4WD	06/07-12/12	EKG	3700			0-N1690	VB [DG]		
3.7 V6, 3.7 V6 4WD	06/07-12/12	EKG	3700			0-N2257	VB [BT]		
3.7 V6, 3.7 V6 4WD	06/07-12/12	EKG	3700			0-N2257S1	VB [DG]		
3.7 V6, 3.7 V6 4WD	06/07-12/12	EKG	3700			0-N2257S2	VB [DG]		
STRATUS									
2.5 V6	12/95-04/01	EEB	2497			0-N185	TB [TE]		
2.5 V6	12/95-04/01	EEB	2497			0-N189	TB [DG]		
STRATUS Coupe									
2.4	01/01-12/01	EDZ	2351	01/2003 →		0-N1838S	TB [TE]		
2.4	01/01-12/01		2429	01/2003 →		0-N1838S	TB [TE]		
3.0	09/00-12/05		2972			0-N185	TB [TE]		
STRATUS [USA] Stufenheck									
2.4	01/01-12/01	EDZ	2351	01/2003 →		0-N1838S	TB [TE]		



CM³



Art. Nr.



ohne Halter

STRATUS II

2.4 STX	10/00-10/06	EDZ	2429	01/2003 →	0-N1838S	TB [TE]	
3.0	10/00-12/01		2972		0-N185	TB [TE]	

RAM 3500 [USA] Crew Cab Pickup

3.0 V6 24V	01/03-12/03		5890		0-N185	TB [TE]	
------------	-------------	--	------	--	---------------	---------	--

RAM 2500 [USA] Crew Cab Pickup

2.0 Flex	01/98-12/01		5890		0-N2353	VB [DG]	
----------	-------------	--	------	--	----------------	---------	--

RAM 2500 Cab & Chassis

2.0 Flex	01/98-12/01		5890		0-N2353	VB [DG]	
----------	-------------	--	------	--	----------------	---------	--



OPTIMAL®

DONGNAN (SOUEAST)

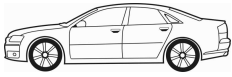

CM³



Art. Nr.



ohne Halter

FREECA Großraumlimousine

2.0	04/00-08/03	4G63	1997		0-N056	TB [TE]	
-----	-------------	------	------	--	--------	---------	--

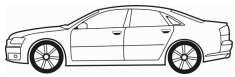

CM³



Art. Nr.



ohne Halter

500 Stufenheck

1.6	01/92-10/99	B69N, B6EW	1598	22x145	SK-1224	BTK	
2.0	01/92-10/99	KF27	1995	30x192	SK-1457	BTK	

800 Stufenheck (E65, TA)

2.0	09/93-06/96	KF42	1995	30x192	SK-1457	BTK	
2.5	09/93-12/02	KL68, KLZ5	2497	30x192	SK-1457	BTK	



OPTIMAL®

FENGXING (DONGFENG)

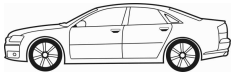

CM³



Art. Nr.



ohne Halter

FUTURE Großraumlimousine

1.8	12/07-	4G93	1834		0-N056	TB [TE]	
-----	--------	------	------	--	--------	---------	--



CM³



Art. Nr.



ohne Halter

127 (127_)							
1.3 Sport	12/81-05/83	127 A3.000	1301	15x120	SK-1449	BTK	
1.0, 1.0 Sport	04/77-12/86	127 A.000, 127 A1.000	1049		0-N850	TB [TE]	
1.3 Sport	12/81-05/83	127 A3.000	1301		0-N850	TB [TE]	
127 Panorama (127_)							
1.0	01/77-12/86	127 A.000	1049		0-N850	TB [TE]	
131 (131_)							
2.5 Diesel	06/78-02/84	8144.61	2445	30x152; ohne Spannelement	SK-1657	BTK	
2.0 D	07/78-08/84	8144.65	1995		0-N1617	TB [BT]	
2.0 D	07/78-08/84	8144.65	1995		0-N816	TB [DG]	
2.0 D	07/78-08/84	8144.65	1995		0-N821	TB [DG]	
2.5 Diesel	06/78-02/84	8144.61	2445		0-N1617	TB [BT]	
2.5 Diesel	06/78-02/84	8144.61	2445		0-N816	TB [DG]	
2.5 Diesel	06/78-02/84	8144.61	2445		0-N821	TB [DG]	
131 Familiare/Panorama (131_)							
2.5 Super Diesel	03/79-12/84	8144.61	2445	30x152; ohne Spannelement	SK-1657	BTK	
2.0 D	07/78-08/84	8144.65	1995		0-N1617	TB [BT]	
2.0 D	07/78-08/84	8144.65	1995		0-N816	TB [DG]	
2.0 D	07/78-08/84	8144.65	1995		0-N821	TB [DG]	
2.5 Super Diesel	03/79-12/84	8144.61	2445		0-N1617	TB [BT]	
2.5 Super Diesel	03/79-12/84	8144.61	2445		0-N816	TB [DG]	
2.5 Super Diesel	03/79-12/84	8144.61	2445		0-N821	TB [DG]	
132 (132_)							
2.5 D	07/78-07/82	8144.61	2445	30x152	SK-1657	BTK	
2.0 D	07/78-07/82	8144.65	1995		0-N1617	TB [BT]	
2.0 D	07/78-07/82	8144.65	1995		0-N816	TB [DG]	
2.0 D	07/78-07/82	8144.65	1995		0-N821	TB [DG]	
2.5 D	07/78-07/82	8144.61	2445		0-N1617	TB [BT]	
2.5 D	07/78-07/82	8144.61	2445		0-N816	TB [DG]	
2.5 D	07/78-07/82	8144.61	2445		0-N821	TB [DG]	
500 (312)							
1.2	10/07-	169 A4.000	1242	22x129; → 06/2008	SK-1677AQ1	BTKW	
1.2, 1.2 LPG	10/07-	169 A4.000	1242	22x129	SK-1677	BTK	
1.4	10/07-	169 A3.000	1368	22x124; Baumuster: 312	SK-1412	BTK	
1.4	10/07-	169 A3.000	1368	22x124	SK-1412AQ2	BTKW	
1.2, 1.2 LPG	10/07-	169 A4.000	1242		0-N1616	TB [TE]	
1.4	10/07-	169 A3.000	1368		0-N195	TB [TE]	
1.2, 1.2 LPG	10/07-	169 A4.000	1242		0-N1517	VB [BT]	S
1.3 D Multijet	10/07-	169 A1.000, 199 B1.000	1248		0-N1478S	VB [TE]	
1.4	10/07-	169 A3.000	1368		0-N1517	VB [BT]	S
500 C (312)							
1.2	09/09-	169 A4.000	1242	22x129	SK-1677	BTK	
1.4	09/09-	169 A3.000	1368	22x124; Baumuster: 312	SK-1412	BTK	
1.4	09/09-	169 A3.000	1368	22x124	SK-1412AQ2	BTKW	
1.2	09/09-	169 A4.000	1242		0-N1616	TB [TE]	
1.4	09/09-	169 A3.000	1368		0-N195	TB [TE]	
1.2	09/09-	169 A4.000	1242		0-N1517	VB [BT]	S
1.3 D Multijet	09/09-	169 A1.000, 199 B1.000	1248		0-N1478S	VB [TE]	
1.4	09/09-	169 A3.000	1368		0-N1517	VB [BT]	S
500L (199_)							
1.4	09/12-	843 A1.000	1368	22x124	SK-1412	BTK	
1.4	09/12-	843 A1.000	1368	22x124	SK-1412AQ2	BTKW	
1.6 D Multijet	09/12-	199 B5.000, 940 C1.000, 955 A3.000	1598	24x194	SK-1693	BTK	
1.6 D Multijet	09/12-	199 B5.000, 940 C1.000, 955 A3.000	1598	24x194	SK-1693AQ1	BTKW	
1.4	09/12-	843 A1.000	1368		0-N195	TB [TE]	
1.6 D Multijet	09/12-	199 B5.000, 940 C1.000, 955 A3.000	1598		0-N2149	TB [DG]	
1.3 D Multijet	09/12-	199 B4.000	1248		0-N1478S	VB [TE]	
1.4	09/12-	843 A1.000	1368		0-N1517	VB [BT]	S
500X (334)							
1.6 D Multijet	09/14-	55260384	1598		0-N2149	TB [DG]	
2.0 D Multijet 4x4	09/14-	55263087, 55263088	1956		0-N2149	TB [DG]	
ARGENTA (132A)							
2500 Diesel, 2500 Turbodiesel	06/81-11/85	8144.61, 8144.61.500.81	2445	30x152	SK-1657	BTK	



OPTIMAL®

FIAT



CM³



Art. Nr.



ARGENTA (132A)

2500 Diesel, 2500 Turbodiesel	06/81-11/85	8144.61, 8144.61.500.81	2445			0-N1617	TB [BT]	
2500 Diesel, 2500 Turbodiesel	06/81-11/85	8144.61, 8144.61.500.81	2445			0-N816	TB [DG]	
2500 Diesel, 2500 Turbodiesel	06/81-11/85	8144.61, 8144.61.500.81	2445			0-N821	TB [DG]	

BARCETTA (183)

1.8 16V	04/95-05/05	183 A1.000	1747	24x168; → 05/1998		SK-1361	BTK	
1.8 16V	04/95-05/05	183 A1.000	1747	24x168; → 05/1998		SK-1361AQ1	BTKW	
1.8 16V	04/95-05/05	183 A1.000	1747	24x168; 05/1998 →		SK-1410	BTK	
1.8 16V	04/95-05/05	183 A1.000	1747	24x168; 05/1998 →		SK-1410AQ1	BTKW	
1.8 16V	04/95-05/05	188 A6.000	1747	24x166		SK-1415	BTK	
1.8 16V	04/95-05/05	183 A1.000	1747	→ 05/1998		0-N114	TB [TE]	
1.8 16V	04/95-05/05	183 A1.000, 188 A6.000	1747	06/1998 →		0-N194	TB [TE]	
1.8 16V	04/95-05/05	183 A1.000, 188 A6.000	1747			0-N938	TB [DG]	
1.8 16V	04/95-05/05	183 A1.000, 188 A6.000	1747			0-N1403	VB [DG]	
1.8 16V	04/95-05/05	183 A1.000	1747			0-N1407	VB [BT]	S
1.8 16V	04/95-05/05	188 A6.000	1747			0-N1407	VB [BT]	S

BRAVA (182)

1.2 16V 80	12/98-12/02	182 B2.000	1242	22x124		SK-1412	BTK	
1.2 16V 80	12/98-12/02	182 B2.000	1242	22x124; → 04/1999		SK-1412AQ1	BTKW	
1.2 16V 80	12/98-12/02	182 B2.000	1242	22x124; 04/1999 →		SK-1412AQ2	BTKW	
1.2 16V 80	10/00-10/01	188 A5.000	1242	22x124; Baumuster: 182		SK-1412	BTK	
1.2 16V 80	10/00-10/01	188 A5.000	1242	22x124		SK-1412AQ2	BTKW	
1.4, 1.4 12 V	10/95-10/01	182 A3.000, 182 A5.000	1370	18x134		SK-1345	BTK	
1.6 16V	10/95-10/01	182 A4.000, 182 A6.000	1581	25x158		SK-1076	BTK	
1.6 16V	01/99-12/02	182 B6.000	1596	25x158; 09/2000 →		SK-1076	BTK	
1.8 GT 16V	10/95-10/01	182 A2.000	1747	24x168		SK-1410	BTK	
1.8 GT 16V	10/95-10/01	182 A2.000	1747	24x168		SK-1410AQ1	BTKW	
1.9 D	10/95-10/01	160 A7.000	1929	22x173		SK-1033	BTK	
1.9 JTD, 1.9 JTD 105	12/98-10/01	182 B4.000, 182 B9.000	1910	24x190; mit Zubehör		SK-1629	BTK	
1.9 JTD, 1.9 JTD 105	12/98-10/01	182 B4.000, 182 B9.000	1910	24x190; mit Zubehör		SK-1629AQ1	BTKW	
1.9 JTD, 1.9 TD 100 S	03/96-10/01	182 A7.000	1910	24x193; mit Zubehör		SK-1646	BTK	
1.9 JTD, 1.9 TD 100 S	03/96-10/01	182 A7.000	1910	24x193		SK-1646AQ1	BTKW	
1.9 TD 100 S	03/96-10/01	182 A7.000	1910	24x190; 09/1996 →; mit Zubehör		SK-1629	BTK	
1.9 TD 100 S	03/96-10/01	182 A7.000	1910	24x190; 09/1996 →; mit Zubehör		SK-1629AQ1	BTKW	
1.9 TD 75 S	03/96-10/01	182 A8.000	1910	24x193; mit Zubehör		SK-1646	BTK	
1.9 TD 75 S	03/96-10/01	182 A8.000	1910	24x193		SK-1646AQ1	BTKW	
1.2 16V 80	12/98-12/02	182 B2.000, 188 A5.000	1242			0-N195	TB [TE]	
1.4, 1.4 12 V	10/95-10/01	182 A3.000, 182 A5.000	1370			0-N113	TB [TE]	
1.6 16V	10/95-10/01	182 A4.000, 182 A6.000	1581			0-N208	TB [TE]	
1.6 16V	10/95-10/01	182 A4.000, 182 A6.000	1581			0-N951	TB [DG]	
1.8 GT 16V	10/95-10/01	182 A2.000	1747			0-N194	TB [TE]	
1.8 GT 16V	10/95-10/01	182 A2.000	1747			0-N938	TB [DG]	
1.9 D	10/95-10/01	160 A7.000	1929			0-N835	TB [TE]	
1.9 JTD, 1.9 JTD 105, 1.9 TD 100 S, 1.9 TD 75 S	03/96-10/01	182 A7.000, 182 A8.000, 182 B4.000, 182 B9.000	1910			0-N115	TB [TE]	
1.9 JTD, 1.9 JTD 105, 1.9 TD 100 S, 1.9 TD 75 S	03/96-12/02	182 A7.000, 182 A8.000, 182 B4.000, 182 B9.000	1910			0-N1326	TB [DG]	
1.2 16V 80	12/98-12/02	182 B2.000, 188 A5.000	1242	☼		0-N1398	VB [DG]	
1.2 16V 80	12/98-12/02	182 B2.000, 188 A5.000	1242	☼		0-N1481	VB [BT]	S
1.4, 1.4 12 V	10/95-10/01	182 A3.000, 182 A5.000	1370			0-N1403	VB [DG]	
1.4, 1.4 12 V	10/95-10/01	182 A3.000, 182 A5.000	1370			0-N1407	VB [BT]	S
1.6 16V	10/95-10/01	182 A4.000, 182 A6.000	1581	03/2000 →		0-N1450	VB [DG]	
1.6 16V	10/95-10/01	182 A4.000, 182 A6.000	1581	→ 02/2000		0-N187	VB [DG]	
1.8 GT 16V	10/95-10/01	182 A2.000	1747			0-N1403	VB [DG]	
1.8 GT 16V	10/95-10/01	182 A2.000	1747			0-N1407	VB [BT]	S
1.9 D	10/95-10/01	160 A7.000	1929			0-N1672	VB [DG]	
1.9 JTD, 1.9 JTD 105	12/98-10/01	182 B4.000, 182 B9.000	1910			0-N1487	VB [BT]	S
1.9 JTD, 1.9 JTD 105, 1.9 TD 100 S, 1.9 TD 75 S	03/96-10/01	182 A7.000, 182 A8.000, 182 B4.000, 182 B9.000	1910			0-N1415	VB [DG]	
1.9 TD 100 S	03/96-10/01	182 A7.000	1910			0-N1407	VB [BT]	S
1.9 TD 75 S	03/96-10/01	182 A8.000	1910	☼ (ENGINE); → 1865932		0-N1407	VB [BT]	S

BRAVO I (182)

1.2 16V 80	12/98-10/00	182 B2.000	1242	22x124		SK-1412	BTK	
1.2 16V 80	12/98-10/00	182 B2.000	1242	22x124; → 04/1999		SK-1412AQ1	BTKW	
1.2 16V 80	12/98-10/00	182 B2.000	1242	22x124; 04/1999 →		SK-1412AQ2	BTKW	
1.2 16V 80	10/00-10/01	188 A5.000	1242	22x124; Baumuster: 182		SK-1412	BTK	

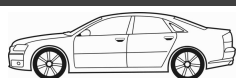

CM³



Art. Nr.



ohne Halter

BRAVO I (182)

1.2 16V 80	10/00-10/01	188 A5.000	1242	22x124	SK-1412AQ2	BTKW
1.4	10/95-10/01	182 A3.000, 182 A5.000	1370	18x134	SK-1345	BTK
1.6	09/00-10/01	182 B6.000	1596	25x158	SK-1076	BTK
1.6 16V	10/95-10/01	182 A4.000, 182 A6.000	1581	25x158	SK-1076	BTK
1.8 GT	10/95-10/01	182 A2.000	1747	24x168	SK-1410	BTK
1.8 GT	10/95-10/01	182 A2.000	1747	24x168	SK-1410AQ1	BTKW
1.9 D	10/95-10/01	160 A7.000	1929	22x173	SK-1033	BTK
1.9 JTD, 1.9 JTD 105	12/98-10/01	182 B4.000, 182 B9.000	1910	24x190; mit Zubehör	SK-1629	BTK
1.9 JTD, 1.9 JTD 105	12/98-10/01	182 B4.000, 182 B9.000	1910	24x190; mit Zubehör	SK-1629AQ1	BTKW
1.9 JTD, 1.9 TD 100 S	03/96-10/01	182 A7.000	1910	24x193; mit Zubehör	SK-1646	BTK
1.9 JTD, 1.9 TD 100 S	03/96-10/01	182 A7.000	1910	24x193	SK-1646AQ1	BTKW
1.9 TD 100 S	03/96-10/01	182 A7.000	1910	24x190; 09/1996 →; mit Zubehör	SK-1629	BTK
1.9 TD 100 S	03/96-10/01	182 A7.000	1910	24x190; 09/1996 →; mit Zubehör	SK-1629AQ1	BTKW
1.9 TD 75 S	03/96-10/01	182 A8.000	1910	24x193; mit Zubehör	SK-1646	BTK
1.9 TD 75 S	03/96-10/01	182 A8.000	1910	24x193	SK-1646AQ1	BTKW
2.0 HGT 20V	10/95-10/01	182 A1.000, 182 B7.000	1998	24x167	SK-1411	BTK
1.2 16V 80	12/98-10/01	182 B2.000, 188 A5.000	1242		0-N195	TB [TE]
1.4	10/95-10/01	182 A3.000, 182 A5.000	1370		0-N113	TB [TE]
1.6 16V	10/95-10/01	182 A4.000, 182 A6.000	1581		0-N208	TB [TE]
1.6 16V	10/95-10/01	182 A4.000, 182 A6.000	1581		0-N951	TB [DG]
1.8 GT	10/95-10/01	182 A2.000	1747		0-N194	TB [TE]
1.8 GT	10/95-10/01	182 A2.000	1747		0-N938	TB [DG]
1.9 D	10/95-10/01	160 A7.000	1929		0-N835	TB [TE]
1.9 JTD, 1.9 JTD 105, 1.9 TD 100 S, 1.9 TD 75 S	03/96-10/01	182 A7.000, 182 A8.000, 182 B4.000, 182 B9.000	1910		0-N115	TB [TE]
1.9 JTD, 1.9 JTD 105, 1.9 TD 100 S, 1.9 TD 75 S	03/96-10/01	182 A7.000, 182 A8.000, 182 B4.000, 182 B9.000	1910		0-N1326	TB [DG]
2.0 HGT 20V	10/95-10/01	182 A1.000, 182 B7.000	1998		0-N196	TB [TE]
2.0 HGT 20V	10/95-10/01	182 A1.000, 182 B7.000	1998		0-N950	TB [DG]
1.2 16V 80	12/98-10/01	182 B2.000, 188 A5.000	1242	✳	0-N1398	VB [DG]
1.2 16V 80	12/98-10/01	182 B2.000, 188 A5.000	1242	✳	0-N1481	VB [BT] S
1.4	10/95-10/01	182 A3.000, 182 A5.000	1370		0-N1403	VB [DG]
1.4	10/95-10/01	182 A3.000, 182 A5.000	1370		0-N1407	VB [BT] S
1.6 16V	10/95-10/01	182 A4.000, 182 A6.000	1581	03/2000 →	0-N1450	VB [DG]
1.6 16V	10/95-10/01	182 A4.000, 182 A6.000	1581	→ 02/2000	0-N187	VB [DG]
1.8 GT	10/95-10/01	182 A2.000	1747		0-N1403	VB [DG]
1.8 GT	10/95-10/01	182 A2.000	1747		0-N1407	VB [BT] S
1.9 D	10/95-10/01	160 A7.000	1929		0-N1672	VB [DG]
1.9 JTD, 1.9 JTD 105	12/98-10/01	182 B4.000, 182 B9.000	1910		0-N1487	VB [BT] S
1.9 JTD, 1.9 JTD 105, 1.9 TD 100 S, 1.9 TD 75 S	03/96-10/01	182 A7.000, 182 A8.000, 182 B4.000, 182 B9.000	1910		0-N1415	VB [DG]
1.9 TD 100 S	03/96-10/01	182 A7.000	1910		0-N1407	VB [BT] S
1.9 TD 75 S	03/96-10/01	182 A8.000	1910	EMM: →1865932	0-N1407	VB [BT] S
2.0 HGT 20V	10/95-07/98	182 A1.000	1998	EMM: →1140488	0-N1596	VB [DG]
2.0 HGT 20V	10/95-10/01	182 A1.000, 182 B7.000	1998		0-N1599	VB [BT] S
2.0 HGT 20V	10/95-07/98	182 A1.000	1998	EMM: →1140487	0-N1630	VB [DG]
2.0 HGT 20V	10/95-10/01	182 A1.000, 182 B7.000	1998		0-N1916	VB [BT]
2.0 HGT 20V	10/95-10/01	182 A1.000, 182 B7.000	1998		0-N1966	VB [DG]
2.0 HGT 20V	07/98-10/01	182 B7.000	1998		0-N1596	VB [DG]

BRAVO II (198)

1.4 16V	03/08-	198 A7.000	1368	22x124; 05/2010 →; Baumuster: 198	SK-1412	BTK
1.4 16V	03/08-	198 A7.000	1368	22x124; 05/2010 →	SK-1412AQ2	BTKW
1.4, 1.4 LPG, 1.4 T-Jet	04/07-	192 B2.000, 198 A1.000, 198 A4.000	1368	22x124; Baumuster: 198	SK-1412	BTK
1.4, 1.4 LPG, 1.4 T-Jet	04/07-	192 B2.000, 198 A1.000, 198 A4.000	1368	22x124	SK-1412AQ2	BTKW
1.6 D Multijet	09/07-	198 A2.000, 198 A3.000, 844 A3.000, 198 A6.000	1598	24x194	SK-1693	BTK
1.6 D Multijet	09/07-	198 A2.000, 198 A3.000, 844 A3.000, 198 A6.000	1598	24x194	SK-1693AQ1	BTKW
1.9 D Multijet	11/06-	192 A1.000, 192 B4.000	1910	24x190; 04/2007 →; mit Zubehör	SK-1629	BTK
1.9 D Multijet	11/06-	192 A1.000, 192 B4.000	1910	24x190; 04/2007 →; mit Zubehör	SK-1629AQ1	BTKW
1.9 D Multijet	04/07-	937 A5.000	1910	24x199; Baumuster: 198	SK-1586	BTK
1.9 D Multijet	04/07-	937 A5.000	1910	24x199	SK-1586AQ1	BTKW
1.9 D Multijet	04/07-12/08	192 A8.000, 192 B5.000	1910	24x190; mit Zubehör	SK-1629	BTK
1.9 D Multijet	04/07-12/08	192 A8.000, 192 B5.000	1910	24x190; mit Zubehör	SK-1629AQ1	BTKW
2.0 D Multijet	09/08-	198 A5.000, 198 A8.000, 844 A2.000	1956	24x199	SK-1586	BTK
2.0 D Multijet	09/08-	198 A5.000, 198 A8.000, 844 A2.000	1956	24x199	SK-1586AQ1	BTKW

CM³

Art. Nr.

**BRAVO II (198)**

1.4, 1.4 16V, 1.4 LPG, 1.4 T-Jet	04/07-	192 B2.000, 198 A1.000, 198 A4.000, 198 A7.000	1368			0-N195	TB [TE]	
1.6 D Multijet	09/07-	198 A2.000, 198 A3.000, 844 A3.000, 198 A6.000	1598			0-N115	TB [TE]	
1.6 D Multijet	09/07-	198 A2.000, 198 A3.000, 844 A3.000, 198 A6.000, 955 A4.000	1598			0-N2149	TB [DG]	
1.9 D Multijet	11/06-12/08	192 A1.000, 192 B4.000, 192 A8.000, 192 B5.000, 937 A5.000	1910			0-N115	TB [TE]	
1.9 D Multijet	11/06-12/08	192 A1.000, 192 B4.000, 192 B5.000, 937 A5.000	1910			0-N2149	TB [DG]	
1.9 D Multijet	04/07-	192 A8.000	1910			0-N1326	TB [DG]	
2.0 D Multijet	09/08-	198 A5.000	1956			0-N115	TB [TE]	
2.0 D Multijet	09/08-	198 A5.000, 198 A8.000, 844 A2.000	1956			0-N2149	TB [DG]	
1.4, 1.4 16V, 1.4 LPG, 1.4 T-Jet	04/07-	192 B2.000, 198 A1.000, 198 A4.000, 198 A7.000	1368			0-N1517	VB [BT]	S
1.6 D Multijet	09/07-	198 A2.000, 198 A3.000, 844 A3.000, 198 A6.000	1598	→ 12/2009		0-N1503	VB [BT]	S
1.6 D Multijet	09/07-	198 A2.000, 198 A3.000, 844 A3.000, 198 A6.000, 955 A4.000	1598	→ 12/2009; *		0-N1522	VB [DG]	
1.6 D Multijet	09/07-	198 A2.000, 198 A3.000, 844 A3.000, 198 A6.000	1598	12/2009 →		0-N2030	VB [BT]	S
1.6 D Multijet	09/07-	198 A2.000, 198 A3.000, 844 A3.000, 198 A6.000, 955 A4.000	1598	→ 12/2009; Rippenanzahl: 6		0-N2122	VB [DG]	
1.9 D Multijet	11/06-12/08	192 A1.000, 192 B4.000, 192 A8.000, 192 B5.000	1910			0-N1408	VB [DG]	
1.9 D Multijet	11/06-12/08	192 A1.000, 192 B4.000, 192 A8.000, 192 B5.000, 937 A5.000	1910			0-N1415	VB [DG]	
1.9 D Multijet	11/06-12/08	192 A1.000, 192 B4.000, 192 A8.000, 192 B5.000	1910	*		0-N1487	VB [BT]	S
1.9 D Multijet	04/07-	937 A5.000	1910			0-N1394	VB [DG]	
1.9 D Multijet	04/07-	937 A5.000	1910			0-N1503	VB [BT]	S
2.0 D Multijet	09/08-	198 A5.000	1956	→ 12/2009		0-N1503	VB [BT]	S
2.0 D Multijet	09/08-	198 A5.000, 198 A8.000, 844 A2.000	1956	→ 12/2009; *		0-N1522	VB [DG]	
2.0 D Multijet	09/08-	198 A5.000	1956	12/2009 →		0-N2030	VB [BT]	S
2.0 D Multijet	09/08-	198 A5.000, 198 A8.000, 844 A2.000	1956	→ 12/2009; Rippenanzahl: 6		0-N2122	VB [DG]	

BRAVO Van (198)

1.6 Multijet	03/08-	198 A3.000	1598	24x194		SK-1693	BTK	
1.6 Multijet	03/08-	198 A3.000	1598	24x194		SK-1693AQ1	BTKW	
1.6 Multijet	03/08-	198 A3.000	1598			0-N2149	TB [DG]	

CAMPAGNOLA

2.4 D	06/74-10/89	8144.61.200	2445	30x152; 05/1979 →		SK-1657	BTK	
-------	-------------	-------------	------	-------------------	--	---------	-----	--

CINQUECENTO (170)

1.1 Sporting	10/94-01/98	176 B2.000	1108	15x125; :9042884 →		SK-1421	BTK	
1.1 Sporting	10/94-01/98	176 B2.000	1108	15x125; :9042884 →		SK-1421AQ1	BTKW	
1.1 Sporting	10/94-01/98	176 B2.000	1108	15x104; :→9042883		SK-1665	BTK	
1.1 Sporting	10/94-01/98	176 B2.000	1108	15x104; :→9042883		SK-1665AQ1	BTKW	
1.1 Sporting	10/94-01/98	176 B2.000	1108			0-N822	TB [TE]	

COUPE (FA/175)

1.8 16V	03/96-08/00	183 A1.000	1747	24x168; → 05/1998; :→1070426		SK-1361	BTK	
1.8 16V	03/96-08/00	183 A1.000	1747	24x168; → 05/1998; :→1070426		SK-1361AQ1	BTKW	
1.8 16V	03/96-08/00	183 A1.000	1747	24x168; 05/1998 →; :1070427 →		SK-1410	BTK	
1.8 16V	03/96-08/00	183 A1.000	1747	24x168; 05/1998 →; :1070427 →		SK-1410AQ1	BTKW	
2.0 16V, 2.0 16V Turbo	11/93-08/96	175 A1.000, 836 A3.000	1995	18x173		SK-1050	BTK	
2.0 20V, 2.0 20V Turbo	08/96-08/00	175 A3.000, 182 A1.000, 182 B3.000	1998	24x167		SK-1411	BTK	
1.8 16V	03/96-08/00	183 A1.000	1747	→ 05/1998		0-N114	TB [TE]	
1.8 16V	03/96-08/00	183 A1.000	1747	06/1998 →		0-N194	TB [TE]	
1.8 16V	03/96-08/00	183 A1.000	1747			0-N938	TB [DG]	
2.0 16V, 2.0 16V Turbo	11/93-08/96	175 A1.000, 836 A3.000	1995			0-N818	TB [TE]	
2.0 20V, 2.0 20V Turbo	08/96-08/00	175 A3.000, 182 A1.000, 182 B3.000	1998			0-N196	TB [TE]	
2.0 20V, 2.0 20V Turbo	08/96-08/00	175 A3.000, 182 A1.000, 182 B3.000	1998			0-N950	TB [DG]	
1.8 16V	03/96-08/00	183 A1.000	1747			0-N1403	VB [DG]	
1.8 16V	03/96-08/00	183 A1.000	1747			0-N1407	VB [BT]	S
2.0 20V	08/96-08/00	182 A1.000, 182 B3.000	1998	:1140488 →		0-N1596	VB [DG]	
2.0 20V	08/96-08/00	182 A1.000, 182 B3.000	1998	:→1104487		0-N1630	VB [DG]	
2.0 20V Turbo	08/96-08/00	175 A3.000	1998	:1444576 →		0-N1596	VB [DG]	
2.0 20V Turbo	08/96-08/00	175 A3.000	1998	:→1444575		0-N1630	VB [DG]	
2.0 20V, 2.0 20V Turbo	08/96-08/00	175 A3.000, 182 A1.000, 182 B3.000	1998			0-N1599	VB [BT]	S



CM³



Art. Nr.



COUPE (FA/175)

2.0 20V, 2.0 20V Turbo	08/96-08/00	175 A3.000, 182 A1.000, 182 B3.000	1998		0-N1916	VB [BT]
2.0 20V, 2.0 20V Turbo	08/96-08/00	175 A3.000, 182 A1.000, 182 B3.000	1998		0-N1966	VB [DG]

CROMA (154)

1900 Turbo D i.d.	05/89-12/96	154 C6.000, 154 D1.000	1929	25x170	SK-1142	BTK
2000 16V	08/92-08/96	154 E1.000	1995	18x173	SK-1050	BTK
2000 CHT	12/85-02/89	154 A1.000	1995	18x142; 08/1986 →	SK-1155	BTK
2000 CHT	01/91-09/92	154 A1.000, 154 C5.000	1995	18x142	SK-1155	BTK
2500 TD	05/89-08/96	8144.97, 8144.97 Y, 8144.97.2400	2500	19x95	SK-1154	BTK
1600	12/85-12/90	154 A.048	1585		0-N818	TB [TE]
1900 Turbo D i.d.	05/89-12/96	154 C6.000, 154 D1.000	1929		0-N826	TB [TE]
2000 16V	08/92-08/96	154 E1.000	1995		0-N818	TB [TE]
2000 CHT, 2000 i.e., 2000 i.e. Turbo	12/85-09/92	154 A1.000, 154 A1.000, 154 C5.000, 154 A2.000, 154 C3.000, 834 B.000, 834 B.048, 834 C.146	1995		0-N823	TB [TE]
2000 i.e., 2000 i.e. Turbo	06/87-08/96	154 C3.046, 834 B.146, 154 C4.046, 834 C.146	1995	→ 12/1991	0-N823	TB [TE]
2000 i.e., 2000 i.e. Turbo	06/87-08/96	154 C3.046, 834 B.146, 154 C4.046, 834 C.146	1995	01/1992 →	0-N832	TB [TE]
2500 D	12/85-12/89	8144.67	2499		0-N1617	TB [BT]
2500 D	12/85-12/89	8144.67	2499		0-N816	TB [DG]
2500 D	12/85-12/89	8144.67	2499		0-N821	TB [DG]
2500 TD	12/85-08/89	8144.91.2000	2445		0-N949	TB [TE]
2500 TD	05/89-08/96	8144.97, 8144.97 Y, 8144.97.2400	2500		0-N949	TB [TE]
1900 Turbo D i.d.	05/89-12/96	154 C6.000, 154 D1.000	1929	:→953135;	0-N1629	VB [DG]
1900 Turbo D i.d.	05/89-12/96	154 C6.000, 154 D1.000	1929	:953136→	0-N187	VB [DG]

CROMA (194)

1.8 16V	12/05-	939 A4.000	1796	24x146	SK-1607	BTK
1.9 D Multijet	06/05-	939 A2.000, 939 A8.000	1910	24x199	SK-1586	BTK
1.9 D Multijet	06/05-	939 A2.000, 939 A8.000	1910	24x199	SK-1586AQ1	BTKW
1.9 D Multijet	06/05-	939 A1.000, 939 A7.000	1910	24x190	SK-1696	BTK
1.9 D Multijet	06/05-	939 A1.000, 939 A7.000	1910	24x190	SK-1696AQ1	BTKW
2.4 D Multijet	06/05-	939 A3.000	2387	24x199	SK-1587	BTK
2.4 D Multijet	06/05-	939 A3.000	2387	24x199	SK-1587AQ1	BTKW
1.8 16V	12/05-	939 A4.000	1796		0-N1347	TB [TE]
1.8 16V	12/05-	939 A4.000	1796		0-N1348	TB [DG]
1.9 D Multijet	06/05-	939 A1.000, 939 A2.000, 939 A7.000, 939 A8.000	1910		0-N115	TB [TE]
1.9 D Multijet	06/05-	939 A1.000, 939 A2.000, 939 A7.000, 939 A8.000	1910		0-N2149	TB [DG]
2.4 D Multijet	06/05-	939 A3.000	2387		0-N115	TB [TE]
2.4 D Multijet	06/05-	939 A3.000	2387		0-N950	TB [DG]
1.8 16V	12/05-	939 A4.000	1796		0-N1799	VB [BT] S
1.9 D Multijet	06/05-	939 A1.000, 939 A2.000, 939 A7.000	1910	→ 12/2009	0-N1503	VB [BT] S
1.9 D Multijet	06/05-	939 A1.000, 939 A2.000, 939 A7.000, 939 A8.000	1910	→ 12/2009	0-N1522	VB [DG]
1.9 D Multijet	06/05-	939 A1.000, 939 A2.000, 939 A7.000, 939 A8.000	1910	Rippenanzahl: 6	0-N1667	VB [DG]
1.9 D Multijet	06/05-	939 A1.000, 939 A2.000, 939 A7.000	1910	12/2009 →	0-N2030	VB [BT] S
2.2 16V	06/05-	194 A1.000	2198		0-N1588	VB [BT] S
2.4 D Multijet	06/05-	939 A3.000	2387		0-N1522	VB [DG]
2.4 D Multijet	06/05-	939 A3.000	2387		0-N1805	VB [BT] S

DOBLO Großraumlimousine (223, 119)

1.2	03/01-	223 A5.000	1242	15x129; → 01/2004; Baumuster: 223AXA1A	SK-1418	BTK
1.2	03/01-	223 A5.000	1242	15x129; → 01/2004	SK-1418AQ1	BTKW
1.2	03/01-	223 A5.000	1242	22x129; 02/2004 →	SK-1677	BTK
1.2	03/01-	223 A5.000	1242	22x129	SK-1677AQ1	BTKW
1.4	10/05-	350 A1.000	1368	22x129	SK-1677	BTK
1.4	10/05-	350 A1.000	1368	22x129; → 06/2008	SK-1677AQ1	BTKW
1.6 16V, 1.6 Natural Power	10/01-	182 B6.000	1596	25x158	SK-1076	BTK
1.9 D	03/01-	223 A6.000	1910	24x193; mit Zubehör	SK-1646	BTK
1.9 D	03/01-	223 A6.000	1910	24x193	SK-1646AQ1	BTKW
1.9 D Multijet, 1.9 JTD	10/01-	182 B9.000, 223 B2.000, 186 A9.000, 223 A7.000, 223 B1.000	1910	24x190; mit Zubehör	SK-1629	BTK
1.9 D Multijet, 1.9 JTD	10/01-	182 B9.000, 223 B2.000, 186 A9.000, 223 A7.000, 223 B1.000	1910	24x190; mit Zubehör	SK-1629AQ1	BTKW
1.9 JTD	10/01-	182 B9.000, 223 B2.000	1910	24x190; → 05/2003	SK-1112	BTK
1.2	03/01-	223 A5.000	1242	:2533529→	0-N1616	TB [TE]



CM³



Art. Nr.



DOBLO Großraumlimousine (223, 119)							
1.2	03/01-	223 A5.000	1242	:→2533528	0-N822	TB [TE]	
1.4	10/05-	350 A1.000	1368		0-N1616	TB [TE]	
1.6 16V , 1.6 Natural Power	10/01-	182 B6.000	1596		0-N208	TB [TE]	
1.6 16V , 1.6 Natural Power	10/01-	182 B6.000	1596		0-N951	TB [DG]	
1.9 D , 1.9 D Multijet, 1.9 JTD	03/01-	182 B9.000, 223 B2.000, 186 A9.000, 223 A6.000, 223 A7.000, 223 B1.000	1910		0-N115	TB [TE]	
1.9 D , 1.9 JTD	03/01-	182 B9.000, 223 B2.000, 223 A6.000	1910		0-N1326	TB [DG]	
1.9 D Multijet	10/05-	186 A9.000	1910		0-N2149	TB [DG]	
1.9 JTD	07/03-	223 A7.000, 223 B1.000	1910	→ 04/2004	0-N1326	TB [DG]	
1.9 JTD	07/03-	223 A7.000, 223 B1.000	1910	04/2004 →	0-N2149	TB [DG]	
1.3 D Multijet	10/05-	223 A9.000	1248		0-N1478S	VB [TE]	
1.4	10/05-	350 A1.000	1368		0-N1517	VB [BT]	S
1.6 16V , 1.6 Natural Power	10/01-	182 B6.000	1596		0-N1450	VB [DG]	
1.9 D , 1.9 D Multijet, 1.9 JTD	03/01-	182 B9.000, 223 B2.000, 186 A9.000, 223 A6.000, 223 A7.000, 223 B1.000	1910		0-N1415	VB [DG]	
1.9 D , 1.9 D Multijet, 1.9 JTD	03/01-	182 B9.000, 223 B2.000, 186 A9.000, 223 A6.000, 223 A7.000, 223 B1.000	1910		0-N1487	VB [BT]	S

DOBLO Cargo (223)							
1.2	03/01-	223 A5.000	1242	15x129; Baumuster: 223ZXA1A	SK-1418	BTK	
1.2	03/01-	223 A5.000	1242	15x129	SK-1418AQ1	BTKW	
1.2	03/01-	223 A5.000	1242	22x129; :2533529→	SK-1677AQ1	BTKW	
1.4	10/05-	350 A1.000	1368	22x129	SK-1677	BTK	
1.4	10/05-	350 A1.000	1368	22x129; → 06/2008	SK-1677AQ1	BTKW	
1.6 16V , 1.6 Natural Power	10/01-	182 B6.000	1596	25x158	SK-1076	BTK	
1.9 D	03/01-	223 A6.000	1910	24x193; mit Zubehör	SK-1646	BTK	
1.9 D	03/01-	223 A6.000	1910	24x193	SK-1646AQ1	BTKW	
1.9 JTD , 1.9 JTD Multijet	10/01-	182 B9.000, 186 A9.000, 223 A7.000, 223 B1.000	1910	24x190; mit Zubehör	SK-1629	BTK	
1.9 JTD , 1.9 JTD Multijet	10/01-	182 B9.000, 186 A9.000, 223 A7.000, 223 B1.000	1910	24x190; mit Zubehör	SK-1629AQ1	BTKW	
1.2	03/01-	223 A5.000	1242	:2533529→	0-N1616	TB [TE]	
1.2	03/01-	223 A5.000	1242	:→2533528	0-N822	TB [TE]	
1.4	10/05-	350 A1.000	1368		0-N1616	TB [TE]	
1.6 16V , 1.6 Natural Power	10/01-	182 B6.000	1596		0-N208	TB [TE]	
1.6 16V , 1.6 Natural Power	10/01-	182 B6.000	1596		0-N951	TB [DG]	
1.9 D , 1.9 JTD	03/01-	182 B9.000, 223 A6.000	1910		0-N1326	TB [DG]	
1.9 D , 1.9 JTD , 1.9 JTD Multijet	03/01-	182 B9.000, 186 A9.000, 223 A6.000, 223 A7.000, 223 B1.000	1910		0-N115	TB [TE]	
1.9 JTD	07/03-	223 A7.000, 223 B1.000	1910	→ 04/2004	0-N1326	TB [DG]	
1.9 JTD	07/03-	223 A7.000, 223 B1.000	1910	04/2004 →	0-N2149	TB [DG]	
1.9 JTD Multijet	12/06-	186 A9.000	1910		0-N2149	TB [DG]	
1.3 D Multijet, 1.3 JTD 16V	05/04-01/10	188 A8.000, 188 A9.000, 199 A2.000	1248		0-N1478S	VB [TE]	
1.4	10/05-	350 A1.000	1368		0-N1517	VB [BT]	S
1.6 16V , 1.6 Natural Power	10/01-	182 B6.000	1596		0-N1450	VB [DG]	
1.9 D , 1.9 JTD , 1.9 JTD Multijet	03/01-	182 B9.000, 186 A9.000, 223 A6.000, 223 A7.000, 223 B1.000	1910		0-N1487	VB [BT]	S
1.9 D , 1.9 JTD, 1.9 JTD Multijet	03/01-	182 B9.000, 186 A9.000, 223 A6.000, 223 A7.000, 223 B1.000	1910		0-N1415	VB [DG]	

DOBLO Kombi (152, 263_)							
1.4	10/11-	198 A4.000	1368	22x124	SK-1412	BTK	
1.4, 1.4 Natural Power	02/10-	198 A4.000, 843 A1.000	1368	22x124; Baumuster: 263	SK-1412	BTK	
1.4, 1.4 Natural Power	02/10-	198 A4.000, 843 A1.000	1368	22x124	SK-1412AQ2	BTKW	
1.6 D Multijet	02/10-	198 A3.000, 263 A4.000	1598	24x194	SK-1693	BTK	
1.6 D Multijet	02/10-	198 A3.000, 263 A4.000, 940 C1.000	1598	24x194	SK-1693AQ1	BTKW	
2.0 D Multijet	02/10-	263 A1.000	1956	24x199	SK-1586	BTK	
2.0 D Multijet	02/10-	263 A1.000	1956	24x199	SK-1586AQ1	BTKW	
1.4, 1.4 Natural Power	02/10-	198 A4.000, 843 A1.000	1368		0-N195	TB [TE]	
1.6 D Multijet	02/10-	198 A3.000, 263 A4.000	1598		0-N115	TB [TE]	
1.6 D Multijet	02/10-	198 A3.000, 263 A4.000	1598		0-N2149	TB [DG]	
2.0 D Multijet	02/10-	263 A1.000	1956		0-N115	TB [TE]	
2.0 D Multijet	02/10-	263 A1.000	1956		0-N2149	TB [DG]	
1.3 D Multijet	02/10-	199 A3.000, 263 A2.000	1248		0-N2390	VB [BT]	S
1.4, 1.4 Natural Power	02/10-	198 A4.000, 843 A1.000	1368		0-N1517	VB [BT]	S
1.6 D Multijet	02/10-	198 A3.000, 263 A4.000	1598		0-N1503	VB [BT]	S
1.6 D Multijet	02/10-	198 A3.000, 263 A4.000	1598		0-N1522	VB [DG]	
1.6 D Multijet	02/10-	198 A3.000, 263 A4.000	1598		0-N2049	VB [DG]	
2.0 D Multijet	02/10-	263 A1.000	1956		0-N1503	VB [BT]	S



CM³



Art. Nr.



ohne Halter

DOBLO Kombi (152, 263_)							
2.0 D Multijet	02/10-	263 A1.000	1956	✳		0-N1522	VB [DG]
2.0 D Multijet	02/10-	263 A1.000	1956			0-N2049	VB [DG]
DOBLO Kasten/Kombi (263)							
1.4	10/11-	198 A4.000	1368	22x124		SK-1412	BTK
1.4	10/11-	198 A4.000	1368	22x124; 03/2012 →		SK-1412AQ2	BTKW
1.4, 1.4 Natural Power	02/10-	198 A4.000, 843 A1.000	1368	22x124; Baumuster: 263		SK-1412	BTK
1.4, 1.4 Natural Power	02/10-	198 A4.000, 843 A1.000	1368	22x124		SK-1412AQ2	BTKW
1.6 D Multijet	02/10-	198 A3.000, 263 A3.000, 263 A4.000	1598	24x194		SK-1693	BTK
1.6 D Multijet	02/10-	198 A3.000, 263 A3.000, 263 A4.000	1598	24x194		SK-1693AQ1	BTKW
2.0 D Multijet	02/10-	263 A1.000	1956	24x199		SK-1586	BTK
2.0 D Multijet	02/10-	263 A1.000	1956	24x199		SK-1586AQ1	BTKW
1.4, 1.4 Natural Power	02/10-	198 A4.000, 843 A1.000	1368			0-N195	TB [TE]
1.6 D Multijet	02/10-	198 A3.000, 263 A3.000, 263 A4.000	1598			0-N115	TB [TE]
1.6 D Multijet	02/10-	198 A3.000, 263 A3.000, 263 A4.000	1598			0-N2149	TB [DG]
2.0 D Multijet	02/10-	263 A1.000	1956			0-N115	TB [TE]
2.0 D Multijet	02/10-	263 A1.000	1956			0-N2149	TB [DG]
1.3 D Multijet	02/10-	199 A3.000, 263 A2.000, 263 A6.000	1248			0-N2390	VB [BT] S
1.4, 1.4 Natural Power	02/10-	198 A4.000, 843 A1.000	1368			0-N1517	VB [BT] S
1.6 D Multijet	02/10-	198 A3.000, 263 A3.000	1598			0-N1503	VB [BT] S
1.6 D Multijet	02/10-	198 A3.000, 263 A3.000, 263 A4.000	1598	✳		0-N1522	VB [DG]
1.6 D Multijet	02/10-	198 A3.000, 263 A3.000	1598			0-N2049	VB [DG]
2.0 D Multijet	02/10-	263 A1.000	1956			0-N1503	VB [BT] S
2.0 D Multijet	02/10-	263 A1.000	1956	✳		0-N1522	VB [DG]
2.0 D Multijet	02/10-	263 A1.000	1956			0-N2049	VB [DG]
DOBLO Pritsche/Fahrgestell (263)							
1.4	04/10-	843 A1.000	1368	22x124; Baumuster: 263		SK-1412	BTK
1.4	04/10-	843 A1.000	1368	22x124		SK-1412AQ2	BTKW
1.6 D Multijet	02/10-	198 A3.000, 263 A3.000, 263 A4.000, 263 A5.000	1598	24x194		SK-1693	BTK
1.6 D Multijet	02/10-	263 A3.000, 263 A4.000, 263 A5.000	1598	24x194		SK-1693AQ1	BTKW
1.6 D Multijet	02/10-	198 A3.000	1598	24x194; Baumuster: Doblo Cargo		SK-1693AQ1	BTKW
1.6 D Multijet	02/10-	198 A3.000	1598	24x194; Baumuster: Pratico		SK-1693AQ1	BTKW
2.0 D Multijet	02/10-	263 A1.000	1956	24x199		SK-1586	BTK
2.0 D Multijet	02/10-	263 A1.000	1956	24x199; Baumuster: Doblo Cargo		SK-1586AQ1	BTKW
2.0 D Multijet	02/10-	263 A1.000	1956	24x199; Baumuster: Pratico		SK-1586AQ1	BTKW
1.4	04/10-	843 A1.000	1368			0-N195	TB [TE]
1.6 D Multijet	02/10-	198 A3.000	1598			0-N115	TB [TE]
1.6 D Multijet	02/10-	198 A3.000, 263 A3.000, 263 A4.000, 263 A5.000	1598			0-N2149	TB [DG]
2.0 D Multijet	02/10-	263 A1.000	1956			0-N115	TB [TE]
2.0 D Multijet	02/10-	263 A1.000	1956			0-N2149	TB [DG]
1.3 D Multijet	02/10-	199 A3.000, 263 A2.000, 263 A6.000	1248			0-N2390	VB [BT] S
1.4	04/10-	843 A1.000	1368			0-N1517	VB [BT] S
1.6 D Multijet	02/10-	198 A3.000, 263 A3.000, 263 A4.000, 263 A5.000	1598	✳		0-N1522	VB [DG]
2.0 D Multijet	02/10-	263 A1.000	1956	✳		0-N1522	VB [DG]
DUCATO Kasten (280)							
1.9 TD	03/89-08/90	280 A1.000	1929	25x173		SK-1144	BTK
2.4 D	01/82-08/90	8144.61	2428	30x152		SK-1657	BTK
2.4 D 4x4	09/86-05/90	8140.61, 8140.61, 8144.61	2445	30x152		SK-1657	BTK
2.5 D	01/82-08/90	8144.67, CRD93L (U25-661)	2500	32x118		SK-1018S	BTK
2.5 D	09/86-05/90	8140.61	2445	30x152; ohne Spanndämpfer, Spannrolle; Baumuster: Ducato 10		SK-1657	BTK
2.5 D	09/86-05/90	8140.61	2445	30x152; ohne Spanndämpfer, Spannrolle; Baumuster: Ducato 15		SK-1657	BTK
2.5 D, 2.5 D 4x4	01/82-08/90	8144.67, 8144.67, CRD93L (U25-661)	2500	30x152		SK-1657	BTK
1.9 D, 1.9 TD	01/88-08/90	149 B1.000, 280 A1.000	1929			0-N835	TB [TE]
1.9 D, 1.9 TD	01/88-08/90	149 B1.000, 280 A1.000	1929			0-N889	TB [DG]
2.4 D	01/82-08/90	8144.61	2428			0-N1617	TB [BT]
2.4 D	01/82-08/90	8144.61	2428			0-N816	TB [DG]
2.4 D	01/82-08/90	8144.61	2428			0-N821	TB [DG]
2.4 D 4x4	09/86-05/90	8140.61, 8144.61	2445			0-N821	TB [DG]
2.4 D 4x4, 2.5 TD 4x4	09/86-09/90	8140.61, 8144.61, 8144.21	2445			0-N1617	TB [BT]
2.4 D 4x4, 2.5 TD 4x4	09/86-09/90	8140.61, 8144.61, 8144.21	2445			0-N816	TB [DG]
2.5 D	01/82-08/90	CRD93L	2500			0-N815	TB [TE]

CM³

Art. Nr.

**DUCATO Kasten (280)**

2.5 D	01/82-08/90	CRD93L	2500			0-N822	TB [TE]
2.5 D 4x4	03/89-08/90	8144.67	2500			0-N815	TB [TE]
2.5 D 4x4	03/89-08/90	8144.67	2500			0-N822	TB [TE]
2.5 D, 2.5 D 4x4	01/82-08/90	8144.67, 8144.67, CRD93L (U25-661)	2500			0-N1617	TB [BT]
2.5 D, 2.5 D 4x4	01/82-08/90	8144.67, 8144.67, CRD93L (U25-661)	2500			0-N816	TB [DG]
2.5 D, 2.5 D 4x4	01/82-08/90	8144.67, 8144.67, CRD93L (U25-661)	2500			0-N821	TB [DG]
2.5 TD 4x4	09/86-05/90	8140.27	2499			0-N1617	TB [BT]
2.5 TD 4x4	09/86-05/90	8140.27	2499			0-N816	TB [DG]

DUCATO Panorama (280)

1.9 TD	03/89-08/90	280 A1.000	1929	25x173		SK-1144	BTK
2.4 D	07/82-12/85	8144.61	2428	30x152		SK-1657	BTK
2.4 TD, 2.4 TD 4x4	01/86-08/90	8144.21, 8144.21, 8144.21.220	2445	30x153		SK-1045	BTK
2.5 D	01/86-08/90	8144.67, CRD93L (U25-661)	2500	32x118		SK-1018S	BTK
2.5 D, 2.5 D 4x4	01/86-08/90	8144.67, 8144.67, CRD93L (U25-661)	2500	30x152		SK-1657	BTK
1.9 D, 1.9 TD	02/87-08/90	149 B1.000, 280 A1.000	1929			0-N835	TB [TE]
1.9 D, 1.9 TD	02/87-08/90	149 B1.000, 280 A1.000	1929			0-N889	TB [DG]
2.4 D	07/82-12/85	8144.61	2428			0-N1617	TB [BT]
2.4 D	07/82-12/85	8144.61	2428			0-N816	TB [DG]
2.4 D	07/82-12/85	8144.61	2428			0-N821	TB [DG]
2.4 TD, 2.4 TD 4x4	01/86-08/90	8144.21, 8144.21, 8144.21.220	2445			0-N1617	TB [BT]
2.4 TD, 2.4 TD 4x4	01/86-08/90	8144.21, 8144.21, 8144.21.220	2445			0-N816	TB [DG]
2.5 D	01/86-08/90	CRD93L	2500			0-N815	TB [TE]
2.5 D	01/86-08/90	CRD93L	2500			0-N822	TB [TE]
2.5 D 4x4	01/87-08/90	8144.67	2500			0-N815	TB [TE]
2.5 D 4x4	01/87-08/90	8144.67	2500			0-N822	TB [TE]
2.5 D, 2.5 D 4x4	01/86-08/90	8144.67, 8144.67, CRD93L (U25-661)	2500			0-N1617	TB [BT]
2.5 D, 2.5 D 4x4	01/86-08/90	8144.67, 8144.67, CRD93L (U25-661)	2500			0-N816	TB [DG]
2.5 D, 2.5 D 4x4	01/86-08/90	8144.67, 8144.67, CRD93L (U25-661)	2500			0-N821	TB [DG]

DUCATO Pritsche/Fahrgestell (280)

1.9 TD	03/89-08/90	280 A1.000	1929	25x173		SK-1144	BTK
2.4 TD	01/86-08/90	8144.21	2445	30x153		SK-1045	BTK
2.5 D	07/82-08/90	8144.67, CRD93L (U25-661)	2500	32x118		SK-1018S	BTK
2.5 D, 2.5 D 4x4	07/82-08/90	8144.67, 8144.67, CRD93L (U25-661)	2500	30x152		SK-1657	BTK
1.9 D, 1.9 TD	01/88-08/90	149 B1.000, 280 A1.000	1929			0-N835	TB [TE]
1.9 D, 1.9 TD	01/88-08/90	149 B1.000, 280 A1.000	1929			0-N889	TB [DG]
2.4 TD	01/86-08/90	8144.21	2445			0-N1617	TB [BT]
2.4 TD	01/86-08/90	8144.21	2445			0-N816	TB [DG]
2.5 D	07/82-08/90	CRD93L	2500			0-N815	TB [TE]
2.5 D	07/82-08/90	CRD93L	2500			0-N822	TB [TE]
2.5 D 4x4	03/89-08/90	8144.67	2500			0-N815	TB [TE]
2.5 D 4x4	03/89-08/90	8144.67	2500			0-N822	TB [TE]
2.5 D, 2.5 D 4x4	07/82-08/90	8144.67, 8144.67, CRD93L (U25-661)	2500			0-N1617	TB [BT]
2.5 D, 2.5 D 4x4	07/82-08/90	8144.67, 8144.67, CRD93L (U25-661)	2500			0-N816	TB [DG]
2.5 D, 2.5 D 4x4	07/82-08/90	8144.67, 8144.67, CRD93L (U25-661)	2500			0-N821	TB [DG]

DUCATO Kasten (290)

1.9 D, 1.9 TD	03/89-03/94	149 B1.000, 280 A1.000	1929	25x170		SK-1143	BTK
1.9 TD	03/89-03/94	280 A1.000	1929	25x173; 06/1990 →		SK-1144	BTK
2.5 D	06/90-05/94	8144.67	2499	30x152		SK-1035	BTK
2.5 D	06/90-05/94	8144.67	2499	30x152; mit Spanndämpfer, Spannrolle		SK-1680	BTK
2.5 D 4x4	07/90-03/94	8144.67	2500	30x152		SK-1035	BTK
2.5 D 4x4	07/90-03/94	8144.67	2500	30x152; mit Spanndämpfer, Spannrolle		SK-1680	BTK
2.5 TD, 2.5 TD 4x4	07/90-03/94	8140.27	2500	30x153		SK-1046	BTK
2.5 TD, 2.5 TD 4x4	07/90-03/94	8140.27	2500	mit Spanndämpfer, Spannrolle		SK-1679	BTK
1.9 D, 1.9 TD	03/89-03/94	149 B1.000, 280 A1.000	1929			0-N835	TB [TE]
1.9 D, 1.9 TD	03/89-03/94	149 B1.000, 280 A1.000	1929			0-N889	TB [DG]
2.5 D	06/90-05/94	8144.67	2499			0-N1617	TB [BT]
2.5 D	06/90-05/94	8144.67	2499			0-N816	TB [DG]
2.5 D	06/90-05/94	8144.67	2499			0-N821	TB [DG]
2.5 D 4x4	07/90-03/94	8144.67	2500			0-N821	TB [DG]
2.5 D 4x4, 2.5 TD, 2.5 TD 4x4	07/90-03/94	8140.27, 8144.67	2500			0-N1617	TB [BT]
2.5 D 4x4, 2.5 TD, 2.5 TD 4x4	07/90-03/94	8140.27, 8144.67	2500			0-N816	TB [DG]

DUCATO Panorama (290)

1.9 D, 1.9 TD	07/90-03/94	149 B1.000, 280 A1.000	1929	25x170		SK-1143	BTK
1.9 TD	07/90-03/94	280 A1.000	1929	25x173		SK-1144	BTK

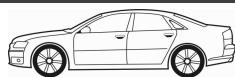

CM³



Art. Nr.



ohne Halter

DUCATO Panorama (290)

2.5 D 4x4	07/90-03/94	8144.67	2500	30x152; mit Spanndämpfer, Spannrolle	SK-1680	BTK
2.5 D, 2.5 D 4x4	07/90-03/94	8144.67	2500	30x152	SK-1035	BTK
2.5 TD 4x4	06/90-05/94	8140.27	2499	30x153	SK-1046	BTK
2.5 TD, 2.5 TD 4x4	08/90-03/94	8140.27	2500	30x153	SK-1046	BTK
2.5 TD, 2.5 TD 4x4	08/90-03/94	8140.27	2500	mit Spanndämpfer, Spannrolle	SK-1679	BTK
1.9 D, 1.9 TD	07/90-03/94	149 B1.000, 280 A1.000	1929		0-N835	TB [TE]
1.9 D, 1.9 TD	07/90-03/94	149 B1.000, 280 A1.000	1929		0-N889	TB [DG]
2.5 D, 2.5 D 4x4	07/90-03/94	8144.67	2500		0-N821	TB [DG]
2.5 D, 2.5 D 4x4, 2.5 TD, 2.5 TD 4x4	07/90-03/94	8140.27, 8144.67	2500		0-N1617	TB [BT]
2.5 D, 2.5 D 4x4, 2.5 TD, 2.5 TD 4x4	07/90-03/94	8140.27, 8144.67	2500		0-N816	TB [DG]
2.5 TD 4x4	06/90-05/94	8140.27	2499		0-N1617	TB [BT]
2.5 TD 4x4	06/90-05/94	8140.27	2499		0-N816	TB [DG]

DUCATO Pritsche/Fahrgestell (290)

1.9 TD	03/89-03/94	280 A1.000	1929	25x170	SK-1143	BTK
1.9 TD	03/89-03/94	280 A1.000	1929	25x173; 06/1990 →	SK-1144	BTK
2.5 D, 2.5 D 4x4	03/89-03/94	8144.67	2500	30x152	SK-1035	BTK
2.5 D, 2.5 D 4x4	03/89-03/94	8144.67	2500	30x152; mit Spanndämpfer, Spannrolle	SK-1680	BTK
2.5 TD, 2.5 TD 4x4	07/90-03/94	8140.27	2500	30x153	SK-1046	BTK
2.5 TD, 2.5 TD 4x4	07/90-03/94	8140.27	2500	mit Spanndämpfer, Spannrolle	SK-1679	BTK
1.9 TD	03/89-03/94	280 A1.000	1929		0-N835	TB [TE]
1.9 TD	03/89-03/94	280 A1.000	1929		0-N889	TB [DG]
2.5 D, 2.5 D 4x4	03/89-03/94	8144.67	2500		0-N821	TB [DG]
2.5 D, 2.5 D 4x4, 2.5 TD, 2.5 TD 4x4	03/89-03/94	8140.27, 8144.67	2500		0-N1617	TB [BT]
2.5 D, 2.5 D 4x4, 2.5 TD, 2.5 TD 4x4	03/89-03/94	8140.27, 8144.67	2500		0-N816	TB [DG]

DUCATO Bus (230)

1.9 D Combinato, 1.9 TD Combinato, 1.9 TD Panorama/Combinato	03/94-04/02	230 A2.000, 230 A3.000, 230 A4.000	1929	25x173	SK-1144	BTK
1.9 D, 1.9 TD	04/98-04/02	D9B, D9B (XUD9A), DJY, DHX (XUD9TF/L)	1905	25.4x136	SK-1022	BTK
1.9 TD	04/98-04/02	DHX (XUD9TF/L)	1905	25.4x136	SK-1022AQ1	BTKW
2.0 JTD	10/01-04/02	RHV (DW10)	1997	25x141; mit Zubehör	SK-1085	BTK
2.0 JTD	10/01-04/02	RHV (DW10)	1997	25.4x141; mit Zubehör	SK-1085AQ1	BTKW
2.0, 2.0 4x4, 2.0 Panorama/Combinato	03/94-04/02	RFW	1998	25.4x114	SK-1079	BTK
2.5 D Combinato	08/94-04/02	8140.67	2500	30x152	SK-1035	BTK
2.5 D Combinato	08/94-04/02	8140.67	2500	30x152; → 04/1998; mit Spanndämpfer, Spannrolle	SK-1680	BTK
2.5 TD, 2.5 TD 4x4	06/94-08/98	8140.47	2499	30x153	SK-1046	BTK
2.5 TD, 2.5 TD 4x4	06/94-08/98	8140.47	2499	mit Spanndämpfer, Spannrolle	SK-1679	BTK
2.5 TDI 4x4, 2.5 TDI Panorama/Combinato	03/94-04/02	8140.47, 8140.47R	2500	30x153	SK-1046	BTK
2.5 TDI 4x4, 2.5 TDI Panorama/Combinato	03/94-04/02	8140.47, 8140.47R	2500	mit Spanndämpfer, Spannrolle	SK-1679	BTK
2.8 D	02/98-04/02	8140.63	2800	30x153	SK-1046	BTK
2.8 D	02/98-04/02	8140.63	2800	05/1998 → 09/2001; mit Spanndämpfer, Spannrolle	SK-1679	BTK
2.8 JTD	11/00-04/02	8140.43S	2798	30x152; mit Spanndämpfer, Spannrolle	SK-1680	BTK
2.8 JTD 4x4	11/00-04/02	8140.43S	2798	30x154	SK-1153	BTK
2.8 JTD 4x4	11/00-04/02	8140.43S	2798	30x152; 02/2001 → 09/2001; mit Spanndämpfer, Spannrolle	SK-1680	BTK
2.8 JTD, 2.8 JTD 4x4	11/00-04/02	8140.43S	2798	30x152	SK-1035	BTK
2.8 TDI	10/97-04/02	8140.43	2800	30x154; 05/1998 →	SK-1153	BTK
2.8 TDI	10/97-04/02	8140.43	2800	mit Spanndämpfer, Spannrolle; Baumuster: Ducato 10	SK-1681	BTK
2.8 TDI	10/97-04/02	8140.43	2800	mit Spanndämpfer, Spannrolle; Baumuster: Ducato 18	SK-1681	BTK
2.8 TDI 4x4	07/99-04/02	8140.43	2800	30x154	SK-1153	BTK
2.8 TDI 4x4	07/99-04/02	8140.43	2800	mit Spanndämpfer, Spannrolle	SK-1681	BTK
1.9 D Combinato, 1.9 TD Combinato, 1.9 TD Panorama/Combinato	03/94-04/02	230 A2.000, 230 A3.000, 230 A4.000	1929		0-N835	TB [TE]
1.9 D Combinato, 1.9 TD Combinato, 1.9 TD Panorama/Combinato	03/94-04/02	230 A2.000, 230 A3.000, 230 A4.000	1929		0-N889	TB [DG]
1.9 D, 1.9 TD	04/98-04/02	D9B, D9B (XUD9A), DJY, DHX (XUD9TF/L)	1905		0-N900	TB [DG]
1.9 D, 1.9 TD	04/98-04/02	D9B, D9B (XUD9A), DJY, DHX (XUD9TF/L)	1905		0-N901	TB [TE]
2.0 4x4, 2.0 Panorama/Combinato	03/94-04/02	RFW	1998		0-N943	TB [TE]
2.0 JTD	10/01-04/02	RHV (DW10)	1997		0-N118P	TB [TE]
2.0 JTD	10/01-04/02	RHV (DW10)	1997		0-N119P	TB [DG]
2.5 D Combinato	08/94-04/02	8140.67	2500		0-N821	TB [DG]
2.5 D Combinato, 2.5 TDI 4x4, 2.5 TDI Panorama/Combinato	03/94-04/02	8140.47, 8140.47R, 8140.67	2500		0-N1617	TB [BT]



CM³



Art. Nr.



ohne Halter

DUCATO Bus (230)

2.5 D Combinato, 2.5 TDI 4x4, 2.5 TDI Panorama/Combinato	03/94-04/02	8140.47, 8140.47R, 8140.67	2500		0-N816	TB [DG]
2.5 TD, 2.5 TD 4x4	06/94-08/98	8140.47	2499		0-N1617	TB [BT]
2.5 TD, 2.5 TD 4x4	06/94-08/98	8140.47	2499		0-N816	TB [DG]
2.8 D, 2.8 TDI, 2.8 TDI 4x4	10/97-04/02	8140.43, 8140.63	2800		0-N1617	TB [BT]
2.8 D, 2.8 TDI, 2.8 TDI 4x4	10/97-04/02	8140.43, 8140.63	2800		0-N816	TB [DG]
2.8 JTD, 2.8 JTD 4x4	11/00-04/02	8140.43S	2798		0-N1617	TB [BT]
2.8 JTD, 2.8 JTD 4x4	11/00-04/02	8140.43S	2798		0-N816	TB [DG]
2.8 JTD, 2.8 JTD 4x4	11/00-04/02	8140.43S	2798		0-N821	TB [DG]
1.9 D, 1.9 TD	04/98-04/02	D9B, D9B (XUD9A), DJY, DHX (XUD9TF/L)	1905		0-N931	VB [TE]
1.9 TD Combinato, 1.9 TD Panorama/Combinato	03/94-04/02	230 A3.000, 230 A4.000	1929	☼	0-N1672	VB [DG]
1.9 TD Combinato, 1.9 TD Panorama/Combinato	03/94-04/02	230 A3.000, 230 A4.000	1929		0-N187	VB [DG]
2.0 4x4, 2.0 Panorama/Combinato	03/94-04/02	RFW	1998		0-N124	VB [TE]
2.0 JTD	10/01-04/02	RHV (DW10)	1997		0-N1421	VB [DG]
2.0 JTD	10/01-04/02	RHV (DW10)	1997	☼	0-N1471	VB [BT]
2.0 JTD	10/01-04/02	RHV (DW10)	1997	☼	0-N1493	VB [BT]
2.0 JTD	10/01-04/02	RHV (DW10)	1997	☼	0-N1748	VB [BT]
2.5 D Combinato, 2.5 TDI 4x4, 2.5 TDI Panorama/Combinato	03/94-04/02	8140.47, 8140.47R, 8140.67	2500	‡; mit Anbaumaterial	0-N1386	VB [TE]
2.5 TD, 2.5 TD 4x4	06/94-08/98	8140.47	2499	‡; mit Anbaumaterial	0-N1386	VB [TE]
2.8 D, 2.8 TDI, 2.8 TDI 4x4	10/97-04/02	8140.43, 8140.63	2800	‡; mit Anbaumaterial	0-N1386	VB [TE]
2.8 JTD, 2.8 JTD 4x4	11/00-04/02	8140.43S	2798	☼ → 3980846; ‡; mit Anbaumaterial	0-N1386	VB [TE]
2.8 JTD, 2.8 JTD 4x4	11/00-04/02	8140.43S	2798		0-N1387	VB [DG]
2.8 JTD, 2.8 JTD 4x4	11/00-04/02	8140.43S	2798	☼ → 3980847 →; mit Anbaumaterial	0-N1711S	VB [TE]

DUCATO Kasten (230L)

1.9 D, 1.9 TD	03/94-04/02	230 A2.000, 230 A3.000	1929	25x173; 11/1994 →	SK-1144	BTK
1.9 D, 1.9 TD	04/98-04/02	DHX, DHX (XUD9TF/L), DJY	1905	25.4x136	SK-1022	BTK
1.9 TD	04/98-04/02	DHX, DHX (XUD9TF/L)	1905	25.4x136	SK-1022AQ1	BTKW
1.9 TD CAT	08/94-04/02	230 A4.000	1929	25x173	SK-1144	BTK
2.0	03/94-04/02	RFW	1998	25.4x114; 06/1994 →	SK-1079	BTK
2.0 4x4	11/94-04/02	RFW	1998	25.4x114	SK-1079	BTK
2.0 JTD	10/01-04/02	RHV (DW10)	1997	25x141; mit Zubehör	SK-1085	BTK
2.0 JTD	10/01-04/02	RHV (DW10)	1997	25.4x141; mit Zubehör	SK-1085AQ1	BTKW
2.5 D	03/94-04/02	8140.67	2500	30x152	SK-1035	BTK
2.5 D	03/94-04/02	8140.67	2500	30x152; 06/1994 → 04/1998; mit Spanndämpfer, Spannrolle	SK-1680	BTK
2.5 TD 4x4	11/94-04/98	8140.47	2499	mit Spanndämpfer, Spannrolle	SK-1679	BTK
2.5 TD, 2.5 TD 4x4	06/94-08/98	8140.47	2499	30x153	SK-1046	BTK
2.5 TDI Maxi	03/94-04/02	8140.47	2500	06/1994 → 08/1998; mit Spanndämpfer, Spannrolle	SK-1679	BTK
2.5 TDI, 2.5 TDI 4x4, 2.5 TDI Maxi	03/94-04/02	8140.47, 8140.47R	2500	30x153	SK-1046	BTK
2.8 D, 2.8 D 4x4	05/98-04/02	8140.63	2800	30x153	SK-1046	BTK
2.8 D, 2.8 D 4x4	05/98-04/02	8140.63	2800	→ 09/2001; mit Spanndämpfer, Spannrolle	SK-1679	BTK
2.8 IDTD 4x4	05/98-09/01	8140.43	2799	mit Spanndämpfer, Spannrolle; Baumuster: Ducato 14	SK-1681	BTK
2.8 IDTD 4x4	05/98-09/01	8140.43	2799	mit Spanndämpfer, Spannrolle; Baumuster: Ducato 18	SK-1681	BTK
2.8 JTD	11/00-04/02	8140.43S	2798	30x154; 03/2001 →	SK-1153	BTK
2.8 JTD, 2.8 JTD 4x4	11/00-04/02	8140.43S	2798	30x152	SK-1035	BTK
2.8 JTD, 2.8 JTD 4x4	11/00-04/02	8140.43S	2798	30x152; mit Spanndämpfer, Spannrolle	SK-1680	BTK
2.8 TDI	10/97-04/02	8140.43	2800	30x154; 05/1998 →	SK-1153	BTK
2.8 TDI	10/97-04/02	8140.43	2800	mit Spanndämpfer, Spannrolle; Baumuster: Ducato 10	SK-1681	BTK
2.8 TDI 4x4	06/99-04/02	8140.43	2800	30x154	SK-1153	BTK
2.8 TDI, 2.8 TDI 4x4	10/97-04/02	8140.43	2800	mit Spanndämpfer, Spannrolle; Baumuster: Ducato 14	SK-1681	BTK
2.8 TDI, 2.8 TDI 4x4	10/97-04/02	8140.43	2800	mit Spanndämpfer, Spannrolle; Baumuster: Ducato 18	SK-1681	BTK
1.9 D, 1.9 TD	04/98-04/02	DHX, DHX (XUD9TF/L), DJY	1905		0-N900	TB [DG]
1.9 D, 1.9 TD	04/98-04/02	DHX, DHX (XUD9TF/L), DJY	1905		0-N901	TB [TE]
1.9 D, 1.9 TD, 1.9 TD CAT	03/94-04/02	230 A2.000, 230 A3.000, 230 A4.000	1929		0-N835	TB [TE]
1.9 D, 1.9 TD, 1.9 TD CAT	03/94-04/02	230 A2.000, 230 A3.000, 230 A4.000	1929		0-N889	TB [DG]
2.0 JTD	10/01-04/02	RHV (DW10)	1997		0-N118P	TB [TE]
2.0 JTD	10/01-04/02	RHV (DW10)	1997		0-N119P	TB [DG]
2.0, 2.0 4x4	03/94-04/02	RFW	1998		0-N943	TB [TE]
2.5 D	03/94-04/02	8140.67	2500		0-N821	TB [DG]



CM³



Art. Nr.



ohne Halter

DUCATO Kasten (230L)

2.5 D, 2.5 TDI, 2.5 TDI 4x4, 2.5 TDI Maxi	03/94-04/02	8140.47, 8140.47R, 8140.67	2500		0-N1617	TB [BT]
2.5 D, 2.5 TDI, 2.5 TDI 4x4, 2.5 TDI Maxi	03/94-04/02	8140.47, 8140.47R, 8140.67	2500		0-N816	TB [DG]
2.5 TD, 2.5 TD 4x4	06/94-08/98	8140.47	2499		0-N1617	TB [BT]
2.5 TD, 2.5 TD 4x4	06/94-08/98	8140.47	2499		0-N816	TB [DG]
2.8 D, 2.8 D 4x4, 2.8 TDI, 2.8 TDI 4x4	10/97-04/02	8140.43, 8140.63	2800		0-N1617	TB [BT]
2.8 D, 2.8 D 4x4, 2.8 TDI, 2.8 TDI 4x4	10/97-04/02	8140.43, 8140.63	2800		0-N816	TB [DG]
2.8 iDTD 4x4	05/98-09/01	8140.43	2799		0-N1617	TB [BT]
2.8 iDTD 4x4	05/98-09/01	8140.43	2799		0-N816	TB [DG]
2.8 JTD, 2.8 JTD 4x4	11/00-04/02	8140.43S	2798		0-N1617	TB [BT]
2.8 JTD, 2.8 JTD 4x4	11/00-04/02	8140.43S	2798		0-N816	TB [DG]
2.8 JTD, 2.8 JTD 4x4	11/00-04/02	8140.43S	2798		0-N821	TB [DG]
1.9 D, 1.9 TD	04/98-04/02	DHX (XUD9TF/L), DJY	1905		0-N931	VB [TE]
1.9 TD, 1.9 TD CAT	03/94-04/02	230 A3.000, 230 A4.000	1929	☼	0-N1672	VB [DG]
1.9 TD, 1.9 TD CAT	03/94-04/02	230 A3.000, 230 A4.000	1929		0-N187	VB [DG]
2.0 JTD	10/01-04/02	RHV (DW10)	1997		0-N1421	VB [DG]
2.0 JTD	10/01-04/02	RHV (DW10)	1997	☼	0-N1471	VB [BT] S
2.0 JTD	10/01-04/02	RHV (DW10)	1997	☼	0-N1493	VB [BT] S
2.0 JTD	10/01-04/02	RHV (DW10)	1997	☼	0-N1748	VB [BT]
2.0, 2.0 4x4	03/94-04/02	RFW	1998		0-N124	VB [TE]
2.5 D, 2.5 TDI, 2.5 TDI 4x4, 2.5 TDI Maxi	03/94-04/02	8140.47, 8140.47R, 8140.67	2500	☼; mit Anbaumaterial	0-N1386	VB [TE]
2.5 TD, 2.5 TD 4x4	06/94-08/98	8140.47	2499	☼; mit Anbaumaterial	0-N1386	VB [TE]
2.8 D, 2.8 D 4x4, 2.8 TDI, 2.8 TDI 4x4	10/97-04/02	8140.43, 8140.63	2800	☼; mit Anbaumaterial	0-N1386	VB [TE]
2.8 iDTD 4x4	05/98-09/01	8140.43	2799	☼; mit Anbaumaterial	0-N1386	VB [TE]
2.8 JTD, 2.8 JTD 4x4	11/00-04/02	8140.43S	2798	☼: →3980846; ☼; mit Anbaumaterial	0-N1386	VB [TE]
2.8 JTD, 2.8 JTD 4x4	11/00-04/02	8140.43S	2798		0-N1387	VB [DG]
2.8 JTD, 2.8 JTD 4x4	11/00-04/02	8140.43S	2798	☼: →3980847 →; mit Anbaumaterial	0-N1711S	VB [TE]

DUCATO Pritsche/Fahrgestell (230)

1.9 D, 1.9 TD	03/94-04/02	230 A2.000, 230 A3.000	1929	25x173; 11/1994 →	SK-1144	BTK
1.9 D, 1.9 TD	04/98-04/02	DHX (XUD9TF/L), DJY	1905	25.4x136	SK-1022	BTK
1.9 TD	04/98-04/02	DHX (XUD9TF/L)	1905	25.4x136	SK-1022AQ1	BTKW
1.9 TD CAT	08/94-04/02	230 A4.000	1929	25x173	SK-1144	BTK
2.0	03/94-04/02	RFW	1998	25.4x114	SK-1079	BTK
2.0 JTD	07/01-04/02	RHV (DW10)	1997	25.4x141; mit Zubehör	SK-1085AQ1	BTKW
2.5 D	03/94-04/02	8140.67	2500	30x152; 06/1994 → 08/1998; mit Spanndämpfer, Spannrolle	SK-1680	BTK
2.5 D 4x4	03/94-04/02	8140.67	2500	30x152; 06/1994 → 04/1998; mit Spanndämpfer, Spannrolle	SK-1680	BTK
2.5 D, 2.5 D 4x4	03/94-04/02	8140.67	2500	30x152	SK-1035	BTK
2.5 TD, 2.5 TD 4x4	06/94-08/98	8140.47	2499	30x153	SK-1046	BTK
2.5 TD, 2.5 TD 4x4	06/94-08/98	8140.47	2499	mit Spanndämpfer, Spannrolle	SK-1679	BTK
2.5 TDI, 2.5 TDI 4x4	03/94-04/02	8140.47, 8140.47R	2500	30x153	SK-1046	BTK
2.5 TDI, 2.5 TDI 4x4	03/94-04/02	8140.47, 8140.47R	2500	mit Spanndämpfer, Spannrolle	SK-1679	BTK
2.8 D	02/98-04/02	8140.63	2800	30x153	SK-1046	BTK
2.8 D	02/98-04/02	8140.63	2800	05/1998 → 09/2001; mit Spanndämpfer, Spannrolle	SK-1679	BTK
2.8 iDTD 4x4	05/98-09/01	8140.43	2799	30x154	SK-1153	BTK
2.8 iDTD 4x4	05/98-09/01	8140.43	2799	mit Spanndämpfer, Spannrolle; Baumuster: Ducato 14	SK-1681	BTK
2.8 iDTD 4x4	05/98-09/01	8140.43	2799	mit Spanndämpfer, Spannrolle; Baumuster: Ducato 18	SK-1681	BTK
2.8 JTD	11/00-04/02	8140.43S	2798	30x152	SK-1035	BTK
2.8 JTD	11/00-04/02	8140.43S	2798	30x152; mit Spanndämpfer, Spannrolle	SK-1680	BTK
2.8 JTD	03/01-04/02	8140.43S	2799	30x152	SK-1035	BTK
2.8 JTD	03/01-04/02	8140.43S	2799	30x152; mit Spanndämpfer, Spannrolle	SK-1680	BTK
2.8 TDI	12/98-04/02	8140.43	2800	30x154	SK-1153	BTK
2.8 TDI	12/98-04/02	8140.43	2800	mit Spanndämpfer, Spannrolle	SK-1681	BTK
1.9 D, 1.9 TD	04/98-04/02	DHX (XUD9TF/L), DJY	1905		0-N900	TB [DG]
1.9 D, 1.9 TD	04/98-04/02	DHX (XUD9TF/L), DJY	1905		0-N901	TB [TE]
1.9 D, 1.9 TD, 1.9 TD CAT	03/94-04/02	230 A2.000, 230 A3.000, 230 A4.000	1929		0-N835	TB [TE]
1.9 D, 1.9 TD, 1.9 TD CAT	03/94-04/02	230 A2.000, 230 A3.000, 230 A4.000	1929		0-N889	TB [DG]
2.0	03/94-04/02	RFW	1998		0-N943	TB [TE]
2.5 D, 2.5 D 4x4	03/94-04/02	8140.67	2500		0-N821	TB [DG]
2.5 D, 2.5 D 4x4, 2.5 TDI, 2.5 TDI 4x4	03/94-04/02	8140.47, 8140.47R, 8140.67	2500		0-N1617	TB [BT]
2.5 D, 2.5 D 4x4, 2.5 TDI, 2.5 TDI 4x4	03/94-04/02	8140.47, 8140.47R, 8140.67	2500		0-N816	TB [DG]
2.5 TD, 2.5 TD 4x4	06/94-08/98	8140.47	2499		0-N1617	TB [BT]
2.5 TD, 2.5 TD 4x4	06/94-08/98	8140.47	2499		0-N816	TB [DG]



CM³



Art. Nr.



DUCATO Pritsche/Fahrgestell (230)

2.8 D, 2.8 TDI	02/98-04/02	8140.43, 8140.63	2800		0-N1617	TB [BT]
2.8 D, 2.8 TDI	02/98-04/02	8140.43, 8140.63	2800		0-N816	TB [DG]
2.8 IDTD 4x4, 2.8 JTD, 2.8 TD 4x4	05/98-04/02	8140.43, 8140.43S, 8140.63	2799		0-N816	TB [DG]
2.8 IDTD 4x4, 2.8 TD 4x4	05/98-11/01	8140.43, 8140.63	2799		0-N1617	TB [BT]
2.8 JTD	11/00-04/02	8140.43S	2798		0-N1617	TB [BT]
2.8 JTD	11/00-04/02	8140.43S	2798		0-N816	TB [DG]
2.8 JTD	11/00-04/02	8140.43S	2798		0-N821	TB [DG]
2.8 JTD	03/01-04/02	8140.43S	2799		0-N821	TB [DG]
1.9 D, 1.9 TD	04/98-04/02	DHX (XUD9TF/L), DJY	1905		0-N931	VB [TE]
1.9 TD, 1.9 TD CAT	03/94-04/02	230 A3.000, 230 A4.000	1929	✳	0-N1672	VB [DG]
1.9 TD, 1.9 TD CAT	03/94-04/02	230 A3.000, 230 A4.000	1929		0-N187	VB [DG]
2.0	03/94-04/02	RFW	1998		0-N124	VB [TE]
2.5 D, 2.5 D 4x4, 2.5 TDI, 2.5 TDI 4x4	03/94-04/02	8140.47, 8140.47R, 8140.67	2500	†; mit Anbaumaterial	0-N1386	VB [TE]
2.5 TD, 2.5 TD 4x4	06/94-08/98	8140.47	2499	†; mit Anbaumaterial	0-N1386	VB [TE]
2.8 D, 2.8 TDI	02/98-04/02	8140.43, 8140.63	2800	†; mit Anbaumaterial	0-N1386	VB [TE]
2.8 IDTD 4x4, 2.8 TD 4x4	05/98-11/01	8140.43, 8140.63	2799	†; mit Anbaumaterial	0-N1386	VB [TE]
2.8 JTD	11/00-04/02	8140.43S	2798	†; mit Anbaumaterial <small>† (ENGINE) → 3980846; †; mit Anbaumaterial</small>	0-N1386	VB [TE]
2.8 JTD	11/00-04/02	8140.43S	2798		0-N1387	VB [DG]
2.8 JTD	11/00-04/02	8140.43S	2798	† (ENGINE): 3980847 →; mit Anbaumaterial	0-N1711S	VB [TE]
2.8 JTD	03/01-04/02	8140.43S	2799	† (ENGINE): → 3980846; †; mit Anbaumaterial	0-N1386	VB [TE]
2.8 JTD	03/01-04/02	8140.43S	2799		0-N1387	VB [DG]
2.8 JTD	03/01-04/02	8140.43S	2799	† (ENGINE): 3980847 →; mit Anbaumaterial	0-N1711S	VB [TE]

DUCATO Bus (244, Z_)

2.0 JTD	04/02-	RHV (DW10)	1997	25x141; mit Zubehör	SK-1085	BTK
2.0 JTD	04/02-	RHV (DW10)	1997	25.4x141; mit Zubehör	SK-1085AQ1	BTKW
2.0, 2.0 4x4, 2.0 Bipower	04/02-07/06	RFL	1998	25.4x114	SK-1079	BTK
2.3 JTD	04/02-	F1AE0481C	2286	30x178	SK-1610	BTK
2.3 JTD	04/02-	F1AE0481C	2286	30x178; Baumuster: Ducato 11	SK-1610AQ1	BTKW
2.3 JTD	04/02-	F1AE0481C	2286	30x178; Baumuster: Ducato 15	SK-1610AQ1	BTKW
2.3 JTD	04/02-	F1AE0481C	2286	30x178; Baumuster: Ducato 18	SK-1610AQ1	BTKW
2.8 JTD	04/04-07/06	8140.43N	2800	30x152	SK-1035	BTK
2.8 JTD, 2.8 JTD 4x4	04/02-	8140.43S	2798	30x152	SK-1035	BTK
2.8 JTD, 2.8 JTD 4x4	04/02-	8140.43S	2798	30x152; → 07/2006; mit Spanndämpfer, Spannrolle	SK-1680	BTK
2.8 TD	11/03-07/06	8140.43	2799	30x154	SK-1153	BTK
2.8 TD 4x4	11/03-07/06	8140.43	2799	30x152	SK-1035	BTK
2.8 TD 4x4	11/03-07/06	8140.43	2799	30x152; mit Spanndämpfer, Spannrolle	SK-1680	BTK
2.0 JTD	04/02-	RHV (DW10)	1997		0-N118P	TB [TE]
2.0 JTD	04/02-	RHV (DW10)	1997		0-N119P	TB [DG]
2.0, 2.0 Bipower	04/02-	RFL	1998		0-N943	TB [TE]
2.3 JTD	04/02-	F1AE0481C	2286		0-N1351	TB [TE]
2.3 JTD	04/02-	F1AE0481C	2286		0-N1352	TB [DG]
2.8 JTD	04/04-07/06	8140.43N	2800		0-N1617	TB [BT]
2.8 JTD	04/04-07/06	8140.43N	2800		0-N816	TB [DG]
2.8 JTD	04/04-07/06	8140.43N	2800		0-N821	TB [DG]
2.8 JTD, 2.8 JTD 4x4	04/02-	8140.43S	2798		0-N1617	TB [BT]
2.8 JTD, 2.8 JTD 4x4	04/02-	8140.43S	2798		0-N816	TB [DG]
2.8 JTD, 2.8 JTD 4x4	04/02-	8140.43S	2798		0-N821	TB [DG]
2.8 TD, 2.8 TD 4x4	11/03-07/06	8140.43	2799		0-N1617	TB [BT]
2.8 TD, 2.8 TD 4x4	11/03-07/06	8140.43	2799		0-N816	TB [DG]
2.0 JTD	04/02-	RHV (DW10)	1997		0-N1421	VB [DG]
2.0 JTD	04/02-	RHV (DW10)	1997	05/2004 →; ✳, ✳; VET7431902 →; VET → 7431901	0-N1471	VB [BT] S
2.0 JTD	04/02-	RHV (DW10)	1997	✳; VET → 7431901	0-N1493	VB [BT] S
2.0 JTD	04/02-	RHV (DW10)	1997	✳; VET → 7431901	0-N1748	VB [BT]
2.0, 2.0 Bipower	04/02-	RFL	1998		0-N124	VB [TE]
2.3 JTD	04/02-	F1AE0481C	2286		0-N1483	VB [BT] S
2.3 JTD	04/02-	F1AE0481C	2286		0-N1597	VB [DG]
2.3 JTD	04/02-	F1AE0481C	2286		0-N1806	VB [BT]
2.8 JTD	04/04-07/06	8140.43N	2800	†; mit Anbaumaterial	0-N1386	VB [TE]
2.8 JTD	04/04-07/06	8140.43N	2800		0-N1387	VB [DG]
2.8 JTD, 2.8 JTD 4x4	04/02-	8140.43S	2798	† (ENGINE): → 3980846; †; mit Anbaumaterial	0-N1386	VB [TE]
2.8 JTD, 2.8 JTD 4x4	04/02-	8140.43S	2798		0-N1387	VB [DG]
2.8 JTD, 2.8 JTD 4x4	04/02-	8140.43S	2798	† (ENGINE): 3980847 →; mit Anbaumaterial	0-N1711S	VB [TE]
2.8 TD, 2.8 TD 4x4	11/03-07/06	8140.43	2799	†; mit Anbaumaterial	0-N1386	VB [TE]

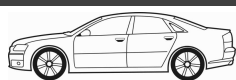

CM³



Art. Nr.



ohne Halter

DUCATO Kasten (244)

2.0 JTD	04/02-	RHV (DW10)	1997	25x141; mit Zubehör	SK-1085	BTK	
2.0 JTD	04/02-	RHV (DW10)	1997	25.4x141; mit Zubehör	SK-1085AQ1	BTKW	
2.0, 2.0 Bipower	04/02-	RFL	1998	25.4x114	SK-1079	BTK	
2.3 JTD	04/02-	F1AE0481C	2286	30x178	SK-1610	BTK	
2.3 JTD	04/02-	F1AE0481C	2286	30x178; Baumuster: Ducato 11	SK-1610AQ1	BTKW	
2.3 JTD	04/02-	F1AE0481C	2286	30x178; Baumuster: Ducato 15	SK-1610AQ1	BTKW	
2.3 JTD	04/02-	F1AE0481C	2286	30x178; Baumuster: Ducato 18	SK-1610AQ1	BTKW	
2.8 JTD Power	05/04-	8140.43N	2800	30x152	SK-1035	BTK	
2.8 JTD Power	05/04-	8140.43N	2800	30x152; → 07/2006; mit Spanndämpfer, Spannrolle	SK-1680	BTK	
2.8 JTD, 2.8 JTD 4x4	04/02-	8140.43S	2798	30x152	SK-1035	BTK	
2.8 JTD, 2.8 JTD 4x4	04/02-	8140.43S	2798	30x152; → 07/2006; mit Spanndämpfer, Spannrolle	SK-1680	BTK	
2.8 TD	11/03-07/06	8140.43	2799	30x154	SK-1153	BTK	
2.0 JTD	04/02-	RHV (DW10)	1997		0-N118P	TB [TE]	
2.0 JTD	04/02-	RHV (DW10)	1997		0-N119P	TB [DG]	
2.0, 2.0 Bipower	04/02-	RFL	1998		0-N943	TB [TE]	
2.3 JTD	04/02-	F1AE0481C	2286		0-N1351	TB [TE]	
2.3 JTD	04/02-	F1AE0481C	2286		0-N1352	TB [DG]	
2.8 JTD Power	05/04-	8140.43N	2800		0-N1617	TB [BT]	
2.8 JTD Power	05/04-	8140.43N	2800		0-N816	TB [DG]	
2.8 JTD Power	05/04-	8140.43N	2800		0-N821	TB [DG]	
2.8 JTD, 2.8 JTD 4x4	04/02-	8140.43S	2798		0-N1617	TB [BT]	
2.8 JTD, 2.8 JTD 4x4	04/02-	8140.43S	2798		0-N816	TB [DG]	
2.8 JTD, 2.8 JTD 4x4	04/02-	8140.43S	2798		0-N821	TB [DG]	
2.8 TD, 2.8 TD 4x4	11/03-07/06	8140.43	2799		0-N1617	TB [BT]	
2.8 TD, 2.8 TD 4x4	11/03-07/06	8140.43	2799		0-N816	TB [DG]	
2.0 JTD	04/02-	RHV (DW10)	1997		0-N1421	VB [DG]	
2.0 JTD	04/02-	RHV (DW10)	1997	05/2004 →; *; VET7431902→; VET→7431901	0-N1471	VB [BT]	S
2.0 JTD	04/02-	RHV (DW10)	1997	*; VET→7431901	0-N1493	VB [BT]	S
2.0 JTD	04/02-	RHV (DW10)	1997	*; VET→7431901	0-N1748	VB [BT]	
2.0, 2.0 Bipower	04/02-	RFL	1998		0-N124	VB [TE]	
2.3 JTD	04/02-	F1AE0481C	2286		0-N1483	VB [BT]	S
2.3 JTD	04/02-	F1AE0481C	2286		0-N1597	VB [DG]	
2.3 JTD	04/02-	F1AE0481C	2286		0-N1806	VB [BT]	
2.8 JTD Power	05/04-	8140.43N	2800	†; mit Anbaumaterial	0-N1386	VB [TE]	
2.8 JTD Power	05/04-	8140.43N	2800		0-N1387	VB [DG]	
2.8 JTD, 2.8 JTD 4x4	04/02-	8140.43S	2798	☎; →3980846; †; mit Anbaumaterial	0-N1386	VB [TE]	
2.8 JTD, 2.8 JTD 4x4	04/02-	8140.43S	2798		0-N1387	VB [DG]	
2.8 JTD, 2.8 JTD 4x4	04/02-	8140.43S	2798	☎:3980847→; mit Anbaumaterial	0-N1711S	VB [TE]	
2.8 TD, 2.8 TD 4x4	11/03-07/06	8140.43	2799	†; mit Anbaumaterial	0-N1386	VB [TE]	

DUCATO Pritsche/Fahrgestell (244)

2.0 JTD	04/02-07/06	RHV (DW10)	1997	25x141; mit Zubehör	SK-1085	BTK	
2.0 JTD	04/02-07/06	RHV (DW10)	1997	25.4x141; mit Zubehör	SK-1085AQ1	BTKW	
2.3 JTD	04/02-07/06	F1AE0481C	2286	30x178	SK-1610	BTK	
2.3 JTD	04/02-07/06	F1AE0481C	2286	30x178; Baumuster: Ducato 15	SK-1610AQ1	BTKW	
2.3 JTD	04/02-07/06	F1AE0481C	2286	30x178; Baumuster: Ducato 18	SK-1610AQ1	BTKW	
2.8 JTD	11/03-07/06	8140.43	2799	30x154	SK-1153	BTK	
2.8 JTD Power	05/04-07/06	8140.43N	2800	30x152	SK-1035	BTK	
2.8 JTD Power	05/04-07/06	8140.43N	2800	30x152; mit Spanndämpfer, Spannrolle	SK-1680	BTK	
2.8 JTD, 2.8 JTD 4x4	04/02-07/06	8140.43S	2798	30x152	SK-1035	BTK	
2.8 JTD, 2.8 JTD 4x4	04/02-07/06	8140.43S	2798	30x152; mit Spanndämpfer, Spannrolle	SK-1680	BTK	
2.0	04/02-07/06	RFL	1998		0-N943	TB [TE]	
2.0 JTD	04/02-07/06	RHV (DW10)	1997		0-N118P	TB [TE]	
2.0 JTD	04/02-07/06	RHV (DW10)	1997		0-N119P	TB [DG]	
2.3 JTD	04/02-07/06	F1AE0481C	2286		0-N1351	TB [TE]	
2.3 JTD	04/02-07/06	F1AE0481C	2286		0-N1352	TB [DG]	
2.8 JTD Power	05/04-07/06	8140.43N	2800		0-N1617	TB [BT]	
2.8 JTD Power	05/04-07/06	8140.43N	2800		0-N816	TB [DG]	
2.8 JTD Power	05/04-07/06	8140.43N	2800		0-N821	TB [DG]	
2.8 JTD, 2.8 JTD 4x4	04/02-07/06	8140.43S	2798		0-N1617	TB [BT]	
2.8 JTD, 2.8 JTD 4x4	04/02-07/06	8140.43S	2798		0-N816	TB [DG]	
2.8 JTD, 2.8 JTD 4x4	04/02-07/06	8140.43S	2798		0-N821	TB [DG]	
2.8 JTD, 2.8 JTD 4x4	11/03-07/06	8140.43	2799		0-N1617	TB [BT]	
2.8 JTD, 2.8 JTD 4x4	11/03-07/06	8140.43	2799		0-N816	TB [DG]	



OPTIMAL®

FIAT



CM³



Art. Nr.



DUCATO Pritsche/Fahrgestell (244)

2.0 JTD	04/02-07/06	RHV (DW10)	1997		0-N1421	VB [DG]	
2.0 JTD	04/02-07/06	RHV (DW10)	1997	05/2004 →; ⚡; ⚡; VET7431902→; VET→7431901	0-N1471	VB [BT]	S
2.0 JTD	04/02-07/06	RHV (DW10)	1997	⚡; VET→7431901	0-N1493	VB [BT]	S
2.0 JTD	04/02-07/06	RHV (DW10)	1997	⚡; VET→7431901	0-N1748	VB [BT]	
2.3 JTD	04/02-07/06	F1AE0481C	2286		0-N1483	VB [BT]	S
2.3 JTD	04/02-07/06	F1AE0481C	2286		0-N1597	VB [DG]	
2.3 JTD	04/02-07/06	F1AE0481C	2286		0-N1806	VB [BT]	
2.8 JTD Power	05/04-07/06	8140.43N	2800	‡; mit Anbaumaterial	0-N1386	VB [TE]	
2.8 JTD Power	05/04-07/06	8140.43N	2800		0-N1387	VB [DG]	
2.8 JTD, 2.8 JTD 4x4	04/02-07/06	8140.43S	2798	⚡: →3980846; ‡; mit Anbaumaterial	0-N1386	VB [TE]	
2.8 JTD, 2.8 JTD 4x4	04/02-07/06	8140.43S	2798		0-N1387	VB [DG]	
2.8 JTD, 2.8 JTD 4x4	04/02-07/06	8140.43S	2798	⚡: →3980847→; mit Anbaumaterial	0-N1711S	VB [TE]	
2.8 JTD, 2.8 JTD 4x4	11/03-07/06	8140.43	2799	‡; mit Anbaumaterial	0-N1386	VB [TE]	

DUCATO Bus (250, 290)

110 Multijet 2,3 D	10/11-	F1AE3481G	2287	30x178	SK-1610AQ1	BTKW	
110 Multijet 2,3 D, 150 Multijet 2,3 D	06/11-	F1AE3481E, F1AE3481G	2287	30x178	SK-1610	BTK	
115 Multijet 2,0 D	06/11-	250 A1.000, 250 A2.000	1956	24x199	SK-1586	BTK	
115 Multijet 2,0 D	06/11-	250 A1.000, 250 A2.000	1956	24x199; Baumuster: Ducato 30	SK-1586AQ1	BTKW	
115 Multijet 2,0 D	06/11-	250 A1.000, 250 A2.000	1956	24x199; Baumuster: Ducato 33	SK-1586AQ1	BTKW	
115 Multijet 2,0 D	06/11-	250 A1.000, 250 A2.000	1956	24x199; Baumuster: Ducato 35	SK-1586AQ1	BTKW	
120 Multijet 2,3 D	07/06-	F1AE0481D	2287	30x178; Baumuster: 30, 33	SK-1610	BTK	
120 Multijet 2,3 D	07/06-	F1AE0481D	2287	30x178; Baumuster: Ducato 40	SK-1610AQ1	BTKW	
120 Multijet 2,3 D, 130 Multijet 2,3 D, 150 Multijet 2,3 D	07/06-	F1AE0481D, F1AE3481D, F1AGL411D, F1AE3481E	2287	30x178; Baumuster: Ducato 30	SK-1610AQ1	BTKW	
120 Multijet 2,3 D, 130 Multijet 2,3 D, 150 Multijet 2,3 D	07/06-	F1AE0481D, F1AE3481D, F1AGL411D, F1AE3481E	2287	30x178; Baumuster: Ducato 33	SK-1610AQ1	BTKW	
120 Multijet 2,3 D, 130 Multijet 2,3 D, 150 Multijet 2,3 D	07/06-	F1AE0481D, F1AE3481D, F1AGL411D, F1AE3481E	2287	30x178; Baumuster: Ducato 35	SK-1610AQ1	BTKW	
130 Multijet 2,3 D	01/07-	F1AE3481D, F1AGL411D	2287	30x178; 06/2011 →	SK-1610	BTK	
110 Multijet 2,3 D, 120 Multijet 2,3 D, 130 Multijet 2,3 D, 150 Multijet 2,3 D	07/06-	F1AE0481D, F1AE3481D, F1AGL411D, F1AE3481E, F1AE3481G	2287		0-N1351	TB [TE]	
110 Multijet 2,3 D, 120 Multijet 2,3 D, 130 Multijet 2,3 D, 150 Multijet 2,3 D	07/06-	F1AE0481D, F1AE3481D, F1AGL411D, F1AE3481E, F1AE3481G	2287		0-N1352	TB [DG]	
115 Multijet 2,0 D	06/11-	250 A1.000, 250 A2.000	1956		0-N2149	TB [DG]	
100 Multijet 2,2 D	07/06-	4HV	2198		0-N1392	VB [DG]	
100 Multijet 2,2 D	07/06-	4HV	2198	Rippenanzahl: 6	0-N1460	VB [DG]	
100 Multijet 2,2 D	07/06-	4HV	2198		0-N2014	VB [BT]	S
110 Multijet 2,3 D, 120 Multijet 2,3 D, 130 Multijet 2,3 D, 130 Multijet 2,3 D, 150 Multijet 2,3 D	07/06-	F1AE0481D, F1AE0481T, F1AE3481D, F1AGL411D, F1AE3481E, F1AE3481G	2287		0-N1483	VB [BT]	S
110 Multijet 2,3 D, 120 Multijet 2,3 D, 130 Multijet 2,3 D, 150 Multijet 2,3 D	07/06-	F1AE0481D, F1AE3481D, F1AGL411D, F1AE3481E, F1AE3481G	2287		0-N1806	VB [BT]	
120 Multijet 2,3 D	07/06-	F1AE0481D	2287		0-N1597	VB [DG]	
140 Natural Power, 150 Multijet 3,0 D, 160 Multijet 3,0 D	07/06-	F1CE0441A, F1CE0481D, F1CE3481M, F1CE3481N	2999		0-N1714	VB [BT]	S
140 Natural Power, 150 Multijet 3,0 D, 160 Multijet 3,0 D, 3,0 D Multijet	07/06-	F1CE0441A, F1CE0481D, F1CE3481M, F1CE3481E, F1CE3481N	2999	mit Anbaumaterial	0-N1711S	VB [TE]	

DUCATO Kasten (250, 290)

110 Multijet 2,3 D, 150 Multijet 2,3 D, Multijet	08/06-	F1AE0481T, F1AE3481E, F1AE3481G	2287	30x178	SK-1610	BTK	
110 Multijet 2,3 D, Multijet	08/06-	F1AE0481T, F1AE3481G	2287	30x178	SK-1610AQ1	BTKW	
115 Multijet 2,0 D	06/11-	250 A1.000, 250 A2.000	1956	24x199	SK-1586	BTK	
115 Multijet 2,0 D	06/11-	250 A1.000, 250 A2.000	1956	24x199; Baumuster: Ducato 28	SK-1586AQ1	BTKW	
115 Multijet 2,0 D	06/11-	250 A1.000, 250 A2.000	1956	24x199; Baumuster: Ducato 30	SK-1586AQ1	BTKW	
115 Multijet 2,0 D	06/11-	250 A1.000, 250 A2.000	1956	24x199; Baumuster: Ducato 33	SK-1586AQ1	BTKW	
115 Multijet 2,0 D	06/11-	250 A1.000, 250 A2.000	1956	24x199; Baumuster: Ducato 35	SK-1586AQ1	BTKW	
120 Multijet 2,3 D	07/06-	F1AE0481D, FPT	2287	30x178; Baumuster: 30, 33, 35	SK-1610	BTK	
120 Multijet 2,3 D, 130 Multijet 2,3 D, 150 Multijet 2,3 D	07/06-	F1AE0481D, FPT, F1AE0481N, F1AE3481D, F1AGL411D, F1AE3481E	2287	30x178; Baumuster: Ducato 30	SK-1610AQ1	BTKW	
120 Multijet 2,3 D, 130 Multijet 2,3 D, 150 Multijet 2,3 D	07/06-	F1AE0481D, FPT, F1AE0481N, F1AE3481D, F1AGL411D, F1AE3481E	2287	30x178; Baumuster: Ducato 33	SK-1610AQ1	BTKW	
120 Multijet 2,3 D, 130 Multijet 2,3 D, 150 Multijet 2,3 D	07/06-	F1AE0481D, FPT, F1AE0481N, F1AE3481D, F1AGL411D, F1AE3481E	2287	30x178; Baumuster: Ducato 35	SK-1610AQ1	BTKW	
120 Multijet 2,3 D, 130 Multijet 2,3 D, 150 Multijet 2,3 D	07/06-	F1AE0481D, FPT, F1AE0481N, F1AE3481D, F1AGL411D, F1AE3481E	2287	30x178; Baumuster: Ducato 40	SK-1610AQ1	BTKW	
130 Multijet 2,3 D	01/07-	F1AE0481N, F1AE3481D, F1AGL411D	2287	30x178; 06/2010 →	SK-1610	BTK	
130 Multijet 2,3 D	01/07-	F1AE0481N, F1AE3481D, F1AGL411D	2287	30x178; Baumuster: Ducato 26	SK-1610AQ1	BTKW	

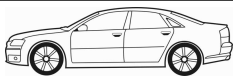

CM³



Art. Nr.



DUCATO Kasten (250, 290)

110 Multijet 2,3 D, 120 Multijet 2,3 D, 130 Multijet 2,3 D, 150 Multijet 2,3 D, Multijet	07/06-	F1AE0481D, F1AE0481D, FPT, F1AE0481N, F1AE3481D, F1AGL411D, F1AE0481T, F1AE3481E, F1AE3481G	2287			0-N1351	TB [TE]	
110 Multijet 2,3 D, 120 Multijet 2,3 D, 130 Multijet 2,3 D, 150 Multijet 2,3 D, Multijet	07/06-	F1AE0481D, F1AE0481D, FPT, F1AE0481N, F1AE3481D, F1AGL411D, F1AE0481T, F1AE3481E, F1AE3481G	2287			0-N1352	TB [DG]	
115 Multijet 2,0 D	06/11-	250 A1.000, 250 A2.000	1956			0-N2149	TB [DG]	
100 Multijet 2,2 D	07/06-	4HV	2198			0-N1392	VB [DG]	
100 Multijet 2,2 D	07/06-	4HV	2198	Rippenanzahl: 6		0-N1460	VB [DG]	
100 Multijet 2,2 D	07/06-	4HV	2198			0-N2014	VB [BT]	S
110 Multijet 2,3 D, 120 Multijet 2,3 D, 130 Multijet 2,3 D, 150 Multijet 2,3 D	07/06-	F1AE0481D, F1AE0481D, FPT, F1AE0481N, F1AE3481D, F1AGL411D, F1AE3481E, F1AE3481G	2287			0-N1806	VB [BT]	
110 Multijet 2,3 D, 120 Multijet 2,3 D, 130 Multijet 2,3 D, 150 Multijet 2,3 D, Multijet	07/06-	F1AE0481D, F1AE0481D, FPT, F1AE0481N, F1AE3481D, F1AGL411D, F1AE0481T, F1AE3481E, F1AE3481G	2287			0-N1483	VB [BT]	S
120 Multijet 2,3 D	07/06-	F1AE0481D, FPT	2287			0-N1597	VB [DG]	
140 Natural Power, 150 Multijet 3,0 D, 160 Multijet 3,0 D	07/06-	F1CE0441A, F1CFA401A, F1CE0481D, F1CE3481N	2999			0-N1714	VB [BT]	S
140 Natural Power, 150 Multijet 3,0 D, 160 Multijet 3,0 D, 3,0 D Multijet	07/06-	F1CE0441A, F1CFA401A, F1CE0481D, F1CE3481E, F1CE3481M, F1CE3481N	2999	mit Anbaumaterial		0-N1711S	VB [TE]	

DUCATO Pritsche/Fahrgestell (250, 290)

110 Multijet 2,3 D, 130 Multijet 2,3 D	08/06-	F1AE0481T, F1AE3481G	2287	30x178		SK-1610AQ1	BTKW	
110 Multijet 2,3 D, 130 Multijet 2,3 D, 150 Multijet 2,3 D	08/06-	F1AE0481T, F1AE3481E, F1AE3481G	2287	30x178		SK-1610	BTK	
115 Multijet 2,0 D	06/11-	250 A1.000, 250 A2.000	1956	24x199		SK-1586	BTK	
115 Multijet 2,0 D	06/11-	250 A1.000, 250 A2.000	1956	24x199; Baumuster: Ducato 30		SK-1586AQ1	BTKW	
115 Multijet 2,0 D	06/11-	250 A1.000, 250 A2.000	1956	24x199; Baumuster: Ducato 33		SK-1586AQ1	BTKW	
115 Multijet 2,0 D	06/11-	250 A1.000, 250 A2.000	1956	24x199; Baumuster: Ducato 35		SK-1586AQ1	BTKW	
120 Multijet 2,3 D	07/06-	F1AE0481D	2287	30x178; Baumuster: 33, 35		SK-1610	BTK	
120 Multijet 2,3 D, 130 Multijet 2,3 D, 150 Multijet 2,3 D	07/06-	F1AE0481D, F1AE0481N, F1AE3481D, F1AGL411D, F1AE3481E	2287	30x178; Baumuster: Ducato 30		SK-1610AQ1	BTKW	
120 Multijet 2,3 D, 130 Multijet 2,3 D, 150 Multijet 2,3 D	07/06-	F1AE0481D, F1AE0481N, F1AE3481D, F1AGL411D, F1AE3481E	2287	30x178; Baumuster: Ducato 33		SK-1610AQ1	BTKW	
120 Multijet 2,3 D, 130 Multijet 2,3 D, 150 Multijet 2,3 D	07/06-	F1AE0481D, F1AE0481N, F1AE3481D, F1AGL411D, F1AE3481E	2287	30x178; Baumuster: Ducato 35		SK-1610AQ1	BTKW	
120 Multijet 2,3 D, 130 Multijet 2,3 D, 150 Multijet 2,3 D	07/06-	F1AE0481D, F1AE0481N, F1AE3481D, F1AGL411D, F1AE3481E	2287	30x178; Baumuster: Ducato 40		SK-1610AQ1	BTKW	
130 Multijet 2,3 D	01/07-	F1AE3481D	2287	30x178; 06/2011 →; Baumuster: 30, 33, 35		SK-1610	BTK	
110 Multijet 2,3 D, 120 Multijet 2,3 D, 130 Multijet 2,3 D, 150 Multijet 2,3 D	07/06-	F1AE0481D, F1AE0481N, F1AE3481D, F1AGL411D, F1AE3481E, F1AE3481G	2287			0-N1351	TB [TE]	
110 Multijet 2,3 D, 120 Multijet 2,3 D, 130 Multijet 2,3 D, 150 Multijet 2,3 D	07/06-	F1AE0481D, F1AE0481N, F1AE3481D, F1AGL411D, F1AE3481E, F1AE3481G	2287			0-N1352	TB [DG]	
115 Multijet 2,0 D	06/11-	250 A1.000, 250 A2.000	1956			0-N2149	TB [DG]	
100 Multijet 2,2 D	07/06-	4HV	2198			0-N1392	VB [DG]	
100 Multijet 2,2 D	07/06-	4HV	2198	Rippenanzahl: 6		0-N1460	VB [DG]	
100 Multijet 2,2 D	07/06-	4HV	2198			0-N2014	VB [BT]	S
110 Multijet 2,3 D, 120 Multijet 2,3 D, 130 Multijet 2,3 D, 150 Multijet 2,3 D	07/06-	F1AE0481D, F1AE0481N, F1AE3481D, F1AGL411D, F1AE3481E, F1AE3481G	2287			0-N1483	VB [BT]	S
110 Multijet 2,3 D, 120 Multijet 2,3 D, 130 Multijet 2,3 D, 150 Multijet 2,3 D	07/06-	F1AE0481D, F1AE0481N, F1AE3481D, F1AGL411D, F1AE3481E, F1AE3481G	2287			0-N1806	VB [BT]	
120 Multijet 2,3 D	07/06-	F1AE0481D	2287			0-N1597	VB [DG]	
130 Multijet 2,3 D	01/07-	F1AE0481N	2287			0-N1597	VB [DG]	
140 Natural Power, 150 Multijet 3,0 D, 160 Multijet 3,0 D, 3,0 D Multijet	07/06-	F1CE0441A, F1CE0481D, F1CE3481E, F1CE3481M, F1CE3481N	2999	mit Anbaumaterial		0-N1711S	VB [TE]	
150 Multijet 3,0 D, 160 Multijet 3,0 D	07/06-	F1CE0481D, F1CE3481N	2999			0-N1714	VB [BT]	S

DUNA (146 B)

70 1.3	01/87-12/91	146 A5.000	1301	15x120		SK-1449	BTK	
DS 1.7	01/87-12/91	149 B3.000	1698	22x168; 06/1987 →		SK-1032	BTK	
60 1.1	01/87-12/91	146 A6.000	1116			0-N850	TB [TE]	
70 1.3	01/87-12/91	146 A5.000	1301			0-N850	TB [TE]	
DS 1.7	01/87-12/91	149 B3.000	1698			0-N819	TB [TE]	
DS 1.7	01/87-12/91	149 B3.000	1698			0-N820	TB [DG]	

DUNA Weekend (146 B)

70 1.3	01/87-12/91	146 A5.000	1301	15x120		SK-1449	BTK	
DS 1.7	01/87-12/91	149 B3.000	1698	22x168; 06/1987 →		SK-1032	BTK	
60 1.1	01/87-12/91	146 A6.000	1116			0-N850	TB [TE]	
70 1.3	01/87-12/91	146 A5.000	1301			0-N850	TB [TE]	
DS 1.7	01/87-12/91	149 B3.000	1698			0-N819	TB [TE]	

CM³

Art. Nr.



DUNA Weekend (146 B)								
DS 1.7	01/87-12/91	149 B3.000	1698			0-N820	TB [DG]	
ELBA (146_)								
1.4	10/93-02/95	146 D5.000	1372	15x138		SK-1031	BTK	
1.7 D	04/89-12/96	146 B2.000	1698	22x168; 04/1991 →		SK-1032	BTK	
1.3	04/91-02/95	146 A5.000	1301			0-N850	TB [TE]	
1.4	10/93-02/95	146 D5.000	1372			0-N822	TB [TE]	
1.7 D	04/89-12/96	146 B2.000	1698			0-N819	TB [TE]	
1.7 D	04/89-12/96	146 B2.000	1698			0-N820	TB [DG]	
FIORINO (127)								
1050	01/80-12/87	127 A.000	1049			0-N850	TB [TE]	
FIORINO Kasten (146)								
1.7 TD, 60 1.7 D	05/88-05/00	146 B2.000, 146 D7.000	1697	22x168		SK-1032	BTK	
60 1.7 D, 65 1.7 TD	05/88-05/01	146 D7.000, 149 B3.000	1698	22x168		SK-1032	BTK	
70 i.e. 1.4	05/94-05/01	146 C5.000, 146 D5.000	1372	15x138		SK-1031	BTK	
75 i.e. 1.5	05/88-12/93	149 C1.000	1499	19.05x118		SK-1138	BTK	
75 i.e. 1.6	10/93-05/01	146 C6.000, 146 D6.000	1581	15x138		SK-1031	BTK	
1.4, 70 i.e. 1.4	11/92-05/01	146 C5.000, 146 C5.000, 146 D5.000	1372			0-N822	TB [TE]	
1.7 D, 1.7 TD, 60 1.7 D	01/88-05/00	146 B2.000, 146 D7.000	1697			0-N819	TB [TE]	
1.7 D, 1.7 TD, 60 1.7 D	01/88-05/00	146 B2.000, 146 D7.000	1697			0-N820	TB [DG]	
60 1.1	05/88-12/93	146 A9.000	1116	ch.8220597→		0-N822	TB [TE]	
60 1.1	05/88-12/93	146 A9.000	1116	ch.→8220596		0-N850	TB [TE]	
60 1.7 D, 65 1.7 TD	05/88-05/01	146 D7.000, 149 B3.000	1698			0-N819	TB [TE]	
60 1.7 D, 65 1.7 TD	05/88-05/01	146 D7.000, 149 B3.000	1698			0-N820	TB [DG]	
70 1.3	01/88-12/94	146 A5.000	1301	ch.8220597→		0-N822	TB [TE]	
70 1.3	01/88-12/94	146 A5.000	1301	ch.→8220596		0-N850	TB [TE]	
75 i.e. 1.5	05/88-12/93	149 C1.000	1499			0-N818	TB [TE]	
75 i.e. 1.6	10/93-05/01	146 C6.000, 146 D6.000	1581			0-N822	TB [TE]	
65 1.7 TD	01/97-05/01	146 D7.000	1698			0-N1630	VB [DG]	
70 i.e. 1.4	05/94-05/01	146 C5.000, 146 D5.000	1372			0-N187	VB [DG]	
75 i.e. 1.5	05/88-12/93	149 C1.000	1499			0-N187	VB [DG]	
75 i.e. 1.6	10/93-05/01	146 C6.000, 146 D6.000	1581			0-N187	VB [DG]	
FIORINO Pick up (146)								
1.4	05/94-05/01	146 D5.000	1372	15x138		SK-1031	BTK	
1.6	01/94-05/01	146 C6.000, 146 D6.000	1581	15x138		SK-1031	BTK	
1.7 D	10/93-10/99	146 B2.000	1697	22x168		SK-1032	BTK	
1.7 D, 1.7 TD	05/88-05/01	146 D7.000, 149 B3.000	1698	22x168		SK-1032	BTK	
1.3	01/88-12/94	146 A5.000	1301	ch.8220597→		0-N822	TB [TE]	
1.3	01/88-12/94	146 A5.000	1301	ch.→8220596		0-N850	TB [TE]	
1.4	05/94-05/01	146 D5.000	1372			0-N822	TB [TE]	
1.6	01/94-05/01	146 C6.000, 146 D6.000	1581			0-N822	TB [TE]	
1.7 D	10/93-10/99	146 B2.000	1697			0-N819	TB [TE]	
1.7 D	10/93-10/99	146 B2.000	1697			0-N820	TB [DG]	
1.7 D, 1.7 TD	05/88-05/01	146 D7.000, 149 B3.000	1698			0-N819	TB [TE]	
1.7 D, 1.7 TD	05/88-05/01	146 D7.000, 149 B3.000	1698			0-N820	TB [DG]	
1.4	05/94-05/01	146 D5.000	1372			0-N187	VB [DG]	
1.6	01/94-05/01	146 C6.000, 146 D6.000	1581			0-N187	VB [DG]	
1.7 TD	01/97-05/01	146 D7.000	1698			0-N1630	VB [DG]	
FIORINO (147)								
1.3	12/87-08/93	146 A5.000	1301	15x120; ch.→8220596		SK-1449	BTK	
1.5	01/88-08/93	149 C1.000	1499	19.05x118		SK-1138	BTK	
1.7 Diesel	12/87-12/90	149 B3.000	1698	22x168		SK-1032	BTK	
1.7 Diesel	01/88-10/93	149 B2.000	1697	22x168; 05/1988 →		SK-1032	BTK	
1.0	01/80-04/88	127 A.000, 156 A.000	1049			0-N850	TB [TE]	
1.1 60	11/86-04/88	146 A9.000	1116	ch.8220597→		0-N822	TB [TE]	
1.1 60	11/86-04/88	146 A9.000	1116	ch.→8220596		0-N850	TB [TE]	
1.3	12/87-08/93	146 A5.000	1301	ch.8220597→		0-N822	TB [TE]	
1.3	12/87-08/93	146 A5.000	1301	ch.→8220596		0-N850	TB [TE]	
1.5	01/88-08/93	149 C1.000	1499			0-N818	TB [TE]	
1.7 Diesel	12/87-12/90	149 B3.000	1698			0-N819	TB [TE]	
1.7 Diesel	12/87-12/90	149 B3.000	1698			0-N820	TB [DG]	
1.7 Diesel	01/88-10/93	149 B2.000	1697			0-N819	TB [TE]	
1.7 Diesel	01/88-10/93	149 B2.000	1697			0-N820	TB [DG]	

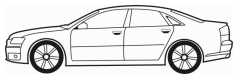

CM³



Art. Nr.



FIORINO Pick up (147)							
1.0	10/82-10/87	156 A.000	1036			0-N850	TB [TE]
1.1	09/87-12/88	149A9.000	1036	ch.8220597→		0-N822	TB [TE]
1.1	09/87-12/88	156 A.000	1036	ch.→8220596		0-N850	TB [TE]

FIORINO Kasten/Kombi (225)							
1.4	11/07-	KFV	1360	17x104; Abgasnorm: Euro 4 (D4); Baumuster: 225		SK-1354	BTK
1.4	11/07-	KFT, KFV	1360	17x104; Abgasnorm: Euro 4 (D4)		SK-1354AQ1	BTKW
1.4 Natural Power	10/09-	350 A1.000	1368	22x129		SK-1677	BTK
1.4	11/07-	KFV	1360			0-N1277	TB [TE]
1.4 Natural Power	10/09-	350 A1.000	1368			0-N1616	TB [TE]
1.3 D Multijet	11/07-	199 A2.000, 199 A9.000	1248			0-N1478S	VB [TE]
1.3 D Multijet	11/07-	199 A2.000, 199 A9.000	1248	☞ sequentiell		0-N1526	VB [BT] S
1.3 D Multijet	07/09-	199 B1.000, 330 A1.000	1248			0-N2390	VB [BT] S
1.4	11/07-	KFV	1360			0-N1419	VB [DG]
1.4	11/07-	KFV	1360			0-N1620	VB [BT] S
1.4 Natural Power	10/09-	350 A1.000	1368			0-N1517	VB [BT] S

FREEMONT (JF_, JC_)							
2.0 JTD, 2.0 JTD 4x4	08/11-	939 B5.000, 939 B5.000, 940 A5.000	1956	24x199		SK-1586	BTK
2.0 JTD, 2.0 JTD 4x4	08/11-	939 B5.000, 939 B5.000, 940 A5.000	1956	24x199		SK-1586AQ1	BTKW
2.0 JTD, 2.0 JTD 4x4	08/11-	939 B5.000, 939 B5.000, 940 A5.000	1956			0-N115	TB [TE]
2.0 JTD, 2.0 JTD 4x4	08/11-	939 B5.000, 939 B5.000, 940 A5.000	1956			0-N2149	TB [DG]
2.4	08/11-	ED3, EDG	2360			0-N2048	VB [DG]
2.4	08/11-	ED3, EDG	2360			0-N2112	VB [BT] S

PUNTO Van (199)							
1.4	04/08-	350 A1.000	1368	22x129; → 06/2008		SK-1677AQ1	BTKW
1.4, 1.4 LPG, 1.4 Natural Power	04/08-	350 A1.000	1368	22x129		SK-1677	BTK
1.4, 1.4 LPG, 1.4 Natural Power	04/08-	350 A1.000	1368			0-N1616	TB [TE]
1.3 D Multijet	03/09-	199 B1.000	1248			0-N2390	VB [BT] S

IDEA (350_)							
1.2 16V	01/04-	188 A5.000	1242	22x124; Baumuster: 350		SK-1412	BTK
1.2 16V	01/04-	188 A5.000	1242	22x124		SK-1412AQ2	BTKW
1.4	10/05-	350 A1.000	1368	22x129; → 06/2008		SK-1677AQ1	BTKW
1.4, 1.4 16V	12/03-	192 B2.000, 843 A1.000	1368	22x124; Baumuster: 350		SK-1412	BTK
1.4, 1.4 16V	12/03-	192 B2.000, 843 A1.000	1368	22x124		SK-1412AQ2	BTKW
1.4, 1.4 LPG	10/05-	350 A1.000	1368	22x129		SK-1677	BTK
1.6 D Multijet	05/08-	350 A2.000	1598	24x194; 07/2008 →		SK-1693	BTK
1.6 D Multijet	05/08-	350 A2.000	1598	24x194		SK-1693AQ1	BTKW
1.9 JTD	01/04-	188 B2.000	1910	24x190; mit Zubehör		SK-1629	BTK
1.9 JTD	01/04-	188 B2.000	1910	24x190; mit Zubehör		SK-1629AQ1	BTKW
1.2 16V	01/04-	188 A5.000	1242			0-N195	TB [TE]
1.4, 1.4 16V	12/03-	192 B2.000, 843 A1.000	1368			0-N195	TB [TE]
1.4, 1.4 LPG	10/05-	350 A1.000	1368			0-N1616	TB [TE]
1.6 D Multijet	05/08-	350 A2.000	1598			0-N115	TB [TE]
1.9 JTD	01/04-	188 B2.000	1910			0-N115	TB [TE]
1.9 JTD	01/04-	188 B2.000	1910	→ 06/2004		0-N1326	TB [DG]
1.9 JTD	01/04-	188 B2.000	1910	06/2004 →		0-N2149	TB [DG]
1.2 16V	01/04-	188 A5.000	1242			0-N1517	VB [BT] S
1.3 D Multijet, 1.3 JTD	01/04-	188 A9.000, 199 A3.000, 199 B1.000	1248			0-N1478S	VB [TE]
1.3 D Multijet, 1.3 JTD	01/04-	188 A9.000, 199 A3.000	1248	☞ sequentiell		0-N1526	VB [BT] S
1.4, 1.4 16V, 1.4 LPG	12/03-	192 B2.000, 350 A1.000, 843 A1.000	1368			0-N1517	VB [BT] S
1.9 JTD	01/04-	188 B2.000	1910			0-N1408	VB [DG]
1.9 JTD	01/04-	188 B2.000	1910			0-N1415	VB [DG]
1.9 JTD	01/04-	188 B2.000	1910			0-N1487	VB [BT] S

LINEA (323)							
1.4	06/07-	350 A1.000	1368	22x129		SK-1677	BTK
1.4	06/07-	350 A1.000	1368	22x129; → 06/2008		SK-1677AQ1	BTKW
1.4 T-Jet	09/07-	198 A4.000	1368	22x124; Baumuster: 323		SK-1412	BTK
1.4 T-Jet	09/07-	198 A4.000	1368	22x124		SK-1412AQ2	BTKW
1.6 D Multijet	06/09-	198 A3.000	1598	24x194		SK-1693	BTK
1.6 D Multijet	06/09-	198 A3.000	1598	24x194		SK-1693AQ1	BTKW
1.4	06/07-	350 A1.000	1368			0-N1616	TB [TE]
1.4 T-Jet	09/07-	198 A4.000	1368			0-N195	TB [TE]
1.6 D Multijet	06/09-	198 A3.000	1598			0-N115	TB [TE]
1.6 D Multijet	06/09-	198 A3.000	1598			0-N2149	TB [DG]



OPTIMAL®

FIAT



CM³



Art. Nr.



LINEA (323)

1.3 D Multijet	06/07-	199 A3.000	1248		0-N1478S	VB [TE]	
1.3 D Multijet	06/07-	199 A3.000	1248	sequentiell	0-N1526	VB [BT]	S
1.3 D Multijet	09/09-	199 A3.000	1248		0-N2390	VB [BT]	S
1.4, 1.4 T-Jet	06/07-	198 A4.000, 350 A1.000	1368		0-N1517	VB [BT]	S
1.6 D Multijet	06/09-	198 A3.000	1598		0-N1503	VB [BT]	S
1.6 D Multijet	06/09-	198 A3.000	1598		0-N1522	VB [DG]	
1.6 D Multijet	06/09-	198 A3.000	1598		0-N2049	VB [DG]	

MAREA (185)

1.2 16V	10/98-05/02	182 B2.000	1242	22x124; 03/1999 →	SK-1412	BTK	
1.2 16V	10/98-05/02	182 B2.000	1242	22x124; 03/1999 → 04/1999	SK-1412AQ1	BTKW	
1.2 16V	10/98-05/02	182 B2.000	1242	22x124; 04/1999 →	SK-1412AQ2	BTKW	
1.4 80 12V	09/96-05/02	182 A3.000	1370	18x134	SK-1345	BTK	
1.6	09/00-08/02	182 B6.000	1596	25x158	SK-1076	BTK	
1.6, 1.6 100 16V, 1.6 100 16V Bipower, 1.6 16V, 1.6 SX	09/96-08/02	182 A4.000, 182 B5.098, 185 A3.000, 185 A3.000, 186 A4.000	1581	25x158	SK-1076	BTK	
1.8 115 16V	09/96-05/02	182 A2.000	1747	24x168	SK-1410	BTK	
1.8 115 16V	09/96-05/02	182 A2.000	1747	24x168	SK-1410AQ1	BTKW	
1.9 JTD 105, 1.9 JTD 110	04/99-05/02	182 B4.000, 186 A6.000	1910	24x190; mit Zubehör	SK-1629	BTK	
1.9 JTD 105, 1.9 JTD 110	04/99-05/02	182 B4.000, 186 A6.000	1910	24x190; mit Zubehör	SK-1629AQ1	BTKW	
1.9 TD 100, 1.9 TD 75	09/96-05/02	182 A7.000, 182 A8.000	1910	24x193; mit Zubehör	SK-1646	BTK	
1.9 TD 100, 1.9 TD 75	09/96-05/02	182 A7.000, 182 A8.000	1910	24x193	SK-1646AQ1	BTKW	
2.0 150 20V	01/01-05/02	185 A8.000	1998	24x166; → 06/2006	SK-1637	BTK	
2.0 150 20V, 2.0 155 20V	09/96-01/01	182 A1.000, 182 B7.000	1998	24x167	SK-1411	BTK	
2.4 JTD 130	04/99-05/02	185 A6.000	2387	24x190; Baumuster: 185	SK-1112	BTK	
2.4 JTD 130	04/99-05/02	185 A6.000	2387	24x190	SK-1112AQ1	BTKW	
2.4 TD 125	09/96-04/99	185 A2.000	2387	24x193	SK-1080	BTK	
2.4 TD 125	09/96-04/99	185 A2.000	2387	24x193; mit Zubehör	SK-1646	BTK	
2.4 TD 125	09/96-04/99	185 A2.000	2387	24x193	SK-1646AQ1	BTKW	
1.2 16V	10/98-05/02	182 B2.000	1242		0-N195	TB [TE]	
1.4 80 12V	09/96-05/02	182 A3.000	1370		0-N113	TB [TE]	
1.6 100 16V, 1.6 100 16V Bipower	09/96-05/02	182 A4.000, 185 A3.000, 186 A4.000	1581		0-N208	TB [TE]	
1.6 100 16V, 1.6 100 16V Bipower	09/96-05/02	182 A4.000, 185 A3.000, 186 A4.000	1581		0-N951	TB [DG]	
1.8 115 16V	09/96-05/02	182 A2.000	1747		0-N194	TB [TE]	
1.8 115 16V	09/96-05/02	182 A2.000	1747		0-N938	TB [DG]	
1.9 JTD 105, 1.9 JTD 110, 1.9 TD 100, 1.9 TD 75	09/96-05/02	182 A7.000, 182 A8.000, 182 B4.000, 186 A6.000	1910		0-N115	TB [TE]	
1.9 JTD 105, 1.9 JTD 110, 1.9 TD 100, 1.9 TD 75	09/96-05/02	182 A7.000, 182 A8.000, 182 B4.000, 186 A6.000	1910		0-N1326	TB [DG]	
2.0 150 20V, 2.0 155 20V	09/96-05/02	182 A1.000, 182 B7.000, 185 A8.000	1998		0-N196	TB [TE]	
2.0 150 20V, 2.0 155 20V	09/96-05/02	182 A1.000, 182 B7.000, 185 A8.000	1998		0-N950	TB [DG]	
2.4 JTD 130, 2.4 TD 125	09/96-05/02	185 A2.000, 185 A6.000, 839 A5.000	2387		0-N115	TB [TE]	
2.4 JTD 130, 2.4 TD 125	09/96-05/02	185 A2.000, 185 A6.000, 839 A5.000	2387		0-N950	TB [DG]	
1.4 80 12V	09/96-05/02	182 A3.000	1370		0-N1403	VB [DG]	
1.4 80 12V	09/96-05/02	182 A3.000	1370		0-N1407	VB [BT]	S
1.6 100 16V, 1.6 100 16V Bipower	09/96-05/02	182 A4.000, 185 A3.000, 186 A4.000	1581	03/2000 →	0-N1450	VB [DG]	
1.6 100 16V, 1.6 100 16V Bipower	09/96-05/02	182 A4.000, 185 A3.000, 186 A4.000	1581	→ 02/2000	0-N187	VB [DG]	
1.8 115 16V	09/96-05/02	182 A2.000	1747		0-N1403	VB [DG]	
1.8 115 16V	09/96-05/02	182 A2.000	1747		0-N1407	VB [BT]	S
1.9 JTD 105, 1.9 JTD 110	04/99-05/02	182 B4.000, 186 A6.000	1910		0-N1487	VB [BT]	S
1.9 JTD 105, 1.9 JTD 110, 1.9 TD 100, 1.9 TD 75	09/96-05/02	182 A7.000, 182 A8.000, 182 B4.000, 186 A6.000	1910		0-N1415	VB [DG]	
1.9 TD 100	09/96-05/02	182 A7.000	1910		0-N1407	VB [BT]	S
1.9 TD 75	09/96-05/02	182 A8.000	1910	ENGINE: → 1865932	0-N1407	VB [BT]	S
2.0 150 20V	09/96-04/99	182 A1.000	1998	ENGINE: 1140488 →	0-N1596	VB [DG]	
2.0 150 20V	09/96-04/99	182 A1.000	1998	ENGINE: → 1140487	0-N1630	VB [DG]	
2.0 150 20V, 2.0 155 20V	09/96-05/02	182 A1.000, 182 B7.000, 185 A8.000	1998		0-N1599	VB [BT]	S
2.0 150 20V, 2.0 155 20V	09/96-05/02	182 A1.000, 182 B7.000, 185 A8.000	1998		0-N1916	VB [BT]	
2.0 150 20V, 2.0 155 20V	09/96-05/02	182 A1.000, 182 B7.000, 185 A8.000	1998		0-N1966	VB [DG]	
2.0 150 20V, 2.0 155 20V	04/99-05/02	182 B7.000, 185 A8.000	1998		0-N1596	VB [DG]	
2.4 JTD 130	04/99-05/02	185 A6.000, 839 A5.000	2387		0-N1894	VB [BT]	
2.4 JTD 130, 2.4 TD 125	09/96-05/02	185 A2.000, 185 A6.000, 839 A5.000	2387		0-N1404	VB [DG]	
2.4 JTD 130, 2.4 TD 125	09/96-05/02	185 A2.000, 185 A6.000, 839 A5.000	2387		0-N1490S	VB [TE]	
2.4 JTD 130, 2.4 TD 125	09/96-05/02	185 A2.000, 185 A6.000, 839 A5.000	2387		0-N1916	VB [BT]	
2.4 TD 125	09/96-04/99	185 A2.000	2387	ENGINE: → 543351	0-N1652	VB [BT]	
2.4 TD 125	09/96-04/99	185 A2.000	2387	ENGINE: 543352 →	0-N1894	VB [BT]	



CM³



Art. Nr.



ohne Halter

MAREA Weekend (185)

1.2 16V	10/98-05/02	182 B2.000	1242	22x124	SK-1412	BTK
1.2 16V	10/98-05/02	182 B2.000	1242	22x124; → 04/1999	SK-1412AQ1	BTKW
1.2 16V	10/98-05/02	182 B2.000	1242	22x124; 04/1999 →	SK-1412AQ2	BTKW
1.4 80 12V	09/96-05/02	182 A3.000	1370	18x134	SK-1345	BTK
1.6	09/00-08/02	182 B6.000	1596	25x158	SK-1076	BTK
1.6 100 16V	09/96-05/02	182 A4.000	1581	25x158	SK-1076	BTK
1.8 115 16V	09/96-05/02	182 A2.000	1747	24x168	SK-1410	BTK
1.8 115 16V	09/96-05/02	182 A2.000	1747	24x168	SK-1410AQ1	BTKW
1.9 JTD 105, 1.9 JTD 110	04/99-05/02	182 B4.000, 186 A6.000	1910	24x190; mit Zubehör	SK-1629	BTK
1.9 JTD 105, 1.9 JTD 110	04/99-05/02	182 B4.000, 186 A6.000	1910	24x190; mit Zubehör	SK-1629AQ1	BTKW
1.9 TD 100	09/96-05/02	182 B9.000	1910	24x190; mit Zubehör	SK-1629	BTK
1.9 TD 100	09/96-05/02	182 B9.000	1910	24x190; mit Zubehör	SK-1629AQ1	BTKW
1.9 TD 100	09/96-05/02	182 A7.000	1910	24x193; mit Zubehör	SK-1646	BTK
1.9 TD 100	09/96-05/02	182 A7.000	1910	24x193	SK-1646AQ1	BTKW
1.9 TD 75	09/96-05/02	182 A8.000	1910	24x193; mit Zubehör	SK-1646	BTK
1.9 TD 75	09/96-05/02	182 A8.000	1910	24x193	SK-1646AQ1	BTKW
2.0 150 20V	01/01-05/02	185 A8.000	1998	24x166; → 08/2002	SK-1637	BTK
2.0 150 20V, 2.0 155 20V	09/96-02/03	182 A1.000, 182 B7.000	1998	24x167	SK-1411	BTK
2.4 JTD 130	04/99-05/02	185 A6.000	2387	24x190; Baumuster: 185	SK-1112	BTK
2.4 JTD 130	04/99-05/02	185 A6.000	2387	24x190	SK-1112AQ1	BTKW
2.4 TD 125	09/96-04/99	185 A2.000	2387	24x193	SK-1080	BTK
2.4 TD 125	09/96-04/99	185 A2.000	2387	24x193; mit Zubehör	SK-1646	BTK
2.4 TD 125	09/96-04/99	185 A2.000	2387	24x193	SK-1646AQ1	BTKW
1.2 16V	10/98-05/02	182 B2.000	1242		0-N195	TB [TE]
1.4 80 12V	09/96-05/02	182 A3.000	1370		0-N113	TB [TE]
1.6 100 16V	09/96-05/02	182 A4.000	1581		0-N208	TB [TE]
1.6 100 16V	09/96-05/02	182 A4.000	1581		0-N951	TB [DG]
1.8 115 16V	09/96-05/02	182 A2.000	1747		0-N194	TB [TE]
1.8 115 16V	09/96-05/02	182 A2.000	1747		0-N938	TB [DG]
1.9 JTD 105, 1.9 JTD 110, 1.9 TD 100, 1.9 TD 75	09/96-05/02	182 A7.000, 182 B9.000, 182 A8.000, 182 B4.000, 186 A6.000	1910		0-N115	TB [TE]
1.9 JTD 105, 1.9 JTD 110, 1.9 TD 100, 1.9 TD 75	09/96-05/02	182 A7.000, 182 B9.000, 182 A8.000, 182 B4.000, 186 A6.000	1910		0-N1326	TB [DG]
2.0 150 20V, 2.0 155 20V	09/96-02/03	182 A1.000, 182 B7.000, 185 A8.000	1998		0-N196	TB [TE]
2.0 150 20V, 2.0 155 20V	09/96-02/03	182 A1.000, 182 B7.000, 185 A8.000	1998		0-N950	TB [DG]
2.4 JTD 130, 2.4 TD 125	09/96-05/02	185 A2.000, 185 A6.000, 839 A5.000	2387		0-N115	TB [TE]
2.4 JTD 130, 2.4 TD 125	09/96-05/02	185 A2.000, 185 A6.000, 839 A5.000	2387		0-N950	TB [DG]
1.4 80 12V	09/96-05/02	182 A3.000	1370		0-N1403	VB [DG]
1.4 80 12V	09/96-05/02	182 A3.000	1370		0-N1407	VB [BT] S
1.6 100 16V	09/96-05/02	182 A4.000	1581	03/2000 →	0-N1450	VB [DG]
1.6 100 16V	09/96-05/02	182 A4.000	1581	→ 02/2000	0-N187	VB [DG]
1.8 115 16V	09/96-05/02	182 A2.000	1747		0-N1403	VB [DG]
1.8 115 16V	09/96-05/02	182 A2.000	1747		0-N1407	VB [BT] S
1.9 JTD 105, 1.9 JTD 110	04/99-05/02	182 B4.000, 186 A6.000	1910		0-N1487	VB [BT] S
1.9 JTD 105, 1.9 JTD 110, 1.9 TD 100, 1.9 TD 75	09/96-05/02	182 A7.000, 182 B9.000, 182 A8.000, 182 B4.000, 186 A6.000	1910		0-N1415	VB [DG]
1.9 TD 100	09/96-05/02	182 A7.000	1910		0-N1407	VB [BT] S
1.9 TD 75	09/96-05/02	182 A8.000	1910	: →1865932	0-N1407	VB [BT] S
2.0 150 20V	09/96-04/99	182 A1.000	1998	: →1140488 →	0-N1596	VB [DG]
2.0 150 20V	09/96-04/99	182 A1.000	1998	: →1140487	0-N1630	VB [DG]
2.0 150 20V, 2.0 155 20V	09/96-02/03	182 A1.000, 182 B7.000, 185 A8.000	1998		0-N1599	VB [BT] S
2.0 150 20V, 2.0 155 20V	09/96-02/03	182 A1.000, 182 B7.000, 185 A8.000	1998		0-N1916	VB [BT]
2.0 150 20V, 2.0 155 20V	09/96-02/03	182 A1.000, 182 B7.000, 185 A8.000	1998		0-N1966	VB [DG]
2.0 150 20V, 2.0 155 20V	04/99-02/03	182 B7.000, 185 A8.000	1998		0-N1596	VB [DG]
2.4 JTD 130	04/99-05/02	185 A6.000, 839 A5.000	2387		0-N1894	VB [BT]
2.4 JTD 130, 2.4 TD 125	09/96-05/02	185 A2.000, 185 A6.000, 839 A5.000	2387		0-N1404	VB [DG]
2.4 JTD 130, 2.4 TD 125	09/96-05/02	185 A2.000, 185 A6.000, 839 A5.000	2387		0-N1490S	VB [TE]
2.4 JTD 130, 2.4 TD 125	09/96-05/02	185 A2.000, 185 A6.000, 839 A5.000	2387		0-N1916	VB [BT]
2.4 TD 125	09/96-04/99	185 A2.000	2387	: →543351	0-N1652	VB [BT]
2.4 TD 125	09/96-04/99	185 A2.000	2387	: →543352 →	0-N1894	VB [BT]

MULTIPLA (186)

1.6 100 16V, 1.6 16V Bipower, 1.6 16V Blupower	04/99-06/10	182 A4.000, 186 A3.000, 186 A4.000	1581	25x158	SK-1076	BTK
1.6, 1.6 16V, 1.6 16V Bipower	09/00-06/10	182 B6.000	1596	25x158	SK-1076	BTK
1.9 JTD, 1.9 JTD 105, 1.9 JTD 110, 1.9 JTD 115	04/99-06/10	182 B4.000, 186 A6.000, 186 A8.000, 186 A9.000	1910	24x190; mit Zubehör	SK-1629	BTK

CM³

Art. Nr.

**MULTIPLA (186)**

1.9 JTD , 1.9 JTD 105 , 1.9 JTD 110, 1.9 JTD 115	04/99-06/10	182 B4.000, 186 A6.000, 186 A8.000, 186 A9.000	1910	24x190; mit Zubehör	SK-1629AQ1	BTKW	
1.6 100 16V , 1.6 16V Bipower , 1.6 16V Blupower	04/99-06/10	182 A4.000, 186 A3.000, 186 A4.000	1581		0-N208	TB [TE]	
1.6 100 16V , 1.6 16V Bipower , 1.6 16V Blupower	04/99-06/10	182 A4.000, 186 A3.000, 186 A4.000	1581		0-N951	TB [DG]	
1.6, 1.6 16V , 1.6 16V Bipower	09/00-06/10	182 B6.000	1596		0-N208	TB [TE]	
1.6, 1.6 16V , 1.6 16V Bipower	09/00-06/10	182 B6.000	1596		0-N951	TB [DG]	
1.9 JTD , 1.9 JTD 105	04/99-06/10	182 B4.000, 186 A9.000	1910		0-N1326	TB [DG]	
1.9 JTD , 1.9 JTD 105 , 1.9 JTD 110, 1.9 JTD 115	04/99-06/10	182 B4.000, 186 A6.000, 186 A8.000, 186 A9.000	1910		0-N115	TB [TE]	
1.9 JTD 110	03/01-07/02	186 A6.000	1910	→4114649	0-N1326	TB [DG]	
1.9 JTD 110	03/01-07/02	186 A6.000	1910	→4114650→	0-N2149	TB [DG]	
1.9 JTD 115	07/02-06/10	186 A8.000	1910	→04114649	0-N1326	TB [DG]	
1.9 JTD 115	07/02-06/10	186 A8.000	1910	→04114650→	0-N2149	TB [DG]	
1.6 100 16V , 1.6 16V Bipower , 1.6 16V Blupower	04/99-06/10	182 A4.000, 186 A3.000, 186 A4.000	1581	02/2000 →	0-N1450	VB [DG]	
1.6 100 16V , 1.6 16V Blupower	04/99-06/10	182 A4.000, 186 A3.000	1581	→ 06/2001	0-N187	VB [DG]	
1.6 16V Bipower	04/99-06/10	186 A4.000	1581	→ 02/2000	0-N187	VB [DG]	
1.6, 1.6 16V , 1.6 16V Bipower	09/00-06/10	182 B6.000	1596		0-N1450	VB [DG]	
1.9 JTD , 1.9 JTD 105 , 1.9 JTD 110, 1.9 JTD 115	04/99-06/10	182 B4.000, 186 A6.000, 186 A8.000, 186 A9.000	1910		0-N1415	VB [DG]	
1.9 JTD , 1.9 JTD 105 , 1.9 JTD 110, 1.9 JTD 115	04/99-06/10	182 B4.000, 186 A6.000, 186 A8.000, 186 A9.000	1910		0-N1487	VB [BT]	S

PALIO (178BX)

1.1	07/97-10/03	178 B9.033	1108	15x125; →9042884 →	SK-1421	BTK	
1.1	07/97-10/03	178 B9.033	1108	15x125; →9042884 →	SK-1421AQ1	BTKW	
1.1	07/97-10/03	178 B9.033	1108	15x104; →9042883	SK-1665	BTK	
1.2	07/97-08/02	178 B7.045, 178 C4.066	1242	15x108; →9042883	SK-1043	BTK	
1.2	07/97-08/02	188 A4.000	1242	15x129	SK-1418	BTK	
1.2	07/97-08/02	178 C4.066	1242	15x129; →2533527 →	SK-1418	BTK	
1.2	07/97-08/02	188 A4.000	1242	15x129	SK-1418AQ1	BTKW	
1.2	07/97-08/02	178 B7.045	1242	15x129; →9042884 →	SK-1418AQ1	BTKW	
1.2	06/98-10/00	176 A8.000, 178 B5.000, 178 E2.000, 178 E2.000	1242	15x108; →9042883	SK-1043	BTK	
1.2	06/98-	176 A8.000, 178 B5.000, 178 E2.000	1242	15x108; → 03/1999; →9042883	SK-1043AQ1	BTKW	
1.2	06/98-10/00	176 A8.000, 178 B5.000, 178 E2.000, 178 E2.000	1242	15x129; →9042884 →	SK-1418	BTK	
1.2	06/98-10/00	176 A8.000, 178 B5.000, 178 E2.000, 178 E2.000	1242	15x129; →9042884 →	SK-1418AQ1	BTKW	
1.2	09/01-	188 A5.000	1242	22x124; Baumuster: 178	SK-1412	BTK	
1.2	09/01-	188 A5.000	1242	22x124	SK-1412AQ2	BTKW	
1.6 16V	04/96-	178 B3.000	1581	25x158	SK-1076	BTK	
1.7 TD	02/97-10/03	176 A3.000, 176 A5.000	1697	22x168	SK-1032	BTK	
1.0	04/96-		994		0-N822	TB [TE]	
1.1	07/97-10/03	178 B9.033	1108		0-N822	TB [TE]	
1.2	07/97-08/02	178 C4.066	1242	→2533529 →	0-N1616	TB [TE]	
1.2	07/97-08/02	188 A4.000	1242		0-N822	TB [TE]	
1.2	07/97-08/02	178 C4.066	1242	→2533528	0-N822	TB [TE]	
1.2	06/98-	176 A8.000, 178 B5.000, 178 E2.000	1242		0-N822	TB [TE]	
1.2	09/01-	188 A5.000	1242		0-N195	TB [TE]	
1.4	10/05-	178 F3.011, 350 A1.000	1368		0-N1616	TB [TE]	
1.4, 1.4 KAT	04/96-	178 B2.000, 178 B2.016	1372		0-N822	TB [TE]	
1.7 TD	02/97-10/03	176 A3.000, 176 A5.000	1697		0-N819	TB [TE]	
1.7 TD	02/97-10/03	176 A3.000, 176 A5.000	1697		0-N820	TB [DG]	
1.9 D	09/00-	223 A6.000	1910		0-N115	TB [TE]	
1.9 D	09/00-	223 A6.000	1910		0-N1326	TB [DG]	
1.2	07/97-08/02	188 A4.000	1242	✳	0-N1399	VB [DG]	
1.2	07/97-08/02	188 A4.000	1242		0-N1517	VB [BT]	S
1.5	06/04-	178 E5.022	1461	für Fahrzeuge mit Servolenkung	0-N1522	VB [DG]	
1.5	06/04-	178 E5.022	1461	für Fahrzeuge ohne Servolenkung	0-N1522	VB [DG]	
1.5	06/04-	178 E5.022	1461		0-N1842	VB [BT]	S
1.7 TD	02/97-10/03	176 A3.000, 176 A5.000	1697		0-N1634	VB [DG]	
1.9 D	09/00-	223 A6.000	1910		0-N1487	VB [BT]	S

PALIO Weekend (178DX)

1.2	04/96-10/02	178 B5.000, 178 E2.000	1242	15x108; →9042883	SK-1043	BTK	
1.2	04/96-02/01	178 B5.000	1242	15x108; → 03/1999; →9042883	SK-1043AQ1	BTKW	

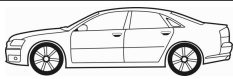

CM³



Art. Nr.



PALIO Weekend (178DX)

1.2	04/96-10/02	178 B5.000, 178 E2.000	1242	15x129; :9042884 →	SK-1418	BTK	
1.2	04/96-10/02	178 B5.000, 178 E2.000	1242	15x129; :9042884 →	SK-1418AQ1	BTKW	
1.2	02/01-	188 A4.000	1242	15x129	SK-1418	BTK	
1.2	02/01-	178 C4.066	1242	15x129; :→2533527	SK-1418	BTK	
1.2	02/01-	178 C4.066, 188 A4.000	1242	15x129	SK-1418AQ1	BTKW	
1.2	09/01-	188 A5.000	1242	22x124; Baumuster: 178	SK-1412	BTK	
1.2	09/01-	188 A5.000	1242	22x124	SK-1412AQ2	BTKW	
1.6 16V	04/96-02/01	178 B3.000	1581	25x158	SK-1076	BTK	
1.6 16V	02/01-	182 B6.000	1596	25x158	SK-1076	BTK	
1.7 TD	04/96-03/01	176 A3.000	1698	22x168; 07/1997 →	SK-1032	BTK	
1.9 D	03/01-	223 A6.000	1910	24x193; mit Zubehör	SK-1646	BTK	
1.9 D	03/01-	223 A6.000	1910	24x193	SK-1646AQ1	BTKW	
1.9 JTD	09/01-	188 A2.000	1910	24x190; mit Zubehör	SK-1629	BTK	
1.9 JTD	09/01-	188 A2.000	1910	24x190; mit Zubehör	SK-1629AQ1	BTKW	
1.2	09/01-	188 A5.000	1242		0-N195	TB [TE]	
1.2, 1.2 Biopower	04/96-12/05	178 B5.000, 178 C4.066, 188 A4.000, 178 E9.011	1242		0-N822	TB [TE]	
1.4	07/97-08/01	178 B2.000	1372		0-N822	TB [TE]	
1.4 Biopower	02/05-	310 A2.011	1368		0-N1616	TB [TE]	
1.6 16V	04/96-02/01	178 B3.000	1581		0-N208	TB [TE]	
1.6 16V	04/96-02/01	178 B3.000	1581		0-N951	TB [DG]	
1.6 16V	02/01-	182 B6.000	1596		0-N208	TB [TE]	
1.6 16V	02/01-	182 B6.000	1596		0-N951	TB [DG]	
1.7 TD	04/96-03/01	176 A3.000	1698		0-N819	TB [TE]	
1.7 TD	04/96-03/01	176 A3.000	1698		0-N820	TB [DG]	
1.9 D, 1.9 JTD	03/01-	188 A2.000, 223 A6.000	1910		0-N115	TB [TE]	
1.9 D, 1.9 JTD	03/01-	188 A2.000, 223 A6.000	1910		0-N1326	TB [DG]	
1.2	02/01-	178 C4.066, 188 A4.000, 188 A5.000	1242		0-N1399	VB [DG]	
1.2	02/01-	178 C4.066, 188 A4.000, 188 A5.000	1242		0-N1517	VB [BT]	S
1.5	02/02-	178 E5.022	1461	für Fahrzeuge mit Servolenkung	0-N1522	VB [DG]	
1.5	02/02-	178 E5.022	1461	für Fahrzeuge ohne Servolenkung	0-N1522	VB [DG]	
1.5	02/02-	178 E5.022	1461		0-N1842	VB [BT]	S
1.6 16V	04/96-02/01	178 B3.000	1581	02/2000 →	0-N1450	VB [DG]	
1.6 16V	04/96-02/01	178 B3.000	1581	→ 02/2000	0-N187	VB [DG]	
1.6 16V	02/01-	182 B6.000	1596		0-N1450	VB [DG]	
1.7 TD	04/96-03/01	176 A3.000	1698		0-N1634	VB [DG]	
1.7 TD	04/96-03/01	176 A3.000	1698		0-N187	VB [DG]	
1.9 D, 1.9 JTD	03/01-	188 A2.000, 223 A6.000	1910		0-N1415	VB [DG]	
1.9 D, 1.9 JTD	03/01-	188 A2.000, 223 A6.000	1910		0-N1487	VB [BT]	S

PANDA (141A_)

1000 4x4, 1000 i.e. KAT	01/86-08/98	141 C2.000, 156 A2.246, 156 A2.100, 156 A3.100, 156 A3.000	999	15x104; :→9042883	SK-1023	BTK	
1000 4x4, 1000 i.e. KAT	01/86-08/98	141 C2.000, 156 A2.246, 156 A2.100, 156 A3.100, 156 A3.000	999	15x125; :9042884 →	SK-1421	BTK	
1000 i.e. KAT	10/87-08/98	141 C2.000, 156 A2.246	999	15x125; :9042884 →	SK-1421AQ1	BTKW	
1000, 1000 4x4	01/85-12/94	141 C2.000, 156 A2.246, 156 A2.100, 156 A3.000	999	15x104	SK-1023	BTK	
1000, 1000 4x4, 1000 i.e. KAT	01/85-08/98	141 C2.000, 156 A2.246, 156 A2.100, 156 A2.100, 156 A3.100, 156 A3.000	999	15x104; :→9042883	SK-1665AQ1	BTKW	
1100	02/95-09/03	187 A1.000	1108	15x125	SK-1421	BTK	
1100	02/95-09/03	176 B2.000	1108	15x125; :9042884 →	SK-1421	BTK	
1100	02/95-09/03	176 B2.000	1108	15x125; :9042884 →	SK-1421AQ1	BTKW	
1100	02/95-09/03	187 A1.000	1108	15x125; :9042884 →	SK-1421AQ1	BTKW	
1100	02/95-09/03	176 B2.000	1108	15x104; :→9042883	SK-1665	BTK	
1100	02/95-09/03	176 B2.000	1108	15x104; 04/1999 →; :→9042882	SK-1665AQ2	BTKW	
1100	02/95-09/03	187 A1.000	1108	22x125; :2533529 →	SK-1676	BTK	
1100 4x4	02/95-07/04	176 B2.000	1108	15x104; :→9042883	SK-1665	BTK	
1100 4x4	02/95-07/04	176 B2.000	1108	15x104; 04/1999 →; :→9042883	SK-1665AQ2	BTKW	
1100, 1100 4x4, 1100 Trekking 4x4	05/91-07/04	156 C.046, 176 B2.000, 176 B2.000, 187 A1.000	1108	15x104; :→9042883	SK-1023	BTK	
1100, 1100 4x4, 1100 Trekking 4x4	05/91-07/04	156 C.046, 176 B2.000	1108	15x125; :9042884 →	SK-1421	BTK	
1100, 1100 4x4, 1100 Trekking 4x4	05/91-07/04	156 C.046, 176 B2.000	1108	15x125; :9042884 →	SK-1421AQ1	BTKW	
1100, 1100 4x4, 1100 Trekking 4x4	05/91-07/04	156 C.046, 176 B2.000, 176 B2.000, 187 A1.000	1108	15x104; → 03/1999; :→9042883	SK-1665AQ1	BTKW	
750	01/86-01/95	141 B.000	770	15x104	SK-1023	BTK	
750	01/86-10/03	141 B.000, 156 A4.000, 156 A4.048, 156 A4.048	770	15x104; :→9042883	SK-1023	BTK	



OPTIMAL®

FIAT



CM³



Art. Nr.



PANDA (141A_)							
750	01/86-10/03	141 B.000, 156 A4.000, 156 A4.048, 156 A4.048	770	15x125; :9042884→	SK-1421	BTK	
750	01/86-01/95	141 B.000, 156 A4.000, 156 A4.048	770	15x104; :→9042883	SK-1665AQ1	BTKW	
1000, 1000 4x4, 1000 i.e. KAT	01/85-08/98	141 C2.000, 156 A2.246, 156 A2.100, 156 A2.100, 156 A3.100, 156 A3.000	999		0-N822	TB [TE]	
1100	02/95-09/03	187 A1.000	1108	:2533529→	0-N1616	TB [TE]	
1100	02/95-09/03	176 B2.000	1108		0-N822	TB [TE]	
1100	02/95-09/03	187 A1.000	1108	:→2533528	0-N822	TB [TE]	
1100, 1100 4x4, 1100 Trekking 4x4	05/91-07/04	156 C.046, 176 B2.000	1108		0-N822	TB [TE]	
750	01/86-10/03	141 B.000, 141 B.000, 156 A4.000, 156 A4.048, 156 A4.048	770		0-N822	TB [TE]	
1100	02/95-09/03	187 A1.000	1108		0-N1517	VB [BT]	S

PANDA Van (141_)							
1.1	05/91-03/95	156 C.046	1108	15x104; :→9042883	SK-1023	BTK	
1.1	05/91-03/95	156 C.046	1108	15x125; :9042884→	SK-1421	BTK	
1.1, 1.1 4x4	05/91-02/04	156 C.046, 187 A1.000	1108	15x125; :9042884→	SK-1421AQ1	BTKW	
1.1, 1.1 4x4	09/00-02/04	187 A1.000	1108	15x125	SK-1421	BTK	
1.1, 1.1 4x4	09/00-02/04	187 A1.000	1108	22x125; :2533529→	SK-1676	BTK	
1000 i.e	08/92-02/04	156 A2.246	999	15x125; :9042884→	SK-1421AQ1	BTKW	
1000, 1000 i.e	01/86-02/04	156 A2.100, 156 A3.100, 156 A2.246	999	15x104; :→9042883	SK-1023	BTK	
1000, 1000 i.e	01/86-02/04	156 A2.100, 156 A3.100, 156 A2.246	999	15x125; :9042884→	SK-1421	BTK	
1000, 1000 i.e	01/86-02/04	156 A2.100, 156 A3.100, 156 A2.246	999	15x104; :→9042883	SK-1665AQ1	BTKW	
750	01/86-07/92	141 B.000	764	15x104	SK-1023	BTK	
1.1	05/91-03/95	156 C.046	1108		0-N822	TB [TE]	
1.1, 1.1 4x4	09/00-02/04	187 A1.000	1108	:2533529→	0-N1616	TB [TE]	
1.1, 1.1 4x4	09/00-02/04	187 A1.000	1108	:→2533528	0-N822	TB [TE]	
1000, 1000 i.e	01/86-02/04	156 A2.100, 156 A3.100, 156 A2.246	999		0-N822	TB [TE]	
750	01/86-07/92	141 B.000	764		0-N822	TB [TE]	
1.1	09/00-02/04	187 A1.000	1108		0-N1517	VB [BT]	S

PANDA (169)							
1.1	09/03-	187 A1.000	1108	15x125; :→2533527	SK-1421	BTK	
1.1	09/03-	187 A1.000	1108	15x125; :→2533527	SK-1421AQ1	BTKW	
1.1	09/03-	187 A1.000	1108	22x125; :2533528→	SK-1676	BTK	
1.1	09/03-	187 A1.000	1108	22x125; :2533528→	SK-1676AQ1	BTKW	
1.2 4x4	11/09-	169 A4.000	1242	22x129; 04/2010 →	SK-1677	BTK	
1.2, 1.2 4x4	09/03-	188 A4.000	1242	22x129; :2533529→	SK-1677	BTK	
1.2, 1.2 4x4, 1.2 Bi-Power / Natural Power	09/03-11/09	188 A4.000	1242	22x129; → 06/2008; :2533529→	SK-1677AQ1	BTKW	
1.2, 1.2 4x4, 1.2 Bi-Power / Natural Power, 1.2 LPG	09/03-11/09	188 A4.000	1242	15x129; :→2533528	SK-1418	BTK	
1.2, 1.2 4x4, 1.2 Bi-Power / Natural Power, 1.2 LPG	09/03-11/09	188 A4.000	1242	15x129; :→2533528	SK-1418AQ1	BTKW	
1.2, 1.2 Bi-Power / Natural Power, 1.2 LPG	01/07-11/09	169 A4.000, 188 A4.000	1242	22x129	SK-1677	BTK	
1.4	10/06-	169 A3.000	1368	22x124; Baumuster: 169	SK-1412	BTK	
1.4	10/06-	169 A3.000	1368	22x124	SK-1412AQ2	BTKW	
1.4 8V Natural Power, 1.4 Bi-Power / Natural Power	01/10-	350 A1.000	1368	22x129	SK-1677	BTK	
1.1	09/03-	187 A1.000	1108	:2533529→	0-N1616	TB [TE]	
1.1	09/03-	187 A1.000	1108	:→2533528	0-N822	TB [TE]	
1.2, 1.2 4x4, 1.2 Bi-Power / Natural Power, 1.2 LPG	09/03-11/09	188 A4.000	1242	:2533529→	0-N1616	TB [TE]	
1.2, 1.2 4x4, 1.2 Bi-Power / Natural Power, 1.2 LPG	09/03-11/09	188 A4.000	1242	:→2533528	0-N822	TB [TE]	
1.2, 1.2 4x4, 1.2 LPG	11/09-	169 A4.000	1242		0-N1616	TB [TE]	
1.4	10/06-	169 A3.000	1368		0-N195	TB [TE]	
1.4 8V Natural Power, 1.4 Bi-Power / Natural Power	01/10-	350 A1.000	1368		0-N1616	TB [TE]	
1.1	09/03-	187 A1.000	1108		0-N1517	VB [BT]	S
1.2, 1.2 4x4, 1.2 Bi-Power / Natural Power, 1.2 LPG	09/03-11/09	169 A4.000, 188 A4.000	1242		0-N1517	VB [BT]	S
1.3 D Multijet, 1.3 D Multijet 4x4	09/03-	169 A1.000, 169 A5.000, 188 A8.000, 188 A9.000	1248		0-N1478S	VB [TE]	
1.4, 1.4 8V Natural Power, 1.4 Bi-Power / Natural Power	10/06-	169 A3.000, 350 A1.000	1368		0-N1517	VB [BT]	S

PANDA Van (169)							
1.1	09/04-	187 A1.000	1108	15x125; :→2533528	SK-1421	BTK	
1.1	09/04-	187 A1.000	1108	15x125; :→2533528	SK-1421AQ1	BTKW	
1.1	09/04-	187 A1.000	1108	22x125; :2533529→	SK-1676	BTK	

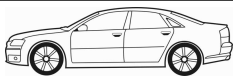

CM³



Art. Nr.



PANDA Van (169)							
1.1	09/04-	187 A1.000	1108	22x125; :2533529 →	SK-1676AQ1	BTKW	
1.2	09/04-	188 A4.000	1242	22x129; → 06/2008; :2533529 →	SK-1677AQ1	BTKW	
1.2, 1.2 4x4	09/04-	188 A4.000	1242	15x129; :→2533528	SK-1418	BTK	
1.2, 1.2 4x4	09/04-	188 A4.000	1242	15x129; :→2533528	SK-1418AQ1	BTKW	
1.2, 1.2 4x4	09/04-	188 A4.000	1242	22x129; :2533529 →	SK-1677	BTK	
1.2, 1.2 4x4, 1.2 LPG	09/10-	169 A4.000	1242	22x129	SK-1677	BTK	
1.4 Natural Power	10/09-	350 A1.000	1368	22x129	SK-1677	BTK	
1.2, 1.2 4x4	09/04-	188 A4.000	1242	:2533529 →	0-N1616	TB [TE]	
1.2, 1.2 4x4	09/04-	188 A4.000	1242	:→2533528	0-N822	TB [TE]	
1.2, 1.2 4x4, 1.2 LPG	09/10-	169 A4.000	1242		0-N1616	TB [TE]	
1.4 Natural Power	10/09-	350 A1.000	1368		0-N1616	TB [TE]	
1.4 Natural Power	10/09-	350 A1.000	1368		0-N1517	VB [BT]	S
PANDA (312, 312_)							
1.2, 1.2 LPG	02/12-	169 A4.000	1242	22x129	SK-1677	BTK	
1.2	02/12-	169 A4.000	1242		0-N1616	TB [TE]	
1.2	02/12-	169 A4.000	1242		0-N1517	VB [BT]	S
1.3 D Multijet	02/12-	199 A1.000, 199 A9.000	1248		0-N1478S	VB [TE]	
PENNY VAN (257)							
1.7 D	01/86-12/90	149 B3.000	1698	22x168; 02/1988 →	SK-1032	BTK	
1.1	01/86-12/90	146 A6.000	1116		0-N850	TB [TE]	
1.3	01/86-12/90	146 A5.000	1301		0-N850	TB [TE]	
PUNTO (176)							
1.4 GT Turbo	01/94-09/99	176 A4.000, 176 B6.000	1372	15x138	SK-1031	BTK	
1.7 D, 1.7 TD, 60 TD 1.7	01/94-09/99	176 A3.000, 176 A5.000, 176 B3.000, 176 B7.000	1698	22x168	SK-1032	BTK	
55 1.1	09/93-09/99	176 A6.000, 176 B2.000	1108	15x104; :→9042883	SK-1023	BTK	
55 1.1	09/93-09/99	176 A6.000, 176 B2.000	1108	15x125; :9042884 →	SK-1421	BTK	
55 1.1	09/93-09/99	176 A6.000, 176 B2.000	1108	15x125; :9042884 →	SK-1421AQ1	BTKW	
55 1.1	09/93-09/99	176 A6.000, 176 B2.000	1108	15x104; :→9042883	SK-1665	BTK	
55 1.1	09/93-09/99	176 A6.000, 176 B2.000	1108	15x104; → 03/1999; :→9042883	SK-1665AQ1	BTKW	
55 1.1	09/93-09/99	176 A6.000, 176 B2.000	1108	15x104; 04/1999 →; :→9042883	SK-1665AQ2	BTKW	
60 1.2, 75 1.2	10/93-09/99	176 A7.000, 176 A8.000, 176 B1.000, 176 B4.000	1242	15x108; :→9042883	SK-1043	BTK	
60 1.2, 75 1.2	10/93-09/99	176 A8.000, 176 B1.000, 176 B4.000	1242	15x108; → 03/1999; :→9042883	SK-1043AQ1	BTKW	
60 1.2, 75 1.2	10/93-09/99	176 A7.000, 176 A8.000, 176 B1.000, 176 B4.000	1242	15x129; :9042884 →	SK-1418	BTK	
60 1.2, 75 1.2	10/93-09/99	176 A7.000, 176 A8.000, 176 B1.000, 176 B4.000	1242	15x129; :9042884 →	SK-1418AQ1	BTKW	
85 16V 1.2	04/97-09/99	176 B9.000	1242	22x124	SK-1412	BTK	
85 16V 1.2	04/97-09/99	176 B9.000	1242	22x124; → 04/1999	SK-1412AQ1	BTKW	
85 16V 1.2	04/97-09/99	176 B9.000	1242	22x124; 04/1999 →	SK-1412AQ2	BTKW	
90 1.6	01/94-04/97	176 A9.000	1581	15x138	SK-1031	BTK	
1.4 GT Turbo	01/94-09/99	176 A4.000, 176 B6.000	1372		0-N822	TB [TE]	
1.7 D, 1.7 TD, 60 TD 1.7	01/94-09/99	176 A3.000, 176 A5.000, 176 B3.000, 176 B7.000	1698		0-N819	TB [TE]	
1.7 D, 1.7 TD, 60 TD 1.7	01/94-09/99	176 A3.000, 176 A5.000, 176 B3.000, 176 B7.000	1698		0-N820	TB [DG]	
55 1.1	09/93-09/99	176 A6.000, 176 B2.000	1108		0-N822	TB [TE]	
60 1.2, 75 1.2	10/93-09/99	176 A7.000, 176 A8.000, 176 B1.000, 176 B4.000	1242		0-N822	TB [TE]	
85 16V 1.2	04/97-09/99	176 B9.000	1242		0-N195	TB [TE]	
90 1.6	01/94-04/97	176 A9.000	1581		0-N822	TB [TE]	
1.4 GT Turbo	01/94-09/99	176 A4.000, 176 B6.000	1372		0-N187	VB [DG]	
1.7 D, 1.7 TD, 60 TD 1.7	01/94-09/99	176 A3.000, 176 A5.000, 176 B3.000, 176 B7.000	1698		0-N1634	VB [DG]	
1.7 D, 1.7 TD, 60 TD 1.7	01/94-09/99	176 A3.000, 176 A5.000, 176 B3.000, 176 B7.000	1698		0-N187	VB [DG]	
90 1.6	01/94-04/97	176 A9.000	1581		0-N187	VB [DG]	
PUNTO Cabriolet (176C)							
60 1.2	04/94-06/00	176 A7.000	1242	15x108; Baumuster: 176	SK-1043	BTK	
60 1.2	04/94-06/00	176 A7.000	1242	15x108; → 03/1999	SK-1043AQ1	BTKW	
60 1.2	04/94-06/00	176 A7.000	1242	15x129; :9042883 →	SK-1418	BTK	
60 1.2	04/94-06/00	176 A7.000	1242	15x129; :9042883 →	SK-1418AQ1	BTKW	
60 1.2	05/95-06/00	176 B1.000, 176 B4.000	1242	15x108; 04/1997 →; :→9042883	SK-1043	BTK	
60 1.2	05/95-06/00	176 B1.000, 176 B4.000	1242	15x108; → 03/1999; :→9042883	SK-1043AQ1	BTKW	
60 1.2	05/95-06/00	176 B1.000, 176 B4.000	1242	15x129; 04/1997 →; :9042884 →	SK-1418	BTK	



CM³



Art. Nr.



PUNTO Cabriolet (176C)

60 1.2	05/95-06/00	176 B1.000, 176 B4.000	1242	15x129; 04/1997 →; :9042884 →	SK-1418AQ1	BTKW	
85 16V 1.2	04/97-06/00	176 B9.000	1242	22x124	SK-1412	BTK	
85 16V 1.2	04/97-06/00	176 B9.000	1242	22x124; → 04/1999	SK-1412AQ1	BTKW	
85 16V 1.2	04/97-06/00	176 B9.000	1242	22x124; 04/1999 →	SK-1412AQ2	BTKW	
90 1.6	04/94-04/97	176 A9.000	1581	15x138	SK-1031	BTK	
60 1.2	04/94-06/00	176 A7.000, 176 B1.000, 176 B4.000	1242		0-N822	TB [TE]	
85 16V 1.2	04/97-06/00	176 B9.000	1242		0-N195	TB [TE]	
90 1.6	04/94-04/97	176 A9.000	1581		0-N822	TB [TE]	
90 1.6	04/94-04/97	176 A9.000	1581		0-N187	VB [DG]	

PUNTO Van (176L)

1.1	04/96-02/00	176 B2.000	1108	15x104; :→9042883	SK-1023	BTK	
1.1	04/96-02/00	176 B2.000	1108	15x125; :9042884 →	SK-1421	BTK	
1.1	04/96-02/00	176 B2.000	1108	15x125; :9042884 →	SK-1421AQ1	BTKW	
1.1	04/96-02/00	176 B2.000	1108	15x104; :→9042883	SK-1665	BTK	
1.1	04/96-02/00	176 B2.000	1108	15x104; → 03/1999; :→9042883	SK-1665AQ1	BTKW	
1.1	04/96-02/00	176 B2.000	1108	15x104; 04/1999 →; :→9042883	SK-1665AQ2	BTKW	
1.7 D, 1.7 TD	04/96-02/00	176 A5.000, 176 B3.000	1698	22x168	SK-1032	BTK	
1.7 TD	09/96-09/99	176 B7.000	1698	22x168; 08/1997 →	SK-1032	BTK	
1.1	04/96-02/00	176 B2.000	1108		0-N822	TB [TE]	
1.7 D, 1.7 TD	04/96-02/00	176 A5.000, 176 B3.000	1698		0-N819	TB [TE]	
1.7 D, 1.7 TD	04/96-02/00	176 A5.000, 176 B3.000	1698		0-N820	TB [DG]	
1.7 D, 1.7 TD	04/96-02/00	176 A5.000, 176 B3.000	1698		0-N1634	VB [DG]	
1.7 D, 1.7 TD	04/96-02/00	176 A5.000, 176 B3.000	1698		0-N187	VB [DG]	

PUNTO (188)

1.2 16V 80	09/99-	188 A5.000	1242	22x124; Baumuster: 188	SK-1412	BTK	
1.2 16V 80	09/99-	188 A5.000	1242	22x124	SK-1412AQ2	BTKW	
1.2 60	09/99-	188 A4.000	1242	15x129; :→2533528	SK-1418	BTK	
1.2 60	09/99-	188 A4.000	1242	15x129; :→2533528	SK-1418AQ1	BTKW	
1.2 60	09/99-	188 A4.000	1242	22x129; :2533529 →	SK-1677	BTK	
1.2 60	09/99-	188 A4.000	1242	22x129; → 06/2008; :2533529 →	SK-1677AQ1	BTKW	
1.2 Bifuel	08/07-	188 A4.000	1242	22x129; → 10/2011	SK-1677	BTK	
1.2 Bifuel, 1.2 Natural Power	09/03-	188 A4.000	1242	22x129; :2533529 →	SK-1677AQ1	BTKW	
1.2 Natural Power	09/03-	188 A4.000	1242	15x129; :→2533528; →2003	SK-1418	BTK	
1.2 Natural Power	09/03-	188 A4.000	1242	15x129; :→2533528; →2003	SK-1418AQ1	BTKW	
1.2 Natural Power	09/03-	188 A4.000	1242	22x129; 10/2003 → 04/2006	SK-1677	BTK	
1.4	09/03-	843 A1.000	1368	22x124; Baumuster: 188	SK-1412	BTK	
1.4	09/03-	843 A1.000	1368	22x124	SK-1412AQ2	BTKW	
1.4	11/05-	199 A6.000	1368	22x124	SK-1412	BTK	
1.8 130 HGT	09/99-	183 A1.000	1747	24x168	SK-1410	BTK	
1.8 130 HGT	09/99-	183 A1.000	1747	24x168	SK-1410AQ1	BTKW	
1.8 130 HGT	09/99-	188 A6.000	1747	24x166	SK-1415	BTK	
1.9 DS 60	09/99-	188 A3.000	1910	24x193; mit Zubehör	SK-1646	BTK	
1.9 DS 60	09/99-	188 A3.000	1910	24x193	SK-1646AQ1	BTKW	
1.9 JTD, 1.9 JTD 80	09/99-	188 A2.000, 188 A7.000, 188 B2.000	1910	24x190; mit Zubehör	SK-1629	BTK	
1.9 JTD, 1.9 JTD 80	09/99-	188 A2.000, 188 A7.000, 188 B2.000	1910	24x190; mit Zubehör	SK-1629AQ1	BTKW	
1.2 16V 80	09/99-	188 A5.000	1242		0-N195	TB [TE]	
1.2 60, 1.2 Bifuel, 1.2 Natural Power	09/99-	188 A4.000	1242	:2533529 →	0-N1616	TB [TE]	
1.2 60, 1.2 Bifuel, 1.2 Natural Power	09/99-	188 A4.000	1242	:→2533528	0-N822	TB [TE]	
1.4	09/03-	843 A1.000	1368		0-N195	TB [TE]	
1.8 130 HGT	09/99-	183 A1.000, 188 A6.000	1747		0-N194	TB [TE]	
1.8 130 HGT	09/99-	183 A1.000, 188 A6.000	1747		0-N938	TB [DG]	
1.9 DS 60, 1.9 JTD, 1.9 JTD 80	09/99-	188 A2.000, 188 A3.000, 188 A7.000, 188 B2.000	1910		0-N115	TB [TE]	
1.9 DS 60, 1.9 JTD, 1.9 JTD 80	09/99-	188 A2.000, 188 A3.000, 188 B2.000	1910		0-N1326	TB [DG]	
1.9 JTD	10/01-	188 A7.000	1910	:→4115088	0-N1326	TB [DG]	
1.9 JTD	10/01-	188 A7.000	1910	:4115089 →	0-N2149	TB [DG]	
1.2 16V 80, 1.2 60, 1.2 Natural Power	09/99-	188 A4.000, 188 A5.000	1242		0-N1517	VB [BT]	S
1.3 JTD 16V	06/03-	188 A9.000	1248		0-N1478S	VB [TE]	
1.4	09/03-	843 A1.000	1368		0-N1517	VB [BT]	S
1.8 130 HGT	09/99-	183 A1.000, 188 A6.000	1747		0-N1403	VB [DG]	
1.8 130 HGT	09/99-	188 A6.000	1747	→ 09/2003	0-N1407	VB [BT]	S
1.8 130 HGT	09/99-	183 A1.000, 188 A6.000	1747		0-N1966	VB [DG]	
1.8 130 HGT	09/99-	188 A6.000	1747	09/2003 →	0-N2117	VB [BT]	S
1.9 DS 60, 1.9 JTD, 1.9 JTD 80	09/99-	188 A2.000, 188 A3.000, 188 A7.000, 188 B2.000	1910		0-N1408	VB [DG]	

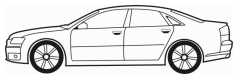

CM³



Art. Nr.



PUNTO (188)

1.9 DS 60, 1.9 JTD, 1.9 JTD 80	09/99-	188 A2.000, 188 A3.000, 188 A7.000, 188 B2.000	1910		0-N1415	VB [DG]	
1.9 DS 60, 1.9 JTD, 1.9 JTD 80	09/99-	188 A2.000, 188 A3.000, 188 A7.000, 188 B2.000	1910	✳	0-N1487	VB [BT]	S

PUNTO Van (188AX)

1.2 60	02/00-10/09	188 A4.000	1242	15x129; 09/2000 →; :→2533528	SK-1418	BTK	
1.2 60	02/00-10/09	188 A4.000	1242	15x129; :→2533528	SK-1418AQ1	BTKW	
1.2 60	02/00-10/09	188 A4.000	1242	22x129; 09/2000 →; :2533529→	SK-1677	BTK	
1.2 60	02/00-10/09	188 A4.000	1242	22x129; → 06/2008; :2533529→	SK-1677AQ1	BTKW	
1.9 D 60	02/00-10/09	188 A3.000	1910	24x193; mit Zubehör	SK-1646	BTK	
1.9 D 60	02/00-10/09	188 A3.000	1910	24x193	SK-1646AQ1	BTKW	
1.9 JTD	02/00-10/09	188 A7.000	1910	24x190; 09/2001 →; mit Zubehör	SK-1629	BTK	
1.9 JTD	02/00-10/09	188 A7.000	1910	24x190; 09/2001 →; mit Zubehör	SK-1629AQ1	BTKW	
1.2 60	02/00-10/09	188 A4.000	1242	:2533529→	0-N1616	TB [TE]	
1.2 60	02/00-10/09	188 A4.000	1242	:→2533528	0-N822	TB [TE]	
1.9 D 60	02/00-10/09	188 A3.000	1910		0-N1326	TB [DG]	
1.9 D 60, 1.9 JTD	02/00-10/09	188 A3.000, 188 A7.000	1910		0-N115	TB [TE]	
1.9 JTD	02/00-10/09	188 A7.000	1910	:→4115088	0-N1326	TB [DG]	
1.9 JTD	02/00-10/09	188 A7.000	1910	:4115089→	0-N2149	TB [DG]	
1.2 60	02/00-10/09	188 A4.000	1242		0-N1517	VB [BT]	S
1.9 D 60, 1.9 JTD	02/00-10/09	188 A3.000, 188 A7.000	1910		0-N1408	VB [DG]	
1.9 D 60, 1.9 JTD	02/00-10/09	188 A3.000, 188 A7.000	1910		0-N1415	VB [DG]	
1.9 D 60, 1.9 JTD	02/00-10/09	188 A3.000, 188 A7.000	1910	✳	0-N1487	VB [BT]	S

GRANDE PUNTO (199)

1.2	10/05-	199 A4.000	1242	22x129; → 06/2008	SK-1677AQ1	BTKW	
1.2, 1.2 LPG	10/05-	169 A4.000, 199 A4.000	1242	22x129	SK-1677	BTK	
1.4	10/05-	199 A7.000, 350 A1.000	1368	22x129; → 06/2008	SK-1677AQ1	BTKW	
1.4 16V	10/05-	199 A6.000	1368	22x124	SK-1412	BTK	
1.4 16V	09/07-07/12	198 A1.000	1368	22x124; 01/2009 →	SK-1412	BTK	
1.4 16V	09/07-07/12	198 A1.000	1368	22x124; 01/2009 →	SK-1412AQ2	BTKW	
1.4 16V, 1.4 T-Jet	10/05-	198 A4.000, 199 A6.000	1368	22x124	SK-1412AQ2	BTKW	
1.4 LPG	12/08-	350 A1.000	1368	22x129; 11/2011 →	SK-1677	BTK	
1.4 T-Jet	09/07-	198 A4.000	1368	22x124; Baumuster: 199	SK-1412	BTK	
1.4, 1.4 Natural Power	10/05-	199 A7.000, 350 A1.000	1368	22x129	SK-1677	BTK	
1.6 D Multijet	07/08-	955 A3.000	1598	24x194; → 12/2009	SK-1693	BTK	
1.6 D Multijet	07/08-	955 A3.000	1598	24x194	SK-1693AQ1	BTKW	
1.9 D Multijet	10/05-	199 A5.000, 939 A1.000, 939 A7.000	1910	24x190	SK-1696	BTK	
1.9 D Multijet	10/05-	199 A5.000, 939 A1.000, 939 A7.000	1910	24x190	SK-1696AQ1	BTKW	
1.2	10/05-	169 A4.000, 199 A4.000	1242		0-N1616	TB [TE]	
1.4 16V, 1.4 T-Jet	10/05-	198 A4.000, 199 A6.000	1368		0-N195	TB [TE]	
1.4, 1.4 LPG, 1.4 Natural Power	10/05-	350 A1.000	1368		0-N1616	TB [TE]	
1.6 D Multijet	07/08-	955 A3.000	1598		0-N115	TB [TE]	
1.6 D Multijet	07/08-	955 A3.000	1598		0-N2149	TB [DG]	
1.9 D Multijet	10/05-	199 A5.000, 939 A1.000, 939 A7.000	1910		0-N115	TB [TE]	
1.9 D Multijet	10/05-	199 A5.000, 939 A1.000, 939 A7.000	1910		0-N2149	TB [DG]	
1.2	09/10-	169 A4.000	1242		0-N1517	VB [BT]	S
1.3 D Multijet	10/05-	199 A2.000, 199 B2.000, 199 B4.000, 223 A9.000	1248		0-N1478S	VB [TE]	
1.3 D Multijet	10/05-	199 A3.000	1248		0-N1526	VB [BT]	S
1.4, 1.4 16V, 1.4 LPG, 1.4 Natural Power, 1.4 T-Jet	10/05-	198 A4.000, 199 A6.000, 199 A7.000, 350 A1.000	1368		0-N1517	VB [BT]	S
1.9 D Multijet	10/05-	199 A5.000, 939 A1.000	1910		0-N1503	VB [BT]	S
1.9 D Multijet	10/05-	199 A5.000, 939 A1.000, 939 A7.000	1910		0-N1522	VB [DG]	
1.9 D Multijet	10/05-	199 A5.000, 939 A1.000, 939 A7.000	1910	Rippenanzahl: 6	0-N1667	VB [DG]	

PUNTO (199)

1.2	03/12-	169 A4.000	1242	22x129	SK-1677	BTK	
1.4 Multi Air, 1.4 Turbo Multi Air	03/12-	955 A2.000, 955 A6.000	1368	22x124	SK-1412	BTK	
1.4 Multi Air, 1.4 Turbo Multi Air	03/12-	955 A2.000, 955 A6.000	1368	22x124	SK-1412AQ2	BTKW	
1.4, 1.4 Bifuel, 1.4 Natural Power	03/12-	199 A7.000, 350 A1.000	1368	22x129	SK-1677	BTK	
1.2	03/12-	169 A4.000	1242		0-N1616	TB [TE]	
1.4, 1.4 Bifuel, 1.4 Natural Power	03/12-	350 A1.000	1368		0-N1616	TB [TE]	
1.2	03/12-	169 A4.000	1242		0-N1517	VB [BT]	S
1.3 Multijet	03/12-	199 A2.000, 199 A9.000, 199 B4.000	1248		0-N1478S	VB [TE]	
1.3 Multijet	03/12-	199 B1.000	1248		0-N2390	VB [BT]	S



CM³



Art. Nr.



PUNTO (199)

1.4, 1.4 Bifuel, 1.4 Natural Power, 1.4 Turbo Multi Air	03/12-	199 A7.000, 350 A1.000, 955 A2.000	1368			0-N1517	VB [BT]	S
---	--------	------------------------------------	------	--	--	----------------	---------	----------

PUNTO EVO (199)

1.2	10/09-02/12	199 A4.000	1242	22x129		SK-1677	BTK	
1.2	10/09-02/12	169 A4.000	1242	22x129; 09/2010 →		SK-1677	BTK	
1.4 16V	10/09-02/12	955 A2.000, 955 A6.000	1368	22x124		SK-1412	BTK	
1.4 16V	10/09-02/12	955 A2.000, 955 A6.000	1368	22x124		SK-1412AQ2	BTKW	
1.4, 1.4 LPG, 1.4 Natural Power	06/09-02/12	199 A7.000, 350 A1.000	1368	22x129		SK-1677	BTK	
1.6 D Multijet	10/09-02/12	955 A3.000	1598	24x194		SK-1693	BTK	
1.6 D Multijet	10/09-02/12	955 A3.000	1598	24x194		SK-1693AQ1	BTKW	
1.2	10/09-02/12	169 A4.000, 199 A4.000	1242			0-N1616	TB [TE]	
1.4 16V	10/09-02/12	955 A2.000, 955 A6.000	1368			0-N195	TB [TE]	
1.4, 1.4 LPG, 1.4 Natural Power	06/09-02/12	350 A1.000	1368			0-N1616	TB [TE]	
1.6 D Multijet	10/09-02/12	955 A3.000	1598			0-N115	TB [TE]	
1.6 D Multijet	10/09-02/12	955 A3.000	1598			0-N2149	TB [DG]	
1.2	10/09-02/12	169 A4.000	1242			0-N1517	VB [BT]	S
1.3 D Multijet	07/08-02/12	199 A2.000, 199 A9.000, 199 B1.000, 199 B2.000, 199 B4.000, 223 A9.000	1248			0-N1478S	VB [TE]	
1.3 D Multijet	10/09-02/12	199 A3.000	1248			0-N1526	VB [BT]	S
1.3 D Multijet	10/09-02/12	199 B1.000	1248	☞ sequentiell		0-N1526	VB [BT]	S
1.4, 1.4 16V, 1.4 LPG, 1.4 Natural Power	06/09-02/12	199 A7.000, 350 A1.000, 955 A2.000, 955 A6.000	1368			0-N1517	VB [BT]	S
1.6 D Multijet	10/09-02/12	955 A3.000	1598			0-N1503	VB [BT]	S
1.6 D Multijet	10/09-02/12	955 A3.000	1598	☞		0-N1522	VB [DG]	
1.6 D Multijet	10/09-02/12	955 A3.000	1598	Rippenanzahl: 6		0-N2122	VB [DG]	

QUBO (225)

1.4	02/08-	KFV	1360	17x104; Baumuster: 225		SK-1354	BTK	
1.4	02/08-	KFT, KFV	1360	17x104		SK-1354AQ1	BTKW	
1.4 Natural Power	10/09-	350 A1.000	1368	22x129		SK-1677	BTK	
1.4	02/08-	KFV	1360			0-N1277	TB [TE]	
1.4 Natural Power	10/09-	350 A1.000	1368			0-N1616	TB [TE]	
1.3 D Multijet	02/08-	199 A2.000, 199 A9.000	1248			0-N1478S	VB [TE]	
1.3 D Multijet	02/08-	199 A2.000, 199 A9.000	1248	☞ sequentiell		0-N1526	VB [BT]	S
1.3 D Multijet	07/10-	199 B1.000	1248			0-N2390	VB [BT]	S
1.4	02/08-	KFV	1360			0-N1419	VB [DG]	
1.4	02/08-	KFV	1360			0-N1620	VB [BT]	S
1.4 Natural Power	10/09-	350 A1.000	1368			0-N1517	VB [BT]	S

REGATA (138)

100 Super 1.6	10/83-12/90	149 A2.000, 149 A4.000, 149 C3.000	1585	18x138		SK-1445	BTK	
90 i.e. 1.6	01/87-07/89	149 C2.000	1595	18x138		SK-1445	BTK	
100 Super 1.6	10/83-12/90	149 A2.000, 149 A4.000	1585	ch.70566788, 7380452→		0-N823	TB [TE]	
60 Diesel 1.7	05/85-03/89	149 B3.000	1698			0-N826	TB [TE]	
65 Diesel 1.9	04/84-07/89	149 A1.000	1929	ch.7056788, 7380452→		0-N826	TB [TE]	
65 Diesel 1.9	04/84-07/89	149 A1.000	1929	ch.→7056787, 7380451		0-N889	TB [DG]	
70 1.3	09/83-07/89	138 B2.000, 149 A3.000, 149 A7.000	1301	☞:5771823→		0-N818	TB [TE]	
75 1.5, 75 i.e. 1.5, 85 1.5, 85 Super 1.5	09/83-07/89	138 B3.000, 138 B3.048, 138 C2.048, 138 C3.048, 149 C1.000, 138 C2.048, 149 C1.000, 149 A5.000	1498	☞:5771823→		0-N818	TB [TE]	
80 Turbo Diesel 1.9	05/86-07/89	831 D1.000	1929			0-N826	TB [TE]	
85 1.6	10/83-06/90	149 A.000	1585	ch.7409425→		0-N818	TB [TE]	
90 i.e. 1.6	01/87-07/89	149 C2.000	1595	ch.70566788, 7380452→		0-N823	TB [TE]	

REGATA Weekend (138)

100 1.6, 100 i.e. 1.6	09/84-12/90	149 A4.000, 149 C3.000, 149 C3.000	1585	18x138		SK-1445	BTK	
100 1.6	09/84-12/86	149 A4.000, 149 C3.000	1585	ch.70566788, 7380452→		0-N823	TB [TE]	
60 Diesel 1.7	01/84-12/89	149 B3.000	1698			0-N826	TB [TE]	
65 Diesel 1.9	04/84-07/89	149 A1.000	1929	ch.→7056787, 7380451		0-N889	TB [DG]	
65 Diesel 1.9, 80 Turbo Diesel 1.9	04/84-07/89	149 A1.000, 831 D1.000	1929	ch.7056788, 7380452→		0-N826	TB [TE]	
75 1.5, 75 1.5 i.e. KAT	09/84-07/89	138 B3.048, 138 C2.048, 138 C3.048, 138 C2.048	1498	☞:5771823→		0-N818	TB [TE]	
90 i.e. 1.6	01/87-07/89	149 C2.000	1595	ch.70566788, 7380452→		0-N823	TB [TE]	

RITMO Cabriolet (138_)

100 1.6	10/85-12/87	138 AR.000	1585	18x138; VET4880208→		SK-1445	BTK	
85 1.5	01/80-07/89	138 A4.000, 138 B3.000	1498	19.05x118; ☞:5771823→; ☞		SK-1138	BTK	
100 1.6	10/85-12/87	138 AR.048	1585	ch.4880208→		0-N823	TB [TE]	
85 1.5	01/80-07/89	138 A4.000, 138 B3.000	1498	☞:5771823→		0-N818	TB [TE]	

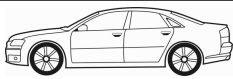

CM³



Art. Nr.



RITMO I (138A)							
105 Sport 1.6	05/81-12/82	138 AR.000	1585	18x138; VET4880208→	SK-1445	BTK	
75 1.5, 75 i.e. 1.5, 85 1.5	01/78-05/87	138 A2.000, 138 C2.048, 138 C3.048, 149 C1.000, 138 A4.000, 138 C2.048, 149 C1.000	1498	19.05x118; :5771823→;	SK-1138	BTK	
90 i.e. 1.6	09/85-12/87	149 C2.000	1595	18x138; VET4880208→	SK-1445	BTK	
60 1.0	09/78-09/82	127 A6.000	1049		0-N850	TB [TE]	
70 1.3	11/83-08/85	149 A3.000, 149 A7.000	1301	:5771823→	0-N818	TB [TE]	
75 i.e. 1.5	10/85-05/87	138 C2.048, 149 C1.000	1498	:5771823→	0-N818	TB [TE]	
90 i.e. 1.6	09/85-12/87	149 C2.000	1595	ch.4880208→	0-N823	TB [TE]	
RITMO II (138A)							
100 1.6	01/83-12/87	149 A4.000	1585	18x138; 10/1986 →; VET4880208→	SK-1445	BTK	
105 1.6, 90 1.6 i.e.	01/83-12/87	138 AR.000	1585	18x138; VET4880208→	SK-1445	BTK	
75 1.5, 75 1.5 KAT, 85 1.5	08/85-12/88	138 A2.000, 138 A2.000, 138 C2.048, 149 C1.000, 149 A5.000	1498	19.05x118; :5771823→;	SK-1138	BTK	
60 1.1	04/85-12/87	146 A4.048	1116	:5771823→	0-N818	TB [TE]	
60 Diesel 1.7	05/85-12/87	138 C.000, 149 B3.000	1698		0-N826	TB [TE]	
70 1.3	01/83-04/85	138 B2.000	1301	:5771823→	0-N818	TB [TE]	
75 1.5 KAT, 85 1.5	01/83-12/88	138 A2.000, 138 C2.048, 149 C1.000, 138 B3.000, 149 A5.000	1498	:5771823→	0-N818	TB [TE]	
80 Turbo Diesel 1.9	12/85-12/87	831 D1.000	1929		0-N826	TB [TE]	
90 1.6 i.e.	12/85-12/87	138 AR.000	1585	ch.4880208→	0-N823	TB [TE]	
SCUDO Combinato (220P)							
1.6	02/96-12/06	220 A 2.000	1581	15x138	SK-1031	BTK	
1.9 D	04/98-12/06	WJZ (DW8)	1868	25.4x140; 08/1998 →; Baumuster: 220P	SK-1086	BTK	
1.9 D	04/98-12/06	WJZ (DW8)	1868	25.4x140	SK-1086AQ1	BTKW	
1.9 D, 1.9 TD	02/96-12/06	D8B, D9B	1905	25.4x136; Baumuster: 220P	SK-1022	BTK	
1.9 D, 1.9 TD	02/96-12/06	D8B, D9B	1905	25.4x136; 04/1997 →; VET7391→	SK-1022AQ1	BTKW	
1.9 D, 1.9 TD, 1.9 TD Eco	02/96-12/06	D8B, D9B, DHX (XUD9TF/L)	1905	25.4x136; → 03/1997; Orga.→07390	SK-1022AQ2	BTKW	
1.9 TD Eco	02/96-12/06	DHX (XUD9TF/L)	1905	25.4x136; 05/1997 →; Baumuster: 220P	SK-1022	BTK	
1.9 TD Eco	02/96-12/06	DHX (XUD9TF/L)	1905	25.4x136; 03/1997 →; VET7390→	SK-1022AQ1	BTKW	
2.0 16V	06/00-12/06	RFN (EW10J4)	1997	25.4x153; 09/2000 →	SK-1482	BTK	
2.0 16V	06/00-12/06	RFN (EW10J4)	1997	25.4x153	SK-1482AQ1	BTKW	
2.0 JTD	12/99-12/06	RHZ	1997	25x141; → 04/2000; Orga.→8561; mit Zubehör	SK-1085	BTK	
2.0 JTD	12/99-12/06	RHZ	1997	25.4x141; → 04/2000; mit Zubehör	SK-1085AQ1	BTKW	
2.0 JTD	01/04-12/06	RHX	1997	25x141; mit Zubehör; Baumuster: 220P	SK-1085	BTK	
2.0 JTD	01/04-12/06	RHX	1997	25.4x141; mit Zubehör	SK-1085AQ1	BTKW	
2.0 JTD 16V	05/99-12/06	RHW (DW10ATED4)	1997	25x144	SK-1616	BTK	
2.0 JTD, 2.0 JTD 16V	05/99-12/06	RHW (DW10ATED4), RHZ	1997	25.4x144	SK-1534	BTK	
1.6	02/96-12/06	220 A 2.000	1581		0-N822	TB [TE]	
1.9 D	04/98-12/06	WJZ (DW8)	1868		0-N118P	TB [TE]	
1.9 D	04/98-12/06	WJZ (DW8)	1868		0-N1381	TB [DG]	
1.9 D, 1.9 TD, 1.9 TD Eco	02/96-12/06	D8B, D9B, DHX (XUD9TF/L)	1905		0-N900	TB [DG]	
1.9 D, 1.9 TD, 1.9 TD Eco	02/96-12/06	D8B, D9B, DHX (XUD9TF/L)	1905		0-N901	TB [TE]	
2.0 16V	06/00-12/06	RFN (EW10J4)	1997		0-N1057	TB [TE]	
2.0 16V	06/00-12/06	RFN (EW10J4)	1997		0-N1065	TB [DG]	
2.0 JTD	12/99-12/06	RHZ	1997	→ 04/2000	0-N118P	TB [TE]	
2.0 JTD	12/99-12/06	RHZ	1997	→ 04/2000	0-N119P	TB [DG]	
2.0 JTD	12/99-12/06	RHZ	1997	04/2000 →	0-N1381	TB [DG]	
2.0 JTD	01/04-12/06	RHX	1997		0-N118P	TB [TE]	
2.0 JTD	01/04-12/06	RHX	1997		0-N1381	TB [DG]	
2.0 JTD 16V	05/99-12/06	RHW (DW10ATED4)	1997	→ 04/2004	0-N118P	TB [TE]	
2.0 JTD 16V	05/99-12/06	RHW (DW10ATED4)	1997	→ 04/2004	0-N119P	TB [DG]	
2.0 JTD 16V	05/99-12/06	RHW (DW10ATED4)	1997	04/2004 →	0-N1357	TB [TE]	
2.0 JTD 16V	05/99-12/06	RHW (DW10ATED4)	1997	04/2004 →	0-N1358	TB [DG]	
1.6	02/96-12/06	220 A 2.000	1581		0-N1672	VB [DG]	
1.9 D	04/98-12/06	WJZ (DW8)	1868	10/1999 →; für Fahrzeuge mit Servolenkung	0-N1309	VB [DG]	
1.9 D	04/98-12/06	WJZ (DW8)	1868		0-N1320	VB [TE]	
1.9 D	04/98-12/06	WJZ (DW8)	1868	→ 10/1999	0-N1455	VB [TE]	
1.9 D	04/98-12/06	WJZ (DW8)	1868	10/1999 →; für Fahrzeuge mit Servolenkung	0-N1471	VB [BT]	S
1.9 D	04/98-12/06	WJZ (DW8)	1868	→ 12/2002; für Fahrzeuge mit Servolenkung	0-N1472	VB [BT]	S
1.9 D	04/98-12/06	WJZ (DW8)	1868		0-N1545	VB [DG]	
1.9 D	04/98-12/06	WJZ (DW8)	1868	für Fahrzeuge ohne Servolenkung	0-N1681	VB [BT]	
1.9 D	04/98-12/06	WJZ (DW8)	1868	→ 12/2002; für Fahrzeuge mit Servolenkung	0-N1747	VB [VD]	



CM³



Art. Nr.



SCUDO Combinato (220P)

1.9 D	04/98-12/06	WJZ (DW8)	1868	12/2002 →; ⚠, für Fahrzeuge mit Servolenkung	0-N1945	VB [BT]	S
1.9 D, 1.9 TD, 1.9 TD Eco	02/96-12/06	D8B, D9B, DHX (XUD9TF/L)	1905		0-N1320	VB [TE]	
1.9 D, 1.9 TD, 1.9 TD Eco	02/96-12/06	D8B, D9B, DHX (XUD9TF/L)	1905		0-N1472	VB [BT]	S
1.9 D, 1.9 TD, 1.9 TD Eco	02/96-12/06	D8B, D9B, DHX (XUD9TF/L)	1905		0-N1747	VB [VD]	
1.9 D, 1.9 TD, 1.9 TD Eco	02/96-12/06	D8B, D9B, DHX (XUD9TF/L)	1905		0-N931	VB [TE]	
2.0 16V	06/00-12/06	RFN (EW10J4)	1997		0-N1391	VB [BT]	S
2.0 16V	06/00-12/06	RFN (EW10J4)	1997		0-N1416	VB [DG]	
2.0 16V	06/00-12/06	RFN (EW10J4)	1997	11/2005 →	0-N2276	VB [DG]	
2.0 JTD	12/99-12/06	RHX, RHZ	1997		0-N1493	VB [BT]	S
2.0 JTD	12/99-12/06	RHX, RHZ	1997	⚠	0-N151	VB [DG]	
2.0 JTD	12/99-12/06	RHX, RHZ	1997	⚠	0-N1748	VB [BT]	
2.0 JTD, 2.0 JTD 16V	05/99-12/06	RHW (DW10ATED4), RHX, RHZ	1997		0-N1320	VB [TE]	

SCUDO Kasten (220L)

1.6	02/96-12/06	220 A 2.000	1581	15x138	SK-1031	BTK	
1.9 D	04/98-12/06	WJY (DW8B), WJZ (DW8)	1868	25.4x140; Baumuster: 220L	SK-1086	BTK	
1.9 D	04/98-12/06	WJY (DW8B), WJZ (DW8)	1868	25.4x140	SK-1086AQ1	BTKW	
1.9 D, 1.9 TD	02/96-12/06	D8B, D9B, DHX (XUD9TF/L)	1905	25.4x136; Baumuster: 220L	SK-1022	BTK	
1.9 D, 1.9 TD	02/96-12/06	D9B, DHX (XUD9TF/L)	1905	25.4x136; 04/1997 →; VET7391 →	SK-1022AQ1	BTKW	
1.9 D, 1.9 TD	02/96-12/06	D9B, DHX (XUD9TF/L)	1905	25.4x136; → 03/1997; Orga.→07390	SK-1022AQ2	BTKW	
1.9 TD	02/98-12/06	D8B	1905	25.4x136; VET7391 →	SK-1022AQ1	BTKW	
2.0	05/00-12/06	RFN (EW10J4)	1997	25.4x153	SK-1482	BTK	
2.0 JTD	12/99-12/06	RHX	1997	25x141; → 04/2000; Orga.→8561; mit Zubehör	SK-1085	BTK	
2.0 JTD	12/99-12/06	RHX	1997	25.4x141; → 04/2000; mit Zubehör	SK-1085AQ1	BTKW	
2.0 JTD	12/02-12/06	RHZ	1997	25x141; mit Zubehör	SK-1085	BTK	
2.0 JTD	12/02-12/06	RHZ	1997	25.4x141; mit Zubehör	SK-1085AQ1	BTKW	
2.0 JTD	12/02-12/06	RHZ	1997	25.4x144; → 10/2006; Baumuster: 220L	SK-1534	BTK	
2.0 JTD	12/02-12/06	RHZ	1997	25.4x144; → 10/2006	SK-1534AQ1	BTKW	
2.0 JTD 16V	05/99-12/06	RHW (DW10ATED4)	1997	25.4x144; 09/2000 →	SK-1534	BTK	
2.0 JTD 16V	05/99-12/06	RHW (DW10ATED4)	1997	25.4x144; 09/2000 →	SK-1534AQ1	BTKW	
2.0 JTD 16V	05/99-12/06	RHW (DW10ATED4)	1997	25x144	SK-1616	BTK	
1.6	02/96-12/06	220 A 2.000	1581		0-N822	TB [TE]	
1.9 D	04/98-12/06	WJY (DW8B), WJZ (DW8)	1868		0-N118P	TB [TE]	
1.9 D	04/98-12/06	WJY (DW8B), WJZ (DW8)	1868		0-N1381	TB [DG]	
1.9 D, 1.9 TD	02/96-12/06	D8B, D9B, DHX (XUD9TF/L)	1905		0-N900	TB [DG]	
1.9 D, 1.9 TD	02/96-12/06	D8B, D9B, DHX (XUD9TF/L)	1905		0-N901	TB [TE]	
2.0	05/00-12/06	RFN (EW10J4)	1997		0-N1057	TB [TE]	
2.0	05/00-12/06	RFN (EW10J4)	1997		0-N1065	TB [DG]	
2.0 JTD	12/99-12/06	RHX	1997	→ 04/2000	0-N118P	TB [TE]	
2.0 JTD	12/99-12/06	RHX	1997	→ 04/2000	0-N119P	TB [DG]	
2.0 JTD	12/99-12/06	RHX	1997	04/2000 →	0-N1381	TB [DG]	
2.0 JTD	12/02-12/06	RHZ	1997		0-N118P	TB [TE]	
2.0 JTD	12/02-12/06	RHZ	1997		0-N1381	TB [DG]	
2.0 JTD 16V	05/99-12/06	RHW (DW10ATED4)	1997	→ 04/2004	0-N118P	TB [TE]	
2.0 JTD 16V	05/99-12/06	RHW (DW10ATED4)	1997	→ 04/2004	0-N119P	TB [DG]	
2.0 JTD 16V	05/99-12/06	RHW (DW10ATED4)	1997	04/2004 →	0-N1357	TB [TE]	
2.0 JTD 16V	05/99-12/06	RHW (DW10ATED4)	1997	04/2004 →	0-N1358	TB [DG]	
1.6	02/96-12/06	220 A 2.000	1581		0-N1672	VB [DG]	
1.9 D	04/98-12/06	WJY (DW8B), WJZ (DW8)	1868	10/1999 →; für Fahrzeuge mit Servolenkung	0-N1309	VB [DG]	
1.9 D	04/98-12/06	WJY (DW8B), WJZ (DW8)	1868		0-N1320	VB [TE]	
1.9 D	04/98-12/06	WJY (DW8B), WJZ (DW8)	1868	→ 10/1999	0-N1455	VB [TE]	
1.9 D	04/98-12/06	WJY (DW8B), WJZ (DW8)	1868	10/1999 →; für Fahrzeuge mit Servolenkung	0-N1471	VB [BT]	S
1.9 D	04/98-12/06	WJY (DW8B), WJZ (DW8)	1868	→ 12/2002; ⚠, für Fahrzeuge mit Servolenkung	0-N1472	VB [BT]	S
1.9 D	04/98-12/06	WJY (DW8B), WJZ (DW8)	1868		0-N1545	VB [DG]	
1.9 D	04/98-12/06	WJY (DW8B), WJZ (DW8)	1868	⚠, für Fahrzeuge ohne Servolenkung	0-N1681	VB [BT]	
1.9 D	04/98-12/06	WJY (DW8B), WJZ (DW8)	1868	→ 12/2002; ⚠, für Fahrzeuge mit Servolenkung	0-N1747	VB [VD]	
1.9 D	04/98-12/06	WJY (DW8B), WJZ (DW8)	1868	12/2002 →; ⚠, für Fahrzeuge mit Servolenkung	0-N1945	VB [BT]	S
1.9 D, 1.9 TD	02/96-12/06	D8B, D9B, DHX (XUD9TF/L)	1905		0-N1320	VB [TE]	
1.9 D, 1.9 TD	02/96-12/06	D8B, D9B, DHX (XUD9TF/L)	1905		0-N1472	VB [BT]	S
1.9 D, 1.9 TD	02/96-12/06	D8B, D9B, DHX (XUD9TF/L)	1905		0-N1747	VB [VD]	
1.9 D, 1.9 TD	02/96-12/06	D8B, D9B, DHX (XUD9TF/L)	1905		0-N931	VB [TE]	
2.0	05/00-12/06	RFN (EW10J4)	1997		0-N1391	VB [BT]	S

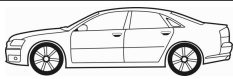

CM³



Art. Nr.



SCUDO Kasten (220L)

2.0	05/00-12/06	RFN (EW10J4)	1997		0-N1416	VB [DG]	
2.0	05/00-12/06	RFN (EW10J4)	1997	11/2005 →	0-N2276	VB [DG]	
2.0 JTD	12/99-12/06	RHX, RHZ	1997		0-N1493	VB [BT]	S
2.0 JTD	12/99-12/06	RHX, RHZ	1997	✘	0-N151	VB [DG]	
2.0 JTD	12/99-12/06	RHX, RHZ	1997	✘	0-N1748	VB [BT]	
2.0 JTD, 2.0 JTD 16V	05/99-12/06	RHW (DW10ATED4), RHX, RHZ	1997		0-N1320	VB [TE]	

SCUDO (272, 270)

1.6 D Multijet	01/07-	9HU	1560	25x137	SK-1424	BTK	
1.6 D Multijet	01/07-	9HU	1560	25x137	SK-1424AQ1	BTKW	
2.0 D Multijet	01/07-	RHK, RHR	1997	25.4x116; Baumuster: 270_	SK-1594	BTK	
2.0 D Multijet, 2.0 D Multijet 4x4	01/07-	RH02, RHH, RHK	1997	25.4x116	SK-1594	BTK	
2.0 D Multijet, 2.0 D Multijet 4x4	01/07-	RHK, RHR	1997	25.4x116	SK-1594AQ1	BTKW	
2.0 D Multijet, 2.0 D Multijet 4x4	07/10-	RH02, RH02, RHH	1997	25x116	SK-1714	BTK	
2.0 D Multijet, 2.0 D Multijet 4x4	07/10-	RH02, RH02, RHH	1997	25x116	SK-1714AQ1	BTKW	
1.6 D Multijet	01/07-	9HU	1560		0-N1062	TB [TE]	
1.6 D Multijet	01/07-	9HU	1560		0-N1066	TB [DG]	
2.0 4x4	03/07-	RFH (EW10A)	1997		0-N1065	TB [DG]	
2.0 D Multijet	01/07-	RH02, RHH, RHK, RHR	1997		0-N1334	TB [DG]	
2.0 D Multijet	07/10-	RH02, RHH	1997		0-N2063	TB [TE]	
1.6 D Multijet	01/07-	9HU	1560		0-N1807	VB [DG]	
1.6 D Multijet	01/07-	9HU	1560		0-N1808	VB [BT]	S
2.0 D Multijet	01/07-	RHK, RHR	1997		0-N1327	VB [BT]	
2.0 D Multijet	01/07-	RHK, RHR	1997	→ 07/2007; VET→11194	0-N2037	VB [BT]	S
2.0 D Multijet	01/07-	RHK, RHR	1997	07/2007 →; VET11195→	0-N2046	VB [BT]	S
2.0 D Multijet	07/10-	RH02, RHH	1997		0-N2046	VB [BT]	S
2.0 D Multijet	07/10-	RH02, RH02, RHH	1997		0-N2268	VB [BT]	S

SCUDO Kasten (272, 270)

1.6 D Multijet	01/07-	9HU	1560	25x137	SK-1424	BTK	
1.6 D Multijet	01/07-	9HU	1560	25x137	SK-1424AQ1	BTKW	
2.0 D Multijet	01/07-	RHK, RHR	1997	25.4x116; Baumuster: 270_	SK-1594	BTK	
2.0 D Multijet	07/10-	RH02, RH02, RHH	1997	25x116	SK-1714	BTK	
2.0 D Multijet	07/10-	RH02, RH02, RHH	1997	25x116	SK-1714AQ1	BTKW	
2.0 D Multijet, 2.0 D Multijet 4x4	01/07-	RH02, RHH, RHK	1997	25.4x116	SK-1594	BTK	
2.0 D Multijet, 2.0 D Multijet 4x4	01/07-	RHK, RHR	1997	25.4x116	SK-1594AQ1	BTKW	
1.6 D Multijet	01/07-	9HU	1560		0-N1062	TB [TE]	
1.6 D Multijet	01/07-	9HU	1560		0-N1066	TB [DG]	
2.0 D Multijet	01/07-	RH02, RHH, RHK, RHR	1997		0-N1334	TB [DG]	
2.0 D Multijet	07/10-	RH02, RHH	1997		0-N2063	TB [TE]	
1.6 D Multijet	01/07-	9HU	1560		0-N1807	VB [DG]	
1.6 D Multijet	01/07-	9HU	1560		0-N1808	VB [BT]	S
2.0 D Multijet	01/07-	RHK, RHR	1997		0-N1327	VB [BT]	
2.0 D Multijet	01/07-	RHK, RHR	1997	→ 07/2007; VET→11194	0-N2037	VB [BT]	S
2.0 D Multijet	01/07-	RHK, RHR	1997	07/2007 →; VET11195→	0-N2046	VB [BT]	S
2.0 D Multijet	07/10-	RH02, RHH	1997		0-N2046	VB [BT]	S
2.0 D Multijet	07/10-	RH02, RH02, RHH	1997		0-N2268	VB [BT]	S

SCUDO Pritsche/Fahrgestell (272, 270)

1.6 D Multijet	01/07-	9HU	1560	25x137	SK-1424	BTK	
1.6 D Multijet	01/07-	9HU	1560	25x137	SK-1424AQ1	BTKW	
2.0 D Multijet	01/07-	DW10BTED4, RHR, RHK	1997	25.4x116; Baumuster: 270_	SK-1594	BTK	
2.0 D Multijet	01/07-	DW10BTED4, RHR, RHK	1997	25.4x116	SK-1594AQ1	BTKW	
2.0 D Multijet	07/10-	RH02, RH02, RHH	1997	25x116	SK-1714	BTK	
2.0 D Multijet	07/10-	RH02, RH02, RHH	1997	25x116	SK-1714AQ1	BTKW	
1.6 D Multijet	01/07-	9HU	1560		0-N1062	TB [TE]	
1.6 D Multijet	01/07-	9HU	1560		0-N1066	TB [DG]	
2.0 D Multijet	01/07-	DW10BTED4, RHR, RHK	1997		0-N1334	TB [DG]	
1.6 D Multijet	01/07-	9HU	1560		0-N1807	VB [DG]	
1.6 D Multijet	01/07-	9HU	1560		0-N1808	VB [BT]	S
2.0 D Multijet	01/07-	DW10BTED4, RHR, RHK	1997		0-N1327	VB [BT]	
2.0 D Multijet	01/07-	DW10BTED4, RHR, RHK	1997	→ 07/2007; VET→11194	0-N2037	VB [BT]	S
2.0 D Multijet	01/07-	DW10BTED4, RHR, RHK	1997	07/2007 →; VET11195→	0-N2046	VB [BT]	S
2.0 D Multijet	07/10-	RH02, RH02, RHH	1997		0-N2268	VB [BT]	S

SEDICI (FY_)

1.9 D Multijet	06/06-	D19AA	1910	24x190; 04/2007 →	SK-1696	BTK	
1.9 D Multijet 4x4	06/06-	D19AA	1910	24x190; mit Zubehör	SK-1629	BTK	



OPTIMAL®

FIAT



CM³



Art. Nr.



SEDICI (FY_)

1.9 D Multijet 4x4	06/06-	D19AA	1910	24x190	SK-1696	BTK	
1.9 D Multijet, 1.9 D Multijet 4x4	06/06-	D19AA	1910	24x190	SK-1696AQ1	BTKW	
2.0 D Multijet, 2.0 D Multijet 4x4	06/06-	D20AA	1956	24x199; 09/2009 →	SK-1586	BTK	
2.0 D Multijet, 2.0 D Multijet 4x4	06/06-	D20AA	1956	24x199	SK-1586AQ1	BTKW	
1.9 D Multijet 4x4	06/06-	D19AA	1910		0-N115	TB [TE]	
1.9 D Multijet, 1.9 D Multijet 4x4	06/06-	D19AA	1910		0-N2149	TB [DG]	
2.0 D Multijet, 2.0 D Multijet 4x4	06/06-	D20AA	1956		0-N115	TB [TE]	
2.0 D Multijet, 2.0 D Multijet 4x4	06/06-	D20AA	1956		0-N2149	TB [DG]	
1.9 D Multijet 4x4	06/06-	D19AA	1910		0-N1503	VB [BT]	S
1.9 D Multijet 4x4	06/06-	D19AA	1910		0-N1522	VB [DG]	
1.9 D Multijet 4x4	06/06-	D19AA	1910	Rippenanzahl: 6	0-N1667	VB [DG]	
2.0 D Multijet, 2.0 D Multijet 4x4	06/06-	D20AA	1956		0-N1503	VB [BT]	S
2.0 D Multijet, 2.0 D Multijet 4x4	06/06-	D20AA	1956		0-N1522	VB [DG]	
2.0 D Multijet, 2.0 D Multijet 4x4	06/06-	D20AA	1956	Rippenanzahl: 6	0-N1667	VB [DG]	

SEICENTO / 600 (187)

1.1	01/98-01/10	187 A1.000	1108	15x125; :→2934169	SK-1421	BTK	
1.1	01/98-01/10	176 B2.000	1108	15x125; :9042884 →	SK-1421	BTK	
1.1	01/98-01/10	176 B2.000	1108	15x125; :9042884 →	SK-1421AQ1	BTKW	
1.1	01/98-01/10	187 A1.000	1108	15x125; :9042884 →	SK-1421AQ1	BTKW	
1.1	01/98-01/10	176 B2.000	1108	15x104; :→9042883	SK-1665	BTK	
1.1	01/98-01/10	176 B2.000, 187 A1.000	1108	15x104; → 03/1999; :→9042883	SK-1665AQ1	BTKW	
1.1	01/98-01/10	176 B2.000	1108	15x104; 04/1999 →; :→9042882	SK-1665AQ2	BTKW	
1.1	01/98-01/10	176 B2.000, 187 A1.000	1108		0-N822	TB [TE]	
1.1	01/98-01/10	176 B2.000, 187 A1.000	1108	⊛	0-N1627	VB [BT]	S
1.1	01/98-01/10	176 B2.000, 187 A1.000	1108		0-N1720	VB [BT]	S

SEICENTO / 600 Van (287)

1.1	01/98-01/10	176 B2.000	1108	15x125; :→2934169	SK-1421	BTK	
1.1	01/98-01/10	176 B2.000	1108	15x125; :9042884 →	SK-1421	BTK	
1.1	01/98-01/10	176 B2.000	1108	15x125; 03/2000 →; :9042884 →	SK-1421AQ1	BTKW	
1.1	01/98-01/10	176 B2.000	1108	15x104; :→9042883	SK-1665	BTK	
1.1	01/98-01/10	176 B2.000	1108	15x104; → 03/1999; :→9042883	SK-1665AQ1	BTKW	
1.1	01/98-01/10	176 B2.000	1108	15x104; 04/1999 →; :→9042882	SK-1665AQ2	BTKW	
1.1	01/98-01/10	176 B2.000	1108		0-N822	TB [TE]	
1.1	01/98-01/10	176 B2.000	1108		0-N1627	VB [BT]	S
1.1	01/98-01/10	176 B2.000	1108		0-N1720	VB [BT]	S

SIENA (172_)

1.4	11/07-	199 A1.000	1368	22x129	SK-1677	BTK	
-----	--------	------------	------	--------	---------	-----	--

SIENA (178_)

1.2	09/98-12/09	178 B5.000	1242	15x108; :→9042883	SK-1043	BTK	
1.2	09/98-12/09	178 B5.000	1242	15x108; → 03/1999; :→9042883	SK-1043AQ1	BTKW	
1.2	09/98-12/09	178 B5.000	1242	15x129; :9042884 →	SK-1418	BTK	
1.2	09/98-12/09	178 B5.000	1242	15x129; :9042884 →	SK-1418AQ1	BTKW	
1.2	09/01-12/09	188 A5.000	1242	22x124; Nockenwelle: DOHC; 01/2002 →; Baumuster: 178	SK-1412	BTK	
1.2	09/01-12/09	188 A5.000	1242	22x124	SK-1412AQ2	BTKW	
1.2	09/01-12/09	188 A4.000	1242	15x129	SK-1418	BTK	
1.2	09/01-12/09	178 C4.066	1242	15x129; 01/2002 →; :→2919639	SK-1418	BTK	
1.2	09/01-12/09	178 C4.066, 188 A4.000	1242	15x129; 01/2002 →; :→2533528	SK-1418AQ1	BTKW	
1.4	01/07-12/09	178 F3.011, 350 A1.000	1368	22x129	SK-1677	BTK	
1.6	11/00-12/09	182 B6.000	1596	25x158	SK-1076	BTK	
1.6 16V	09/98-12/09	178 B3.000	1581	25x158	SK-1076	BTK	
1.7 TD	02/06-12/09	176 A3.000	1697	22x168	SK-1032	BTK	
1.0	09/98-12/09		994		0-N822	TB [TE]	
1.2	09/01-12/09	178 C4.066	1242	:2533529 →	0-N1616	TB [TE]	
1.2	09/01-12/09	188 A5.000	1242		0-N195	TB [TE]	
1.2	09/01-12/09	188 A4.000	1242		0-N822	TB [TE]	
1.2	09/01-12/09	178 C4.066	1242	:→2533528	0-N822	TB [TE]	
1.2, 1.2 Bipower	09/98-12/09	178 B5.000, 178 E9.011	1242		0-N822	TB [TE]	
1.4, 1.4 KAT	04/96-12/09	178 B2.000, 178 B2.016	1372		0-N822	TB [TE]	
1.7 TD	02/06-12/09	176 A3.000	1697		0-N819	TB [TE]	
1.7 TD	02/06-12/09	176 A3.000	1697		0-N820	TB [DG]	
1.9 D	11/00-	223 A6.000	1910		0-N115	TB [TE]	
1.0 Bipower	09/00-12/09	178 D9.011, 178 F1.011	999		0-N1841	VB [BT]	
1.4 Bipower	06/04-10/07	178 F3.011	1368		0-N1841	VB [BT]	

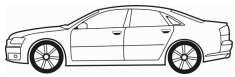

CM³



Art. Nr.



SIENA (178_)

1.5	06/04-12/09	178 E5.022	1461	für Fahrzeuge mit Servolenkung	0-N1522	VB [DG]	
1.5	06/04-12/09	178 E5.022	1461	für Fahrzeuge ohne Servolenkung	0-N1522	VB [DG]	
1.5	06/04-12/09	178 E5.022	1461		0-N1842	VB [BT]	S
1.7 TD	02/06-12/09	176 A3.000	1697		0-N1634	VB [DG]	

STILO (192)

1.2 16V	02/02-11/06	188 A5.000	1242	22x124; Baumuster: 192_XA1B	SK-1412	BTK	
1.2 16V	02/02-11/06	188 A5.000	1242	22x124	SK-1412AQ2	BTKW	
1.4 16V	01/04-11/06	192 B2.000, 843 A1.000	1368	22x124; Baumuster: 192	SK-1412	BTK	
1.4 16V	01/04-11/06	192 B2.000, 843 A1.000	1368	22x124	SK-1412AQ2	BTKW	
1.6 16V	10/01-11/06	182 B6.000	1596	25x158	SK-1076	BTK	
1.6 16V	05/05-11/06	192 B3.000	1598	24x146	SK-1607	BTK	
1.8 16V	10/01-11/06	192 A4.000	1747	24x166	SK-1415	BTK	
1.9 D Multijet	09/05-11/06	937 A5.000	1910	24x199	SK-1586	BTK	
1.9 D Multijet	09/05-11/06	937 A5.000	1910	24x199	SK-1586AQ1	BTKW	
1.9 D Multijet	09/05-11/06	192 A9.000	1910	24x190; :4114650→	SK-1696	BTK	
1.9 D Multijet, 1.9 JTD	10/01-11/06	192 A1.000, 937 A7.000, 192 A3.000, 192 A8.000, 192 A9.000, 192 B5.000	1910	24x190; mit Zubehör	SK-1629	BTK	
1.9 D Multijet, 1.9 JTD	10/01-11/06	192 A1.000, 937 A7.000, 192 A3.000, 192 A8.000, 192 A9.000, 192 B5.000	1910	24x190; mit Zubehör	SK-1629AQ1	BTKW	
1.9 JTD	09/03-11/06	192 A5.000, 192 B1.000, 937 A4.000	1910	24x198; mit Zubehör	SK-1602	BTK	
1.9 JTD	09/03-11/06	192 A5.000, 192 B1.000, 937 A4.000	1910	24x198; mit Zubehör	SK-1602AQ1	BTKW	
2.4 20V	10/01-11/06	192 A2.000	2446	24x168	SK-1446	BTK	
1.2 16V	02/02-11/06	188 A5.000	1242		0-N195	TB [TE]	
1.4 16V	01/04-11/06	192 B2.000, 843 A1.000	1368		0-N195	TB [TE]	
1.6 16V	10/01-11/06	182 B6.000	1596		0-N208	TB [TE]	
1.6 16V	10/01-11/06	182 B6.000	1596		0-N951	TB [DG]	
1.6 16V	05/05-11/06	192 B3.000	1598		0-N1347	TB [TE]	
1.6 16V	05/05-11/06	192 B3.000	1598		0-N1348	TB [DG]	
1.8 16V	10/01-11/06	192 A4.000	1747		0-N194	TB [TE]	
1.8 16V	10/01-11/06	192 A4.000	1747		0-N938	TB [DG]	
1.9 D Multijet, 1.9 JTD	10/01-11/06	192 A1.000, 937 A7.000, 192 A3.000, 192 A5.000, 192 A8.000, 192 A9.000, 192 B1.000, 192 B5.000, 937 A4.000, 937 A5.000	1910		0-N115	TB [TE]	
1.9 D Multijet, 1.9 JTD	01/04-11/06	192 A5.000, 192 A8.000, 192 A9.000, 192 B1.000, 937 A5.000	1910		0-N1326	TB [DG]	
1.9 JTD	10/01-11/06	192 A1.000, 937 A7.000, 192 A3.000	1910	:→4114649	0-N1326	TB [DG]	
1.9 JTD	10/01-11/06	192 A1.000, 937 A7.000, 192 A3.000	1910	:4114650→	0-N2149	TB [DG]	
1.9 JTD	09/03-11/06	937 A4.000	1910	Abgasnorm: Euro 4 (D4)	0-N1326	TB [DG]	
1.9 JTD	09/03-11/06	937 A4.000	1910	:→4109227; Abgasnorm: Euro 3 (D3)	0-N1326	TB [DG]	
1.9 JTD	09/03-11/06	937 A4.000	1910	:4109228→; Abgasnorm: Euro 3 (D3)	0-N2149	TB [DG]	
1.9 JTD	09/04-11/06	192 B5.000	1910		0-N2149	TB [DG]	
2.4 20V	10/01-11/06	192 A2.000	2446		0-N196	TB [TE]	
2.4 20V	10/01-11/06	192 A2.000	2446		0-N950	TB [DG]	
1.2 16V	02/02-11/06	188 A5.000	1242		0-N1517	VB [BT]	S
1.4 16V	01/04-11/06	192 B2.000, 843 A1.000	1368		0-N1517	VB [BT]	S
1.6 16V	10/01-11/06	182 B6.000	1596		0-N1450	VB [DG]	
1.6 16V	05/05-11/06	192 B3.000	1598		0-N1799	VB [BT]	S
1.8 16V	10/01-11/06	192 A4.000	1747		0-N1394	VB [DG]	
1.9 D Multijet, 1.9 JTD	10/01-11/06	192 A1.000, 937 A7.000, 192 A3.000, 192 A8.000, 192 A9.000, 192 B5.000	1910		0-N1408	VB [DG]	
1.9 D Multijet, 1.9 JTD	10/01-11/06	192 A1.000, 937 A7.000, 192 A3.000, 192 A5.000, 192 A8.000, 192 A9.000, 192 B5.000, 937 A4.000, 937 A5.000	1910		0-N1415	VB [DG]	
1.9 D Multijet, 1.9 JTD	10/01-11/06	192 A1.000, 937 A7.000, 192 A3.000, 192 A8.000, 192 A9.000, 192 B5.000	1910		0-N1487	VB [BT]	S
1.9 D Multijet, 1.9 JTD	09/03-11/06	192 A5.000, 192 B1.000, 937 A4.000, 937 A5.000	1910		0-N1394	VB [DG]	
1.9 D Multijet, 1.9 JTD	09/03-11/06	192 A5.000, 192 B1.000, 937 A4.000, 937 A5.000	1910		0-N1503	VB [BT]	S
2.4 20V	10/01-11/06	192 A2.000	2446		0-N1528	VB [BT]	S
2.4 20V	10/01-11/06	192 A2.000	2446		0-N1966	VB [DG]	

STILO Multi Wagon (192)

1.4 16V	01/04-08/08	192 B2.000, 843 A1.000	1368	22x124; Baumuster: 192	SK-1412	BTK	
1.4 16V	01/04-08/08	192 B2.000, 843 A1.000	1368	22x124	SK-1412AQ2	BTKW	
1.6 16V	01/03-08/08	182 B6.000	1596	25x158	SK-1076	BTK	
1.6 16V	03/05-12/07	192 B3.000	1598	24x146	SK-1607	BTK	
1.8 16V	01/03-08/08	192 A4.000	1747	24x166	SK-1415	BTK	

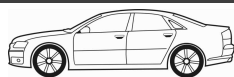

CM³



Art. Nr.



STILO Multi Wagon (192)

1.9 D Multijet	09/05-08/08	937 A5.000	1910	24x199	SK-1586	BTK	
1.9 D Multijet	09/05-08/08	937 A5.000	1910	24x199	SK-1586AQ1	BTKW	
1.9 D Multijet	09/05-08/08	192 A9.000	1910	24x190; <small>ENGINE</small> :4114650→	SK-1696	BTK	
1.9 D, 1.9 D Multijet, 1.9 JTD	01/03-08/08	192 A1.000, 937 A7.000, 192 A3.000, 192 A8.000, 192 A9.000, 192 B5.000	1910	24x190; mit Zubehör	SK-1629	BTK	
1.9 D, 1.9 D Multijet, 1.9 JTD	01/03-08/08	192 A1.000, 937 A7.000, 192 A3.000, 192 A8.000, 192 A9.000, 192 B5.000	1910	24x190; mit Zubehör	SK-1629AQ1	BTKW	
1.9 JTD	09/03-08/08	192 A5.000, 192 B1.000, 937 A4.000	1910	24x198; mit Zubehör	SK-1602	BTK	
1.9 JTD	09/03-08/08	192 A5.000, 192 B1.000, 937 A4.000	1910	24x198; mit Zubehör	SK-1602AQ1	BTKW	
1.4 16V	01/04-08/08	192 B2.000, 843 A1.000	1368		0-N195	TB [TE]	
1.6 16V	01/03-08/08	182 B6.000	1596		0-N208	TB [TE]	
1.6 16V	01/03-08/08	182 B6.000	1596		0-N951	TB [DG]	
1.6 16V	03/05-12/07	192 B3.000	1598		0-N1347	TB [TE]	
1.8 16V	01/03-08/08	192 A4.000	1747		0-N194	TB [TE]	
1.8 16V	01/03-08/08	192 A4.000	1747		0-N938	TB [DG]	
1.9 D	09/04-08/08	192 B5.000	1910		0-N2149	TB [DG]	
1.9 D Multijet, 1.9 JTD	01/04-08/08	192 A5.000, 192 A8.000, 192 A9.000, 192 B1.000, 937 A5.000	1910		0-N1326	TB [DG]	
1.9 D, 1.9 D Multijet, 1.9 JTD	01/03-08/08	192 A1.000, 937 A7.000, 192 A3.000, 192 A5.000, 192 A8.000, 192 A9.000, 192 B1.000, 192 B5.000, 937 A4.000, 937 A5.000	1910		0-N115	TB [TE]	
1.9 JTD	01/03-08/08	192 A1.000, 937 A7.000, 192 A3.000	1910	<small>ENGINE</small> :→4114649	0-N1326	TB [DG]	
1.9 JTD	01/03-08/08	192 A1.000, 937 A7.000, 192 A3.000	1910	<small>ENGINE</small> :4114650→	0-N2149	TB [DG]	
1.9 JTD	09/03-08/08	937 A4.000	1910	Abgasnorm: Euro 4 (D4)	0-N1326	TB [DG]	
1.9 JTD	09/03-08/08	937 A4.000	1910	<small>ENGINE</small> :→4109227; Abgasnorm: Euro 3 (D3)	0-N1326	TB [DG]	
1.9 JTD	09/03-08/08	937 A4.000	1910	<small>ENGINE</small> :4109228→; Abgasnorm: Euro 3 (D3)	0-N2149	TB [DG]	
1.4 16V	01/04-08/08	192 B2.000, 843 A1.000	1368		0-N1517	VB [BT]	S
1.6 16V	01/03-08/08	182 B6.000	1596		0-N1450	VB [DG]	
1.8 16V	01/03-08/08	192 A4.000	1747		0-N1394	VB [DG]	
1.9 D Multijet, 1.9 JTD	09/03-08/08	192 A5.000, 192 B1.000, 937 A4.000, 937 A5.000	1910		0-N1394	VB [DG]	
1.9 D Multijet, 1.9 JTD	09/03-08/08	192 A5.000, 192 B1.000, 937 A4.000, 937 A5.000	1910		0-N1503	VB [BT]	S
1.9 D, 1.9 D Multijet, 1.9 JTD	01/03-08/08	192 A1.000, 937 A7.000, 192 A3.000, 192 A8.000, 192 A9.000, 192 B5.000	1910		0-N1408	VB [DG]	
1.9 D, 1.9 D Multijet, 1.9 JTD	01/03-08/08	192 A1.000, 937 A7.000, 192 A3.000, 192 A5.000, 192 A8.000, 192 A9.000, 192 B5.000, 937 A5.000	1910		0-N1415	VB [DG]	
1.9 D, 1.9 D Multijet, 1.9 JTD	01/03-08/08	192 A1.000, 937 A7.000, 192 A3.000, 192 A8.000, 192 A9.000, 192 B5.000	1910		0-N1487	VB [BT]	S

STRADA Pick-up (178E)

1.2	06/99-	178 B5.000	1242	15x108; 02/2000 →; <small>ENGINE</small> :→9042883	SK-1043	BTK	
1.2	06/99-	178 B5.000	1242	15x129; 02/2000 →; <small>ENGINE</small> :9042883→	SK-1418	BTK	
1.2	06/99-	178 B5.000	1242	15x129; 02/2000 →; <small>ENGINE</small> :9042883→	SK-1418AQ1	BTKW	
1.2	06/99-	178 B5.000	1242	22x129; 01/2004 →; <small>ENGINE</small> :2546254→	SK-1677AQ1	BTKW	
1.2	04/03-	188 A4.000	1242	15x129	SK-1418	BTK	
1.2	04/03-	188 A4.000	1242	15x129	SK-1418AQ1	BTKW	
1.2	04/03-	188 A4.000	1242	22x129; → 06/2008; <small>ENGINE</small> :2546255→	SK-1677AQ1	BTKW	
1.2 Trekking	11/05-	178 B7.045	1242	22x129	SK-1677	BTK	
1.7 TD	06/99-	176 A3.000	1698	22x168; 02/2000 →	SK-1032	BTK	
1.9 D	12/00-	223 A6.000	1910	24x193; mit Zubehör	SK-1646	BTK	
1.9 D	12/00-	223 A6.000	1910	24x193	SK-1646AQ1	BTKW	
1.9 JTD	04/03-	188 A2.000	1910	24x190; mit Zubehör	SK-1629	BTK	
1.9 JTD	04/03-	188 A2.000	1910	24x190; mit Zubehör	SK-1629AQ1	BTKW	
1.2	06/99-	178 B5.000	1242	<small>ENGINE</small> :2546255→	0-N1616	TB [TE]	
1.2	06/99-	178 B5.000	1242	<small>ENGINE</small> :→2546254	0-N822	TB [TE]	
1.2	04/03-	188 A4.000	1242		0-N822	TB [TE]	
1.2 Trekking	11/05-	178 B7.045	1242		0-N1616	TB [TE]	
1.7 TD	06/99-	176 A3.000	1698		0-N819	TB [TE]	
1.7 TD	06/99-	176 A3.000	1698		0-N820	TB [DG]	
1.9 D	12/00-	223 A6.000	1910		0-N1326	TB [DG]	
1.9 D, 1.9 JTD	12/00-	188 A2.000, 223 A6.000	1910		0-N115	TB [TE]	
1.9 JTD	04/03-	188 A2.000	1910	<small>ENGINE</small> :→4114190	0-N1326	TB [DG]	
1.9 JTD	04/03-	188 A2.000	1910	<small>ENGINE</small> :4114191→	0-N2149	TB [DG]	
1.2	04/03-	188 A4.000	1242	⊛	0-N1399	VB [DG]	
1.2	04/03-	188 A4.000	1242		0-N1517	VB [BT]	S
1.3 D Multijet	05/06-	223 A9.000	1248		0-N1478S	VB [TE]	

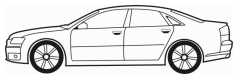

CM³



Art. Nr.



ohne Halter

STRADA Pick-up (178E)							
1.7 TD	06/99-	176 A3.000	1698			0-N1634	VB [DG]
1.7 TD	06/99-	176 A3.000	1698			0-N187	VB [DG]
1.9 D, 1.9 JTD	12/00-	188 A2.000, 223 A6.000	1910			0-N1487	VB [BT] S
1.9 D, 1.9 JTD	12/00-	188 A2.000, 223 A6.000	1910			0-N1630	VB [DG]
STRADA Pick-up (578_, 278_)							
1.3 D Multijet	10/10-	199 B1.000	1248			0-N2390	VB [BT] S
TALENTO Bus (290)							
1.9 D	03/89-03/94	149 B1.000	1929			0-N835	TB [TE]
1.9 D	03/89-03/94	149 B1.000	1929			0-N889	TB [DG]
TALENTO Kasten (290)							
1.9 D	03/89-03/94	149 B1.000	1929			0-N835	TB [TE]
1.9 D	03/89-03/94	149 B1.000	1929			0-N889	TB [DG]
TALENTO Pritsche/Fahrgestell (290)							
1.9 D	03/89-03/94	149 B1.000	1929			0-N835	TB [TE]
1.9 D	03/89-03/94	149 B1.000	1929			0-N889	TB [DG]
TEMPRA (159)							
1.4 i.e.	03/91-08/96	159 A2.000	1372	15x138; 07/1993 →		SK-1031	BTK
1.4 i.e.	03/92-08/96	160 A1.046, 836 A4.000	1372	15x138		SK-1031	BTK
1.6, 1.6 i.e.	03/90-08/96	159 A3.000, 159 B9.000, 159 A3.046, 159 A3.048, 159 A3.048, 835 C1.000, 159 B9.000	1581	15x138		SK-1031	BTK
1.8 i.e.	03/90-08/96	159 A4.000, 159 A4.046, 835 C4.000, 836 A5.000	1756	18x139		SK-1150	BTK
1.8 i.e.	03/90-08/96	159 A4.000, 159 A4.046	1756	18x142; Baumuster: 159AN		SK-1151	BTK
1.8 i.e.	09/93-08/96	835 C2.000, 835 C4.000, 836 A5.000	1756	18x142		SK-1151	BTK
1.9 D, 1.9 TD	05/90-08/96	149 A1.000, 160 A7.000, 160 A6.000, 160 D1.000, 160 B6.046	1929	22x173		SK-1033	BTK
2.0 i.e.	10/90-08/96	159 A6.046	1995	18x142		SK-1151	BTK
1.4 i.e.	03/91-08/96	159 A2.000, 160 A1.046, 836 A4.000	1372			0-N822	TB [TE]
1.6, 1.6 i.e.	03/90-08/96	159 A3.000, 159 B9.000, 159 A3.046, 159 A3.048, 835 C1.000, 159 B9.000	1581			0-N822	TB [TE]
1.8 i.e.	03/92-08/96	159 A4.046, 835 C2.000, 835 C4.000	1756			0-N832	TB [TE]
1.9 D, 1.9 TD	05/90-08/96	149 A1.000, 160 A7.000, 160 A6.000, 160 D1.000, 160 B6.046	1929			0-N835	TB [TE]
1.9 TD	05/90-08/96	160 A6.000, 160 D1.000, 160 B6.046	1929			0-N889	TB [DG]
2.0 i.e.	10/90-08/96	159 A6.046	1995			0-N832	TB [TE]
1.4 i.e.	03/92-08/96	160 A1.046, 836 A4.000	1372			0-N187	VB [DG]
1.6, 1.6 i.e.	03/90-08/96	159 A3.000, 159 B9.000, 159 A3.046, 159 A3.048, 835 C1.000, 159 B9.000	1581			0-N187	VB [DG]
1.9 TD	05/90-08/96	160 A6.000, 160 D1.000, 160 B6.046	1929	:935305→; *		0-N1629	VB [DG]
1.9 TD	05/90-08/96	160 A6.000, 160 D1.000, 160 B6.046	1929	:→953304		0-N187	VB [DG]
TEMPRA S.W. (159)							
1.4 i.e.	03/91-08/96	159 A2.000	1372	15x138		SK-1031	BTK
1.4 i.e.	10/92-08/96	160 A1.046, 836 A4.000	1372	15x138; 07/1993 →		SK-1031	BTK
1.6 i.e.	10/90-08/96	159 A3.046, 835 C1.000	1581	15x138; 04/1991 →		SK-1031	BTK
1.6, 1.6 i.e.	12/90-08/96	159 A3.000, 159 A3.048, 159 A3.048, 835 C1.000, 159 B9.000	1581	15x138		SK-1031	BTK
1.8 4x4, 1.8 i.e.	03/90-08/96	159 A4.000, 159 A4.046	1756	18x142; 01/1993 →		SK-1151	BTK
1.8 i.e.	03/90-08/96	159 A4.000, 159 A4.046, 835 C4.000, 836 A5.000	1756	18x139		SK-1150	BTK
1.8 i.e.	09/93-08/96	835 C2.000, 835 C4.000, 836 A5.000	1756	18x142		SK-1151	BTK
1.9 D, 1.9 TD	07/91-08/96	149 A1.000, 160 A7.000, 160 A6.000, 160 D1.000, 160 B6.046	1929	22x173		SK-1033	BTK
2.0 i.e., 2.0 i.e. 4x4	01/91-03/95	159 A6.046	1995	18x142		SK-1151	BTK
1.4 i.e.	03/91-08/96	159 A2.000, 160 A1.046, 836 A4.000	1372			0-N822	TB [TE]
1.6, 1.6 i.e.	10/90-08/96	159 A3.000, 159 A3.046, 835 C1.000, 159 A3.048, 835 C1.000, 159 B9.000	1581			0-N822	TB [TE]
1.8 i.e.	03/92-08/96	159 A4.046, 835 C2.000, 835 C4.000	1756			0-N832	TB [TE]
1.9 D, 1.9 TD	07/91-08/96	149 A1.000, 160 A7.000, 160 A6.000, 160 D1.000, 160 B6.046	1929			0-N835	TB [TE]
1.9 TD	07/91-02/95	160 A6.000, 160 D1.000, 160 B6.046	1929			0-N889	TB [DG]
2.0 i.e., 2.0 i.e. 4x4	01/91-03/95	159 A6.046	1995			0-N832	TB [TE]
1.4 i.e.	10/92-08/96	160 A1.046, 836 A4.000	1372			0-N187	VB [DG]
1.6, 1.6 i.e.	10/90-08/96	159 A3.000, 159 A3.046, 835 C1.000, 159 A3.048, 835 C1.000, 159 B9.000	1581			0-N187	VB [DG]
1.9 TD	07/91-02/95	160 A6.000, 160 D1.000, 160 B6.046	1929	:935305→; *		0-N1629	VB [DG]
1.9 TD	07/91-02/95	160 A6.000, 160 D1.000, 160 B6.046	1929	:→953304		0-N187	VB [DG]



OPTIMAL®

FIAT



CM³



Art. Nr.



TIPO (160)

1.1	01/88-10/91	160 A3.000	1108	15x104	SK-1023	BTK
1.1	01/88-10/91	160 A3.000	1108	15x104	SK-1665AQ1	BTKW
1.4	07/87-12/89	160 A1.000, 160 A1.048	1372	15x138; 03/1988 →	SK-1031	BTK
1.4 i.e.	05/89-04/95	159 A2.000, 160 A1.046, 836 A4.000	1372	15x138	SK-1031	BTK
1.6, 1.6 i.e.	01/88-04/95	159 A3.046, 159 A3.048, 835 C1.000, 160 A2.000	1581	15x138	SK-1031	BTK
1.6 i.e.	02/88-05/91	149 C2.046	1595	18x138	SK-1445	BTK
1.7 D	01/88-10/95	149 B4.000	1697	22x170	SK-1141	BTK
1.8 i.e, 1.8 i.e.	10/90-04/95	159 A4.000, 159 A4.046, 835 C4.000, 836 A5.000	1756	18x139	SK-1150	BTK
1.8 i.e, 1.8 i.e.	03/93-10/95	159 A4.000, 836 A5.000, 835 C2.000, 835 C4.000, 836 A5.000	1756	18x142	SK-1151	BTK
1.8 i.e.	10/90-06/93	159 A4.000, 159 A4.046	1756	18x142; 01/1993 →	SK-1151	BTK
1.8 i.e.	04/93-04/95	835 C2.000	1756	18x142	SK-1264	BTK
1.8 i.e.	10/94-10/95	159 A4.000, 836 A5.000	1756	18x142; 01/1995 →	SK-1264	BTK
1.8 i.e. 16V Sport	11/89-06/92	160 A5.000	1756	18x142; 04/1990 →; → 1066635	SK-1264	BTK
1.9 D, 1.9 TD	09/90-08/95	149 A1.000, 160 A7.000, 160 A6.000, 160 A6.046, 160 D1.000, 160 B6.046	1929	22x173	SK-1033	BTK
2.0 16V, 2.0 i.e. 16V Sport	07/91-04/95	160 A8.046, 836 A3.000	1995	18x173	SK-1050	BTK
2.0 i.e.	03/90-04/95	159 A6.046	1995	18x142; → 10/1992	SK-1151	BTK
2.0 i.e.	03/90-04/95	159 A6.046	1995	18x142; 03/1993 →	SK-1264	BTK
2.0, 2.0 i.e.	06/90-10/92	159 A5.046, 159 A5.046, 159 A6.046	1995	18x142	SK-1151	BTK
1.1	01/88-10/91	160 A3.000	1108		0-N822	TB [TE]
1.4, 1.4 i.e.	07/87-04/95	159 A2.000, 160 A1.000, 160 A1.048, 160 A1.046, 836 A4.000	1372		0-N822	TB [TE]
1.6, 1.6 i.e., 1.6 SX DGT	01/88-10/95	159 A3.000, 159 A3.046, 159 A3.048, 835 C1.000, 160 A2.000	1581		0-N822	TB [TE]
1.6 i.e.	02/88-05/91	149 C2.046	1595		0-N823	TB [TE]
1.7 D	01/88-10/95	149 B4.000	1697		0-N835	TB [TE]
1.7 D	01/88-10/94	149 B4.000	1697		0-N889	TB [DG]
1.8 i.e, 1.8 i.e.	10/90-04/95	159 A4.046, 835 C2.000, 835 C4.000, 836 A5.000	1756		0-N832	TB [TE]
1.8 i.e, 1.8 i.e.	03/93-10/95	159 A4.000, 836 A5.000, 835 C2.000, 835 C4.000, 836 A5.000	1756		0-N1105	TB [TE]
1.8 i.e.	10/90-10/95	159 A4.000, 159 A4.000, 836 A5.000	1756		0-N823	TB [TE]
1.8 i.e. 16V Sport	11/89-06/92	160 A5.000	1756		0-N818	TB [TE]
1.9 D, 1.9 TD	09/90-08/95	149 A1.000, 160 A7.000, 160 A6.000, 160 A6.046, 160 D1.000, 160 B6.046	1929		0-N835	TB [TE]
1.9 TD	09/90-04/95	160 A6.000, 160 A6.046, 160 D1.000, 160 B6.046	1929		0-N889	TB [DG]
2.0 16V, 2.0 i.e.	03/90-04/95	159 A5.046, 159 A6.046, 160 A8.046	1995		0-N1105	TB [TE]
2.0 16V, 2.0 i.e. 16V Sport	07/91-04/95	160 A8.046, 836 A3.000	1995		0-N818	TB [TE]
2.0 i.e.	03/90-04/95	159 A5.046, 159 A6.046	1995		0-N832	TB [TE]
1.1	01/88-10/91	160 A3.000	1108		0-N187	VB [DG]
1.4, 1.4 i.e.	07/87-04/95	159 A2.000, 160 A1.000, 160 A1.048	1372		0-N187	VB [DG]
1.4 i.e.	05/89-04/95	160 A1.046	1372		0-N187	VB [DG]
1.6, 1.6 i.e.	01/88-04/95	159 A3.046, 159 A3.048, 835 C1.000, 160 A2.000	1581		0-N187	VB [DG]
1.7 D	01/88-10/94	149 B4.000	1697	: → 953304; ⚠	0-N1629	VB [DG]
1.7 D	01/88-10/94	149 B4.000	1697	: 953305 →	0-N187	VB [DG]
1.9 TD	09/90-04/95	160 A6.000, 160 A6.046, 160 D1.000, 160 B6.046	1929	: → 953304; ⚠	0-N1629	VB [DG]
1.9 TD	09/90-04/95	160 A6.000, 160 A6.046, 160 D1.000, 160 B6.046	1929	: 953305 →	0-N187	VB [DG]

ULYSSE (179AX)

2.0	08/02-06/11	RFN (EW10J4)	1997	25.4x153	SK-1482	BTK
2.0	08/02-06/11	RFN (EW10J4)	1997	25.4x153	SK-1482AQ1	BTKW
2.0 D Multijet	05/06-06/11	RHK, RHR	1997	25.4x116; Baumuster: 179	SK-1594	BTK
2.0 D Multijet	05/06-06/11	RHK, RHR	1997	25.4x116	SK-1594AQ1	BTKW
2.0 JTD	08/02-08/06	RHW (DW10ATED4)	1997	25.4x144; 06/2003 →; Baumuster: 179	SK-1534	BTK
2.0 JTD	08/02-08/06	RHW (DW10ATED4)	1997	25.4x144	SK-1534AQ1	BTKW
2.0 JTD	05/03-08/06	RHM (DW10ATED4)	1997	25.4x144; Baumuster: 179AX	SK-1534	BTK
2.0 JTD	05/03-08/06	RHM (DW10ATED4)	1997	25.4x144; 06/2003 →	SK-1534AQ1	BTKW
2.2 D Multijet	03/08-06/11	4HS, 4HT (DW12BTED4)	2179	25.4x118	SK-1692	BTK
2.2 D Multijet	03/08-06/11	4HS, 4HT (DW12BTED4)	2179	25.4x118	SK-1692AQ1	BTKW
2.2 JTD	08/02-08/06	4HW (DW12ATED4)	2179	25.4x146; → 04/2004; VET → 10011	SK-1394	BTK
2.2 JTD	08/02-08/06	4HW (DW12ATED4)	2179	25.4x146; → 04/2004; VET → 11001	SK-1394AQ1	BTKW
2.2 JTD	08/02-08/06	4HW (DW12ATED4)	2179	25.4x146; 05/2004 →; Baumuster: 179; VET 11002 →	SK-1614	BTK



CM³



Art. Nr.



ULYSSE (179AX)

2.2 JTD	08/02-08/06	4HW (DW12ATED4)	2179	25.4x146; 05/2004 →; VET11002→	SK-1614AQ1	BTKW	
3.0 V6	08/02-06/11	XFW	2946	32x259	SK-1483	BTK	
3.0 V6	08/02-06/11	XFW	2946	32x259	SK-1483AQ1	BTKW	
2.0	08/02-06/11	RFN (EW10J4)	1997		0-N1057	TB [TE]	
2.0	08/02-06/11	RFN (EW10J4)	1997		0-N1065	TB [DG]	
2.0 D Multijet	05/06-06/11	RHK, RHR	1997		0-N1334	TB [DG]	
2.0 JTD	08/02-08/06	RHM (DW10ATED4), RHW (DW10ATED4)	1997		0-N118P	TB [TE]	
2.0 JTD	08/02-08/06	RHM (DW10ATED4), RHW (DW10ATED4)	1997		0-N119P	TB [DG]	
2.2 D Multijet	03/08-06/11	4HT	2179		0-N2018	TB [BT]	
2.2 D Multijet, 2.2 JTD	03/08-06/11	4HP, 4HR, 4HS, 4HT (DW12BTED4)	2179		0-N1334	TB [DG]	
2.2 JTD	08/02-08/06	4HW (DW12ATED4)	2179	→ 12/2003	0-N118P	TB [TE]	
2.2 JTD	08/02-08/06	4HW (DW12ATED4)	2179		0-N119P	TB [DG]	
2.2 JTD	08/02-08/06	4HW (DW12ATED4)	2179	01/2004 →	0-N1357	TB [TE]	
2.2 JTD	03/08-06/11	4HP, 4HR	2179		0-N2018	TB [BT]	
3.0 V6	08/02-06/11	XFW	2946		0-N1056	TB [TE]	
3.0 V6	08/02-06/11	XFW	2946		0-N170	TB [DG]	
3.0 V6	08/02-06/11	XFW	2946		0-N171	TB [DG]	
2.0	08/02-06/11	RFN (EW10J4)	1997		0-N1391	VB [BT]	S
2.0	08/02-06/11	RFN (EW10J4)	1997		0-N1416	VB [DG]	
2.0	08/02-06/11	RFN (EW10J4)	1997	11/2004 →	0-N2276	VB [DG]	
2.0 D Multijet	05/06-06/11	RHK, RHR	1997		0-N1327	VB [BT]	
2.0 D Multijet	05/06-06/11	RHK, RHR	1997	→ 07/2007; VET→11194	0-N2037	VB [BT]	S
2.0 D Multijet	05/06-06/11	RHK, RHR	1997	07/2007 →; VET11195→	0-N2046	VB [BT]	S
2.0 JTD	08/02-08/06	RHM (DW10ATED4), RHW (DW10ATED4)	1997		0-N1320	VB [TE]	
2.0 JTD	08/02-08/06	RHM (DW10ATED4), RHW (DW10ATED4)	1997		0-N1493	VB [BT]	S
2.2 D Multijet	03/08-06/11	4HS, 4HT (DW12BTED4)	2179		0-N2042	VB [BT]	S
2.2 JTD	08/02-08/06	4HW (DW12ATED4)	2179		0-N1413	VB [DG]	
2.2 JTD	08/02-08/06	4HW (DW12ATED4)	2179		0-N1493	VB [BT]	S
3.0 V6	08/02-06/11	XFW	2946		0-N1449	VB [TE]	
3.0 V6	08/02-06/11	XFW	2946		0-N1473	VB [BT]	S
3.0 V6	08/02-06/11	XFW	2946		0-N1757	VB [VD]	

ULYSSE (220)

1.8	05/97-08/02	LFW	1761	17x114	SK-1019	BTK	
1.9 TD	02/95-08/02	DHX (XUD9TF/L)	1905	25.4x136; Baumuster: 220AH5	SK-1022	BTK	
1.9 TD	02/95-08/02	DHX (XUD9TF/L)	1905	25.4x136; 04/1997 →; VET7391→	SK-1022AQ1	BTKW	
1.9 TD	02/95-08/02	DHX (XUD9TF/L)	1905	25.4x136; → 03/1997; Orga.→07390	SK-1022AQ2	BTKW	
2.0 , 2.0 Turbo	06/94-08/02	RFU (XU10J2C), RGX (XU10J2CTE)	1998	17x114	SK-1019	BTK	
2.0 16V	05/98-09/00	RFV	1998	25x136	SK-1082	BTK	
2.0 16V	05/98-09/00	RFV	1998	25x136	SK-1082AQ2	BTKW	
2.0 16V	09/00-08/02	RFN (EW10J4)	1997	25.4x153	SK-1482	BTK	
2.0 16V	09/00-08/02	RFN (EW10J4)	1997	25.4x153	SK-1482AQ1	BTKW	
2.0 JTD	10/99-08/02	RHZ	1997	25x141; → 04/2000; mit Zubehör; Baumuster: 220; VET→8561	SK-1085	BTK	
2.0 JTD	10/99-08/02	RHZ	1997	25.4x141; → 04/2000; mit Zubehör	SK-1085AQ1	BTKW	
2.0 JTD, 2.0 JTD 16V	05/99-08/02	RHW (DW10ATED4), RHZ	1997	25.4x144	SK-1534	BTK	
2.0 JTD, 2.0 JTD 16V	05/99-08/02	RHW (DW10ATED4), RHZ	1997	25.4x144	SK-1534AQ1	BTKW	
2.1 TD	03/96-10/99	P8C	2088	25.4x149	SK-1017	BTK	
2.1 TD	03/96-10/99	P8C	2088	25x149	SK-1017AQ1	BTKW	
1.8	05/97-08/02	LFW	1761		0-N811	TB [TE]	
1.9 TD	02/95-08/02	DHX (XUD9TF/L)	1905		0-N900	TB [DG]	
1.9 TD	02/95-08/02	DHX (XUD9TF/L)	1905		0-N901	TB [TE]	
2.0 , 2.0 Turbo	06/94-08/02	RFU (XU10J2C), RGX (XU10J2CTE)	1998		0-N811	TB [TE]	
2.0 16V	05/98-09/00	RFV	1998		0-N862	TB [DG]	
2.0 16V	05/98-09/00	RFV	1998		0-N943	TB [TE]	
2.0 16V	09/00-08/02	RFN (EW10J4)	1997		0-N1057	TB [TE]	
2.0 16V	09/00-08/02	RFN (EW10J4)	1997		0-N1065	TB [DG]	
2.0 JTD	10/99-08/02	RHZ	1997	→ 04/2000	0-N118P	TB [TE]	
2.0 JTD	10/99-08/02	RHZ	1997	→ 04/2000	0-N119P	TB [DG]	
2.0 JTD	10/99-08/02	RHZ	1997	04/2000 →	0-N1381	TB [DG]	
2.0 JTD 16V	05/99-08/02	RHW (DW10ATED4)	1997		0-N118P	TB [TE]	
2.0 JTD 16V	05/99-08/02	RHW (DW10ATED4)	1997		0-N119P	TB [DG]	
2.1 TD	03/96-10/99	P8C	2088		0-N862	TB [DG]	
2.1 TD	03/96-10/99	P8C	2088		0-N871	TB [TE]	
1.8	05/97-08/02	LFW	1761	→ 07/1998	0-N124	VB [TE]	
1.8	05/97-08/02	LFW	1761	☼	0-N1405	VB [DG]	



CM³



Art. Nr.



ULYSSE (220)

1.8	05/97-08/02	LFW	1761	☼	0-N1484	VB [BT]	S
1.8	05/97-08/02	LFW	1761	08/1998 →; ☼	0-N1968	VB [BT]	
1.9 TD	02/95-08/02	DHX (XUD9TF/L)	1905		0-N1320	VB [TE]	
1.9 TD	02/95-08/02	DHX (XUD9TF/L)	1905		0-N1472	VB [BT]	S
1.9 TD	02/95-08/02	DHX (XUD9TF/L)	1905		0-N1747	VB [VD]	
1.9 TD	02/95-08/02	DHX (XUD9TF/L)	1905		0-N931	VB [TE]	
2.0	06/94-08/02	RFU (XU10J2C)	1998	→ 07/1998	0-N124	VB [TE]	
2.0	06/94-08/02	RFU (XU10J2C)	1998	☼	0-N1405	VB [DG]	
2.0	06/94-08/02	RFU (XU10J2C)	1998	08/1998 →; ☼	0-N1968	VB [BT]	
2.0, 2.0 16V, 2.0 Turbo	06/94-08/02	RFU (XU10J2C), RFV, RGX (XU10J2CTE)	1998	☼	0-N1484	VB [BT]	S
2.0 16V	05/98-09/00	RFV	1998	☼	0-N1463S	VB [DG]	
2.0 16V	05/98-09/00	RFV	1998	☼	0-N1713	VB [BT]	
2.0 16V	05/98-09/00	RFV	1998	☼	0-N1722	VB [DG]	
2.0 16V	09/00-08/02	RFN (EW10J4)	1997		0-N1391	VB [BT]	S
2.0 16V	09/00-08/02	RFN (EW10J4)	1997		0-N1416	VB [DG]	
2.0 JTD	10/99-08/02	RHZ	1997		0-N1493	VB [BT]	S
2.0 JTD	10/99-08/02	RHZ	1997		0-N151	VB [DG]	
2.0 JTD	10/99-08/02	RHZ	1997	☼	0-N1748	VB [BT]	
2.0 JTD, 2.0 JTD 16V	05/99-08/02	RHW (DW10ATED4), RHZ	1997		0-N1320	VB [TE]	
2.0 Turbo	06/94-08/02	RGX (XU10J2CTE)	1998	→ 02/1997	0-N124	VB [TE]	
2.0 Turbo	06/94-08/02	RGX (XU10J2CTE)	1998	→ 02/1997; ☼	0-N1405	VB [DG]	
2.0 Turbo	06/94-08/02	RGX (XU10J2CTE)	1998	03/1997 →; ☼	0-N1463S	VB [DG]	
2.0 Turbo	06/94-08/02	RGX (XU10J2CTE)	1998	03/1997 →; ☼	0-N1713	VB [BT]	
2.0 Turbo	06/94-08/02	RGX (XU10J2CTE)	1998	03/1997 →; ☼	0-N1722	VB [DG]	
2.1 TD	03/96-10/99	P8C	2088		0-N1320	VB [TE]	
2.1 TD	03/96-10/99	P8C	2088		0-N1472	VB [BT]	S
2.1 TD	03/96-10/99	P8C	2088		0-N931	VB [TE]	

UNO (146A/E)

1.0	08/90-06/01	146 A2.166	994	15x125; ☼:9042884 →	SK-1421	BTK	
1.0	08/90-06/01	146 A2.166	994	15x125; ☼:9042884 →	SK-1421AQ1	BTKW	
1.0	08/90-06/01	146 A2.166	994	15x104; ☼:→9042883	SK-1665	BTK	
1.0 iE	05/98-08/00	156 A2.246	999	15x104; ☼:→9042883	SK-1665	BTK	
1.0, 1.0 iE	06/89-08/00	156 A2.000, 156 A2.246	999	15x125; ☼:9042884 →	SK-1421	BTK	
1.0, 1.0 iE, 45 1.0	06/86-08/00	156 A2.000, 156 A2.048, 156 A2.100, 156 A2.246	999	15x125; ☼:9042884 →	SK-1421AQ1	BTKW	
1.0, 1.0 iE, 45 1.0, 45 i.e. 1.0	04/84-08/00	156 A2.000, 156 A2.048, 156 A2.100, 156 A2.246	999	15x104; ☼:→9042883	SK-1023	BTK	
1.1	01/92-06/06	160 A3.000	1108	15x125; 01/1998 →; ☼:9042884 →	SK-1421	BTK	
1.1, 60 1.1	04/89-06/06	160 A3.000	1108	15x125; ☼:9042884 →	SK-1421AQ1	BTKW	
1.3 Turbo i.e.	04/85-03/91	146 A2.000, 146 A2.146, 146 A2.246	1301	19.05x118	SK-1138	BTK	
1.4 Turbo i.e.	09/89-09/93	146 A8.046	1372	15x138; 01/1992 →	SK-1031	BTK	
1.4, 1.4 Turbo i.e., 70 i.e. 1.4, 70 S 1.4	09/89-12/96	146 A8.000, 146 C1.000, 160 A1.046, 160 A1.048	1372	15x138	SK-1031	BTK	
1.7 D	11/94-08/00	146 B2.000	1697	22x168	SK-1032	BTK	
1.9 D	09/89-03/94	149 B5.046	1929	22x170	SK-1141	BTK	
45 1.0	06/86-12/93		999	15x104; 09/1989 →; ☼:→9042883	SK-1023	BTK	
45 1.0	06/86-12/93	156 A2.048, 156 A2.100	999	15x125; 06/1989 →; ☼:9042884 →	SK-1421	BTK	
45 1.0, 45 i.e. 1.0	04/84-10/95	156 A2.246	999	15x125; 09/1989 →; ☼:9042884 →	SK-1421	BTK	
45 1.0, 45 i.e. 1.0	04/84-10/95	156 A2.048, 156 A2.100, 156 A2.246	999	15x104; ☼:→9042883	SK-1665AQ1	BTKW	
45 i.e. 1.0	04/84-10/95	156 A2.246	999	15x125; 10/1984 →; ☼:9042884 →	SK-1421AQ1	BTKW	
50 1.1	01/90-12/93	156 C.046	1108	15x125; 10/1990 →; ☼:9042884 →	SK-1421	BTK	
50 1.1	01/90-12/93	156 C.046	1108	15x125; 10/1990 →; ☼:9042884 →	SK-1421AQ1	BTKW	
50 1.1	01/90-12/93	156 C.046	1108	15x104; ☼:→9042883	SK-1665AQ1	BTKW	
50 1.1, 50 i.e. 1.1	01/86-12/93	146 A4.044, 146 C3.000	1116	15x104	SK-1023	BTK	
50 1.1, 50 i.e. 1.1	01/86-12/93	146 A4.044, 146 C3.000	1116	15x104	SK-1665AQ1	BTKW	
50 1.1, 60 1.1	04/89-12/93	156 C.046, 160 A3.000	1108	15x104; ☼:→9042883	SK-1023	BTK	
50 i.e. 1.1	06/92-12/93	146 C3.000	1116	15x125; ☼:9042884 →	SK-1421	BTK	
50 i.e. 1.1	06/92-12/93	146 C3.000	1116	15x125; ☼:9042884 →	SK-1421AQ1	BTKW	
60 1.1	04/89-12/92	160 A3.000	1108	15x125; ☼:9042884 →	SK-1421	BTK	
60 Diesel 1.7	07/86-12/93	146 B2.000, 149 B3.000	1698	22x168	SK-1032	BTK	
70 TD 1.4	10/86-10/90	146 B.000, 146 B3.000	1367	21x165	SK-1140	BTK	
75 i.e. 1.5	10/85-12/93	138 C2.048, 149 C1.000	1499	15x138; 01/1989 →	SK-1031	BTK	
75 i.e. 1.5	10/85-12/93	149 C1.000	1499	19.05x118; 01/1989 →	SK-1138	BTK	
1.3 Turbo i.e.	04/85-03/91	146 A2.000, 146 A2.146, 146 A2.246	1301		0-N818	TB [TE]	
1.4 Turbo i.e., 70 i.e. 1.4	09/89-12/96	146 A8.000, 146 A8.046, 160 A1.046	1372		0-N822	TB [TE]	
1.9 D	09/89-03/94	149 B5.046	1929		0-N819	TB [TE]	



CM³



Art. Nr.



ohne Halter

UNO (146A/E)

1.9 D	09/89-03/94	149 B5.046	1929		0-N820	TB [DG]
45 1.0	06/86-12/93		999		0-N850	TB [TE]
45 1.0, 45 i.e. 1.0	04/84-10/95	156 A2.048, 156 A2.100, 156 A2.246	999		0-N822	TB [TE]
50 1.1, 50 i.e. 1.1	01/86-12/93	146 A4.044, 146 C3.000	1116		0-N822	TB [TE]
50 1.1, 60 1.1	04/89-12/93	156 C.046, 160 A3.000	1108		0-N822	TB [TE]
55 1.0	11/93-08/00	146 C4.011	996		0-N850	TB [TE]
55 1.1, 60 1.1	01/83-08/89	138 B.000, 146 A4.048	1116	ch.1821990, 967610→	0-N818	TB [TE]
60 Diesel 1.7	07/86-12/93	146 B2.000, 149 B3.000	1698		0-N819	TB [TE]
60 Diesel 1.7	07/86-12/93	146 B2.000, 149 B3.000	1698		0-N820	TB [DG]
70 1.3	01/83-08/89	138 B2.000, 149 A7.000	1302	:5771823→	0-N818	TB [TE]
70 TD 1.4	10/86-10/90	146 B.000, 146 B3.000	1367		0-N819	TB [TE]
70 TD 1.4	10/86-10/90	146 B.000, 146 B3.000	1367		0-N820	TB [DG]
75 i.e. 1.5	10/85-12/93	138 C2.048, 149 C1.000	1499		0-N818	TB [TE]
1.4 Turbo i.e., 70 i.e. 1.4	09/89-12/93	146 A8.046, 160 A1.046	1372		0-N187	VB [DG]
60 1.1	05/85-08/89	146 A4.048	1116		0-N187	VB [DG]
60 1.1	04/89-12/92	160 A3.000	1108		0-N187	VB [DG]
75 i.e. 1.5	10/85-12/93	138 C2.048, 149 C1.000	1499		0-N187	VB [DG]

UNO Kasten (146)

1.7 D	02/88-02/92	146 B2.000, 149 B4.046	1697	22x168; 09/1989 →	SK-1032	BTK
-------	-------------	------------------------	------	-------------------	---------	-----



CM³



Art. Nr.



ohne Halter

PALIO Kombi

1.3	01/02-	188 A5.000	1242	22x124; 06/2003 →	SK-1412AQ2	BTKW	
1.3	01/02-	188 A5.000	1242		0-N822	TB [TE]	

PALIO Schrägheck

1.3	01/02-	188 A5.000	1242	22x124	SK-1412AQ2	BTKW	
1.3	01/02-	188 A4.000	1242	15x129	SK-1418	BTK	
1.3	01/02-	188 A4.000	1242	15x129	SK-1418AQ1	BTKW	
1.3	01/02-	188 A5.000	1242		0-N195	TB [TE]	
1.3	01/02-	188 A4.000	1242		0-N822	TB [TE]	

SIENA

1.3	01/03-	188 A5.000	1242	22x124	SK-1412AQ2	BTKW	
1.3	01/03-	188 A4.000	1242	15x129; :9042884 →	SK-1418	BTK	
1.3	01/03-	188 A4.000	1242	15x129; :9042884 →	SK-1418AQ1	BTKW	
1.3	01/03-	188 A4.000, 188 A5.000	1242		0-N822	TB [TE]	

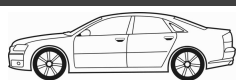

CM³



Art. Nr.



B-MAX (JK)								
1.4	10/12-	SPJD	1388	22x117; mit Zubehör	SK-1659	BTK		
1.4	10/12-	SPJD	1388	22x117; mit Zubehör	SK-1659AQ1	BTKW		
1.5 TDCi	10/12-	UGJC	1499	25x141	SK-1728	BTK		
1.5 TDCi	10/12-	UGJC	1499	25x141	SK-1728AQ1	BTKW		
1.6 TDCi	10/12-	T3JB	1560	25x141	SK-1728	BTK		
1.6 TDCi	10/12-	T3JB	1560	25x141	SK-1728AQ1	BTKW		
1.6 Ti	10/12-	IQJA	1596	22x117; mit Zubehör	SK-1659	BTK		
1.6 Ti	10/12-	IQJA	1596	22x117; mit Zubehör	SK-1659AQ1	BTKW		
1.4, 1.4 LPG	10/12-	RTJC, SPJD	1388		0-N1564	TB [TE]		
1.5 TDCi	10/12-	UGJC	1499		0-N2224	TB [TE]		
1.5 TDCi	10/12-	UGJC, XVJA, XVJC	1499		0-N2382	TB [DG]		
1.6 TDCi	10/12-	T3JB	1560		0-N2224	TB [TE]		
1.6 TDCi	10/12-	T3JB	1560		0-N2382	TB [DG]		
1.6 Ti	10/12-	IQJA	1596		0-N1564	TB [TE]		
1.0 EcoBoost	10/12-	M1JA, M1JE, SFJA, SFJB, SFJC, SFJD	998		0-N2300	VB [BT]		S
1.0 EcoBoost	10/12-	M1JA, M1JE, SFJA, SFJB, SFJC, SFJD	998		0-N2303	VB [DG]		
1.0 EcoBoost	10/12-	M1JA, M1JE, SFJA, SFJB, SFJC, SFJD	998	✘	0-N2353	VB [DG]		
1.4, 1.4 LPG	10/12-	RTJC, SPJD	1388	✘	0-N2353	VB [DG]		
1.5 TDCi	10/12-	UGJC	1499		0-N1339	VB [BT]		S
1.6 TDCi	10/12-	T3JB	1560		0-N1339	VB [BT]		S
1.6 Ti	10/12-	IQJA	1596	✘	0-N2353	VB [DG]		
B-MAX Van								
1.5 TDCi	10/12-	UGJC	1499	25x141	SK-1728	BTK		
1.5 TDCi	10/12-	UGJC	1499	25x141	SK-1728AQ1	BTKW		
1.6 TDCi	10/12-	T3JB	1560	25x141	SK-1728	BTK		
1.6 TDCi	10/12-	T3JB	1560	25x141	SK-1728AQ1	BTKW		
1.4	10/12-	SPJD	1388		0-N1564	TB [TE]		
1.5 TDCi	10/12-	UGJC, XVJA, XVJC	1499		0-N2382	TB [DG]		
1.6 TDCi	10/12-	T3JB	1560		0-N2382	TB [DG]		
1.6 Ti	10/12-	IQJA	1596		0-N1564	TB [TE]		
1.0 EcoBoost	10/12-	M1JE, SFJA, SFJB, SFJC, SFJD	998		0-N2300	VB [BT]		S
1.0 EcoBoost	10/12-	M1JE, SFJA, SFJB, SFJC, SFJD	998		0-N2303	VB [DG]		
1.0 EcoBoost	10/12-	M1JE, SFJA, SFJB, SFJC, SFJD	998	✘	0-N2353	VB [DG]		
1.4	10/12-	SPJD	1388	✘	0-N2353	VB [DG]		
1.6 Ti	10/12-	IQJA	1596	✘	0-N2353	VB [DG]		
CAPRI (ECJ)								
1600	08/72-02/74	OHC TL 16 H	1593	19.05x119; Nockenwelle: SOHC/OHC	SK-1160	BTK		
1600	08/72-02/74	LE	1593	19.05x119; Nockenwelle: SOHC/OHC; 11/1972 →	SK-1160	BTK		
1600 GT	01/69-10/72		1599	19.05x119; Nockenwelle: SOHC/OHC	SK-1160	BTK		
1300	12/68-12/72	EV 13 H, EV 13 L	1305		0-N839	TB [TE]		
1600	08/72-02/74	LE	1593		0-N839	TB [TE]		
CAPRI II (GECF)								
1.6	02/74-12/77	LAC, LCE, LEC	1593	19.05x119; Nockenwelle: SOHC/OHC	SK-1160	BTK		
1.3	02/74-08/77	J1E	1298		0-N839	TB [TE]		
1.6	02/74-12/77	LAC, LCE, LEC	1593		0-N839	TB [TE]		
CAPRI III (GECF)								
1.6	01/78-04/87	LCN	1593	19.05x119; Nockenwelle: SOHC/OHC	SK-1160	BTK		
1.3	01/78-06/85	J1E	1298		0-N839	TB [TE]		
1.6	01/78-04/87	LCN	1593		0-N839	TB [TE]		
2.0	01/78-12/85	NEN, OHC TL 20 H	1993		0-N839	TB [TE]		
2.0	01/78-12/85		1994		0-N839	TB [TE]		
C-MAX (DM2)								
1.6	02/07-09/10	HWDA, HWDB, SHDA, SHDB, SHDC	1596	22x117; mit Zubehör	SK-1659	BTK		
1.6	02/07-09/10	HWDA, HWDB, SHDA, SHDB, SHDC	1596	22x117; mit Zubehör	SK-1659AQ1	BTKW		
1.6 TDCi	02/07-09/10	G8DA, G8DB, G8DD, G8DC, MTDA, GPDA, HHDA, HHDB	1560	25x137; → 12/2009	SK-1424	BTK		
1.6 TDCi	02/07-09/10	G8DA, G8DB, G8DD, G8DC, MTDA, GPDA, HHDA, HHDB	1560	25x137; → 12/2009	SK-1424AQ1	BTKW		
1.8 TDCi	02/07-09/10	KKDA	1753	20x91	SK-1341	BTK		
2.0 TDCi	02/07-09/10	G6DA, G6DB, G6DD, G6DG, G6DC, G6DE, G6DF, IXDA	1997	25.4x116	SK-1594	BTK		
2.0 TDCi	02/07-09/10	G6DA, G6DB, G6DD, G6DG, G6DC, G6DE, G6DF, IXDA	1997	25.4x116	SK-1594AQ1	BTKW		
1.6	02/07-09/10	HWDA, HWDB, SHDA, SHDB, SHDC	1596		0-N1564	TB [TE]		



OPTIMAL®

FORD

**CM³**

Art. Nr.



C-MAX (DM2)										
1.6 TDCi	02/07-09/10	G8DA, G8DB, G8DD, G8DC, MTDA, GPDA, HHDA, HHDB	1560					0-N1062	TB [TE]	
1.6 TDCi	02/07-09/10	G8DA, G8DB, G8DD, G8DC, MTDA, GPDA, HHDA, HHDB	1560					0-N1066	TB [DG]	
1.8 TDCi	02/07-09/10	KKDA	1753					0-N1367	TB [TE]	
2.0 TDCi	02/07-09/10	G6DA, G6DB, G6DD, G6DG, G6DC, G6DE, G6DF, IXDA	1997					0-N1334	TB [DG]	
1.6 TDCi	02/07-09/10	G8DA, G8DB, G8DD, G8DC, MTDA, GPDA, HHDA, HHDB	1560					0-N1339	VB [BT]	S
1.6 TDCi	02/07-09/10	G8DA, G8DB, G8DD, G8DC, MTDA, GPDA, HHDA, HHDB	1560					0-N1418	VB [DG]	
1.8	02/07-09/10	QQDC	1798	→ 01/2008				0-N1639	VB [BT]	S
1.8 TDCi	02/07-09/10	KKDA	1753					0-N1622	VB [DG]	
1.8 TDCi	02/07-09/10	KKDA	1753					0-N1709	VB [BT]	
1.8 TDCi	02/07-09/10	KKDA	1753					0-N1709S1	VB [TE]	
1.8 TDCi	02/07-09/10	KKDA	1753	Rippenanzahl: 6				0-N1709S2	VB [TE]	
1.8, 1.8 Flexifuel	02/07-09/10	Q7DA, QQDA, QQDB	1798					0-N1639	VB [BT]	S
1.8, 1.8 Flexifuel	02/07-09/10	Q7DA, QQDA, QQDB, QQDC	1798	01/2008 →				0-N2353	VB [DG]	
2.0	02/07-09/10	AODA, AODB, AODE, SYDA	1999					0-N1639	VB [BT]	S
2.0	02/07-09/10	AODA, AODB, AODE, SYDA	1999	01/2008 →				0-N2353	VB [DG]	
2.0 CNG, 2.0 LPG	06/08-09/10	SYDA	1999					0-N2353	VB [DG]	
2.0 TDCi	02/07-09/10	G6DA, G6DB, G6DD, G6DG, IXDA	1997					0-N1327	VB [BT]	

C-MAX II (DXA/CB7, DXA/CEU)										
1.6 Flexifuel, 1.6 LPG, 1.6 Ti	12/10-	IQDA, IQDB, MUDA, PNDA, XTDA	1596	22x117; mit Zubehör				SK-1659AQ1	BTKW	
1.6 TDCi	12/10-	T1DA, T1DB, T3DA, T3DB	1560	25x141				SK-1728	BTK	
1.6 TDCi	12/10-	T1DA, T1DB, T3DA, T3DB	1560	25x141				SK-1728AQ1	BTKW	
1.6 Ti	12/10-	IQDA, IQDB	1596	22x117; mit Zubehör				SK-1659	BTK	
2.0 TDCi	12/10-	TXDB, TYDA, UFDB, UKDB	1997	25x116				SK-1714	BTK	
2.0 TDCi	12/10-	TXDB, TYDA, UFDB, UKDB	1997	25x116				SK-1714AQ1	BTKW	
1.5 TDCi, 1.5 TDCi ECOnetic	03/15-	AEDA, XWDA, XWDB, XXDA	1499					0-N2382	TB [DG]	
1.6 EcoBoost	12/10-	JQDA, JQDB, JTDA, JTDB	1596					0-N2057	TB [TE]	
1.6 Flexifuel, 1.6 LPG, 1.6 Ti	12/10-	IQDA, IQDB, MUDA, PNDA, XTDA	1596					0-N1564	TB [TE]	
1.6 TDCi	12/10-	T1DA, T1DB, T3DA, T3DB	1560					0-N2224	TB [TE]	
1.6 TDCi	12/10-	T1DA, T1DB, T3DA, T3DB	1560					0-N2382	TB [DG]	
2.0 TDCi	12/10-	TXDB, TYDA, UFDB, UKDB	1997					0-N1334	TB [DG]	
2.0 TDCi	12/10-	TXDB, TYDA, UFDB, UKDB	1997					0-N2063	TB [TE]	
1.0 EcoBoost	10/12-	M1DA, M2DA, SFDA	998					0-N2300	VB [BT]	S
1.0 EcoBoost	10/12-	M1DA, M2DA, SFDA	998					0-N2303	VB [DG]	
1.0 EcoBoost	10/12-	M1DA, M2DA, SFDA	998	✘				0-N2353	VB [DG]	
1.6 EcoBoost	12/10-	JQDA, JQDB, JTDA, JTDB	1596					0-N2269	VB [BT]	S
1.6 EcoBoost	12/10-	JQDA, JQDB, JTDA, JTDB	1596					0-N2363	VB [DG]	
1.6 Flexifuel, 1.6 LPG, 1.6 Ti	12/10-	IQDA, IQDB, MUDA, PNDA, XTDA	1596	✘				0-N2353	VB [DG]	
1.6 TDCi	12/10-	T1DA, T1DB, T3DA, T3DB	1560					0-N1339	VB [BT]	S
1.6 TDCi	12/10-	T1DA, T1DB, T3DA, T3DB	1560					0-N1418	VB [DG]	
2.0 TDCi	12/10-	TXDB, TYDA, UFDB, UKDB	1997					0-N2396	VB [BT]	S

C-MAX II Van										
1.6 TDCi	12/10-	T1DA, T1DB, T3DA, T3DB	1560	25x141				SK-1728	BTK	
1.6 TDCi	12/10-	T1DA, T1DB, T3DA, T3DB	1560	25x141				SK-1728AQ1	BTKW	
2.0 TDCi	12/10-	TXDB, TYDA, UFDB	1997	25x116				SK-1714AQ1	BTKW	
1.5 TDCi	03/15-	XWDA, XWDB	1499					0-N2382	TB [DG]	
1.6 EcoBoost	12/10-	JQDA, JQDB	1596					0-N2057	TB [TE]	
1.6 TDCi	12/10-	T1DA, T1DB, T3DA, T3DB	1560					0-N2224	TB [TE]	
1.6 TDCi	12/10-	T1DA, T1DB, T3DA, T3DB	1560					0-N2382	TB [DG]	
1.6 EcoBoost	12/10-	JQDA, JQDB	1596					0-N2363	VB [DG]	

CONSUL (GGFL)										
2000	01/72-12/75		1993					0-N839	TB [TE]	

CONSUL Coupe (GGCL)										
2000	01/72-12/75		1993					0-N839	TB [TE]	

CONSUL Turnier (GGNL)										
2000	01/72-12/75		1993					0-N839	TB [TE]	

CORTINA										
1600 GT	10/70-03/72	LCJ	1593	19.05x119; 09/1971 →				SK-1160	BTK	

CORTINA Coupe										
1600 GT	10/70-03/72	LCJ	1593	19.05x119; 09/1971 →				SK-1160	BTK	

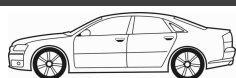

CM³



Art. Nr.



COUGAR (EC_)								
2.0 16V	08/98-12/01	EDBA, EDBB, EDBC, EDBD	1988	25x129; → 01/1999; beinhaltete Rollen: 3	SK-1339	BTK		
2.0 16V	08/98-12/01	EDBA, EDBB, EDBC, EDBD	1988	25x129; 02/1999 →; beinhaltete Rollen: 2	SK-1340	BTK		
2.0 16V	08/98-12/01	EDBA, EDBB, EDBC, EDBD	1988		0-N290	TB [TE]		
2.0 16V	08/98-12/01	EDBA, EDBB, EDBC, EDBD	1988	01/1999 →; †	0-N291	TB [DG]		
2.0 16V	08/98-12/01	EDBA, EDBB, EDBC, EDBD	1988	→ 01/1999	0-N292	TB [DG]		
2.0 16V	08/98-12/01	EDBA, EDBB, EDBC, EDBD	1988	→ 01/1999	0-N293	TB [DG]		
2.0 16V	08/98-12/01	EDBA, EDBB, EDBC, EDBD	1988	Rippenanzahl: 6	0-N1435	VB [BT]	S	
2.5 ST 200, 2.5 V6 24V	01/00-12/01	LCBB, LCBC, LCBE, SGA	2495		0-N2028	VB [DG]		
2.5 V6 24V	08/98-12/01	LCBA	2544		0-N2028	VB [DG]		

COURIER Pick-up								
1.8 D	06/99-02/02	RTK	1753	22x116; 22x85; mit Zubehör	SK-1078	BTK		
1.8 D	06/99-02/02	RTK	1753	22x116; 22x85	SK-1078AQ1	BTKW		
1.8 D	06/99-02/02	RTK	1753		0-N089	TB [TE]		
1.8 D	06/99-02/02	RTK	1753		0-N123	TB [TE]		
1.8 D	06/99-02/02	RTK	1753		0-N915	TB [TE]		

COURIER Kasten (F3L, F5L)								
1.8 D	09/91-02/96	RTC, RTD, RTG	1753	20x116; 22x85; → 10/1995; mit Zubehör	SK-1041	BTK		
1.8 D	09/91-02/96	RTC, RTD, RTG	1753	22x116; 22x85; 10/1995 →	SK-1042	BTK		
1.8 D	09/91-02/96	RTC, RTD, RTG	1753	22x116; 22x85; 10/1995 →	SK-1042AQ1	BTKW		
1.8 D	09/91-02/96	RTC, RTD, RTG	1753	→ 10/1995	0-N874	TB [TE]		
1.8 D	09/91-02/96	RTC, RTD, RTG	1753		0-N902	TB [DG]		
1.8 D	09/91-02/96	RTC, RTD, RTG	1753		0-N915	TB [TE]		
1.8 D	09/91-02/96	RTC, RTD, RTG	1753	10/1995 →	0-N985	TB [TE]		
1.3	09/91-02/96	J6B	1299	01/1994 →	0-N1401	VB [DG]		
1.3	09/91-02/96	J6B	1299	08/1995 →; für Fahrzeuge mit Servolenkung	0-N1443	VB [BT]	S	
1.8 D	09/91-02/96	RTC, RTD, RTG	1753	01/1994 → 10/1995; Rippenanzahl: 4	0-N1400	VB [TE]	S	
1.8 D	09/91-02/96	RTC, RTD, RTG	1753	10/1995 →	0-N1501	VB [BT]	S	

COURIER Kasten (J5_, J3_)								
1.4 i	04/96-10/99	FHA	1388	22x117; 02/1997 →; mit Zubehör	SK-1077	BTK		
1.4 i	04/96-10/99	FHA	1388	22x117; 04/1998 →; mit Zubehör	SK-1077	BTK		
1.4 i	04/96-10/99	FHA	1388	22x117; → 02/1997	SK-1105	BTK		
1.8 D	02/96-04/02	RTK	1753	22x116; 22x85; → 01/1997	SK-1042	BTK		
1.8 D	02/96-04/02	RTK	1753	22x116; 22x85; → 01/1997; Baumuster: Courier	SK-1042AQ1	BTKW		
1.8 D	02/96-04/02	RTK	1753	22x116; 22x85; 01/1997 →; mit Zubehör	SK-1078	BTK		
1.8 D	02/96-04/02	RTK	1753	22x116; 22x85; 01/1997 →; Baumuster: Courier	SK-1078AQ1	BTKW		
1.8 DI	09/00-08/03	RTN, RTP	1753	20x91	SK-1341	BTK		
1.4 i	04/96-10/99	FHA	1388	→ 02/1997	0-N1260	TB [TE]		
1.4 i	04/96-10/99	FHA	1388	03/1997 →	0-N294	TB [TE]		
1.8 D	02/96-04/02	RTK	1753	09/1996 →	0-N089	TB [TE]		
1.8 D	02/96-04/02	RTK	1753	09/1996 →	0-N123	TB [TE]		
1.8 D	02/96-04/02	RTK	1753	→ 09/1996	0-N902	TB [DG]		
1.8 D	02/96-04/02	RTK	1753		0-N915	TB [TE]		
1.8 D	02/96-04/02	RTK	1753	→ 09/1996	0-N985	TB [TE]		
1.8 DI	09/00-08/03	RTN, RTP	1753		0-N1367	TB [TE]		
1.8 DI	09/00-08/03	RTN, RTP	1753		0-N295	TB [TE]		
1.3	02/96-	J4C	1299	für Fahrzeuge mit Servolenkung	0-N1443	VB [BT]	S	
1.4 i	04/96-10/99	FHA	1388	Rippenanzahl: 6; für Fahrzeuge mit Servolenkung, ⚡	0-N1897	VB [BT]	S	
1.4 i	04/96-10/99	FHA	1388	Rippenanzahl: 6; ⚡, für Fahrzeuge ohne Servolenkung	0-N1897	VB [BT]	S	
1.4 i	04/96-10/99	FHA	1388	Rippenanzahl: 6; ⚡, für Fahrzeuge ohne Servolenkung	0-N1897	VB [BT]	S	
1.8 D	02/96-04/02	RTK	1753		0-N1501	VB [BT]	S	
1.8 D	02/96-04/02	RTK	1753	⚡	0-N2022	VB [BT]	S	
1.8 DI	09/00-08/03	RTN, RTP	1753	†; ⚡	0-N1458	VB [DG]		
1.8 DI	09/00-08/03	RTN, RTP	1753		0-N1622	VB [DG]		
1.8 DI	09/00-08/03	RTN, RTP	1753		0-N2155	VB [BT]	S	

ECONOVAN (KBA, KCA)								
1.4	03/86-03/92	UC	1416		0-N837	TB [TE]		
2.0 D	03/86-03/92	RF	1998		0-N1216	TB [TE]		
1.4	03/86-03/92	UC	1416	mit Anbaumaterial	0-N197	VB [DG]		

ECONOVAN Kasten (KAA)								
1.4	03/86-03/92	UC	1416		0-N837	TB [TE]		

CM³

Art. Nr.

**ECONOVAN Kasten (KAA)**

2.0 D	03/86-03/92	RF	1998		0-N1216	TB [TE]
1.4	03/86-03/92	UC	1416	mit Anbaumaterial	0-N197	VB [DG]

ECOSPORT

1.5 TDCi	10/13-	UGJE	1499	25x141	SK-1728	BTK
1.5 TDCi	10/13-	UGJE	1499	25x141	SK-1728AQ1	BTKW
1.5 TDCi	10/13-	UGJE, XVJD	1499		0-N2382	TB [DG]
1.5 Ti	10/13-	UEJB	1498		0-N1564	TB [TE]
1.5 TDCi	10/13-	UGJE	1499		0-N1339	VB [BT] S
EcoBoost 1.0	10/13-	M1JC	998		0-N2300	VB [BT] S
EcoBoost 1.0	10/13-	M1JC	998		0-N2303	VB [DG]
EcoBoost 1.0	10/13-	M1JC	998	✳	0-N2353	VB [DG]

ESCORT '81 Express (AVA)

1.6	03/81-02/86		1567	19x97; Baumuster: 55	SK-1027	BTK
1.6 D	02/84-02/86	LTA	1608	19.05x98	SK-1039	BTK
1.6	03/81-02/86		1567		0-N837	TB [TE]
1.6 D	02/84-02/86	LTA	1608		0-N838	TB [TE]
1.3	03/81-02/86	JPA	1296	mit Anbaumaterial	0-N197	VB [DG]

ESCORT '86 Express (AVF)

1.4 i	02/86-07/90	F6B, F6D, FUC	1392	19x97; 09/1988 →	SK-1027	BTK
1.6	02/86-07/90	LUC	1597	19x97	SK-1027	BTK
1.6 D	02/86-07/90	LTA	1608	19.05x98	SK-1039	BTK
1.8 D	07/88-07/90	RTA	1753	20x116; 22x85; mit Zubehör	SK-1041	BTK
1.4 i	02/86-07/90	F6B, F6D, FUC	1392		0-N837	TB [TE]
1.6	02/86-07/90	LUC	1597		0-N837	TB [TE]
1.6 D	02/86-07/90	LTA	1608		0-N838	TB [TE]
1.8 D	07/88-07/90	RTA, RTB	1753		0-N874	TB [TE]
1.8 D	07/88-07/90	RTA, RTB	1753		0-N902	TB [DG]
1.8 D	07/88-07/90	RTA, RTB	1753		0-N915	TB [TE]

ESCORT '91 Express (AVL)

1.4	07/90-12/94	F6F, F6G	1391	19x97; → 04/1992	SK-1027	BTK
1.4	07/90-12/94	F6F, F6G	1391	21x97; 04/1992 →; Baumuster: Escort-Express 40	SK-1053	BTK
1.4	07/90-12/94	F6F, F6G	1391	21x97; 04/1992 →; Baumuster: Escort-Express 60	SK-1053	BTK
1.4	07/90-12/94	F6F, F6G	1391	21.6x97; 04/1992 →; Baumuster: Escort-Express 40	SK-1053AQ1	BTKW
1.4	07/90-12/94	F6F, F6G	1391	21.6x97; 04/1992 →; Baumuster: Escort-Express 60	SK-1053AQ1	BTKW
1.8 D	07/90-12/94	RTH	1753	20x116; 22x85; mit Zubehör	SK-1041	BTK
1.4	07/90-12/94	F6F, F6G	1391		0-N837	TB [TE]
1.8 D	07/90-12/94	RTH	1753		0-N874	TB [TE]
1.8 D	07/90-12/94	RTH	1753		0-N902	TB [DG]
1.8 D	07/90-12/94	RTH	1753		0-N915	TB [TE]
1.4	07/90-12/94	F6F, F6G	1391	mit Anbaumaterial; ✳, für Fahrzeuge mit Servolenkung	0-N197	VB [DG]

ESCORT '95 Express (AVL)

1.4	01/95-	F4B	1392	21x97; Baumuster: Escort 55	SK-1053	BTK
1.4	01/95-	F4B	1392	21x97; Baumuster: Escort 75	SK-1053	BTK
1.4	01/95-	F4B	1392	21.6x97; Baumuster: Escort 55	SK-1053AQ1	BTKW
1.4	01/95-	F4B	1392	21.6x97; Baumuster: Escort 75	SK-1053AQ1	BTKW
1.8 D	01/95-	RTF, RTH	1753	20x116; 22x85; → 10/1995; mit Zubehör; Baumuster: 55, 75	SK-1041	BTK
1.8 D	01/95-	RTF, RTH	1753	22x116; 22x85; 10/1995 → 01/1997; Baumuster: 55, 75	SK-1042	BTK
1.8 D	01/95-	RTF, RTH	1753	22x116; 22x85; 10/1995 → 01/1997; Baumuster: Escort 55	SK-1042AQ1	BTKW
1.8 D	01/95-	RTF, RTH	1753	22x116; 22x85; 10/1995 → 01/1997; Baumuster: Escort 75	SK-1042AQ1	BTKW
1.8 D	01/95-	RTF, RTH	1753	22x116; 22x85; 01/1997 →; Baumuster: Escort 55	SK-1078AQ1	BTKW
1.8 D	01/95-	RTF, RTH	1753	22x116; 22x85; 01/1997 →; Baumuster: Escort 75	SK-1078AQ1	BTKW
1.8 D, 1.8 Turbo D	01/95-06/01	RTF, RTH, RVA	1753	22x116; 22x85; 01/1997 →; mit Zubehör; Baumuster: 55, 75	SK-1078	BTK
1.8 TD	01/95-	RFD, RFK, RFS	1753	20x116; 22x85; → 10/1995; mit Zubehör	SK-1041	BTK
1.8 TD	01/95-	RFD, RFK, RFS	1753	22x116; 22x85; 09/1996 →; mit Zubehör	SK-1078	BTK

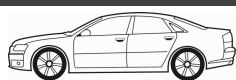

CM³



Art. Nr.



ohne Halter

ESCORT '95 Express (AVL)							
1.8 Turbo D	12/95-06/01	RVA	1753	22x116; 22x85; → 09/1996; Baumuster: 55, 75	SK-1042	BTK	
1.8 Turbo D	12/95-06/01	RVA	1753	22x116; 22x85; → 09/1996; Baumuster: Escort 55	SK-1042AQ2	BTKW	
1.8 Turbo D	12/95-06/01	RVA	1753	22x116; 22x85; → 09/1996; Baumuster: Escort 75	SK-1042AQ2	BTKW	
1.8 Turbo D	12/95-06/01	RVA	1753	22x116; 22x85; 10/1996 →	SK-1078AQ2	BTKW	
1.4	01/95-	F4B	1392		0-N837	TB [TE]	
1.8 D	01/95-	RTF, RTH	1753	→ 10/1995	0-N874	TB [TE]	
1.8 D	01/95-	RTF, RTH	1753	10/1995 → 08/1996	0-N985	TB [TE]	
1.8 D, 1.8 Turbo D	01/95-06/01	RTF, RTH, RVA	1753	09/1996 →	0-N089	TB [TE]	
1.8 D, 1.8 Turbo D	01/95-06/01	RTF, RTH, RVA	1753	09/1996 →	0-N123	TB [TE]	
1.8 D, 1.8 Turbo D	01/95-06/01	RTF, RTH, RVA	1753	→ 09/1996	0-N902	TB [DG]	
1.8 D, 1.8 Turbo D	01/95-06/01	RTF, RTH, RVA	1753		0-N915	TB [TE]	
1.8 Turbo D	12/95-06/01	RVA	1753	→ 09/1996	0-N985	TB [TE]	
1.4	01/95-	F4B	1392	mit Anbaumaterial; ⚙, für Fahrzeuge mit Servolenkung	0-N197	VB [DG]	
1.8 D	01/95-	RTF, RTH	1753	10/1995 →	0-N1501	VB [BT]	S
1.8 D, 1.8 Turbo D	01/95-06/01	RTF, RTH, RVA	1753		0-N1400	VB [TE]	S
1.8 Turbo D	12/95-06/01	RVA	1753		0-N1501	VB [BT]	S
ESCORT CLASSIC (AAL, ABL)							
1.6 16V	10/98-07/00	L1E	1597	25x131; mit Zubehör	SK-1094	BTK	
1.8 TD	10/98-07/00	RFD, RFK	1753	22x116; 22x85; mit Zubehör	SK-1078	BTK	
1.8 TD	10/98-07/00	RFD, RFK	1753	22x116; 22x85	SK-1078AQ2	BTKW	
1.6 16V	10/98-07/00	L1E	1597		0-N096	TB [DG]	
1.6 16V	10/98-07/00	L1E	1597		0-N903	TB [TE]	
1.6 16V	10/98-07/00	L1E	1597		0-N904	TB [DG]	
1.8 TD	10/98-07/00	RFD, RFK	1753		0-N089	TB [TE]	
1.8 TD	10/98-07/00	RFD, RFK	1753		0-N123	TB [TE]	
1.8 TD	10/98-07/00	RFD, RFK	1753		0-N915	TB [TE]	
1.6 16V	10/98-07/00	L1E	1597	⚙, für Fahrzeuge mit Servolenkung	0-N1385	VB [DG]	
1.6 16V	10/98-07/00	L1E	1597		0-N1533	VB [BT]	S
1.8 TD	10/98-07/00	RFD, RFK	1753		0-N1400	VB [TE]	S
1.8 TD	10/98-07/00	RFD, RFK	1753		0-N1501	VB [BT]	S
ESCORT CLASSIC Turnier (ANL)							
1.6 16V	02/99-07/00	L1E	1597	25x131; mit Zubehör	SK-1094	BTK	
1.8 TD	02/99-07/00	RFD, RFK	1753	22x116; 22x85; mit Zubehör	SK-1078	BTK	
1.8 TD	02/99-07/00	RFD, RFK	1753	22x116; 22x85	SK-1078AQ2	BTKW	
1.6 16V	02/99-07/00	L1E	1597		0-N096	TB [DG]	
1.6 16V	02/99-07/00	L1E	1597		0-N903	TB [TE]	
1.6 16V	02/99-07/00	L1E	1597		0-N904	TB [DG]	
1.8 TD	02/99-07/00	RFD, RFK	1753		0-N089	TB [TE]	
1.8 TD	02/99-07/00	RFD, RFK	1753		0-N123	TB [TE]	
1.8 TD	02/99-07/00	RFD, RFK	1753		0-N915	TB [TE]	
1.6 16V	02/99-07/00	L1E	1597	⚙, für Fahrzeuge mit Servolenkung	0-N1385	VB [DG]	
1.6 16V	02/99-07/00	L1E	1597		0-N1533	VB [BT]	S
1.8 TD	02/99-07/00	RFD, RFK	1753		0-N1400	VB [TE]	S
1.8 TD	02/99-07/00	RFD, RFK	1753		0-N1501	VB [BT]	S
ESCORT II (ATH)							
2.0 RS Heckantrieb	08/75-08/80	NE	1993		0-N839	TB [TE]	
ESCORT III (GAA)							
1.6	05/83-07/86	CHT 1600	1555	19x97	SK-1027	BTK	
1.6 D	02/84-12/85	LTA	1608	19.05x98	SK-1039	BTK	
1.6, 1.6 i, 1.6 RS Turbo	09/80-12/85	L4B, LNA, LUA	1597	19x97	SK-1027	BTK	
1.6, 1.6 XR3i, RS 1600i	09/80-02/86	LJC, LP1, LPA, LR1, LRA, LUAE	1597	19x97; 06/1983 →	SK-1027	BTK	
1.6 D	02/84-12/85	LTA	1608		0-N838	TB [TE]	
1.6, 1.6 i, 1.6 RS Turbo, 1.6 XR3i, RS 1600i	09/80-12/85	L4B, LNA, LP1, LPA, LR1, LRA, LUAE	1597		0-N837	TB [TE]	
ESCORT III Cabriolet (ALD)							
1.6, 1.6 i	09/83-12/85	LP1, LPA, LR1, LRA	1597	19x97	SK-1027	BTK	
1.6, 1.6 i	09/83-12/85	LP1, LPA, LR1, LRA	1597		0-N837	TB [TE]	
ESCORT III Kombi (AWA)							
1.6	09/80-12/85	LP1, LPA	1597	19x97; 06/1983 →	SK-1027	BTK	
1.6 D	02/84-12/85	LTA	1608	19.05x98	SK-1039	BTK	



OPTIMAL®

FORD



CM³



Art. Nr.



ESCORT III Kombi (AWA)

1.6	09/80-12/85	LP1, LPA	1597		0-N837	TB [TE]
1.6 D	02/84-12/85	LTA	1608		0-N838	TB [TE]

ESCORT IV (GAF, AWF, ABFT)

1.4	10/85-10/90	F6B, F6D, FUC, FUA, FUA	1392	19x97	SK-1027	BTK
1.6 D	01/86-01/89	LTC	1608	19.05x98	SK-1039	BTK
1.6, 1.6 i	01/86-07/90	L4B, LUG	1598	19x97	SK-1027	BTK
1.6, 1.6 i, 1.6 Turbo RS, 1.6 XR3i	01/86-07/90	LJB, LNB, LP2, LR2, LRB	1597	19x97	SK-1027	BTK
1.8 D	01/89-07/90	RTA, RTB	1753	20x116; 22x85; mit Zubehör; Baumuster: ABFT, GAF	SK-1041	BTK
1.4	10/85-10/90	F6B, F6D, FUC, FUA, FUA	1392		0-N837	TB [TE]
1.6 D	01/86-01/89	LTC	1608		0-N838	TB [TE]
1.6, 1.6 i	01/86-07/90	L4B, LUG	1598		0-N837	TB [TE]
1.6, 1.6 i, 1.6 Turbo RS, 1.6 XR3i	01/86-07/90	LJB, LNB, LP2, LR2, LRB	1597		0-N837	TB [TE]
1.8 D	01/89-07/90	RTA, RTB	1753		0-N874	TB [TE]
1.8 D	01/89-07/90	RTA, RTB	1753		0-N902	TB [DG]
1.8 D	01/89-07/90	RTA, RTB	1753		0-N915	TB [TE]

ESCORT IV Cabriolet (ALF)

1.4	01/86-07/90	F6B, F6D, FUC, FUA	1392	19x97	SK-1027	BTK
1.6, 1.6 i, 1.6 XR3i	01/86-07/90	L4B, LJB, LP2, LPA, LR2, LRB	1597	19x97	SK-1027	BTK
1.4	01/86-07/90	F6B, F6D, FUC, FUA	1392		0-N837	TB [TE]
1.6, 1.6 i, 1.6 XR3i	01/86-07/90	L4B, LJB, LP2, LPA, LR2, LRB	1597		0-N837	TB [TE]

ESCORT IV Kombi (AWF, AVF)

1.4	10/85-10/90	F6B, F6D, FUC, FUA, FUA	1392	19x97	SK-1027	BTK
1.6 D	01/86-01/89	LTC	1608	19.05x98	SK-1039	BTK
1.6, 1.6 i	01/86-07/90	L4B, LJB, LP2, LRB	1597	19x97	SK-1027	BTK
1.8 D	01/89-07/90	RTA, RTB	1753	20x116; 22x85; mit Zubehör; Baumuster: ADF, ANF	SK-1041	BTK
1.4	10/85-10/90	F6B, F6D, FUC, FUA, FUA	1392		0-N837	TB [TE]
1.6 D	01/86-01/89	LTC	1608		0-N838	TB [TE]
1.6, 1.6 i	01/86-07/90	L4B, LP2	1597		0-N837	TB [TE]
1.8 D	01/89-07/90	RTA, RTB	1753		0-N874	TB [TE]
1.8 D	01/89-07/90	RTA, RTB	1753		0-N902	TB [DG]
1.8 D	01/89-07/90	RTA, RTB	1753		0-N915	TB [TE]

ESCORT V (GAL)

1.4	07/90-09/92	F6F, F6G	1392	19x97; → 04/1992	SK-1027	BTK
1.4	07/90-09/92	F6F, F6G	1392	21x97; 04/1992 →	SK-1053	BTK
1.4	07/90-09/92	F6F, F6G	1392	21.6x97; 04/1992 →	SK-1053AQ1	BTKW
1.6	07/90-08/92	LUK	1598	19x97; → 04/1992	SK-1027	BTK
1.6	07/90-12/92	LJF	1598	19x97; → 04/1992	SK-1027	BTK
1.6	07/90-12/92	LJF, LUJ, LUK	1598	21x97; 04/1992 →	SK-1053	BTK
1.6	07/90-12/92	LJF, LUJ, LUK	1598	21.6x97; 04/1992 →	SK-1053AQ1	BTKW
1.8 16V XR3i	02/92-12/92	RDA	1796	25x131; mit Zubehör	SK-1094	BTK
1.8 16V XR3i	02/92-12/92	RQB	1796	25x131; mit Zubehör; Baumuster: ABL	SK-1094	BTK
1.8 16V XR3i	02/92-12/92	RDA, RQB	1796	25x131	SK-1094AQ1	BTKW
1.8 D	07/90-12/92	RTE, RTF, RTH	1753	20x116; 22x85; mit Zubehör	SK-1041	BTK
1.4	07/90-09/92	F6F, F6G	1392		0-N837	TB [TE]
1.6	07/90-12/92	LJF, LUJ, LUK	1598		0-N837	TB [TE]
1.8 16V XR3i	02/92-12/92	RDA, RQB	1796		0-N906	TB [DG]
1.8 16V XR3i	02/92-12/92	RDA, RQB	1796		0-N903	TB [TE]
1.8 16V XR3i	02/92-12/92	RDA, RQB	1796		0-N904	TB [DG]
1.8 D	07/90-12/92	RTE, RTF, RTH	1753		0-N874	TB [TE]
1.8 D	07/90-12/92	RTE, RTF, RTH	1753		0-N902	TB [DG]
1.8 D	07/90-12/92	RTE, RTF, RTH	1753		0-N915	TB [TE]
1.4	07/90-09/92	F6F, F6G	1392	mit Anbaumaterial; ⚠, für Fahrzeuge mit Servolenkung	0-N197	VB [DG]
1.6	07/90-12/92	LJF, LUJ, LUK	1598	mit Anbaumaterial; ⚠, für Fahrzeuge mit Servolenkung	0-N197	VB [DG]
1.8 16V XR3i	02/92-12/92	RDA, RQB	1796		0-N1401	VB [DG]
1.8 16V XR3i	02/92-12/92	RDA, RQB	1796		0-N1533	VB [BT] S

ESCORT V Cabriolet (ALL)

1.4	07/90-12/92	F6F, F6G	1392	19x97; → 04/1992	SK-1027	BTK
1.4	07/90-12/92	F6F, F6G	1392	21x97; 04/1992 →	SK-1053	BTK
1.4	07/90-12/92	F6F, F6G	1392	21.6x97; 04/1992 →	SK-1053AQ1	BTKW
1.6	07/90-12/92	LJF	1598	19x97; → 04/1992	SK-1027	BTK



CM³



Art. Nr.



ESCORT V Cabriolet (ALL)

1.6	07/90-12/92	LJF	1598	21x97; 04/1992 →	SK-1053	BTK	
1.6	07/90-12/92	LJF	1598	21.6x97; 04/1992 →	SK-1053AQ1	BTKW	
1.8 16V XR3i	02/92-12/92	RDA, RQB	1796	25x131; mit Zubehör; Baumuster: ALL	SK-1094	BTK	
1.8 16V XR3i	02/92-12/92	RDA, RQB	1796	25x131	SK-1094AQ1	BTKW	
1.4	07/90-12/92	F6F, F6G	1392		0-N837	TB [TE]	
1.6	07/90-12/92	LJF	1598		0-N837	TB [TE]	
1.8 16V XR3i	02/92-12/92	RDA, RQB	1796		0-N096	TB [DG]	
1.8 16V XR3i	02/92-12/92	RDA, RQB	1796		0-N903	TB [TE]	
1.8 16V XR3i	02/92-12/92	RDA, RQB	1796		0-N904	TB [DG]	
1.4	07/90-12/92	F6F, F6G	1392	mit Anbaumaterial; ⚠, für Fahrzeuge mit Servolenkung	0-N197	VB [DG]	
1.6	07/90-12/92	LJF	1598	mit Anbaumaterial; ⚠, für Fahrzeuge mit Servolenkung	0-N197	VB [DG]	
1.8 16V XR3i	02/92-12/92	RDA, RQB	1796		0-N1401	VB [DG]	
1.8 16V XR3i	02/92-12/92	RDA, RQB	1796		0-N1533	VB [BT]	S

ESCORT V Kombi (GAL, AVL)

1.4	07/90-09/92	F6F, F6G	1392	19x97; → 04/1992	SK-1027	BTK	
1.4	07/90-09/92	F6F, F6G	1392	21x97; 04/1992 →	SK-1053	BTK	
1.4	07/90-09/92	F6F, F6G	1392	21.6x97; 04/1992 →	SK-1053AQ1	BTKW	
1.6	07/90-08/92	LUK	1598	19x97; → 04/1992	SK-1027	BTK	
1.6	07/90-09/92	LJF	1598	19x97; → 04/1992	SK-1027	BTK	
1.6	07/90-09/92	LJF, LUJ, LUK	1598	21x97; 04/1992 →; Baumuster: Escort	SK-1053	BTK	
1.6	07/90-09/92	LJF, LUJ, LUK	1598	21x97; 04/1992 →; Baumuster: Escort-Nomade	SK-1053	BTK	
1.6	07/90-09/92	LJF, LUJ, LUK	1598	21.6x97; 04/1992 →; Baumuster: Escort	SK-1053AQ1	BTKW	
1.6	07/90-09/92	LJF, LUJ, LUK	1598	21.6x97; 04/1992 →; Baumuster: Escort-Nomade	SK-1053AQ1	BTKW	
1.6	07/90-08/92	LUK	1598	25x131; mit Zubehör; Baumuster: ANL	SK-1094	BTK	
1.8 16V	02/92-12/92	RDA	1796	25x131; mit Zubehör; Baumuster: ANL	SK-1094	BTK	
1.8 16V	02/92-12/92	RDA	1796	25x131	SK-1094AQ1	BTKW	
1.8 D, 1.8 TD	07/90-12/92	RTE, RTF, RTH	1753	20x116; 22x85; mit Zubehör	SK-1041	BTK	
1.4	07/90-09/92	F6F, F6G	1392		0-N837	TB [TE]	
1.6	07/90-09/92	LJF, LUJ, LUK	1598		0-N837	TB [TE]	
1.8 16V	02/92-12/92	RDA	1796		0-N096	TB [DG]	
1.8 16V	02/92-12/92	RDA	1796		0-N903	TB [TE]	
1.8 16V	02/92-12/92	RDA	1796		0-N904	TB [DG]	
1.8 D	07/90-12/92	RTE, RTF, RTH	1753		0-N874	TB [TE]	
1.8 D	07/90-12/92	RTE, RTF, RTH	1753		0-N902	TB [DG]	
1.8 D	07/90-12/92	RTE, RTF, RTH	1753		0-N915	TB [TE]	
1.4	07/90-09/92	F6F, F6G	1392	mit Anbaumaterial; ⚠, für Fahrzeuge mit Servolenkung	0-N197	VB [DG]	
1.6	07/90-09/92	LJF, LUJ, LUK	1598	mit Anbaumaterial; ⚠, für Fahrzeuge mit Servolenkung	0-N197	VB [DG]	
1.8 16V	02/92-12/92	RDA	1796		0-N1401	VB [DG]	
1.8 16V	02/92-12/92	RDA	1796		0-N1533	VB [BT]	S

ESCORT VI (GAL)

1.4	09/92-01/95	F6F, F6G	1391	21x97	SK-1053	BTK	
1.4	09/92-01/95	F6F, F6G	1391	21.6x97	SK-1053AQ1	BTKW	
1.4	01/94-01/95	F4B, FUH	1392	21x97	SK-1053	BTK	
1.4	01/94-01/95	F4B, FUH	1392	21.6x97	SK-1053AQ1	BTKW	
1.6 i 16V	09/92-01/95	L1E	1597	25x131; mit Zubehör	SK-1094	BTK	
1.6 i 16V	09/92-01/95	L1E, L1H	1597	25x131	SK-1094AQ1	BTKW	
1.6 i 16V	01/94-01/95	L1H	1597	25x131; mit Zubehör; Baumuster: GAL	SK-1094	BTK	
1.8 16V XR3i	09/92-01/95	RQB	1796	25x131; mit Zubehör; Baumuster: ABL	SK-1094	BTK	
1.8 16V XR3i, 1.8 i 16V, 1.8 XR3i 16V 4x4	09/92-01/95	RDA, RQB	1796	25x131	SK-1094AQ1	BTKW	
1.8 D	09/92-01/95	RTE, RTF, RTH	1753	20x116; 22x85; mit Zubehör	SK-1041	BTK	
1.8 i 16V, 1.8 XR3i 16V 4x4	09/92-01/95	RDA, RQB	1796	25x131; mit Zubehör	SK-1094	BTK	
1.8 TD	02/93-01/95	RFD, RFK, RFS	1753	20x116; 22x85; 06/1993 →; mit Zubehör	SK-1041	BTK	
1.4	09/92-01/95	F6F, F6G	1391		0-N837	TB [TE]	
1.4	01/94-01/95	F4B, FUH	1392		0-N837	TB [TE]	
1.6 i 16V	09/92-01/95	L1E, L1H	1597		0-N096	TB [DG]	
1.6 i 16V	09/92-01/95	L1E, L1H	1597		0-N903	TB [TE]	
1.6 i 16V	09/92-01/95	L1E, L1H	1597		0-N904	TB [DG]	
1.8 16V XR3i, 1.8 i 16V, 1.8 XR3i 16V 4x4	09/92-01/95	RDA, RQB	1796		0-N096	TB [DG]	
1.8 16V XR3i, 1.8 i 16V, 1.8 XR3i 16V 4x4	09/92-01/95	RDA, RQB	1796		0-N903	TB [TE]	
1.8 16V XR3i, 1.8 i 16V, 1.8 XR3i 16V 4x4	09/92-01/95	RDA, RQB	1796		0-N904	TB [DG]	

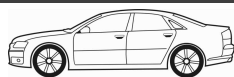
CM³

Art. Nr.

**ESCORT VI (GAL)**

1.8 D, 1.8 TD	09/92-01/95	RFD, RFK, RFS, RTE, RTF, RTH	1753		0-N874	TB [TE]	
1.8 D, 1.8 TD	09/92-01/95	RFD, RFK, RFS, RTE, RTF, RTH	1753		0-N902	TB [DG]	
1.8 D, 1.8 TD	09/92-01/95	RFD, RFK, RFS, RTE, RTF, RTH	1753		0-N915	TB [TE]	
RS Cosworth 4x4	09/92-01/95	N5F	1994		0-N1779	TB [BT]	
1.4	09/92-01/95	F6F, F6G	1391	mit Anbaumaterial; ⚠, für Fahrzeuge mit Servolenkung	0-N197	VB [DG]	
1.4	01/94-01/95	F4B, FUH	1392	mit Anbaumaterial; ⚠, für Fahrzeuge mit Servolenkung	0-N197	VB [DG]	
1.6 i 16V	09/92-01/95	L1E, L1H	1597		0-N1533	VB [BT]	S
1.8 16V XR3i, 1.8 i 16V, 1.8 XR3i 16V 4x4	09/92-01/95	RDA, RQB	1796		0-N1533	VB [BT]	S
1.8 D, 1.8 TD	09/92-01/95	RFD, RFK, RFS, RTE, RTF, RTH	1753	08/1994 →	0-N1400	VB [TE]	S
1.8 i 16V, 1.8 XR3i 16V 4x4	09/92-01/95	RDA	1796		0-N1401	VB [DG]	

ESCORT VI Cabriolet (ALL)

1.4, 1.4 i	12/92-01/95	F4B, F6F, F6G	1392	21x97	SK-1053	BTK	
1.4, 1.4 i	12/92-01/95	F4B, F6F, F6G	1392	21.6x97	SK-1053AQ1	BTKW	
1.6 16V XR3i, 1.6 i 16V	12/92-01/95	L1E, L1H	1597	25x131; mit Zubehör; Baumuster: ALL	SK-1094	BTK	
1.6 16V XR3i, 1.6 i 16V	12/92-01/95	L1E, L1H	1597	25x131	SK-1094AQ1	BTKW	
1.8 16V XR3i	12/92-01/95	RDA, RQB	1796	25x131; mit Zubehör; Baumuster: ALL	SK-1094	BTK	
1.8 16V XR3i	12/92-01/95	RDA, RQB	1796	25x131	SK-1094AQ1	BTKW	
1.4, 1.4 i	12/92-01/95	F4B, F6F, F6G	1392		0-N837	TB [TE]	
1.6 16V XR3i, 1.6 i 16V	12/92-01/95	L1E, L1H	1597		0-N096	TB [DG]	
1.6 16V XR3i, 1.6 i 16V	12/92-01/95	L1E, L1H	1597		0-N903	TB [TE]	
1.6 16V XR3i, 1.6 i 16V	12/92-01/95	L1E, L1H	1597		0-N904	TB [DG]	
1.8 16V XR3i	12/92-01/95	RDA, RQB	1796		0-N096	TB [DG]	
1.8 16V XR3i	12/92-01/95	RDA, RQB	1796		0-N903	TB [TE]	
1.8 16V XR3i	12/92-01/95	RDA, RQB	1796		0-N904	TB [DG]	
1.4, 1.4 i	12/92-01/95	F4B, F6F, F6G	1392	mit Anbaumaterial; ⚠, für Fahrzeuge mit Servolenkung	0-N197	VB [DG]	
1.6 16V XR3i, 1.6 i 16V	12/92-01/95	L1E, L1H	1597		0-N1533	VB [BT]	S
1.8 16V XR3i	12/92-01/95	RDA, RQB	1796		0-N1401	VB [DG]	
1.8 16V XR3i	12/92-01/95	RDA, RQB	1796		0-N1533	VB [BT]	S

ESCORT VI Kombi (GAL)

1.4	09/92-01/95	F6F, F6G	1391	21x97	SK-1053	BTK	
1.4	09/92-01/95	F6F, F6G	1391	21.6x97	SK-1053AQ1	BTKW	
1.4	01/94-01/95	F4B, FUH	1392	21x97	SK-1053	BTK	
1.4	01/94-01/95	F4B, FUH	1392	21.6x97	SK-1053AQ1	BTKW	
1.6 i 16V	09/92-01/95	L1E	1597	25x131; 01/1993 →; mit Zubehör	SK-1094	BTK	
1.6 i 16V	09/92-01/95	L1E, L1H	1597	25x131; mit Zubehör; Baumuster: ANL	SK-1094	BTK	
1.6 i 16V	09/92-01/95	L1E, L1H	1597	25x131	SK-1094AQ1	BTKW	
1.8 D	09/92-01/95	RTH	1753	20x116; 22x85; mit Zubehör	SK-1041	BTK	
1.8 i 16V	01/93-01/95	RDA, RQB	1796	25x131; mit Zubehör; Baumuster: ANL	SK-1094	BTK	
1.8 i 16V	01/93-01/95	RDA, RQB	1796	25x131	SK-1094AQ1	BTKW	
1.8 TD	02/93-01/95	RFK	1753	20x116; 22x85; 06/1993 →; mit Zubehör	SK-1041	BTK	
1.4	09/92-01/95	F6F, F6G	1391		0-N837	TB [TE]	
1.4	01/94-01/95	F4B, FUH	1392		0-N837	TB [TE]	
1.6 i 16V	09/92-01/95	L1E, L1H	1597		0-N096	TB [DG]	
1.6 i 16V	09/92-01/95	L1E, L1H	1597		0-N903	TB [TE]	
1.6 i 16V	09/92-01/95	L1E, L1H	1597		0-N904	TB [DG]	
1.8 D, 1.8 TD	09/92-01/95	RFD, RFK, RTH	1753		0-N874	TB [TE]	
1.8 D, 1.8 TD	09/92-01/95	RFD, RFK, RTH	1753		0-N902	TB [DG]	
1.8 D, 1.8 TD	09/92-01/95	RFD, RFK, RTH	1753		0-N915	TB [TE]	
1.8 i 16V	01/93-01/95	RDA, RQB	1796		0-N096	TB [DG]	
1.8 i 16V	01/93-01/95	RDA, RQB	1796		0-N903	TB [TE]	
1.8 i 16V	01/93-01/95	RDA, RQB	1796		0-N904	TB [DG]	
1.4	09/92-01/95	F6F, F6G	1391	mit Anbaumaterial; ⚠, für Fahrzeuge mit Servolenkung	0-N197	VB [DG]	
1.4	01/94-01/95	F4B, FUH	1392	mit Anbaumaterial; ⚠, für Fahrzeuge mit Servolenkung	0-N197	VB [DG]	
1.6 i 16V	09/92-01/95	L1E, L1H	1597		0-N1533	VB [BT]	S
1.8 D, 1.8 TD	09/92-01/95	RFD, RFK, RTH	1753	08/1994 →	0-N1400	VB [TE]	S
1.8 i 16V	01/93-01/95	RDA, RQB	1796		0-N1401	VB [DG]	
1.8 i 16V	01/93-01/95	RDA, RQB	1796		0-N1533	VB [BT]	S

ESCORT VI Stufenheck (GAL)

1.4	08/93-01/95	F4B, FUH, F6F, F6G	1392	21x97	SK-1053	BTK	
1.4	08/93-01/95	F4B, FUH, F6F, F6G	1392	21.6x97	SK-1053AQ1	BTKW	

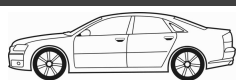

CM³



Art. Nr.



ESCORT VI Stufenheck (GAL)

1.6 i 16V	08/93-01/95	L1E, L1K, L1H	1597	25x131; mit Zubehör; Baumuster: AFL	SK-1094	BTK	
1.6 i 16V	08/93-01/95	L1E, L1K, L1H	1597	25x131	SK-1094AQ1	BTKW	
1.8 D, 1.8 TD	08/93-01/95	RFD, RFK, RTE, RTF, RTH	1753	20x116; 22x85; mit Zubehör	SK-1041	BTK	
1.8 i 16V	08/93-01/95	RDA	1796	25x131; mit Zubehör; Baumuster: AFL	SK-1094	BTK	
1.8 i 16V	08/93-01/95	RDA	1796	25x131	SK-1094AQ1	BTKW	
1.4	08/93-01/95	F4B, FUH, F6F, F6G	1392		0-N837	TB [TE]	
1.6 i 16V	08/93-01/95	L1E, L1K, L1H	1597		0-N096	TB [DG]	
1.6 i 16V	08/93-01/95	L1E, L1K, L1H	1597		0-N903	TB [TE]	
1.6 i 16V	08/93-01/95	L1E, L1K, L1H	1597		0-N904	TB [DG]	
1.8 D, 1.8 TD	08/93-01/95	RFD, RFK, RTE, RTF, RTH	1753		0-N874	TB [TE]	
1.8 D, 1.8 TD	08/93-01/95	RFD, RFK, RTE, RTF, RTH	1753		0-N902	TB [DG]	
1.8 D, 1.8 TD	08/93-01/95	RFD, RFK, RTE, RTF, RTH	1753		0-N915	TB [TE]	
1.8 i 16V	08/93-01/95	RDA	1796		0-N096	TB [DG]	
1.8 i 16V	08/93-01/95	RDA	1796		0-N903	TB [TE]	
1.8 i 16V	08/93-01/95	RDA	1796		0-N904	TB [DG]	
1.4	08/93-01/95	F4B, FUH, F6F, F6G	1392	mit Anbaumaterial; ⚠, für Fahrzeuge mit Servolenkung	0-N197	VB [DG]	
1.6 i 16V	08/93-01/95	L1E, L1K, L1H	1597		0-N1533	VB [BT]	S
1.8 D, 1.8 TD	08/93-01/95	RFD, RFK, RTE, RTF, RTH	1753	08/1994 →	0-N1400	VB [TE]	S
1.8 i 16V	08/93-01/95	RDA	1796		0-N1401	VB [DG]	
1.8 i 16V	08/93-01/95	RDA	1796		0-N1533	VB [BT]	S

ESCORT VII (GAL, AAL, ABL)

1.4	01/95-10/98	F4B	1392	21x97	SK-1053	BTK	
1.4	01/95-10/98	F4B	1392	21.6x97	SK-1053AQ1	BTKW	
1.6 16V	01/95-10/98	L1E	1597	25x131; → 05/1998	SK-1094AQ1	BTKW	
1.6 16V 4x4, 1.6 i 16V	01/95-10/98	L1E, L1H	1597	25x131	SK-1094AQ1	BTKW	
1.6 16V, 1.6 16V 4x4	01/95-10/98	L1E	1597	25x131; mit Zubehör; Baumuster: AAL, ABL	SK-1094	BTK	
1.6 i 16V	01/95-08/95	L1H	1597	25x131; mit Zubehör; Baumuster: AAL	SK-1094	BTK	
1.8 16V	01/95-10/98	RDA, RKC	1796	25x131; mit Zubehör; Baumuster: AAL, ABL	SK-1094	BTK	
1.8 16V	01/95-10/98	RDA, RKC	1796	25x131	SK-1094AQ1	BTKW	
1.8 D	01/95-12/96	RTE, RTF, RTH	1753	22x116; 22x85; 10/1995 →	SK-1042	BTK	
1.8 D	01/95-12/96	RTE, RTF, RTH	1753	22x116; 22x85; 10/1995 →	SK-1042AQ1	BTKW	
1.8 D, 1.8 TD	01/95-10/98	RFD, RFK, RTE, RTF, RTH	1753	20x116; 22x85; → 10/1995; mit Zubehör	SK-1041	BTK	
1.8 TD	01/95-10/98	RFD, RFK	1753	22x116; 22x85; 10/1995 → 09/1996	SK-1042	BTK	
1.8 TD	01/95-10/98	RFD, RFK	1753	22x116; 22x85; 10/1995 → 09/1996	SK-1042AQ2	BTKW	
1.8 TD, 1.8 Turbo D	01/95-10/98	RFD, RFK, RVA	1753	22x116; 22x85; 09/1996 →; mit Zubehör	SK-1078	BTK	
1.8 TD, 1.8 Turbo D	01/95-10/98	RFD, RFK, RVA	1753	22x116; 22x85; 10/1996 →	SK-1078AQ2	BTKW	
1.8 Turbo D	12/95-10/98	RVA	1753	22x116; 22x85; 04/1996 → 09/1996	SK-1042	BTK	
1.8 Turbo D	12/95-10/98	RVA	1753	22x116; 22x85; → 09/1996	SK-1042AQ2	BTKW	
1.4	01/95-10/98	F4B	1392		0-N837	TB [TE]	
1.6 16V, 1.6 16V 4x4, 1.6 i 16V	01/95-10/98	L1E, L1H	1597		0-N096	TB [DG]	
1.6 16V, 1.6 16V 4x4, 1.6 i 16V	01/95-10/98	L1E, L1H	1597		0-N903	TB [TE]	
1.6 16V, 1.6 16V 4x4, 1.6 i 16V	01/95-10/98	L1E, L1H	1597		0-N904	TB [DG]	
1.8 16V	01/95-10/98	RDA, RKC	1796		0-N096	TB [DG]	
1.8 16V	01/95-10/98	RDA, RKC	1796		0-N903	TB [TE]	
1.8 16V	01/95-10/98	RDA, RKC	1796		0-N904	TB [DG]	
1.8 D	01/95-12/96	RTE, RTF, RTH	1753		0-N902	TB [DG]	
1.8 D	01/95-12/96	RTE, RTF, RTH	1753	10/1995 →	0-N985	TB [TE]	
1.8 D, 1.8 TD	01/95-10/98	RFD, RFK, RTE, RTF, RTH	1753	→ 10/1995	0-N874	TB [TE]	
1.8 D, 1.8 TD, 1.8 Turbo D	01/95-10/98	RFD, RFK, RTE, RTF, RTH, RVA	1753		0-N915	TB [TE]	
1.8 TD	01/95-10/98	RFD, RFK	1753	10/1995 → 09/1996	0-N985	TB [TE]	
1.8 TD, 1.8 Turbo D	01/95-10/98	RFD, RFK, RVA	1753	09/1996 →	0-N089	TB [TE]	
1.8 TD, 1.8 Turbo D	01/95-10/98	RFD, RFK, RVA	1753	09/1996 →	0-N123	TB [TE]	
1.8 TD, 1.8 Turbo D	01/95-10/98	RFD, RFK, RVA	1753	→ 09/1996	0-N902	TB [DG]	
1.8 Turbo D	12/95-10/98	RVA	1753	→ 09/1996	0-N985	TB [TE]	
RS Cosworth 4x4	02/95-10/98	N5F	1994		0-N1779	TB [BT]	
1.3	01/95-10/98	J4B, J6A	1299	08/1995 →; für Fahrzeuge mit Servolenkung	0-N1443	VB [BT]	S
1.4	01/95-10/98	F4B	1392	mit Anbaumaterial; ⚠, für Fahrzeuge mit Servolenkung	0-N197	VB [DG]	
1.6 16V, 1.6 16V 4x4, 1.6 i 16V	01/95-10/98	L1E, L1H	1597	⚠, für Fahrzeuge mit Servolenkung	0-N1385	VB [DG]	
1.6 16V, 1.6 16V 4x4, 1.6 i 16V	01/95-10/98	L1E, L1H	1597		0-N1533	VB [BT]	S
1.8 16V	01/95-10/98	RDA, RKC	1796	⚠, für Fahrzeuge mit Servolenkung	0-N1385	VB [DG]	
1.8 16V	01/95-10/98	RDA, RKC	1796		0-N1533	VB [BT]	S
1.8 D	01/95-12/96	RTE, RTF, RTH	1753	10/1995 →	0-N1501	VB [BT]	S
1.8 D, 1.8 TD, 1.8 Turbo D	01/95-10/98	RFD, RFK, RTE, RTF, RTH, RVA	1753		0-N1400	VB [TE]	S

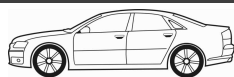
CM³

Art. Nr.

**ESCORT VII (GAL, AAL, ABL)**

1.8 TD, 1.8 Turbo D	01/95-10/98	RFD, RFK, RVA	1753			0-N1501	VB [BT]	S
---------------------	-------------	---------------	------	--	--	----------------	---------	----------

ESCORT VII Cabriolet (ALL)

1.4	02/95-08/98	F4B	1392	21x97		SK-1053	BTK	
1.4	02/95-08/98	F4B	1392	21.6x97		SK-1053AQ1	BTKW	
1.6 16V XR3i	02/95-09/99	L1E, L1H	1597	25x131; mit Zubehör; Baumuster: ALL		SK-1094	BTK	
1.6 16V XR3i	02/95-09/99	L1E	1597	25x131; → 05/1998		SK-1094AQ1	BTKW	
1.6 16V XR3i	02/95-12/96	L1H	1597	25x131		SK-1094AQ1	BTKW	
1.8 16V XR3i	02/95-08/00	RDA, RKC, RQB	1796	25x131; mit Zubehör; Baumuster: ALL		SK-1094	BTK	
1.8 16V XR3i	02/95-08/00	RDA, RKC, RQB	1796	25x131		SK-1094AQ1	BTKW	
1.8 TD	09/95-08/98	RFD, RFK	1753	20x116; 22x85; → 10/1995; mit Zubehör		SK-1041	BTK	
1.8 TD	09/95-08/98	RFD, RFK	1753	22x116; 22x85		SK-1042	BTK	
1.8 TD	09/95-08/98	RFD, RFK	1753	22x116; 22x85; 10/1995 →		SK-1042AQ2	BTKW	
1.8 TD	09/95-08/98	RFD, RFK	1753	22x116; 22x85; 10/1996 →; mit Zubehör		SK-1078	BTK	
1.8 TD	09/95-08/98	RFD, RFK	1753	22x116; 22x85; 10/1996 →		SK-1078AQ2	BTKW	
1.8 Turbo D	10/96-08/99	RVA	1753	22x116; 22x85; mit Zubehör		SK-1078	BTK	
1.8 Turbo D	10/96-08/99	RVA	1753	22x116; 22x85		SK-1078AQ2	BTKW	
1.4	02/95-08/98	F4B	1392			0-N837	TB [TE]	
1.6 16V XR3i	02/95-09/99	L1E, L1H	1597			0-N096	TB [DG]	
1.6 16V XR3i	02/95-09/99	L1E, L1H	1597			0-N903	TB [TE]	
1.6 16V XR3i	02/95-09/99	L1E, L1H	1597			0-N904	TB [DG]	
1.8 16V XR3i	02/95-08/00	RDA, RKC, RQB	1796			0-N096	TB [DG]	
1.8 16V XR3i	02/95-08/00	RDA, RKC, RQB	1796			0-N903	TB [TE]	
1.8 16V XR3i	02/95-08/00	RDA, RKC, RQB	1796			0-N904	TB [DG]	
1.8 TD	09/95-08/98	RFD, RFK	1753	09/1996 →		0-N089	TB [TE]	
1.8 TD	09/95-08/98	RFD, RFK	1753	09/1996 →		0-N123	TB [TE]	
1.8 TD	09/95-08/98	RFD, RFK	1753	→ 10/1995		0-N874	TB [TE]	
1.8 TD	09/95-08/98	RFD, RFK	1753	→ 09/1996		0-N902	TB [DG]	
1.8 TD	09/95-08/98	RFD, RFK	1753	10/1995 → 09/1996		0-N985	TB [TE]	
1.8 TD, 1.8 Turbo D	09/95-08/99	RFD, RFK, RVA	1753			0-N915	TB [TE]	
1.8 Turbo D	10/96-08/99	RVA	1753			0-N089	TB [TE]	
1.8 Turbo D	10/96-08/99	RVA	1753			0-N123	TB [TE]	
1.4	02/95-08/98	F4B	1392	mit Anbaumaterial; ⚠, für Fahrzeuge mit Servolenkung		0-N197	VB [DG]	
1.6 16V XR3i	02/95-09/99	L1E	1597	→ 02/1999; ⚠, für Fahrzeuge mit Servolenkung		0-N1385	VB [DG]	
1.6 16V XR3i	02/95-12/96	L1H	1597	⚠, für Fahrzeuge mit Servolenkung		0-N1385	VB [DG]	
1.6 16V XR3i	02/95-09/99	L1E, L1H	1597			0-N1533	VB [BT]	S
1.8 16V XR3i	02/95-08/00	RQB	1796	→ 02/1999; ⚠, für Fahrzeuge mit Servolenkung		0-N1385	VB [DG]	
1.8 16V XR3i	02/95-08/98	RDA, RKC	1796	⚠, für Fahrzeuge mit Servolenkung		0-N1385	VB [DG]	
1.8 16V XR3i	02/95-08/00	RDA, RKC, RQB	1796			0-N1533	VB [BT]	S
1.8 TD, 1.8 Turbo D	09/95-08/99	RFD, RFK, RVA	1753			0-N1400	VB [TE]	S
1.8 TD, 1.8 Turbo D	09/95-08/99	RFD, RFK, RVA	1753			0-N1501	VB [BT]	S

ESCORT VII Stufenheck (GAL, AFL)

1.4	01/95-02/99	F4B, FUH	1392	21x97		SK-1053	BTK	
1.4	01/95-02/99	F4B, FUH	1392	21.6x97		SK-1053AQ1	BTKW	
1.6 i 16V	01/95-02/99	L1E, L1K, L1H	1597	25x131; mit Zubehör; Baumuster: AFL		SK-1094	BTK	
1.6 i 16V	01/95-02/99	L1E, L1K	1597	25x131; → 05/1998		SK-1094AQ1	BTKW	
1.6 i 16V	01/95-08/95	L1H	1597	25x131		SK-1094AQ1	BTKW	
1.8 16V	01/95-02/99	RKC	1796	25x131; 04/1996 →; mit Zubehör; Baumuster: AFL		SK-1094	BTK	
1.8 16V	01/95-08/95	RDA	1796	25x131; mit Zubehör; Baumuster: AFL		SK-1094	BTK	
1.8 16V	01/95-02/99	RDA, RKC	1796	25x131		SK-1094AQ1	BTKW	
1.8 D	01/95-12/96	RTE, RTF, RTH	1753	22x116; 22x85; 10/1995 →		SK-1042	BTK	
1.8 D	01/95-12/96	RTE, RTF, RTH	1753	22x116; 22x85; 10/1995 →		SK-1042AQ1	BTKW	
1.8 D, 1.8 TD	01/95-02/99	RFD, RFK, RTE, RTF, RTH	1753	20x116; 22x85; → 10/1995; mit Zubehör		SK-1041	BTK	
1.8 TD	01/95-02/99	RFD, RFK	1753	22x116; 22x85; 10/1995 → 09/1996		SK-1042	BTK	
1.8 TD	01/95-02/99	RFD, RFK	1753	22x116; 22x85; 10/1995 → 09/1996		SK-1042AQ2	BTKW	
1.8 TD, 1.8 Turbo D	01/95-02/99	RFD, RFK, RVA	1753	22x116; 22x85; 09/1996 →; mit Zubehör		SK-1078	BTK	
1.8 TD, 1.8 Turbo D	01/95-02/99	RFD, RFK, RVA	1753	22x116; 22x85; 10/1996 →		SK-1078AQ2	BTKW	
1.8 Turbo D	12/95-02/99	RVA	1753	22x116; 22x85; 04/1996 → 09/1996		SK-1042	BTK	
1.8 Turbo D	12/95-02/99	RVA	1753	22x116; 22x85; → 09/1996		SK-1042AQ2	BTKW	
1.4	01/95-02/99	F4B, FUH	1392			0-N837	TB [TE]	
1.6 i 16V	01/95-02/99	L1E, L1K, L1H	1597			0-N096	TB [DG]	
1.6 i 16V	01/95-02/99	L1E, L1K, L1H	1597			0-N903	TB [TE]	



CM³



Art. Nr.



ESCORT VII Stufenheck (GAL, AFL)

1.6 i 16V	01/95-02/99	L1E, L1K, L1H	1597		0-N904	TB [DG]	
1.8 16V	01/95-02/99	RDA, RKC	1796		0-N096	TB [DG]	
1.8 16V	01/95-02/99	RDA, RKC	1796		0-N903	TB [TE]	
1.8 16V	01/95-02/99	RDA, RKC	1796		0-N904	TB [DG]	
1.8 D	01/95-12/96	RTE, RTF, RTH	1753		0-N902	TB [DG]	
1.8 D	01/95-12/96	RTE, RTF, RTH	1753	10/1995 →	0-N985	TB [TE]	
1.8 D, 1.8 TD	01/95-02/99	RFD, RFK, RTE, RTF, RTH	1753	→ 10/1995	0-N874	TB [TE]	
1.8 D, 1.8 TD, 1.8 Turbo D	01/95-02/99	RFD, RFK, RTE, RTF, RTH, RVA	1753		0-N915	TB [TE]	
1.8 TD	01/95-02/99	RFD, RFK	1753	10/1995 → 09/1996	0-N985	TB [TE]	
1.8 TD, 1.8 Turbo D	01/95-02/99	RFD, RFK, RVA	1753	09/1996 →	0-N089	TB [TE]	
1.8 TD, 1.8 Turbo D	01/95-02/99	RFD, RFK, RVA	1753	09/1996 →	0-N123	TB [TE]	
1.8 TD, 1.8 Turbo D	01/95-02/99	RFD, RFK, RVA	1753	→ 09/1996	0-N902	TB [DG]	
1.8 Turbo D	12/95-02/99	RVA	1753	→ 09/1996	0-N985	TB [TE]	
1.3	01/95-02/99	J4B, J6A	1299	08/1995 →; für Fahrzeuge mit Servolenkung	0-N1443	VB [BT]	S
1.4	01/95-02/99	F4B, FUH	1392	mit Anbaumaterial; ⚠, für Fahrzeuge mit Servolenkung	0-N197	VB [DG]	
1.6 i 16V	01/95-02/99	L1E, L1K, L1H	1597	⚠, für Fahrzeuge mit Servolenkung	0-N1385	VB [DG]	
1.6 i 16V	01/95-02/99	L1E, L1K, L1H	1597		0-N1533	VB [BT]	S
1.8 16V	01/95-02/99	RDA, RKC	1796	⚠, für Fahrzeuge mit Servolenkung	0-N1385	VB [DG]	
1.8 16V	01/95-02/99	RDA, RKC	1796		0-N1533	VB [BT]	S
1.8 D	01/95-12/96	RTE, RTF, RTH	1753	10/1995 →	0-N1501	VB [BT]	S
1.8 D, 1.8 TD, 1.8 Turbo D	01/95-02/99	RFD, RFK, RTE, RTF, RTH, RVA	1753		0-N1400	VB [TE]	S
1.8 TD, 1.8 Turbo D	01/95-02/99	RFD, RFK, RVA	1753		0-N1501	VB [BT]	S

ESCORT VII Kombi (GAL, ANL)

1.4	01/95-02/99	F4B, FUH	1392	21x97	SK-1053	BTK	
1.4	01/95-02/99	F4B, FUH	1392	21.6x97	SK-1053AQ1	BTKW	
1.6 16V	01/95-02/99	L1E	1597	25x131; mit Zubehör; Baumuster: ANL	SK-1094	BTK	
1.6 16V	01/95-02/99	L1E	1597	25x131; → 05/1998	SK-1094AQ1	BTKW	
1.6 i 16V	01/95-08/95	L1H	1597	25x131; mit Zubehör; Baumuster: ANL, GAL	SK-1094	BTK	
1.6 i 16V	01/95-08/95	L1H	1597	25x131	SK-1094AQ1	BTKW	
1.8 16V	01/95-02/99	RDA, RKC	1796	25x131; mit Zubehör; Baumuster: ANL	SK-1094	BTK	
1.8 16V	01/95-02/99	RDA, RKC	1796	25x131	SK-1094AQ1	BTKW	
1.8 D	01/95-02/99	RTE, RTF, RTH	1753	22x116; 22x85; 10/1995 → 01/1997	SK-1042	BTK	
1.8 D	01/95-02/99	RTE, RTF, RTH	1753	22x116; 22x85; 10/1995 → 01/1997	SK-1042AQ1	BTKW	
1.8 D	01/95-02/99	RTE, RTF, RTH	1753	22x116; 22x85; 01/1997 →; mit Zubehör	SK-1078	BTK	
1.8 D	01/95-02/99	RTE, RTF, RTH	1753	22x116; 22x85; 01/1997 →	SK-1078AQ1	BTKW	
1.8 D, 1.8 TD	01/95-02/99	RFD, RFK, RTE, RTF, RTH	1753	20x116; 22x85; → 10/1995; mit Zubehör	SK-1041	BTK	
1.8 TD	01/95-02/99	RFD, RFK	1753	22x116; 22x85; 10/1995 → 09/1996	SK-1042	BTK	
1.8 TD	01/95-02/99	RFD, RFK	1753	22x116; 22x85; 10/1995 → 09/1996	SK-1042AQ2	BTKW	
1.8 TD, 1.8 Turbo D	01/95-02/99	RFD, RFK, RVA	1753	22x116; 22x85; 09/1996 →; mit Zubehör	SK-1078	BTK	
1.8 TD, 1.8 Turbo D	01/95-02/99	RFD, RFK, RVA	1753	22x116; 22x85; 10/1996 →	SK-1078AQ2	BTKW	
1.8 Turbo D	12/95-02/99	RVA	1753	22x116; 22x85; 04/1996 → 09/1996	SK-1042	BTK	
1.8 Turbo D	12/95-02/99	RVA	1753	22x116; 22x85; → 09/1996	SK-1042AQ2	BTKW	
1.4	01/95-02/99	F4B, FUH	1392		0-N837	TB [TE]	
1.6 16V, 1.6 i 16V	01/95-02/99	L1E, L1H	1597		0-N096	TB [DG]	
1.6 16V, 1.6 i 16V	01/95-02/99	L1E, L1H	1597		0-N903	TB [TE]	
1.6 16V, 1.6 i 16V	01/95-02/99	L1E, L1H	1597		0-N904	TB [DG]	
1.8 16V	01/95-02/99	RDA, RKC	1796		0-N096	TB [DG]	
1.8 16V	01/95-02/99	RDA, RKC	1796		0-N903	TB [TE]	
1.8 16V	01/95-02/99	RDA, RKC	1796		0-N904	TB [DG]	
1.8 D, 1.8 TD, 1.8 Turbo D	01/95-02/99	RFD, RFK, RTE, RTF, RTH, RVA	1753	09/1996 →	0-N089	TB [TE]	
1.8 D, 1.8 TD, 1.8 Turbo D	01/95-02/99	RFD, RFK, RTE, RTF, RTH, RVA	1753	09/1996 →	0-N123	TB [TE]	
1.8 D, 1.8 TD, 1.8 Turbo D	01/95-02/99	RFD, RFK, RTE, RTF, RTH, RVA	1753	→ 09/1996	0-N902	TB [DG]	
1.8 D, 1.8 TD, 1.8 Turbo D	01/95-02/99	RFD, RFK, RTE, RTF, RTH, RVA	1753		0-N915	TB [TE]	
1.8 D, 1.8 Turbo D	01/95-02/99	RTE, RTF, RTH, RVA	1753	→ 09/1996	0-N985	TB [TE]	
1.8 TD	01/95-02/99	RFD, RFK	1753	→ 10/1995	0-N874	TB [TE]	
1.8 TD	01/95-02/99	RFD, RFK	1753	10/1995 → 09/1996	0-N985	TB [TE]	
1.3	01/95-01/99	J4B, J6A	1299	08/1995 →; für Fahrzeuge mit Servolenkung	0-N1443	VB [BT]	S
1.4	01/95-02/99	F4B, FUH	1392	mit Anbaumaterial; ⚠, für Fahrzeuge mit Servolenkung	0-N197	VB [DG]	
1.6 16V, 1.6 i 16V	01/95-02/99	L1E, L1H	1597	⚠, für Fahrzeuge mit Servolenkung	0-N1385	VB [DG]	
1.6 16V, 1.6 i 16V	01/95-02/99	L1E, L1H	1597		0-N1533	VB [BT]	S
1.8 16V	01/95-02/99	RDA, RKC	1796	⚠, für Fahrzeuge mit Servolenkung	0-N1385	VB [DG]	
1.8 16V	01/95-02/99	RDA, RKC	1796		0-N1533	VB [BT]	S
1.8 D, 1.8 TD, 1.8 Turbo D	01/95-02/99	RFD, RFK, RTE, RTF, RTH, RVA	1753		0-N1400	VB [TE]	S



OPTIMAL®

FORD



CM³



Art. Nr.



ESCORT VII Kombi (GAL, ANL)								
1.8 D, 1.8 TD, 1.8 Turbo D	01/95-02/99	RFD, RFK, RTE, RTF, RTH, RVA	1753			0-N1501	VB [BT]	S
F-450 SUPER DUTY [USA] Cab & Chassis								
1.6 Flex	01/04-12/06		5949			0-N1331	TB [TE]	
FIESTA I (GFBT)								
1.6 XR2	08/81-08/83	L3E	1599			0-N837	TB [TE]	
FIESTA II (FBD)								
1.4	09/83-01/87	FUBA	1392	19x97; 01/1986 →		SK-1027	BTK	
1.4	10/85-11/89	F6A, F6C, FUB, FUD	1392	19x97		SK-1027	BTK	
1.6 D	04/84-02/89	LTB	1608	19.05x98		SK-1039	BTK	
1.6 XR2	04/84-02/89	LUB	1597	19x97; 09/1986 →		SK-1027	BTK	
1.6, 1.6 XR2	03/84-11/89	LP3, LUD	1597	19x97		SK-1027	BTK	
1.4	09/83-11/89	F6A, F6C, FUB, FUBA, FUD	1392			0-N837	TB [TE]	
1.6 D	04/84-02/89	LTB	1608			0-N838	TB [TE]	
1.6 XR2	03/84-02/89	LUB, LUD	1597			0-N837	TB [TE]	
FIESTA Kasten (FVD)								
1.4	09/86-09/89	F6A	1392	19x97		SK-1027	BTK	
1.6 D	09/83-09/89	LTB	1608	19.05x98		SK-1039	BTK	
1.8 D	03/89-12/95	RTC, RTD, RTG	1753	20x116; 22x85; 11/1989 →; mit Zubehör		SK-1041	BTK	
1.8 D	03/89-12/95	RTC, RTD, RTG	1753	22x116; 22x85; 10/1995 →		SK-1042	BTK	
1.8 D	03/89-12/95	RTC, RTD, RTG	1753	→ 10/1995		0-N874	TB [TE]	
1.8 D	03/89-12/95	RTC, RTD, RTG	1753			0-N902	TB [DG]	
1.8 D	03/89-12/95	RTC, RTD, RTG	1753			0-N915	TB [TE]	
1.8 D	03/89-12/95	RTC, RTD, RTG	1753	10/1995 →		0-N985	TB [TE]	
1.8 D	03/89-12/95	RTC, RTD, RTG	1753	01/1994 → 10/1995; Rippenanzahl: 4		0-N1400	VB [TE]	S
1.8 D	03/89-12/95	RTC, RTD, RTG	1753	10/1995 →		0-N1501	VB [BT]	S
FIESTA III (GFJ)								
1.4, 1.4 KAT	03/89-12/95	F4A, F6E, FUG, FUJ	1391	19x97; → 04/1992		SK-1027	BTK	
1.4, 1.4 KAT	03/89-12/95	F4A, F6E, FUG, FUJ	1391	21x97; 04/1992 →		SK-1053	BTK	
1.4, 1.4 KAT	03/89-12/95	F4A, F6E, FUG, FUJ	1391	21.6x97; 04/1992 →		SK-1053AQ1	BTKW	
1.6 i 16V	01/94-12/95	L1G	1597	25x131; mit Zubehör		SK-1094	BTK	
1.6 i 16V	01/94-12/95	L1G	1597	25x131		SK-1094AQ1	BTKW	
1.6 Turbo, 1.6 XR2i	03/89-03/93	LHA, LJD	1598	19x97; → 04/1992		SK-1027	BTK	
1.6 Turbo, 1.6 XR2i	03/89-03/93	LHA, LJD	1598	21x97; 04/1992 →		SK-1053	BTK	
1.6 Turbo, 1.6 XR2i	03/89-03/93	LHA, LJD	1598	21.6x97; 04/1992 →		SK-1053AQ1	BTKW	
1.6, 1.6 XR2i	01/89-01/94	LJC, LUH	1597	19x97; → 04/1992		SK-1027	BTK	
1.6, 1.6 XR2i	01/89-01/94	LJC, LUH	1597	21x97; 04/1992 →		SK-1053	BTK	
1.6, 1.6 XR2i	01/89-01/94	LJC, LUH	1597	21.6x97; 04/1992 →		SK-1053AQ1	BTKW	
1.8 16V, 1.8 XR2i 16V	02/92-12/95	RDB, RQC	1796	25x131; mit Zubehör		SK-1094	BTK	
1.8 16V, 1.8 XR2i 16V	02/92-12/95	RDB, RQC	1796	25x131		SK-1094AQ1	BTKW	
1.8 D	03/89-12/95	RTC, RTD, RTG	1753	20x116; 22x85; mit Zubehör		SK-1041	BTK	
1.8 D	03/89-12/95	RTC, RTD, RTG	1753	22x116; 22x85; 10/1995 →		SK-1042	BTK	
1.8 D	03/89-12/95	RTC, RTD, RTG	1753	22x116; 22x85; 10/1995 →		SK-1042AQ1	BTKW	
1.4, 1.4 KAT	03/89-12/95	F4A, F6E, FUG, FUJ	1391			0-N837	TB [TE]	
1.6 i 16V	01/94-12/95	L1G	1597			0-N096	TB [DG]	
1.6 i 16V	01/94-12/95	L1G	1597			0-N903	TB [TE]	
1.6 i 16V	01/94-12/95	L1G	1597			0-N904	TB [DG]	
1.6 Turbo, 1.6 XR2i	03/89-03/93	LHA, LJD	1598			0-N837	TB [TE]	
1.6, 1.6 XR2i	01/89-01/94	LJC, LUH	1597			0-N837	TB [TE]	
1.8 16V, 1.8 XR2i 16V	02/92-12/95	RDB, RQC	1796			0-N096	TB [DG]	
1.8 16V, 1.8 XR2i 16V	02/92-12/95	RDB, RQC	1796			0-N903	TB [TE]	
1.8 16V, 1.8 XR2i 16V	02/92-12/95	RDB, RQC	1796			0-N904	TB [DG]	
1.8 D	03/89-12/95	RTC, RTD, RTG	1753	→ 10/1995		0-N874	TB [TE]	
1.8 D	03/89-12/95	RTC, RTD, RTG	1753	10/1995 →		0-N985	TB [TE]	
1.8 D, 1.8 TD	03/89-12/95	RFL, RTC, RTD, RTG	1753			0-N902	TB [DG]	
1.8 D, 1.8 TD	03/89-12/95	RFL, RTC, RTD, RTG	1753			0-N915	TB [TE]	
1.8 TD	03/93-12/95	RFL	1753			0-N874	TB [TE]	
1.3	03/89-12/92	JBC	1299			0-N1401	VB [DG]	
1.3 KAT	05/91-01/97	J6B	1299	01/1994 →		0-N1401	VB [DG]	
1.4, 1.4 KAT	03/89-12/95	F4A, F6E, FUG, FUJ	1391	mit Anbaumaterial; ⚠, für Fahrzeuge mit Servolenkung		0-N197	VB [DG]	
1.6 i 16V	01/94-12/95	L1G	1597	→ 03/1995; für Fahrzeuge mit Servolenkung, ⚠		0-N1401	VB [DG]	
1.6 i 16V	01/94-12/95	L1G	1597	→ 03/1995; ⚠, für Fahrzeuge ohne Servolenkung		0-N1401	VB [DG]	

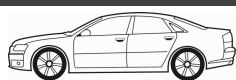

CM³



Art. Nr.



ohne Halter

FIESTA III (GFJ)								
1.6 Turbo , 1.6 XR2i	03/89-03/93	LHA, LJD	1598	mit Anbaumaterial; ⚡, für Fahrzeuge mit Servolenkung	0-N197	VB [DG]		
1.6, 1.6 XR2i	01/89-01/94	LJC, LUH	1597	mit Anbaumaterial; ⚡, für Fahrzeuge mit Servolenkung	0-N197	VB [DG]		
1.8 16V, 1.8 XR2i 16V	02/92-12/95	RDB, RQC	1796	→ 03/1995; für Fahrzeuge mit Servolenkung, ⚡	0-N1401	VB [DG]		
1.8 16V, 1.8 XR2i 16V	02/92-12/95	RDB, RQC	1796	→ 03/1995; ⚡, für Fahrzeuge ohne Servolenkung	0-N1401	VB [DG]		
1.8 D	03/89-12/95	RTC, RTD, RTG	1753	01/1994 → 10/1995; Rippenanzahl: 4	0-N1400	VB [TE]		S
1.8 D	03/89-12/95	RTC, RTD, RTG	1753	10/1995 →	0-N1501	VB [BT]		S
FIESTA IV (JA_, JB_)								
1.25 i 16V	08/95-01/02	DHA, DHB, DHC, DHD, DHE, DHF, DHG	1242	22x117; 02/1997 →; mit Zubehör	SK-1077	BTK		
1.25 i 16V	08/95-01/02	DHA, DHB, DHC, DHD, DHE, DHF, DHG	1242	22x117; 02/1997 →; mit Zubehör	SK-1077AQ1	BTKW		
1.25 i 16V	08/95-01/02	DHA, DHB, DHC, DHD, DHE, DHF, DHG	1242	22x117; → 02/1997	SK-1105	BTK		
1.4 i 16V	04/96-01/02	FHA, FHE	1388	22x117; 02/1997 →; mit Zubehör	SK-1077	BTK		
1.4 i 16V	04/96-01/02	FHA, FHE	1388	22x117; 02/1997 →; mit Zubehör	SK-1077AQ1	BTKW		
1.4 i 16V	04/96-01/02	FHA, FHE	1388	22x117; → 02/1997	SK-1105	BTK		
1.6 16V Sport	02/00-01/02	L1T, L1V	1596	22x117; mit Zubehör	SK-1077	BTK		
1.6 16V Sport	02/00-01/02	L1T, L1V	1596	22x117; mit Zubehör	SK-1077AQ1	BTKW		
1.8 D	08/95-04/00	RTJ, RTK	1753	22x116; 22x85; → 01/1997	SK-1042	BTK		
1.8 D	08/95-04/00	RTJ, RTK	1753	22x116; 22x85; → 01/1997	SK-1042AQ1	BTKW		
1.8 D	08/95-04/00	RTJ, RTK	1753	22x116; 22x85; 01/1997 →; mit Zubehör	SK-1078	BTK		
1.8 D	08/95-04/00	RTJ, RTK	1753	22x116; 22x85; 01/1997 →	SK-1078AQ1	BTKW		
1.8 DI	04/00-01/02	RTN, RTP, RTQ	1753	20x91	SK-1341	BTK		
1.25 i 16V	08/95-01/02	DHA, DHB, DHC, DHD, DHE, DHF, DHG	1242	→ 02/1997	0-N1260	TB [TE]		
1.25 i 16V	08/95-01/02	DHA, DHB, DHC, DHD, DHE, DHF, DHG	1242		0-N294	TB [TE]		
1.4 i 16V	04/96-01/02	FHA, FHE	1388	→ 02/1997	0-N1260	TB [TE]		
1.4 i 16V	04/96-01/02	FHA, FHE	1388	03/1997 →	0-N294	TB [TE]		
1.6 16V Sport	02/00-01/02	L1T, L1V	1596		0-N294	TB [TE]		
1.8 D	08/95-04/00	RTJ, RTK	1753	09/1996 →	0-N089	TB [TE]		
1.8 D	08/95-04/00	RTJ, RTK	1753	09/1996 →	0-N123	TB [TE]		
1.8 D	08/95-04/00	RTJ, RTK	1753	→ 10/1995	0-N874	TB [TE]		
1.8 D	08/95-04/00	RTJ, RTK	1753	→ 09/1996	0-N902	TB [DG]		
1.8 D	08/95-04/00	RTJ, RTK	1753		0-N915	TB [TE]		
1.8 D	08/95-04/00	RTJ, RTK	1753	10/1995 → 09/1996	0-N985	TB [TE]		
1.8 DI	04/00-01/02	RTN, RTP, RTQ	1753	09/2000 →	0-N1367	TB [TE]		
1.8 DI	04/00-01/02	RTN, RTP, RTQ	1753		0-N295	TB [TE]		
1.0 i	02/97-01/02	ZH10JRB	999	für Fahrzeuge mit Servolenkung	0-N1385	VB [DG]		
1.25 i 16V	08/95-01/02	DHA, DHB, DHC, DHD, DHE, DHF, DHG	1242	Rippenanzahl: 6; für Fahrzeuge mit Servolenkung, ⚡	0-N1897	VB [BT]		S
1.25 i 16V	08/95-01/02	DHA, DHB, DHC, DHD, DHE, DHF, DHG	1242	Rippenanzahl: 6; ⚡, für Fahrzeuge ohne Servolenkung	0-N1897	VB [BT]		S
1.25 i 16V	08/95-01/02	DHA, DHB, DHC, DHD, DHE, DHF, DHG	1242	Rippenanzahl: 6; ⚡, für Fahrzeuge ohne Servolenkung	0-N1897	VB [BT]		S
1.25 i 16V	08/95-01/02	DHA, DHB, DHC, DHD, DHE, DHF, DHG	1242	⚡	0-N1903	VB [BT]		S
1.3 i	08/95-01/02	J4C, J4J, J4L, J4Q, J4R, J4T, JBC, JJA, JJC, JJE, JJJ, JJK, JJM	1299		0-N1385	VB [DG]		
1.3 i	08/95-01/02	J4C, J4J, J4L, J4Q, J4R, J4T, JBC, JJA, JJC, JJE, JJJ, JJK, JJM	1299	für Fahrzeuge mit Servolenkung	0-N1443	VB [BT]		S
1.4 i 16V	04/96-01/02	FHA, FHE	1388	Rippenanzahl: 6; für Fahrzeuge mit Servolenkung, ⚡	0-N1897	VB [BT]		S
1.4 i 16V	04/96-01/02	FHA, FHE	1388	Rippenanzahl: 6; ⚡, für Fahrzeuge ohne Servolenkung	0-N1897	VB [BT]		S
1.4 i 16V	04/96-01/02	FHA, FHE	1388	Rippenanzahl: 6; ⚡, für Fahrzeuge ohne Servolenkung	0-N1897	VB [BT]		S
1.4 i 16V	04/96-01/02	FHA, FHE	1388	⚡	0-N1903	VB [BT]		S
1.6 16V Sport	02/00-01/02	L1T, L1V	1596	Rippenanzahl: 6; ⚡	0-N1897	VB [BT]		S
1.6 16V Sport	02/00-01/02	L1T, L1V	1596	⚡	0-N1903	VB [BT]		S
1.8 D	08/95-04/00	RTJ, RTK	1753	→ 10/1995; Rippenanzahl: 4	0-N1400	VB [TE]		S
1.8 D	08/95-04/00	RTJ, RTK	1753	10/1995 →	0-N1501	VB [BT]		S
1.8 D	08/95-04/00	RTJ, RTK	1753	⚡	0-N2022	VB [BT]		S
1.8 DI	04/00-01/02	RTN, RTP, RTQ	1753		0-N1385	VB [DG]		
1.8 DI	04/00-01/02	RTN, RTP, RTQ	1753	†; ⚡	0-N1458	VB [DG]		
1.8 DI	04/00-01/02	RTN, RTP, RTQ	1753		0-N1622	VB [DG]		
1.8 DI	04/00-01/02	RTN, RTP, RTQ	1753		0-N2155	VB [BT]		S
FIESTA Kasten (JV_)								
D 1.8	05/98-04/02	RTJ, RTK	1753	22x116; 22x85; mit Zubehör	SK-1078	BTK		
D 1.8	05/98-04/02	RTJ, RTK	1753	22x116; 22x85; Baumuster: Courier	SK-1078AQ1	BTKW		

CM³

Art. Nr.



FIESTA Kasten (JV_)

D 1.8	05/98-04/02	RTJ, RTK	1753	22x116; 22x85; Baumuster: Fiesta Van	SK-1078AQ1	BTKW	
TD 1.8	03/00-08/03	RTN, RTP, RTQ	1753	20x91	SK-1341	BTK	
D 1.8	05/98-04/02	RTJ, RTK	1753		0-N089	TB [TE]	
D 1.8	05/98-04/02	RTJ, RTK	1753		0-N123	TB [TE]	
D 1.8	05/98-04/02	RTJ, RTK	1753		0-N915	TB [TE]	
TD 1.8	03/00-08/03	RTN, RTP, RTQ	1753		0-N1367	TB [TE]	
TD 1.8	03/00-08/03	RTN, RTP, RTQ	1753		0-N295	TB [TE]	
D 1.8	05/98-04/02	RTJ, RTK	1753		0-N1501	VB [BT]	S
D 1.8	05/98-04/02	RTJ, RTK	1753	⊛	0-N2022	VB [BT]	S
TD 1.8	03/00-08/03	RTN, RTP, RTQ	1753	†; ⊛	0-N1458	VB [DG]	
TD 1.8	03/00-08/03	RTN, RTP, RTQ	1753		0-N1622	VB [DG]	
TD 1.8	03/00-08/03	RTN, RTP, RTQ	1753		0-N2155	VB [BT]	S

FIESTA V (JH_, JD_)

1.25 16V	05/02-06/08	FUJA, FUJB	1242	22x117; 03/2003 → 04/2005; mit Zubehör	SK-1077	BTK	
1.25 16V	05/02-06/08	FUJA, FUJB	1242	22x117; 03/2003 → 04/2005; mit Zubehör	SK-1077AQ1	BTKW	
1.25 16V	05/02-06/08	FUJA, FUJB, M7JA, M7JB	1242	22x117; 04/2005 →; mit Zubehör	SK-1659	BTK	
1.25 16V	05/02-06/08	FUJA, FUJB, M7JA, M7JB	1242	22x117; 04/2005 →; mit Zubehör	SK-1659AQ1	BTKW	
1.25 16V	03/03-06/08	M7JA, M7JB	1242	22x117; → 04/2005; mit Zubehör	SK-1077	BTK	
1.25 16V	03/03-06/08	M7JA, M7JB	1242	22x117; → 04/2005; mit Zubehör	SK-1077AQ1	BTKW	
1.4 16V	11/01-06/08	FXJA, FXJB	1388	22x117; 05/2002 → 04/2005; mit Zubehör	SK-1077	BTK	
1.4 16V	11/01-06/08	FXJA, FXJB	1388	22x117; 05/2002 → 04/2005; mit Zubehör	SK-1077AQ1	BTKW	
1.4 16V	11/01-06/08	FXJA, FXJB	1388	22x117; 04/2005 →; mit Zubehör	SK-1659	BTK	
1.4 16V	11/01-06/08	FXJA, FXJB	1388	22x117; 04/2005 →; mit Zubehör	SK-1659AQ1	BTKW	
1.4 TDCi	11/01-06/08	F6JA, F6JB	1399	25.4x144; 05/2002 → 04/2008	SK-1391	BTK	
1.4 TDCi	11/01-06/08	F6JA, F6JB	1399	25.4x144; 05/2002 → 04/2008	SK-1391AQ1	BTKW	
1.6 16V	11/01-06/08	FYJA, FYJB	1596	22x117; 05/2002 → 04/2005; mit Zubehör	SK-1077	BTK	
1.6 16V	11/01-06/08	FYJA, FYJB	1596	22x117; 05/2002 → 04/2005; mit Zubehör	SK-1077AQ1	BTKW	
1.6 16V	11/01-06/08	FYJA, FYJB	1596	22x117; 04/2005 →; mit Zubehör	SK-1659	BTK	
1.6 16V	11/01-06/08	FYJA, FYJB	1596	22x117; 04/2005 →; mit Zubehör	SK-1659AQ1	BTKW	
1.6 TDCi	11/04-06/08	HHJA, HHJB	1560	25x137	SK-1424	BTK	
1.6 TDCi	11/04-06/08	HHJA, HHJB	1560	25x137	SK-1424AQ1	BTKW	
1.25 16V	05/02-06/08	FUJA, FUJB, M7JA, M7JB	1242	04/2005 →	0-N1564	TB [TE]	
1.25 16V	05/02-06/08	FUJA, FUJB, M7JA, M7JB	1242	→ 04/2005	0-N294	TB [TE]	
1.4 16V	11/01-06/08	FXJA, FXJB	1388	04/2005 →	0-N1564	TB [TE]	
1.4 16V	11/01-06/08	FXJA, FXJB	1388		0-N294	TB [TE]	
1.4 TDCi	11/01-06/08	F6JA, F6JB	1399		0-N1062	TB [TE]	
1.4 TDCi	11/01-06/08	F6JA, F6JB	1399		0-N1066	TB [DG]	
1.6 16V	11/01-06/08	FYJA, FYJB	1596	04/2005 →	0-N1564	TB [TE]	
1.6 16V	11/01-06/08	FYJA, FYJB	1596		0-N294	TB [TE]	
1.6 TDCi	11/04-06/08	HHJA, HHJB	1560		0-N1062	TB [TE]	
1.6 TDCi	11/04-06/08	HHJA, HHJB	1560		0-N1066	TB [DG]	
1.3	11/01-06/08	A9JA, A9JB, BAJA	1299		0-N2266	VB [BT]	
1.3	11/01-06/08	A9JA, A9JB, BAJA	1299		0-N2266S1	VB [DG]	
1.3	11/01-06/08	A9JA, A9JB, BAJA	1299		0-N2266S2	VB [DG]	
1.4 TDCi	11/01-06/08	F6JA, F6JB	1399		0-N1418	VB [DG]	
1.4 TDCi	11/01-06/08	F6JA, F6JB	1399	⊛	0-N1420	VB [DG]	
1.4 TDCi	11/01-06/08	F6JA, F6JB	1399		0-N1636	VB [BT]	S
1.6 TDCi	11/04-06/08	HHJA, HHJB	1560		0-N1339	VB [BT]	S
1.6 TDCi	11/04-06/08	HHJA, HHJB	1560		0-N1418	VB [DG]	
ST150	03/05-06/08	N4JB	1999	→ 11/2005	0-N1702	VB [DG]	
ST150	03/05-06/08	N4JB	1999	05/2005 → 07/2008; Rippenanzahl: 6	0-N1811	VB [BT]	S
ST150	03/05-06/08	N4JB	1999	12/2005 →	0-N1991	VB [DG]	

FIESTA V Van

1.4 TDCi	10/03-12/10	F6JA, F6JB	1399	25.4x144; → 04/2008	SK-1391	BTK	
1.4 TDCi	10/03-12/10	F6JA, F6JB	1399	25.4x144; → 04/2008	SK-1391AQ1	BTKW	
1.4 TDCi	10/03-12/10	F6JA, F6JB	1399		0-N1062	TB [TE]	
1.4 TDCi	10/03-12/10	F6JA, F6JB	1399		0-N1066	TB [DG]	
1.3	10/03-07/05	A9JA, A9JB	1299		0-N2266	VB [BT]	
1.3	10/03-07/05	A9JA, A9JB	1299		0-N2266S1	VB [DG]	
1.3	10/03-07/05	A9JA, A9JB	1299		0-N2266S2	VB [DG]	
1.4 TDCi	10/03-12/10	F6JA, F6JB	1399		0-N1418	VB [DG]	
1.4 TDCi	10/03-12/10	F6JA, F6JB	1399	⊛	0-N1420	VB [DG]	
1.4 TDCi	10/03-12/10	F6JA, F6JB	1399		0-N1636	VB [BT]	S

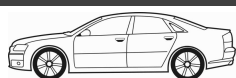

CM³



Art. Nr.



FIESTA VI

1.25	06/08-	SNJA, SNJB, SNJC, SNJD, STJA, STJB	1242	22x117; mit Zubehör	SK-1659	BTK	
1.25	06/08-	SNJA, SNJB, SNJC, SNJD, STJA, STJB	1242	22x117; mit Zubehör	SK-1659AQ1	BTKW	
1.4 TDCi	01/09-	F6JB	1399	25.4x144; → 01/2010	SK-1391	BTK	
1.4 TDCi	01/09-	F6JB	1399	25.4x144; → 01/2010	SK-1391AQ1	BTKW	
1.4 TDCi	07/10-	F6JD, KVJA	1399	25.4x139	SK-1732	BTK	
1.4 TDCi	07/10-	F6JD, KVJA	1399	25.4x139	SK-1732AQ1	BTKW	
1.4, 1.4 LPG	06/08-	RTJA, RTJB, SPJA, SPJC	1388	22x117; mit Zubehör	SK-1659	BTK	
1.4, 1.4 LPG	06/08-	RTJA, RTJB, SPJA, SPJC	1388	22x117; mit Zubehör	SK-1659AQ1	BTKW	
1.5 TDCi	09/12-	UGJC	1499	25x141	SK-1728	BTK	
1.5 TDCi	09/12-	UGJC	1499	25x141	SK-1728AQ1	BTKW	
1.6	06/08-		1597	22x117; mit Zubehör	SK-1659AQ1	BTKW	
1.6 TDCi	06/08-	HHJC, HHJD, HHJE, HHJF, UBJA	1560	25x137; → 12/2009	SK-1424	BTK	
1.6 TDCi	06/08-	HHJC, HHJD, HHJE, HHJF, UBJA	1560	25x137; → 12/2009	SK-1424AQ1	BTKW	
1.6 TDCi	02/10-	T3JA, TZJA, TZJB	1560	25x141	SK-1728	BTK	
1.6 TDCi	02/10-	T3JA, TZJA, TZJB	1560	25x141	SK-1728AQ1	BTKW	
1.6 Ti	06/08-	HXJA, HXJB, U5JA	1596	22x117; mit Zubehör	SK-1659	BTK	
1.6 Ti	06/08-	HXJA, HXJB, U5JA	1596	22x117; mit Zubehör	SK-1659AQ1	BTKW	
1.25	06/08-	M7JA, M7JB	1242		0-N1564	TB [TE]	
1.4 TDCi	01/09-	F6JB	1399		0-N1062	TB [TE]	
1.4 TDCi	01/09-	F6JB	1399		0-N1066	TB [DG]	
1.4 TDCi	07/10-	F6JD, KVJA	1399		0-N2224	TB [TE]	
1.4 TDCi	07/10-	F6JD, KVJA	1399		0-N2382	TB [DG]	
1.4, 1.4 LPG	06/08-	RTJA, RTJB, SPJA, SPJC	1388		0-N1564	TB [TE]	
1.5 TDCi	09/12-	UGJC, XVJB, XVJC	1499		0-N2382	TB [DG]	
1.6	06/08-		1597		0-N1564	TB [TE]	
1.6 ST	03/13-	JTJA	1596		0-N2057	TB [TE]	
1.6 TDCi	06/08-	HHJC, HHJD, HHJE, HHJF, UBJA	1560		0-N1062	TB [TE]	
1.6 TDCi	06/08-	HHJC, HHJD, HHJE, HHJF, UBJA	1560		0-N1066	TB [DG]	
1.6 TDCi	02/10-	T3JA, TZJA, TZJB	1560		0-N2224	TB [TE]	
1.6 TDCi	02/10-	T3JA, TZJA, TZJB	1560		0-N2382	TB [DG]	
1.6 Ti	06/08-	HXJA, HXJB, IQJA, U5JA	1596		0-N1564	TB [TE]	
1.0, 1.0 EcoBoost	09/12-	M1JE, M1JH, P4JA, P4JB, P4JC, P4JD, SFJA, SFJB, SFJC, SFJD, XMJA, XMJB	998		0-N2300	VB [BT]	S
1.0, 1.0 EcoBoost	09/12-	M1JE, M1JH, P4JA, P4JB, P4JC, P4JD, SFJA, SFJB, SFJC, SFJD, XMJA, XMJB	998		0-N2303	VB [DG]	
1.0, 1.0 EcoBoost	09/12-	M1JE, M1JH, P4JA, P4JB, P4JC, P4JD, SFJA, SFJB, SFJC, SFJD, XMJA, XMJB	998	✱	0-N2353	VB [DG]	
1.25	06/08-	SNJA, SNJB, SNJC, SNJD, STJA, STJB	1242	✱	0-N2353	VB [DG]	
1.4 TDCi	01/09-	F6JB, F6JD, KVJA	1399		0-N1339	VB [BT]	S
1.4 TDCi	01/09-	F6JB, F6JD, KVJA	1399		0-N1418	VB [DG]	
1.4, 1.4 LPG	06/08-	RTJA, RTJB, SPJA, SPJC	1388	✱	0-N2353	VB [DG]	
1.5 TDCi	09/12-	UGJC	1499		0-N1339	VB [BT]	S
1.6 ST	03/13-	JTJA	1596		0-N2269	VB [BT]	S
1.6 ST	03/13-	JTJA	1596		0-N2363	VB [DG]	
1.6 TDCi	06/08-	HHJC, HHJD, HHJE, HHJF, UBJA, T3JA, TZJA, TZJB	1560		0-N1339	VB [BT]	S
1.6 TDCi	06/08-	HHJC, HHJD, HHJE, HHJF, UBJA	1560		0-N1418	VB [DG]	
1.6 TDCi	02/10-	T3JA, TZJA, TZJB	1560	03/2010 →	0-N1418	VB [DG]	
1.6 Ti	06/08-	HXJA, HXJB, IQJA, U5JA	1596	✱	0-N2353	VB [DG]	

FIESTA VI Van

1.25	01/09-	SNJA, SNJB	1242	22x117; mit Zubehör	SK-1659	BTK	
1.25	01/09-	SNJA, SNJB	1242	22x117; mit Zubehör	SK-1659AQ1	BTKW	
1.4 TDCi	01/09-	F6JB	1399	25.4x144	SK-1391	BTK	
1.4 TDCi	01/09-	F6JB	1399	25.4x144	SK-1391AQ1	BTKW	
1.4 TDCi	07/10-	F6JD, KVJA	1399	25.4x139	SK-1732	BTK	
1.4 TDCi	07/10-	F6JD, KVJA	1399	25.4x139	SK-1732AQ1	BTKW	
1.5 TDCi	10/12-	UGJC	1499	25x141	SK-1728	BTK	
1.5 TDCi	10/12-	UGJC	1499	25x141	SK-1728AQ1	BTKW	
1.6 TDCi	01/09-	HHJC, HHJD, HHJE	1560	25x137; → 12/2009	SK-1424	BTK	
1.6 TDCi	01/09-	HHJC, HHJD, HHJE	1560	25x137; → 12/2009	SK-1424AQ1	BTKW	
1.6 TDCi	02/10-	T3JA, TZJA, TZJB	1560	25x141	SK-1728	BTK	
1.6 TDCi	02/10-	T3JA, TZJA, TZJB	1560	25x141	SK-1728AQ1	BTKW	
1.25	01/09-	SNJA, SNJB	1242		0-N1564	TB [TE]	
1.4 TDCi	01/09-	F6JB	1399		0-N1062	TB [TE]	
1.4 TDCi	01/09-	F6JB	1399		0-N1066	TB [DG]	
1.4 TDCi	07/10-	F6JD, KVJA	1399		0-N2224	TB [TE]	

CM³

Art. Nr.



ohne Halter

FIESTA VI Van

1.4 TDCi	07/10-	F6JD, KVJA	1399		0-N2382	TB [DG]	
1.5 TDCi	10/12-	UGJC, XVJB, XVJC	1499		0-N2382	TB [DG]	
1.6 ST	03/13-	JTJA	1596		0-N2057	TB [TE]	
1.6 TDCi	01/09-	HHJC, HHJD, HHJE	1560		0-N1062	TB [TE]	
1.6 TDCi	01/09-	HHJC, HHJD, HHJE	1560		0-N1066	TB [DG]	
1.6 TDCi	02/10-	T3JA, TZJA, TZJB	1560		0-N2224	TB [TE]	
1.6 TDCi	02/10-	T3JA, TZJA, TZJB	1560		0-N2382	TB [DG]	
1.25	01/09-	SNJA, SNJB	1242	✘	0-N2353	VB [DG]	
1.4 TDCi	01/09-	F6JB, F6JD, KVJA	1399		0-N1339	VB [BT]	S
1.4 TDCi	01/09-	F6JB, F6JD, KVJA	1399		0-N1418	VB [DG]	
1.5 TDCi	10/12-	UGJC	1499		0-N1339	VB [BT]	S
1.6 ST	03/13-	JTJA	1596		0-N2363	VB [DG]	
1.6 TDCi	01/09-	HHJC, HHJD, HHJE, T3JA, TZJA, TZJB	1560		0-N1339	VB [BT]	S
1.6 TDCi	01/09-	HHJC, HHJD, HHJE	1560		0-N1418	VB [DG]	
1.6 TDCi	02/10-	T3JA, TZJA, TZJB	1560	03/2010 →	0-N1418	VB [DG]	

FIESTA Stufenheck

1.25	10/12-	STJB	1242		0-N1564	TB [TE]	
1.25	10/12-	STJB	1242	✘	0-N2353	VB [DG]	

FOCUS (DAW, DBW)

1.4 16V	10/98-11/04	FXDA, FXDB, FXDC, FXDD	1388	22x117; mit Zubehör	SK-1077	BTK	
1.4 16V	10/98-11/04	FXDA, FXDB, FXDC, FXDD	1388	22x117; mit Zubehör	SK-1077AQ1	BTKW	
1.6 16V, 1.6 16V Flexifuel	10/98-11/04	FYDA, FYDB, FYDC, FYDD, FYDH, FYDH, FYDH	1596	22x117; mit Zubehör	SK-1077	BTK	
1.6 16V, 1.6 16V Flexifuel	10/98-11/04	FYDA, FYDB, FYDC, FYDD, FYDH, FYDH, FYDH	1596	22x117; mit Zubehör	SK-1077AQ1	BTKW	
1.8 16V	10/98-11/04	EYDB, EYDC, EYDD, EYDE, EYDF, EYDG, EYDI, EYDJ, EYDL	1796	25x129; → 11/1998; beinhaltetete Rollen: 3	SK-1339	BTK	
1.8 16V	10/98-11/04	EYDB, EYDC, EYDD, EYDE, EYDF, EYDG, EYDI, EYDJ, EYDL	1796	25x129; beinhaltetete Rollen: 2	SK-1340	BTK	
1.8 DI / TDDi	08/99-11/04	BHDA, BHDB	1753	20x91; 09/2000 →	SK-1341	BTK	
1.8 TDCi, 1.8 Turbo DI / TDDi	10/98-11/04	C9DA, C9DB, C9DC, F9DA, F9DB, FFDA	1753	20x91	SK-1341	BTK	
2.0 16V	10/98-11/04	EDDB, EDDC, EDDD, EDDF	1988	25x129; → 01/1999; beinhaltetete Rollen: 3	SK-1339	BTK	
2.0 16V	10/98-11/04	EDDB, EDDC, EDDD, EDDF	1988	25x129; 02/1999 →; beinhaltetete Rollen: 2	SK-1340	BTK	
RS	10/02-11/04	HMDA	1988	25x129; beinhaltetete Rollen: 2	SK-1340	BTK	
1.4 16V	10/98-11/04	FXDA, FXDB, FXDC, FXDD	1388		0-N294	TB [TE]	
1.6 16V	10/98-11/04	FYDA, FYDB, FYDC, FYDD, FYDH	1596		0-N294	TB [TE]	
1.8 16V	10/98-11/04	EYDB, EYDC, EYDD, EYDE, EYDF, EYDG, EYDI, EYDJ, EYDL	1796		0-N290	TB [TE]	
1.8 16V	10/98-11/04	EYDB, EYDC, EYDD, EYDE, EYDF, EYDG, EYDI, EYDJ, EYDL	1796	01/1999 →; †	0-N291	TB [DG]	
1.8 16V	10/98-11/04	EYDB, EYDC, EYDD, EYDE, EYDF, EYDG, EYDI, EYDJ, EYDL	1796	→ 01/1999	0-N292	TB [DG]	
1.8 16V	10/98-11/04	EYDB, EYDC, EYDD, EYDE, EYDF, EYDG, EYDI, EYDJ, EYDL	1796	→ 01/1999	0-N293	TB [DG]	
1.8 DI / TDDi, 1.8 TDCi, 1.8 Turbo DI / TDDi	10/98-11/04	BHDA, BHDB, C9DA, C9DB, C9DC, F9DA, F9DB, FFDA	1753		0-N295	TB [TE]	
1.8 DI / TDDi, 1.8 Turbo DI / TDDi	10/98-11/04	BHDA, BHDB, C9DA, C9DB, C9DC	1753	09/2000 →	0-N1367	TB [TE]	
1.8 TDCi	03/01-11/04	F9DA, F9DB, FFDA	1753		0-N1367	TB [TE]	
2.0 16V	10/98-11/04	EDDB, EDDC, EDDD, EDDF	1988	01/1999 →; †	0-N291	TB [DG]	
2.0 16V	10/98-11/04	EDDB, EDDC, EDDD, EDDF	1988	→ 01/1999	0-N292	TB [DG]	
2.0 16V	10/98-11/04	EDDB, EDDC, EDDD, EDDF	1988	→ 01/1999	0-N293	TB [DG]	
2.0 16V, RS	10/98-11/04	EDDB, EDDC, EDDD, EDDF, HMDA	1988		0-N290	TB [TE]	
RS, ST170	03/02-11/04	ALDA, HMDA	1988	†	0-N291	TB [DG]	
1.4 16V	10/98-11/04	FXDA, FXDB, FXDC, FXDD	1388		0-N1385	VB [DG]	
1.4 16V	10/98-11/04	FXDA, FXDB, FXDC, FXDD	1388	Rippenanzahl: 6; ✘	0-N1433	VB [BT]	S
1.4 16V	10/98-11/04	FXDA, FXDB, FXDC, FXDD	1388	Rippenanzahl: 6; ✘	0-N1434	VB [BT]	S
1.6 16V	10/98-11/04	FYDA, FYDB, FYDC, FYDD, FYDH	1596	Rippenanzahl: 6; ✘	0-N1433	VB [BT]	S
1.6 16V	10/98-11/04	FYDA, FYDB, FYDC, FYDD, FYDH	1596	Rippenanzahl: 6; ✘	0-N1434	VB [BT]	S
1.6 16V, 1.6 16V Flexifuel	10/98-11/04	FYDA, FYDB, FYDC, FYDD, FYDH, FYDH, FYDH	1596		0-N1385	VB [DG]	
1.8 16V	10/98-11/04	EYDB, EYDC, EYDD, EYDE, EYDF, EYDG, EYDI, EYDJ, EYDL	1796	Rippenanzahl: 6	0-N1435	VB [BT]	S
1.8 16V	10/98-11/04	EYDB, EYDC, EYDD, EYDE, EYDF, EYDG, EYDI, EYDJ, EYDL	1796	für Fahrzeuge mit Servolenkung	0-N1716	VB [DG]	
1.8 DI / TDDi, 1.8 TDCi, 1.8 Turbo DI / TDDi	10/98-11/04	BHDA, BHDB, C9DA, C9DB, C9DC, F9DA, F9DB, FFDA	1753	†; ✘	0-N1458	VB [DG]	
1.8 DI / TDDi, 1.8 TDCi, 1.8 Turbo DI / TDDi	10/98-11/04	BHDA, BHDB, C9DA, C9DB, C9DC, F9DA, F9DB, FFDA	1753		0-N1520	VB [BT]	S

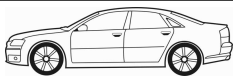

CM³



Art. Nr.



FOCUS (DAW, DBW)

1.8 DI / TDDi, 1.8 TDCi, 1.8 Turbo DI / TDDi	10/98-11/04	BHDA, BHDB, C9DA, C9DB, C9DC, F9DA, F9DB, FFDA	1753		0-N1610	VB [BT]	
2.0 16V	10/98-11/04	EDDB, EDDC, EDDD, EDDF	1988	für Fahrzeuge mit Servolenkung	0-N1716	VB [DG]	
2.0 16V, RS, ST170	10/98-11/04	ALDA, EDDB, EDDC, EDDD, EDDF, HMDA	1988	Rippenanzahl: 6	0-N1435	VB [BT]	S
ST170	03/02-11/04	ALDA	1988		0-N1716	VB [DG]	

FOCUS [USA] Turnier

1.0 Flex	01/01-12/04		1989	☼, für Fahrzeuge mit Servolenkung	0-N1890	VB [BT]	S
----------	-------------	--	------	-----------------------------------	----------------	---------	---

FOCUS Stufenheck (DFW)

1.4 16V	02/99-11/04	FXDA, FXDB, FXDC, FXDD	1388	22x117; mit Zubehör	SK-1077	BTK	
1.4 16V	02/99-11/04	FXDA, FXDB, FXDC, FXDD	1388	22x117; mit Zubehör	SK-1077AQ1	BTKW	
1.6 16V	02/99-11/04	FYDA, FYDB, FYDC, FYDD, FYDH	1596	22x117; mit Zubehör	SK-1077	BTK	
1.6 16V	02/99-11/04	FYDA, FYDB, FYDC, FYDD, FYDH	1596	22x117; mit Zubehör	SK-1077AQ1	BTKW	
1.8 16V	02/99-11/04	EYDB, EYDC, EYDD, EYDE, EYDF, EYDG, EYDI, EYDJ, EYDL	1796	25x129; beinhaltete Rollen: 2	SK-1340	BTK	
1.8 TDCi, 1.8 Turbo DI / TDDi	03/01-03/05	BHDA, BHDB, F9DA, F9DB, FFDA	1753	20x91	SK-1341	BTK	
1.8 Turbo DI / TDDi	02/99-11/04	C9DA, C9DB, C9DC	1753	20x91; 09/2000 →	SK-1341	BTK	
2.0 16V	02/99-11/04	EDDB, EDDC, EDDD, EDDF	1988	25x129; beinhaltete Rollen: 2	SK-1340	BTK	
1.4 16V	02/99-11/04	FXDA, FXDB, FXDC, FXDD	1388		0-N294	TB [TE]	
1.6 16V	02/99-11/04	FYDA, FYDB, FYDC, FYDD, FYDH	1596		0-N294	TB [TE]	
1.8 16V	02/99-11/04	EYDB, EYDC, EYDD, EYDE, EYDF, EYDG, EYDI, EYDJ, EYDL	1796		0-N290	TB [TE]	
1.8 16V	02/99-11/04	EYDB, EYDC, EYDD, EYDE, EYDF, EYDG, EYDI, EYDJ, EYDL	1796	†	0-N291	TB [DG]	
1.8 TDCi, 1.8 Turbo DI / TDDi	02/99-11/04	C9DA, C9DB, C9DC, F9DA, F9DB, FFDA	1753		0-N295	TB [TE]	
1.8 TDCi, 1.8 Turbo DI / TDDi	03/01-03/05	BHDA, BHDB, F9DA, F9DB, FFDA	1753		0-N1367	TB [TE]	
1.8 Turbo DI / TDDi	02/99-11/04	C9DA, C9DB, C9DC	1753	09/2000 →	0-N1367	TB [TE]	
2.0 16V	02/99-11/04	EDDB, EDDC, EDDD, EDDF	1988		0-N290	TB [TE]	
2.0 16V	02/99-11/04	EDDB, EDDC, EDDD, EDDF	1988	†	0-N291	TB [DG]	
1.4 16V	02/99-11/04	FXDA, FXDB, FXDC, FXDD	1388		0-N1385	VB [DG]	
1.4 16V	02/99-11/04	FXDA, FXDB, FXDC, FXDD	1388	Rippenanzahl: 6; ☼	0-N1433	VB [BT]	S
1.4 16V	02/99-11/04	FXDA, FXDB, FXDC, FXDD	1388	Rippenanzahl: 6; ☼	0-N1434	VB [BT]	S
1.6 16V	02/99-11/04	FYDA, FYDB, FYDC, FYDD, FYDH	1596		0-N1385	VB [DG]	
1.6 16V	02/99-11/04	FYDA, FYDB, FYDC, FYDD, FYDH	1596	Rippenanzahl: 6; ☼	0-N1433	VB [BT]	S
1.6 16V	02/99-11/04	FYDA, FYDB, FYDC, FYDD, FYDH	1596	Rippenanzahl: 6; ☼	0-N1434	VB [BT]	S
1.8 16V	02/99-11/04	EYDB, EYDC, EYDD, EYDE, EYDF, EYDG, EYDI, EYDJ, EYDL	1796	Rippenanzahl: 6	0-N1435	VB [BT]	S
1.8 16V	02/99-11/04	EYDB, EYDC, EYDD, EYDE, EYDF, EYDG, EYDI, EYDJ, EYDL	1796	für Fahrzeuge mit Servolenkung	0-N1716	VB [DG]	
1.8 TDCi, 1.8 Turbo DI / TDDi	02/99-03/05	BHDA, BHDB, C9DA, C9DB, C9DC, F9DA, F9DB, FFDA	1753	†; ☼	0-N1458	VB [DG]	
1.8 TDCi, 1.8 Turbo DI / TDDi	02/99-03/05	BHDA, BHDB, C9DA, C9DB, C9DC, F9DA, F9DB, FFDA	1753		0-N1520	VB [BT]	S
1.8 TDCi, 1.8 Turbo DI / TDDi	02/99-03/05	BHDA, BHDB, C9DA, C9DB, C9DC, F9DA, F9DB, FFDA	1753		0-N1610	VB [BT]	
2.0 16V	02/99-11/04	EDDB, EDDC, EDDD, EDDF	1988	Rippenanzahl: 6	0-N1435	VB [BT]	S
2.0 16V	02/99-11/04	EDDB, EDDC, EDDD, EDDF	1988	für Fahrzeuge mit Servolenkung	0-N1716	VB [DG]	

FOCUS Kombi (DNW)

1.4 16V	02/99-11/04	FXDA, FXDB, FXDC, FXDD	1388	22x117; mit Zubehör	SK-1077	BTK	
1.4 16V	02/99-11/04	FXDA, FXDB, FXDC, FXDD	1388	22x117; mit Zubehör	SK-1077AQ1	BTKW	
1.6 16V, 1.6 16V Flexifuel	02/99-11/04	FYDA, FYDB, FYDC, FYDD, FYDH	1596	22x117; mit Zubehör	SK-1077	BTK	
1.6 16V, 1.6 16V Flexifuel	02/99-11/04	FYDA, FYDB, FYDC, FYDD, FYDH	1596	22x117; mit Zubehör	SK-1077AQ1	BTKW	
1.8 16V, 1.8 BiFuel	02/99-01/05	EYDB, EYDC, EYDD, EYDE, EYDF, EYDG, EYDI, EYDJ, EYDL	1796	25x129; beinhaltete Rollen: 2	SK-1340	BTK	
1.8 DI / TDDi, 1.8 Turbo DI / TDDi	02/99-11/04	BHDA, BHDB, C9DA, C9DB, C9DC	1753	20x91; 09/2000 →	SK-1341	BTK	
1.8 TDCi	03/01-11/04	F9DA, F9DB, FFDA	1753	20x91	SK-1341	BTK	
2.0 16V	02/99-11/04	EDDB, EDDC, EDDD, EDDF	1988	25x129; beinhaltete Rollen: 2	SK-1340	BTK	
1.4 16V	02/99-11/04	FXDA, FXDB, FXDC, FXDD	1388		0-N294	TB [TE]	
1.6 16V	02/99-11/04	FYDA, FYDB, FYDC, FYDD, FYDH	1596		0-N294	TB [TE]	
1.8 16V, 1.8 BiFuel	02/99-01/05	EYDB, EYDC, EYDD, EYDE, EYDF, EYDG, EYDI, EYDJ, EYDL	1796		0-N290	TB [TE]	
1.8 16V, 1.8 BiFuel	02/99-01/05	EYDB, EYDC, EYDD, EYDE, EYDF, EYDG, EYDI, EYDJ, EYDL	1796	†	0-N291	TB [DG]	
1.8 DI / TDDi, 1.8 TDCi, 1.8 Turbo DI / TDDi	02/99-11/04	BHDA, BHDB, C9DA, C9DB, C9DC, F9DA, F9DB, FFDA	1753		0-N295	TB [TE]	
1.8 DI / TDDi, 1.8 Turbo DI / TDDi	02/99-11/04	BHDA, BHDB, C9DA, C9DB, C9DC	1753	09/2000 →	0-N1367	TB [TE]	
1.8 TDCi	03/01-11/04	F9DA, F9DB, FFDA	1753		0-N1367	TB [TE]	
2.0 16V	02/99-11/04	EDDB, EDDC, EDDD, EDDF	1988		0-N290	TB [TE]	
2.0 16V, ST170	02/99-11/04	ALDA, EDDB, EDDC, EDDD, EDDF	1988	†	0-N291	TB [DG]	

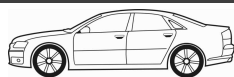

CM³



Art. Nr.



FOCUS Kombi (DNW)							
1.4 16V	02/99-11/04	FXDA, FXDB, FXDC, FXDD	1388			0-N1385	VB [DG]
1.4 16V	02/99-11/04	FXDA, FXDB, FXDC, FXDD	1388	Rippenanzahl: 6; ⚡		0-N1433	VB [BT] S
1.4 16V	02/99-11/04	FXDA, FXDB, FXDC, FXDD	1388	Rippenanzahl: 6; ⚡		0-N1434	VB [BT] S
1.6 16V	02/99-11/04	FYDA, FYDB, FYDC, FYDD, FYDH	1596	Rippenanzahl: 6; ⚡		0-N1433	VB [BT] S
1.6 16V	02/99-11/04	FYDA, FYDB, FYDC, FYDD, FYDH	1596	Rippenanzahl: 6; ⚡		0-N1434	VB [BT] S
1.6 16V, 1.6 16V Flexifuel	02/99-11/04	FYDA, FYDB, FYDC, FYDD, FYDH, FYDH	1596			0-N1385	VB [DG]
1.8 16V	02/99-11/04	EYDB, EYDC, EYDD, EYDE, EYDF, EYDG, EYDI, EYDJ, EYDL	1796	Rippenanzahl: 6		0-N1435	VB [BT] S
1.8 16V	02/99-11/04	EYDB, EYDC, EYDD, EYDE, EYDF, EYDG, EYDI, EYDJ, EYDL	1796	für Fahrzeuge mit Servolenkung		0-N1716	VB [DG]
1.8 DI / TDDi, 1.8 TDCi, 1.8 Turbo DI / TDDi	02/99-11/04	BHDA, BHDB, C9DA, C9DB, C9DC, F9DA, F9DB, FFDA	1753	†; ⚡		0-N1458	VB [DG]
1.8 DI / TDDi, 1.8 TDCi, 1.8 Turbo DI / TDDi	02/99-11/04	BHDA, BHDB, C9DA, C9DB, C9DC, F9DA, F9DB, FFDA	1753			0-N1520	VB [BT] S
1.8 DI / TDDi, 1.8 TDCi, 1.8 Turbo DI / TDDi	02/99-11/04	BHDA, BHDB, C9DA, C9DB, C9DC, F9DA, F9DB, FFDA	1753			0-N1610	VB [BT]
2.0 16V	02/99-11/04	EDDB, EDCC, EDDD, EDDF	1988	für Fahrzeuge mit Servolenkung		0-N1716	VB [DG]
2.0 16V, ST170	02/99-11/04	ALDA, EDDB, EDCC, EDDD, EDDF	1988	Rippenanzahl: 6		0-N1435	VB [BT] S
ST170	08/02-11/04	ALDA	1988			0-N1716	VB [DG]

FOCUS [USA] Turnier							
1.0 Flex	01/01-12/04		1989			0-N1258	TB [TE]
1.0 Flex	01/01-12/04		1989			0-N165	TB [DG]

FOCUS II (DA_)							
1.4	07/04-09/12	ASDA, ASDB	1388	22x117; → 04/2005; mit Zubehör		SK-1077	BTK
1.4	07/04-09/12	ASDA, ASDB	1388	22x117; → 04/2005; mit Zubehör		SK-1077AQ1	BTKW
1.4	07/04-09/12	ASDA, ASDB	1388	22x117; 04/2005 →; mit Zubehör		SK-1659	BTK
1.4	07/04-09/12	ASDA, ASDB	1388	22x117; 04/2005 →; mit Zubehör		SK-1659AQ1	BTKW
1.6 LPG	10/09-07/11	SIDA	1596	22x117; mit Zubehör		SK-1659	BTK
1.6 LPG	10/09-07/11	SIDA	1596	22x117; mit Zubehör		SK-1659AQ1	BTKW
1.6 TDCi	07/04-09/12	G8DA, G8DB, G8DD, G8DE, G8DF, G8DC, MTDA, GPDA, GPDB, GPDC, HHDA, HHDB	1560	25x137; → 12/2009		SK-1424	BTK
1.6 TDCi	07/04-09/12	G8DA, G8DB, G8DD, G8DE, G8DF, G8DC, MTDA, GPDA, GPDB, GPDC, HHDA, HHDB	1560	25x137; → 12/2009		SK-1424AQ1	BTKW
1.6, 1.6 Ti	07/04-09/12	HWDA, HWDB, SHDA, SHDB, SHDC, HXDA, HXDB, SIDA	1596	22x117; → 04/2005; mit Zubehör		SK-1077	BTK
1.6, 1.6 Ti	07/04-09/12	HWDA, HWDB, SHDA, SHDB, SHDC, HXDA, HXDB, SIDA	1596	22x117; → 04/2005; mit Zubehör		SK-1077AQ1	BTKW
1.6, 1.6 Ti	07/04-09/12	HWDA, HWDB, SHDA, SHDB, SHDC, HXDA, HXDB, SIDA	1596	22x117; 04/2005 →; mit Zubehör		SK-1659	BTK
1.6, 1.6 Ti	07/04-09/12	HWDA, HWDB, SHDA, SHDB, SHDC, HXDA, HXDB, SIDA	1596	22x117; 04/2005 →; mit Zubehör		SK-1659AQ1	BTKW
1.8 TDCi	01/05-09/12	KKDA, KKDB	1753	20x91		SK-1341	BTK
2.0 TDCi	07/04-09/12	G6DA, G6DB, G6DD, G6DE, G6DF, IXDA	1997	25.4x116		SK-1594	BTK
2.0 TDCi	07/04-09/12	G6DA, G6DB, G6DD, G6DE, G6DF, IXDA	1997	25.4x116		SK-1594AQ1	BTKW
2.5 RS, 2.5 RS 500	01/09-07/11	JZDA	2521	23x142		SK-1666	BTK
2.5 RS, 2.5 RS 500	01/09-07/11	JZDA	2521	23x142		SK-1666AQ1	BTKW
2.5 ST	10/05-09/12	HYDA	2522	23x142; → 01/2009		SK-1492	BTK
2.5 ST	10/05-09/12	HYDA	2522	23x142; → 01/2009		SK-1492AQ1	BTKW
2.5 ST	10/05-09/12	HYDA	2522	23x142; → 01/2009		SK-1666	BTK
2.5 ST	10/05-09/12	HYDA	2522	23x142; 01/2009 →		SK-1666AQ1	BTKW
1.4	07/04-09/12	ASDA, ASDB	1388	04/2005 →		0-N1564	TB [TE]
1.4	07/04-09/12	ASDA, ASDB	1388			0-N294	TB [TE]
1.6 LPG	10/09-07/11	SIDA	1596			0-N1564	TB [TE]
1.6 TDCi	07/04-09/12	G8DA, G8DB, G8DD, G8DE, G8DF, G8DC, MTDA, GPDA, GPDB, GPDC, HHDA, HHDB	1560			0-N1062	TB [TE]
1.6 TDCi	07/04-09/12	G8DA, G8DB, G8DD, G8DE, G8DF, G8DC, MTDA, GPDA, GPDB, GPDC, HHDA, HHDB	1560			0-N1066	TB [DG]
1.6, 1.6 Ti	07/04-09/12	HWDA, HWDB, SHDA, SHDB, SHDC, HXDA, HXDB, SIDA	1596	04/2005 →		0-N1564	TB [TE]
1.6, 1.6 Ti	07/04-09/12	HWDA, HWDB, SHDA, SHDB, SHDC, HXDA, HXDB, SIDA	1596			0-N294	TB [TE]
1.8 TDCi	01/05-09/12	KKDA, KKDB	1753			0-N1367	TB [TE]
1.8 TDCi	01/05-09/12	KKDA, KKDB	1753			0-N295	TB [TE]
2.0 TDCi	07/04-01/08	G6DE, G6DF	1997	→ 01/2008		0-N1334	TB [DG]
2.0 TDCi	07/04-09/12	G6DA, G6DB, G6DD, IXDA	1997			0-N1334	TB [DG]
2.5 RS, 2.5 RS 500	01/09-07/11	JZDA	2521			0-N958	TB [DG]
2.5 ST	10/05-09/12	HYDA	2522			0-N958	TB [DG]
1.6 TDCi	07/04-09/12	G8DA, G8DB, G8DD, G8DE, G8DF, G8DC, MTDA, GPDA, GPDB, GPDC, HHDA, HHDB	1560			0-N1339	VB [BT] S

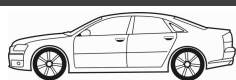

CM³



Art. Nr.



FOCUS II (DA_)							
1.6 TDCi	07/04-09/12	G8DA, G8DB, G8DD, G8DE, G8DF, G8DC, MTD, GPDA, GPDB, GPDC, HHDA, HHDB	1560			0-N1418	VB [DG]
1.8 TDCi	01/05-09/12	KKDA, KKDB	1753	→ 01/2008		0-N1622	VB [DG]
1.8 TDCi	01/05-09/12	KKDA, KKDB	1753	→ 01/2008; Rippenanzahl: 6; ✱		0-N1667	VB [DG]
1.8 TDCi	01/05-09/12	KKDA, KKDB	1753	→ 01/2008		0-N1709	VB [BT]
1.8 TDCi	01/05-09/12	KKDA, KKDB	1753	→ 01/2008		0-N1709S1	VB [TE]
1.8 TDCi	01/05-09/12	KKDA, KKDB	1753	→ 01/2008; Rippenanzahl: 6		0-N1709S2	VB [TE]
1.8, 1.8 Flexifuel	12/05-09/12	Q7DA, QQDB, QQDD	1798			0-N1639	VB [BT] S
1.8, 1.8 Flexifuel	12/05-09/12	Q7DA, QQDB, QQDD	1798	01/2008 →		0-N2353	VB [DG]
2.0	07/04-09/12	AODA, AODB, AODE	1999			0-N1639	VB [BT] S
2.0	07/04-09/12	AODA, AODB, AODE	1999	01/2008 →		0-N2353	VB [DG]
2.0 CNG, 2.0 Flex, 2.0 LPG	06/08-07/11	SYDA	1999			0-N2353	VB [DG]
2.0 TDCi	07/04-09/12	G6DA, G6DB, G6DD, G6DE, G6DF, IXDA	1997			0-N1327	VB [BT]
2.0 TDCi	07/04-09/12	G6DA, G6DB, G6DD, G6DE, G6DF, IXDA	1997			0-N2037	VB [BT] S
2.5 RS, 2.5 RS 500	01/09-07/11	JZDA	2521			0-N2109	VB [BT] S
2.5 RS, 2.5 RS 500	01/09-07/11	JZDA	2521			0-N2190	VB [BT] S
2.5 ST	10/05-09/12	HYDA	2522	→ 01/2008		0-N1554	VB [BT] S
2.5 ST	10/05-09/12	HYDA	2522	→ 01/2008		0-N2096	VB [BT] S
2.5 ST	10/05-09/12	HYDA	2522	01/2008 →		0-N2109	VB [BT] S
2.5 ST	10/05-09/12	HYDA	2522	01/2008 →		0-N2190	VB [BT] S
FOCUS II Cabriolet							
1.6	10/06-07/11	HWDA, HWDB, SHDA, SHDB, SHDC	1596	22x117; mit Zubehör		SK-1659	BTK
1.6	10/06-07/11	HWDA, HWDB, SHDA, SHDB, SHDC	1596	22x117; mit Zubehör		SK-1659AQ1	BTKW
2.0 TDCi	10/06-07/11	G6DA, G6DB, G6DD	1997	25.4x116		SK-1594	BTK
2.0 TDCi	10/06-07/11	G6DA, G6DB, G6DD	1997	25.4x116		SK-1594AQ1	BTKW
1.6	10/06-07/11	HWDA, HWDB, SHDA, SHDB, SHDC	1596			0-N1564	TB [TE]
1.6	10/06-07/11	HWDA, HWDB, SHDA, SHDB, SHDC	1596			0-N294	TB [TE]
2.0 TDCi	10/06-07/11	G6DA, G6DB, G6DD	1997			0-N1334	TB [DG]
2.0	10/06-07/11	AODA, AODB	1999	→ 01/2008		0-N1639	VB [BT] S
2.0	10/06-07/11	AODA, AODB	1999	01/2008 →		0-N2353	VB [DG]
2.0 TDCi	10/06-07/11	G6DA, G6DB, G6DD	1997			0-N1327	VB [BT]
2.0 TDCi	10/06-07/11	G6DA, G6DB, G6DD	1997			0-N2037	VB [BT] S
FOCUS II Stufenheck (DA_)							
1.4	04/05-09/12	ASDA, ASDB	1388	22x117; → 04/2005; mit Zubehör		SK-1077	BTK
1.4	04/05-09/12	ASDA, ASDB	1388	22x117; → 04/2005; mit Zubehör		SK-1077AQ1	BTKW
1.4	04/05-09/12	ASDA, ASDB	1388	22x117; mit Zubehör		SK-1659	BTK
1.4	04/05-09/12	ASDA, ASDB	1388	22x117; mit Zubehör		SK-1659AQ1	BTKW
1.6 TDCi	04/05-09/12	G8DA, G8DB, G8DD, G8DE, G8DF, G8DC, MTD, HHDA, HHDB	1560	25x137; → 12/2009		SK-1424	BTK
1.6 TDCi	04/05-09/12	G8DA, G8DB, G8DD, G8DE, G8DF, G8DC, MTD, HHDA, HHDB	1560	25x137; → 12/2009		SK-1424AQ1	BTKW
1.6, 1.6 Ti	04/05-09/12	HWDA, HWDB, SHDA, SHDB, SHDC, HXDA, HXDB, SIDA	1596	22x117; → 04/2005; mit Zubehör		SK-1077	BTK
1.6, 1.6 Ti	04/05-09/12	HWDA, HWDB, SHDA, SHDB, SHDC, HXDA, HXDB, SIDA	1596	22x117; → 04/2005; mit Zubehör		SK-1077AQ1	BTKW
1.6, 1.6 Ti	04/05-09/12	HWDA, HWDB, SHDA, SHDB, SHDC, HXDA, HXDB, SIDA	1596	22x117; mit Zubehör		SK-1659	BTK
1.6, 1.6 Ti	04/05-09/12	HWDA, HWDB, SHDA, SHDB, SHDC, HXDA, HXDB, SIDA	1596	22x117; mit Zubehör		SK-1659AQ1	BTKW
1.8 TDCi	04/05-09/12	KKDA, KKDB	1753	20x91		SK-1341	BTK
2.0 TDCi	04/05-09/12	G6DA, G6DB, G6DD, IXDA	1997	25.4x116		SK-1594	BTK
2.0 TDCi	04/05-09/12	G6DA, G6DB, G6DD, IXDA	1997	25.4x116		SK-1594AQ1	BTKW
1.4	04/05-09/12	ASDA, ASDB	1388			0-N1564	TB [TE]
1.4	04/05-09/12	ASDA, ASDB	1388			0-N294	TB [TE]
1.6 TDCi	04/05-09/12	G8DA, G8DB, G8DD, G8DE, G8DF, G8DC, MTD, HHDA, HHDB	1560			0-N1062	TB [TE]
1.6 TDCi	04/05-09/12	G8DA, G8DB, G8DD, G8DE, G8DF, HHDA, HHDB	1560			0-N1066	TB [DG]
1.6, 1.6 Ti	04/05-09/12	HWDA, HWDB, SHDA, SHDB, SHDC, HXDA, HXDB, SIDA	1596			0-N1564	TB [TE]
1.6, 1.6 Ti	04/05-09/12	HWDA, HWDB, SHDA, SHDB, SHDC, HXDA, HXDB, SIDA	1596			0-N294	TB [TE]
1.8 TDCi	04/05-09/12	KKDA, KKDB	1753			0-N1367	TB [TE]
1.8 TDCi	04/05-09/12	KKDA, KKDB	1753			0-N295	TB [TE]
2.0 TDCi	04/05-09/12	G6DA, G6DB, G6DD, IXDA	1997			0-N1334	TB [DG]
1.6 TDCi	04/05-09/12	G8DA, G8DB, G8DD, G8DE, G8DF, G8DC, MTD, HHDA, HHDB	1560			0-N1339	VB [BT] S



OPTIMAL®

FORD



CM³



Art. Nr.



FOCUS II Stufenheck (DA_)

1.6 TDCi	04/05-09/12	G8DA, G8DB, G8DD, G8DE, G8DF, G8DC, MTDA, HHDA, HHDB	1560		0-N1418	VB [DG]	
1.8 TDCi	04/05-09/12	KKDA, KKDB	1753	→ 01/2008	0-N1622	VB [DG]	
1.8 TDCi	04/05-09/12	KKDA, KKDB	1753	→ 01/2008; Rippenanzahl: 6;	0-N1667	VB [DG]	
1.8 TDCi	04/05-09/12	KKDA, KKDB	1753	→ 01/2008	0-N1709	VB [BT]	
1.8 TDCi	04/05-09/12	KKDA, KKDB	1753	→ 01/2008	0-N1709S1	VB [TE]	
1.8 TDCi	04/05-09/12	KKDA, KKDB	1753	→ 01/2008; Rippenanzahl: 6	0-N1709S2	VB [TE]	
1.8, 1.8 Flexifuel	12/05-09/12	Q7DA, QQDB	1798		0-N1639	VB [BT]	S
1.8, 1.8 Flexifuel	12/05-09/12	Q7DA, QQDB	1798	01/2008 →	0-N2353	VB [DG]	
2.0	04/05-07/11	AODA, AODB	1999		0-N1639	VB [BT]	S
2.0	04/05-07/11	AODA, AODB	1999	01/2008 →	0-N2353	VB [DG]	
2.0	02/08-		1999		0-N2353	VB [DG]	
2.0 TDCi	04/05-09/12	G6DA, G6DB, G6DD, IXDA	1997		0-N1327	VB [BT]	
2.0 TDCi	04/05-09/12	G6DA, G6DB, G6DD, IXDA	1997		0-N2037	VB [BT]	S

FOCUS II Kombi (DA_)

1.4	07/04-09/12	ASDA, ASDB	1388	22x117; → 04/2005; mit Zubehör	SK-1077	BTK	
1.4	07/04-09/12	ASDA, ASDB	1388	22x117; → 04/2005; mit Zubehör	SK-1077AQ1	BTKW	
1.4	07/04-09/12	ASDA, ASDB	1388	22x117; 04/2005 →; mit Zubehör	SK-1659	BTK	
1.4	07/04-09/12	ASDA, ASDB	1388	22x117; 04/2005 →; mit Zubehör	SK-1659AQ1	BTKW	
1.6 LPG	10/09-09/12	SIDA	1596	22x117; mit Zubehör	SK-1659	BTK	
1.6 LPG	10/09-09/12	SIDA	1596	22x117; mit Zubehör	SK-1659AQ1	BTKW	
1.6 TDCi	07/04-09/12	G8DA, G8DB, G8DD, G8DE, G8DF, G8DC, MTDA, GPDA, GPDC, HHDA, HHDB	1560	25x137; → 12/2009	SK-1424	BTK	
1.6 TDCi	07/04-09/12	G8DA, G8DB, G8DD, G8DE, G8DF, G8DC, MTDA, GPDA, GPDC, HHDA, HHDB	1560	25x137; → 12/2009	SK-1424AQ1	BTKW	
1.6, 1.6 Ti	07/04-09/12	HWDA, HWDB, SHDA, SHDB, SHDC, HXDA, HXDB, SIDA	1596	22x117; → 04/2005; mit Zubehör	SK-1077	BTK	
1.6, 1.6 Ti	07/04-09/12	HWDA, HWDB, SHDA, SHDB, SHDC, HXDA, HXDB, SIDA	1596	22x117; → 04/2005; mit Zubehör	SK-1077AQ1	BTKW	
1.6, 1.6 Ti	07/04-09/12	HWDA, HWDB, SHDA, SHDB, SHDC, HXDA, HXDB, SIDA	1596	22x117; 04/2005 →; mit Zubehör	SK-1659	BTK	
1.6, 1.6 Ti	07/04-09/12	HWDA, HWDB, SHDA, SHDB, SHDC, HXDA, HXDB, SIDA	1596	22x117; 04/2005 →; mit Zubehör	SK-1659AQ1	BTKW	
1.8 TDCi	07/04-09/12	KKDA, KKDB	1753	20x91	SK-1341	BTK	
2.0 TDCi	07/04-09/12	G6DA, G6DB, G6DD, G6DE, G6DF, IXDA	1997	25.4x116	SK-1594	BTK	
2.0 TDCi	07/04-09/12	G6DA, G6DB, G6DD, G6DE, G6DF, IXDA	1997	25.4x116	SK-1594AQ1	BTKW	
1.4	07/04-09/12	ASDA, ASDB	1388	04/2005 →	0-N1564	TB [TE]	
1.4	07/04-09/12	ASDA, ASDB	1388		0-N294	TB [TE]	
1.6 LPG	10/09-09/12	SIDA	1596		0-N1564	TB [TE]	
1.6 TDCi	07/04-09/12	G8DA, G8DB, G8DD, G8DE, G8DF, G8DC, MTDA, GPDA, GPDC, HHDA, HHDB	1560		0-N1062	TB [TE]	
1.6 TDCi	07/04-09/12	G8DA, G8DB, G8DD, G8DE, G8DF, G8DC, MTDA, GPDA, GPDC, HHDA, HHDB	1560		0-N1066	TB [DG]	
1.6, 1.6 Ti	07/04-09/12	HWDA, HWDB, SHDA, SHDB, SHDC, HXDA, HXDB, SIDA	1596	04/2005 →	0-N1564	TB [TE]	
1.6, 1.6 Ti	07/04-09/12	HWDA, HWDB, SHDA, SHDB, SHDC, HXDA, HXDB, SIDA	1596		0-N294	TB [TE]	
1.8 TDCi	07/04-09/12	KKDA, KKDB	1753		0-N1367	TB [TE]	
1.8 TDCi	07/04-09/12	KKDA, KKDB	1753		0-N295	TB [TE]	
2.0 TDCi	07/04-01/08	G6DE, G6DF	1997	→ 01/2008	0-N1334	TB [DG]	
2.0 TDCi	07/04-09/12	G6DA, G6DB, G6DD, IXDA	1997		0-N1334	TB [DG]	
1.6 TDCi	07/04-09/12	G8DA, G8DB, G8DD, G8DE, G8DF, G8DC, MTDA, GPDA, GPDC, HHDA, HHDB	1560		0-N1339	VB [BT]	S
1.6 TDCi	07/04-09/12	G8DA, G8DB, G8DD, G8DE, G8DF, G8DC, MTDA, GPDA, GPDC, HHDA, HHDB	1560		0-N1418	VB [DG]	
1.6 TDCi	12/07-09/12	G8DA	1560		0-N1418	VB [DG]	
1.8 TDCi	07/04-09/12	KKDA, KKDB	1753	→ 01/2008	0-N1622	VB [DG]	
1.8 TDCi	07/04-09/12	KKDA, KKDB	1753	→ 01/2008; Rippenanzahl: 6;	0-N1667	VB [DG]	
1.8 TDCi	07/04-09/12	KKDA, KKDB	1753	→ 01/2008	0-N1709	VB [BT]	
1.8 TDCi	07/04-09/12	KKDA, KKDB	1753	→ 01/2008	0-N1709S1	VB [TE]	
1.8 TDCi	07/04-09/12	KKDA, KKDB	1753	→ 01/2008; Rippenanzahl: 6	0-N1709S2	VB [TE]	
1.8, 1.8 Flexifuel	12/05-09/12	Q7DA, Q7DA, QQDB	1798		0-N1639	VB [BT]	S
1.8, 1.8 Flexifuel	12/05-09/12	Q7DA, Q7DA, QQDB	1798	01/2008 →	0-N2353	VB [DG]	
2.0	07/04-09/12	AODA, AODB, AODE	1999	→ 01/2008	0-N1639	VB [BT]	S
2.0	07/04-09/12	AODA, AODB, AODE	1999	01/2008 →	0-N2353	VB [DG]	
2.0 LPG	06/08-07/11	SYDA	1999		0-N1639	VB [BT]	S
2.0 LPG	06/08-07/11	SYDA	1999		0-N2353	VB [DG]	
2.0 TDCi	07/04-09/12	G6DA, G6DB, G6DD, G6DE, G6DF, IXDA	1997		0-N1327	VB [BT]	

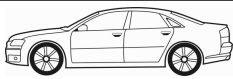

CM³



Art. Nr.



FOCUS II Kombi (DA_)

2.0 TDCi	07/04-09/12	G6DA, G6DB, G6DD, G6DE, G6DF, IXDA	1997		0-N2037	VB [BT]	S
----------	-------------	------------------------------------	------	--	---------	---------	---

FOCUS III

1.6 Flexifuel, 1.6 LPG, 1.6 Ti	07/10-	IQDB, MUDA, PNDA, XTDA	1596	22x117; mit Zubehör	SK-1659AQ1	BTKW	
1.6 TDCi, 1.6 TDCi ECOnetic	07/10-	NGDA, NGDB, T1DA, T1DB, T3DA, T3DB	1560	25x141	SK-1728	BTK	
1.6 TDCi, 1.6 TDCi ECOnetic	07/10-	NGDA, NGDB, T1DA, T1DB, T3DA, T3DB	1560	25x141	SK-1728AQ1	BTKW	
1.6 Ti	07/10-	IQDB, PNDA, XTDA	1596	22x117; mit Zubehör	SK-1659	BTK	
2.0 TDCi	07/10-	TXDB, TYDA, UFDB, UKDB	1997	25x116	SK-1714	BTK	
2.0 TDCi	07/10-	TXDB, TYDA, UFDB, UKDB	1997	25x116	SK-1714AQ1	BTKW	
1.5 EcoBoost	09/14-	M8DA, M8DB, M9DA, M9DB	1498		0-N2057	TB [TE]	
1.5 TDCi, 1.5 TDCi ECOnetic	09/14-	XWDA, XWDB, XWDC, XWDD, XXDA, XXDC, XXDB	1499		0-N2382	TB [DG]	
1.6 EcoBoost, 1.6 Flexifuel	07/10-	JQDA, JQDB, YUDA, JTDA, JTDB, YUDA	1596		0-N2057	TB [TE]	
1.6 Flexifuel, 1.6 LPG, 1.6 Ti	07/10-	IQDB, MUDA, PNDA, XTDA	1596	→ 10/2012	0-N1564	TB [TE]	
1.6 TDCi, 1.6 TDCi ECOnetic	07/10-	NGDA, NGDB, T1DA, T1DB, T3DA, T3DB	1560		0-N2224	TB [TE]	
1.6 TDCi, 1.6 TDCi ECOnetic	07/10-	NGDA, NGDB, T1DA, T1DB, T3DA, T3DB	1560		0-N2382	TB [DG]	
2.0 TDCi	07/10-	TXDB, TYDA, UFDB, UKDB	1997		0-N1334	TB [DG]	
2.0 TDCi	07/10-	TXDB, TYDA, UFDB, UKDB	1997		0-N2063	TB [TE]	
1.0 EcoBoost	02/12-	M1DA, M2DA	998		0-N2300	VB [BT]	S
1.0 EcoBoost	02/12-	M1DA, M2DA	998		0-N2303	VB [DG]	
1.0 EcoBoost	02/12-	M1DA, M2DA	998	✱	0-N2353	VB [DG]	
1.5 EcoBoost	09/14-	M8DA, M8DB, M9DA, M9DB	1498		0-N2363	VB [DG]	
1.5 TDCi, 1.5 TDCi ECOnetic	09/14-	XWDA, XWDB, XWDC, XWDD, XXDA, XXDC, XXDB	1499	✱	0-N1418	VB [DG]	
1.6 EcoBoost	07/10-	JQDA, JQDB, YUDA, JTDA, JTDB	1596		0-N2269	VB [BT]	S
1.6 EcoBoost, 1.6 Flexifuel	07/10-	JQDA, JQDB, YUDA, JTDA, JTDB, YUDA	1596		0-N2363	VB [DG]	
1.6 Flexifuel, 1.6 LPG, 1.6 Ti	07/10-	IQDB, MUDA, PNDA, XTDA	1596	✱	0-N2353	VB [DG]	
1.6 TDCi, 1.6 TDCi ECOnetic	07/10-	NGDA, NGDB, T1DA, T1DB, T3DA, T3DB	1560		0-N1339	VB [BT]	S
1.6 TDCi, 1.6 TDCi ECOnetic	07/10-	NGDA, NGDB, T1DA, T1DB, T3DA, T3DB	1560		0-N1418	VB [DG]	
2.0 TDCi	07/10-	TXDB, TYDA, UFDB, UKDB	1997		0-N2396	VB [BT]	S

FOCUS III Stufenheck

1.6 Flexifuel, 1.6 Ti	07/10-	IQDB, MUDA, PNDA, XTDA	1596	22x117; mit Zubehör	SK-1659AQ1	BTKW	
1.6 TDCi	07/10-	T1DA, T1DB, T3DA, T3DB	1560	25x141	SK-1728	BTK	
1.6 TDCi	07/10-	T1DA, T1DB, T3DA, T3DB	1560	25x141	SK-1728AQ1	BTKW	
1.6 Ti	07/10-	IQDB, PNDA, XTDA	1596	22x117; mit Zubehör	SK-1659	BTK	
2.0 TDCi	07/10-	TXDB, TYDA, UFDB, UKDB	1997	25x116	SK-1714	BTK	
2.0 TDCi	07/10-	TXDB, TYDA, UFDB, UKDB	1997	25x116	SK-1714AQ1	BTKW	
1.5 EcoBoost	11/14-	M8DA, M8DB, M9DA, M9DB	1498		0-N2057	TB [TE]	
1.5 TDCi, 1.5 TDCi ECOnetic	11/14-	XWDA, XWDB, XWDC, XWDD, XXDA, XXDC, XXDB	1499		0-N2382	TB [DG]	
1.6 EcoBoost, 1.6 Flexifuel	07/10-	JQDA, JQDB, YUDA, JTDA, JTDB, YUDA	1596		0-N2057	TB [TE]	
1.6 Flexifuel, 1.6 Ti	07/10-	IQDB, MUDA, PNDA, XTDA	1596	→ 10/2012	0-N1564	TB [TE]	
1.6 TDCi	07/10-	T1DA, T1DB, T3DA, T3DB	1560		0-N2224	TB [TE]	
1.6 TDCi	07/10-	T1DA, T1DB, T3DA, T3DB	1560		0-N2382	TB [DG]	
2.0 TDCi	07/10-	TXDB, TYDA, UFDB, UKDB	1997		0-N1334	TB [DG]	
2.0 TDCi	07/10-	TXDB, TYDA, UFDB, UKDB	1997		0-N2063	TB [TE]	
1.0 EcoBoost	02/12-	M1DA, M2DA	998		0-N2300	VB [BT]	S
1.0 EcoBoost	02/12-	M1DA, M2DA	998		0-N2303	VB [DG]	
1.0 EcoBoost	02/12-	M1DA, M2DA	998	✱	0-N2353	VB [DG]	
1.5 EcoBoost	11/14-	M8DA, M8DB, M9DA, M9DB	1498		0-N2363	VB [DG]	
1.5 TDCi, 1.5 TDCi ECOnetic	11/14-	XWDA, XWDB, XWDC, XWDD, XXDA, XXDC, XXDB	1499	✱	0-N1418	VB [DG]	
1.6 EcoBoost	07/10-	JQDA, JQDB, YUDA, JTDA, JTDB	1596		0-N2269	VB [BT]	S
1.6 EcoBoost, 1.6 Flexifuel	07/10-	JQDA, JQDB, YUDA, JTDA, JTDB, YUDA	1596		0-N2363	VB [DG]	
1.6 Flexifuel, 1.6 Ti	07/10-	IQDB, MUDA, PNDA, XTDA	1596	✱	0-N2353	VB [DG]	
1.6 TDCi	07/10-	T1DA, T1DB, T3DA, T3DB	1560		0-N1339	VB [BT]	S
1.6 TDCi	07/10-	T1DA, T1DB, T3DA, T3DB	1560		0-N1418	VB [DG]	
2.0 TDCi	07/10-	TXDB, TYDA, UFDB, UKDB	1997		0-N2396	VB [BT]	S

FOCUS III Turnier

1.6 Flexifuel, 1.6 LPG, 1.6 Ti	07/10-	IQDB, MUDA, PNDA, XTDA	1596	22x117; mit Zubehör	SK-1659AQ1	BTKW	
1.6 TDCi, 1.6 TDCi ECOnetic	07/10-	NGDA, NGDB, T1DA, T1DB, T3DA, T3DB	1560	25x141	SK-1728	BTK	
1.6 TDCi, 1.6 TDCi ECOnetic	07/10-	NGDA, NGDB, T1DA, T1DB, T3DA, T3DB	1560	25x141	SK-1728AQ1	BTKW	
1.6 Ti	07/10-	IQDB, PNDA, XTDA	1596	22x117; mit Zubehör	SK-1659	BTK	
2.0 TDCi	07/10-	TXDB, TYDA, UFDB, UKDB	1997	25x116	SK-1714	BTK	
2.0 TDCi	07/10-	TXDB, TYDA, UFDB, UKDB	1997	25x116	SK-1714AQ1	BTKW	
1.5 EcoBoost	09/14-	M8DA, M8DB, M9DA, M9DB	1498		0-N2057	TB [TE]	

CM³

Art. Nr.



FOCUS III Turnier

1.5 TDCi, 1.5 TDCi ECOnetic	09/14-	XWDA, XWDB, XWDC, XWDD, XXDA, XXDC, XXDB	1499			0-N2382	TB [DG]	
1.6 EcoBoost, 1.6 Flexifuel	07/10-	JQDA, JQDB, YUDA, JTDA, JTDB, YUDA	1596			0-N2057	TB [TE]	
1.6 Flexifuel, 1.6 LPG, 1.6 Ti	07/10-	IQDB, MUDA, PNDA, XTDA	1596	→ 10/2012		0-N1564	TB [TE]	
1.6 TDCi, 1.6 TDCi ECOnetic	07/10-	NGDA, NGDB, T1DA, T1DB, T3DA, T3DB	1560			0-N2224	TB [TE]	
1.6 TDCi, 1.6 TDCi ECOnetic	07/10-	NGDA, NGDB, T1DA, T1DB, T3DA, T3DB	1560			0-N2382	TB [DG]	
2.0 TDCi	07/10-	TXDB, TYDA, UFDB, UKDB	1997			0-N1334	TB [DG]	
2.0 TDCi	07/10-	TXDB, TYDA, UFDB, UKDB	1997			0-N2063	TB [TE]	
1.0 EcoBoost	02/12-	M1DA, M2DA	998			0-N2300	VB [BT]	S
1.0 EcoBoost	02/12-	M1DA, M2DA	998			0-N2303	VB [DG]	
1.0 EcoBoost	02/12-	M1DA, M2DA	998	✳		0-N2353	VB [DG]	
1.5 EcoBoost	09/14-	M8DA, M8DB, M9DA, M9DB	1498			0-N2363	VB [DG]	
1.5 TDCi, 1.5 TDCi ECOnetic	09/14-	XWDA, XWDB, XWDC, XWDD, XXDA, XXDC, XXDB	1499	✳		0-N1418	VB [DG]	
1.6 EcoBoost	07/10-	JQDA, JQDB, YUDA, JTDA, JTDB	1596			0-N2269	VB [BT]	S
1.6 EcoBoost, 1.6 Flexifuel	07/10-	JQDA, JQDB, YUDA, JTDA, JTDB, YUDA	1596			0-N2363	VB [DG]	
1.6 Flexifuel, 1.6 LPG, 1.6 Ti	07/10-	IQDB, MUDA, PNDA, XTDA	1596	✳		0-N2353	VB [DG]	
1.6 TDCi	07/10-	T1DA, T1DB	1560	✳		0-N1339	VB [BT]	S
1.6 TDCi, 1.6 TDCi ECOnetic	07/10-	NGDA, NGDB, T3DA, T3DB	1560			0-N1339	VB [BT]	S
1.6 TDCi, 1.6 TDCi ECOnetic	07/10-	NGDA, NGDB, T1DA, T1DB, T3DA, T3DB	1560			0-N1418	VB [DG]	
2.0 TDCi	07/10-	TXDB, TYDA, UFDB, UKDB	1997			0-N2396	VB [BT]	S

FOCUS III Van

1.5 TDCi, 1.5 TDCi ECOnetic	09/14-	XWDA, XWDB, XWDC, XWDD, XXDA, XXDC, XXDB	1499			0-N2382	TB [DG]	
-----------------------------	--------	--	------	--	--	---------	---------	--

FOCUS C-MAX

1.6 TDCi	10/03-03/07	G8DA, G8DB, HHDA, HHDB	1560	25x137		SK-1424	BTK	
1.6 TDCi	10/03-03/07	G8DA, G8DB, HHDA, HHDB	1560	25x137		SK-1424AQ1	BTKW	
1.6, 1.6 Ti	10/03-03/07	HWDA, HWDB, HXDA, SIDA	1596	22x117; → 04/2005; mit Zubehör		SK-1077	BTK	
1.6, 1.6 Ti	10/03-03/07	HWDA, HWDB, HXDA, SIDA	1596	22x117; → 04/2005; mit Zubehör		SK-1077AQ1	BTKW	
1.6, 1.6 Ti	10/03-03/07	HWDA, HWDB, HXDA, SIDA	1596	22x117; 04/2005 →; mit Zubehör		SK-1659	BTK	
1.6, 1.6 Ti	10/03-03/07	HWDA, HWDB, HXDA, SIDA	1596	22x117; 04/2005 →; mit Zubehör		SK-1659AQ1	BTKW	
1.8 TDCi	01/05-03/07	KKDA	1753	20x91		SK-1341	BTK	
2.0 TDCi	10/03-03/07	G6DA, G6DB	1997	25.4x116		SK-1594	BTK	
2.0 TDCi	10/03-03/07	G6DC, G6DE, G6DF	1997	25.4x116		SK-1594	BTK	
2.0 TDCi	10/03-03/07	G6DA, G6DB, G6DD, G6DG, G6DC, G6DE, G6DF	1997	25.4x116		SK-1594AQ1	BTKW	
1.6 TDCi	10/03-03/07	G8DA, G8DB, HHDA, HHDB	1560			0-N1062	TB [TE]	
1.6 TDCi	10/03-03/07	G8DA, G8DB, HHDA, HHDB	1560			0-N1066	TB [DG]	
1.6, 1.6 Ti	10/03-03/07	HWDA, HWDB, HXDA, SIDA	1596	04/2005 →		0-N1564	TB [TE]	
1.6, 1.6 Ti	10/03-03/07	HWDA, HWDB, HXDA, SIDA	1596			0-N294	TB [TE]	
1.8 TDCi	01/05-03/07	KKDA	1753			0-N1367	TB [TE]	
1.8 TDCi	01/05-03/07	KKDA	1753			0-N295	TB [TE]	
2.0 TDCi	10/03-03/07	G6DA, G6DB, G6DD, G6DG, G6DC, G6DE, G6DF	1997			0-N1334	TB [DG]	
1.6 TDCi	10/03-03/07	G8DA, G8DB, HHDA, HHDB	1560			0-N1339	VB [BT]	S
1.6 TDCi	10/03-03/07	G8DA, G8DB, HHDA, HHDB	1560			0-N1418	VB [DG]	
1.8 TDCi	01/05-03/07	KKDA	1753			0-N1622	VB [DG]	
1.8 TDCi	01/05-03/07	KKDA	1753	Rippenanzahl: 6; ✳		0-N1667	VB [DG]	
1.8 TDCi	01/05-03/07	KKDA	1753			0-N1709	VB [BT]	
1.8 TDCi	01/05-03/07	KKDA	1753			0-N1709S1	VB [TE]	
1.8 TDCi	01/05-03/07	KKDA	1753	Rippenanzahl: 6		0-N1709S2	VB [TE]	
1.8, 1.8 Flexifuel	10/03-03/07	CSDA, CSDB, Q7DA, Q7DA, QQDA, QQDB	1798			0-N1639	VB [BT]	S
2.0	03/04-03/07	AODA, AODB, SYDA	1999			0-N1639	VB [BT]	S
2.0 TDCi	10/03-03/07	G6DA, G6DB, G6DD, G6DG	1997			0-N1327	VB [BT]	
2.0 TDCi	10/03-03/07	G6DA, G6DB, G6DD, G6DG	1997			0-N2037	VB [BT]	S

FUSION (JU_)

1.25	08/04-12/12	FUJA, FUJB	1242	22x117; → 04/2005; mit Zubehör		SK-1077	BTK	
1.25	08/04-12/12	FUJA, FUJB	1242	22x117; → 04/2005; mit Zubehör		SK-1077AQ1	BTKW	
1.25	08/04-12/12	FUJA, FUJB	1242	22x117; 04/2005 →; mit Zubehör		SK-1659	BTK	
1.25	08/04-12/12	FUJA, FUJB	1242	22x117; 04/2005 →; mit Zubehör		SK-1659AQ1	BTKW	
1.4	08/02-12/12	FXJA, FXJB, FXJC	1388	22x117; → 04/2005; mit Zubehör		SK-1077	BTK	
1.4	08/02-12/12	FXJA, FXJB, FXJC	1388	22x117; → 04/2005; mit Zubehör		SK-1077AQ1	BTKW	
1.4	08/02-12/12	FXJA, FXJB, FXJC	1388	22x117; 04/2005 →; mit Zubehör		SK-1659	BTK	
1.4	08/02-12/12	FXJA, FXJB, FXJC	1388	22x117; 04/2005 →; mit Zubehör		SK-1659AQ1	BTKW	
1.4 LPG	01/10-12/12	UTJA	1388	22x117; mit Zubehör		SK-1659	BTK	

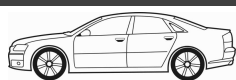

CM³



Art. Nr.



ohne Halter

FUSION (JU_)							
1.4 LPG	01/10-12/12	UTJA	1388	22x117; mit Zubehör	SK-1659AQ1	BTKW	
1.4 TDCi	08/02-07/05	F6JA, F6JB	1399	25.4x144; 11/2002 → 04/2008	SK-1391	BTK	
1.4 TDCi	08/02-07/05	F6JA, F6JB	1399	25.4x144; 11/2002 → 04/2008	SK-1391AQ1	BTKW	
1.6	08/02-11/08	FYJA, FYJB, FYJC	1596	22x117; → 04/2005; mit Zubehör	SK-1077	BTK	
1.6	08/02-11/08	FYJA, FYJB, FYJC	1596	22x117; → 04/2005; mit Zubehör	SK-1077AQ1	BTKW	
1.6	08/02-11/08	FYJA, FYJB, FYJC	1596	22x117; 04/2005 →; mit Zubehör	SK-1659	BTK	
1.6	08/02-11/08	FYJA, FYJB, FYJC	1596	22x117; 04/2005 →; mit Zubehör	SK-1659AQ1	BTKW	
1.6 TDCi	11/04-12/12	HHJA, HHJB	1560	25x137	SK-1424	BTK	
1.6 TDCi	11/04-12/12	HHJA, HHJB	1560	25x137	SK-1424AQ1	BTKW	
1.25	08/04-12/12	FUJA, FUJB	1242	04/2005 →	0-N1564	TB [TE]	
1.25	08/04-12/12	FUJA, FUJB	1242		0-N294	TB [TE]	
1.4	08/02-12/12	FXJA, FXJB, FXJC	1388	04/2005 →	0-N1564	TB [TE]	
1.4	08/02-12/12	FXJA, FXJB, FXJC	1388		0-N294	TB [TE]	
1.4 LPG	01/10-12/12	UTJA	1388		0-N1564	TB [TE]	
1.4 TDCi	08/02-07/05	F6JA, F6JB	1399		0-N1062	TB [TE]	
1.4 TDCi	08/02-07/05	F6JA, F6JB	1399		0-N1066	TB [DG]	
1.6	08/02-11/08	FYJA, FYJB, FYJC	1596	04/2005 →	0-N1564	TB [TE]	
1.6	08/02-11/08	FYJA, FYJB, FYJC	1596		0-N294	TB [TE]	
1.6 TDCi	11/04-12/12	HHJA, HHJB	1560		0-N1062	TB [TE]	
1.6 TDCi	11/04-12/12	HHJA, HHJB	1560		0-N1066	TB [DG]	
1.4 TDCi	08/02-07/05	F6JA, F6JB	1399		0-N1418	VB [DG]	
1.4 TDCi	08/02-07/05	F6JA, F6JB	1399	✳	0-N1420	VB [DG]	
1.4 TDCi	08/02-07/05	F6JA, F6JB	1399		0-N1636	VB [BT]	S
1.6 TDCi	11/04-12/12	HHJA, HHJB	1560		0-N1339	VB [BT]	S
1.6 TDCi	11/04-12/12	HHJA, HHJB	1560		0-N1418	VB [DG]	
GALAXY (WGR)							
1.9 TDI	03/95-05/06	ANU	1896	30x120; 01/2003 →; mit Zubehör	SK-1372	BTK	
1.9 TDI	03/95-05/06	ANU	1896	30x120; 05/2002 →; Baumuster: Galaxy	SK-1372AQ2	BTKW	
1.9 TDI	03/95-05/06	ANU	1896	30x120; 05/2002 →; Baumuster: Galaxy Van	SK-1372AQ2	BTKW	
1.9 TDI	03/95-05/06	ANU	1896	30x120; 09/1999 → 03/2000; Länderausführung Deutschland; mit Spanndämpfer, Spannrolle; mit Zubehör; Baumuster: Galaxy	SK-1378	BTK	
1.9 TDI	03/95-05/06	ANU	1896	30x120; 09/1999 → 03/2000; Länderausführung Deutschland; mit Spanndämpfer, Spannrolle; mit Zubehör; Baumuster: Galaxy Van	SK-1378	BTK	
1.9 TDI	03/95-05/06	1Z, AHU	1896	30x120; 09/1999 → 03/2000; Länderausführung Deutschland; ohne Spanndämpfer, Spannrolle; mit Zubehör	SK-1388	BTK	
1.9 TDI	03/95-05/06	1Z, AHU, ANU	1896	25.4x137; → 03/2000; mit Zubehör	SK-1425	BTK	
1.9 TDI	03/95-05/06	1Z, AHU	1896	30x120; 04/2000 → 04/2002; mit Zubehör	SK-1582	BTK	
1.9 TDI	03/95-05/06	ANU	1896	30x120; 04/2000 → 04/2002; ohne Spanndämpfer, Spannrolle; mit Zubehör; Baumuster: Galaxy	SK-1582AQ1	BTKW	
1.9 TDI	03/95-05/06	ANU	1896	30x120; 04/2000 → 04/2002; ohne Spanndämpfer, Spannrolle; mit Zubehör; Baumuster: Galaxy Van	SK-1582AQ1	BTKW	
1.9 TDI	03/95-05/06	1Z, AHU	1896	30x120; 04/2000 → 04/2002; mit Spanndämpfer, Spannrolle; mit Zubehör	SK-1583	BTK	
1.9 TDI	03/95-05/06	ANU	1896	30x120; 04/2000 → 04/2002; mit Spanndämpfer, Spannrolle; mit Zubehör; Baumuster: Galaxy	SK-1583AQ1	BTKW	
1.9 TDI	03/95-05/06	ANU	1896	30x120; 04/2000 → 04/2002; mit Spanndämpfer, Spannrolle; mit Zubehör; Baumuster: Galaxy Van	SK-1583AQ1	BTKW	
1.9 TDI	08/97-04/00	AFN, AVG	1896	25.4x137; mit Zubehör	SK-1425	BTK	
1.9 TDI	04/00-05/06	AUY	1896	30x120; 04/2002 →; mit Zubehör	SK-1372	BTK	
1.9 TDI	04/00-05/06	AUY	1896	30x120; 05/2002 →; Baumuster: Galaxy	SK-1372AQ2	BTKW	
1.9 TDI	04/00-05/06	AUY	1896	30x120; 05/2002 →; Baumuster: Galaxy Van	SK-1372AQ2	BTKW	
1.9 TDI	04/00-05/06	AUY	1896	30x120; → 04/2002; mit Zubehör	SK-1582	BTK	
1.9 TDI	04/00-05/06	AUY	1896	30x120; → 04/2002; ohne Spanndämpfer, Spannrolle; mit Zubehör; Baumuster: Galaxy	SK-1582AQ1	BTKW	
1.9 TDI	04/00-05/06	AUY	1896	30x120; → 04/2002; ohne Spanndämpfer, Spannrolle; mit Zubehör; Baumuster: Galaxy Van	SK-1582AQ1	BTKW	
1.9 TDI	04/00-05/06	AUY	1896	30x120; → 04/2002; mit Spanndämpfer, Spannrolle; mit Zubehör	SK-1583	BTK	
1.9 TDI	04/00-05/06	AUY	1896	30x120; → 04/2002; mit Spanndämpfer, Spannrolle; mit Zubehör; Baumuster: Galaxy	SK-1583AQ1	BTKW	



CM³



Art. Nr.



GALAXY (WGR)

1.9 TDI	04/00-05/06	AUY	1896	30x120; → 04/2002; mit Spanndämpfer, Spannrolle; mit Zubehör; Baumuster: Galaxy Van	SK-1583AQ1	BTKW	
1.9 TDI	02/03-05/06	ASZ, BTB	1896	30x120; mit Zubehör	SK-1372	BTK	
1.9 TDI	02/03-05/06	ASZ, BTB	1896	30x120	SK-1372AQ1	BTKW	
1.9 TDI	03/95-05/06	1Z, AHU	1896		0-N104	TB [TE]	
1.9 TDI	03/95-05/06	ANU	1896	04/2002 →	0-N1045	TB [TE]	
1.9 TDI	03/95-05/06	ANU	1896	04/2002 →	0-N1046	TB [DG]	
1.9 TDI	03/95-05/06	ANU	1896	04/2000 → 03/2002	0-N1048	TB [TE]	
1.9 TDI	03/95-05/06	ANU	1896	→ 03/2000	0-N1049	TB [BT]	
1.9 TDI	03/95-05/06	ANU	1896	→ 03/2000; mit Anbaumaterial	0-N1265	TB [TE]	
1.9 TDI	03/95-05/06	ANU	1896	→ 03/2002	0-N1268	TB [DG]	
1.9 TDI	03/95-05/06	ANU	1896	04/2000 →	0-N1274	TB [BT]	
1.9 TDI	03/95-05/06	1Z, AHU	1896		0-N128	TB [DG]	
1.9 TDI	08/97-04/00	AFN, AVG	1896		0-N104	TB [TE]	
1.9 TDI	08/97-04/00	AFN, AVG	1896		0-N128	TB [DG]	
1.9 TDI	04/00-05/06	AUY	1896	04/2002 →	0-N1045	TB [TE]	
1.9 TDI	04/00-05/06	AUY	1896	04/2002 →	0-N1046	TB [DG]	
1.9 TDI	04/00-05/06	AUY	1896	→ 03/2002	0-N1048	TB [TE]	
1.9 TDI	04/00-05/06	AUY	1896	→ 03/2002	0-N1268	TB [DG]	
1.9 TDI	04/00-05/06	AUY	1896	→ 03/2002	0-N1274	TB [BT]	
1.9 TDI	02/03-05/06	ASZ, BTB	1896		0-N1045	TB [TE]	
1.9 TDI	02/03-05/06	ASZ, BTB	1896		0-N1046	TB [DG]	
1.9 TDI	03/95-05/06	1Z, AHU	1896		0-N1417	VB [TE]	
1.9 TDI	03/95-05/06	ANU	1896		0-N1494	VB [BT]	S
1.9 TDI	03/95-05/06	1Z, AHU	1896		0-N1609	VB [BT]	
1.9 TDI	08/97-04/00	AFN, AVG	1896		0-N1417	VB [TE]	
1.9 TDI	08/97-04/00	AFN, AVG	1896		0-N1609	VB [BT]	
1.9 TDI	04/00-05/06	ASZ, AUY, BTB	1896		0-N1494	VB [BT]	S
2.0 i	11/95-05/06	NSE, ZVSA	1998		0-N1385	VB [DG]	
2.0 i	11/95-05/06	NSE, ZVSA	1998		0-N1653S	VB [TE]	
2.3 16V	01/97-05/06	E5SA, Y5B, E5SB	2295		0-N1385	VB [DG]	
2.3 16V	01/97-05/06	E5SA, Y5B, E5SB	2295		0-N1653S	VB [TE]	
2.8 i V6, 2.8 i V6 4x4	11/95-04/00	AAA, AMY	2792	Rippenanzahl: 7	0-N1657	VB [BT]	S
2.8 V6	04/00-05/06	AYL	2792	Rippenanzahl: 6	0-N1496S	VB [TE]	
2.8 V6	04/00-05/06	AYL	2792	Rippenanzahl: 7; ⚠	0-N1657	VB [BT]	S

GALAXY (WA6)

1.6 TDCi	02/11-06/15	T1WA, T1WB	1560	25x141; Baumuster: Galaxy	SK-1728	BTK	
1.6 TDCi	02/11-06/15	T1WA, T1WB	1560	25x141; Baumuster: Galaxy Van	SK-1728	BTK	
1.6 TDCi	02/11-06/15	T1WA, T1WB	1560	25x141; Baumuster: Galaxy	SK-1728AQ1	BTKW	
1.6 TDCi	02/11-06/15	T1WA, T1WB	1560	25x141; Baumuster: Galaxy Van	SK-1728AQ1	BTKW	
1.8 TDCi	05/06-06/15	FFWA, QYWA	1753	20x91	SK-1341	BTK	
2.0 TDCi	05/06-06/15	AZWC, UKWA, KLWA, TYWA	1997	25.4x116	SK-1594	BTK	
2.0 TDCi	05/06-06/15	QXWA, QXWB, QXWC, UFWA	1997	25.4x116; → 03/2010	SK-1594	BTK	
2.0 TDCi	05/06-06/15	AZWA	1997	25.4x116; 11/2006 →	SK-1594	BTK	
2.0 TDCi	05/06-06/15	AZWC, UKWA	1997	25.4x116; Abgasnorm: Euro 4 (D4)	SK-1594AQ1	BTKW	
2.0 TDCi	05/06-06/15	AZWA, KLWA, TYWA, QXWA, QXWB, QXWC, UFWA	1997	25.4x116; Baumuster: Galaxy	SK-1594AQ1	BTKW	
2.0 TDCi	05/06-06/15	AZWA, KLWA, TYWA, QXWA, QXWB, QXWC, UFWA	1997	25.4x116; Baumuster: Galaxy Van	SK-1594AQ1	BTKW	
2.0 TDCi	05/06-06/15	AZWC, UKWA, QXWA, QXWB, QXWC, UFWA	1997	25x116; 03/2010 →	SK-1714	BTK	
2.0 TDCi	05/06-06/15	AZWC, UKWA, QXWA, QXWB, QXWC, UFWA, TXWA	1997	25x116	SK-1714AQ1	BTKW	
2.0 TDCi	11/07-06/15	TYWA	1997	25x116	SK-1714	BTK	
2.0 TDCi	11/07-06/15	TYWA	1997	25x116; Baumuster: Galaxy	SK-1714AQ1	BTKW	
2.0 TDCi	11/07-06/15	TYWA	1997	25x116; Baumuster: Galaxy Van	SK-1714AQ1	BTKW	
2.0 TDCi	03/10-06/15	TXWA	1997	25x116	SK-1714	BTK	
2.2 TDCi	03/08-12/12	Q4BA, Q4WA	2179	25.4x118	SK-1692	BTK	
2.2 TDCi	03/08-06/15	KNWA, Q4BA, Q4WA	2179	25.4x118	SK-1692AQ1	BTKW	
2.2 TDCi	11/10-06/15	KNWA	2179	25.4x118; 11/2010 →	SK-1692	BTK	
1.6 EcoBoost	11/10-06/15	JTWA, JTWB	1596		0-N2057	TB [TE]	
1.6 TDCi	02/11-06/15	T1WA, T1WB	1560		0-N2224	TB [TE]	
1.6 TDCi	02/11-06/15	T1WA, T1WB	1560		0-N2382	TB [DG]	
1.8 TDCi	05/06-06/15	FFWA, QYWA	1753		0-N1367	TB [TE]	
2.0 TDCi	05/06-06/15	AZWA, AZWC, UKWA, KLWA, TYWA, QXWA, QXWB, QXWC, UFWA, TXWA	1997		0-N1334	TB [DG]	

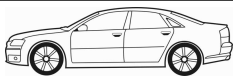

CM³



Art. Nr.



GALAXY (WA6)

2.0 TDCi	05/06-06/15	AZWC, UKWA, QXWA, QXWB, QXWC, UFWA, TXWA	1997		0-N2063	TB [TE]	
2.2 TDCi	03/08-06/15	KNWA, Q4BA, Q4WA	2179		0-N1334	TB [DG]	
2.2 TDCi	03/08-06/15	KNWA, Q4BA, Q4WA	2179		0-N2018	TB [BT]	
1.6 EcoBoost	11/10-06/15	JTWA, JTWB	1596		0-N2269	VB [BT]	S
1.6 EcoBoost	11/10-06/15	JTWA, JTWB	1596		0-N2363	VB [DG]	
1.6 TDCi	02/11-06/15	T1WA, T1WB	1560		0-N1339	VB [BT]	S
1.6 TDCi	02/11-06/15	T1WA, T1WB	1560		0-N1418	VB [DG]	
1.8 TDCi	05/06-06/15	FFWA, QYWA	1753		0-N1622	VB [DG]	
1.8 TDCi	05/06-06/15	FFWA, QYWA	1753		0-N1797	VB [BT]	S
2.0 TDCi	05/06-06/15	AZWA, KLWA, TYWA	1997		0-N1327	VB [BT]	
2.0 TDCi	05/06-06/15	AZWA, KLWA, TYWA	1997		0-N2037	VB [BT]	S
2.0 TDCi	05/06-06/15	AZWA, AZWC, UKWA, KLWA, TYWA, QXWA, QXWB, QXWC, UFWA	1997	03/2010 →	0-N2396	VB [BT]	S
2.0 TDCi	03/10-06/15	TXWA	1997		0-N2396	VB [BT]	S
2.0, 2.0 Flexifuel	05/06-06/15	AOWA, AOWB, TBWA, TBWB	1999	Rippenanzahl: 6	0-N1497	VB [BT]	S
2.0, 2.0 Flexifuel	05/06-06/15	AOWA, AOWB, TBWA, TBWB	1999		0-N1991	VB [DG]	
2.2 TDCi	03/08-06/15	KNWA, Q4BA, Q4WA	2179		0-N1963	VB [DG]	
2.2 TDCi	03/08-06/15	KNWA, Q4BA, Q4WA	2179		0-N2042	VB [BT]	S
2.3	09/07-06/15	SEWA	2261	Rippenanzahl: 6	0-N1497	VB [BT]	S
2.3	09/07-06/15	SEWA	2261		0-N1991	VB [DG]	

GALAXY

1.5 EcoBoost	01/15-	UNCI, UNCJ	1499		0-N2363	VB [DG]	
--------------	--------	------------	------	--	---------	---------	--

GRAND C-MAX (DXA/CB7, DXA/CEU)

1.6 TDCi	12/10-	T1DA, T1DB, T3DA, T3DB	1560	25x141	SK-1728	BTK	
1.6 TDCi	12/10-	T1DA, T1DB, T3DA, T3DB	1560	25x141	SK-1728AQ1	BTKW	
1.6 Ti	12/10-	IQDA, IQDB, PNDA	1596	22x117; mit Zubehör	SK-1659AQ1	BTKW	
2.0 TDCi	12/10-	TXDB, TYDA, UFDB, UKDB	1997	25x116	SK-1714	BTK	
2.0 TDCi	12/10-	TXDB, TYDA, UFDB, UKDB	1997	25x116	SK-1714AQ1	BTKW	
1.5 TDCi	03/15-	XWDA, XWDB, XXDA, XXDC	1499		0-N2382	TB [DG]	
1.6 EcoBoost	12/10-	JQDA, JQDB, JTDA, JTDB	1596		0-N2057	TB [TE]	
1.6 TDCi	12/10-	T1DA, T1DB, T3DA, T3DB	1560		0-N2224	TB [TE]	
1.6 TDCi	12/10-	DV6C	1560		0-N2382	TB [DG]	
1.6 TDCi	12/10-	T1DA, T1DB	1560		0-N2382	TB [DG]	
1.6 Ti	12/10-	IQDA, IQDB, PNDA	1596		0-N1564	TB [TE]	
2.0 TDCi	12/10-	TXDB, TYDA, UFDB, UKDB	1997		0-N1334	TB [DG]	
2.0 TDCi	12/10-	TXDB, TYDA, UFDB, UKDB	1997		0-N2063	TB [TE]	
1.0 EcoBoost	10/12-	M1DA, M2DA, SFDA	998		0-N2300	VB [BT]	S
1.0 EcoBoost	10/12-	M1DA, M2DA, SFDA	998		0-N2303	VB [DG]	
1.0 EcoBoost	10/12-	M1DA, M2DA, SFDA	998	✳	0-N2353	VB [DG]	
1.6 EcoBoost	12/10-	JQDA, JQDB, JTDA, JTDB	1596		0-N2269	VB [BT]	S
1.6 EcoBoost	12/10-	JQDA, JQDB, JTDA, JTDB	1596		0-N2363	VB [DG]	
1.6 TDCi	12/10-	T1DA, T1DB, T3DA, T3DB	1560		0-N1339	VB [BT]	S
1.6 TDCi	12/10-	T1DA, T1DB, T3DA, T3DB	1560		0-N1418	VB [DG]	
1.6 Ti	12/10-	IQDA, IQDB, PNDA	1596	✳	0-N2353	VB [DG]	
2.0 TDCi	12/10-	TXDB, TYDA, UFDB, UKDB	1997		0-N2396	VB [BT]	S

GRAND C-MAX Van

1.6 TDCi	12/10-	T1DA, T1DB, T3DA, T3DB	1560	25x141	SK-1728	BTK	
1.6 TDCi	12/10-	T1DA, T1DB, T3DA, T3DB	1560	25x141	SK-1728AQ1	BTKW	
2.0 TDCi	12/10-	TXDB, TYDA, UFDB	1997	25x116	SK-1714AQ1	BTKW	
1.5 TDCi	03/15-	XWDA, XWDB	1499		0-N2382	TB [DG]	
1.6 EcoBoost	12/10-	JQDA, JQDB	1596		0-N2057	TB [TE]	
1.6 TDCi	12/10-	DV6C	1560		0-N2224	TB [TE]	
1.6 TDCi	12/10-	DV6C	1560		0-N2382	TB [DG]	
1.6 EcoBoost	12/10-	JQDA, JQDB	1596		0-N2363	VB [DG]	

GRANADA (GU)

1.6	07/81-08/85	LCK	1593	19.05x119	SK-1160	BTK	
1.6	07/81-08/85	LCK	1593		0-N839	TB [TE]	
2.0	08/77-08/85	NYP	1998		0-N839	TB [TE]	
2.0	08/79-08/85	NEK, NEP	1993		0-N839	TB [TE]	

GRANADA Kombi (GNU)

1.7	08/77-07/81	MYE	1699		0-N839	TB [TE]	
2.0	08/77-06/85	NYP	1998		0-N839	TB [TE]	
2.0	08/79-08/85	NEK, NEP	1993		0-N839	TB [TE]	



CM³



Art. Nr.



KA (RB_)							
1.0 i	07/97-11/08	ZH10JRB	999	für Fahrzeuge mit Servolenkung	0-N1385	VB [DG]	
1.3 i	09/96-11/08	BAA, J4D, J4K, J4M, J4N, J4P, J4S	1299	→ 10/2002; für Fahrzeuge mit Servolenkung	0-N1385	VB [DG]	
1.3 i	09/96-11/08	JJB, JJD, JJF, JJG, JJH, JJJ	1299	für Fahrzeuge mit Servolenkung	0-N1385	VB [DG]	
1.3 i	09/96-11/08	BAA, J4D, J4K, J4M, J4N, J4P, J4S	1299	→ 10/2002; für Fahrzeuge mit Servolenkung	0-N1443	VB [BT]	S
1.3 i	09/96-11/08	JJB, JJD, JJF, JJG, JJH, JJJ	1299	für Fahrzeuge mit Servolenkung	0-N1443	VB [BT]	S
1.3 i	09/96-11/08	BAA, J4D, J4K, J4M, J4N, J4P, J4S	1299	10/2002 →	0-N2266	VB [BT]	
1.3 i	09/96-11/08	BAA, J4D, J4K, J4M, J4N, J4P, J4S	1299	10/2002 →	0-N2266S1	VB [DG]	
1.3 i	09/96-11/08	BAA, J4D, J4K, J4M, J4N, J4P, J4S	1299	10/2002 →	0-N2266S2	VB [DG]	
1.3 i	08/02-11/08	A9A, A9B	1299		0-N2266	VB [BT]	
1.3 i	08/02-11/08	A9A, A9B	1299		0-N2266S1	VB [DG]	
1.3 i	08/02-11/08	A9A, A9B	1299		0-N2266S2	VB [DG]	
1.6	10/06-12/07		1598		0-N2266	VB [BT]	
1.6	10/06-12/07		1598		0-N2266S1	VB [DG]	
1.6	10/06-12/07		1598		0-N2266S2	VB [DG]	
1.6 i	07/03-11/08	CDB, CDC, CDC	1599		0-N2266	VB [BT]	
1.6 i	07/03-11/08	CDB, CDC, CDC	1599		0-N2266S1	VB [DG]	
1.6 i	07/03-11/08	CDB, CDC, CDC	1599		0-N2266S2	VB [DG]	
KA Van (RB)							
1.3 i	05/02-05/05	BAA, J4D, J4K, J4M, J4N, J4P, J4S	1299	→ 10/2002; für Fahrzeuge mit Servolenkung	0-N1385	VB [DG]	
1.3 i	05/02-05/05	BAA, J4D, J4K, J4M, J4N, J4P, J4S	1299	10/2002 →	0-N2266	VB [BT]	
1.3 i	05/02-05/05	BAA, J4D, J4K, J4M, J4N, J4P, J4S	1299	10/2002 →	0-N2266S1	VB [DG]	
1.3 i	05/02-05/05	BAA, J4D, J4K, J4M, J4N, J4P, J4S	1299	10/2002 →	0-N2266S2	VB [DG]	
KA (RU8)							
1.2	10/08-	FP4	1242	22x129	SK-1677	BTK	
1.2	10/08-	FP4	1242		0-N1616	TB [TE]	
1.2	10/08-	FP4	1242		0-N1517	VB [BT]	S
1.3 TDCi	10/08-	FD4	1248		0-N1478S	VB [TE]	
KUGA I							
2.0 TDCi 4x4	03/10-11/12	TXDA	1998	25x116	SK-1714	BTK	
2.0 TDCi 4x4	03/10-11/12	TXDA	1998	25x116	SK-1714AQ1	BTKW	
2.0 TDCi, 2.0 TDCi 4x4	03/08-11/12	G6DG, UKDA	1997	25.4x116	SK-1594	BTK	
2.0 TDCi, 2.0 TDCi 4x4	03/08-11/12	G6DG, UKDA	1997	25.4x116; → 05/2010	SK-1594AQ1	BTKW	
2.0 TDCi, 2.0 TDCi 4x4	03/08-11/12	G6DG, UKDA	1997	25x116; 05/2010 →	SK-1714	BTK	
2.0 TDCi, 2.0 TDCi 4x4	03/08-11/12	G6DG, UKDA	1997	25x116; 05/2010 →	SK-1714AQ1	BTKW	
2.0 TDCi, 2.0 TDCi 4x4	03/10-11/12	UFDA	1997	25x116	SK-1714	BTK	
2.0 TDCi, 2.0 TDCi 4x4	03/10-11/12	UFDA	1997	25x116	SK-1714AQ1	BTKW	
2.5, 2.5 4x4	03/09-11/12	HYDB, HYDB, HYDC	2522	23x142	SK-1666	BTK	
2.5, 2.5 4x4	03/09-11/12	HYDB, HYDB, HYDC	2522	23x142	SK-1666AQ1	BTKW	
2.0 TDCi 4x4	03/10-11/12	TXDA	1998		0-N1334	TB [DG]	
2.0 TDCi 4x4	03/10-11/12	TXDA	1998		0-N2063	TB [TE]	
2.0 TDCi, 2.0 TDCi 4x4	03/08-11/12	G6DG, UKDA, UFDA	1997		0-N1334	TB [DG]	
2.0 TDCi, 2.0 TDCi 4x4	03/10-11/12	UFDA	1997		0-N2063	TB [TE]	
2.5, 2.5 4x4	03/09-11/12	HYDB, HYDB, HYDC	2522		0-N958	TB [DG]	
2.0 TDCi 4x4	03/10-11/12	TXDA	1998		0-N2396	VB [BT]	S
2.0 TDCi, 2.0 TDCi 4x4	03/08-11/12	G6DG, UKDA	1997		0-N1327	VB [BT]	
2.0 TDCi, 2.0 TDCi 4x4	03/08-11/12	G6DG, UKDA	1997		0-N2037	VB [BT]	S
2.0 TDCi, 2.0 TDCi 4x4	03/08-11/12	G6DG, UKDA	1997	03/2010 →	0-N2396	VB [BT]	S
2.0 TDCi, 2.0 TDCi 4x4	03/10-11/12	UFDA	1997		0-N2396	VB [BT]	S
2.5, 2.5 4x4	03/09-11/12	HYDB, HYDB, HYDC	2522		0-N2109	VB [BT]	S
2.5, 2.5 4x4	03/09-11/12	HYDB, HYDB, HYDC	2522		0-N2190	VB [BT]	S
KUGA II (DM2)							
2.0 TDCi 4x4	03/13-	T7MA, T7MB, TXDA, TXMA	1998	25x116	SK-1714	BTK	
2.0 TDCi 4x4	03/13-	TXDA, TXMA	1998	25x116	SK-1714AQ1	BTKW	
2.0 TDCi, 2.0 TDCi 4x4	03/13-	UFMA, UKMA	1997	25x116	SK-1714	BTK	
2.0 TDCi, 2.0 TDCi 4x4	03/13-	UFMA, UKMA	1997	25x116	SK-1714AQ1	BTKW	
1.6 EcoBoost, 1.6 EcoBoost 4x4	01/13-	JQMA, JQMB, JTMA	1596		0-N2057	TB [TE]	
1.6 EcoBoost, 1.6 EcoBoost 4x4	01/13-	JQMA, JQMB, JTMA	1596		0-N2363	VB [DG]	
1.6 EcoBoost, 1.6 EcoBoost 4x4	03/13-	JQMA, JQMB, JTMA	1596		0-N2269	VB [BT]	S
2.0 TDCi 4x4	03/13-	TXDA, TXMA	1998		0-N2396	VB [BT]	S
2.0 TDCi, 2.0 TDCi 4x4	03/13-	UFMA, UKMA	1997		0-N2396	VB [BT]	S
KUGA II Van							
1.5 EcoBoost, 1.5 EcoBoost 4x4	09/14-	M8MA, M9MA	1499		0-N2057	TB [TE]	
1.5 EcoBoost, 1.5 EcoBoost 4x4	09/14-	M8MA, M9MA	1499		0-N2363	VB [DG]	

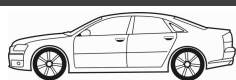

CM³



Art. Nr.



MAVERICK							
2.0 16V	02/01-	YF	1989	25.4x129	SK-1748	BTK	
2.0 16V	02/01-	YF	1989		0-N1778	TB [BT]	
2.0 16V	02/01-	YF	1989		0-N291	TB [DG]	
2.0 16V	02/01-	YF	1989	Rippenanzahl: 6	0-N1435	VB [BT]	S
2.0 16V	02/01-	YF	1989		0-N1716	VB [DG]	
2.3 16V	03/04-	GZ	2261		0-N1702	VB [DG]	
2.3 16V	03/04-	GZ	2261	→ 12/2005; Rippenanzahl: 6	0-N1811	VB [BT]	S

MONDEO I (GBP)							
1.6 i 16V	02/93-08/96	L1F, L1J	1597	25x131; mit Zubehör	SK-1094	BTK	
1.8 i 16V, 1.8 i 16V 4x4	02/93-08/96	RKA, RKB	1796	25x131; mit Zubehör	SK-1094	BTK	
1.8 TD	06/93-08/96	RFM, RFN	1753	20x116; 22x85; → 10/1995; mit Zubehör	SK-1041	BTK	
1.8 TD	06/93-08/96	RFN	1753	22x116; 22x85; 10/1995 →; Baumuster: GPB	SK-1042	BTK	
1.8 TD	06/93-08/96	RFM, RFN	1753	22x116; 22x85; 10/1995 →	SK-1042AQ3	BTKW	
1.8 TD	10/95-08/96	RFN	1753	22x116; 22x85	SK-1042	BTK	
1.8 TD	10/95-08/96	RFM, RFN	1753	22x116; 22x85	SK-1042AQ3	BTKW	
1.8 TD	10/95-08/96	RFM, RFN	1753	22x116; 22x85	SK-1078AQ3	BTKW	
2.0 i 16V, 2.0 i 16V 4x4	02/93-08/96	NGA	1988	25x131; mit Zubehör	SK-1094	BTK	
1.6 i 16V	02/93-08/96	L1F, L1J	1597		0-N096	TB [DG]	
1.6 i 16V	02/93-08/96	L1F, L1J	1597		0-N903	TB [TE]	
1.6 i 16V	02/93-08/96	L1F, L1J	1597		0-N904	TB [DG]	
1.8 i 16V, 1.8 i 16V 4x4	02/93-08/96	RKA, RKB	1796		0-N096	TB [DG]	
1.8 i 16V, 1.8 i 16V 4x4	02/93-08/96	RKA, RKB	1796		0-N903	TB [TE]	
1.8 i 16V, 1.8 i 16V 4x4	02/93-08/96	RKA, RKB	1796		0-N904	TB [DG]	
1.8 TD	06/93-08/96	RFM, RFN	1753	→ 10/1995	0-N874	TB [TE]	
1.8 TD	06/93-08/96	RFM, RFN	1753		0-N902	TB [DG]	
1.8 TD	06/93-08/96	RFM, RFN	1753		0-N915	TB [TE]	
1.8 TD	06/93-08/96	RFM, RFN	1753	10/1995 →	0-N985	TB [TE]	
1.8 TD	10/95-08/96	RFM, RFN	1753		0-N985	TB [TE]	
2.0 i 16V, 2.0 i 16V 4x4	02/93-08/96	NGA	1988		0-N096	TB [DG]	
2.0 i 16V, 2.0 i 16V 4x4	02/93-08/96	NGA	1988		0-N903	TB [TE]	
2.0 i 16V, 2.0 i 16V 4x4	02/93-08/96	NGA	1988		0-N904	TB [DG]	
1.6 i 16V	02/93-08/96	L1F, L1J	1597		0-N1642	VB [DG]	
1.6 i 16V	02/93-08/96	L1F, L1J	1597	→ 08/1995; ☼	0-N1845	VB [BT]	S
1.6 i 16V	02/93-08/96	L1F, L1J	1597	08/1995 →; ☼; ☼	0-N1845	VB [BT]	S
1.6 i 16V	02/93-08/96	L1F, L1J	1597	08/1995 →; ☼; ☼	0-N1845	VB [BT]	S
1.6 i 16V	02/93-08/96	L1F, L1J	1597	☼	0-N1845	VB [BT]	S
1.8 i 16V, 1.8 i 16V 4x4	02/93-08/96	RKA, RKB	1796		0-N1642	VB [DG]	
1.8 i 16V, 1.8 i 16V 4x4	02/93-08/96	RKA, RKB	1796	→ 08/1995; ☼	0-N1845	VB [BT]	S
1.8 i 16V, 1.8 i 16V 4x4	02/93-08/96	RKA, RKB	1796	08/1995 →; ☼; ☼	0-N1845	VB [BT]	S
1.8 i 16V, 1.8 i 16V 4x4	02/93-08/96	RKA, RKB	1796	08/1995 →; ☼; ☼	0-N1845	VB [BT]	S
1.8 i 16V, 1.8 i 16V 4x4	02/93-08/96	RKA, RKB	1796	☼	0-N1845	VB [BT]	S
1.8 TD	06/93-08/96	RFM, RFN	1753	09/1993 →	0-N1895	VB [BT]	S
1.8 TD	06/93-08/96	RFM, RFN	1753	09/1993 →	0-N1896	VB [BT]	S
1.8 TD	10/95-08/96	RFM, RFN	1753		0-N1895	VB [BT]	S
1.8 TD	10/95-08/96	RFM, RFN	1753		0-N1896	VB [BT]	S
2.0 i 16V, 2.0 i 16V 4x4	02/93-08/96	NGA	1988		0-N1642	VB [DG]	
2.0 i 16V, 2.0 i 16V 4x4	02/93-08/96	NGA	1988	→ 08/1995; ☼	0-N1845	VB [BT]	S
2.0 i 16V, 2.0 i 16V 4x4	02/93-08/96	NGA	1988	08/1995 →; ☼; ☼	0-N1845	VB [BT]	S
2.0 i 16V, 2.0 i 16V 4x4	02/93-08/96	NGA	1988	08/1995 →; ☼; ☼	0-N1845	VB [BT]	S
2.0 i 16V, 2.0 i 16V 4x4	02/93-08/96	NGA	1988	☼	0-N1845	VB [BT]	S
2.5 i 24V	07/94-08/96	SEA	2544		0-N2028	VB [DG]	

MONDEO I Stufenheck (GBP)							
1.6 i 16V	02/93-08/96	L1F, L1J	1597	25x131; mit Zubehör	SK-1094	BTK	
1.8 4x4, 1.8 i 16V	02/93-08/96	RKA, RKB	1796	25x131; mit Zubehör	SK-1094	BTK	
1.8 TD	06/93-08/96	RFM, RFN	1753	20x116; 22x85; → 10/1995; mit Zubehör	SK-1041	BTK	
1.8 TD	06/93-08/96	RFN	1753	22x116; 22x85; 10/1995 →; Baumuster: GPB	SK-1042	BTK	
1.8 TD	06/93-08/96	RFM, RFN	1753	22x116; 22x85; 10/1995 →	SK-1042AQ3	BTKW	
1.8 TD	10/95-08/96	RFN	1753	22x116; 22x85	SK-1042	BTK	
1.8 TD	10/95-08/96	RFM, RFN	1753	22x116; 22x85	SK-1042AQ3	BTKW	
1.8 TD	10/95-08/96	RFM, RFN	1753	22x116; 22x85	SK-1078AQ3	BTKW	
2.0 i 16V, 2.0 i 16V 4x4	02/93-08/96	NGA	1988	25x131; mit Zubehör	SK-1094	BTK	
1.6 i 16V	02/93-08/96	L1F, L1J	1597		0-N096	TB [DG]	
1.6 i 16V	02/93-08/96	L1F, L1J	1597		0-N903	TB [TE]	



CM³



Art. Nr.



ohne Halter

MONDEO I Stufenheck (GBP)

1.6 i 16V	02/93-08/96	L1F, L1J	1597		0-N904	TB [DG]	
1.8 4x4, 1.8 i 16V	02/93-08/96	RKA, RKB	1796		0-N096	TB [DG]	
1.8 4x4, 1.8 i 16V	02/93-08/96	RKA, RKB	1796		0-N903	TB [TE]	
1.8 4x4, 1.8 i 16V	02/93-08/96	RKA, RKB	1796		0-N904	TB [DG]	
1.8 TD	06/93-08/96	RFM, RFN	1753	→ 10/1995	0-N874	TB [TE]	
1.8 TD	06/93-08/96	RFM, RFN	1753		0-N902	TB [DG]	
1.8 TD	06/93-08/96	RFM, RFN	1753		0-N915	TB [TE]	
1.8 TD	06/93-08/96	RFM, RFN	1753	10/1995 →	0-N985	TB [TE]	
1.8 TD	10/95-08/96	RFM, RFN	1753		0-N985	TB [TE]	
2.0 i 16V, 2.0 i 16V 4x4	02/93-08/96	NGA	1988		0-N096	TB [DG]	
2.0 i 16V, 2.0 i 16V 4x4	02/93-08/96	NGA	1988		0-N903	TB [TE]	
2.0 i 16V, 2.0 i 16V 4x4	02/93-08/96	NGA	1988		0-N904	TB [DG]	
1.6 i 16V	02/93-08/96	L1F, L1J	1597		0-N1642	VB [DG]	
1.6 i 16V	02/93-08/96	L1F, L1J	1597	→ 08/1995; ✱	0-N1845	VB [BT]	S
1.6 i 16V	02/93-08/96	L1F, L1J	1597	08/1995 →; ✱; ✱	0-N1845	VB [BT]	S
1.6 i 16V	02/93-08/96	L1F, L1J	1597	08/1995 →; ✱; ✱	0-N1845	VB [BT]	S
1.6 i 16V	02/93-08/96	L1F, L1J	1597	✱	0-N1845	VB [BT]	S
1.8 4x4, 1.8 i 16V	02/93-08/96	RKA, RKB	1796		0-N1642	VB [DG]	
1.8 4x4, 1.8 i 16V	02/93-08/96	RKA, RKB	1796	→ 08/1995; ✱	0-N1845	VB [BT]	S
1.8 4x4, 1.8 i 16V	02/93-08/96	RKA, RKB	1796	08/1995 →; ✱; ✱	0-N1845	VB [BT]	S
1.8 4x4, 1.8 i 16V	02/93-08/96	RKA, RKB	1796	08/1995 →; ✱; ✱	0-N1845	VB [BT]	S
1.8 4x4, 1.8 i 16V	02/93-08/96	RKA, RKB	1796	✱	0-N1845	VB [BT]	S
1.8 TD	06/93-08/96	RFM, RFN	1753	09/1993 →	0-N1895	VB [BT]	S
1.8 TD	06/93-08/96	RFM, RFN	1753	09/1993 →	0-N1896	VB [BT]	S
1.8 TD	10/95-08/96	RFM, RFN	1753		0-N1895	VB [BT]	S
1.8 TD	10/95-08/96	RFM, RFN	1753		0-N1896	VB [BT]	S
2.0 i 16V, 2.0 i 16V 4x4	02/93-08/96	NGA	1988		0-N1642	VB [DG]	
2.0 i 16V, 2.0 i 16V 4x4	02/93-08/96	NGA	1988	→ 08/1995; ✱	0-N1845	VB [BT]	S
2.0 i 16V, 2.0 i 16V 4x4	02/93-08/96	NGA	1988	08/1995 →; ✱; ✱	0-N1845	VB [BT]	S
2.0 i 16V, 2.0 i 16V 4x4	02/93-08/96	NGA	1988	08/1995 →; ✱; ✱	0-N1845	VB [BT]	S
2.0 i 16V, 2.0 i 16V 4x4	02/93-08/96	NGA	1988	✱	0-N1845	VB [BT]	S
2.5 i 24V	07/94-08/96	SEA	2544		0-N2028	VB [DG]	

MONDEO I Kombi (BNP)

1.6 i 16V	04/93-08/96	L1F, L1J	1597	25x131; mit Zubehör	SK-1094	BTK	
1.8 i 16V	04/93-08/96	RKA, RKB	1796	25x131; mit Zubehör	SK-1094	BTK	
1.8 i 16V 4x4	04/93-08/96	RKA	1796	25x131; 04/1994 →; mit Zubehör	SK-1094	BTK	
1.8 TD	06/93-08/96	RFM, RFN	1753	20x116; 22x85; → 10/1995; mit Zubehör	SK-1041	BTK	
1.8 TD	06/93-08/96	RFN	1753	22x116; 22x85; 10/1995 →; Baumuster: BNP	SK-1042	BTK	
1.8 TD	06/93-08/96	RFM, RFN	1753	22x116; 22x85; 10/1995 →	SK-1042AQ3	BTKW	
1.8 TD	11/95-08/96	RFN	1753	22x116; 22x85; Baumuster: BNP	SK-1042	BTK	
1.8 TD	11/95-08/96	RFM, RFN	1753	22x116; 22x85	SK-1042AQ3	BTKW	
2.0 i 16V, 2.0 i 16V 4x4	01/93-08/96	NGA	1988	25x131; mit Zubehör	SK-1094	BTK	
1.6 i 16V	04/93-08/96	L1F, L1J	1597		0-N096	TB [DG]	
1.6 i 16V	04/93-08/96	L1F, L1J	1597		0-N903	TB [TE]	
1.6 i 16V	04/93-08/96	L1F, L1J	1597		0-N904	TB [DG]	
1.8 i 16V, 1.8 i 16V 4x4	04/93-08/96	RKA, RKB	1796		0-N096	TB [DG]	
1.8 i 16V, 1.8 i 16V 4x4	04/93-08/96	RKA, RKB	1796		0-N903	TB [TE]	
1.8 i 16V, 1.8 i 16V 4x4	04/93-08/96	RKA, RKB	1796		0-N904	TB [DG]	
1.8 TD	06/93-08/96	RFM, RFN	1753	→ 10/1995	0-N874	TB [TE]	
1.8 TD	06/93-08/96	RFM, RFN	1753		0-N902	TB [DG]	
1.8 TD	06/93-08/96	RFM, RFN	1753		0-N915	TB [TE]	
1.8 TD	06/93-08/96	RFM, RFN	1753	10/1995 →	0-N985	TB [TE]	
1.8 TD	11/95-08/96	RFM, RFN	1753		0-N985	TB [TE]	
2.0 i 16V, 2.0 i 16V 4x4	01/93-08/96	NGA	1988		0-N096	TB [DG]	
2.0 i 16V, 2.0 i 16V 4x4	01/93-08/96	NGA	1988		0-N903	TB [TE]	
2.0 i 16V, 2.0 i 16V 4x4	01/93-08/96	NGA	1988		0-N904	TB [DG]	
1.6 i 16V	04/93-08/96	L1F, L1J	1597		0-N1642	VB [DG]	
1.6 i 16V	04/93-08/96	L1F, L1J	1597	08/1995 →; ✱; ✱	0-N1845	VB [BT]	S
1.6 i 16V	04/93-08/96	L1F, L1J	1597	08/1995 →; ✱; ✱	0-N1845	VB [BT]	S
1.6 i 16V	04/93-08/96	L1F, L1J	1597	✱	0-N1845	VB [BT]	S
1.8 i 16V, 1.8 i 16V 4x4	04/93-08/96	RKA, RKB	1796		0-N1642	VB [DG]	
1.8 i 16V, 1.8 i 16V 4x4	04/93-08/96	RKA, RKB	1796	→ 08/1995; ✱	0-N1845	VB [BT]	S
1.8 i 16V, 1.8 i 16V 4x4	04/93-08/96	RKA, RKB	1796	08/1995 →; ✱; ✱	0-N1845	VB [BT]	S
1.8 i 16V, 1.8 i 16V 4x4	04/93-08/96	RKA, RKB	1796	08/1995 →; ✱; ✱	0-N1845	VB [BT]	S

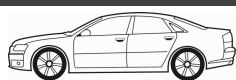

CM³



Art. Nr.



MONDEO I Kombi (BNP)							
1.8 i 16V, 1.8 i 16V 4x4	04/93-08/96	RKA, RKB	1796	☼		0-N1845	VB [BT] S
1.8 TD	06/93-08/96	RFM, RFN	1753	09/1993 →		0-N1895	VB [BT] S
1.8 TD	06/93-08/96	RFM, RFN	1753	09/1993 →		0-N1896	VB [BT] S
1.8 TD	11/95-08/96	RFM, RFN	1753			0-N1895	VB [BT] S
1.8 TD	11/95-08/96	RFM, RFN	1753			0-N1896	VB [BT] S
2.0 i 16V, 2.0 i 16V 4x4	01/93-08/96	NGA	1988			0-N1642	VB [DG]
2.0 i 16V, 2.0 i 16V 4x4	01/93-08/96	NGA	1988	→ 08/1995; ☼		0-N1845	VB [BT] S
2.0 i 16V, 2.0 i 16V 4x4	01/93-08/96	NGA	1988	08/1995 →; ☼; ☼		0-N1845	VB [BT] S
2.0 i 16V, 2.0 i 16V 4x4	01/93-08/96	NGA	1988	08/1995 →; ☼; ☼		0-N1845	VB [BT] S
2.0 i 16V, 2.0 i 16V 4x4	01/93-08/96	NGA	1988	☼		0-N1845	VB [BT] S
2.5 i 24V	07/94-08/96	SEA	2544			0-N2028	VB [DG]
MONDEO II (BAP)							
1.6 i	08/96-09/00	L1J	1597	25x131; → 05/1998; mit Zubehör		SK-1094	BTK
1.6 i	08/96-09/00	L1J	1597	25x129; 05/1998 → 01/1999; beinhaltetete Rollen: 3		SK-1339	BTK
1.6 i 16V	05/98-09/00	L1L, L1N, L1Q	1597	25x129; → 01/1999; beinhaltetete Rollen: 3		SK-1339	BTK
1.6 i, 1.6 i 16V	08/96-09/00	L1J, L1L, L1N, L1Q	1597	25x129; 02/1999 →; beinhaltetete Rollen: 2		SK-1340	BTK
1.8 i	08/96-09/00	RKB, RKF, RKH, RKJ, RKK	1796	25x131; → 05/1998; mit Zubehör		SK-1094	BTK
1.8 i	08/96-09/00	RKB, RKF, RKH, RKJ, RKK	1796	25x129; 05/1998 → 01/1999; beinhaltetete Rollen: 3		SK-1339	BTK
1.8 i	08/96-09/00	RKB, RKF, RKH, RKJ, RKK	1796	25x129; 02/1999 →; beinhaltetete Rollen: 2		SK-1340	BTK
1.8 TD	08/96-09/00	RFN	1753	22x116; 22x85; mit Zubehör		SK-1078	BTK
1.8 TD	08/96-09/00	RFN	1753	22x116; 22x85		SK-1078AQ3	BTKW
2.0 i	08/96-09/00	NGA, NGB, NGC, NGD	1988	25x131; → 05/1998; mit Zubehör		SK-1094	BTK
2.0 i	08/96-09/00	NGA, NGB, NGC, NGD	1988	25x129; 05/1998 → 01/1999; beinhaltetete Rollen: 3		SK-1339	BTK
2.0 i	08/96-09/00	NGA, NGB, NGC, NGD	1988	25x129; 02/1999 →; beinhaltetete Rollen: 2		SK-1340	BTK
1.6 i	08/96-09/00	L1J	1597	→ 04/1998		0-N096	TB [DG]
1.6 i	08/96-09/00	L1J	1597	05/1998 →		0-N290	TB [TE]
1.6 i	08/96-09/00	L1J	1597	05/1998 → 01/1999		0-N292	TB [DG]
1.6 i	08/96-09/00	L1J	1597	05/1998 → 01/1999		0-N293	TB [DG]
1.6 i	08/96-09/00	L1J	1597	→ 04/1998		0-N903	TB [TE]
1.6 i	08/96-09/00	L1J	1597	→ 04/1998		0-N904	TB [DG]
1.6 i 16V	05/98-09/00	L1L, L1N, L1Q	1597			0-N290	TB [TE]
1.6 i 16V	05/98-09/00	L1L, L1N, L1Q	1597	→ 01/1999		0-N292	TB [DG]
1.6 i 16V	05/98-09/00	L1L, L1N, L1Q	1597	→ 01/1999		0-N293	TB [DG]
1.6 i, 1.6 i 16V	08/96-09/00	L1J, L1L, L1N, L1Q	1597	02/1999 →; ¶		0-N291	TB [DG]
1.8 i	08/96-09/00	RKB, RKF, RKH, RKJ, RKK	1796	→ 04/1998		0-N096	TB [DG]
1.8 i	08/96-09/00	RKB, RKF, RKH, RKJ, RKK	1796	05/1998 →		0-N290	TB [TE]
1.8 i	08/96-09/00	RKB, RKF, RKH, RKJ, RKK	1796	02/1999 →; ¶		0-N291	TB [DG]
1.8 i	08/96-09/00	RKB, RKF, RKH, RKJ, RKK	1796	05/1998 → 01/1999		0-N292	TB [DG]
1.8 i	08/96-09/00	RKB, RKF, RKH, RKJ, RKK	1796	05/1998 → 01/1999		0-N293	TB [DG]
1.8 i	08/96-09/00	RKB, RKF, RKH, RKJ, RKK	1796	→ 04/1998		0-N903	TB [TE]
1.8 i	08/96-09/00	RKB, RKF, RKH, RKJ, RKK	1796	→ 04/1998		0-N904	TB [DG]
1.8 TD	08/96-09/00	RFN	1753			0-N089	TB [TE]
1.8 TD	08/96-09/00	RFN	1753			0-N123	TB [TE]
1.8 TD	08/96-09/00	RFN	1753			0-N915	TB [TE]
2.0 i	08/96-09/00	NGA, NGB, NGC, NGD	1988	→ 04/1998		0-N096	TB [DG]
2.0 i	08/96-09/00	NGA, NGB, NGC, NGD	1988	05/1998 →		0-N290	TB [TE]
2.0 i	08/96-09/00	NGA, NGB, NGC, NGD	1988	02/1999 →; ¶		0-N291	TB [DG]
2.0 i	08/96-09/00	NGA, NGB, NGC, NGD	1988	05/1998 → 01/1999		0-N292	TB [DG]
2.0 i	08/96-09/00	NGA, NGB, NGC, NGD	1988	05/1998 → 01/1999		0-N293	TB [DG]
2.0 i	08/96-09/00	NGA, NGB, NGC, NGD	1988	→ 04/1998		0-N903	TB [TE]
2.0 i	08/96-09/00	NGA, NGB, NGC, NGD	1988	→ 04/1998		0-N904	TB [DG]
1.6 i	08/96-09/00	L1J	1597	05/1998 →; Rippenanzahl: 6		0-N1435	VB [BT] S
1.6 i	08/96-09/00	L1J	1597	→ 05/1998		0-N1642	VB [DG]
1.6 i	08/96-09/00	L1J	1597	05/1998 →		0-N1716	VB [DG]
1.6 i	08/96-09/00	L1J	1597	→ 05/1998; ☼; ☼		0-N1845	VB [BT] S
1.6 i	08/96-09/00	L1J	1597	→ 05/1998; ☼		0-N1845	VB [BT] S
1.6 i	08/96-09/00	L1J	1597	→ 05/1998; ☼; ☼		0-N1845	VB [BT] S
1.6 i 16V	05/98-09/00	L1L, L1N, L1Q	1597	Rippenanzahl: 6		0-N1435	VB [BT] S
1.6 i 16V	05/98-09/00	L1L, L1N, L1Q	1597			0-N1716	VB [DG]
1.8 i	08/96-09/00	RKB, RKF, RKH, RKJ, RKK	1796	05/1998 →; Rippenanzahl: 6		0-N1435	VB [BT] S
1.8 i	08/96-09/00	RKB, RKF, RKH, RKJ, RKK	1796	→ 05/1998		0-N1642	VB [DG]
1.8 i	08/96-09/00	RKB, RKF, RKH, RKJ, RKK	1796	05/1998 →		0-N1716	VB [DG]
1.8 i	08/96-09/00	RKB, RKF, RKH, RKJ, RKK	1796	→ 05/1998; ☼; ☼		0-N1845	VB [BT] S



OPTIMAL®

FORD



CM³



Art. Nr.



MONDEO II (BAP)

1.8 i	08/96-09/00	RKB, RKF, RKH, RKJ, RKK	1796	→ 05/1998;	0-N1845	VB [BT]	S
1.8 i	08/96-09/00	RKB, RKF, RKH, RKJ, RKK	1796	→ 05/1998; ;	0-N1845	VB [BT]	S
1.8 TD	08/96-09/00	RFN	1753		0-N1895	VB [BT]	S
1.8 TD	08/96-09/00	RFN	1753		0-N1896	VB [BT]	S
2.0 i	08/96-09/00	NGA, NGB, NGC, NGD	1988	05/1998 →; Rippenanzahl: 6	0-N1435	VB [BT]	S
2.0 i	08/96-09/00	NGA, NGB, NGC, NGD	1988	→ 05/1998	0-N1642	VB [DG]	
2.0 i	08/96-09/00	NGA, NGB, NGC, NGD	1988	05/1998 →	0-N1716	VB [DG]	
2.0 i	08/96-09/00	NGA, NGB, NGC, NGD	1988	→ 05/1998; ;	0-N1845	VB [BT]	S
2.0 i	08/96-09/00	NGA, NGB, NGC, NGD	1988	→ 05/1998;	0-N1845	VB [BT]	S
2.0 i	08/96-09/00	NGA, NGB, NGC, NGD	1988	→ 05/1998; ;	0-N1845	VB [BT]	S
2.5 24V	08/96-09/00	SEA	2544		0-N2028	VB [DG]	
2.5 24V, 2.5 ST 200	05/99-09/00	SEB, SEC, SGA	2495		0-N2028	VB [DG]	

MONDEO II Stufenheck (BFP)

1.6 i	08/96-09/00	L1J	1597	25x131; → 05/1998; mit Zubehör	SK-1094	BTK	
1.6 i	08/96-09/00	L1J	1597	25x129; 05/1998 → 01/1999; beinhaltete Rollen: 3	SK-1339	BTK	
1.6 i 16V	05/98-09/00	L1L, L1N, L1Q	1597	25x129; → 01/1999; beinhaltete Rollen: 3	SK-1339	BTK	
1.6 i, 1.6 i 16V	08/96-09/00	L1J, L1L, L1N, L1Q	1597	25x129; 02/1999 →; beinhaltete Rollen: 2	SK-1340	BTK	
1.8 i	08/96-09/00	RKB, RKF, RKH, RKJ, RKK	1796	25x131; → 05/1998; mit Zubehör	SK-1094	BTK	
1.8 i	08/96-09/00	RKB, RKF, RKH, RKJ, RKK	1796	25x129; 05/1998 → 01/1999; beinhaltete Rollen: 3	SK-1339	BTK	
1.8 i	08/96-09/00	RKB, RKF, RKH, RKJ, RKK	1796	25x129; 02/1999 →; beinhaltete Rollen: 2	SK-1340	BTK	
1.8 TD	08/96-09/00	RFN	1753	22x116; 22x85; mit Zubehör	SK-1078	BTK	
1.8 TD	08/96-09/00	RFN	1753	22x116; 22x85	SK-1078AQ3	BTKW	
2.0 i	08/96-09/00	NGA, NGB, NGC, NGD	1988	25x131; → 05/1998; mit Zubehör	SK-1094	BTK	
2.0 i	08/96-09/00	NGA, NGB, NGC, NGD	1988	25x129; 05/1998 → 01/1999; beinhaltete Rollen: 3	SK-1339	BTK	
2.0 i	08/96-09/00	NGA, NGB, NGC, NGD	1988	25x129; 02/1999 →; beinhaltete Rollen: 2	SK-1340	BTK	
1.6 i	08/96-09/00	L1J	1597	→ 04/1998	0-N096	TB [DG]	
1.6 i	08/96-09/00	L1J	1597	05/1998 →	0-N290	TB [TE]	
1.6 i	08/96-09/00	L1J	1597	05/1998 → 01/1999	0-N292	TB [DG]	
1.6 i	08/96-09/00	L1J	1597	05/1998 → 01/1999	0-N293	TB [DG]	
1.6 i	08/96-09/00	L1J	1597	→ 04/1998	0-N903	TB [TE]	
1.6 i	08/96-09/00	L1J	1597	→ 04/1998	0-N904	TB [DG]	
1.6 i 16V	05/98-09/00	L1L, L1N, L1Q	1597		0-N290	TB [TE]	
1.6 i 16V	05/98-09/00	L1L, L1N, L1Q	1597	→ 01/1999	0-N292	TB [DG]	
1.6 i 16V	05/98-09/00	L1L, L1N, L1Q	1597	→ 01/1999	0-N293	TB [DG]	
1.6 i, 1.6 i 16V	08/96-09/00	L1J, L1L, L1N, L1Q	1597	02/1999 →;	0-N291	TB [DG]	
1.8 i	08/96-09/00	RKB, RKF, RKH, RKJ, RKK	1796	→ 04/1998	0-N096	TB [DG]	
1.8 i	08/96-09/00	RKB, RKF, RKH, RKJ, RKK	1796	05/1998 →	0-N290	TB [TE]	
1.8 i	08/96-09/00	RKB, RKF, RKH, RKJ, RKK	1796	02/1999 →;	0-N291	TB [DG]	
1.8 i	08/96-09/00	RKB, RKF, RKH, RKJ, RKK	1796	05/1998 → 01/1999	0-N292	TB [DG]	
1.8 i	08/96-09/00	RKB, RKF, RKH, RKJ, RKK	1796	05/1998 → 01/1999	0-N293	TB [DG]	
1.8 i	08/96-09/00	RKB, RKF, RKH, RKJ, RKK	1796	→ 04/1998	0-N903	TB [TE]	
1.8 i	08/96-09/00	RKB, RKF, RKH, RKJ, RKK	1796	→ 04/1998	0-N904	TB [DG]	
1.8 TD	08/96-09/00	RFN	1753		0-N089	TB [TE]	
1.8 TD	08/96-09/00	RFN	1753		0-N123	TB [TE]	
1.8 TD	08/96-09/00	RFN	1753		0-N915	TB [TE]	
2.0 i	08/96-09/00	NGA, NGB, NGC, NGD	1988	→ 04/1998	0-N096	TB [DG]	
2.0 i	08/96-09/00	NGA, NGB, NGC, NGD	1988	05/1998 →	0-N290	TB [TE]	
2.0 i	08/96-09/00	NGA, NGB, NGC, NGD	1988	02/1999 →;	0-N291	TB [DG]	
2.0 i	08/96-09/00	NGA, NGB, NGC, NGD	1988	05/1998 → 01/1999	0-N292	TB [DG]	
2.0 i	08/96-09/00	NGA, NGB, NGC, NGD	1988	05/1998 → 01/1999	0-N293	TB [DG]	
2.0 i	08/96-09/00	NGA, NGB, NGC, NGD	1988	→ 04/1998	0-N903	TB [TE]	
2.0 i	08/96-09/00	NGA, NGB, NGC, NGD	1988	→ 04/1998	0-N904	TB [DG]	
1.6 i	08/96-09/00	L1J	1597	05/1998 →; Rippenanzahl: 6	0-N1435	VB [BT]	S
1.6 i	08/96-09/00	L1J	1597	→ 05/1998	0-N1642	VB [DG]	
1.6 i	08/96-09/00	L1J	1597	05/1998 →	0-N1716	VB [DG]	
1.6 i	08/96-09/00	L1J	1597	→ 05/1998; ;	0-N1845	VB [BT]	S
1.6 i	08/96-09/00	L1J	1597	→ 05/1998;	0-N1845	VB [BT]	S
1.6 i	08/96-09/00	L1J	1597	→ 05/1998; ;	0-N1845	VB [BT]	S
1.6 i 16V	05/98-09/00	L1L, L1N, L1Q	1597	Rippenanzahl: 6	0-N1435	VB [BT]	S
1.6 i 16V	05/98-09/00	L1L, L1N, L1Q	1597		0-N1716	VB [DG]	
1.8 i	08/96-09/00	RKB, RKF, RKH, RKJ, RKK	1796	05/1998 →; Rippenanzahl: 6	0-N1435	VB [BT]	S
1.8 i	08/96-09/00	RKB, RKF, RKH, RKJ, RKK	1796	→ 05/1998	0-N1642	VB [DG]	
1.8 i	08/96-09/00	RKB, RKF, RKH, RKJ, RKK	1796	05/1998 →	0-N1716	VB [DG]	

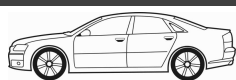

CM³



Art. Nr.



ohne Halter

MONDEO II Stufenheck (BFP)								
1.8 i	08/96-09/00	RKB, RKF, RKH, RKJ, RKK	1796	→ 05/1998; ;	0-N1845	VB [BT]	S	
1.8 i	08/96-09/00	RKB, RKF, RKH, RKJ, RKK	1796	→ 05/1998;	0-N1845	VB [BT]	S	
1.8 i	08/96-09/00	RKB, RKF, RKH, RKJ, RKK	1796	→ 05/1998; ;	0-N1845	VB [BT]	S	
1.8 TD	08/96-09/00	RFN	1753		0-N1895	VB [BT]	S	
1.8 TD	08/96-09/00	RFN	1753		0-N1896	VB [BT]	S	
2.0 i	08/96-09/00	NGA, NGB, NGC, NGD	1988	05/1998 →; Rippenanzahl: 6	0-N1435	VB [BT]	S	
2.0 i	08/96-09/00	NGA, NGB, NGC, NGD	1988	→ 05/1998	0-N1642	VB [DG]		
2.0 i	08/96-09/00	NGA, NGB, NGC, NGD	1988	05/1998 →	0-N1716	VB [DG]		
2.0 i	08/96-09/00	NGA, NGB, NGC, NGD	1988	→ 05/1998; ;	0-N1845	VB [BT]	S	
2.0 i	08/96-09/00	NGA, NGB, NGC, NGD	1988	→ 05/1998;	0-N1845	VB [BT]	S	
2.0 i	08/96-09/00	NGA, NGB, NGC, NGD	1988	→ 05/1998; ;	0-N1845	VB [BT]	S	
2.5 24V	08/96-09/00	SEA	2544		0-N2028	VB [DG]		
2.5 24V, 2.5 ST 200	05/99-09/00	LCBD, SEB, SEC, SGA	2495		0-N2028	VB [DG]		
MONDEO II Kombi (BNP)								
1.6 i	08/96-09/00	L1J	1597	25x131; → 05/1998; mit Zubehör	SK-1094	BTK		
1.6 i	08/96-09/00	L1J	1597	25x129; 05/1998 → 01/1999; beinhaltetete Rollen: 3	SK-1339	BTK		
1.6 i 16V	05/98-09/00	L1L, L1N, L1Q	1597	25x129; → 01/1999; beinhaltetete Rollen: 3	SK-1339	BTK		
1.6 i, 1.6 i 16V	08/96-09/00	L1J, L1L, L1N, L1Q	1597	25x129; 02/1999 →; beinhaltetete Rollen: 2	SK-1340	BTK		
1.8 i	08/96-09/00	RKB, RKF, RKH, RKJ, RKK	1796	25x131; → 05/1998; mit Zubehör	SK-1094	BTK		
1.8 i	08/96-09/00	RKB, RKF, RKH, RKJ, RKK	1796	25x129; 05/1998 → 01/1999; beinhaltetete Rollen: 3	SK-1339	BTK		
1.8 i	08/96-09/00	RKB, RKF, RKH, RKJ, RKK	1796	25x129; 02/1999 →; beinhaltetete Rollen: 2	SK-1340	BTK		
1.8 TD	08/96-09/00	RFN	1753	22x116; 22x85; mit Zubehör	SK-1078	BTK		
1.8 TD	08/96-09/00	RFN	1753	22x116; 22x85	SK-1078AQ3	BTKW		
2.0 i	08/96-09/00	NGA, NGB, NGC, NGD	1988	25x131; → 05/1998; mit Zubehör	SK-1094	BTK		
2.0 i	08/96-09/00	NGA, NGB, NGC, NGD	1988	25x129; 05/1998 → 01/1999; beinhaltetete Rollen: 3	SK-1339	BTK		
2.0 i	08/96-09/00	NGA, NGB, NGC, NGD	1988	25x129; 02/1999 →; beinhaltetete Rollen: 2	SK-1340	BTK		
1.6 i	08/96-09/00	L1J	1597	→ 04/1998	0-N096	TB [DG]		
1.6 i	08/96-09/00	L1J	1597	05/1998 →	0-N290	TB [TE]		
1.6 i	08/96-09/00	L1J	1597	05/1998 → 01/1999	0-N292	TB [DG]		
1.6 i	08/96-09/00	L1J	1597	05/1998 → 01/1999	0-N293	TB [DG]		
1.6 i	08/96-09/00	L1J	1597	→ 04/1998	0-N903	TB [TE]		
1.6 i	08/96-09/00	L1J	1597	→ 04/1998	0-N904	TB [DG]		
1.6 i 16V	05/98-09/00	L1L, L1N, L1Q	1597		0-N290	TB [TE]		
1.6 i 16V	05/98-09/00	L1L, L1N, L1Q	1597	→ 01/1999	0-N292	TB [DG]		
1.6 i 16V	05/98-09/00	L1L, L1N, L1Q	1597	→ 01/1999	0-N293	TB [DG]		
1.6 i, 1.6 i 16V	08/96-09/00	L1J, L1L, L1N, L1Q	1597	02/1999 →;	0-N291	TB [DG]		
1.8 i	08/96-09/00	RKB, RKF, RKH, RKJ, RKK	1796	→ 04/1998	0-N096	TB [DG]		
1.8 i	08/96-09/00	RKB, RKF, RKH, RKJ, RKK	1796	05/1998 →	0-N290	TB [TE]		
1.8 i	08/96-09/00	RKB, RKF, RKH, RKJ, RKK	1796	02/1999 →;	0-N291	TB [DG]		
1.8 i	08/96-09/00	RKB, RKF, RKH, RKJ, RKK	1796	05/1998 → 01/1999	0-N292	TB [DG]		
1.8 i	08/96-09/00	RKB, RKF, RKH, RKJ, RKK	1796	05/1998 → 01/1999	0-N293	TB [DG]		
1.8 i	08/96-09/00	RKB, RKF, RKH, RKJ, RKK	1796	→ 04/1998	0-N903	TB [TE]		
1.8 i	08/96-09/00	RKB, RKF, RKH, RKJ, RKK	1796	→ 04/1998	0-N904	TB [DG]		
1.8 TD	08/96-09/00	RFN	1753		0-N089	TB [TE]		
1.8 TD	08/96-09/00	RFN	1753		0-N123	TB [TE]		
1.8 TD	08/96-09/00	RFN	1753		0-N915	TB [TE]		
2.0 i	08/96-09/00	NGA, NGB, NGC, NGD	1988	→ 04/1998	0-N096	TB [DG]		
2.0 i	08/96-09/00	NGA, NGB, NGC, NGD	1988	05/1998 →	0-N290	TB [TE]		
2.0 i	08/96-09/00	NGA, NGB, NGC, NGD	1988	02/1999 →;	0-N291	TB [DG]		
2.0 i	08/96-09/00	NGA, NGB, NGC, NGD	1988	05/1998 → 01/1999	0-N292	TB [DG]		
2.0 i	08/96-09/00	NGA, NGB, NGC, NGD	1988	05/1998 → 01/1999	0-N293	TB [DG]		
2.0 i	08/96-09/00	NGA, NGB, NGC, NGD	1988	→ 04/1998	0-N903	TB [TE]		
2.0 i	08/96-09/00	NGA, NGB, NGC, NGD	1988	→ 04/1998	0-N904	TB [DG]		
1.6 i	08/96-09/00	L1J	1597	05/1998 →; Rippenanzahl: 6	0-N1435	VB [BT]	S	
1.6 i	08/96-09/00	L1J	1597	→ 05/1998	0-N1642	VB [DG]		
1.6 i	08/96-09/00	L1J	1597	05/1998 →	0-N1716	VB [DG]		
1.6 i	08/96-09/00	L1J	1597	→ 05/1998; ;	0-N1845	VB [BT]	S	
1.6 i	08/96-09/00	L1J	1597	→ 05/1998;	0-N1845	VB [BT]	S	
1.6 i	08/96-09/00	L1J	1597	→ 05/1998; ;	0-N1845	VB [BT]	S	
1.6 i 16V	05/98-09/00	L1L, L1N, L1Q	1597	Rippenanzahl: 6	0-N1435	VB [BT]	S	
1.6 i 16V	05/98-09/00	L1L, L1N, L1Q	1597		0-N1716	VB [DG]		
1.8 i	08/96-09/00	RKB, RKF, RKH, RKJ, RKK	1796	05/1998 →; Rippenanzahl: 6	0-N1435	VB [BT]	S	
1.8 i	08/96-09/00	RKB, RKF, RKH, RKJ, RKK	1796	→ 05/1998	0-N1642	VB [DG]		

CM³

Art. Nr.

**MONDEO II Kombi (BNP)**

1.8 i	08/96-09/00	RKB, RKF, RKH, RKJ, RKK	1796	05/1998 →	0-N1716	VB [DG]	
1.8 i	08/96-09/00	RKB, RKF, RKH, RKJ, RKK	1796	→ 05/1998; ;	0-N1845	VB [BT]	S
1.8 i	08/96-09/00	RKB, RKF, RKH, RKJ, RKK	1796	→ 05/1998;	0-N1845	VB [BT]	S
1.8 i	08/96-09/00	RKB, RKF, RKH, RKJ, RKK	1796	→ 05/1998; ;	0-N1845	VB [BT]	S
1.8 TD	08/96-09/00	RFN	1753		0-N1895	VB [BT]	S
1.8 TD	08/96-09/00	RFN	1753		0-N1896	VB [BT]	S
2.0 i	08/96-09/00	NGA, NGB, NGC, NGD	1988	05/1998 →; Rippenanzahl: 6	0-N1435	VB [BT]	S
2.0 i	08/96-09/00	NGA, NGB, NGC, NGD	1988	→ 05/1998	0-N1642	VB [DG]	
2.0 i	08/96-09/00	NGA, NGB, NGC, NGD	1988	05/1998 →	0-N1716	VB [DG]	
2.0 i	08/96-09/00	NGA, NGB, NGC, NGD	1988	→ 05/1998; ;	0-N1845	VB [BT]	S
2.0 i	08/96-09/00	NGA, NGB, NGC, NGD	1988	→ 05/1998;	0-N1845	VB [BT]	S
2.0 i	08/96-09/00	NGA, NGB, NGC, NGD	1988	→ 05/1998; ;	0-N1845	VB [BT]	S
2.5 24V	08/96-09/00	SEA	2544		0-N2028	VB [DG]	
2.5 24V, 2.5 ST 200	05/99-09/00	SEB, SEC, SGA	2495		0-N2028	VB [DG]	

MONDEO III (B5Y)

1.8 16V	10/00-03/07	CGBA, CGBB, CHBA, CHBB	1798	→ 11/2005	0-N1702	VB [DG]	
1.8 16V, 1.8 Sci	10/00-03/07	CFBA, CGBA, CGBB, CHBA, CHBB	1798	Rippenanzahl: 6	0-N1497	VB [BT]	S
1.8 16V, 1.8 Sci	10/00-03/07	CFBA, CGBA, CGBB, CHBA, CHBB	1798	12/2005 →	0-N1991	VB [DG]	
1.8 Sci	06/03-03/07	CFBA	1798		0-N1702	VB [DG]	
2.0 16V	10/00-03/07	CJBA, CJBB	1999	Rippenanzahl: 6	0-N1497	VB [BT]	S
2.0 16V	10/00-03/07	CJBA, CJBB	1999	→ 11/2005	0-N1702	VB [DG]	
2.0 16V	10/00-03/07	CJBA, CJBB	1999	12/2005 →	0-N1991	VB [DG]	
2.0 16V DI / TDDi / TDCi, 2.0 16V TDDi / TDCi, 2.0 TDCi	10/00-03/07	D5BA, SDBA, D6BA, HJBA, HJBB, HJBC, FMBA, N7BA	1998		0-N1390	VB [BT]	S
2.0 16V DI / TDDi / TDCi, 2.0 16V TDDi / TDCi, 2.0 TDCi	10/00-03/07	D5BA, SDBA, D6BA, HJBA, HJBB, HJBC, FMBA, N7BA	1998		0-N1392	VB [DG]	
2.0 16V DI / TDDi / TDCi, 2.0 16V TDDi / TDCi, 2.0 TDCi	10/00-03/07	D5BA, SDBA, D6BA, HJBA, HJBB, HJBC, FMBA, N7BA	1998	Rippenanzahl: 6	0-N1428	VB [DG]	
2.0 16V DI / TDDi / TDCi, 2.0 16V TDDi / TDCi, 2.0 TDCi	10/00-03/07	D5BA, SDBA, D6BA, HJBA, HJBB, HJBC, FMBA, N7BA	1998		0-N1477	VB [TE]	S
2.2 TDCi	09/04-03/07	QJBA, QJBB, QJBC, QJBD	2198		0-N1390	VB [BT]	S
2.2 TDCi	09/04-03/07	QJBA, QJBB, QJBC, QJBD	2198		0-N1392	VB [DG]	
2.2 TDCi	09/04-03/07	QJBA, QJBB	2198	Rippenanzahl: 6	0-N1428	VB [DG]	
2.2 TDCi	09/04-03/07	QJBA, QJBB	2198		0-N1477	VB [TE]	S

MONDEO III Stufenheck (B4Y)

1.8 16V	10/00-03/07	CGBA, CGBB, CHBA, CHBB	1798	→ 11/2005	0-N1702	VB [DG]	
1.8 16V, 1.8 Sci	10/00-03/07	CFBA, CGBA, CGBB, CHBA, CHBB	1798	Rippenanzahl: 6	0-N1497	VB [BT]	S
1.8 16V, 1.8 Sci	10/00-03/07	CFBA, CGBA, CGBB, CHBA, CHBB	1798	12/2005 →	0-N1991	VB [DG]	
1.8 Sci	06/03-03/07	CFBA	1798		0-N1702	VB [DG]	
2.0 16V	10/00-03/07	CJBA, CJBB	1999	Rippenanzahl: 6	0-N1497	VB [BT]	S
2.0 16V	10/00-03/07	CJBA, CJBB	1999	→ 11/2005	0-N1702	VB [DG]	
2.0 16V	10/00-03/07	CJBA, CJBB	1999	12/2005 →	0-N1991	VB [DG]	
2.0 16V DI / TDDi / TDCi, 2.0 16V TDDi / TDCi, 2.0 TDCi	10/00-03/07	D5BA, SDBA, D6BA, HJBA, HJBB, HJBC, FMBA, N7BA	1998		0-N1390	VB [BT]	S
2.0 16V DI / TDDi / TDCi, 2.0 16V TDDi / TDCi, 2.0 TDCi	10/00-03/07	D5BA, SDBA, D6BA, HJBA, HJBB, HJBC, FMBA, N7BA	1998		0-N1392	VB [DG]	
2.0 16V DI / TDDi / TDCi, 2.0 16V TDDi / TDCi, 2.0 TDCi	10/00-03/07	D5BA, SDBA, D6BA, HJBA, HJBB, HJBC, FMBA, N7BA	1998	Rippenanzahl: 6	0-N1428	VB [DG]	
2.0 16V DI / TDDi / TDCi, 2.0 16V TDDi / TDCi, 2.0 TDCi	10/00-03/07	D5BA, SDBA, D6BA, HJBA, HJBB, HJBC, FMBA, N7BA	1998		0-N1477	VB [TE]	S
2.2 TDCi	09/04-03/07	QJBA, QJBB, QJBC, QJBD	2198		0-N1390	VB [BT]	S
2.2 TDCi	09/04-03/07	QJBA, QJBB, QJBC, QJBD	2198		0-N1392	VB [DG]	
2.2 TDCi	09/04-03/07	QJBA, QJBB	2198	Rippenanzahl: 6	0-N1428	VB [DG]	
2.2 TDCi	09/04-03/07	QJBA, QJBB	2198		0-N1477	VB [TE]	S

MONDEO III Kombi (BWY)

1.8 16V	10/00-03/07	CGBA, CGBB, CHBA, CHBB	1798	→ 11/2005	0-N1702	VB [DG]	
1.8 16V, 1.8 Sci	10/00-03/07	CFBA, CGBA, CGBB, CHBA, CHBB	1798	Rippenanzahl: 6	0-N1497	VB [BT]	S
1.8 16V, 1.8 Sci	10/00-03/07	CFBA, CGBA, CGBB, CHBA, CHBB	1798	12/2005 →	0-N1991	VB [DG]	
1.8 Sci	06/03-03/07	CFBA	1798		0-N1702	VB [DG]	
2.0 16V	10/00-03/07	CJBA, CJBB	1999	Rippenanzahl: 6	0-N1497	VB [BT]	S
2.0 16V	10/00-03/07	CJBA, CJBB	1999	→ 11/2005	0-N1702	VB [DG]	
2.0 16V	10/00-03/07	CJBA, CJBB	1999	12/2005 →	0-N1991	VB [DG]	
2.0 16V DI / TDDi / TDCi, 2.0 16V TDDi / TDCi, 2.0 TDCi	10/00-03/07	D5BA, SDBA, D6BA, HJBA, HJBB, HJBC, FMBA, N7BA	1998		0-N1390	VB [BT]	S
2.0 16V DI / TDDi / TDCi, 2.0 16V TDDi / TDCi, 2.0 TDCi	10/00-03/07	D5BA, SDBA, D6BA, HJBA, HJBB, HJBC, FMBA, N7BA	1998		0-N1392	VB [DG]	

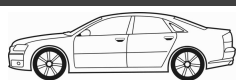

CM³



Art. Nr.



MONDEO III Kombi (BWY)									
2.0 16V Di / TDDi / TDCi, 2.0 16V TDDi / TDCi, 2.0 TDCi	10/00-03/07	D5BA, SDBA, D6BA, HJBA, HJBB, HJBC, FMBA, N7BA	1998	Rippenanzahl: 6		0-N1428	VB [DG]		
2.0 16V Di / TDDi / TDCi, 2.0 16V TDDi / TDCi, 2.0 TDCi	10/00-03/07	D5BA, SDBA, D6BA, HJBA, HJBB, HJBC, FMBA, N7BA	1998			0-N1477	VB [TE]	S	
2.2 TDCi	09/04-03/07	QJBA, QJBB, QJBC, QJBD	2198			0-N1390	VB [BT]	S	
2.2 TDCi	09/04-03/07	QJBA, QJBB, QJBC, QJBD	2198			0-N1392	VB [DG]		
2.2 TDCi	09/04-03/07	QJBA, QJBB, QJBC, QJBD	2198	Rippenanzahl: 6		0-N1428	VB [DG]		
2.2 TDCi	09/04-03/07	QJBA, QJBB, QJBC, QJBD	2198			0-N1477	VB [TE]	S	
MONDEO IV (BA7)									
1.6 TDCi	02/11-09/14	T1BA, T1BB, T1BC	1560	25x141		SK-1728	BTK		
1.6 TDCi	02/11-09/14	T1BA, T1BB, T1BC	1560	25x141		SK-1728AQ1	BTKW		
1.6 Ti	03/07-09/14	KGBA, PNBA	1596	22x117; → 09/2010; mit Zubehör		SK-1659	BTK		
1.6 Ti	03/07-09/14	RHBA	1596	22x117; 06/2007 → 09/2010; mit Zubehör		SK-1659	BTK		
1.6 Ti	03/07-09/14	KGBA, PNBA, RHBA	1596	22x117; mit Zubehör		SK-1659AQ1	BTKW		
1.8 TDCi	03/07-09/14	FFBA, KHBA, QYBA	1753	20x91		SK-1341	BTK		
2.0 TDCi	03/07-09/14	AZBA	1997	25.4x116		SK-1594	BTK		
2.0 TDCi	03/07-09/14	QXBB	1997	25.4x116		SK-1594	BTK		
2.0 TDCi	03/07-09/14	AZBC, UKBA, UKBB	1997	25.4x116; → 03/2010		SK-1594	BTK		
2.0 TDCi	03/07-09/14	AZBA, QXBA, QXBB, UFBA, UFBB	1997	25.4x116		SK-1594AQ1	BTKW		
2.0 TDCi	03/07-09/14	AZBC, UKBA, UKBB, KLBA, LPBA, TYBA	1997	25.4x116; Abgasnorm: Euro 4 (D4)		SK-1594AQ1	BTKW		
2.0 TDCi	03/07-09/14	UFBA	1997	25x116		SK-1714	BTK		
2.0 TDCi	03/07-09/14	AZBC, UKBA, UKBB	1997	25x116; 03/2010 →		SK-1714	BTK		
2.0 TDCi	03/07-09/14	UFBA	1997	25x116		SK-1714AQ1	BTKW		
2.0 TDCi	03/07-09/14	AZBC, UKBA, UKBB, KLBA, LPBA, TYBA	1997	25x116; Abgasnorm: Euro 5		SK-1714AQ1	BTKW		
2.0 TDCi	11/07-09/14	KLBA, LPBA	1997	25.4x116		SK-1594	BTK		
2.0 TDCi	11/07-09/14	KLBA, LPBA, TYBA	1997	25x116; Abgasnorm: Euro 5		SK-1714	BTK		
2.0 TDCi	03/10-09/14	TXBA, TXBB	1997	25x116		SK-1714	BTK		
2.0 TDCi	03/10-09/14	TXBA, TXBB	1997	25x116		SK-1714AQ1	BTKW		
2.2 TDCi	03/08-10/10	Q4BA	2179	25.4x118		SK-1692	BTK		
2.2 TDCi	03/08-09/14	KNBA, Q4BA	2179	25.4x118		SK-1692AQ1	BTKW		
2.2 TDCi	07/10-09/14	KNBA	2179	25.4x118; 11/2010 →		SK-1692	BTK		
2.5	03/07-09/14	HUBA	2521	23x142; → 08/2009		SK-1492	BTK		
2.5	03/07-09/14	HUBA	2521	23x142; → 08/2009		SK-1492AQ1	BTKW		
2.5	03/07-09/14	HUBA	2521	23x142; → 08/2009		SK-1666	BTK		
2.5	03/07-09/14	HUBA	2521	23x142; 08/2009 →		SK-1666AQ1	BTKW		
1.6 EcoBoost	02/11-09/14	JTBB	1596			0-N2057	TB [TE]		
1.6 TDCi	02/11-09/14	T1BA, T1BB, T1BC	1560			0-N2224	TB [TE]		
1.6 TDCi	02/11-09/14	T1BA, T1BB, T1BC	1560			0-N2382	TB [DG]		
1.6 Ti	03/07-09/14	KGBA, PNBA, RHBA	1596			0-N1564	TB [TE]		
1.8 TDCi	03/07-09/14	FFBA, KHBA, QYBA	1753			0-N1367	TB [TE]		
2.0 TDCi	03/07-09/14	AZBA, AZBC, UKBA, UKBB, KLBA, LPBA, TYBA, QXBA, QXBB, UFBA, UFBB, TXBA, TXBB	1997			0-N1334	TB [DG]		
2.0 TDCi	03/10-09/14	TXBA, TXBB	1997			0-N2063	TB [TE]		
2.2 TDCi	03/08-09/14	KNBA, Q4BA	2179			0-N1334	TB [DG]		
2.2 TDCi	03/08-09/14	KNBA, Q4BA	2179			0-N2018	TB [BT]		
2.5	03/07-09/14	HUBA	2521			0-N958	TB [DG]		
1.6 EcoBoost	02/11-09/14	JTBB	1596			0-N2269	VB [BT]	S	
1.6 EcoBoost	02/11-09/14	JTBB	1596			0-N2363	VB [DG]		
1.6 TDCi	02/11-09/14	T1BA, T1BB, T1BC	1560			0-N1339	VB [BT]	S	
1.6 TDCi	02/11-09/14	T1BA, T1BB, T1BC	1560			0-N1418	VB [DG]		
1.8 TDCi	03/07-09/14	FFBA, KHBA, QYBA	1753			0-N1622	VB [DG]		
1.8 TDCi	03/07-09/14	FFBA, KHBA, QYBA	1753			0-N1797	VB [BT]	S	
2.0 TDCi	03/07-09/14	AZBA, AZBC, UKBA, UKBB, KLBA, LPBA, TYBA, QXBA, QXBB, UFBA, UFBB	1997			0-N1327	VB [BT]		
2.0 TDCi	03/07-09/14	AZBA, AZBC, UKBA, UKBB, KLBA, LPBA, TYBA, QXBA, QXBB, UFBA, UFBB	1997			0-N1991	VB [DG]		
2.0 TDCi	03/07-09/14	AZBA, AZBC, UKBA, UKBB, KLBA, LPBA, TYBA, QXBA, QXBB, UFBA, UFBB, TXBA, TXBB	1997			0-N2042	VB [BT]	S	
2.0 TDCi	03/07-09/14	AZBA, AZBC, UKBA, UKBB, KLBA, LPBA, TYBA, QXBA, QXBB, UFBA, UFBB	1997	04/2012 →		0-N2396	VB [BT]	S	
2.0 TDCi	03/10-09/14	TXBA, TXBB	1997	→ 04/2012		0-N1991	VB [DG]		
2.0 TDCi	03/10-09/14	TXBA, TXBB	1997			0-N2396	VB [BT]	S	
2.0, 2.0 Flexifuel, 2.0 LPG	03/07-09/14	AOBA, AOBC, TBBA, TBBA, TBBA, TBBB	1999	Rippenanzahl: 6		0-N1497	VB [BT]	S	
2.0, 2.0 Flexifuel, 2.0 LPG	03/07-09/14	AOBA, AOBC, TBBA, TBBA, TBBA, TBBB	1999			0-N1991	VB [DG]		
2.2 TDCi	03/08-09/14	KNBA, Q4BA	2179			0-N1963	VB [DG]		



OPTIMAL®

FORD



CM³



Art. Nr.



MONDEO IV (BA7)

2.2 TDCi	03/08-09/14	KNBA, Q4BA	2179		0-N2042	VB [BT]	S
2.3	07/07-09/14	SEBA	2261	Rippenanzahl: 6	0-N1497	VB [BT]	S
2.3	07/07-09/14	SEBA	2261		0-N1702	VB [DG]	
2.5	03/07-09/14	HUBA	2521		0-N1964	VB [BT]	S

MONDEO IV Stufenheck (BA7)

1.6 TDCi	12/10-09/14	T1BA, T1BB, T1BC	1560	25x141	SK-1728	BTK	
1.6 TDCi	12/10-09/14	T1BA, T1BB, T1BC	1560	25x141	SK-1728AQ1	BTKW	
1.6 Ti	03/07-09/14	PNBA, RHBA	1596	22x117; → 09/2010; mit Zubehör	SK-1659	BTK	
1.6 Ti	03/07-09/14	PNBA, RHBA	1596	22x117; mit Zubehör	SK-1659AQ1	BTKW	
1.8 TDCi	03/07-09/14	FFBA	1753	20x91; 09/2007 →	SK-1341	BTK	
1.8 TDCi	06/07-09/14	KHBA, QYBA	1753	20x91	SK-1341	BTK	
2.0 TDCi	03/07-09/14	AZBA	1997	25.4x116	SK-1594	BTK	
2.0 TDCi	03/07-09/14	QXBB	1997	25.4x116	SK-1594	BTK	
2.0 TDCi	03/07-09/14	AZBA, QXBA, QXBB, UFBA, UFBB	1997	25.4x116	SK-1594AQ1	BTKW	
2.0 TDCi	03/07-09/14	UFBA	1997	25x116	SK-1714	BTK	
2.0 TDCi	03/07-09/14	UFBA	1997	25x116	SK-1714AQ1	BTKW	
2.0 TDCi	11/07-09/14	KLBA	1997	25.4x116	SK-1594	BTK	
2.0 TDCi	11/07-09/14	KLBA, LPBA, TYBA	1997	25.4x116; Abgasnorm: Euro 4 (D4)	SK-1594AQ1	BTKW	
2.0 TDCi	11/07-09/14	KLBA, LPBA, TYBA	1997	25x116; Abgasnorm: Euro 5	SK-1714	BTK	
2.0 TDCi	11/07-09/14	KLBA, LPBA, TYBA	1997	25x116; Abgasnorm: Euro 5	SK-1714AQ1	BTKW	
2.0 TDCi	03/10-09/14	TXBA, TXBB	1997	25x116	SK-1714	BTK	
2.0 TDCi	03/10-09/14	TXBA, TXBB	1997	25x116	SK-1714AQ1	BTKW	
2.2 TDCi	03/08-10/10	Q4BA	2179	25.4x118	SK-1692	BTK	
2.2 TDCi	03/08-10/10	Q4BA	2179	25.4x118	SK-1692AQ1	BTKW	
2.5	03/07-09/14	HUBA	2521	23x142; → 08/2009	SK-1492	BTK	
2.5	03/07-09/14	HUBA	2521	23x142; → 08/2009	SK-1492AQ1	BTKW	
2.5	03/07-09/14	HUBA	2521	23x142; → 08/2009	SK-1666	BTK	
2.5	03/07-09/14	HUBA	2521	23x142; 08/2009 →	SK-1666AQ1	BTKW	
1.6 TDCi	12/10-09/14	T1BA, T1BB, T1BC	1560		0-N2382	TB [DG]	
1.6 Ti	03/07-09/14	PNBA, RHBA	1596		0-N1564	TB [TE]	
1.8 TDCi	03/07-09/14	FFBA, KHBA, QYBA	1753		0-N1367	TB [TE]	
2.0 TDCi	03/07-09/14	AZBA, KLBA, LPBA, TYBA, QXBA, QXBB, UFBA, UFBB, TXBA, TXBB	1997		0-N1334	TB [DG]	
2.0 TDCi	03/10-09/14	TXBA, TXBB	1997		0-N2063	TB [TE]	
2.2 TDCi	03/08-10/10	Q4BA	2179		0-N1334	TB [DG]	
2.2 TDCi	03/08-10/10	Q4BA	2179		0-N2018	TB [BT]	
2.5	03/07-09/14	HUBA	2521		0-N958	TB [DG]	
1.6 TDCi	12/10-09/14	T1BA, T1BB, T1BC	1560		0-N1339	VB [BT]	S
1.8 TDCi	03/07-09/14	FFBA, KHBA, QYBA	1753		0-N1622	VB [DG]	
1.8 TDCi	03/07-09/14	FFBA, KHBA, QYBA	1753		0-N1797	VB [BT]	S
2.0 TDCi	03/07-09/14	AZBA, KLBA, LPBA, TYBA, QXBA, QXBB, UFBA, UFBB	1997		0-N1327	VB [BT]	
2.0 TDCi	03/07-09/14	AZBA, KLBA, LPBA, TYBA, QXBA, QXBB, UFBA, UFBB	1997		0-N1991	VB [DG]	
2.0 TDCi	03/07-09/14	AZBA, KLBA, LPBA, TYBA, QXBA, QXBB, UFBA, UFBB	1997		0-N2042	VB [BT]	S
2.0 TDCi	03/07-09/14	AZBA, KLBA, LPBA, TYBA, QXBA, QXBB, UFBA, UFBB	1997	04/2012 →	0-N2396	VB [BT]	S
2.0 TDCi	03/10-09/14	TXBA, TXBB	1997		0-N2396	VB [BT]	S
2.0, 2.0 Flexifuel, 2.0 LPG	03/07-09/14	AOBA, AOBC, TBBA, TBBA, TBBA, TBBB	1999	Rippenanzahl: 6	0-N1497	VB [BT]	S
2.0, 2.0 Flexifuel, 2.0 LPG	03/07-09/14	AOBA, AOBC, TBBA, TBBA, TBBA, TBBB	1999		0-N1991	VB [DG]	
2.2 TDCi	03/08-10/10	Q4BA	2179		0-N1963	VB [DG]	
2.2 TDCi	03/08-10/10	Q4BA	2179		0-N2042	VB [BT]	S
2.3	07/07-09/14	SEBA	2261	Rippenanzahl: 6	0-N1497	VB [BT]	S
2.3	07/07-09/14	SEBA	2261		0-N1702	VB [DG]	
2.5	03/07-09/14	HUBA	2521		0-N1964	VB [BT]	S

MONDEO IV Turnier (BA7)

1.6 TDCi	02/11-09/14	T1BA, T1BB, T1BC	1560	25x141	SK-1728	BTK	
1.6 TDCi	02/11-09/14	T1BA, T1BB, T1BC	1560	25x141	SK-1728AQ1	BTKW	
1.6 Ti	03/07-09/14	KGBA, PNBA	1596	22x117; → 09/2010; mit Zubehör	SK-1659	BTK	
1.6 Ti	03/07-12/12	RHBA	1596	22x117; 06/2007 → 09/2010; mit Zubehör	SK-1659	BTK	
1.6 Ti	03/07-09/14	KGBA, PNBA, RHBA	1596	22x117; mit Zubehör	SK-1659AQ1	BTKW	
1.8 TDCi	03/07-12/12	FFBA, KHBA, QYBA	1753	20x91	SK-1341	BTK	
2.0 TDCi	03/07-09/14	QXBB	1997	25.4x116	SK-1594	BTK	
2.0 TDCi	03/07-09/14	AZBC, UKBA, UKBB	1997	25.4x116; → 03/2010	SK-1594	BTK	
2.0 TDCi	03/07-12/12	AZBA	1997	25.4x116	SK-1594	BTK	



CM³



Art. Nr.



ohne Halter

MONDEO IV Turnier (BA7)

2.0 TDCi	03/07-09/14	AZBA, QXBA, QXBB, UFBA, UFBB	1997	25.4x116	SK-1594AQ1	BTKW	
2.0 TDCi	03/07-09/14	AZBC, UKBA, UKBB, KLBA, LPBA, TYBA	1997	25.4x116; Abgasnorm: Euro 4 (D4)	SK-1594AQ1	BTKW	
2.0 TDCi	03/07-09/14	UFBA	1997	25x116	SK-1714	BTK	
2.0 TDCi	03/07-09/14	AZBC, UKBA, UKBB	1997	25x116; 03/2010 →	SK-1714	BTK	
2.0 TDCi	03/07-09/14	UFBA	1997	25x116	SK-1714AQ1	BTKW	
2.0 TDCi	03/07-09/14	AZBC, UKBA, UKBB, KLBA, LPBA, TYBA	1997	25x116; Abgasnorm: Euro 5	SK-1714AQ1	BTKW	
2.0 TDCi	11/07-09/14	KLBA, LPBA	1997	25.4x116	SK-1594	BTK	
2.0 TDCi	11/07-09/14	KLBA, LPBA, TYBA	1997	25x116; Abgasnorm: Euro 5	SK-1714	BTK	
2.0 TDCi	03/10-09/14	TXBA, TXBB	1997	25x116	SK-1714	BTK	
2.0 TDCi	03/10-09/14	TXBA, TXBB	1997	25x116	SK-1714AQ1	BTKW	
2.2 TDCi	03/08-10/10	Q4BA	2179	25.4x118	SK-1692	BTK	
2.2 TDCi	03/08-09/14	KNBA, Q4BA	2179	25.4x118	SK-1692AQ1	BTKW	
2.2 TDCi	07/10-09/14	KNBA	2179	25.4x118; 11/2010 →	SK-1692	BTK	
2.5	03/07-12/12	HUBA	2521	23x142; → 08/2009	SK-1492	BTK	
2.5	03/07-12/12	HUBA	2521	23x142; → 08/2009	SK-1492AQ1	BTKW	
2.5	03/07-12/12	HUBA	2521	23x142; → 08/2009	SK-1666	BTK	
2.5	03/07-12/12	HUBA	2521	23x142; 08/2009 →	SK-1666AQ1	BTKW	
1.6 EcoBoost	02/11-09/14	JTBA	1596		0-N2057	TB [TE]	
1.6 TDCi	02/11-09/14	T1BA, T1BB, T1BC	1560		0-N2224	TB [TE]	
1.6 TDCi	02/11-09/14	T1BA, T1BB, T1BC	1560		0-N2382	TB [DG]	
1.6 Ti	03/07-09/14	KGBA, PNBA, RHBA	1596		0-N1564	TB [TE]	
1.8 TDCi	03/07-12/12	FFBA, KHBA, QYBA	1753		0-N1367	TB [TE]	
2.0 TDCi	03/07-09/14	AZBA, AZBC, UKBA, UKBB, KLBA, LPBA, TYBA, QXBA, QXBB, UFBA, UFBB, TXBA, TXBB	1997		0-N1334	TB [DG]	
2.0 TDCi	03/10-09/14	TXBA, TXBB	1997		0-N2063	TB [TE]	
2.2 TDCi	03/08-09/14	KNBA, Q4BA	2179		0-N1334	TB [DG]	
2.2 TDCi	03/08-09/14	KNBA, Q4BA	2179		0-N2018	TB [BT]	
2.5	03/07-12/12	HUBA	2521		0-N958	TB [DG]	
1.6 EcoBoost	02/11-09/14	JTBA	1596		0-N2269	VB [BT]	S
1.6 EcoBoost	02/11-09/14	JTBA	1596		0-N2363	VB [DG]	
1.6 TDCi	02/11-09/14	T1BA, T1BB, T1BC	1560		0-N1339	VB [BT]	S
1.6 TDCi	02/11-09/14	T1BA, T1BB, T1BC	1560		0-N1418	VB [DG]	
1.8 TDCi	03/07-12/12	FFBA, KHBA, QYBA	1753		0-N1622	VB [DG]	
1.8 TDCi	03/07-12/12	FFBA, KHBA, QYBA	1753		0-N1797	VB [BT]	S
2.0 TDCi	03/07-09/14	AZBA, AZBC, UKBA, UKBB, KLBA, LPBA, TYBA, QXBA, QXBB, UFBA, UFBB	1997		0-N1327	VB [BT]	
2.0 TDCi	03/07-09/14	AZBA, AZBC, UKBA, UKBB, KLBA, LPBA, TYBA, QXBA, QXBB, UFBA, UFBB	1997		0-N1991	VB [DG]	
2.0 TDCi	03/07-09/14	AZBA, AZBC, UKBA, UKBB, KLBA, LPBA, TYBA, QXBA, QXBB, UFBA, UFBB, TXBA, TXBB	1997		0-N2042	VB [BT]	S
2.0 TDCi	03/07-09/14	AZBA, AZBC, UKBA, UKBB, KLBA, LPBA, TYBA, QXBA, QXBB, UFBA, UFBB	1997	04/2012 →	0-N2396	VB [BT]	S
2.0 TDCi	03/10-09/14	TXBA, TXBB	1997	→ 04/2012	0-N1991	VB [DG]	
2.0 TDCi	03/10-09/14	TXBA, TXBB	1997		0-N2396	VB [BT]	S
2.0, 2.0 Flexifuel, 2.0 LPG	03/07-09/14	AOBA, AOBC, TBBA, TBBA, TBBA, TBBB	1999	Rippenanzahl: 6	0-N1497	VB [BT]	S
2.0, 2.0 Flexifuel, 2.0 LPG	03/07-09/14	AOBA, AOBC, TBBA, TBBA, TBBA, TBBB	1999		0-N1991	VB [DG]	
2.2 TDCi	03/08-09/14	KNBA, Q4BA	2179		0-N1963	VB [DG]	
2.2 TDCi	03/08-09/14	KNBA, Q4BA	2179		0-N2042	VB [BT]	S
2.3	07/07-09/14	SEBA	2261	Rippenanzahl: 6	0-N1497	VB [BT]	S
2.3	07/07-09/14	SEBA	2261		0-N1702	VB [DG]	
2.5	03/07-12/12	HUBA	2521		0-N1964	VB [BT]	S

MONDEO V Schrägheck

1.6 TDCi	09/14-	NGCA, U3CA	1560	25x141	SK-1728	BTK	
1.6 TDCi	09/14-	NGCA, U3CA	1560	25x141	SK-1728AQ1	BTKW	
1.5 EcoBoost	09/14-	UNCA, UNCB, UNCE, UNCF	1499		0-N2057	TB [TE]	
1.5 TDCi	03/15-	UGCC, XUCA	1499		0-N2382	TB [DG]	
1.6 TDCi	09/14-	NGCA, U3CA	1560		0-N2382	TB [DG]	
1.5 EcoBoost	09/14-	UNCA, UNCB, UNCE, UNCF	1499		0-N2363	VB [DG]	

MONDEO V Turnier

1.6 TDCi	09/14-	NGCA, U3CA	1560	25x141	SK-1728	BTK	
1.6 TDCi	09/14-	NGCA, U3CA	1560	25x141	SK-1728AQ1	BTKW	
1.5 EcoBoost	09/14-	UNCA, UNCB, UNCE, UNCF	1499		0-N2057	TB [TE]	
1.5 TDCi	03/15-	UGCC, XUCA	1499		0-N2382	TB [DG]	
1.6 TDCi	09/14-	NGCA, U3CA	1560		0-N2382	TB [DG]	



CM³



Art. Nr.



ohne Halter

MONDEO V Turnier							
1.5 EcoBoost	09/14-	UNCA, UNCB, UNCE, UNCF	1499			0-N2363	VB [DG]
ORION I (AFD)							
1.6 D	02/84-03/86	LTA	1608	19.05x98		SK-1039	BTK
1.6, 1.6 i	07/83-03/86	LP1, LPA, LR1, LRA	1597	19x97		SK-1027	BTK
1.6 D	02/84-03/86	LTA	1608			0-N838	TB [TE]
1.6, 1.6 i	07/83-03/86	LP1, LPA, LR1, LRA	1597			0-N837	TB [TE]
1.3	07/83-03/86	JPA	1296	mit Anbaumaterial		0-N197	VB [DG]
1.6, 1.6 i	07/83-03/86	LP1, LPA, LR1, LRA	1597	mit Anbaumaterial		0-N197	VB [DG]
ORION II (AFF)							
1.4	01/86-07/90	FUC	1392	19x97; 04/1987 →		SK-1027	BTK
1.4, 1.4 KAT	12/85-07/90	F6B, F6D, FUA, FUA A	1392	19x97		SK-1027	BTK
1.6 D	12/85-01/89	LTC	1608	19.05x98; 03/1986 →		SK-1039	BTK
1.6, 1.6 i, 1.6 i KAT	12/85-08/90	L4B, LJB, LRB, LUC, LUG	1597	19x97		SK-1027	BTK
1.8 D	01/89-07/90	RTA, RTB	1753	20x116; 22x85; mit Zubehör		SK-1041	BTK
1.4, 1.4 KAT	12/85-07/90	F6B, F6D, FUA, FUA A, FUC	1392			0-N837	TB [TE]
1.6 D	12/85-01/89	LTC	1608			0-N838	TB [TE]
1.6, 1.6 i, 1.6 i KAT	12/85-07/90	L4B, LJB, LRB, LUC	1597			0-N837	TB [TE]
1.8 D	01/89-07/90	RTA, RTB	1753			0-N874	TB [TE]
1.8 D	01/89-07/90	RTA, RTB	1753			0-N902	TB [DG]
1.8 D	01/89-07/90	RTA, RTB	1753			0-N915	TB [TE]
1.4, 1.4 KAT	12/85-07/90	F6B, F6D, FUA, FUA A, FUC	1392	mit Anbaumaterial		0-N197	VB [DG]
1.6, 1.6 i, 1.6 i KAT	12/85-07/90	L4B, LJB, LRB, LUC	1597	mit Anbaumaterial		0-N197	VB [DG]
ORION III (GAL)							
1.4	07/90-12/93	F6F, F6G	1391	19x97; → 04/1992		SK-1027	BTK
1.4	07/90-12/93	FUH	1392	19x97; → 04/1992		SK-1027	BTK
1.4	07/90-12/93	F6F, F6G	1391	21x97; 04/1992 →		SK-1053	BTK
1.4	07/90-12/93	FUH	1392	21x97; 04/1992 →		SK-1053	BTK
1.4	07/90-12/93	F6F, F6G	1391	21.6x97; 04/1992 →		SK-1053AQ1	BTKW
1.4	07/90-12/93	FUH	1392	21.6x97; 04/1992 →		SK-1053AQ1	BTKW
1.6	07/90-12/92	LUK	1598	19x97; → 04/1992		SK-1027	BTK
1.6	07/90-12/92	LUK	1598	25x131; mit Zubehör; Baumuster: GAL		SK-1094	BTK
1.6 i	07/90-09/92	LJF	1598	19x97; → 04/1992		SK-1027	BTK
1.6 i	07/90-09/92	LJF	1598	21x97; 04/1992 →		SK-1053	BTK
1.6 i	07/90-09/92	LJF	1598	21.6x97; 04/1992 →		SK-1053AQ1	BTKW
1.6 i 16V	07/92-12/93	L1E, L1K	1597	25x131; mit Zubehör; Baumuster: GAL		SK-1094	BTK
1.6 i 16V	07/92-12/93	L1E, L1K	1597	25x131		SK-1094AQ1	BTKW
1.8 D	11/90-12/93	RTE, RTF, RTH	1753	20x116; 22x85; mit Zubehör		SK-1041	BTK
1.8 i 16V	01/92-12/93	RDA, RQB	1796	25x131; mit Zubehör; Baumuster: GAL		SK-1094	BTK
1.8 i 16V	01/92-12/93	RDA, RQB	1796	25x131		SK-1094AQ1	BTKW
1.8 TD	03/92-12/93	RFD, RFK	1753	20x116; 22x85; 09/1992 →; mit Zubehör		SK-1041	BTK
1.4	07/90-12/93	F6F, F6G	1391			0-N837	TB [TE]
1.4	07/90-12/93	FUH	1392			0-N837	TB [TE]
1.6 i 16V	07/92-12/93	L1E, L1K	1597			0-N096	TB [DG]
1.6 i 16V	07/92-12/93	L1E, L1K	1597			0-N903	TB [TE]
1.6 i 16V	07/92-12/93	L1E, L1K	1597			0-N904	TB [DG]
1.6, 1.6 i	07/90-12/92	LJF, LUJ, LUK	1598			0-N837	TB [TE]
1.8 D, 1.8 TD	11/90-12/93	RFD, RFK, RTE, RTF, RTH	1753			0-N874	TB [TE]
1.8 D, 1.8 TD	11/90-12/93	RFD, RFK, RTE, RTF, RTH	1753			0-N902	TB [DG]
1.8 D, 1.8 TD	11/90-12/93	RFD, RFK, RTE, RTF, RTH	1753			0-N915	TB [TE]
1.8 i 16V	01/92-12/93	RDA, RQB	1796			0-N096	TB [DG]
1.8 i 16V	01/92-12/93	RDA, RQB	1796			0-N903	TB [TE]
1.8 i 16V	01/92-12/93	RDA, RQB	1796			0-N904	TB [DG]
1.4	07/90-12/93	F6F, F6G	1391	mit Anbaumaterial		0-N197	VB [DG]
1.4	07/90-12/93	FUH	1392	mit Anbaumaterial; ⚠, für Fahrzeuge mit Servolenkung		0-N197	VB [DG]
1.6	07/90-12/92	LUJ, LUK	1598	mit Anbaumaterial; ⚠, für Fahrzeuge mit Servolenkung		0-N197	VB [DG]
1.6 i 16V	07/92-12/93	L1E, L1K	1597	→ 07/1993		0-N1401	VB [DG]
1.8 i 16V	01/92-12/93	RDA, RQB	1796	→ 07/1993		0-N1401	VB [DG]
P 100 II							
1.8 TD	10/87-12/92	RFA	1753	20x116; 22x85; mit Zubehör		SK-1041	BTK
1.8 TD	10/87-12/92	RFA	1753			0-N874	TB [TE]
1.8 TD	10/87-12/92	RFA	1753			0-N902	TB [DG]
1.8 TD	10/87-12/92	RFA	1753			0-N915	TB [TE]



CM³



Art. Nr.



PUMA (EC_)							
1.4 16V	11/97-10/00	FHD, FHF	1388	22x117; mit Zubehör	SK-1077	BTK	
1.4 16V	11/97-10/00	FHD, FHF	1388	22x117; mit Zubehör	SK-1077AQ1	BTKW	
1.6 16V	08/00-06/02	L1W	1596	22x117; mit Zubehör	SK-1077	BTK	
1.6 16V	08/00-06/02	L1W	1596	22x117; mit Zubehör	SK-1077AQ1	BTKW	
1.7 16V, ST 160	03/97-06/02	MHA, MHB	1679	22x117	SK-1754	BTK	
1.4 16V	11/97-10/00	FHD, FHF	1388		0-N294	TB [TE]	
1.6 16V	08/00-06/02	L1W	1596		0-N294	TB [TE]	
1.7 16V	03/97-06/02	MHA, MHB	1679	06/1997 → 12/2001	0-N2220	TB [TE]	S
1.4 16V	11/97-10/00	FHD, FHF	1388		0-N1385	VB [DG]	
1.4 16V	11/97-10/00	FHD, FHF	1388	Rippenanzahl: 6; für Fahrzeuge mit Servolenkung, ☼	0-N1897	VB [BT]	S
1.4 16V	11/97-10/00	FHD, FHF	1388	Rippenanzahl: 6; ☼, für Fahrzeuge ohne Servolenkung	0-N1897	VB [BT]	S
1.4 16V	11/97-10/00	FHD, FHF	1388	Rippenanzahl: 6; ☼, für Fahrzeuge ohne Servolenkung	0-N1897	VB [BT]	S
1.4 16V	11/97-10/00	FHD, FHF	1388	☼	0-N1903	VB [BT]	S
1.6 16V	08/00-06/02	L1W	1596		0-N1385	VB [DG]	
1.6 16V	08/00-06/02	L1W	1596	Rippenanzahl: 6; ☼	0-N1897	VB [BT]	S
1.6 16V	08/00-06/02	L1W	1596	☼	0-N1903	VB [BT]	S
1.7 16V	03/97-06/02	MHA, MHB	1679	06/1997 → 12/2001	0-N1385	VB [DG]	
1.7 16V	03/97-06/02	MHA, MHB	1679	06/1997 → 12/2001; Rippenanzahl: 6; ☼, für Fahrzeuge mit Servolenkung	0-N1796	VB [BT]	S
1.7 16V	03/97-06/02	MHA, MHB	1679	Rippenanzahl: 6; ☼	0-N1897	VB [BT]	S
ST 160	06/99-06/02		1679	→ 12/2001	0-N1385	VB [DG]	
ST 160	06/99-06/02		1679	→ 08/2001; Rippenanzahl: 6; ☼	0-N1897	VB [BT]	S
RANGER (ES, ET)							
2.5 TDCi 4x4, 2.5 TDdi	05/06-07/12	WLAA	2499		0-N1666	TB [BT]	
2.5 TDdi	05/06-07/12	WLAA	2499	Nockenwelle: SOHC/OHC	0-N2225	TB [TE]	
3.0 TDCi, 3.0 TDCi 4x4	05/06-07/12	WEAT	2953		0-N1666	TB [BT]	
RANGER (TKE)							
2.5 i 4x4	11/11-	GBVAF, GBVAK, GBVAL	2488		0-N1991	VB [DG]	
RANGER (ER, EQ)							
2.2	03/02-09/05		2184	25x110	SK-1226	BTK	
2.5 D, 2.5 D 4x4, 2.5 TD, 2.5 TD 4x4	10/99-06/06	WL, WL-T	2500	30x101	SK-1750	BTK	
2.5 TDdi, 2.5 TDdi 4x4	04/02-09/05		2499	30x101	SK-1750	BTK	
2.5 D, 2.5 D 4x4, 2.5 TD, 2.5 TD 4x4	10/99-06/06	WL, WL-T	2500		0-N2225	TB [TE]	
2.5 TDdi	04/02-09/05		2499		0-N2225	TB [TE]	
2.5 TDdi 4x4	04/02-09/05		2499	☼: → 102007	0-N2225	TB [TE]	
SCORPIO I (GAE, GGE)							
1.8	04/85-02/92	REC	1796		0-N839	TB [TE]	
2.0	04/85-08/89	NEL	1993		0-N839	TB [TE]	
2.0 i	04/85-09/94	NRA, NRI, NRC	1993		0-N839	TB [TE]	
2.0	04/85-08/89	N8D, NEL	1993	☼	0-N1401	VB [DG]	
2.0	11/88-10/92	N8A	1998	☼	0-N1401	VB [DG]	
2.0 i	05/89-09/94	N9D	1998	05/1993 →; ☼	0-N1401	VB [DG]	
2.5 D	12/85-02/92	STR	2498		0-N1644	VB [DG]	
2.5 TD	06/88-07/93	SFA	2498		0-N1644	VB [DG]	
2.5 TD	06/88-07/93	SFA, SFB	2498		0-N2156	VB [DG]	
2.5 TD	06/88-07/93	SFA, SFB	2498		0-N2157	VB [VD]	
2.5 TD	08/93-09/94	SCB	2500		0-N2156	VB [DG]	
2.5 TD	08/93-09/94	SCB	2500		0-N2157	VB [VD]	
SCORPIO I Stufenheck (GGE)							
2.0	06/89-03/93	N8B	1998	☼	0-N1401	VB [DG]	
2.0 i	05/89-09/94	N9D, N9F	1998	05/1993 →; ☼	0-N1401	VB [DG]	
2.5 D	12/89-12/94	STR	2498		0-N1644	VB [DG]	
2.5 TD	06/88-07/93	SFA	2498		0-N1644	VB [DG]	
2.5 TD	06/88-07/93	SFA, SFB	2498		0-N2156	VB [DG]	
2.5 TD	06/88-07/93	SFA, SFB	2498		0-N2157	VB [VD]	
2.5 TD	08/93-09/94	SCB	2500		0-N2156	VB [DG]	
2.5 TD	08/93-09/94	SCB	2500		0-N2157	VB [VD]	
SCORPIO I Kombi (GGE)							
2.0 i	09/91-09/94	N9D, N9F	1998	05/1993 →; ☼	0-N1401	VB [DG]	
2.5 TD	09/91-07/93	SFA, SFB	2498		0-N2156	VB [DG]	
2.5 TD	09/91-07/93	SFA, SFB	2498		0-N2157	VB [VD]	



CM³



Art. Nr.



SCORPIO I Kombi (GGE)

2.5 TD	08/93-09/94	SCB	2500			0-N2156	VB [DG]
2.5 TD	08/93-09/94	SCB	2500			0-N2157	VB [VD]

SCORPIO II (GFR, GGR)

2.0 i, 2.0 i 16V	10/94-08/98	N3A, NSD	1998	☼		0-N1401	VB [DG]
2.0 i, 2.0 i 16V	10/94-08/98	N3A, NSD	1998			0-N1557S	VB [TE]
2.3 i 16V	06/96-08/98	Y5A	2295	☼		0-N1401	VB [DG]
2.3 i 16V	06/96-08/98	Y5A	2295			0-N1557S	VB [TE]
2.5 TD	10/94-08/98	SCC	2500		→ 09/1996	0-N2156	VB [DG]
2.5 TD	10/94-08/98	SCC	2500			0-N2157	VB [VD]

SCORPIO II Kombi (GNR, GGR)

2.0 i, 2.0 i 16V	10/94-08/98	N3A, NSD	1998	☼		0-N1401	VB [DG]
2.0 i, 2.0 i 16V	10/94-08/98	N3A, NSD	1998			0-N1557S	VB [TE]
2.3 i 16V	06/96-08/98	Y5A	2295	☼		0-N1401	VB [DG]
2.3 i 16V	06/96-08/98	Y5A	2295			0-N1557S	VB [TE]
2.5 TD	10/94-08/98	SCC	2500		→ 09/1996	0-N2156	VB [DG]
2.5 TD	10/94-08/98	SCC	2500			0-N2157	VB [VD]

SIERRA Schrägheck (GBC)

1.3	08/82-12/86	JCT	1294	19.05x119		SK-1160	BTK
1.6	08/82-02/87	LCS, LCT, LSD	1593	19.05x119		SK-1160	BTK
1.6	08/84-12/86	LSD	1597	19.05x119		SK-1160	BTK
1.3	08/82-12/86	JCT	1294			0-N839	TB [TE]
1.6	08/82-12/86	LCS, LCT, LSD	1593			0-N839	TB [TE]
1.8	10/84-12/86	REB	1796			0-N839	TB [TE]
2.0	08/82-10/84	NYT	1999			0-N839	TB [TE]
2.0, 2.0 i	08/82-12/86	NET, NR2, NRB, NRD	1993			0-N839	TB [TE]

SIERRA Kombi (BNC)

1.6	08/82-12/86	LCS, LCT, LSD	1593	19.05x119		SK-1160	BTK
1.6	08/82-12/86	LCS, LCT, LSD	1593			0-N839	TB [TE]
1.8	10/84-12/86	REB	1796			0-N839	TB [TE]
2.0	08/82-10/84	NYT	1999			0-N839	TB [TE]
2.0	08/82-12/86	NET, NR2, NRB, NRD	1993			0-N839	TB [TE]

SIERRA (GBG, GB4)

1.6	01/87-02/93	LSE, LSF	1597	19x97; → 04/1992		SK-1027	BTK
1.6 i	10/89-02/93	L6B	1597	19x97; 10/1991 → 04/1992		SK-1027	BTK
1.6 i	10/89-02/93	L6B	1597	21x97; 04/1992 →		SK-1053	BTK
1.6 i	10/89-02/93	L6B	1597	21x97; 04/1992 →; Baumuster: Sapphire		SK-1053	BTK
1.6 i	10/89-02/93	L6B	1597	21.6x97; 04/1992 →		SK-1053AQ1	BTKW
1.6 i	10/89-02/93	L6B	1597	21.6x97; 04/1992 →; Baumuster: Sapphire		SK-1053AQ1	BTKW
1.8 TD	08/88-02/93	RFB	1753	20x116; 22x85; 10/1989 →; mit Zubehör		SK-1041	BTK
1.6, 1.6 i	01/87-02/93	L6B, LSE, LSF	1597			0-N837	TB [TE]
1.6, 1.6 i	01/87-02/93	L6B, LSE, LSF	1597			0-N839	TB [TE]
1.8	01/87-05/88	R2A	1796			0-N1246	TB [TE]
1.8	01/87-09/89	R2A, RED, RED, REF	1796			0-N839	TB [TE]
1.8	05/88-02/93	R2C	1769			0-N1246	TB [TE]
1.8	05/88-02/93	R2C, R6A	1769			0-N839	TB [TE]
1.8 TD	08/88-02/93	RFA, RFB, RFL	1753			0-N1214	TB [DG]
1.8 TD	08/88-02/93	RFA, RFB, RFL	1753			0-N874	TB [TE]
1.8 TD	08/88-02/93	RFA, RFB, RFL	1753			0-N902	TB [DG]
1.8 TD	08/88-02/93	RFA, RFB, RFL	1753			0-N915	TB [TE]
2.0 4x4, 2.0 i	01/90-02/93	N9C	1998			0-N839	TB [TE]
2.0, 2.0 i, 2.0 i KAT	01/87-02/93	N4A, N4I, N4B, N8C, NES, NE5, NEJ	1993			0-N839	TB [TE]
1.8 TD	08/88-02/93	RFA, RFB, RFL	1753			0-N155	VB [TE]
1.8 TD	08/88-02/93	RFA, RFB, RFL	1753			0-N156	VB [TE]

SIERRA Schrägheck (GBC, GBG)

1.6	01/87-02/93	LSE, LSF	1597	19x97; → 04/1992		SK-1027	BTK
1.6 i	10/89-02/93	L6B	1598	19x97; → 04/1992		SK-1027	BTK
1.6 i	10/89-02/93	L6B	1598	21x97; 04/1992 →		SK-1053	BTK
1.6 i	10/89-02/93	L6B	1598	21.6x97; 04/1992 →		SK-1053AQ1	BTKW
1.8 TD	08/88-02/93	RFA, RFB, RFL	1753	20x116; 22x85; 10/1989 →; mit Zubehör		SK-1041	BTK
1.6	01/87-02/93	LSE, LSF	1597			0-N837	TB [TE]
1.6	01/87-02/93	LSE, LSF	1597			0-N839	TB [TE]
1.6 i	10/89-02/93	L6B	1598			0-N837	TB [TE]
1.6 i	10/89-02/93	L6B	1598			0-N839	TB [TE]

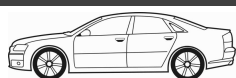

CM³



Art. Nr.

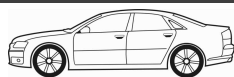

SIERRA Schrägheck (GBC, GBG)							
1.8	01/87-05/88	R2A	1796		0-N1246	TB [TE]	
1.8	01/87-05/88	R2A, RED, RED, REF	1796		0-N839	TB [TE]	
1.8	05/88-02/93	R2C	1769		0-N1246	TB [TE]	
1.8	05/88-02/93	R2C, R6A	1769		0-N839	TB [TE]	
1.8 TD	08/88-02/93	RFA, RFB, RFL	1753		0-N1214	TB [DG]	
1.8 TD	08/88-02/93	RFA, RFB, RFL	1753		0-N874	TB [TE]	
1.8 TD	08/88-02/93	RFA, RFB, RFL	1753		0-N902	TB [DG]	
1.8 TD	08/88-02/93	RFA, RFB, RFL	1753		0-N915	TB [TE]	
2.0 16V Cosworth 4x4, 2.0 16V Cosworth 4x4 KAT, 2.0 RS Cosworth	11/87-02/93	N5B, N5C, N5D	1993		0-N1779	TB [BT]	
2.0 i	06/89-02/93	N9B, N9C	1998		0-N839	TB [TE]	
2.0, 2.0 i, 2.0 i KAT	01/87-02/93	N4A, N4I, N4B, N8C, NES, NE5, NEJ	1993		0-N839	TB [TE]	
1.8 TD	08/88-02/93	RFA, RFB, RFL	1753		0-N155	VB [TE]	
1.8 TD	08/88-02/93	RFA, RFB, RFL	1753		0-N156	VB [TE]	
SIERRA Kombi (BNG)							
1.6	01/87-02/93	LSE, LSF	1597	19x97; → 04/1992	SK-1027	BTK	
1.6 i	10/89-02/93	L6B	1598	19x97; → 04/1992	SK-1027	BTK	
1.6 i	10/89-02/93	L6B	1598	21x97; 04/1992 →	SK-1053	BTK	
1.6 i	10/89-02/93	L6B	1598	21.6x97; 04/1992 →	SK-1053AQ1	BTKW	
1.8 TD	08/88-02/93	RFA, RFB, RFL	1753	20x116; 22x85; 10/1989 →; mit Zubehör	SK-1041	BTK	
1.6	01/87-02/93	LSE, LSF	1597		0-N837	TB [TE]	
1.6	01/87-02/93	LSE, LSF	1597		0-N839	TB [TE]	
1.6 i	10/89-02/93	L6B	1598		0-N837	TB [TE]	
1.6 i	10/89-02/93	L6B	1598		0-N839	TB [TE]	
1.8	01/87-05/88	R2A	1796		0-N1246	TB [TE]	
1.8	01/87-05/88	R2A, RED, RED, REF	1796		0-N839	TB [TE]	
1.8	05/88-02/93	R2C	1769		0-N1246	TB [TE]	
1.8	05/88-02/93	R2C, R6A	1769		0-N839	TB [TE]	
1.8 TD	08/88-02/93	RFA, RFB, RFL	1753		0-N1214	TB [DG]	
1.8 TD	08/88-02/93	RFA, RFB, RFL	1753		0-N874	TB [TE]	
1.8 TD	08/88-02/93	RFA, RFB, RFL	1753		0-N902	TB [DG]	
1.8 TD	08/88-02/93	RFA, RFB, RFL	1753		0-N915	TB [TE]	
2.0 4x4, 2.0 i	05/89-02/93	N9C	1998		0-N839	TB [TE]	
2.0, 2.0 i, 2.0 i KAT	01/87-02/93	N4A, N4I, N4B, N8C, NES, NE5, NEJ	1993		0-N839	TB [TE]	
1.8 TD	08/88-02/93	RFA, RFB, RFL	1753		0-N155	VB [TE]	
1.8 TD	08/88-02/93	RFA, RFB, RFL	1753		0-N156	VB [TE]	
S-MAX (WA6)							
1.6 TDCi	02/11-	T1WA, T1WB	1560	25x141	SK-1728	BTK	
1.6 TDCi	02/11-	T1WA, T1WB	1560	25x141	SK-1728AQ1	BTKW	
1.8 TDCi	05/06-	FFWA, QYWA	1753	20x91	SK-1341	BTK	
2.0 TDCi	05/06-	AZWC, UKWA	1997	25.4x116; 03/2008 →	SK-1594	BTK	
2.0 TDCi	05/06-	AZWA, KLWA, TYWA, QXWA, QXWB, QXWC, UFWA	1997	25.4x116; Baumuster: BWS	SK-1594	BTK	
2.0 TDCi	05/06-	AZWA, KLWA, TYWA, QXWA, QXWB, QXWC, UFWA	1997	25.4x116	SK-1594AQ1	BTKW	
2.0 TDCi	05/06-	AZWC, UKWA	1997	25.4x116; Abgasnorm: Euro 4 (D4)	SK-1594AQ1	BTKW	
2.0 TDCi	05/06-	AZWC, UKWA, TXWA	1997	25x116	SK-1714	BTK	
2.0 TDCi	05/06-	QXWA, QXWB, QXWC, UFWA	1997	25x116; 03/2010 →	SK-1714	BTK	
2.0 TDCi	05/06-	AZWC, UKWA, QXWA, QXWB, QXWC, UFWA, TXWA	1997	25x116	SK-1714AQ1	BTKW	
2.0 TDCi	11/07-	TYWA	1997	25x116	SK-1714	BTK	
2.0 TDCi	11/07-	TYWA	1997	25x116	SK-1714AQ1	BTKW	
2.2 TDCi	03/08-	Q4WA	2179	25.4x118	SK-1692	BTK	
2.2 TDCi	03/08-	KNWA, Q4WA	2179	25.4x118	SK-1692AQ1	BTKW	
2.2 TDCi	07/10-	KNWA	2179	25.4x118; 11/2010 →	SK-1692	BTK	
2.5 ST	05/06-	HUWA	2521	23x142; → 08/2009	SK-1492	BTK	
2.5 ST	05/06-	HUWA	2521	23x142; → 08/2009	SK-1492AQ1	BTKW	
2.5 ST	05/06-	HUWA	2521	23x142; → 08/2009	SK-1666	BTK	
2.5 ST	05/06-	HUWA	2521	23x142; 08/2009 →	SK-1666AQ1	BTKW	
1.6 EcoBoost	02/11-	JTWA, JTWB	1596		0-N2057	TB [TE]	
1.6 TDCi	02/11-	T1WA, T1WB	1560		0-N2224	TB [TE]	
1.6 TDCi	02/11-	T1WA, T1WB	1560		0-N2382	TB [DG]	
1.8 TDCi	05/06-	FFWA, QYWA	1753		0-N1367	TB [TE]	
2.0 TDCi	05/06-	AZWA, AZWC, UKWA, KLWA, TYWA, QXWA, QXWB, QXWC, UFWA, TXWA	1997		0-N1334	TB [DG]	

CM³

Art. Nr.



S-MAX (WA6)								
2.0 TDCi	05/06-	AZWC, UKWA, QXWA, QXWB, QXWC, UFWA, TXWA	1997				0-N2063	TB [TE]
2.2 TDCi	03/08-	KNWA, Q4WA	2179				0-N1334	TB [DG]
2.2 TDCi	03/08-	KNWA, Q4WA	2179				0-N2018	TB [BT]
2.5 ST	05/06-	HUWA	2521				0-N958	TB [DG]
1.6 EcoBoost	02/11-	JTWA, JTWB	1596				0-N2269	VB [BT] S
1.6 EcoBoost	02/11-	JTWA, JTWB	1596				0-N2363	VB [DG]
1.6 TDCi	02/11-	T1WA, T1WB	1560				0-N1339	VB [BT] S
1.6 TDCi	02/11-	T1WA, T1WB	1560				0-N1418	VB [DG]
1.8 TDCi	05/06-	QYWA	1753				0-N1622	VB [DG]
1.8 TDCi	05/06-	FFWA, QYWA	1753				0-N1797	VB [BT] S
2.0 TDCi	05/06-	AZWA, AZWC, UKWA, KLWA, TYWA, QXWA, QXWB, QXWC, UFWA	1997				0-N1327	VB [BT]
2.0 TDCi	05/06-	AZWA, AZWC, UKWA, KLWA, TYWA, QXWA, QXWB, QXWC, UFWA	1997	03/2010 →			0-N2037	VB [BT] S
2.0 TDCi	11/07-	KLWA, TYWA	1997				0-N1797	VB [BT] S
2.0 TDCi	03/10-	TXWA	1997				0-N2396	VB [BT] S
2.0, 2.0 Flexifuel	05/06-	AOWA, AOWB, TBWA, TBWB	1999	Rippenanzahl: 6			0-N1497	VB [BT] S
2.0, 2.0 Flexifuel	05/06-	AOWA, AOWB, TBWA, TBWB	1999				0-N1991	VB [DG]
2.2 TDCi	03/08-	KNWA, Q4WA	2179				0-N1963	VB [DG]
2.2 TDCi	03/08-	KNWA, Q4WA	2179				0-N2042	VB [BT] S
2.3	07/07-	SEWA	2261	Rippenanzahl: 6			0-N1497	VB [BT] S
2.3	07/07-	SEWA	2261				0-N1991	VB [DG]
2.5 ST	05/06-	HUWA	2521				0-N1964	VB [BT] S
S-MAX								
1.5 EcoBoost	02/15-	UNCI, UNCJ, UNCK	1498				0-N2363	VB [DG]
STREET KA (RL2)								
1.6	05/03-07/05	CDRA, CDRB	1599				0-N2266	VB [BT]
1.6	05/03-07/05	CDRA, CDRB	1599				0-N2266S1	VB [DG]
1.6	05/03-07/05	CDRA, CDRB	1599				0-N2266S2	VB [DG]
TAUNUS '80 (GBS, GBNS)								
1.6	07/79-07/82	LCJ	1593	19.05x119			SK-1160	BTK
1.3	07/79-07/82	JCC	1294				0-N839	TB [TE]
1.6	07/79-07/82	LAR, LCJ, LE	1593				0-N839	TB [TE]
2.0	07/79-07/82	NER	1993				0-N839	TB [TE]
TAUNUS '80 Turnier (GBNS)								
1.6	07/79-07/82	LAR, LCJ	1593				0-N839	TB [TE]
2.0	07/79-07/82	NER	1993				0-N839	TB [TE]
TAUNUS (GBFK)								
1300	08/70-02/76		1285	19.05x119; 04/1972 →			SK-1160	BTK
1600	08/70-02/76	LAD, LCJ	1593	19.05x119			SK-1160	BTK
1600	08/70-02/76		1576	19.05x119; 04/1972 →			SK-1160	BTK
1300	08/70-02/76		1285				0-N839	TB [TE]
1600	08/70-02/76		1576				0-N839	TB [TE]
1600	08/70-02/76	LAD, LCJ	1593				0-N839	TB [TE]
TAUNUS (GBTK)								
1300	01/70-05/75	JAC	1297	19.05x119			SK-1160	BTK
1600	01/70-05/75	LCJ	1593	19.05x119; 04/1972 →			SK-1160	BTK
1600	08/70-02/76		1576	19.05x119; 04/1972 →			SK-1160	BTK
1600	01/74-05/75	LAD	1593	19.05x119			SK-1160	BTK
1300	01/70-05/75	JAC	1297				0-N839	TB [TE]
1600	01/70-05/75	LAD, LCJ	1593				0-N839	TB [TE]
1600	08/70-02/76		1576				0-N839	TB [TE]
TAUNUS Coupe (GBCK)								
1300	08/70-02/76		1285	19.05x119; 04/1972 →			SK-1160	BTK
1600	08/70-02/76		1576	19.05x119; 04/1972 →			SK-1160	BTK
1600	08/70-02/76		1576	19.05x119; 08/1973 →			SK-1160	BTK
1300	08/70-02/76		1285				0-N839	TB [TE]
1600	08/70-02/76		1576				0-N839	TB [TE]
TAUNUS Turnier (GBNK)								
1300	08/70-02/76		1285	19.05x119; 04/1972 →			SK-1160	BTK

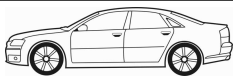

CM³



Art. Nr.



TAUNUS Turnier (GBNK)

1600	08/70-02/76		1576	19.05x119; 09/1971 →	SK-1160	BTK	
1600	01/74-05/75	LAD	1593	19.05x119	SK-1160	BTK	
1300	08/70-02/76		1285		0-N839	TB [TE]	
1600	08/70-02/76		1576		0-N839	TB [TE]	
1600	01/74-05/75	LAD	1593		0-N839	TB [TE]	

TAUNUS (GBTS, GBFS, CBTS)

1.3	05/75-07/79	JAC	1297	19.05x119; 09/1976 →	SK-1160	BTK	
1.3	09/76-07/79		1285	19.05x119	SK-1160	BTK	
1.6	05/75-07/79	LAD, LCJ, LE	1593	19.05x119	SK-1160	BTK	
1.3	05/75-07/79	JAC	1297		0-N839	TB [TE]	
1.3	09/76-07/79		1285		0-N839	TB [TE]	
1.6	05/75-07/79	LAD, LCJ, LE	1593		0-N839	TB [TE]	

TAUNUS Turnier (GBNS)

1.3	05/75-07/79	JAC	1297	19.05x119; 09/1976 →	SK-1160	BTK	
1.6	05/75-07/79	LAD, LCJ	1593	19.05x119; 09/1976 →	SK-1160	BTK	
1.3	05/75-07/79	JAC	1297		0-N839	TB [TE]	
1.6	05/75-07/79	LAD, LCJ	1593		0-N839	TB [TE]	

TOURNEO CONNECT

1.8 16V	06/02-12/13	EYPA, EYPC, EYPD	1796	25x129; beinhaltenete Rollen: 2	SK-1340	BTK	
1.8 Di, 1.8 TDCi, 1.8 Turbo Di	06/02-12/13	BHPA, P7PA, P7PB, R2PA, HCPA, HCPB, P9PA, P9PB, P9PC, P9PD, R3PA, RWPE, RWPF, RWPA, RWPC, RWPD	1753	20x91	SK-1341	BTK	
1.8 16V	06/02-12/13	EYPA, EYPC, EYPD	1796		0-N290	TB [TE]	
1.8 16V	06/02-12/13	EYPA, EYPC, EYPD	1796	†	0-N291	TB [DG]	
1.8 Di, 1.8 TDCi, 1.8 Turbo Di	06/02-12/13	BHPA, P7PA, P7PB, R2PA, HCPA, HCPB, P9PA, P9PB, P9PC, P9PD, R3PA, RWPE, RWPF, RWPA, RWPC, RWPD	1753		0-N1367	TB [TE]	
1.8 16V	06/02-12/13	EYPA, EYPC, EYPD	1796	Rippenanzahl: 6	0-N1435	VB [BT]	S
1.8 16V	06/02-12/13	EYPA, EYPC, EYPD	1796		0-N1716	VB [DG]	
1.8 16V	06/02-12/13	EYPA, EYPC, EYPD	1796	→ 04/2007	0-N1942	VB [DG]	
1.8 16V	06/02-12/13	EYPA, EYPC, EYPD	1796	05/2007 →	0-N1942	VB [DG]	
1.8 Di, 1.8 TDCi, 1.8 Turbo Di	06/02-12/13	BHPA, P7PA, P7PB, R2PA, HCPA, HCPB, P9PA, P9PB, P9PC, P9PD, R3PA, RWPE, RWPF, RWPA, RWPC, RWPD	1753	→ 05/2007; †; ✱	0-N1458	VB [DG]	
1.8 Di, 1.8 TDCi, 1.8 Turbo Di	06/02-12/13	BHPA, P7PA, P7PB, R2PA, HCPA, HCPB, P9PA, P9PB, P9PC, P9PD, R3PA, RWPE, RWPF, RWPA, RWPC, RWPD	1753		0-N1520	VB [BT]	S
1.8 Di, 1.8 TDCi, 1.8 Turbo Di	06/02-12/13	BHPA, P7PA, P7PB, R2PA, HCPA, HCPB, P9PA, P9PB, P9PC, P9PD, R3PA, RWPE, RWPF, RWPA, RWPC, RWPD	1753		0-N1610	VB [BT]	
1.8 Di, 1.8 TDCi, 1.8 Turbo Di	06/02-12/13	BHPA, P7PA, P7PB, R2PA, HCPA, HCPB, P9PA, P9PB, P9PC, P9PD, R3PA, RWPE, RWPF, RWPA, RWPC, RWPD	1753	→ 04/2007	0-N1942	VB [DG]	
1.8 Di, 1.8 TDCi, 1.8 Turbo Di	06/02-12/13	BHPA, P7PA, P7PB, R2PA, HCPA, HCPB, P9PA, P9PB, P9PC, P9PD, R3PA, RWPE, RWPF, RWPA, RWPC, RWPD	1753	05/2007 →	0-N1942	VB [DG]	

TOURNEO COURIER Kombi

1.5 TDCi	02/14-	UGCA, UGCB, XUCC, XUCD	1499	25x141	SK-1728	BTK	
1.5 TDCi	02/14-	UGCA, UGCB, XUCC, XUCD	1499	25x141	SK-1728AQ1	BTKW	
1.6 TDCi	02/14-	T3CA, T3CB, T3CC	1560	25x141	SK-1728	BTK	
1.6 TDCi	02/14-	T3CA, T3CB, T3CC	1560	25x141	SK-1728AQ1	BTKW	
1.5 TDCi	02/14-	UGCA, UGCB, XUCC, XUCD, XVCA, XVCB, XVCC	1499		0-N2382	TB [DG]	
1.6 TDCi	02/14-	T3CA, T3CB, T3CC	1560		0-N2382	TB [DG]	
1.5 TDCi	02/14-	UGCA, UGCB, XUCC, XUCD	1499		0-N1339	VB [BT]	S
1.6 TDCi	02/14-	T3CA, T3CB, T3CC	1560		0-N1339	VB [BT]	S

TOURNEO CONNECT / GRAND TOURNEO CONNECT Kombi

1.6 TDCi	09/13-	T1GA, TZGA, TZGB, UBGA	1560	25x141	SK-1728	BTK	
1.6 TDCi	09/13-	T1GA, TZGA, TZGB, UBGA	1560	25x141	SK-1728AQ1	BTKW	
1.6 EcoBoost	11/13-	JQGA	1596		0-N2057	TB [TE]	
1.6 TDCi	09/13-	T1GA, TZGA, TZGB, UBGA	1560		0-N2382	TB [DG]	
1.0 EcoBoost	11/13-	M2GA, M2GB	998		0-N2300	VB [BT]	S
1.0 EcoBoost	11/13-	M2GA, M2GB	998		0-N2303	VB [DG]	
1.0 EcoBoost	11/13-	M2GA, M2GB	998	✱	0-N2353	VB [DG]	
1.6 EcoBoost	11/13-	JQGA	1596		0-N2269	VB [BT]	S
1.6 EcoBoost	11/13-	JQGA	1596		0-N2363	VB [DG]	
1.6 TDCi	09/13-	T1GA, TZGA, TZGB, UBGA	1560		0-N1339	VB [BT]	S

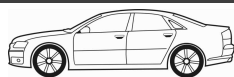
CM³

Art. Nr.



TRANSIT Bus (V_ _)								
1.6	12/77-10/86	4RB	1593	19.05x119	SK-1160	BTK		
2.5 D	10/83-10/86	4AB	2496	25.4x130	SK-1052	BTK		
1.6	12/77-10/86	4RB	1593		0-N839	TB [TE]		
2.0	11/77-10/86	4RC	1993		0-N839	TB [TE]		
2.5 D	10/83-10/86	4AB	2496	Spannrollenbetätigung: manuell	0-N842	TB [TE]		
TRANSIT Pritsche/Fahrgestell (V_ _)								
1.6	11/77-10/86	B	1593	19.05x119	SK-1160	BTK		
2.5 D	10/83-10/86	4AB	2496	25.4x130	SK-1052	BTK		
1.6	11/77-10/86	B	1593		0-N839	TB [TE]		
2.0	11/77-10/86	4RC	1993		0-N839	TB [TE]		
2.5 D	10/83-10/86	4AB	2496	Spannrollenbetätigung: manuell	0-N842	TB [TE]		
TRANSIT Kasten (V_ _)								
1.6	11/77-10/86	4RB	1593	19.05x119	SK-1160	BTK		
2.5 D	10/83-10/86	4AB	2496	25.4x130	SK-1052	BTK		
1.6	11/77-10/86	4RB	1593		0-N839	TB [TE]		
2.0	11/77-10/86	4RC	1993		0-N839	TB [TE]		
2.5 D	10/83-10/86	4AB	2496	Spannrollenbetätigung: manuell	0-N842	TB [TE]		
TRANSIT Bus (T_ _)								
1.6	12/85-01/89	LAT	1593	19.05x119	SK-1160	BTK		
2.5 D	12/85-09/92	4AB, 4AB, 4BA, 4CA	2496	25.4x130	SK-1052	BTK		
2.5 D	09/88-09/92	4AB, 4BA, 4CA	2496	25x130; 08/1991 →	SK-1049	BTK		
1.6	12/85-01/89	LAT	1593		0-N839	TB [TE]		
2.0	11/85-09/92	NAT, NAV	1994		0-N839	TB [TE]		
2.0	12/85-09/92	N6T	1993		0-N839	TB [TE]		
2.5 D	12/85-09/92	4AB, 4AB, 4BA, 4CA	2496	Spannrollenbetätigung: manuell	0-N842	TB [TE]		
TRANSIT Kasten (T_ _)								
1.6	09/85-09/92	LAT	1593	19.05x119	SK-1160	BTK		
2.5 D	10/85-09/91	4AB, 4AE, 4BA, 4CA	2496	25.4x130	SK-1052	BTK		
2.5 D	10/88-09/91	4BA, 4CA	2496	25x130; 08/1991 →	SK-1049	BTK		
1.6	09/85-09/92	LAT	1593		0-N839	TB [TE]		
2.0	09/85-09/92	NAT, NAV	1994		0-N839	TB [TE]		
2.5 D	01/86-09/91	4AB, 4BA, 4CA	2496	Spannrollenbetätigung: manuell	0-N842	TB [TE]		
TRANSIT Pritsche/Fahrgestell (T_ _)								
2.5 D , 2.5 DI	01/86-09/92	4AB, 4BA, 4CA	2496	25.4x130	SK-1052	BTK		
2.5 DI	09/88-09/92	4BA, 4CA	2496	25x130; 08/1991 →	SK-1049	BTK		
2.0	11/85-09/92	N6T	1993		0-N839	TB [TE]		
2.0	01/86-09/92	NAT, NAV	1994		0-N839	TB [TE]		
2.5 D , 2.5 DI	01/86-09/92	4AB, 4BA, 4CA	2496	Spannrollenbetätigung: manuell	0-N842	TB [TE]		
TRANSIT Bus (E_ _)								
2.5 DI , 2.5 TD	08/91-07/94	4BC, 4CC, 4FA, 4DA, 4EA, 4GA, 4GB, 4GC	2496	25x130	SK-1049	BTK		
2.0	09/91-09/94	NBA	1993		0-N839	TB [TE]		
2.0 i	09/91-07/94	NCA	1994		0-N839	TB [TE]		
2.5 DI , 2.5 TD	08/91-07/94	4BC, 4CC, 4FA, 4DA, 4EA, 4EB, 4EC, 4ED, 4FA, 4FB, 4FC, 4FD, 4GA, 4GB, 4GC, 4GA, 4GB, 4GC, 4GD, 4GE, 4GF, 4HA, 4HD, 4HB, 4HC	2496		0-N1361	TB [TE]		
2.5 DI , 2.5 TD	09/91-07/94	4DA, 4EA, 4EB, 4EC, 4ED, 4FA, 4FB, 4FC, 4FD, 4GA, 4GB, 4GC, 4GD, 4GE, 4GF, 4HA, 4HD, 4HB, 4HC	2496	☛, für Fahrzeuge mit Servolenkung	0-N1957	VB [BT]	S	
TRANSIT Kasten (E_ _)								
2.5 DI , 2.5 TD	05/91-06/94	4BC, 4CC, 4FA, 4DA, 4EA, 4GA	2496	25x130	SK-1049	BTK		
2.5 DI , 2.5 TD	05/91-06/94	4BC, 4CC, 4FA, 4DA, 4EA	2496	25.4x130	SK-1052	BTK		
2.0	09/91-06/94	NBA	1993		0-N839	TB [TE]		
2.0 i	09/91-06/94	NCA	1994		0-N839	TB [TE]		
2.5 DI , 2.5 TD , 2.5 TDI	05/91-06/94	4BC, 4CC, 4FA, 4DA, 4EA, 4EB, 4EC, 4ED, 4FA, 4FB, 4FC, 4FD, 4GA, 4GB, 4GC, 4GD, 4GE, 4GF, 4HA, 4HD, 4HB, 4HC	2496		0-N1361	TB [TE]		
2.5 DI , 2.5 TD , 2.5 TDI	05/91-06/94	4DA, 4EB, 4EC, 4ED, 4FA, 4FB, 4FC, 4FD, 4GA, 4GB, 4GC, 4GD, 4GE, 4GF, 4HA, 4HD, 4HB, 4HC	2496	☛, für Fahrzeuge mit Servolenkung	0-N1957	VB [BT]	S	
TRANSIT Pritsche/Fahrgestell (E_ _)								
2.5 DI , 2.5 TD	09/91-08/94	4AB, 4BC, 4CC, 4FA, 4DA, 4EA, 4GA, 4GB, 4GC	2496	25x130	SK-1049	BTK		
2.0	09/91-08/94	NCA	1994		0-N839	TB [TE]		



CM³



Art. Nr.



ohne Halter

TRANSIT Pritsche/Fahrgestell (E_ _)							
2.5 DI, 2.5 TD	09/91-08/94	4AB, 4BC, 4CC, 4FA, 4DA, 4EA, 4EB, 4EC, 4ED, 4FA, 4FB, 4FC, 4FD, 4GA, 4GB, 4GC, 4GA, 4GB, 4GC, 4GD, 4GE, 4GF, 4HA, 4HD, 4HB, 4HC	2496			0-N1361	TB [TE]
2.5 DI, 2.5 TD	09/91-08/94	4DA, 4EB, 4EC, 4ED, 4FA, 4FB, 4FC, 4FD, 4GA, 4GB, 4GC, 4GD, 4GE, 4GF, 4HA, 4HD, 4HB, 4HC	2496	☼, für Fahrzeuge mit Servolenkung		0-N1957	VB [BT] S
TRANSIT Bus (E_ _)							
2.5 DI	08/97-03/00	4ED	2496	27.6x130; 12/1998 →		SK-1351	BTK
2.5 DI, 2.5 TD	07/94-06/00	4EB, 4EC, 4FA, 4FB, 4FC, 4FD, 4GA, 4GB, 4GC, 4GD, 4GE, 4GF, 4HA, 4HD, 4HB, 4HC	2496	25x130; → 09/1997		SK-1049	BTK
2.5 DI, 2.5 TD	07/94-06/00	4EB, 4EC, 4FA, 4FB, 4FC, 4FD, 4GA, 4GB, 4GC, 4GD, 4GE, 4GF, 4HA, 4HD, 4HB, 4HC	2496	27.6x130; 09/1997 →		SK-1351	BTK
2.5 DI, 2.5 TD	07/94-06/00	4BC, 4CC, 4FA, 4DA, 4EA, 4EB, 4EC, 4ED, 4FA, 4FB, 4FC, 4FD, 4GA, 4GB, 4GC, 4GA, 4GB, 4GC, 4GD, 4GE, 4GF, 4HA, 4HD, 4HB, 4HC	2496			0-N1361	TB [TE]
2.0	09/95-03/00	NSF, NSG	1998			0-N1557S	VB [TE]
2.0, 2.0 CNG	06/94-03/00	NSF, NSG, NSH	1998	→ 07/1998; ☼		0-N1401	VB [DG]
2.0, 2.0 CNG	06/94-03/00	NSF, NSG, NSH	1998	ABS		0-N1519	VB [BT] S
2.0 CNG	06/94-03/00	NSH	1998	08/1994 →		0-N1557S	VB [TE]
2.5 DI, 2.5 TD	07/94-06/00	4DA, 4EA, 4EB, 4EC, 4ED, 4FA, 4FB, 4FC, 4FD, 4GA, 4GB, 4GC, 4GD, 4GE, 4GF, 4HA, 4HD, 4HB, 4HC	2496	☼, für Fahrzeuge mit Servolenkung		0-N1957	VB [BT] S
TRANSIT Kasten (E_ _)							
2.5 DI, 2.5 TD	10/98-03/00	4ED, 4HA, 4HD	2496	27.6x130		SK-1351	BTK
2.5 DI, 2.5 TD, 2.5 TDI	06/94-03/00	4EB, 4EC, 4FA, 4FB, 4FC, 4FD, 4GA, 4GB, 4GC, 4GD, 4GE, 4GF, 4HA, 4HD, 4HB, 4HC	2496	25x130; → 09/1997		SK-1049	BTK
2.5 DI, 2.5 TD, 2.5 TDI	06/94-03/00	4EB, 4EC, 4FA, 4FB, 4FC, 4FD, 4GA, 4GB, 4GC, 4GD, 4GE, 4GF, 4HA, 4HD, 4HB, 4HC	2496	27.6x130; 09/1997 →		SK-1351	BTK
2.5 DI, 2.5 TD, 2.5 TDI	06/94-03/00	4BC, 4CC, 4FA, 4DA, 4EA, 4EB, 4EC, 4ED, 4FA, 4FB, 4FC, 4FD, 4GA, 4GB, 4GC, 4GD, 4GE, 4GF, 4HA, 4HD, 4HB, 4HC	2496			0-N1361	TB [TE]
2.0	06/94-03/00	NSF, NSG	1998	→ 07/1998; ☼		0-N1401	VB [DG]
2.0	06/94-03/00	NSF, NSG	1998	ABS		0-N1519	VB [BT] S
2.0	06/94-03/00	NSF, NSG	1998	08/1994 →		0-N1557S	VB [TE]
2.5 DI, 2.5 TD, 2.5 TDI	06/94-03/00	4DA, 4EB, 4EC, 4ED, 4FA, 4FB, 4FC, 4FD, 4GA, 4GB, 4GC, 4GD, 4GE, 4GF, 4HA, 4HD, 4HB, 4HC	2496	☼, für Fahrzeuge mit Servolenkung		0-N1957	VB [BT] S
TRANSIT Pritsche/Fahrgestell (E_ _)							
2.5 DI	05/99-03/00	4ED	2496	27.6x130		SK-1351	BTK
2.5 DI, 2.5 TD	08/94-03/00	4EB, 4EC, 4FA, 4FB, 4FC, 4FD, 4GA, 4GB, 4GC, 4GD, 4GE, 4GF, 4HA, 4HD, 4HB, 4HC	2496	25x130; → 09/1997		SK-1049	BTK
2.5 DI, 2.5 TD	08/94-03/00	4EB, 4EC, 4FA, 4FB, 4FC, 4FD, 4GA, 4GB, 4GC, 4GD, 4GE, 4GF, 4HA, 4HD, 4HB, 4HC	2496	27.6x130; 09/1997 →		SK-1351	BTK
2.5 TD	10/98-07/00	4HA, 4HD	2496	27.6x130; → 06/2000		SK-1351	BTK
2.5 DI, 2.5 TD	08/94-07/00	4AB, 4BC, 4CC, 4FA, 4DA, 4EA, 4EB, 4EC, 4ED, 4FA, 4FB, 4FC, 4FD, 4GA, 4GB, 4GC, 4GA, 4GB, 4GC, 4GD, 4GE, 4GF, 4HA, 4HD, 4HB, 4HC	2496			0-N1361	TB [TE]
2.0	08/94-03/00	NSF, NSG	1998	→ 07/1998; ☼		0-N1401	VB [DG]
2.0	08/94-03/00	NSF, NSG	1998	ABS		0-N1519	VB [BT] S
2.0	08/94-03/00	NSF, NSG	1998			0-N1557S	VB [TE]
2.5 DI, 2.5 TD	08/94-07/00	4DA, 4EB, 4EC, 4ED, 4FA, 4FB, 4FC, 4FD, 4GA, 4GB, 4GC, 4GD, 4GE, 4GF, 4HA, 4HD, 4HB, 4HC	2496	☼, für Fahrzeuge mit Servolenkung		0-N1957	VB [BT] S
TRANSIT Bus (FD_ _, FB_ _, FS_ _, FZ_ _, FC_ _)							
2.0 DI, 2.0 TDCi	08/00-05/06	ABFA, D3FA, F3FA, FIFA	1998			0-N1390	VB [BT] S
2.0 DI, 2.0 TDCi	08/00-05/06	ABFA, D3FA, F3FA, FIFA	1998	☼		0-N1392	VB [DG]
2.0 DI, 2.0 TDCi	08/00-05/06	ABFA, D3FA, F3FA, FIFA	1998	Rippenanzahl: 6		0-N1428	VB [DG]
2.0 DI, 2.0 TDCi	08/00-05/06	ABFA, D3FA, F3FA, FIFA	1998			0-N1477	VB [TE] S
2.3 16V [RWD]	08/00-05/06	E5FA, E5FC	2295			0-N1557S	VB [TE]
2.4 DI	01/00-05/06	D2FE	2402	10/2001 →; Baumuster: 330, 350		0-N1719	VB [BT] S
2.4 DI, 2.4 DI [RWD], 2.4 TD, 2.4 TDCi, 2.4 TDdi, 2.4 TDE	01/00-05/06	D2FA, D2FB, D2FE, D2FE, D4FA, DOFA, F4FA, FXFA, H9FA	2402			0-N1665	VB [DG]
2.4 DI [RWD]	01/00-05/06	D4FA, F4FA	2402	08/2000 →; Baumuster: 330, 350		0-N1719	VB [BT] S
2.4 TD, 2.4 TDdi	08/00-08/03	D4FA, F4FA	2402			0-N1719	VB [BT] S
2.4 TDCi, 2.4 TDdi, 2.4 TDE	07/01-05/06	D2FE, DOFA, H9FA	2402	Baumuster: 330, 350		0-N1719	VB [BT] S
2.4 TDE	03/04-05/06	FXFA	2402	Baumuster: 300, 330, 350		0-N1719	VB [BT] S

CM³

Art. Nr.



ohne Halter

TRANSIT Pritsche/Fahrgestell (FM_ , FN_)							
2.0 DI , 2.0 TDCi	08/00-05/06	ABFA, D3FA, F3FA, FIFA	1998			0-N1390	VB [BT] S
2.0 DI , 2.0 TDCi	08/00-05/06	ABFA, D3FA, F3FA, FIFA	1998	✳		0-N1392	VB [DG]
2.0 DI , 2.0 TDCi	08/00-05/06	ABFA, D3FA, F3FA, FIFA	1998	Rippenanzahl: 6		0-N1428	VB [DG]
2.0 DI , 2.0 TDCi	08/00-05/06	ABFA, D3FA, F3FA, FIFA	1998			0-N1477	VB [TE] S
2.3 16V	04/01-05/06	E5FA, E5FC	2295			0-N1557S	VB [TE]
2.4 DI	01/00-05/06	D2FA	2402	10/2001 →; Baumuster: 430		0-N1719	VB [BT] S
2.4 DI	01/00-05/06	D4FA	2402	Baumuster: 260		0-N1719	VB [BT] S
2.4 DI	01/00-05/06	F4FA	2402	Baumuster: 330, 350		0-N1719	VB [BT] S
2.4 DI	01/00-05/06	D2FA, D2FE	2402	Baumuster: 330, 350, 425		0-N1719	VB [BT] S
2.4 DI	01/00-05/06	D4FA	2402	Baumuster: 330, 350, 425		0-N1719	VB [BT] S
2.4 DI , 2.4 TDCi, 2.4 Tdi, 2.4 TDE	01/00-05/06	D2FA, D2FB, D2FE, D4FA, DOFA, F4FA, FXFA, H9FA	2402			0-N1665	VB [DG]
2.4 TDCi	03/04-05/06	H9FA	2402	Baumuster: 330, 350, 425, 430		0-N1719	VB [BT] S
2.4 Tdi	08/00-08/03	D4FA	2402			0-N1719	VB [BT] S
2.4 TDE	07/01-05/06	DOFA	2402	Baumuster: 330, 350, 410, 425		0-N1719	VB [BT] S
2.4 TDE	07/01-05/06	DOFA	2402	Baumuster: 430		0-N1719	VB [BT] S
2.4 TDE	03/04-05/06	FXFA	2402	Baumuster: 300, 330, 350		0-N1719	VB [BT] S
TRANSIT Kasten (FA_)							
2.0 DI , 2.0 TDCi	08/00-05/06	ABFA, D3FA, F3FA, FIFA	1998			0-N1390	VB [BT] S
2.0 DI , 2.0 TDCi	08/00-05/06	ABFA, D3FA, F3FA, FIFA	1998	✳		0-N1392	VB [DG]
2.0 DI , 2.0 TDCi	08/00-05/06	ABFA, D3FA, F3FA, FIFA	1998	Rippenanzahl: 6		0-N1428	VB [DG]
2.0 DI , 2.0 TDCi	08/00-05/06	ABFA, D3FA, F3FA, FIFA	1998			0-N1477	VB [TE] S
2.3 16V [RWD]	04/01-05/06	E5FA, E5FC	2295			0-N1557S	VB [TE]
2.4 DI	01/00-05/06	D2FE	2402	10/2001 →; Baumuster: 300		0-N1719	VB [BT] S
2.4 DI	01/00-05/06	D2FA, D2FE	2402	Baumuster: 330, 350		0-N1719	VB [BT] S
2.4 DI , 2.4 DI [RWD] , 2.4 TD, 2.4 TDCi, 2.4 Tdi, 2.4 TDE	01/00-05/06	D2FA, D2FB, D2FE, D4FA, DOFA, F4FA, FXFA, H9FA	2402			0-N1665	VB [DG]
2.4 DI [RWD]	01/00-05/06	D4FA	2402	08/2000 →; Baumuster: 350		0-N1719	VB [BT] S
2.4 DI [RWD]	01/00-05/06	D4FA	2402	Baumuster: 330		0-N1719	VB [BT] S
2.4 DI [RWD] , 2.4 TDCi	01/00-05/06	F4FA, H9FA	2402	Baumuster: 330, 350		0-N1719	VB [BT] S
2.4 TD	08/00-08/03	F4FA	2402	Baumuster: 350		0-N1719	VB [BT] S
2.4 Tdi	08/00-08/03	D4FA	2402	Baumuster: 260, 330, 350		0-N1719	VB [BT] S
2.4 TDE	07/01-05/06	DOFA, FXFA	2402	Baumuster: 300, 330, 350		0-N1719	VB [BT] S
TRANSIT Bus							
2.2 TDCi	04/06-08/14	P8FA, P8FB, PGFA, PGFB, UHFA, UHFB, UHFC, QVFA, QWFA, SRFA, SRFB, SRFC, SRFD, SRFE	2198			0-N1392	VB [DG]
2.2 TDCi	04/06-08/14	P8FA, P8FB, PGFA, PGFB, UHFA, UHFB, UHFC, QVFA, QWFA, SRFA, SRFB, SRFC, SRFD, SRFE	2198	Rippenanzahl: 6		0-N1460	VB [DG]
2.2 TDCi, 2.2 TDCi [RWD]	04/06-08/14	CYFA, CYFB, CYFC, CYFD, CYRA, CYRB, DRFA, DRFB, DRFC, DRFD, DRFE, DRRA, DRRB, DRRC, P8FA, P8FB, PGFA, PGFB, UHFA, UHFB, UHFC, QVFA, QWFA, SRFA, SRFB, SRFC, SRFD, SRFE, USRA, USRB	2198			0-N2014	VB [BT] S
2.2 TDCi, 2.2 TDCi [RWD]	09/11-08/14	CYFA, CYFB, CYFC, CYFD, CYRA, CYRB, DRFA, DRFB, DRFC, DRFD, DRFE, DRRA, DRRB, DRRC, USRA, USRB	2198	✳		0-N1392	VB [DG]
2.4 TDCi	04/06-08/14	H9FD, JXFA, JXFC, PHFA, PHFC	2402	→ 07/2009; ✳		0-N2038	VB [BT] S
2.4 TDCi	04/06-08/14	H9FD, JXFA, JXFC, PHFA, PHFC	2402	→ 07/2009; ✳		0-N2038	VB [BT] S
2.4 TDCi 4x4	11/06-08/14	H9FB	2402	→ 04/2009; ✳		0-N2038	VB [BT] S
2.4 TDCi 4x4	11/06-08/14	H9FB	2402	→ 04/2009; ✳		0-N2038	VB [BT] S
2.4 TDCi, 2.4 TDCi 4x4	04/06-08/14	H9FB, H9FD, JXFA, JXFC, PHFA, PHFC	2402			0-N1661	VB [DG]
3.2 TDCi	02/08-08/14	SAFA, SAFB	3199			0-N1661	VB [DG]
3.2 TDCi	02/08-08/14	SAFA, SAFB	3199	→ 04/2009; ✳		0-N2038	VB [BT] S
3.2 TDCi	02/08-08/14	SAFA, SAFB	3199	→ 04/2009; ✳		0-N2038	VB [BT] S
TRANSIT Kasten							
2.2 TDCi	04/06-08/14	P8FA, P8FB, PGFA, PGFB, UHFA, UHFB, UHFC, QVFA, QWFA, SRFA, SRFB, SRFC, SRFD, SRFE	2198			0-N1392	VB [DG]
2.2 TDCi	04/06-08/14	P8FA, P8FB, PGFA, PGFB, UHFA, UHFB, UHFC, QVFA, QWFA, SRFA, SRFB, SRFC, SRFD, SRFE	2198	Rippenanzahl: 6		0-N1460	VB [DG]
2.2 TDCi, 2.2 TDCi [RWD], 2.2 TDCi 4x4	04/06-08/14	CVRA, CVRB, CVRC, CYFA, CYFB, CYFC, CYFD, CYRA, CYRB, CYRC, DRFA, DRFB, DRFC, DRFD, DRFE, DRRA, DRRB, DRRC, P8FA, P8FB, PGFA, PGFB, UHFA, UHFB, UHFC, QVFA, QWFA, SRFA, SRFB, SRFC, SRFD, SRFE	2198			0-N2014	VB [BT] S

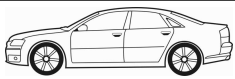

CM³



Art. Nr.



TRANSIT Kasten								
2.2 TDCi, 2.2 TDCi [RWD], 2.2 TDCi 4x4	10/11-08/14	CVRA, CVRB, CVRC, CYFA, CYFB, CYFC, CYFD, CYRA, CYRB, CYRC, DRFA, DRFB, DRFC, DRFD, DRFE, DRRR, DRRB, DRRC	2198	☼		0-N1392	VB [DG]	
2.3 16V	04/06-08/14	GZFA, GZFB, GZFC	2261		Rippenanzahl: 6	0-N1497	VB [BT]	S
2.3 16V	04/06-08/14	GZFA	2261		Baumuster: 300, 330, 350	0-N1702	VB [DG]	
2.4 TDCi	04/06-08/14	H9FD, JXFA, JXFC, PHFA, PHFC	2402		→ 07/2009; ☼	0-N2038	VB [BT]	S
2.4 TDCi	04/06-08/14	H9FD, JXFA, JXFC, PHFA, PHFC	2402		→ 07/2009; ☼	0-N2038	VB [BT]	S
2.4 TDCi 4x4	11/06-08/14	H9FB	2402			0-N2038	VB [BT]	S
2.4 TDCi, 2.4 TDCi 4x4	04/06-08/14	H9FB, H9FD, JXFA, JXFC, PHFA, PHFC	2402			0-N1661	VB [DG]	
3.2 TDCi	09/07-08/14	SAFA, SAFB	3199			0-N1661	VB [DG]	
3.2 TDCi	09/07-08/14	SAFA, SAFB	3199		→ 10/2007; ☼	0-N2038	VB [BT]	S
3.2 TDCi	09/07-08/14	SAFA, SAFB	3199		→ 10/2007; ☼	0-N2038	VB [BT]	S

TRANSIT Pritsche/Fahrgestell								
2.2 TDCi	04/06-08/14	P8FA, P8FB, PGFA, PGFB, UHFA, UHFB, UHFC, QVFA, QWFA, SRFA, SRFB, SRFC, SRFD, SRFE	2198			0-N1392	VB [DG]	
2.2 TDCi	04/06-08/14	P8FA, P8FB, PGFA, PGFB, UHFA, UHFB, UHFC, QVFA, QWFA, SRFA, SRFB, SRFC, SRFD, SRFE	2198		Rippenanzahl: 6	0-N1460	VB [DG]	
2.2 TDCi, 2.2 TDCi [RWD], 2.2 TDCi 4x4	04/06-08/14	CVRA, CVRB, CVRC, CYFA, CYFB, CYFC, CYFD, CYRA, CYRB, CYRC, DRFA, DRFB, DRFC, DRFD, DRFE, DRRR, DRRB, DRRC, P8FA, P8FB, PGFA, PGFB, UHFA, UHFB, UHFC, QVFA, QWFA, SRFA, SRFB, SRFC, SRFD, SRFE	2198			0-N2014	VB [BT]	S
2.2 TDCi, 2.2 TDCi [RWD], 2.2 TDCi 4x4	10/11-08/14	CVRA, CVRB, CVRC, CYFA, CYFB, CYFC, CYFD, CYRA, CYRB, CYRC, DRFA, DRFB, DRFC, DRFD, DRFE, DRRR, DRRB, DRRC	2198	☼		0-N1392	VB [DG]	
2.3 16V	04/06-08/14	GZFA, GZFB, GZFC	2261		Rippenanzahl: 6	0-N1497	VB [BT]	S
2.3 16V	04/06-08/14	GZFA, GZFB, GZFC	2261		Baumuster: 300, 330, 350	0-N1702	VB [DG]	
2.4 TDCi	04/06-08/14	H9FB, H9FD, JXFA, JXFC, PHFA, PHFC	2402		→ 07/2009; ☼	0-N2038	VB [BT]	S
2.4 TDCi	04/06-08/14	H9FB, H9FD, JXFA, JXFC, PHFA, PHFC	2402		→ 07/2009; ☼	0-N2038	VB [BT]	S
2.4 TDCi 4x4	11/06-08/14	H9FB	2402			0-N2038	VB [BT]	S
2.4 TDCi, 2.4 TDCi 4x4	04/06-08/14	H9FB, H9FB, H9FD, JXFA, JXFC, PHFA, PHFC	2402			0-N1661	VB [DG]	
3.2 TDCi	09/07-08/14	SAFA, SAFB	3199			0-N1661	VB [DG]	
3.2 TDCi	09/07-08/14	SAFA, SAFB	3199		→ 07/2009; ☼	0-N2038	VB [BT]	S
3.2 TDCi	09/07-08/14	SAFA, SAFB	3199		→ 07/2009; ☼	0-N2038	VB [BT]	S

TRANSIT CONNECT (P65_, P70_, P80_)								
1.8 16V, 1.8 16V LPG	06/02-12/13	EYPA, EYPC, EYPD, EYPC	1796		25x129; beinhaltetete Rollen: 2	SK-1340	BTK	
1.8 Di, 1.8 TDCi	06/02-12/13	BHPA, P7PA, P7PB, R2PA, HCPA, HCPB, P9PA, P9PB, P9PC, P9PD, R3PA, RWPE, RWPF, RWPA, RWPC, RWPD	1753		20x91	SK-1341	BTK	
1.8 16V	06/02-12/13	EYPA, EYPC, EYPD	1796			0-N290	TB [TE]	
1.8 16V	06/02-12/13	EYPA, EYPC, EYPD	1796	†		0-N291	TB [DG]	
1.8 Di, 1.8 TDCi	06/02-12/13	BHPA, P7PA, P7PB, R2PA, HCPA, HCPB, P9PA, P9PB, P9PC, P9PD, R3PA, RWPE, RWPF, RWPA, RWPC, RWPD	1753			0-N1367	TB [TE]	
1.8 Di, 1.8 TDCi	06/02-12/13	BHPA, P7PA, P7PB, R2PA, HCPA, HCPB, P9PA, P9PB, P9PC, P9PD, R3PA, RWPE, RWPF, RWPA, RWPC, RWPD	1753			0-N295	TB [TE]	
1.8 16V	06/02-12/13	EYPA, EYPC, EYPD	1796		Rippenanzahl: 6	0-N1435	VB [BT]	S
1.8 16V, 1.8 16V LPG	06/02-12/13	EYPA, EYPC, EYPD, EYPC	1796			0-N1716	VB [DG]	
1.8 Di, 1.8 TDCi	06/02-12/13	BHPA, P7PA, P7PB, R2PA, HCPA, HCPB, P9PA, P9PB, P9PC, P9PD, R3PA, RWPE, RWPF, RWPA, RWPC, RWPD	1753		→ 05/2007; †; ☼	0-N1458	VB [DG]	
1.8 Di, 1.8 TDCi	06/02-12/13	BHPA, P7PA, P7PB, R2PA, HCPA, HCPB, P9PA, P9PB, P9PC, P9PD, R3PA, RWPE, RWPF, RWPA, RWPC, RWPD	1753			0-N1520	VB [BT]	S
1.8 Di, 1.8 TDCi	06/02-12/13	BHPA, P7PA, P7PB, R2PA, HCPA, HCPB, P9PA, P9PB, P9PC, P9PD, R3PA, RWPE, RWPF, RWPA, RWPC, RWPD	1753			0-N1610	VB [BT]	
1.8 Di, 1.8 TDCi	06/02-12/13	BHPA, P7PA, P7PB, R2PA, HCPA, HCPB, P9PA, P9PB, P9PC, P9PD, R3PA, RWPE, RWPF, RWPA, RWPC, RWPD	1753		→ 04/2007	0-N1942	VB [DG]	
1.8 Di, 1.8 TDCi	06/02-12/13	BHPA, P7PA, P7PB, R2PA, HCPA, HCPB, P9PA, P9PB, P9PC, P9PD, R3PA, RWPE, RWPF, RWPA, RWPC, RWPD	1753		05/2007 →	0-N1942	VB [DG]	

TRANSIT CONNECT Kombi								
1.6 TDCi	02/13-	T1GA, TZGA, TZGB, UBGA	1560		25x141	SK-1728	BTK	

CM³

Art. Nr.

**TRANSIT CONNECT Kombi**

1.6 TDCi	02/13-	T1GA, TZGA, TZGB, UBGA	1560	25x141	SK-1728AQ1	BTKW	
1.6 EcoBoost	02/13-	JQGA	1596		0-N2057	TB [TE]	
1.6 TDCi	02/13-	T1GA, TZGA, TZGB, UBGA	1560		0-N2382	TB [DG]	
1.6 EcoBoost	02/13-	JQGA	1596		0-N2269	VB [BT]	S
1.6 EcoBoost	02/13-	JQGA	1596		0-N2363	VB [DG]	
1.6 TDCi	02/13-	T1GA, TZGA, TZGB, UBGA	1560		0-N1339	VB [BT]	S

TRANSIT CONNECT Kasten

1.6 TDCi	02/13-	T1GA, TZGA, TZGB, UBGA	1560	25x141	SK-1728	BTK	
1.6 TDCi	02/13-	T1GA, TZGA, TZGB, UBGA	1560	25x141	SK-1728AQ1	BTKW	
1.6 EcoBoost	11/13-	JQGA	1596		0-N2057	TB [TE]	
1.6 TDCi	02/13-	T1GA, TZGA, TZGB, UBGA	1560		0-N2382	TB [DG]	
1.0 EcoBoost	02/13-	M2GA	998		0-N2300	VB [BT]	S
1.0 EcoBoost	02/13-	M2GA	998		0-N2303	VB [DG]	
1.0 EcoBoost	02/13-	M2GA	998	✳	0-N2353	VB [DG]	
1.6 EcoBoost	11/13-	JQGA	1596		0-N2269	VB [BT]	S
1.6 EcoBoost	11/13-	JQGA	1596		0-N2363	VB [DG]	
1.6 TDCi	02/13-	T1GA, TZGA, TZGB, UBGA	1560		0-N1339	VB [BT]	S

TRANSIT COURIER Kasten

1.5 TDCi	02/14-	UGCA, UGCB, XUCC, XUCCD	1499	25x141	SK-1728	BTK	
1.5 TDCi	02/14-	UGCA, UGCB, XUCC, XUCCD	1499	25x141	SK-1728AQ1	BTKW	
1.6 TDCi	02/14-	T3CA, T3CB, T3CC	1560	25x141	SK-1728	BTK	
1.6 TDCi	02/14-	T3CA, T3CB, T3CC	1560	25x141	SK-1728AQ1	BTKW	
1.5 TDCi	02/14-	UGCA, UGCB, XUCC, XUCCD, XVCA, XVCB, XVCC	1499		0-N2382	TB [DG]	
1.6 TDCi	02/14-	T3CA, T3CB, T3CC	1560		0-N2382	TB [DG]	
1.5 TDCi	02/14-	UGCA, UGCB, XUCC, XUCCD	1499		0-N1339	VB [BT]	S
1.6 TDCi	02/14-	T3CA, T3CB, T3CC	1560		0-N1339	VB [BT]	S

TRANSIT COURIER Kombi

1.5 TDCi	02/14-	UGCA, UGCB, XUCC, XUCCD	1499	25x141	SK-1728	BTK	
1.5 TDCi	02/14-	UGCA, UGCB, XUCC, XUCCD	1499	25x141	SK-1728AQ1	BTKW	
1.6 TDCi	02/14-	T3CA, T3CB, T3CC	1560	25x141	SK-1728	BTK	
1.6 TDCi	02/14-	T3CA, T3CB, T3CC	1560	25x141	SK-1728AQ1	BTKW	
1.5 TDCi	02/14-	UGCA, UGCB, XUCC, XUCCD, XVCA, XVCB, XVCC	1499		0-N2382	TB [DG]	
1.6 TDCi	02/14-	T3CA, T3CB, T3CC	1560		0-N2382	TB [DG]	
1.5 TDCi	02/14-	UGCA, UGCB, XUCC, XUCCD	1499		0-N1339	VB [BT]	S
1.6 TDCi	02/14-	T3CA, T3CB, T3CC	1560		0-N1339	VB [BT]	S

TRANSIT TOURNEO

2.4 D, 2.5 DI, 2.5 TD	08/94-12/00	4FA, 4FB, 4FC, 4FD, 4GA, 4GB, 4GC, 4HA, 4HA, 4HB, 4HC	2496	25x130; → 07/1997	SK-1049	BTK	
2.4 D, 2.5 DI, 2.5 TD	08/94-12/00	4FA, 4FB, 4FC, 4FD, 4GA, 4GB, 4GC, 4HA, 4HA, 4HB, 4HC	2496	27.6x130; 07/1997 →	SK-1351	BTK	
2.5 TD	04/98-12/00	4EB, 4EC	2496	27.6x130	SK-1351	BTK	
2.5 DI, 2.5 TD	11/94-12/00	4EB, 4EC, 4FA, 4FB, 4FC, 4FD, 4GA, 4GB, 4GC, 4HA, 4HB, 4HC	2496		0-N1361	TB [TE]	
2.0	11/94-12/00	NSH	1998	→ 07/1998; ✳	0-N1401	VB [DG]	
2.0	11/94-12/00	NSH	1998	ABS	0-N1519	VB [BT]	S
2.0	11/94-12/00	NSH	1998		0-N1557S	VB [TE]	
2.4 D, 2.5 DI, 2.5 TD	08/94-12/00	4EB, 4EC, 4FA, 4FB, 4FC, 4FD, 4GA, 4GB, 4GC, 4HA, 4HA, 4HB, 4HC	2496	✳, für Fahrzeuge mit Servolenkung	0-N1957	VB [BT]	S

TRANSIT TOURNEO

2.2 TDCi	07/06-08/14	PGFA, PGFB, UHFA, UHFB, QVFA, QWFA, SRFA, SRFB, SRFC, SRFD, SRFE	2198		0-N1392	VB [DG]	
2.2 TDCi	07/06-08/14	PGFA, PGFB, UHFA, UHFB, QVFA, QWFA, SRFA, SRFB, SRFC, SRFD, SRFE	2198	Rippenanzahl: 6	0-N1460	VB [DG]	
2.2 TDCi	07/06-08/14	PGFA, PGFB, UHFA, UHFB, QVFA, QWFA, SRFA, SRFB, SRFC, SRFD, SRFE	2198		0-N2014	VB [BT]	S



CM³



Art. Nr.



FIESTA							
1.3	02/09-	ZJ	1349			0-N2035	VB [BT] S
1.5	02/09-	ZY-VE	1498			0-N2035	VB [BT] S
FIESTA (GAF)							
1.3	03/03-06/06	C13A9J2	1297			0-N1385	VB [DG]
1.6	03/03-06/06	JL482QA	1598			0-N1385	VB [DG]
FOCUS Schrägheck (CD5)							
1.8	08/06-12/11	CAF483Q, L8-DE	1798			0-N1639	VB [BT] S
1.8	08/06-12/11	CAF483Q, L8-DE	1798	01/2008 →		0-N2353	VB [DG]
2.0	08/06-12/11	CAF488Q, LF-DE	1999			0-N1639	VB [BT] S
2.0	08/06-12/11	CAF488Q, LF-DE	1999	01/2008 →		0-N2353	VB [DG]
MONDEO							
2.0	05/03-	LF-DE	1999	Rippenanzahl: 6		0-N1497	VB [BT] S
MONDEO							
2.0	09/07-	LF-DE	1999	Rippenanzahl: 6		0-N1497	VB [BT] S
2.3	09/07-	L3	2261	Rippenanzahl: 6		0-N1497	VB [BT] S
S-MAX Großraumlimousine (BWS)							
2.3	01/07-	L3	2261	Rippenanzahl: 6		0-N1497	VB [BT] S

CM³

Art. Nr.



ohne Halter

COURIER Pick-up (UF_, UN_)

2.2	02/99-10/02	F2R4	2184	25x110	SK-1226	BTK	
2.5 TD Allrad	02/99-	WL84	2499	30x101	SK-1750	BTK	

ECONOVAN Kasten

2.0, 2.0 4WD	06/97-	FEY9	1998	25x108	SK-1227	BTK	
--------------	--------	------	------	--------	---------	-----	--

LASER / LASER LIDEA (BA_2, BA_3, BA_4, BJ_2)

1.6	10/00-11/03	ZM39, ZM40	1598	22x123	SK-1627	BTK	
-----	-------------	------------	------	--------	---------	-----	--

SPECTRON Pick-up (SD_)

2.2 D	11/87-05/97	R281	2184	25x164; 06/1988 →	SK-1302	BTK	
-------	-------------	------	------	-------------------	---------	-----	--

TELSTAR Stufenheck

2.0	10/84-06/87		1998	22x109	SK-1219	BTK	
2.0	07/87-07/91		1998	25x108; 11/1987 →	SK-1227	BTK	
2.0	07/87-07/91		1998	25x108; Nockenwelle: SOHC/OHC; 11/1987 →	SK-1227	BTK	
2.0	07/87-07/91		1998	25x168; Nockenwelle: DOHC; 11/1987 →	SK-1231	BTK	
2.0	08/91-10/98	FS83, FS84	1991	25x135; mit Zubehör	SK-1221	BTK	
2.2	11/87-07/91	F2D3, F2D4	2184	25x110	SK-1226	BTK	
2.5	08/91-10/95	FLY1	2497	30x192	SK-1457	BTK	

TELSTAR Coupe (GE_)

2.0 GTE	08/91-10/95	FS83, FS84	1991	25x135; mit Zubehör	SK-1221	BTK	
---------	-------------	------------	------	---------------------	---------	-----	--

TELSTAR Schrägheck

2.5	08/91-10/95	FLY1	2497	30x192	SK-1457	BTK	
-----	-------------	------	------	--------	---------	-----	--



CM³



Art. Nr.



ohne Halter

COUGAR Coupe (SW, SX)							
2.5	10/99-03/03	LCBC	2495			0-N290	TB [TE]
F150 Pick-up							
5.8 V8, 5.8 V8 Allrad	10/91-09/96		5766			0-N1684	VB [DG]
F150 Pick-up							
4.6 V8, 4.6 V8 Allrad	10/96-11/03		4601	☼		0-N1718	VB [DG]
F150 Pick-up							
4.2, 4.2 Allrad	10/03-09/07		4192	☼		0-N1684	VB [DG]
4.2, 4.2 Allrad	10/03-09/07		4192			0-N1688	VB [DG]
4.2, 4.2 Allrad	10/03-09/07		4192			0-N1690	VB [DG]
4.6 V8, 4.6 V8 Allrad	10/03-09/07	99W	4601			0-N1684	VB [DG]
5.4 V8 Allrad	02/04-09/07		5403			0-N1684	VB [DG]
F150 Pick-up							
4.2 Allrad	10/07-		4192			0-N1684	VB [DG]
F350 Pick-up							
7.5 V8, 7.5 V8 Allrad	10/91-09/96		7539			0-N1684	VB [DG]
FIESTA Schrägheck (WS)							
1.4 i	10/09-12/10	SPJA	1388	22x117; mit Zubehör		SK-1659	BTK
1.4 i	10/09-12/10	SPJA	1388	22x117; mit Zubehör		SK-1659AQ1	BTKW
1.6 i	10/08-12/10	HXJA	1596	22x117; 01/2009 →; mit Zubehör		SK-1659	BTK
1.6 i	10/08-12/10	HXJA	1596	22x117; 01/2009 →; mit Zubehör		SK-1659AQ1	BTKW
1.6 TDCi	01/09-12/10	HHJD	1560	25x137		SK-1424	BTK
1.6 TDCi	01/09-12/10	HHJD	1560	25x137		SK-1424AQ1	BTKW
1.6 TDCi	01/09-12/10	HHJD	1560			0-N1326	TB [DG]
FIESTA Schrägheck (WP, WQ)							
1.6 i	04/04-12/08	FYJA, FYJB	1596	22x117; → 04/2005; mit Zubehör		SK-1077	BTK
1.6 i	04/04-12/08	FYJA, FYJB	1596	22x117; → 04/2005; mit Zubehör		SK-1077AQ1	BTKW
1.6 i	04/04-12/08	FYJA, FYJB	1596	22x117; 04/2005 →; mit Zubehör		SK-1659	BTK
1.6 i	04/04-12/08	FYJA, FYJB	1596	22x117; 04/2005 →; mit Zubehör		SK-1659AQ1	BTKW
FOCUS Schrägheck (LR)							
2.0 i	09/02-04/05	EDDB	1988	25x129; beinhaltetete Rollen: 2		SK-1340	BTK
1.8 i	09/02-04/05	EYDE	1796			0-N290	TB [TE]
2.0 i	09/02-04/05	EDDB	1988			0-N290	TB [TE]
FOCUS Stufenheck (LR)							
2.0 i	09/02-04/05	EDDB	1988	25x129; beinhaltetete Rollen: 2		SK-1340	BTK
1.8 i	09/02-04/05	EYDE	1796			0-N290	TB [TE]
2.0 i	09/02-04/05	EDDB	1988			0-N290	TB [TE]
FOCUS Schrägheck (LT)							
2.0 TDCi	04/07-03/09	G6DA	1997	25.4x116		SK-1594	BTK
2.0 TDCi	04/07-03/09	G6DA	1997	25.4x116		SK-1594AQ1	BTKW
2.5 i XR5 Turbo	04/06-05/08	HYDA	2522			0-N958	TB [DG]
FOCUS Schrägheck (LV)							
2.5 i XR5 Turbo	03/09-08/11	HYDA	2522			0-N958	TB [DG]
FOCUS Stufenheck (LV)							
2.0 TDCi	03/09-08/11	G6DA	1997	25.4x116		SK-1594	BTK
2.0 TDCi	03/09-08/11	G6DA	1997	25.4x116		SK-1594AQ1	BTKW
MAVERICK Geländewagen geschlossen (DA)							
4.2 TD	02/88-03/94	TD42	4169			0-N034	TB [TE]
4.2 TD	02/88-03/94	TD42	4169			0-N035	TB [DG]
MAVERICK Pick-up (DA)							
4.2 TD	02/88-03/94	TD42	4169			0-N034	TB [TE]
4.2 TD	02/88-03/94	TD42	4169			0-N035	TB [DG]
MAVERICK Pritsche/Fahrgestell (DA)							
4.2 TD	02/88-03/94	TD42	4169			0-N034	TB [TE]
4.2 TD	02/88-03/94	TD42	4169			0-N035	TB [DG]
MONDEO Schrägheck (MA, MB, MC)							
XR5 Turbo	03/07-01/15	HUBA	2521			0-N958	TB [DG]
2.3 i 16 V	03/07-07/10	SEBA	2261			0-N1702	VB [DG]
XR5 Turbo	03/07-01/15	HUBA	2521			0-N1964	VB [BT] S



OPTIMAL®

FORD AUSTRALIA



CM³



Art. Nr.



ohne Halter

MUSTANG Coupe

3.8	09/93-05/99		3797	08/1998 →		0-N1685	VB [DG]	
3.8	09/93-		3797	01/1994 →		0-N1690	VB [DG]	
3.8	09/93-		3797	01/1994 →; ⊗		0-N1695	VB [DG]	
3.8	01/94-05/99		3797			0-N1690	VB [DG]	
3.8	01/94-05/99		3797	⊗		0-N1695	VB [DG]	
4.6 V8	11/95-05/99		4601			0-N1685	VB [DG]	

PROBE (ST, SU, SV)

2.5	07/94-01/98	KL-ZE	2497	30x192		SK-1457	BTK	
2.5	07/94-01/98	KL-ZE	2497			0-N2024	VB [TE]	

TAURUS Stufenheck (DN, DP)

3.0 i	03/96-09/98		2967	Nockenwelle: OHV		0-N1684	VB [DG]	
3.0 i	03/96-09/98		2967			0-N1685	VB [DG]	

TELSTAR Stufenheck (AT)

2.2	11/87-09/89	F2 (12 V)	2184	25x110		SK-1226	BTK	
-----	-------------	-----------	------	--------	--	----------------	-----	--

TELSTAR Schrägheck (AX)

2.5	01/92-08/94	KL-ZE	2497	30x192		SK-1457	BTK	
-----	-------------	-------	------	--------	--	----------------	-----	--

TELSTAR Stufenheck (AX)

2.5	08/94-10/95	KL-ZE	2497	30x192		SK-1457	BTK	
-----	-------------	-------	------	--------	--	----------------	-----	--

TRANSIT Bus (VH, VJ)

2.4 D	01/00-09/06	D2FA, DOFA, F4FA, FXFA, H9FA	2402			0-N1665	VB [DG]	
2.4 D	01/00-09/06	D2FA, DOFA, F4FA, FXFA, H9FA	2402			0-N1719	VB [BT]	S

TRANSIT Pritsche/Fahrgestell (VH, VJ)

2.4 D	01/00-09/06	D2FA, D4FA, DOFA, F4FA, FXFA, H9FA	2402			0-N1665	VB [DG]	
2.4 D	01/00-09/06	D2FA, D4FA, DOFA, F4FA, FXFA, H9FA	2402			0-N1719	VB [BT]	S

TRANSIT Kasten (VM)

2.4 D	07/06-12/14	FXFA	2402			0-N1665	VB [DG]	
2.4 D	07/06-12/14	FXFA	2402			0-N1719	VB [BT]	S



CM³



Art. Nr.



ohne Halter

TAUNUS

1.6	01/89-	1593	19.05x119	SK-1160	BTK
-----	--------	------	-----------	---------	-----



CM³



Art. Nr.



ohne Halter

CONTOUR								
2.0	09/97-08/00		1988	25x131; mit Zubehör		SK-1094	BTK	
CROWN VICTORIA								
4.6	09/91-04/98	99W	4601			0-N1685	VB [DG]	
4.6	09/97-12/06	99W	4601			0-N1685	VB [DG]	
E SERIES Kasten								
4.6	10/01-09/07	99W	4601			0-N1684	VB [DG]	
ESCAPE								
2.0	01/01-02/04		1988			0-N1686	VB [DG]	
2.0	01/01-02/04		1988			0-N1689	VB [DG]	
3.0 4x4	01/01-04/04		2967			0-N1685	VB [DG]	
EXPEDITION								
4.6 XLT	08/96-09/02		4598	☼		0-N1718	VB [DG]	
4.6, 4.6 4x4	08/96-09/02	99W	4601	☼		0-N1718	VB [DG]	
5.4 4x4, 5.4 XLT	08/96-09/02		5403	☼		0-N1718	VB [DG]	
EXPEDITION								
4.6, 4.6 4x4	10/02-02/06	99W	4601	☼		0-N1718	VB [DG]	
5.4 4x4, 5.4 XLT	10/02-02/06		5403	☼		0-N1718	VB [DG]	
EXPLORER (U2)								
4.9 V6 Allrad	01/96-12/01		4949	09/1996 →		0-N1684	VB [DG]	
4.9 V6 Allrad	01/96-12/01		4949	09/1996 →		0-N1689	VB [DG]	
EXPLORER (U251)								
4.6, 4.6 4x4	05/06-12/10		4601			0-N1684	VB [DG]	
4.6, 4.6 4x4	05/06-12/10		4601			0-N1685	VB [DG]	
F-150								
5.8, 5.8 4x4	10/91-09/96		5766			0-N1684	VB [DG]	
F-150								
4.6, 4.6 4x4	10/96-11/03		4601	☼		0-N1718	VB [DG]	
F-150								
4.2, 4.2 4x4	10/03-09/07		4192	☼		0-N1684	VB [DG]	
4.2, 4.2 4x4	10/03-09/07		4192			0-N1688	VB [DG]	
4.2, 4.2 4x4	10/03-09/07		4192			0-N1690	VB [DG]	
4.6 4x4, 4.6 Lariat Supercab 4x4, 4.6 XL Styleside	10/03-09/07	99W	4601			0-N1684	VB [DG]	
5.4 SVT 4x4	02/04-09/07		5403			0-N1684	VB [DG]	
F-150								
4.2 4x4	10/07-		4192			0-N1684	VB [DG]	
F-250								
5.8, 5.8 Allrad	10/88-09/91		5766			0-N1684	VB [DG]	
5.8, 5.8 Allrad	10/88-09/91		5766	Generator-Ladestrom [A]: 60		0-N1688	VB [DG]	
7.5 4x4	10/87-09/91		7539	Generator-Ladestrom [A]: 60		0-N1688	VB [DG]	
7.5, 7.5 4x4	10/87-09/91		7539			0-N1684	VB [DG]	
F-250								
5.8, 5.8 Allrad	10/91-09/96		5766			0-N1684	VB [DG]	
5.8, 5.8 Allrad	10/91-09/96		5766	Generator-Ladestrom [A]: 60		0-N1688	VB [DG]	
7.5, 7.5 4x4	10/91-09/96		7539			0-N1684	VB [DG]	
F-350								
5.8, 5.8 Allrad	10/88-09/96		5766			0-N1684	VB [DG]	
5.8, 5.8 Allrad	10/88-09/96		5766	Generator-Ladestrom [A]: 60		0-N1688	VB [DG]	
7.5, 7.5 D 4x4	10/91-09/96		7539			0-N1684	VB [DG]	
MUSTANG Coupe (C)								
3.8	09/93-05/99		3797	08/1998 →		0-N1685	VB [DG]	
3.8	09/93-		3797	01/1994 →		0-N1690	VB [DG]	
3.8	09/93-		3797	01/1994 →; ☼		0-N1695	VB [DG]	
3.8	01/94-05/99		3797			0-N1690	VB [DG]	
3.8	01/94-05/99		3797	☼		0-N1695	VB [DG]	
3.8	09/98-09/03		3797	☼		0-N1685	VB [DG]	
4.6	11/95-05/99	99W	4601			0-N1685	VB [DG]	
MUSTANG Convertible (C)								
3.8	09/93-05/99		3797	08/1998 →		0-N1685	VB [DG]	
3.8	09/93-05/99		3797			0-N1690	VB [DG]	

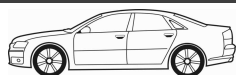

CM³



Art. Nr.



MUSTANG Convertible (C)							
3.8	09/93-05/99		3797	✱		0-N1695	VB [DG]
3.8	06/99-09/03		3797	✱		0-N1685	VB [DG]
4.6	11/95-12/04		4601			0-N1685	VB [DG]
MUSTANG Coupe							
4.0 V6	12/04-12/10		4009			0-N1684	VB [DG]
4.6 V8	12/04-		4601			0-N1684	VB [DG]
MUSTANG Convertible							
4.0 V6	12/05-12/10		4009			0-N1684	VB [DG]
4.6 V8	09/05-		4601			0-N1684	VB [DG]
PROBE I							
2.2, 2.2 GT	08/88-07/93		2184	25x110		SK-1226	BTK
PROBE II (ECP)							
2.0 16V	10/93-03/98	FS	1991	25x135; mit Zubehör		SK-1221	BTK
2.5 V6 24V	10/93-03/98	KL	2497	30x192		SK-1457	BTK
2.0 16V	10/93-03/98	FS	1991	→ 09/1997		0-N077	TB [DG]
2.0 16V	10/93-03/98	FS	1991			0-N078	TB [TE]
2.5 V6 24V	10/93-03/98	KL	2497	mit Anbaumaterial		0-N079	TB [TE]
2.5 V6 24V	10/93-03/98	KL	2497			0-N080	TB [DG]
2.5 V6 24V	10/93-03/98	KL	2497			0-N2160	TB [BT]
2.5 V6 24V	12/94-03/98	KL	2497			0-N081	TB [DG]
2.5 V6 24V	10/93-03/98	KL	2497			0-N2024	VB [TE]
2.5 V6 24V	10/93-03/98	KL	2497			0-N2041	VB [DG]
RANGER							
3.0, 3.0 4x4	10/90-12/96		2986			0-N1684	VB [DG]
3.0, 3.0 4x4	10/90-12/96		2986			0-N1685	VB [DG]
TAURUS (P5_)							
3.0	09/95-		2986			0-N1685	VB [DG]
3.0	09/95-		2986	Nockenwelle: OHV		0-N1687	VB [DG]
3.0	05/96-12/01		2967	Nockenwelle: OHV		0-N1684	VB [DG]
3.0	05/96-12/01		2967			0-N1685	VB [DG]
3.0	11/98-		2986	Nockenwelle: OHV		0-N1684	VB [DG]
3.0 24V	09/96-		2967	Nockenwelle: OHV; 10/1999 →		0-N1684	VB [DG]
3.0 24V	09/96-		2967	10/1999 →		0-N1685	VB [DG]
3.0 V6	03/99-		2986	Nockenwelle: OHV; 10/1999 →		0-N1684	VB [DG]
3.0 V6	03/99-		2986	10/1999 →		0-N1685	VB [DG]
3.4 SHO	05/96-10/98		3392			0-N1685	VB [DG]
TAURUS Wagon (P5_)							
3.0	09/96-12/99		2986			0-N1685	VB [DG]
3.0	09/96-12/99		2986	Nockenwelle: OHV		0-N1687	VB [DG]
3.0	11/98-12/99		2986	Nockenwelle: OHV		0-N1684	VB [DG]
3.0 24V	06/95-12/99		2967	Nockenwelle: OHV; 10/1999 →		0-N1684	VB [DG]
3.0 24V	06/95-12/99		2967	10/1999 →		0-N1685	VB [DG]
3.0 V6	03/99-12/99		2986	Nockenwelle: OHV; 10/1999 →		0-N1684	VB [DG]
3.0 V6	03/99-12/99		2986	10/1999 →		0-N1685	VB [DG]
THUNDERBIRD Coupe							
4.6	01/93-12/97	99W	4601			0-N1685	VB [DG]
WINDSTAR (A3)							
3.0 V6	03/95-02/99		2986			0-N1685	VB [DG]
3.0 V6	03/95-02/99		2986			0-N1687	VB [DG]
3.8	09/00-08/04		3797			0-N1687	VB [DG]
3.8	09/00-08/04		3797			0-N1690	VB [DG]



CM³



Art. Nr.



LANOS Schrägheck

1.4	05/04-10/08	A13SM	1349	17x111; 01/2005 →; mit Zubehör; Baumuster: ATF48	SK-1162	BTK	
1.5	05/04-10/08	A15SM	1498	17x111; mit Zubehör; Baumuster: ATF08	SK-1162	BTK	
1.6 16V	05/04-10/08	A16DMS	1598	25x127; Baumuster: ATF48	SK-1273	BTK	
1.6 16V	05/04-10/08	A16DMS	1598	25x127	SK-1273AQ1	BTKW	
1.6 16V	05/04-10/08	A16DMS	1598		0-N1532	VB [BT]	S
1.4	05/04-10/08	A13SM	1349		0-N2097	FB [DG]	
1.5	05/04-10/08	A15SM	1498		0-N2097	FB [DG]	

LANOS Stufenheck

1.4	05/04-10/08	A13SM	1349	17x111; 01/2005 →; mit Zubehör; Baumuster: ATF69	SK-1162	BTK	
1.5	05/04-10/08	A15SM	1498	17x111; mit Zubehör; Baumuster: ATF69	SK-1162	BTK	
1.6 16V	05/04-10/08	A16DMS	1598	25x127; Baumuster: ATF69	SK-1273	BTK	
1.6 16V	05/04-10/08	A16DMS	1598	25x127	SK-1273AQ1	BTKW	
1.6 16V	05/04-10/08	A16DMS	1598		0-N1532	VB [BT]	S
1.4	05/04-10/08	A13SM	1349		0-N2097	FB [DG]	
1.5	05/04-10/08	A15SM	1498		0-N2097	FB [DG]	

POLONEZ II

1.9 D	08/88-08/92	XUD 9A	1905	25.39x136	SK-1007	BTK	
1.9 D	08/88-08/92	XUD 9A	1905	25.4x136	SK-1007AQ1	BTKW	

POLONEZ III

1.4 i 16V	09/92-03/02	Rover K16 DOHC	1398	23x143; mit Zubehör	SK-1067	BTK	
1.9 D	09/92-03/02	XUD 9A	1905	25.39x136; 09/1993 → 12/1993	SK-1007	BTK	
1.9 D	09/92-03/02	XUD 9A	1905	25.4x136; 09/1993 → 12/1993	SK-1007AQ1	BTKW	
1.9 D	09/92-03/02	XUD 9A	1905	25.4x136; 01/1994 →	SK-1022	BTK	



CM³



Art. Nr.



ohne
Halter

DRAGON Geländewagen geschlossen

1.8	05/07-	1ZZ-FE	1794		0-N1462	VB [BT]	S
-----	--------	--------	------	--	----------------	---------	----------

FREE CRUISER

1.3	04/05-	8A-FE, MR479Q	1342		0-N811	TB [TE]	
1.3	04/05-	8A-FE, MR479Q	1342	❄	0-N1446	VB [DG]	

VISION

1.8	08/06-	JL4G18	1792		0-N1462	VB [BT]	S
-----	--------	--------	------	--	----------------	---------	----------

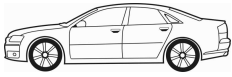

CM³



Art. Nr.



ohne Halter

METRO Stufenheck

1.6 i, 1.6 i 4WD	01/89-12/98	G16B	1590	25x103; 09/1994 →	SK-1245	BTK	
------------------	-------------	------	------	-------------------	----------------	-----	--

TRACKER Station Wagon

1.9 D	12/94-12/98	XUD9	1905	25.4x136	SK-1022	BTK	
-------	-------------	------	------	----------	----------------	-----	--



CM³



Art. Nr.



ohne Halter

S15 JIMMY Geländewagen geschlossen

4.3, 4.3 AWD	01/89-12/94	4293	❄	0-N1685	VB [DG]
--------------	-------------	------	---	---------	---------



OPTIMAL®

HAFEI



CM³



Art. Nr.



ohne Halter

SAIBAO 5 Stufenheck

1.8	01/07-	4 G 93	1834		0-N056	TB [TE]	
-----	--------	--------	------	--	--------	---------	--

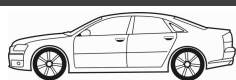

CM³



Art. Nr.



ohne Halter

ASTRA Schrägheck (LB, LC)							
1.6 CD	04/86-06/87	E16	1598			0-N018	TB [TE]
ASTRA Schrägheck (TR)							
1.6 CD	08/95-09/98	Z 16 XE	1598			0-N102	TB [TE]
1.6 CD	08/95-09/98	Z 16 XE	1598			0-N952	TB [DG]
1.6 CD	08/95-09/98	Z 16 XE	1598			0-N953	TB [DG]
1.8 i	09/96-09/98	C 18 XEL	1799			0-N100	TB [TE]
1.8 i	09/96-09/98	C 18 XEL	1799			0-N906	TB [DG]
2.0 GSi	08/95-09/98	X 20 XEV	1998			0-N100	TB [TE]
2.0 GSi	08/95-09/98	X 20 XEV	1998			0-N906	TB [DG]
1.6 CD	08/95-09/98	Z 16 XE	1598	Rippenanzahl: 6		0-N1439	VB [DG]
1.6 CD	08/95-09/98	Z 16 XE	1598	für Fahrzeuge ohne Servolenkung		0-N1464	VB [BT] S
ASTRA Stufenheck (TR)							
1.6 CD	08/95-01/98	X 16 XEL, Z 16 XE	1598			0-N102	TB [TE]
1.6 CD	08/95-01/98	X 16 XEL, Z 16 XE	1598			0-N952	TB [DG]
1.6 CD	08/95-01/98	X 16 XEL, Z 16 XE	1598			0-N953	TB [DG]
1.8 SRi	09/96-09/98	C 18 XEL	1799			0-N100	TB [TE]
1.8 SRi	09/96-09/98	C 18 XEL	1799			0-N906	TB [DG]
ASTRA Cabriolet (TS)							
2.0 i Turbo	06/02-07/04	Z 20 LER, Z 20 LET	1998	→ 12/2003		0-N127	TB [DG]
2.0 i Turbo	06/02-07/04	Z 20 LER, Z 20 LET	1998	01/2004 →		0-N127	TB [DG]
2.0 i Turbo	06/02-07/04	Z 20 LER, Z 20 LET	1998			0-N1369	TB [TE]
2.0 i Turbo	06/02-07/04	Z 20 LER, Z 20 LET	1998	01/2004 →		0-N1574	TB [DG]
ASTRA Stufenheck (TS)							
1.8 i	09/00-10/04	Z 18 XE	1796			0-N102	TB [TE]
1.8 i	09/00-10/04	Z 18 XE	1796	02HL5118, 20041691→; †; mit Anbaumaterial		0-N300	TB [DG]
1.8 i	09/00-10/04	Z 18 XE	1796	02HL5117, 20041690		0-N952	TB [DG]
1.8 i	09/00-10/04	Z 18 XE	1796			0-N953	TB [DG]
1.8 i	09/00-10/04	Z 18 XE	1796			0-N1466	VB [BT] S
ASTRA Schrägheck (TS)							
1.8 i	09/00-10/04	Z 18 XE	1796	20x162; mit Zubehör		SK-1355	BTK
1.8 i	09/00-10/04	Z 18 XE	1796	20x162; mit Zubehör		SK-1355AQ1	BTKW
1.8 i	02/98-10/04	X 18 XE1, Z 18 XE	1796			0-N102	TB [TE]
1.8 i	02/98-10/04	X 18 XE1, Z 18 XE	1796	02HL5118, 20041691→; †; mit Anbaumaterial		0-N300	TB [DG]
1.8 i	02/98-10/04	X 18 XE1, Z 18 XE	1796	02HL5117, 20041690		0-N952	TB [DG]
1.8 i	02/98-10/04	X 18 XE1, Z 18 XE	1796			0-N953	TB [DG]
2.0 i Turbo	05/03-07/04	Z 20 LET	1998			0-N127	TB [DG]
2.0 i Turbo	05/03-07/04	Z 20 LET	1998			0-N1369	TB [TE]
2.0 i Turbo	05/03-07/04	Z 20 LET	1998			0-N1574	TB [DG]
1.8 i	02/98-10/04	X 18 XE1, Z 18 XE	1796			0-N1466	VB [BT] S
ASTRA (AH)							
1.9 CDTI	06/06-03/10	Z 19 DT, Z 19 DT, Z 19 DTH	1910	24x199		SK-1586	BTK
1.8 i	07/05-03/07	Z 18 XE	1796			0-N102	TB [TE]
1.8 i	07/05-03/07	Z 18 XE	1796	†; mit Anbaumaterial		0-N300	TB [DG]
1.8 i	07/05-03/07	Z 18 XE	1796			0-N953	TB [DG]
1.8 i	04/07-03/10	Z 18 XER	1796			0-N1347	TB [TE]
1.9 CDTI	06/06-03/10	Z 19 DT, Z 19 DT, Z 19 DTH	1910			0-N2149	TB [DG]
2.0 i Turbo	07/05-03/10	Z 20 LER	1998			0-N127	TB [DG]
2.0 i Turbo	07/05-03/10	Z 20 LER	1998			0-N1369	TB [TE]
2.0 i Turbo	07/05-03/10	Z 20 LER	1998			0-N1574	TB [DG]
1.8 i	07/05-03/07	Z 18 XE	1796			0-N1466	VB [BT] S
1.8 i	04/07-03/10	Z 18 XER	1796			0-N1799	VB [BT] S
1.9 CDTI	06/06-03/10	Z 19 DT, Z 19 DT, Z 19 DTH	1910	Rippenanzahl: 6		0-N1667	VB [DG]
ASTRA Kombi (AH)							
1.9 CDTI	08/08-03/10	Z 19 D, Z 19 DT	1910	24x199		SK-1586	BTK
1.8 i	04/07-03/10	Z 18 XER	1796			0-N1347	TB [TE]
1.9 CDTI	08/08-03/10	Z 19 D, Z 19 DT	1910			0-N2149	TB [DG]
1.8 i	04/07-03/10	Z 18 XER	1796			0-N1799	VB [BT] S
1.9 CDTI	08/08-03/10	Z 19 D, Z 19 DT	1910	Rippenanzahl: 6		0-N1667	VB [DG]
ASTRA SPORTSBACK (AH)							
1.8 i	07/05-03/08	Z 18 XE	1796			0-N102	TB [TE]
1.8 i	07/05-03/08	Z 18 XE	1796	†; mit Anbaumaterial		0-N300	TB [DG]

CM³

Art. Nr.



ohne Halter

ASTRA SPORTSBACK (AH)							
1.8 i	07/05-03/08	Z 18 XE	1796			0-N953	TB [DG]
1.8 i	04/07-03/10	Z 18 XER	1796			0-N1347	TB [TE]
2.0 i Turbo	06/06-03/10	Z 20 LER	1998			0-N127	TB [DG]
2.0 i Turbo	06/06-03/10	Z 20 LER	1998			0-N1369	TB [TE]
2.0 i Turbo	06/06-03/10	Z 20 LER	1998			0-N1574	TB [DG]
1.8 i	07/05-03/08	Z 18 XE	1796			0-N1466	VB [BT] S
1.8 i	04/07-03/10	Z 18 XER	1796			0-N1799	VB [BT] S
BARINA Schrägheck (MB)							
1.3 GL	02/85-08/86	G13A	1324			0-N018	TB [TE]
BARINA Schrägheck (ML)							
1.3	08/86-12/89	G13A	1324			0-N018	TB [TE]
BARINA Schrägheck (MF)							
1.3 GL	02/89-09/91	G13BA	1298			0-N018	TB [TE]
BARINA Schrägheck (MH)							
1.3 GL	10/91-05/94	G13BA	1298			0-N018	TB [TE]
BARINA Cabriolet (SB)							
1.4 i	11/97-11/00	C 14 SE	1389	Rippenanzahl: 6		0-N1439	VB [DG]
1.4 i	11/97-11/00	C 14 SE	1389	für Fahrzeuge ohne Servolenkung		0-N1464	VB [BT] S
1.4 i	11/97-11/00	C 14 SE	1389			0-N948	TB [TE]
BARINA Schrägheck (SB)							
1.6 i	04/94-08/98	X 16 XE	1598			0-N102	TB [TE]
1.6 i	04/94-08/98	X 16 XE	1598			0-N952	TB [DG]
1.6 i	04/94-08/98	X 16 XE	1598			0-N953	TB [DG]
1.2 i	04/94-07/97	C 12 NZ	1196			0-N948	TB [TE]
1.4 i	04/94-02/01	C 14 NZ, C 14 SE	1389	Rippenanzahl: 6		0-N1439	VB [DG]
1.4 i	04/94-02/01	C 14 NZ, C 14 SE	1389	für Fahrzeuge ohne Servolenkung		0-N1464	VB [BT] S
1.4 i	04/94-02/01	C 14 NZ, C 14 SE	1389			0-N948	TB [TE]
1.6 i	04/94-08/98	X 16 XE	1598	Rippenanzahl: 6		0-N1439	VB [DG]
1.6 i	04/94-08/98	X 16 XE	1598	☞, für Fahrzeuge ohne Servolenkung		0-N1464	VB [BT] S
BARINA Schrägheck (TK)							
1.6 i	03/05-06/12	F16D3	1598			0-N970	TB [TE]
1.6 i	03/05-06/12	F16D3	1598			0-N971	TB [DG]
1.6 i	03/05-06/12	F16D3	1598			0-N1532	VB [BT] S
1.6 i	03/05-06/12	F16D3	1598	Rippenanzahl: 6; ☞		0-N1646	VB [DG]
BARINA Stufenheck (TK)							
1.6 i	11/05-06/12	F16D3	1598			0-N970	TB [TE]
1.6 i	11/05-06/12	F16D3	1598			0-N971	TB [DG]
1.6 i	11/05-06/12	F16D3	1598			0-N1532	VB [BT] S
1.6 i	11/05-06/12	F16D3	1598	Rippenanzahl: 6; ☞		0-N1646	VB [DG]
BARINA Schrägheck (XC)							
1.4 Sfi	09/00-12/05	X 14 XE, Z 14 XE	1389			0-N102	TB [TE]
1.4 Sfi	09/00-12/05	X 14 XE, Z 14 XE	1389	☞☞☞☞:02HL5118, 20041691→; ☞; mit Anbaumaterial		0-N300	TB [DG]
1.4 Sfi	09/00-12/05	X 14 XE, Z 14 XE	1389	☞☞☞☞:→02HL5117, 20041690		0-N952	TB [DG]
1.4 Sfi	09/00-12/05	X 14 XE, Z 14 XE	1389			0-N953	TB [DG]
1.8 SRi	09/00-02/05	Z 18 XE	1796			0-N102	TB [TE]
1.8 SRi	09/00-02/05	Z 18 XE	1796	☞☞☞☞:02HL5118, 20041691→; ☞; mit Anbaumaterial		0-N300	TB [DG]
1.8 SRi	09/00-02/05	Z 18 XE	1796	☞☞☞☞:→02HL5117, 20041690		0-N952	TB [DG]
1.8 SRi	09/00-02/05	Z 18 XE	1796			0-N953	TB [DG]
1.4 Efi	01/04-02/05	Z 14 XEP	1364			0-N2170	VB [BT] S
1.4 Sfi	09/00-12/05	X 14 XE, Z 14 XE	1389			0-N1466	VB [BT] S
1.8 SRi	09/00-02/05	Z 18 XE	1796			0-N1466	VB [BT] S
CALIBRA (YE)							
2.0 i	10/91-07/95	C 20 NE	1998	☞☞☞☞:14608701→		0-N101	TB [TE]
2.0 i 16V	10/91-07/95	C 20 XE	1998	☞☞☞☞:14142839→		0-N100	TB [TE]
2.0 i 16V	10/91-07/95	C 20 XE	1998	☞☞☞☞:→14142838		0-N877	TB [TE]
2.0 i 16V	10/91-07/95	C 20 XE	1998	☞☞☞☞:14142839→		0-N906	TB [DG]
2.0 i 16V	10/91-07/95	C 20 XE	1998	☞☞☞☞:14142839→		0-N907	TB [DG]
2.0 i 16V	07/95-11/97	X 20 XEV	1998			0-N957	TB [DG]
2.0 i Turbo AWD	03/92-11/97	C 20 LET	1998	☞☞☞☞:14002935→		0-N100	TB [TE]
2.0 i Turbo AWD	03/92-11/97	C 20 LET	1998	☞☞☞☞:→14002934		0-N877	TB [TE]



CM³



Art. Nr.



ohne Halter

CALIBRA (YE)							
2.0 i Turbo AWD	03/92-11/97	C 20 LET	1998	:14002935→		0-N906	TB [DG]
2.0 i Turbo AWD	03/92-11/97	C 20 LET	1998	:14002935→		0-N907	TB [DG]
2.5 i V6	07/95-11/97	C 25 XE, X 25 XE	2498			0-N957	TB [DG]
2.5 i V6	07/95-11/97	C 25 XE, X 25 XE	2498	Rippenanzahl: 6;		0-N1438	VB [BT] S
CAPTIVA (CG)							
2.4 i, 2.4 i AWD	12/09-12/11	Z 24 XED	2405			0-N906	TB [DG]
COMBO Kasten (SB)							
1.4 i	03/96-07/97	C 14 NZ	1389	Rippenanzahl: 6		0-N1439	VB [DG]
1.4 i	03/96-07/97	C 14 NZ	1389	für Fahrzeuge ohne Servolenkung		0-N1464	VB [BT] S
1.4 i	03/96-07/97	C 14 NZ	1389	:19311739→		0-N948	TB [TE]
COMBO Kasten (XC)							
1.4 i	04/05-12/12	Z 14 XEP	1364			0-N2170	VB [BT] S
1.6 i	09/02-04/05	Z 16 SE	1598			0-N1466	VB [BT] S
1.6 i	09/02-04/05	Z 16 SE	1598			0-N948	TB [TE]
CRUZE Stufenheck (JG)							
1.8 i	06/09-03/11	F18D	1796			0-N1347	TB [TE]
1.8 i	06/09-03/11	F18D	1796	Rippenanzahl: 6;		0-N1646	VB [DG]
DROVER (QB)							
1.3 4x4	03/85-12/87	G13A	1324			0-N018	TB [TE]
DROVER Pick-up (QB)							
1.3 4x4	03/85-12/87	G13A	1324			0-N018	TB [TE]
FRONTERA (UES)							
2.0 i 4x4	10/95-03/99	X 20 SE	1998			0-N101	TB [TE]
2.2 i 4x4	02/99-07/02	X 22 SE	2198	für Fahrzeuge ohne Katalysator		0-N100	TB [TE]
2.2 i 4x4	02/99-07/02	X 22 SE	2198			0-N906	TB [DG]
JACKAROO (UBS)							
2.3 4x4	08/85-12/88	4ZD1	2254			0-N042	TB [TE]
JACKAROO / MONTEREY (UBS)							
3.0 TD 4x4	03/98-09/04	4JX1-T	2999			0-N2168	TB [TE]
3.2 i 4x4	04/92-02/98	6VD1	3165			0-N2167	TB [DG]
PIAZZA (YB)							
2.0 Turbo	04/85-12/87	4ZC1-T	1994			0-N042	TB [TE]
RODEO Pick-up (KB)							
2.3, 2.3 4x4	08/85-12/88	4ZD1	2254			0-N042	TB [TE]
RODEO Pick-up (TF)							
2.3 i	06/91-08/03	4ZD1	2254			0-N042	TB [TE]
SCURRY Bus (NB)							
1.0	07/85-12/87	F10A	970			0-N017	TB [TE]
SHUTTLE Kasten (WFR)							
2.0	09/83-12/91	4ZC1	1995			0-N042	TB [TE]
TIGRA (XC)							
1.8	09/05-12/07	Z 18 XE	1796			0-N102	TB [TE]
1.8	09/05-12/07	Z 18 XE	1796	; mit Anbaumaterial		0-N300	TB [DG]
1.8	09/05-12/07	Z 18 XE	1796			0-N953	TB [DG]
1.8	09/05-12/07	Z 18 XE	1796			0-N1466	VB [BT] S
VECTRA Schrägheck (JR)							
2.0 i	06/97-12/98	C 20 SEL, X 20 XEV	1998			0-N100	TB [TE]
2.0 i	06/97-12/98	C 20 SEL, X 20 XEV	1998			0-N906	TB [DG]
2.5 i	06/97-12/98	X 25 XE	2498	:08292479→; :→08300418; für OE: 90530599		0-N956	TB [TE]
2.5 i	06/97-12/98	X 25 XE	2498	:→08300418		0-N957	TB [DG]
2.5 i	06/97-12/98	X 25 XE	2498	Rippenanzahl: 6;		0-N1438	VB [BT] S
VECTRA Stufenheck (JR)							
2.0 i	06/97-12/98	C 20 SEL, X 20 XEV	1998			0-N100	TB [TE]
2.0 i	06/97-12/98	C 20 SEL, X 20 XEV	1998			0-N906	TB [DG]
2.5 i	06/97-12/98	X 25 XE	2498	:08292479→; :→08300418; für OE: 90530599		0-N956	TB [TE]
2.5 i	06/97-12/98	X 25 XE	2498	:→08300418		0-N957	TB [DG]
2.5 i	06/97-12/98	X 25 XE	2498	Rippenanzahl: 6;		0-N1438	VB [BT] S



CM³



Art. Nr.



ohne Halter

VECTRA Stufenheck (JS)							
2.0 i	12/98-11/00	C 20 SEL	1998			0-N100	TB [TE]
2.0 i	12/98-11/00	C 20 SEL	1998			0-N906	TB [DG]
2.6 i V6	07/00-07/02	Y 26 SE	2597	Rippenanzahl: 6		0-N1438	VB [BT] S
VECTRA Schrägheck (JS)							
2.0 i	12/98-11/00	C 20 SEL	1998			0-N100	TB [TE]
2.0 i	12/98-11/00	C 20 SEL	1998			0-N906	TB [DG]
2.5 i	08/98-12/02	X 25 XE	2498		→08292479→; →08300418; für OE: 90530599	0-N956	TB [TE]
2.5 i	08/98-12/02	X 25 XE	2498		→08300418	0-N957	TB [DG]
2.5 i	08/98-12/02	X 25 XE	2498	Rippenanzahl: 6; ⚙		0-N1438	VB [BT] S
VIVA Kombi (JF)							
1.8 i	03/05-12/09	F18D3	1796			0-N102	TB [TE]
1.8 i	03/05-12/09	F18D3	1796	†; mit Anbaumaterial		0-N300	TB [DG]
1.8 i	03/05-12/09	F18D3	1796			0-N953	TB [DG]
1.8 i	03/05-12/09	F18D3	1796			0-N1466	VB [BT] S
VIVA Schrägheck (JF)							
1.8 i	03/05-12/09	F18D3	1796			0-N102	TB [TE]
1.8 i	03/05-12/09	F18D3	1796	†; mit Anbaumaterial		0-N300	TB [DG]
1.8 i	03/05-12/09	F18D3	1796			0-N953	TB [DG]
1.8 i	03/05-12/09	F18D3	1796			0-N1466	VB [BT] S
VIVA Stufenheck (JF)							
1.8 i	03/05-12/09	F18D3	1796			0-N102	TB [TE]
1.8 i	03/05-12/09	F18D3	1796	†; mit Anbaumaterial		0-N300	TB [DG]
1.8 i	03/05-12/09	F18D3	1796			0-N953	TB [DG]
1.8 i	03/05-12/09	F18D3	1796			0-N1466	VB [BT] S



CM³



Art. Nr.



ohne Halter

ACCORD [USA]							
2.2	01/91-12/91	F22B	2156			0-N178	TB [TE]
2.2	01/91-12/91	F22B	2156			0-N905	TB [TE]
ACCORD II (AC, AD)							
1.6 EX	09/83-10/85	EZ	1598	24x108		SK-1216	BTK
1.8 EX	09/83-10/85	ET1	1829	24x108		SK-1216	BTK
1.6 EX	09/83-10/85	EZ	1598			0-N981	TB [TE]
1.8 EX	09/83-10/85	ET1	1829			0-N981	TB [TE]
ACCORD II Hatchback (AC, AD)							
1.6 EX	09/83-10/85	EZ	1598	24x108		SK-1216	BTK
1.8 EX	09/83-10/85	ET1	1829	24x108		SK-1216	BTK
1.6 EX	09/83-10/85	EZ	1598			0-N981	TB [TE]
1.8 EX	09/83-10/85	ET1	1829			0-N981	TB [TE]
ACCORD III (CA)							
1.6 L	11/85-12/89	A16A1	1598	24x108		SK-1216	BTK
2.0 EX , 2.0 EXi	11/85-12/89	A20A1, A20A2, A20A3, A20A4	1955	24x108		SK-1216	BTK
1.6 L	11/85-12/89	A16A1	1598			0-N981	TB [TE]
2.0 EX , 2.0 EXi	11/85-12/89	A20A1, A20A2, A20A3, A20A4	1955			0-N981	TB [TE]
2.0 i 16V	01/87-12/89	B20A2, B20A8	1958			0-N982	TB [TE]
ACCORD III Aerodeck (CA)							
2.0, 2.0 EX , 2.0 EXi	11/85-12/89	A20A1, A20A2, A20A3, A20A4	1955	24x108		SK-1216	BTK
1.6 L	11/85-12/89	A16A1	1598			0-N981	TB [TE]
2.0, 2.0 EX , 2.0 EXi	11/85-12/89	A20A1, A20A2, A20A3, A20A4	1955			0-N981	TB [TE]
ACCORD IV (CB)							
1.8	01/90-12/91		1829	24x113; 16x70		SK-1220	BTK
2.0 16V , 2.0 i 16V	01/90-03/93	F20A2, F20A3, F20A4, F20A8, F20A6	1997	24x113; 16x70		SK-1220	BTK
2.2 i 16V , 2.2 i 16V Automatik	01/90-03/93	F22A3	2156	24x113; 16x70		SK-1220	BTK
1.8	01/90-12/91		1829			0-N178	TB [TE]
1.8	01/90-12/91		1829			0-N905	TB [TE]
2.0 16V , 2.0 i 16V	01/90-03/93	F20A2, F20A3, F20A4, F20A8, F20A6	1997			0-N178	TB [TE]
2.0 16V , 2.0 i 16V	01/90-03/93	F20A2, F20A3, F20A4, F20A8, F20A6	1997			0-N905	TB [TE]
2.2 , 2.2 i 16V , 2.2 i 16V Automatik	01/90-10/93	F22A3, F22A6	2156			0-N178	TB [TE]
2.2 , 2.2 i 16V , 2.2 i 16V Automatik	01/90-10/93	F22A3, F22A6	2156			0-N905	TB [TE]
ACCORD IV Aerodeck (CB)							
2.0 i 16V	03/93-12/93	F20Z3	1997	24x113; 16x70		SK-1220	BTK
2.2 , 2.2 i 16V	01/91-12/94	F22A6, F22A7, F22A8	2156	24x113; 16x70		SK-1220	BTK
2.0 i 16V	03/93-12/93	F20Z3	1997			0-N178	TB [TE]
2.0 i 16V	03/93-12/93	F20Z3	1997			0-N905	TB [TE]
2.2 , 2.2 i 16V	01/91-12/94	F22A6, F22A7, F22A8	2156			0-N178	TB [TE]
2.2 , 2.2 i 16V	01/91-12/94	F22A6, F22A7, F22A8	2156			0-N905	TB [TE]
ACCORD IV Coupe (CB, CC)							
2.0 i 16V	01/92-09/93	F20A7	1997	24x113; 16x70		SK-1220	BTK
2.0 i 16V	01/92-09/93	F20A7	1997			0-N178	TB [TE]
2.0 i 16V	01/92-09/93	F20A7	1997			0-N905	TB [TE]
ACCORD V (CC, CD)							
2.0 i, 2.0 i S	03/93-01/96	F20Z1, F20Z2	1997	24x113; 16x70; 06/1993 →		SK-1220	BTK
2.3 i SR	03/93-01/96	H23A3	2259	16x70; 24x127		SK-1218	BTK
2.0 i, 2.0 i S	03/93-01/96	F20Z1, F20Z2	1997			0-N178	TB [TE]
2.0 i, 2.0 i S	03/93-01/96	F20Z1, F20Z2	1997			0-N905	TB [TE]
2.2 Vti	01/94-12/97	F22B1	2156			0-N178	TB [TE]
2.2 Vti	01/94-12/97	F22B1	2156			0-N905	TB [TE]
2.3 i SR	03/93-01/96	H23A3	2259			0-N178	TB [TE]
2.3 i SR	03/93-01/96	H23A3	2259			0-N905	TB [TE]
ACCORD V Aerodeck (CE)							
2.0 i LS 16V	09/93-02/98	F20B3	1997	24x113; 16x70		SK-1220	BTK
2.2 i ES	09/93-02/98	F22B5	2156	24x113; 16x70; 01/1994 →		SK-1220	BTK
2.0 i LS 16V	09/93-02/98	F20B3	1997			0-N178	TB [TE]
2.0 i LS 16V	09/93-02/98	F20B3	1997			0-N905	TB [TE]
2.2 i ES	09/93-02/98	F22B5	2156			0-N178	TB [TE]
2.2 i ES	09/93-02/98	F22B5	2156			0-N905	TB [TE]
ACCORD V Coupe (CD)							
2.0	09/93-12/97	F20B3	1997	24x113; 16x70		SK-1220	BTK

CM³

Art. Nr.

**ACCORD V Coupe (CD)**

2.2 i ES	09/93-02/98	F22B5	2156	24x113; 16x70	SK-1220	BTK	
2.0	09/93-12/97	F20B3	1997		0-N178	TB [TE]	
2.0	09/93-12/97	F20B3	1997		0-N905	TB [TE]	
2.2 i ES	09/93-02/98	F22B5	2156		0-N178	TB [TE]	
2.2 i ES	09/93-02/98	F22B5	2156		0-N905	TB [TE]	

ACCORD V (CE, CF)

1.9 i	02/96-10/98	F18A3	1850	24x113; 16x70	SK-1220	BTK	
2.0 i LS	02/96-10/98	F20Z1	1997	24x113; 16x70	SK-1220	BTK	
2.0 TDi	04/96-10/98	20T2N	1994	28x112; 22x78; mit Zubehör	SK-1102	BTK	
2.2 i VTEC	02/96-10/98	F22Z2	2156	24x112; 16x70	SK-1430	BTK	
2.2 i VTEC	02/96-10/98	F22Z2	2156	24x112; 16x70	SK-1430AQ1	BTKW	
1.9 i	02/96-10/98	F18A3	1850		0-N178	TB [TE]	
1.9 i	02/96-10/98	F18A3	1850		0-N905	TB [TE]	
2.0 i LS	02/96-10/98	F20Z1	1997		0-N178	TB [TE]	
2.0 i LS	02/96-10/98	F20Z1	1997		0-N905	TB [TE]	
2.0 TDi	04/96-10/98	20T2N	1994		0-N1273	TB [TE]	
2.0 TDi	04/96-10/98	20T2N	1994		0-N236	TB [TE]	
2.0 TDi	04/96-10/98	20T2N	1994		0-N237	TB [DG]	
2.2, 2.2 i VTEC	09/95-10/98	F22B1, F22Z2	2156		0-N178	TB [TE]	
2.2, 2.2 i VTEC	09/95-10/98	F22B1, F22Z2	2156		0-N905	TB [TE]	
2.0 TDi	04/96-10/98	20T2N	1994		0-N1535	VB [BT]	S

ACCORD VI (CG, CK)

1.6 i, 1.6 LS	10/98-12/02	D16B6, D16B7	1590	24x104	SK-1277	BTK	
1.6 i, 1.6 LS	10/98-12/02	D16B6, D16B7	1590	24x104	SK-1277AQ1	BTKW	
1.8 i	10/98-12/02	F18B2	1850	24x112; 16x70	SK-1430	BTK	
1.8 i	10/98-12/02	F18B2	1850	24x112; 16x70	SK-1430AQ1	BTKW	
2.0 i	10/98-01/01	F20B6	1997	24x112; 16x70	SK-1430	BTK	
2.0 i	10/98-01/01	F20B6	1997	24x112; 16x70	SK-1430AQ1	BTKW	
2.0 Turbo DI	02/99-12/02	20T2N	1994	28x112; 22x78; mit Zubehör	SK-1102	BTK	
2.3	01/01-06/03	F23A1, F23Z5	2254	24x112; 16x70	SK-1430	BTK	
2.3	01/01-06/03	F23A1, F23Z5	2254	24x112; 16x70	SK-1430AQ1	BTKW	
1.6 i, 1.6 LS	10/98-12/02	D16B6, D16B7	1590		0-N978	TB [TE]	
1.8 i	10/98-12/02	F18B2	1850		0-N178	TB [TE]	
1.8 i	10/98-12/02	F18B2	1850		0-N905	TB [TE]	
2.0 i	10/98-01/01	F20B6	1997		0-N178	TB [TE]	
2.0 i	10/98-01/01	F20B6	1997		0-N905	TB [TE]	
2.0 Turbo DI	02/99-12/02	20T2N	1994		0-N1273	TB [TE]	
2.0 Turbo DI	02/99-12/02	20T2N	1994		0-N236	TB [TE]	
2.0 Turbo DI	02/99-12/02	20T2N	1994		0-N237	TB [DG]	
2.2 Type-R	02/99-12/02	H22A7	2157		0-N068	TB [TE]	
2.2 Type-R	02/99-12/02	H22A7	2157		0-N193	TB [TE]	
2.3	03/97-06/03	F23A1, F23A1, F23Z5	2254		0-N178	TB [TE]	
2.3	03/97-06/03	F23A1, F23A1, F23Z5	2254		0-N905	TB [TE]	
1.6 i, 1.6 LS	10/98-12/02	D16B6, D16B7	1590	01/1999 →	0-N2101	VB [DG]	
1.6 i, 1.6 LS	10/98-12/02	D16B6, D16B7	1590		0-N2102	VB [DG]	
2.0 Turbo DI	02/99-12/02	20T2N	1994		0-N1535	VB [BT]	S

ACCORD VI Aerodeck (CF)

1.6	10/98-12/02	A16A5	1598		0-N978	TB [TE]	
2.3 16 V	02/98-	F23A7	2254		0-N178	TB [TE]	
2.3 16 V	02/98-	F23A7	2254		0-N905	TB [TE]	
1.6	10/98-12/02	A16A5	1598	01/1999 →	0-N2101	VB [DG]	
1.6	10/98-12/02	A16A5	1598		0-N2102	VB [DG]	
2.4 Vtec E	09/03-09/05	K24A2	2354		0-N1850	VB [BT]	S
2.4 Vtec E	09/03-09/05	K24A2	2354		0-N2207	VB [TE]	

ACCORD VI Coupe (CG)

2.0 i 16V	02/98-06/03	F20B5, F20B7	1997	24x112; 16x70	SK-1430	BTK	
2.0 i 16V	02/98-06/03	F20B5, F20B7	1997	24x112; 16x70	SK-1430AQ1	BTKW	
2.0, 2.0 i 16V	02/98-06/03	F20B5, F20B7, F20B7	1997		0-N178	TB [TE]	
2.0, 2.0 i 16V	02/98-06/03	F20B5, F20B7, F20B7	1997		0-N905	TB [TE]	
2.3 VTi	02/98-10/02	F23A3	2254		0-N178	TB [TE]	
2.3 VTi	02/98-10/02	F23A3	2254		0-N905	TB [TE]	
3.0 V6 24V	02/98-06/03	J30A1	2997		0-N1684	VB [DG]	

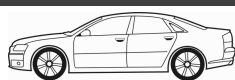

CM³



Art. Nr.



ACCORD VI Hatchback (CH)							
1.6	12/99-12/02	D16B6	1590	24x104	SK-1277	BTK	
1.6	12/99-12/02	D16B6	1590	24x104	SK-1277AQ1	BTKW	
1.8 i	12/99-12/02	F18B2	1850	24x112; 16x70	SK-1430	BTK	
1.8 i	12/99-12/02	F18B2	1850	24x112; 16x70	SK-1430AQ1	BTKW	
2.0	12/99-12/02	F20B6	1997	24x112; 16x70	SK-1430	BTK	
2.0	12/99-12/02	F20B6	1997	24x112; 16x70	SK-1430AQ1	BTKW	
2.0 TDi	12/99-10/00	20T2N	1994	28x112; 22x78; mit Zubehör	SK-1102	BTK	
2.3	11/00-12/02	F23Z5	2254	24x112; 16x70	SK-1430	BTK	
2.3	11/00-12/02	F23Z5	2254	24x112; 16x70	SK-1430AQ1	BTKW	
1.6	12/99-12/02	D16B6	1590		0-N978	TB [TE]	
1.8 i	12/99-12/02	F18B2	1850		0-N178	TB [TE]	
1.8 i	12/99-12/02	F18B2	1850		0-N905	TB [TE]	
2.0	12/99-12/02	F20B6	1997		0-N178	TB [TE]	
2.0	12/99-12/02	F20B6	1997		0-N905	TB [TE]	
2.0 TDi	12/99-10/00	20T2N	1994		0-N1273	TB [TE]	
2.0 TDi	12/99-10/00	20T2N	1994		0-N236	TB [TE]	
2.0 TDi	12/99-10/00	20T2N	1994		0-N237	TB [DG]	
2.3	11/00-12/02	F23Z5	2254		0-N178	TB [TE]	
2.3	11/00-12/02	F23Z5	2254		0-N905	TB [TE]	
1.6	12/99-12/02	D16B6	1590		0-N2102	VB [DG]	
2.0 TDi	12/99-10/00	20T2N	1994		0-N1535	VB [BT]	S
ACCORD VII (CL)							
2.0 , 2.0 Allrad	02/03-05/08	K20A6	1998		0-N2207	VB [TE]	
2.0 , 2.0 Allrad , 2.0 R	02/03-12/08	K20A6	1998		0-N1850	VB [BT]	S
2.2 i-CTDi	01/04-05/08	N22A1	2204		0-N2103	VB [BT]	S
2.4	02/03-05/08	K24A, K24A3, K24A8	2354		0-N1850	VB [BT]	S
2.4	02/03-05/08	K24A, K24A3, K24A8	2354		0-N2207	VB [TE]	
ACCORD VII (CM)							
2.4 Vtec E	09/02-12/05	K24A2, K24A4	2354		0-N1850	VB [BT]	S
2.4 Vtec E	09/02-12/05	K24A2, K24A4	2354		0-N2207	VB [TE]	
ACCORD VII Tourer (CM)							
2.0	04/03-05/08	K20A6	1998		0-N1850	VB [BT]	S
2.0	04/03-05/08	K20A6	1998		0-N2207	VB [TE]	
2.2 i-CTDi	01/04-05/08	N22A1	2204		0-N2103	VB [BT]	S
2.4 , 2.4 Vtec E, 2.4 Vtec T	04/03-05/08	K24A, K24A1, K24A2	2354		0-N1850	VB [BT]	S
2.4 , 2.4 Vtec E, 2.4 Vtec T	04/03-05/08	K24A, K24A1, K24A2	2354		0-N2207	VB [TE]	
2.4 Vtec E	09/03-09/05	K24A2	2354		0-N2033	VB [DG]	
ACCORD VIII (CU)							
2.0 i	07/08-06/15	R20A3	1997	Rippenanzahl: 7	0-N2123	VB [DG]	
2.0 i	07/08-06/15	R20A3	1997		0-N2158	VB [BT]	S
2.2 i-DTEC	07/08-06/15	N22B1, N22B2	2199		0-N2103	VB [BT]	S
2.2 i-DTEC	07/08-06/15	N22B1, N22B2	2199		0-N2400	VB [BT]	S
2.4 , 2.4 i	06/08-06/15	K24Z3	2354		0-N2033	VB [DG]	
2.4 , 2.4 i	06/08-06/15	K24Z3	2354		0-N2399	VB [BT]	S
ACCORD VIII TOURER							
2.0 i	07/08-	R20A3, R20A4	1997	Rippenanzahl: 7	0-N2123	VB [DG]	
2.0 i	07/08-	R20A3, R20A4	1997		0-N2158	VB [BT]	S
2.2 i-DTEC	07/08-	N22B1, N22B2	2199		0-N2103	VB [BT]	S
2.2 i-DTEC	07/08-	N22B1, N22B2	2199		0-N2400	VB [BT]	S
2.4 i	07/08-	K24Z3	2354		0-N2033	VB [DG]	
2.4 i	07/08-	K24Z3	2354		0-N2399	VB [BT]	S
AIRWAVE							
1.5, 1.5 iDSi MDS 4x4	06/04-	L15A2	1497		0-N2210	VB [BT]	S
ASCOT							
2.2 EX	11/90-10/96	F22A7, F22A8	2156		0-N178	TB [TE]	
2.2 EX	11/90-10/96	F22A7, F22A8	2156		0-N905	TB [TE]	
AVANCIER							
2.3, 2.3 4x4	09/99-09/03	F23A	2254		0-N178	TB [TE]	
2.3, 2.3 4x4	09/99-09/03	F23A	2254		0-N905	TB [TE]	
CITY Stufenheck (CG_)							
1.8 D	02/97-11/99	XUD7T	1769		0-N900	TB [DG]	
1.8 D	02/97-11/99	XUD7T	1769		0-N901	TB [TE]	

CM³

Art. Nr.



CITY Stufenheck									
1.3	10/05-	L13A3	1339			0-N1852	VB [DG]		
1.3	10/05-	L13A3	1339			0-N2210	VB [BT]	S	
1.5 FF, 1.5 Vtec	11/02-	L15A1, L15A2, L15AV	1497			0-N2210	VB [BT]	S	
CITY Stufenheck (GM)									
1.4 i-V TEC	09/08-	L13Z1	1339			0-N2210	VB [BT]	S	
1.5	09/08-	L15A7	1497			0-N2210	VB [BT]	S	
CIVIC I Hatchback (SB)									
1200	07/72-02/77	EB1	1169			0-N1781	TB [BT]		
1200	03/77-12/80	EB2, EB3	1238			0-N1781	TB [BT]		
CIVIC I Stufenheck (SF)									
1300 L, 1300 S	10/79-12/84	EN1, EN2, EN4	1335			0-N1781	TB [BT]		
CIVIC II Kombi (WC)									
1300	09/79-09/83	EN1	1335			0-N1781	TB [BT]		
CIVIC II Schrägheck (SS, SL)									
1300 L	09/79-09/83	EN1	1335			0-N1781	TB [BT]		
CIVIC I Shuttle (AN, AR)									
1.3	01/86-12/87	B13B1	1343	24x106		SK-1066	BTK		
1.5, 1.5 4WD	10/83-10/87	EW2	1488			0-N926	TB [TE]		
CIVIC III Hatchback (AL, AJ, AG, AH)									
1.2	01/84-10/87	D12B1, ZA2	1187			0-N926	TB [TE]		
1.3	10/83-10/87	EV2	1342			0-N926	TB [TE]		
1.5 GL, 1.5 GT, 1.5 GTI	10/83-10/87	EW2, EW3, EW4	1488			0-N926	TB [TE]		
CIVIC III Stufenheck (AM, AK, AU)									
1.2	01/85-10/87	D12B1, ZA2	1187			0-N926	TB [TE]		
1.3	10/83-10/87	EV2	1342			0-N926	TB [TE]		
1.5 GL, 1.5 GT, 1.5 GTI	10/83-10/87	EW2, EW3, EW4	1488			0-N926	TB [TE]		
CIVIC IV Hatchback (EC, ED, EE)									
1.3	10/87-12/89	D13B1	1343	24x106; 01/1988 →		SK-1066	BTK		
1.3 16 V	09/89-09/91	D13B2	1343	24x106		SK-1066	BTK		
1.4 L	10/87-12/89	D14A1	1396	24x106; 01/1988 →		SK-1066	BTK		
1.5, 1.5 i 16V	01/88-09/91	D15B1, D15B2	1493	24x106		SK-1066	BTK		
1.6 i 16V	09/87-09/91	D16A7, D16A9	1590	24x124; 01/1988 →		SK-1213	BTK		
1.6 i 16V	10/87-09/91	D16A6, D16Z2	1590	24x107; Nockenwelle: SOHC/OHC		SK-1211	BTK		
1.6 i 16V Vtec	10/89-09/91	B16A1	1595	26x124		SK-1070	BTK		
1.3, 1.3 16 V	10/87-09/91	D13B1, D13B2	1343			0-N927	TB [TE]		
1.4 L	10/87-12/89	D14A1	1396			0-N927	TB [TE]		
1.5 i 16V	10/88-09/91	D15B2	1493			0-N927	TB [TE]		
1.6 i 16V	10/87-09/91	D16A6, D16Z2	1590			0-N927	TB [TE]		
1.6 i 16V Vtec	10/89-09/91	B16A1	1595			0-N979	TB [TE]		
1.5 i 16V	10/88-09/91	D15B2	1493			0-N2100	VB [DG]		
1.6 i 16V	09/87-09/91	D16A7, D16A9	1590	01/1988 →		0-N2100	VB [DG]		
CIVIC IV Stufenheck (ED)									
1.2	01/88-12/91	D12B1	1187	24x106		SK-1066	BTK		
1.3	10/87-12/89	D13B1	1343	24x106; 01/1988 →		SK-1066	BTK		
1.4 L	10/87-12/89	D14A1	1396	24x106		SK-1066	BTK		
1.5 i 16V	10/87-09/91	D15B2	1493	24x106; 01/1988 →		SK-1066	BTK		
1.5, 1.5 i 16V	10/87-09/91	D15B1, D15B2	1493	24x106		SK-1066	BTK		
1.6 16V 4x4	11/87-09/91	D16A6	1590	24x107; Nockenwelle: SOHC/OHC; 06/1989 →		SK-1211	BTK		
1.6 4x4	01/88-12/91		1590	26x124; 01/1989 →		SK-1070	BTK		
1.6 i 16V	09/87-09/91	D16A7	1590	24x107; Nockenwelle: SOHC/OHC; 01/1988 →		SK-1211	BTK		
1.6 i 16V, 1.6 i 16V 4x4	10/87-09/91	D16A6, D16Z2	1590	24x107; Nockenwelle: SOHC/OHC		SK-1211	BTK		
1.6, 1.6 4x4	01/88-12/89	D16Z5	1590	24x124; Nockenwelle: DOHC		SK-1213	BTK		
1.3	10/87-12/89	D13B1	1343			0-N927	TB [TE]		
1.4 L	10/87-12/89	D14A1	1396			0-N927	TB [TE]		
1.5 i 16V	10/87-09/91	D15B2	1493			0-N927	TB [TE]		
1.6 i 16V, 1.6 i 16V 4x4	10/87-09/91	D16A6, D16Z2	1590			0-N927	TB [TE]		
1.6 i 16V	09/87-09/91	D16A6, D16A7, D16Z2	1590	01/1988 →		0-N2100	VB [DG]		
CIVIC II Shuttle (EE)									
1.4 i 16V	01/88-12/92	D14A1	1396	24x106		SK-1066	BTK		
1.5 i 16V	01/88-11/91	D15B2	1493	24x106		SK-1066	BTK		

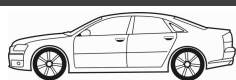

CM³



Art. Nr.



ohne Halter

CIVIC II Shuttle (EE)							
1.6 4x4	01/88-12/92	D16A, D16A7	1590	24x107; Nockenwelle: SOHC/OHC	SK-1211	BTK	
1.6 i 16V 4WD	01/88-02/95	D16A6	1590	24x107	SK-1211	BTK	
1.4 i 16V	01/88-12/92	D14A1	1396		0-N927	TB [TE]	
1.5 i 16V	01/88-11/91	D15B2	1493		0-N927	TB [TE]	
1.6 i 16V 4WD	01/88-02/95	D16A6	1590		0-N927	TB [TE]	
1.6 i 16V 4WD	01/88-02/95	D16A6	1590		0-N2102	VB [DG]	
CIVIC V Coupe (EJ)							
1.5 i LSi	08/93-11/95	D15B7	1493	24x106	SK-1066	BTK	
1.6 i	01/94-11/95	D16Y7	1590	24x104	SK-1277AQ1	BTKW	
1.6 i, 1.6 i Vtec	01/94-03/96	D16Y6, D16Z9, D16Y7	1590	24x104	SK-1277	BTK	
1.6 i Vtec	01/94-03/96	D16Y6, D16Z9	1590	24x104	SK-1277AQ2	BTKW	
1.5 i LSi	08/93-11/95	D15B7	1493		0-N927	TB [TE]	
1.6 i	01/94-11/95	D16Y7	1590		0-N978	TB [TE]	
1.6 i Vtec	01/94-03/96	D16Y6, D16Z9	1590		0-N927	TB [TE]	
1.6 i Vtec	01/94-11/95	B16A2	1595		0-N979	TB [TE]	
CIVIC V Hatchback (EG)							
1.3 16V	10/91-11/95	D13B2	1343	24x106; 01/1992 →	SK-1066	BTK	
1.5 i 16V	10/91-11/95	D15B2	1493	24x106	SK-1066	BTK	
1.5 i 16V	10/91-11/95	D15B2, D15Z2	1493	24x103	SK-1288	BTK	
1.6 VTi 16V	10/91-11/95	B16A2	1595	26x124; 01/1992 →	SK-1070	BTK	
1.3 16V	10/91-11/95	D13B2	1343		0-N927	TB [TE]	
1.5 i 16V	10/91-11/95	D15B2, D15Z1, D15B2, D15Z2	1493		0-N927	TB [TE]	
1.6 16V Vtec	10/91-11/95	D16Z6	1590		0-N978	TB [TE]	
1.6 VTi 16V	10/91-11/95	B16A2	1595		0-N979	TB [TE]	
1.3 16V	10/91-11/95	D13B2	1343	01/1994 → 12/1994	0-N2100	VB [DG]	
1.3 16V	10/91-11/95	D13B2	1343	01/1995 →	0-N2101	VB [DG]	
1.5 i 16V	10/91-11/95	D15B2, D15Z2	1493	01/1992 → 12/1994	0-N2100	VB [DG]	
1.5 i 16V	10/91-11/95	D15B2, D15Z2	1493	01/1995 →	0-N2101	VB [DG]	
1.6 16V Vtec	10/91-11/95	D16Z6	1590	01/1994 → 12/1994	0-N2100	VB [DG]	
1.6 16V Vtec	10/91-11/95	D16Z6	1590	01/1995 →	0-N2101	VB [DG]	
CIVIC V Stufenheck (EG, EH)							
1.3	01/92-12/92	D13B2	1343	24x106	SK-1066	BTK	
1.5	10/93-12/95	D15B7	1493	24x103	SK-1288	BTK	
1.5	10/93-12/95	D15Z1	1493	24x103	SK-1288	BTK	
1.5, 1.5 i 16V	10/91-12/95	D15B2, D15B2, D15Z1	1493	24x106	SK-1066	BTK	
1.6 4x4	01/92-10/95	D16Z7	1590	24x104	SK-1277	BTK	
1.6 4x4	01/92-10/95	D16Z7	1590	24x104	SK-1277AQ2	BTKW	
1.6 VTi	10/91-11/95	B16A2	1595	26x124; 01/1992 →	SK-1070	BTK	
1.5 i 16V	10/91-11/95	D15B2, D15Z1	1493		0-N927	TB [TE]	
1.6, 1.6 16V Vtec, 1.6 4x4	10/91-11/95	D16Y1, D16Z6, D16Z6, D16Z7, D16Z7	1590		0-N978	TB [TE]	
1.6 VTi	10/91-11/95	B16A2	1595		0-N979	TB [TE]	
1.5 i 16V	10/91-11/95	D15B2, D15Z1	1493	01/1992 → 12/1994	0-N2100	VB [DG]	
1.5 i 16V	10/91-11/95	D15B2, D15Z1	1493	01/1995 →	0-N2101	VB [DG]	
1.6 16V Vtec	10/91-11/95	D16Z6, D16Z7	1590	01/1992 → 12/1994	0-N2100	VB [DG]	
1.6 16V Vtec	10/91-11/95	D16Z6, D16Z7	1590	01/1995 →	0-N2101	VB [DG]	
CIVIC VI Aerodeck (MB, MC)							
1.4 16V	04/98-02/01	D14A7, D14A8	1396	24x103	SK-1288	BTK	
1.4 16V	04/98-02/01	D14A7, D14A8	1396	24x103	SK-1288AQ1	BTKW	
1.5 16V	04/98-02/01	D15Z8	1493	24x103	SK-1288	BTK	
1.5 16V	04/98-02/01	D15Z8	1493	24x103	SK-1288AQ1	BTKW	
1.6 16V	04/98-02/01	D16B2, D16W4	1590	24x104	SK-1277	BTK	
1.6 16V	04/98-02/01	D16B2, D16W4	1590	24x104	SK-1277AQ1	BTKW	
2.0 i D	04/98-02/01	20T2N	1994	28x112; 22x78; mit Zubehör	SK-1102	BTK	
1.4 16V	04/98-02/01	D14A7, D14A8	1396		0-N978	TB [TE]	
1.5 16V	04/98-02/01	D15Z8	1493		0-N978	TB [TE]	
1.6 16V	04/98-02/01	D16B2, D16W4	1590		0-N978	TB [TE]	
1.8 16V	04/98-02/01	B18C4	1797		0-N979	TB [TE]	
2.0 i D	04/98-02/01	20T2N	1994		0-N1273	TB [TE]	
2.0 i D	04/98-02/01	20T2N	1994		0-N236	TB [TE]	
2.0 i D	04/98-02/01	20T2N	1994		0-N237	TB [DG]	
1.4 16V	04/98-02/01	D14A7, D14A8	1396		0-N2102	VB [DG]	
1.5 16V	04/98-02/01	D15Z8	1493		0-N2102	VB [DG]	
1.6 16V	04/98-02/01	D16B2, D16W4	1590		0-N2102	VB [DG]	
1.8 16V	04/98-02/01	B18C4	1797		0-N2102	VB [DG]	



OPTIMAL®

HONDA



CM³



Art. Nr.



CIVIC VI Aerodeck (MB, MC)								
2.0 i D	04/98-02/01	20T2N	1994			0-N1535	VB [BT]	S
CIVIC VI Coupe (EJ, EM1)								
1.6 i Vtec	04/99-12/00	B16A2	1595	26x124		SK-1070	BTK	
1.6 i, 1.6 i Vtec	03/96-03/00	D16Y7, D16Y8	1590	24x104		SK-1277	BTK	
1.6 i, 1.6 i Vtec	03/96-03/00	D16Y7, D16Y8	1590	24x104		SK-1277AQ1	BTKW	
1.6 i Vtec	04/99-12/00	B16A2	1595			0-N979	TB [TE]	
1.6, 1.6 i, 1.6 i Vtec	03/96-03/00	D16Y7, D16Y8	1590			0-N978	TB [TE]	
1.6 i Vtec	04/99-12/00	B16A2	1595	⊛		0-N2102	VB [DG]	
1.6, 1.6 i, 1.6 i Vtec	03/96-03/00	D16Y7, D16Y8	1590			0-N2101	VB [DG]	
1.6, 1.6 i, 1.6 i Vtec	03/96-03/00	D16Y7, D16Y8	1590			0-N2102	VB [DG]	
CIVIC VI Fastback (MA, MB)								
1.4 i	09/94-02/01	D14A2	1396	24x106; 06/1995 →		SK-1066	BTK	
1.4 i	09/94-02/01	D14A4, D14Z2	1396	24x103		SK-1288	BTK	
1.4 i	09/94-02/01	D14Z4	1396	24x103		SK-1288	BTK	
1.4 i	09/94-02/01	D14A4, D14Z2	1396	24x103		SK-1288AQ1	BTKW	
1.4 i	09/94-02/01	D14Z4	1396	24x103		SK-1288AQ1	BTKW	
1.4 i	09/95-02/01	D14A5	1396	24x106		SK-1066	BTK	
1.4 i	09/95-02/01	D14A3, D14A7	1396	24x103		SK-1288	BTK	
1.4 i	09/95-02/01	D14Z1, D14Z3	1396	24x103		SK-1288	BTK	
1.4 i	09/95-02/01	D14A3, D14A7	1396	24x103		SK-1288AQ1	BTKW	
1.4 i	09/95-02/01	D14Z1, D14Z3	1396	24x103		SK-1288AQ1	BTKW	
1.5 16V	01/97-02/01	D15Z8	1493	24x103		SK-1288AQ1	BTKW	
1.5 16V, 1.5 i Vtec-E	09/94-02/01	D15Z3, D15Z8	1493	24x103		SK-1288	BTK	
1.6	11/98-10/00	D16W4	1590	24x104		SK-1277	BTK	
1.6 16V	01/97-02/01	D16B2	1590	24x104; TÜrenanzahl 5		SK-1277	BTK	
1.6 i	09/94-01/97	D16Y3	1590	24x107; Nockenwelle: SOHC/OHC; 11/1995 →; TÜrenanzahl 5		SK-1211	BTK	
1.6 i Vtec	09/94-01/97	D16Y2	1590	24x107; Nockenwelle: DOHC; 11/1995 →; TÜrenanzahl 5		SK-1211	BTK	
1.6 VTi	01/97-02/01	B16A2	1595	26x124		SK-1070	BTK	
1.6, 1.6 16V	01/97-02/01	D16B2, D16W4	1590	24x104		SK-1277AQ1	BTKW	
2.0 i TD, 2.0 TDiC	01/97-02/01	20T2N, 20T2R	1994	28x112; 22x78; mit Zubehör		SK-1102	BTK	
1.4 i	09/94-02/01	D14A2, D14A6, D14A8, D14Z4, D14A5, D14A7, D14Z3	1396			0-N927	TB [TE]	
1.5 16V, 1.5 i Vtec-E	09/94-02/01	D15Z3, D15Z8	1493			0-N978	TB [TE]	
1.6 i	09/94-01/97	D16Y3	1590			0-N927	TB [TE]	
1.6 VTi	01/97-02/01	B16A2	1595			0-N979	TB [TE]	
1.6, 1.6 16V, 1.6 i Vtec	09/94-02/01	D16B2, D16W4, D16Y2	1590			0-N978	TB [TE]	
1.8 16V	01/97-02/01	B18C4	1797			0-N979	TB [TE]	
2.0 i TD, 2.0 TDiC	01/97-02/01	20T2N, 20T2R	1994			0-N1273	TB [TE]	
2.0 i TD, 2.0 TDiC	01/97-02/01	20T2N, 20T2R	1994			0-N236	TB [TE]	
2.0 i TD, 2.0 TDiC	01/97-02/01	20T2N, 20T2R	1994			0-N237	TB [DG]	
1.4 i	09/94-02/01	D14A2	1396	01/1995 → 12/1996		0-N2101	VB [DG]	
1.4 i	09/94-02/01	D14A2, D14A6, D14A8, D14Z4, D14A5, D14A7, D14Z3	1396			0-N2102	VB [DG]	
1.4 i	09/95-02/01	D14A5, D14A7, D14Z3	1396	→ 12/1997		0-N2101	VB [DG]	
1.5 16V	01/97-02/01	D15Z8	1493	→ 12/1997		0-N2101	VB [DG]	
1.5 16V	01/97-02/01	D15Z8	1493			0-N2102	VB [DG]	
1.5 i Vtec-E	09/94-01/97	D15Z3	1493	01/1995 → 12/1996		0-N2101	VB [DG]	
1.6 16V	01/97-02/01	D16B2	1590	→ 12/1997		0-N2101	VB [DG]	
1.6 i, 1.6 i Vtec	09/94-01/97	D16Y2, D16Y3	1590	01/1995 → 12/1996		0-N2101	VB [DG]	
1.6 VTi	01/97-02/01	B16A2	1595			0-N2102	VB [DG]	
1.6, 1.6 16V	01/97-02/01	D16B2, D16W4	1590			0-N2102	VB [DG]	
2.0 i TD, 2.0 TDiC	01/97-02/01	20T2N, 20T2R	1994			0-N1535	VB [BT]	S
CIVIC VI Hatchback (EJ, EK)								
1.4 i	11/95-02/01	D14A3, D14A7	1396	24x103		SK-1288	BTK	
1.4 i	11/95-02/01	D14Z1, D14Z3	1396	24x103		SK-1288	BTK	
1.4 i	11/95-02/01	D14A3, D14A7	1396	24x103		SK-1288AQ1	BTKW	
1.4 i	11/95-02/01	D14Z1, D14Z3	1396	24x103		SK-1288AQ1	BTKW	
1.4 i, 1.4 i S	11/95-02/01	D14A3, D14Z1, D14A4, D14Z2, D14Z4	1396	24x106		SK-1066	BTK	
1.4 i S	11/95-02/01	D14A4, D14Z2	1396	24x103		SK-1288	BTK	
1.4 i S	11/95-02/01	D14Z4	1396	24x103		SK-1288	BTK	
1.4 i S	11/95-02/01	D14A4, D14Z2	1396	24x103		SK-1288AQ1	BTKW	
1.4 i S	11/95-02/01	D14Z4	1396	24x103		SK-1288AQ1	BTKW	
1.4 LPG	01/97-02/01	D14Z4	1396	24x103		SK-1288	BTK	

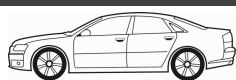

CM³



Art. Nr.



ohne Halter

CIVIC VI Hatchback (EJ, EK)

1.4 LPG	01/97-02/01	D14Z4	1396	24x103	SK-1288AQ1	BTKW	
1.5	11/95-12/96	D15Z1, D15Z3	1493	24x103	SK-1288	BTK	
1.5 i	11/95-02/01	D15Z6	1493	24x103	SK-1288	BTK	
1.5 i	11/95-02/01	D15Z6	1493	24x103	SK-1288AQ1	BTKW	
1.6	10/95-09/00	D16Y2	1590	24x107; Nockenwelle: SOHC/OHC; Türenanzahl 5	SK-1211	BTK	
1.6	11/98-10/00	D16W4	1590	24x104	SK-1277	BTK	
1.6 i	11/95-02/01	D16Y5	1590	24x104; Türenanzahl 3, 4	SK-1277	BTK	
1.6 VTi	11/95-02/01	B16A2	1595	26x124	SK-1070	BTK	
1.6, 1.6 i	11/95-02/01	D16W4, D16Y5	1590	24x104	SK-1277AQ1	BTKW	
2.0 TDiC	11/98-10/00	20T2N	1994	28x112; 22x78; mit Zubehör	SK-1102	BTK	
1.4 i, 1.4 i S	11/95-02/01	D14A3, D14Z1, D14A4, D14Z2, D14Z4	1396		0-N978	TB [TE]	
1.5, 1.5 i	11/95-02/01	D15Z3, D15Z6	1493		0-N978	TB [TE]	
1.6 VTi	11/95-02/01	B16A2	1595		0-N979	TB [TE]	
1.6, 1.6 i	10/95-02/01	D16A7, D16W4, D16Y2, D16Y5	1590		0-N978	TB [TE]	
2.0 TDiC	11/98-10/00	20T2N	1994		0-N1273	TB [TE]	
2.0 TDiC	11/98-10/00	20T2N	1994		0-N236	TB [TE]	
2.0 TDiC	11/98-10/00	20T2N	1994		0-N237	TB [DG]	
1.4 i, 1.4 i S	11/95-02/01	D14A3, D14Z1, D14A4, D14Z2, D14Z4	1396	Kompressor-ID: Hadsys; 01/1996 → 12/2000	0-N2101	VB [DG]	
1.4 i, 1.4 i S	11/95-02/01	D14A3, D14Z1, D14A4, D14Z2, D14Z4	1396	Kompressor-ID: Denso; 01/1996 → 12/2000	0-N2102	VB [DG]	
1.5 i	11/95-02/01	D15Z6	1493	Kompressor-ID: Hadsys; 01/1996 → 12/2000	0-N2101	VB [DG]	
1.5 i	11/95-02/01	D15Z6	1493	Kompressor-ID: Denso; 01/1996 → 12/2000	0-N2102	VB [DG]	
1.6	10/95-10/00	D16A7, D16W4, D16Y2	1590		0-N2102	VB [DG]	
1.6 i	11/95-02/01	D16Y5	1590	Kompressor-ID: Hadsys; 01/1996 → 12/2000	0-N2101	VB [DG]	
1.6 i	11/95-02/01	D16Y5	1590	Kompressor-ID: Denso; 01/1996 → 12/2000	0-N2102	VB [DG]	
1.6 VTi	11/95-02/01	B16A2	1595		0-N2102	VB [DG]	
2.0 TDiC	11/98-10/00	20T2N	1994		0-N1535	VB [BT]	S

CIVIC VI Stufenheck (EJ, EK)

1.4, 1.4 i	11/95-02/01	D14A4, D14A4, D14Z2, D14Z4	1396	24x103	SK-1288	BTK	
1.4, 1.4 i	11/95-02/01	D14A4, D14A4, D14Z2, D14Z4	1396	24x103	SK-1288AQ1	BTKW	
1.5 i	11/95-02/01	D15Z6	1493	24x103	SK-1288	BTK	
1.5 i	11/95-02/01	D15Z6	1493	24x103	SK-1288AQ1	BTKW	
1.6 i Vtec	11/95-02/01	D16Y6, D16Y8	1590	24x104; Baumuster: Ballade	SK-1277	BTK	
1.6 i Vtec	11/95-02/01	D16Y6, D16Y8	1590	24x104; Türenanzahl 3, 4	SK-1277	BTK	
1.6 i Vtec	11/95-02/01	D16Y6, D16Y8	1590	24x104	SK-1277AQ1	BTKW	
1.6 i Vtec	11/95-02/01	D16Y6, D16Y8	1590	24x104; Baumuster: Ballade	SK-1277AQ2	BTKW	
1.6 VTi	11/95-02/01	B16A2	1595	26x124	SK-1070	BTK	
1.4, 1.4 i	11/95-02/01	D14A4, D14A4, D14Z2, D14Z4	1396		0-N978	TB [TE]	
1.5 i	11/95-02/01	D15Z6	1493		0-N978	TB [TE]	
1.6 VTi	11/95-02/01	B16A2	1595		0-N979	TB [TE]	
1.6, 1.6 i Vtec	10/95-02/01	D16Y2, D16Y6, D16Y8	1590		0-N978	TB [TE]	
1.7	11/97-03/01	D17A6	1668		0-N1330	TB [TE]	
1.4	11/95-10/98	D14A4	1396	Kompressor-ID: Hadsys; 01/1996 →	0-N2101	VB [DG]	
1.4	11/95-10/98	D14A4	1396	Kompressor-ID: Denso; 01/1996 →	0-N2102	VB [DG]	
1.4 i	11/95-02/01	D14A4, D14Z2, D14Z4	1396	Kompressor-ID: Hadsys; 01/1996 → 12/2000	0-N2101	VB [DG]	
1.4 i	11/95-02/01	D14A4, D14Z2, D14Z4	1396	Kompressor-ID: Denso; 01/1996 → 12/2000	0-N2102	VB [DG]	
1.5 i	11/95-02/01	D15Z6	1493	Kompressor-ID: Hadsys; 01/1996 → 12/2000	0-N2101	VB [DG]	
1.5 i	11/95-02/01	D15Z6	1493	Kompressor-ID: Denso; 01/1996 → 12/2000	0-N2102	VB [DG]	
1.6	10/95-12/00	D16Y2	1590		0-N2102	VB [DG]	
1.6 i Vtec	11/95-02/01	D16Y6, D16Y8	1590	01/2000 → 12/2000	0-N2101	VB [DG]	
1.6 VTi	11/95-02/01	B16A2	1595		0-N2102	VB [DG]	

CIVIC VII Coupe (EM2)

1.7 i, 1.7 i VTEC	05/01-12/05	D17A5, D17A9, D17A8	1668	22x104; mit Zubehör	SK-1590	BTK	
1.7 i, 1.7 i VTEC	05/01-12/05	D17A5, D17A9, D17A8	1668	22x104; mit Zubehör	SK-1590AQ1	BTKW	
1.6 i	02/01-12/05	D16V1	1590		0-N1330	TB [TE]	
1.7 i, 1.7 i VTEC	05/01-12/05	D17A5, D17A9, D17A8	1668		0-N1330	TB [TE]	

CIVIC VII Hatchback (EU, EP, EV)

1.4 i, 1.4 i S	02/01-09/05	D14Z5, D14Z6, D14Z6	1396	22x103; mit Zubehör	SK-1591	BTK	
1.6 i	02/01-09/05	D16V1	1590	22x104; mit Zubehör	SK-1590	BTK	
1.6 i	02/01-09/05	D16V1	1590	22x104; mit Zubehör	SK-1590AQ1	BTKW	
1.7	01/00-08/05	D17A6	1668	22x104; 01/2002 →; mit Zubehör	SK-1590	BTK	
1.7	01/00-08/05	D17A6	1668	22x104; mit Zubehör	SK-1590AQ1	BTKW	
1.7 CTDi	01/02-09/05	4EE-2	1686	25x129; mit Zubehör	SK-1612	BTK	
1.4 i, 1.4 i S	02/01-09/05	D14Z5, D14Z6, D14Z6	1396		0-N1330	TB [TE]	

CM³

Art. Nr.

**CIVIC VII Hatchback (EU, EP, EV)**

1.6 i	02/01-09/05	D16V1	1590		0-N1330	TB [TE]	
1.7	01/00-08/05	D17A6	1668		0-N1330	TB [TE]	
1.7 CTDi	01/02-09/05	4EE-2	1686		0-N1085	TB [TE]	
1.7 CTDi	01/02-09/05	4EE-2	1686		0-N878	TB [DG]	
1.7 CTDi	01/02-09/05	4EE-2	1686		0-N1798	VB [BT]	S
2.0 i Sport, 2.0 Type-R	09/01-09/05	K20A2, K20A3	1998		0-N1812	VB [BT]	S
2.0 i Sport, 2.0 Type-R	09/01-09/05	K20A2, K20A3	1998		0-N2033	VB [DG]	
2.0 i Sport, 2.0 Type-R	09/01-09/05	K20A2, K20A3	1998		0-N2207	VB [TE]	

CIVIC VII Stufenheck (ES)

1.4	12/00-09/05	D14Z5	1396	22x103; mit Zubehör	SK-1591	BTK	
1.6	02/01-09/05	D16V1	1590	22x104; mit Zubehör	SK-1590	BTK	
1.6	02/01-09/05	D16V1	1590	22x104; mit Zubehör	SK-1590AQ1	BTKW	
1.7	02/01-09/05	D17A6	1668	22x104; mit Zubehör	SK-1590	BTK	
1.4	12/00-09/05	D14Z5	1396		0-N1330	TB [TE]	
1.6	02/01-09/05	D16V1	1590		0-N1330	TB [TE]	
1.7	02/01-09/05	D17A6	1668		0-N1330	TB [TE]	
1.3 IMA	01/04-09/05	LDA1	1339		0-N2102	VB [DG]	
1.6	02/01-09/05	R16A1	1586		0-N1851	VB [BT]	S
1.6	02/01-09/05	R16A1	1586	Rippenanzahl: 7	0-N2123	VB [DG]	
1.8	02/01-09/05	R18A1	1799		0-N1851	VB [BT]	S
1.8	02/01-09/05	R18A1	1799	Rippenanzahl: 7	0-N2123	VB [DG]	
2.0	10/03-09/05	K20A3	1998		0-N2033	VB [DG]	
2.0	10/03-09/05	K20A3	1998		0-N2207	VB [TE]	

CIVIC VIII Hatchback (FN, FK)

1.4	09/05-	L13A7, L13Z1	1339		0-N1852	VB [DG]	
1.4	09/05-	L13A7, L13Z1	1339		0-N2210	VB [BT]	S
1.6	09/05-	R16A1	1586	→ 12/2006	0-N1851	VB [BT]	S
1.6	09/05-	R16A1	1586	Rippenanzahl: 7	0-N2123	VB [DG]	
1.6	09/05-	R16A1	1586	01/2007 →	0-N2158	VB [BT]	S
1.8	09/05-	R18A2	1799	→ 12/2006	0-N1851	VB [BT]	S
1.8	09/05-	R18A2	1799	Rippenanzahl: 7	0-N2123	VB [DG]	
1.8	09/05-	R18A2	1799	01/2007 →	0-N2158	VB [BT]	S
2.2 CTDi	09/05-	N22A2	2204		0-N2103	VB [BT]	S
Type R	09/06-	K20Z4	1998		0-N1850	VB [BT]	S
Type R	09/06-	K20Z4	1998		0-N2033	VB [DG]	
Type R	09/06-	K20Z4	1998		0-N2207	VB [TE]	

CIVIC VIII Stufenheck (FD, FA)

1.6	09/05-	R16A1	1586	→ 12/2006	0-N1851	VB [BT]	S
1.6	09/05-	R16A1	1586	Rippenanzahl: 7	0-N2123	VB [DG]	
1.6	09/05-	R16A1	1586	01/2007 →	0-N2158	VB [BT]	S
1.8	09/05-02/12	R18A1, R18A2	1799	→ 12/2006	0-N1851	VB [BT]	S
1.8	09/05-02/12	R18A1, R18A2	1799	Rippenanzahl: 7	0-N2123	VB [DG]	
1.8	09/05-02/12	R18A1, R18A2	1799	01/2007 →	0-N2158	VB [BT]	S
2.0 i-VTEC Type R	08/07-09/10		1998		0-N1850	VB [BT]	S
2.0, 2.0 i-VTEC Type R	02/06-02/12	K20A3, K20Z2	1998		0-N2207	VB [TE]	

CONCERTO (HW, MA)

1.4	08/89-10/92	D14A1, D14A1, D14A8	1396	24x106	SK-1066	BTK	
1.5 i 16V	08/89-03/95	D15B2	1493	24x106	SK-1066	BTK	
1.6 16V, 1.6 i 16V	08/89-03/95	D16Z2	1590	24x107	SK-1211	BTK	
1.6, 1.6 i 16V	08/89-03/95	D16A8, D16A9	1590	24x124	SK-1213	BTK	
1.8 TD	08/94-10/96	XUD7T	1769	25.4x136	SK-1022	BTK	
1.4	08/89-10/91	D14A8	1396		0-N978	TB [TE]	
1.4	10/89-10/92	D14A1	1396		0-N927	TB [TE]	
1.5 i 16V	08/89-03/95	D15B2	1493		0-N927	TB [TE]	
1.6 i 16V	08/89-03/95	D16A8, D16Z2	1590		0-N927	TB [TE]	
1.8 TD	08/94-10/96	XUD7T	1769		0-N900	TB [DG]	
1.8 TD	08/94-10/96	XUD7T	1769		0-N901	TB [TE]	

CONCERTO Stufenheck (HWW)

1.4	08/89-10/92	D14A1, D14A1, D14A8	1396	24x106	SK-1066	BTK	
1.5 i 16V	08/89-05/95	D15B2	1493	24x106	SK-1066	BTK	
1.6 16V, 1.6 i 16V	08/89-03/95	D16Z2	1590	24x107	SK-1211	BTK	
1.6, 1.6 i 16V	08/89-03/95	D16A8, D16A9	1590	24x124	SK-1213	BTK	
1.4	08/89-10/91	D14A8	1396		0-N978	TB [TE]	



CM³



Art. Nr.



ohne Halter

CONCERTO Stufenheck (HWW)							
1.4	10/89-10/92	D14A1	1396		0-N927	TB [TE]	
CROSSROAD							
1.8 i-VTEC	02/07-08/10	R18A2	1799	Rippenanzahl: 7	0-N2123	VB [DG]	
1.8 i-VTEC	02/07-08/10	R18A2	1799		0-N2158	VB [BT]	S
CR-V I (RD)							
2.0, 2.0 16V	10/95-02/02	B20B, B20Z1	1973	26x125	SK-1436	BTK	
2.0, 2.0 16V	10/95-02/02	B20B, B20Z1	1973	26x125	SK-1436AQ1	BTKW	
2.0 16V	10/95-02/02	B20B, B20Z1	1973		0-N979	TB [TE]	
2.0 16V	10/95-12/01	B20B	1973	01/1997 → 12/1998	0-N2102	VB [DG]	
2.0, 2.0 16V	01/99-02/02	B20Z1	1973	→ 12/2001	0-N2102	VB [DG]	
CR-V II (RD_)							
2.0	09/01-09/06	K20A4	1998	: →2000975	0-N1850	VB [BT]	S
2.0	09/01-09/06	K20A4	1998		0-N2207	VB [TE]	
2.2 CTDi	02/05-09/06	N22A2	2204		0-N2103	VB [BT]	S
2.4 Vtec	09/01-09/06	K24A1	2354		0-N1850	VB [BT]	S
2.4 Vtec	09/01-09/06	K24A1	2354		0-N2207	VB [TE]	
CR-V III (RE)							
2.0 i	01/07-	R20A2	1997	Rippenanzahl: 7	0-N2123	VB [DG]	
2.0 i	01/07-	R20A2	1997		0-N2158	VB [BT]	S
2.2 i-CTDi 4WD	01/07-	N22A2	2204		0-N2103	VB [BT]	S
2.2 i-DTEC 4WD	01/07-	N22B3	2199		0-N2103	VB [BT]	S
2.4, 2.4 4WD, 2.4 i-Vtec 4WD	09/06-	K24A, K24Z1, K24A1, K24Z1, K24Z1, K24Z4	2354		0-N1850	VB [BT]	S
2.4, 2.4 4WD, 2.4 i-VTEC 4WD	09/06-	K24A, K24Z1, K24A1, K24Z1, K24Z4	2354		0-N2207	VB [TE]	
CR-V IV (RE)							
2.0	01/12-	R20A	1997		0-N2158	VB [BT]	S
2.4, 2.4 AWD	01/12-	K24A, K24Z6, K24Z7, K24Z9	2354		0-N1850	VB [BT]	S
CRX I (AF, AS)							
1.6 i 16V	03/86-10/87	ZC1	1590	24x107; Nockenwelle: SOHC/OHC	SK-1211	BTK	
1.3	10/83-10/87	EV2	1342		0-N926	TB [TE]	
1.5 i	10/83-11/86	EW3	1488		0-N926	TB [TE]	
1.6 i 16V	03/86-10/87	ZC1	1590		0-N066	TB [TE]	
CRX II (ED, EE)							
1.6 i 16V	10/87-02/92	D16A8, D16A9, D16Z5	1590	24x107; Nockenwelle: SOHC/OHC; Baumuster: ED9	SK-1211	BTK	
1.6 i 16V	10/87-05/88	D16A, D16A6	1590	24x107; Nockenwelle: SOHC/OHC	SK-1211	BTK	
1.6 i 16V	10/87-02/92	D16A8, D16A9, D16Z5	1590	24x124; Nockenwelle: DOHC	SK-1213	BTK	
1.6 i 16V	10/87-05/88	D16A, D16A6	1590	24x124; Nockenwelle: DOHC; 01/1988 →	SK-1213	BTK	
1.6 i 16V Vtec	10/89-02/92	B16A1	1595	26x124	SK-1070	BTK	
1.6 i 16V	10/87-02/92	D16A8, D16A9, D16Z5	1590		0-N927	TB [TE]	
1.6 i 16V Vtec	10/89-02/92	B16A1	1595		0-N979	TB [TE]	
CRX III (EH, EG)							
1.6 ESi	03/92-12/98	D16Y8, D16Z6	1590	24x104	SK-1277	BTK	
1.6 ESi	03/92-12/98	D16Y8, D16Z6	1590	24x104	SK-1277AQ2	BTKW	
1.6 i VTi	03/92-12/98	B16A2	1595	26x124; 06/1992 →	SK-1070	BTK	
1.6 ESi	03/92-12/98	D16Y8, D16Z6	1590		0-N978	TB [TE]	
1.6 i VTi	03/92-12/98	B16A2	1595		0-N979	TB [TE]	
1.6 ESi	03/92-12/98	D16Y8, D16Z6	1590		0-N2102	VB [DG]	
1.6 i VTi	03/92-12/98	B16A2	1595		0-N2102	VB [DG]	
CR-Z (ZF1)							
1.5 Hybrid	06/10-	LEA1, LEA1, LEA3	1497		0-N2267	VB [BT]	S
DOMANI							
1.6 Allrad	10/95-09/99	D16A	1590		0-N978	TB [TE]	
ELEMENT							
2.4 Vtec, 2.4 Vtec 4x4	07/02-12/11	K24A6	2354		0-N1850	VB [BT]	S
2.4 Vtec, 2.4 Vtec 4x4	07/02-12/11	K24A6	2354		0-N2207	VB [TE]	
ELYSION							
2.4 i-VTEC	05/04-	K24A1	2354		0-N1850	VB [BT]	S
2.4 i-VTEC	05/04-	K24A1	2354		0-N2207	VB [TE]	
FR-V (BE)							
1.7	08/04-	D17A2	1668	22x104; mit Zubehör	SK-1590	BTK	



OPTIMAL®

HONDA

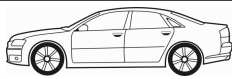

CM³



Art. Nr.



ohne Halter

FR-V (BE)

1.7	08/04-	D17A2	1668	22x104; mit Zubehör	SK-1590AQ1	BTKW	
1.7, 1.7 Vtec 4x4	08/04-09/06	D17A2	1668		0-N1330	TB [TE]	
1.8	01/07-	R18A1	1799	Rippenanzahl: 7	0-N2123	VB [DG]	
1.8	01/07-	R18A1	1799		0-N2158	VB [BT]	S
2.0, 2.0 4x4	08/04-09/06	K20A9	1998		0-N1850	VB [BT]	S
2.0, 2.0 4x4	08/04-09/06	K20A9	1998		0-N2207	VB [TE]	
2.2 i CTDi	07/05-	N22A1	2204		0-N2103	VB [BT]	S

HR-V (GH)

1.6 16V, 1.6 16V 4WD	03/99-	D16W1, D16W5	1590	24x104	SK-1277	BTK	
1.6 16V, 1.6 16V 4WD	03/99-	D16W1, D16W5	1590	24x104	SK-1277AQ1	BTKW	
1.6 16V, 1.6 16V 4WD	03/99-	D16W1, D16W5	1590		0-N978	TB [TE]	
1.6 16V, 1.6 16V 4WD	03/99-	D16W1, D16W5	1590	→ 12/2005	0-N2101	VB [DG]	
1.6 16V, 1.6 16V 4WD	03/99-	D16W1, D16W5	1590		0-N2102	VB [DG]	

INSIGHT (ZE)

1.0 Hybrid	04/00-12/06	ECA1	995		0-N1852	VB [DG]	
------------	-------------	------	-----	--	---------	---------	--

INSIGHT (ZE_)

1.3 Hybrid	04/09-	LDA3	1339		0-N2267	VB [BT]	S
------------	--------	------	------	--	---------	---------	---

INTEGRA (DA)

1.6	03/86-08/89	D16A3	1590		0-N066	TB [TE]	
-----	-------------	-------	------	--	--------	---------	--

INTEGRA Coupe (DC2, DC4)

1.8 Type-R	11/97-10/01	B18C6	1797		0-N979	TB [TE]	
1.8 Type-R	09/93-10/01	B18C6	1797		0-N2102	VB [DG]	

INTEGRA (DC5)

2.0	02/02-	K20A3	1998		0-N1812	VB [BT]	S
2.0	10/04-	K20A2	1998		0-N2033	VB [DG]	
2.0, 2.0 16V Type-R	02/02-	K20A2, K20A3, K20Z1	1998		0-N2207	VB [TE]	

JAZZ I (AA)

45 1.2, 56 1.2	10/83-10/86	ER1, ER2	1231		0-N067	TB [TE]	
----------------	-------------	----------	------	--	--------	---------	--

JAZZ II (GD)

1.2	03/02-07/08	L12A1	1243		0-N1852	VB [DG]	
1.3 iDSi, 1.4	03/02-07/08	L13A1	1339		0-N1852	VB [DG]	
1.3 iDSi, 1.4	03/02-07/08	L13A1, L13A5	1339		0-N2210	VB [BT]	S
1.5, 1.5 FF	03/02-07/08	L15A, L15A1	1497		0-N2210	VB [BT]	S

JAZZ Stufenheck

1.3	05/03-	L13A1	1339		0-N1852	VB [DG]	
1.3	05/03-	L13A1	1339		0-N2210	VB [BT]	S
1.5	10/04-	L15A2	1497		0-N2210	VB [BT]	S

JAZZ III (GE)

1.3 HYBRID	04/11-	LDA3	1339		0-N2267	VB [BT]	S
1.4 i	07/08-	L13Z1	1339		0-N1852	VB [DG]	
1.4, 1.4 i	07/08-	L13Z1	1339		0-N2210	VB [BT]	S
1.5 Flexfuel, 1.5 i	07/08-	L15A3, L15A3, L15A7	1496		0-N2210	VB [BT]	S

LAGREAT

2.3 Vtec	07/02-09/03	F23A	2254		0-N178	TB [TE]	
2.3 Vtec	07/02-09/03	F23A	2254		0-N905	TB [TE]	

LEGEND I (HS, KA)

2.5 i	01/86-06/88	C25A1, C25A2	2494	28x192	SK-1217	BTK	
2.7 i 24V	01/88-12/90	C27A1	2675	28x192	SK-1217	BTK	
2.5 i	01/86-06/88	C25A1, C25A2	2494		0-N928	TB [TE]	
2.7 i 24V	01/88-12/90	C27A1	2675		0-N928	TB [TE]	

LEGEND I Coupe (KA3)

2.7 i 24V	10/87-12/90	C27A1	2675	28x192	SK-1217	BTK	
2.7 i 24V	10/87-12/90	C27A1	2675		0-N928	TB [TE]	

LEGEND II (KA7)

3.2 i 24V	01/91-02/96	C32A2	3206		0-N969	TB [TE]	
-----------	-------------	-------	------	--	--------	---------	--

LEGEND II Coupe (KA8)

3.2 i 24V	01/91-02/96	C32A2	3206		0-N969	TB [TE]	
-----------	-------------	-------	------	--	--------	---------	--

LOGO (GA3)

1.3	03/99-03/02	D13B7	1343	22x103; → 11/2001	SK-1628	BTK	
-----	-------------	-------	------	-------------------	---------	-----	--

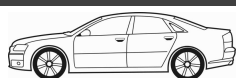

CM³



Art. Nr.



ohne Halter

LOGO (GA3)							
1.3	03/99-03/02	D13B7	1343			0-N978	TB [TE]
1.3	03/99-03/02	D13B7	1343	→ 12/2000		0-N2101	VB [DG]
NSX Cabriolet (NA)							
3.0 24V Vtec, 3.0 24V Vtec Automatic	03/95-09/05	C30A3, C30A4	2977			0-N927	TB [TE]
3.2 24V Vtec	01/97-09/05	C32B2	3179			0-N927	TB [TE]
NSX Coupe (NA)							
3.0 24V Vtec, 3.0 24V Vtec Automatic	06/90-09/05	C30A3, C30A4	2977			0-N927	TB [TE]
3.2 24V Vtec	01/97-09/05	C32B2	3179			0-N927	TB [TE]
ODYSSEY (RA_)							
2.3, 2.3 4x4	10/97-12/99	F23A, F23A7	2254	24x112; 16x70		SK-1430	BTK
2.3, 2.3 4x4	10/97-12/99	F23A, F23A7	2254	24x112; 16x70		SK-1430AQ1	BTKW
2.2 4x4	10/95-12/99	F22B6	2156			0-N178	TB [TE]
2.2 4x4	10/95-12/99	F22B6	2156			0-N905	TB [TE]
2.3, 2.3 4x4	10/97-12/99	F23A, F23A7	2254			0-N178	TB [TE]
2.3, 2.3 4x4	10/97-12/99	F23A, F23A7	2254			0-N905	TB [TE]
ODYSSEY (RB_)							
2.3, 2.3 4x4	07/02-09/03	F23A	2254	24x112; 16x70		SK-1430	BTK
2.3, 2.3 4x4	07/02-09/03	F23A	2254	24x112; 16x70		SK-1430AQ1	BTKW
2.3, 2.3 4x4	07/02-09/03	F23A	2254			0-N178	TB [TE]
2.3, 2.3 4x4	07/02-09/03	F23A	2254			0-N905	TB [TE]
2.4, 2.4 i-VTEC, 2.4 i-VTEC 4x4	10/03-	K24A, K24A4, K24A5	2354			0-N1850	VB [BT] S
2.4, 2.4 i-VTEC, 2.4 i-VTEC 4x4	10/03-	K24A, K24A4, K24A5	2354			0-N2207	VB [TE]
ODYSSEY [USA] Mini Passenger Van							
3.5	01/05-12/07		3471			0-N2251	VB [BT]
3.5	01/05-12/07		3471			0-N2251S1	VB [DG]
3.5	01/05-12/07		3471			0-N2251S2	VB [DG]
PRELUDE II (AB)							
1.8 EX	11/83-04/87	ET2, ET3, ET3, ET4	1829	24x108		SK-1216	BTK
1.8 EX	11/83-04/87	ET2, ET3, ET3, ET4	1829			0-N981	TB [TE]
PRELUDE III (BA)							
2.0 i EX 16V	04/87-01/92	B20A5	1958	24x124; 10/1990 →		SK-1301	BTK
2.0 i EX 16V	10/87-01/92	B20A7, B20A9	1958	24x124		SK-1301	BTK
2.0, 2.0 EX, 2.0 i EX 16V	04/86-01/92	B20A1, B20A3, B20A4, B20A5, B20A7, B20A9	1958			0-N982	TB [TE]
PRELUDE IV (BB)							
2.0 i 16V	02/92-09/96	F20A4	1997	24x113; 16x70		SK-1220	BTK
2.3 i 16V	02/92-09/96	H23A2	2259	16x70; 24x127		SK-1218	BTK
2.0 i 16V	02/92-09/96	F20A4	1997			0-N178	TB [TE]
2.0 i 16V	02/92-09/96	F20A4	1997			0-N905	TB [TE]
2.2 i 16V Vtec	02/93-09/96	H22A2	2157			0-N068	TB [TE]
2.2 i 16V Vtec	02/93-09/96	H22A2	2157			0-N193	TB [TE]
2.3 i 16V	02/92-09/96	H23A2	2259			0-N178	TB [TE]
2.3 i 16V	02/92-09/96	H23A2	2259			0-N905	TB [TE]
PRELUDE V (BB)							
2.0 16V	10/96-10/00	F20A4	1997	24x113; 16x70		SK-1220	BTK
2.0 16V	10/96-10/00	F20A4	1997			0-N178	TB [TE]
2.0 16V	10/96-10/00	F20A4	1997			0-N905	TB [TE]
2.2 16V	10/96-10/00	H22A2, H22A5, H22A5	2157			0-N068	TB [TE]
2.2 16V	10/96-10/00	H22A2, H22A5, H22A5	2157			0-N193	TB [TE]
S2000 (AP)							
2.0	06/99-	F20C VTEC	1997			0-N2298	TB [BT]
2.0, 2.0 Vtec	03/99-10/03	F20C VTEC, F20C1, F20C3	1997	Rippenanzahl: 6		0-N2398	VB [BT] S
SHUTTLE (RA)							
2.2 16V	10/94-02/98	F22B8	2156	24x113; 16x70; 03/1995 →		SK-1220	BTK
2.3 16V, 2.3 16V 4x4	10/97-06/04	F23A, F23A7	2254	24x112; 16x70		SK-1430	BTK
2.3 16V, 2.3 16V 4x4	10/97-06/04	F23A, F23A7	2254	24x112; 16x70		SK-1430AQ1	BTKW
2.2 16V, 2.2 4x4	06/94-02/98	F22B8, F22B9	2156			0-N178	TB [TE]
2.2 16V, 2.2 4x4	06/94-02/98	F22B8, F22B9	2156			0-N905	TB [TE]
2.3 16V, 2.3 16V 4x4	10/97-06/04	F23A, F23A7	2254			0-N178	TB [TE]
2.3 16V, 2.3 16V 4x4	10/97-06/04	F23A, F23A7	2254			0-N905	TB [TE]

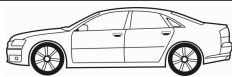
CM³

Art. Nr.



ohne Halter

STEPWGN (LA-RF_, UA-RF_)

2.0, 2.0 4WD	10/00-09/05	K20A9	1998		0-N1850	VB [BT]	S
2.0, 2.0 4WD	10/00-09/05	K20A9	1998		0-N2207	VB [TE]	
2.4	10/00-09/05	K24A3	2354		0-N1850	VB [BT]	S
2.4	10/00-09/05	K24A3	2354		0-N2207	VB [TE]	

STEPWGN (DBA-RG_)

2.0	10/05-	K20A6	1998		0-N1850	VB [BT]	S
2.0	10/05-	K20A6	1998		0-N2207	VB [TE]	
2.4 Z FF	10/05-	K24A3	2354		0-N1850	VB [BT]	S
2.4 Z FF	10/05-	K24A3	2354		0-N2207	VB [TE]	

STEPWGN (DBA-RK_)

2.0 i-VTEC	10/09-	R20A1	1997	Rippenanzahl: 7	0-N2123	VB [DG]	
2.0 i-VTEC	10/09-	R20A1	1997		0-N2158	VB [BT]	S

STREAM (RN)

1.7 16V	05/01-	D17A2	1668	22x104; mit Zubehör	SK-1590	BTK	
1.7 16V	05/01-	D17A2	1668	22x104; mit Zubehör	SK-1590AQ1	BTKW	
1.7 16V	05/01-	D17A2	1668		0-N1330	TB [TE]	
2.0 16V	05/01-	K20A1	1998		0-N1850	VB [BT]	S
2.0 16V	05/01-	K20A1	1998		0-N2207	VB [TE]	

STREAM

1.8 Vtec	10/05-	R18A2	1798	→ 12/2006	0-N1851	VB [BT]	S
1.8 Vtec	10/05-	R18A2	1798	Rippenanzahl: 7	0-N2123	VB [DG]	
1.8 Vtec	10/05-	R18A2	1798	01/2007 →	0-N2158	VB [BT]	S
2.0 Vtec	10/05-	R20A4	1997	Rippenanzahl: 7	0-N2123	VB [DG]	
2.0 Vtec	10/05-	R20A4	1997		0-N2158	VB [BT]	S

TORNEO Stufenheck

2.0, 2.0 VTS, 2.0 VTS 4x4	04/94-12/97	F20B, F20B1, F20Z2	1997		0-N178	TB [TE]	
2.0, 2.0 VTS, 2.0 VTS 4x4	04/94-12/97	F20B, F20B1, F20Z2	1997		0-N905	TB [TE]	

TORNEO Stufenheck

1.6	10/99-09/02	D16B6	1590		0-N978	TB [TE]	
1.8	10/99-09/02	F18B	1849		0-N178	TB [TE]	
1.8	10/99-09/02	F18B	1849		0-N905	TB [TE]	
2.0, 2.0 VTS, 2.0 VTS 4x4	01/98-09/03	F20B, F20B1, F20Z2	1997		0-N178	TB [TE]	
2.0, 2.0 VTS, 2.0 VTS 4x4	01/98-09/03	F20B, F20B1, F20Z2	1997		0-N905	TB [TE]	
1.6	10/99-09/02	D16B6	1590		0-N2102	VB [DG]	

TORNEO Kombi

1.6	10/99-09/02	D16B6	1590		0-N978	TB [TE]	
1.6	10/99-09/02	D16B6	1590		0-N2102	VB [DG]	



CM³



Art. Nr.



ohne Halter

CIVIC							
1.8	04/06-	R18A1	1798	→ 12/2006; für OE: 31170RNAA02	0-N1851	VB [BT]	S
1.8	04/06-	R18A1	1798		0-N2158	VB [BT]	S
CR-V							
2.0 AWD	06/04-02/07	K20A4	1998		0-N1850	VB [BT]	S
2.4 AWD	06/04-02/07	K24A1, K24Z1	2354		0-N1850	VB [BT]	S
CR-V							
2.0 AWD	03/07-02/10	R20A1	1998		0-N2158	VB [BT]	S
2.4 AWD	03/07-12/10	K24A1, K24Z1	2354		0-N1850	VB [BT]	S



CM³



Art. Nr.



ohne Halter

ACCORD VI

2.0	01/99-12/07	F20B2	1998		0-N178	TB [TE]	
2.0	01/99-12/07	F20B2	1998		0-N905	TB [TE]	
2.3 Vtec	06/00-12/02	F23A3, F23Z4, F23Z5	2254	für OE: 13404PT0003, 13404PT0004	0-N178	TB [TE]	
2.3 Vtec	06/00-12/02	F23A3, F23Z4, F23Z5	2254	für OE: 14510PT0003, 14510PT0004	0-N905	TB [TE]	
2.0 Vtec	10/99-12/02	K20A7	1997		0-N1850	VB [BT]	S

ACCORD VII

2.0	01/03-12/07	K20A7	1998		0-N1850	VB [BT]	S
2.4	01/03-12/07	K24A4, K24A8	2354		0-N1850	VB [BT]	S

ACCORD VIII

2.4	01/08-	K24Z2	2354		0-N1850	VB [BT]	S
3.5	03/08-	J35Z2	3471		0-N2251	VB [BT]	
3.5	03/08-	J35Z2	3471		0-N2251S1	VB [DG]	
3.5	03/08-	J35Z2	3471		0-N2251S2	VB [DG]	

ODYSSEY Großraumlimousine

2.4	08/09-	K24A6, K24Z2	2354		0-N1850	VB [BT]	S
-----	--------	--------------	------	--	----------------	---------	----------

ODYSSEY Großraumlimousine

2.4	03/05-08/09	K24A6, K24Z2	2354		0-N1850	VB [BT]	S
-----	-------------	--------------	------	--	----------------	---------	----------



CM³



Art. Nr.



ohne Halter

HQ3							
4.3	12/06-	3UZ-FE	4293		0-N1823	TB [BT]	
4.3	12/06-	3UZ-FE	4293		0-N1883	TB [BT]	S
4.3	12/06-	3UZ-FE	4293		0-N2058	TB [DG]	
4.3	12/06-	3UZ-FE	4293	Rippenanzahl: 6	0-N2186	VB [DG]	
4.3	12/06-	3UZ-FE	4293		0-N2187	VB [BT]	
4.3	12/06-	3UZ-FE	4293		0-N2189S	VB [DG]	



CM³



Art. Nr.



ohne Halter

HUMMER H1

6.5 D, 6.5 Turbo D	01/92-		6500	10/1992 →;	0-N1684	VB [DG]	
6.5 D, 6.5 Turbo D	01/92-		6500	10/1992 →	0-N1685	VB [DG]	

HUMMER H2

2.6 TDiC	02/08-12/10	L92	6162	25.4x163; 19x99	SK-1306	BTK	
6.0 Allrad	09/02-09/04	LQ4	5964		0-N1684	VB [DG]	
6.0 Allrad	09/02-09/04	LQ4	5964		0-N1690	VB [DG]	
6.0 Allrad	09/02-09/04	LQ4	5964		0-N1846	VB [BT]	S



CM³



Art. Nr.



ACCENT I (X-3)							
1.3, 1.3 i 12V	10/94-01/00	G4EH	1341	22x92	SK-1320	BTK	
1.5 i 12V	10/94-01/00	G4EK	1495	22x92	SK-1320	BTK	
1.5 i 16V	12/95-01/00	G4ER	1495	22x105	SK-1634	BTK	
1.5 i 16V	12/95-01/00	G4ER	1495	22x105	SK-1634AQ1	BTKW	
1.3, 1.3 i 12V	10/94-01/00	G4EH	1341		0-N975	TB [TE]	
1.5 i 12V, 1.5 i 16V	10/94-01/00	G4EK, G4ER	1495		0-N975	TB [TE]	
1.5 i 16V	12/95-01/00	G4ER	1495		0-N1370	TB [DG]	
1.3, 1.3 i 12V	10/94-01/00	G4EH	1341		0-N1854	VB [BT]	
1.5 i 12V, 1.5 i 16V	10/94-01/00	G4EK, G4ER	1495		0-N1854	VB [BT]	

ACCENT Stufenheck (X-3)							
1.3	10/94-01/00	G4EH	1341	22x92	SK-1320	BTK	
1.3 i 12V	10/94-01/00	G4EH	1341	22x92; → 12/1995	SK-1320	BTK	
1.5 i 12V	10/94-01/00	G4EK	1495	22x92	SK-1320	BTK	
1.5 i 16V	10/95-01/00	G4ER	1495	22x105	SK-1634	BTK	
1.5 i 16V	10/95-01/00	G4ER	1495	22x105	SK-1634AQ1	BTKW	
1.3, 1.3 i 12V	10/94-01/00	G4EH	1341		0-N975	TB [TE]	
1.5 i 12V, 1.5 i 16V	10/94-01/00	G4EK, G4ER	1495		0-N975	TB [TE]	
1.5 i 16V	10/95-01/00	G4ER	1495		0-N1370	TB [DG]	
1.3, 1.3 i 12V	10/94-01/00	G4EH	1341		0-N1854	VB [BT]	
1.5 i 12V, 1.5 i 16V	10/94-01/00	G4EK, G4ER	1495		0-N1854	VB [BT]	

ACCENT II (LC)							
1.3	01/00-11/05	G4EA	1341	22x110	SK-1439	BTK	
1.3	08/02-11/05	G4EH	1341	22x110; 03/2003 →	SK-1439	BTK	
1.5	01/00-11/05	G4EB	1495	22x110	SK-1439	BTK	
1.5	09/00-11/05	G4EC-G	1495	22x105	SK-1634	BTK	
1.5	09/00-11/05	G4EC-G	1495	22x105; Baumuster: Excel	SK-1634AQ1	BTKW	
1.5 CRDi	04/02-11/05	D3EA	1493	28x123	SK-1654	BTK	
1.5 CRDi	04/02-11/05	D3EA	1493	28x123; Baumuster: Excel	SK-1654AQ1	BTKW	
1.5 CRDi	04/02-11/05	D3EA	1493	28x123; Baumuster: Verna	SK-1654AQ1	BTKW	
1.6	12/02-11/05	G4ED-G	1599	22x105	SK-1634	BTK	
1.6	12/02-11/05	G4ED-G	1599	22x105	SK-1634AQ1	BTKW	
1.3	01/00-11/05	G4EA, G4EH	1341		0-N975	TB [TE]	
1.5	01/00-11/05	G4EB, G4EC-G	1495		0-N975	TB [TE]	
1.5	09/00-11/05	G4EC-G	1495		0-N1370	TB [DG]	
1.5 CRDi	04/02-11/05	D3EA	1493		0-N1499	TB [BT]	S
1.5 CRDi	04/02-11/05	D3EA	1493		0-N1500	TB [DG]	
1.6	12/02-11/05	G4ED-G	1599		0-N1370	TB [DG]	
1.6	12/02-11/05	G4ED-G	1599		0-N975	TB [TE]	
1.3	01/00-11/05	G4EA, G4EH	1341		0-N1854	VB [BT]	
1.5	01/00-11/05	G4EB, G4EC-G	1495		0-N1854	VB [BT]	
1.5 CRDi	04/02-11/05	D3EA	1493		0-N1547	VB [DG]	
1.5 CRDi	04/02-11/05	D3EA	1493	✳	0-N1814	VB [DG]	
1.5 CRDi	04/02-11/05	D3EA	1493		0-N1815	VB [BT]	S
1.6	12/02-11/05	G4ED-G	1599		0-N1854	VB [BT]	

ACCENT II Stufenheck (LC)							
1.3	01/00-11/05	G4EA	1341	22x110	SK-1439	BTK	
1.5	09/99-10/02	G4FK	1495	22x105	SK-1634	BTK	
1.5	09/99-10/02	G4FK	1495	22x105	SK-1634AQ1	BTKW	
1.5	01/00-11/05	G4EB	1495	22x110	SK-1439	BTK	
1.5 CRDi	01/02-11/05	D3EA	1493	28x123	SK-1654	BTK	
1.5 CRDi	01/02-11/05	D3EA	1493	28x123; Baumuster: Admire	SK-1654AQ1	BTKW	
1.6	12/02-11/05	G4ED-G	1599	22x105	SK-1634	BTK	
1.6	12/02-11/05	G4ED-G	1599	22x105; Baumuster: Verna	SK-1634AQ1	BTKW	
1.3	01/00-11/05	G4EA	1341		0-N975	TB [TE]	
1.5	09/99-10/02	G4FK	1495		0-N1370	TB [DG]	
1.5	09/99-11/05	G4EB, G4FK	1495		0-N975	TB [TE]	
1.5 CRDi	01/02-11/05	D3EA	1493		0-N1499	TB [BT]	S
1.5 CRDi	01/02-11/05	D3EA	1493		0-N1500	TB [DG]	
1.6	12/02-11/05	G4ED-G	1599		0-N1370	TB [DG]	
1.6	12/02-11/05	G4ED-G	1599		0-N975	TB [TE]	
1.3	01/00-11/05	G4EA	1341		0-N1854	VB [BT]	
1.5	09/99-11/05	G4EB, G4FK	1495		0-N1854	VB [BT]	
1.5 CRDi	01/02-11/05	D3EA	1493		0-N1547	VB [DG]	
1.5 CRDi	01/02-11/05	D3EA	1493	✳	0-N1814	VB [DG]	

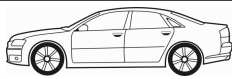
CM³

Art. Nr.



ohne Halter

ACCENT II Stufenheck (LC)

1.5 CRDi	01/02-11/05	D3EA	1493			0-N1815	VB [BT]	S
1.6	12/02-11/05	G4ED-G	1599			0-N1854	VB [BT]	

ACCENT III (MC)

1.4 GL	11/05-11/10	G4EE	1399	22x105; 06/2006 →		SK-1634	BTK	
1.4 GL	11/05-11/10	G4EE	1399	22x105		SK-1634AQ1	BTKW	
1.6 GLS	11/05-11/10	G4ED	1599	22x105; 06/2006 →		SK-1634	BTK	
1.6 GLS	11/05-11/10	G4ED	1599	22x105		SK-1634AQ1	BTKW	
1.4 GL	11/05-11/10	G4EE	1399			0-N1370	TB [DG]	
1.4 GL	11/05-11/10	G4EE	1399			0-N975	TB [TE]	
1.6 GLS	11/05-11/10	G4ED	1599			0-N1370	TB [DG]	
1.6 GLS	11/05-11/10	G4ED	1599			0-N975	TB [TE]	
1.4 GL	11/05-11/10	G4EE	1399			0-N1854	VB [BT]	
1.5 CRDi GLS	11/05-11/10	D4FA	1493			0-N1813	VB [BT]	S
1.5 CRDi GLS	11/05-11/10	D4FA	1493	Rippenanzahl: 5		0-N2375	VB [DG]	
1.5 CRDi GLS	11/05-11/10	D4FA	1493			0-N2429	VB [DG]	
1.6 GLS	11/05-11/10	G4ED	1599			0-N1854	VB [BT]	

ACCENT III Stufenheck (MC)

1.4 GL	11/05-11/10	G4EE	1399	22x105		SK-1634	BTK	
1.4 GL	11/05-11/10	G4EE	1399	22x105		SK-1634AQ1	BTKW	
1.6 GLS	11/05-11/10	G4ED	1599	22x105		SK-1634	BTK	
1.6 GLS	11/05-11/10	G4ED	1599	22x105		SK-1634AQ1	BTKW	
1.4 GL	11/05-11/10	G4EE	1399			0-N1370	TB [DG]	
1.4 GL	11/05-11/10	G4EE	1399			0-N975	TB [TE]	
1.6 GLS	11/05-11/10	G4ED	1599			0-N1370	TB [DG]	
1.6 GLS	11/05-11/10	G4ED	1599			0-N975	TB [TE]	
1.4 GL	11/05-11/10	G4EE	1399			0-N1854	VB [BT]	
1.5 CRDi GLS	11/05-11/10	D4FA	1493			0-N1813	VB [BT]	S
1.5 CRDi GLS	11/05-11/10	D4FA	1493	Rippenanzahl: 5		0-N2375	VB [DG]	
1.5 CRDi GLS	11/05-11/10	D4FA	1493			0-N2429	VB [DG]	
1.6 GLS	11/05-11/10	G4ED	1599			0-N1854	VB [BT]	

ACCENT IV (RB)

1.4	11/10-	G4FA	1396			0-N1987	VB [DG]	
1.4	11/10-	G4FA	1396			0-N2202	VB [BT]	S
1.6	11/10-	G4FC	1591			0-N1987	VB [DG]	
1.6	11/10-	G4FC	1591			0-N2202	VB [BT]	S

ACCENT IV Stufenheck (RB)

1.4	11/10-	G4LC	1368			0-N1987	VB [DG]	
1.4	11/10-	G4FA	1396			0-N1987	VB [DG]	
1.4	11/10-	G4FA	1396			0-N2202	VB [BT]	S
1.4 CRDi	11/10-	D4FC	1396			0-N1813	VB [BT]	S
1.4 CRDi	11/10-	D4FC	1396	Rippenanzahl: 5		0-N2375	VB [DG]	
1.4 CRDi	11/10-	D4FC	1396			0-N2429	VB [DG]	
1.6	11/10-	G4FC	1591			0-N1987	VB [DG]	
1.6	11/10-	G4FC	1591			0-N2202	VB [BT]	S
1.6 CRDi	04/11-	D4FB	1582			0-N2429	VB [DG]	
1.6 CRDi	10/11-	D4FB	1582			0-N1813	VB [BT]	S
1.6 CRDi	10/11-	D4FB	1582	Rippenanzahl: 5		0-N2375	VB [DG]	

ATOS (MX)

0.8	04/99-07/03	G3HJ	798	20x101		SK-1626	BTK	
1.0 i	02/98-03/02	G4HC, G4HC-E	999	20x101		SK-1626	BTK	
1.1	06/03-05/05	G4HD, G4HG	1086	20x101		SK-1626	BTK	
1.0 i	02/98-03/02	G4HC, G4HC-E	999			0-N1366	TB [TE]	
1.1	06/03-05/05	G4HD, G4HG	1086			0-N1366	TB [TE]	

ATOS PRIME (MX)

1.0 i	08/99-	G4HC, G4HC-E	999	20x101		SK-1626	BTK	
1.1	06/03-	G4HD, G4HG	1086	20x101		SK-1626	BTK	
1.0 i	08/99-	G4HC, G4HC-E	999			0-N1366	TB [TE]	
1.1	06/03-	G4HD, G4HG	1086			0-N1366	TB [TE]	

COUPE (RD)

1.6 16V, 1.6 i 16V	12/96-04/02	4G61, G4GR	1599	25x111; → 05/2000; für OE: 2431223002		SK-1440	BTK	
1.6 16V, 1.6 i 16V	12/96-04/02	4G61, G4GR	1599	22x105; 05/2000 →		SK-1634	BTK	
1.6 16V, 1.6 i 16V	12/96-04/02	4G61, G4GR	1599	22x105; 05/2000 →		SK-1634AQ1	BTKW	
1.6 16V, 1.6 i 16V	12/96-04/02	4G61, G4GR	1599	22x105; Baumuster: Tuscani		SK-1634AQ1	BTKW	



CM³



Art. Nr.



ohne Halter

COUPE (RD)							
1.6 i 16V	12/96-04/02	4G61	1599	22x105; 05/2000 →; Baumuster: Tiburon	SK-1634AQ1	BTKW	
1.6 i 16V	08/00-01/02	G4ED-G	1599	22x105	SK-1634	BTK	
1.6 i 16V	08/00-01/02	G4ED-G	1599	22x105	SK-1634AQ1	BTKW	
2.0 16V	08/96-04/02	G4GF	1975	25.4x113; → 08/1999	SK-1651	BTK	
2.0 16V	08/96-04/02	G4GF	1975	25x113; → 05/2000	SK-1656	BTK	
2.0, 2.0 16V	08/99-04/02	G4DF	1975	25x113	SK-1656	BTK	
1.6 16V, 1.6 i 16V	12/96-04/02	4G61, G4GR	1599	05/2000 →	0-N1370	TB [DG]	
1.6 16V, 1.6 i 16V	12/96-04/02	4G61, G4GR	1599	→ 05/2000	0-N1374	TB [DG]	
1.6 16V, 1.6 i 16V	12/96-04/02	4G61, G4GR	1599	→ 05/2000	0-N1561	TB [TE]	
1.6 16V, 1.6 i 16V	12/96-04/02	4G61, G4GR	1599	05/2000 →	0-N975	TB [TE]	
1.6 i 16V	08/00-01/02	G4ED-G	1599		0-N1370	TB [DG]	
1.8 SX	07/96-04/02	G4GM	1795		0-N1374	TB [DG]	
1.8 SX	07/96-04/02	G4GM	1795		0-N1561	TB [TE]	
2.0, 2.0 16V	08/96-04/02	G4DF, G4GF	1975		0-N1561	TB [TE]	
2.0, 2.0 16V, F2 Evolution	08/96-04/02	G4DF, G4GF	1975		0-N1374	TB [DG]	
1.6 16V, 1.6 i 16V	12/96-04/02	4G61, G4GR	1599		0-N1854	VB [BT]	
1.8 SX	07/96-04/02	G4GM	1795		0-N1854	VB [BT]	
2.0, 2.0 16V	08/96-04/02	G4DF, G4GF	1975		0-N1854	VB [BT]	
COUPE (GK)							
1.6 16V	03/02-08/09	G4ED-G	1599	22x105	SK-1634	BTK	
1.6 16V	03/02-08/09	G4ED-G	1599	22x105; Baumuster: Tiburon	SK-1634AQ1	BTKW	
2.0	08/01-08/09	G4GC-G	1975	25x113; → 06/2003	SK-1656	BTK	
2.0	03/02-08/09	G4GC-G	1975	25x113; → 08/2005	SK-1656	BTK	
2.0 GLS	02/03-08/09	G4GC-G	1975	25x113; → 09/2006	SK-1656	BTK	
2.0, 2.0 GLS	08/01-08/09	G4GC-G	1975	25.4x113; 05/2006 →	SK-1684	BTK	
2.7 V6	03/02-08/09	G6BA-G	2656	32x207; Nockenwelle: DOHC	SK-1669	BTK	
2.7 V6	03/02-08/09	G6BA-G	2656	32x207	SK-1669AQ1	BTKW	
2.7 V6	03/02-08/09	G6BA-G	2656	32x207; mit Spanndämpfer, Spannrolle	SK-1749	BTK	
2.7 V6	03/02-08/09	G6BA-G	2656	32x207; mit Spanndämpfer, Spannrolle; Baumuster: Tiburon	SK-1749	BTK	
2.7 V6	03/02-08/09	G6BA-G	2656	32x207; mit Spanndämpfer, Spannrolle; Baumuster: Tuscani	SK-1749	BTK	
2.7 V6	01/07-08/09	G6BA-G	2656	32x207	SK-1669	BTK	
1.6 16V	03/02-08/09	G4ED-G	1599		0-N1370	TB [DG]	
1.6 16V	03/02-08/09	G4ED-G	1599		0-N975	TB [TE]	
2.0, 2.0 GLS	08/01-08/09	G4GC-G	1975		0-N1374	TB [DG]	
2.0, 2.0 GLS	08/01-08/09	G4GC-G	1975	→ 05/2006	0-N1561	TB [TE]	
2.0, 2.0 GLS	08/01-08/09	G4GC-G	1975	05/2006 →	0-N1619	TB [TE]	
2.7 V6	03/02-08/09	G6BA-G	2656		0-N1576	TB [TE]	
2.7 V6	03/02-08/09	G6BA-G	2656		0-N1577	TB [DG]	
2.7 V6	03/02-08/09	G6BA-G	2656	→ 10/2008; Spannrollenbetätigung: hydraulisch	0-N2428	TB [VD]	
1.6 16V	03/02-08/09	G4ED-G	1599		0-N1854	VB [BT]	
2.0, 2.0 GLS	08/01-08/09	G4GC-G	1975		0-N1854	VB [BT]	
2.7 V6	03/02-08/09	G6BA-G	2656		0-N1677	VB [BT]	S
2.7 V6	03/02-08/09	G6BA-G	2656		0-N1678	VB [DG]	
ELANTRA (XD)							
1.6	06/00-07/06	G4ED-G, G4GA, G4GR	1599	22x105	SK-1634	BTK	
1.6	06/00-07/06	G4ED-G, G4GA, G4GR	1599	22x105	SK-1634AQ1	BTKW	
1.8	06/00-07/06	G4BB	1795	25x111	SK-1440	BTK	
2.0	06/00-07/06	G4GC, G4GC-G	1975	25.4x113; → 05/2006	SK-1651	BTK	
2.0	06/00-07/06	G4GC, G4GC-G	1975	25x113	SK-1656	BTK	
2.0	06/00-07/06	G4GC, G4GC-G	1975	25.4x113; 05/2006 →	SK-1684	BTK	
2.0 CRDi	04/01-07/06	D4EA	1991	28x123	SK-1654	BTK	
2.0 CRDi	04/01-07/06	D4EA	1991	28x123; → 01/2006	SK-1654AQ1	BTKW	
2.0 CRDi	04/01-07/06	D4EA	1991	28x123; 01/2006 →	SK-1654AQ2	BTKW	
1.6	06/00-07/06	G4ED-G, G4GA, G4GR	1599		0-N1370	TB [DG]	
1.6	06/00-07/06	G4ED-G, G4GA, G4GR	1599		0-N975	TB [TE]	
1.8	06/00-07/06	G4BB, G4GB	1795		0-N1374	TB [DG]	
1.8	06/00-07/06	G4BB, G4GB	1795		0-N1561	TB [TE]	
1.8	06/00-07/06	G4BB, G4GB	1795	05/2006 →	0-N1619	TB [TE]	
2.0	06/00-07/06	G4GC, G4GC-G	1975		0-N1374	TB [DG]	
2.0	06/00-07/06	G4GC, G4GC-G	1975	→ 05/2006	0-N1561	TB [TE]	
2.0	06/00-07/06	G4GC, G4GC-G	1975	05/2006 →	0-N1619	TB [TE]	
2.0 CRDi	04/01-07/06	D4EA	1991		0-N1499	TB [BT]	S

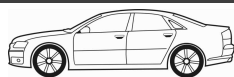
CM³

Art. Nr.

**ELANTRA (XD)**

2.0 CRDi	04/01-07/06	D4EA	1991			0-N1500	TB [DG]	
1.6	06/00-07/06	G4ED-G, G4GA, G4GR	1599			0-N1854	VB [BT]	
1.6 CRDi	02/06-07/06	D4FB	1582			0-N1813	VB [BT]	S
1.8	06/00-07/06	G4BB, G4GB	1795			0-N1854	VB [BT]	
2.0	06/00-07/06	G4GC, G4GC-G	1975			0-N1854	VB [BT]	
2.0 CRDi	04/01-07/06	D4EA	1991			0-N1547	VB [DG]	
2.0 CRDi	04/01-07/06	D4EA	1991	✘		0-N1814	VB [DG]	
2.0 CRDi	04/01-07/06	D4EA	1991			0-N1815	VB [BT]	S

ELANTRA Stufenheck (XD)

1.6	06/00-07/06	G4ED-G, G4GR	1599	22x105		SK-1634	BTK	
1.6	06/00-07/06	G4ED-G, G4GR	1599	22x105		SK-1634AQ1	BTKW	
1.6	06/00-07/06	G4ED-G	1599	22x105; Baumuster: Elantra		SK-1634AQ1	BTKW	
1.6	06/00-07/06	G4ED-G	1599	22x105; Baumuster: Lantra		SK-1634AQ1	BTKW	
1.8	06/00-07/06	G4BB	1795	25x111		SK-1440	BTK	
2.0	06/00-07/06	G4GC, G4GC-G	1975	25.4x113; → 05/2006		SK-1651	BTK	
2.0	06/00-07/06	G4GC, G4GC-G	1975	25x113		SK-1656	BTK	
2.0	06/00-07/06	G4GC, G4GC-G	1975	25.4x113; 05/2006 →		SK-1684	BTK	
2.0 CRDi	04/01-07/06	D4EA	1991	28x123		SK-1654	BTK	
2.0 CRDi	04/01-07/06	D4EA	1991	28x123; → 01/2006; Baumuster: Elantra		SK-1654AQ1	BTKW	
2.0 CRDi	04/01-07/06	D4EA	1991	28x123; Baumuster: Lantra		SK-1654AQ1	BTKW	
2.0 CRDi	04/01-07/06	D4EA	1991	28x123; 01/2006 →; Baumuster: Elantra		SK-1654AQ2	BTKW	
1.6	06/00-07/06	G4ED-G	1599			0-N1370	TB [DG]	
1.6	06/00-07/06	G4GR	1599			0-N1370	TB [DG]	
1.6	06/00-07/06	G4ED-G, G4GR	1599			0-N975	TB [TE]	
1.8	06/00-07/06	G4BB	1795			0-N1374	TB [DG]	
1.8	06/00-07/06	G4BB	1795			0-N1561	TB [TE]	
1.8	06/00-07/06	G4BB	1795	05/2006 →		0-N1619	TB [TE]	
2.0	06/00-07/06	G4GC, G4GC-G	1975			0-N1374	TB [DG]	
2.0	06/00-07/06	G4GC, G4GC-G	1975	→ 05/2006		0-N1561	TB [TE]	
2.0	06/00-07/06	G4GC, G4GC-G	1975	05/2006 →		0-N1619	TB [TE]	
2.0 CRDi	04/01-07/06	D4EA	1991			0-N1499	TB [BT]	S
2.0 CRDi	04/01-07/06	D4EA	1991			0-N1500	TB [DG]	
1.5 D	06/00-07/06	D4FA	1493			0-N2429	VB [DG]	
1.6	06/00-07/06	G4ED-G, G4GR	1599			0-N1854	VB [BT]	
1.6 CRDi	02/06-07/06	D4FB	1582			0-N1813	VB [BT]	S
1.8	06/00-07/06	G4BB	1795			0-N1854	VB [BT]	
2.0	06/00-07/06	G4GC, G4GC-G	1975			0-N1854	VB [BT]	
2.0 CRDi	04/01-07/06	D4EA	1991			0-N1547	VB [DG]	
2.0 CRDi	04/01-07/06	D4EA	1991	✘		0-N1814	VB [DG]	
2.0 CRDi	04/01-07/06	D4EA	1991			0-N1815	VB [BT]	S

ELANTRA Stufenheck (HD)

2.0 CVVT	06/06-06/11	G4GC	1975	25.4x113		SK-1684	BTK	
2.0 CVVT	06/06-06/11	G4GC	1975			0-N1374	TB [DG]	
2.0 CVVT	06/06-06/11	G4GC	1975			0-N1619	TB [TE]	
1.6 CRDi	11/05-12/11	D4FB	1582			0-N2429	VB [DG]	
1.6 CVVT	06/06-06/11	G4FC	1591			0-N1987	VB [DG]	
2.0 CVVT	06/06-06/11	G4GC	1975			0-N1854	VB [BT]	

ELANTRA Stufenheck (MD, UD)

1.6	06/11-	G4FG	1591			0-N1987	VB [DG]	
1.6 CRDi	02/11-	D4FB	1582			0-N1813	VB [BT]	S
1.6 CRDi	02/11-	D4FB	1582	für Fahrzeuge mit Start-Stopp-Funktion		0-N2214	VB [BT]	S
1.6 CRDi	02/11-	D4FB	1582	Rippenanzahl: 5		0-N2375	VB [DG]	
1.6 CRDi	02/11-	D4FB	1582			0-N2429	VB [DG]	
1.8	09/10-	G4NB-B	1797			0-N1987	VB [DG]	

EQUUS / CENTENNIAL

3.5	10/99-03/09	G6CU	3497	32x259		SK-1718	BTK	
3.5	10/99-03/09	G6CU	3497			0-N185	TB [TE]	
3.5	10/99-03/09	G6CU	3497			0-N189	TB [DG]	
4.5	10/99-09/03	8A80	4498			0-N185	TB [TE]	
4.5	10/99-09/03	8A80	4498			0-N189	TB [DG]	

EQUUS / CENTENNIAL

3.8	03/09-	G6DA	3778			0-N1990	VB [DG]	
-----	--------	------	------	--	--	---------	---------	--



CM³



Art. Nr.



GALLOPER I							
2.5 TD, 2.5 TD intercooler	08/91-07/98	4D56T	2477	25.4x163; 19x99; → 10/1997	SK-1306	BTK	
3.0 V6	08/91-07/98	6G72	2972	25.4x149	SK-1308	BTK	
2.5 TD, 2.5 TD intercooler	08/91-07/98	4D56T	2477		0-N061	TB [TE]	
2.5 TD, 2.5 TD intercooler	08/91-07/98	4D56T	2477		0-N184	TB [TE]	
3.0 V6	08/91-07/98	6G72	2972		0-N1521	VB [DG]	
GALLOPER II (JK-01)							
2.5 Tci D, 2.5 TD, 2.5 TD intercooler	08/98-12/03	D4BA, D4BH	2476	25.4x163; 19x99; → 06/2003	SK-1306	BTK	
2.6 TD Allrad	08/98-06/03	D4BB	2607	25.4x163; 19x99	SK-1306	BTK	
3.0 V6	08/98-12/03	G6AT	2972	25.4x149	SK-1308	BTK	
2.5 Tci D, 2.5 TD, 2.5 TD intercooler	08/98-12/03	D4BA, D4BH	2476		0-N061	TB [TE]	
2.5 Tci D, 2.5 TD, 2.5 TD intercooler	08/98-12/03	D4BA, D4BH	2476		0-N184	TB [TE]	
2.6 TD Allrad	08/98-06/03	D4BB	2607		0-N061	TB [TE]	
2.6 TD Allrad	08/98-06/03	D4BB	2607		0-N184	TB [TE]	
3.0 V6	08/98-12/03	G6AT	2972		0-N064	TB [TE]	
3.0 V6	08/98-12/03	G6AT	2972		0-N1521	VB [DG]	
GENESIS (BH)							
3.8 V6	01/08-	G6DA	3778	06/2008 → 12/2011	0-N1990	VB [DG]	
GENESIS Coupe							
3.8 V6	01/08-	G6DA	3778		0-N1990	VB [DG]	
GETZ (TB)							
1.1	09/02-06/09	G4HD, G4HD, G4HG	1086	20x101	SK-1626	BTK	
1.3	09/03-09/05	G4EA	1341	22x110; 02/2004 →	SK-1439	BTK	
1.3 i	09/02-03/04	G4EA	1341	22x110	SK-1439	BTK	
1.4 i	08/05-	G4EE	1399	22x105	SK-1634	BTK	
1.4 i	08/05-	G4EE	1399	22x105	SK-1634AQ1	BTKW	
1.5 CRDi	03/03-06/09	D3EA, D4FA	1493	28x123	SK-1654	BTK	
1.5 CRDi	03/03-09/05	D3EA	1493	28x123; Baumuster: Click	SK-1654AQ1	BTKW	
1.5 CRDi	03/03-09/05	D3EA	1493	28x123; Baumuster: Getz	SK-1654AQ1	BTKW	
1.6	09/02-09/05	G4ED-G	1599	22x105	SK-1634	BTK	
1.6	09/02-09/05	G4ED-G	1599	22x105	SK-1634AQ1	BTKW	
1.6	08/05-	G4ED-G	1599	22x105; 11/2006 →	SK-1634	BTK	
1.1	09/02-06/09	G4HD, G4HD, G4HG	1086		0-N1366	TB [TE]	
1.3, 1.3 i	09/02-06/09	G4EA	1341		0-N975	TB [TE]	
1.4 i	08/05-	G4EE	1399		0-N1370	TB [DG]	
1.4 i	08/05-	G4EE	1399		0-N975	TB [TE]	
1.5 CRDi	03/03-09/05	D3EA	1493		0-N1499	TB [BT]	S
1.5 CRDi	03/03-09/05	D3EA	1493		0-N1500	TB [DG]	
1.5 i	03/03-09/05	G4EC-G, G4ER	1495		0-N1370	TB [DG]	
1.5 i	03/03-09/05	G4EC-G, G4ER	1495		0-N975	TB [TE]	
1.6	09/02-09/05	G4ED-G	1599		0-N1370	TB [DG]	
1.6	09/02-09/05	G4ED-G	1599		0-N975	TB [TE]	
1.3, 1.3 i	09/02-09/05	G4EA	1341		0-N1854	VB [BT]	
1.4 i	08/05-	G4EE	1399		0-N1854	VB [BT]	
1.5 CRDi	03/03-09/05	D3EA	1493		0-N1547	VB [DG]	
1.5 CRDi	03/03-09/05	D3EA	1493	*	0-N1814	VB [DG]	
1.5 CRDi	03/03-09/05	D3EA	1493		0-N1815	VB [BT]	S
1.5 CRDi, 1.5 CRDi GLS	07/04-06/09	D4FA	1493		0-N1813	VB [BT]	S
1.5 CRDi, 1.5 CRDi GLS	07/04-06/09	D4FA	1493	Rippenanzahl: 5	0-N2375	VB [DG]	
1.5 CRDi, 1.5 CRDi GLS	07/04-06/09	D4FA	1493		0-N2429	VB [DG]	
1.5 i	03/03-09/05	G4EC-G, G4ER	1495		0-N1854	VB [BT]	
1.6	09/02-09/05	G4ED-G	1599		0-N1854	VB [BT]	
GRACE Bus							
2.5 D	07/93-06/94	D4BA	2476	25x163; 19x83; → 03/1994	SK-1236	BTK	
2.5 TD	06/98-10/01	D4BF	2476	25.4x163; 19x99	SK-1306	BTK	
2.5 D, 2.5 TD	07/93-10/01	D4BA, D4BF	2476		0-N061	TB [TE]	
2.5 D, 2.5 TD	07/93-10/01	D4BA, D4BF	2476		0-N184	TB [TE]	
2.6 D	10/99-10/04	D4BB	2659		0-N061	TB [TE]	
2.6 D	10/99-10/04	D4BB	2659		0-N184	TB [TE]	
GRANDEUR (TG)							
2.2 CRDi	06/06-	D4EB	2188	28x123	SK-1654	BTK	
2.2 CRDi	06/06-	D4EB	2188	28x123	SK-1654AQ2	BTKW	
2.2 CRDi	06/06-	D4EB	2188	28x123; Baumuster: Azera	SK-1654AQ2	BTKW	
2.2 CRDi	06/06-	D4EB	2188	28x123; Baumuster: Grandeur	SK-1654AQ2	BTKW	



CM³



Art. Nr.



GRANDEUR (TG)

2.7	05/06-	G6BA	2656	32x219; Baumuster: Grandeur	SK-1739	BTK	
2.7	05/06-	G6BA	2656	32x219; mit Spanndämpfer, Spannrolle; Baumuster: Grandeur	SK-1740	BTK	
2.2 CRDi	06/06-	D4EB	2188		0-N1499	TB [BT]	S
2.2 CRDi	06/06-	D4EB	2188		0-N1500	TB [DG]	
2.7	05/06-	G6BA	2656		0-N2326	TB [TE]	
2.7	05/06-	G6BA	2656		0-N2416	TB [VD]	
2.2 CRDi	06/06-	D4EB	2188		0-N1547	VB [DG]	
2.2 CRDi	06/06-	D4EB	2188		0-N1814	VB [DG]	
2.2 CRDi	06/06-	D4EB	2188		0-N1815	VB [BT]	S
2.7	05/06-	G6BA	2656		0-N2231	VB [BT]	S
3.3	04/05-	G6DB	3342		0-N1990	VB [DG]	
3.3	04/05-	G6DB	3342		0-N2250	VB [BT]	S
3.8	06/05-	G6DA	3778		0-N1990	VB [DG]	
3.8	06/05-	G6DA	3778		0-N2250	VB [BT]	S

GRANDEUR (HG)

2.7	06/11-	G6BA	2656		0-N1576	TB [TE]	
2.7	06/11-	G6BA	2656		0-N2326	TB [TE]	
2.7	06/11-	G6BA	2656		0-N2416	TB [VD]	
2.2 D	01/11-	D4HB	2199		0-N2247	VB [BT]	S
2.4, 2.4 16V	01/11-	G4KE, G4KJ	2359		0-N2021	VB [DG]	
2.7	06/11-	G6BA	2656		0-N2231	VB [BT]	S
3.3	06/11-	G6DB	3342		0-N1990	VB [DG]	
3.3	06/11-	G6DB	3342		0-N2250	VB [BT]	S

H-1 / STAREX

2.4, 2.4 4WD	06/97-04/04	G4CS	2351	12x55; 19x123	SK-1237	BTK	
2.4, 2.4 4WD	06/97-04/04	G4CS	2351	19x123	SK-1237S	BTK	
2.5 CRDi	06/06-12/07	D4CB	2497	25.4x163; 19x99	SK-1306	BTK	
2.5 D	10/97-04/04	D4BF	2476	25.4x163; 19x99; → 07/2001	SK-1306	BTK	
2.5 D, 2.5 TCi, 2.5 TD, 2.5 TD 4WD	06/97-12/07	D4BF, D4BH	2476	25.4x163; 19x99	SK-1306	BTK	
2.5 TCi, 2.5 TD 4WD	10/97-12/07	D4BF, D4BH	2476	25.4x163; 19x99; → 08/2000	SK-1306	BTK	
2.6 TDiC	10/97-04/04	D4BB	2607	25.4x163; 19x99; → 08/2000	SK-1306	BTK	
2.4	06/01-04/04	G4JS	2351		0-N1127	TB [TE]	
2.4	06/01-04/04	G4JS	2351		0-N1498	TB [TE]	
2.4	11/01-04/04	G4JS	2351		0-N055	TB [DG]	
2.4, 2.4 4WD	06/97-04/04	G4CS	2351		0-N059	TB [TE]	
2.4, 2.4 4WD	06/97-04/04	G4CS	2351		0-N186	TB [TE]	
2.5 D	10/97-04/04	D4BF	2476		0-N061	TB [TE]	
2.5 D	10/97-04/04	D4BF	2476		0-N184	TB [TE]	
2.5 D, 2.5 TCi, 2.5 TD, 2.5 TD 4WD	06/97-12/07	D4BF, D4BH	2476		0-N061	TB [TE]	
2.5 D, 2.5 TCi, 2.5 TD, 2.5 TD 4WD	06/97-12/07	D4BF, D4BH	2476		0-N184	TB [TE]	
2.6 TDiC	10/97-04/04	D4BB	2607		0-N061	TB [TE]	
2.6 TDiC	10/97-04/04	D4BB	2607		0-N184	TB [TE]	
2.4	11/01-04/04	G4JS	2351		0-N1583	TB [BT]	
2.4, 2.4 4WD	06/97-04/04	G4CS, G4JS	2351	07/2001 →	0-N1583	TB [BT]	
2.5 CRDi, 2.5 CRDi 4x4	06/97-12/07	D4CB	2497		0-N1552	VB [BT]	S

H-1 Kasten

2.4	03/00-04/04	G4CS	2351	12x55; 19x123	SK-1237	BTK	
2.4	03/00-04/04	G4CS	2351	19x123	SK-1237S	BTK	
2.5 CRDi	07/01-04/04	D4CB	2497	25.4x163; 19x99	SK-1306	BTK	
2.5 TD	03/00-04/04	D4BF, D4BH	2476	25.4x163; 19x99	SK-1306	BTK	
2.6 CRDi	10/97-12/07	D4BB	2607	25.4x163; 19x99	SK-1306	BTK	
2.4	03/00-04/04	G4CS	2351		0-N059	TB [TE]	
2.4	03/00-04/04	G4CS	2351		0-N186	TB [TE]	
2.4	11/01-04/04	G4JS	2351		0-N055	TB [DG]	
2.4	11/01-04/04	G4JS	2351		0-N1127	TB [TE]	
2.4	11/01-04/04	G4JS	2351		0-N1498	TB [TE]	
2.5 TD	03/00-04/04	D4BF, D4BH	2476		0-N061	TB [TE]	
2.5 TD	03/00-04/04	D4BF, D4BH	2476		0-N184	TB [TE]	
2.6 CRDi	10/97-12/07	D4BB	2607		0-N061	TB [TE]	
2.6 CRDi	10/97-12/07	D4BB	2607		0-N184	TB [TE]	
2.4	03/00-04/04	G4CS	2351	07/2001 →	0-N1583	TB [BT]	
2.4	11/01-04/04	G4JS	2351		0-N1583	TB [BT]	
2.5 CRDi	07/01-12/07	D4CB	2497		0-N1552	VB [BT]	S



CM³



Art. Nr.



H-1 Kasten								
2.5 CRDi	08/03-12/07	D4CB	2497	☼		0-N1553	VB [DG]	
2.5 CRDi	08/03-12/07	D4CB	2497	☼		0-N1553	VB [DG]	
H-1 Pritsche/Fahrgestell								
2.5 D	06/00-10/05	D4BH	2476	25.4x163; 19x99		SK-1306	BTK	
2.5 D	06/00-10/05	D4BH	2476			0-N061	TB [TE]	
2.5 D	06/00-10/05	D4BH	2476			0-N184	TB [TE]	
2.5 CRDi	12/02-	D4CB	2497			0-N1552	VB [BT]	S
2.5 CRDi	12/02-	D4CB	2497	→ 12/2006; ☼		0-N1553	VB [DG]	
2.5 CRDi	12/02-	D4CB	2497	→ 12/2006; ☼		0-N1553	VB [DG]	
H-1 Cargo (TQ)								
2.5 CRDi	02/08-	D4CB, D4CB-L, D4CB-W	2497			0-N1552	VB [BT]	S
H-1 Travel (TQ)								
2.5 CRDi	05/08-	D4CB	2497			0-N1552	VB [BT]	S
H100 Bus (P)								
2.4	07/93-03/00	G4CS	2351	12x55; 19x123		SK-1237	BTK	
2.4	07/93-03/00	G4CS	2351	19x123		SK-1237S	BTK	
2.4	01/97-03/00	G4CS	2351	12x55; 19x123; 08/1997 →		SK-1237	BTK	
2.5 D	07/93-12/94	D4BA, D4BX	2477	25x163; 19x83; → 03/1994		SK-1236	BTK	
2.5 D	12/94-03/00	D4BA	2477	25.4x163; 19x99; 06/1996 → 05/1998		SK-1306	BTK	
2.5 TD	07/93-03/00	D4BF	2476	25x163; 19x83; → 03/1994		SK-1236	BTK	
2.5 TD	07/93-03/00	D4BF	2476	25.4x163; 19x99; 06/1996 →		SK-1306	BTK	
2.4	07/93-03/00	G4CS	2351			0-N059	TB [TE]	
2.4	07/93-03/00	G4CS	2351	→ 09/1995		0-N183	TB [TE]	
2.4	07/93-03/00	G4CS	2351	09/1995 →		0-N186	TB [TE]	
2.4	01/97-03/00	G4CS	2351			0-N186	TB [TE]	
2.5 D	07/93-12/94	D4BA, D4BX	2477			0-N061	TB [TE]	
2.5 D	07/93-12/94	D4BA, D4BX	2477			0-N184	TB [TE]	
2.5 D	12/94-03/00	D4BA	2477			0-N061	TB [TE]	
2.5 D	12/94-03/00	D4BA	2477			0-N184	TB [TE]	
2.5 TD	07/93-03/00	D4BF	2476			0-N061	TB [TE]	
2.5 TD	07/93-03/00	D4BF	2476			0-N184	TB [TE]	
2.6 D	10/99-10/04	D4BB	2659			0-N061	TB [TE]	
2.6 D	10/99-10/04	D4BB	2659			0-N184	TB [TE]	
H100 Kasten								
2.5 D	07/93-12/94	D4BA, D4BX	2477	25x163; 19x83; → 03/1994		SK-1236	BTK	
2.5 D	07/93-12/94	D4BA, D4BX	2477	25.4x163; 19x99; 03/1994 →		SK-1306	BTK	
2.5 D	12/94-03/00	D4BA	2477	25.4x163; 19x99; 06/1996 →		SK-1306	BTK	
2.5 TDiC	06/98-10/03	D4BF	2476	25.4x163; 19x99		SK-1306	BTK	
2.4	10/97-12/04	G4CS	2351			0-N186	TB [TE]	
2.5 D	07/93-12/94	D4BA, D4BX	2477			0-N061	TB [TE]	
2.5 D	07/93-12/94	D4BA, D4BX	2477			0-N184	TB [TE]	
2.5 D	12/94-03/00	D4BA	2477			0-N061	TB [TE]	
2.5 D	12/94-03/00	D4BA	2477			0-N184	TB [TE]	
2.5 TDiC	06/98-10/03	D4BF	2476			0-N061	TB [TE]	
2.5 TDiC	06/98-10/03	D4BF	2476			0-N184	TB [TE]	
2.6 D	10/99-12/04	D4BB	2659			0-N061	TB [TE]	
2.6 D	10/99-12/04	D4BB	2659			0-N184	TB [TE]	
H100 Pick-up								
2.5 D	05/96-10/01	D4BA	2476			0-N061	TB [TE]	
2.5 D	05/96-10/01	D4BA	2476			0-N184	TB [TE]	
H100 Pritsche/Fahrgestell								
2.4	05/96-12/97	G4CS	2351	12x55; 19x123		SK-1237	BTK	
2.5 D	07/93-12/97	D4BA	2476	25x163; 19x83; → 03/1994		SK-1236	BTK	
2.5 D	07/93-12/97	D4BA	2476	25.4x163; 19x99; 06/1996 →		SK-1306	BTK	
2.5 D	05/96-12/97	D4BF	2476	25.4x163; 19x99		SK-1306	BTK	
2.4	05/96-12/97	G4CS	2351			0-N186	TB [TE]	
2.5 D	07/93-12/97	D4BA, D4BF	2476			0-N061	TB [TE]	
2.5 D	07/93-12/97	D4BA, D4BF	2476			0-N184	TB [TE]	
H100 Pritsche/Fahrgestell								
2.5 CRDi	01/04-	D4CB	2497			0-N1552	VB [BT]	S
HIGHWAY VAN								
2.0 16V	03/00-	G4JP	1997	29x173; 12.7x65; 04/2000 →		SK-1653	BTK	

CM³

Art. Nr.



ohne Halter

HIGHWAY VAN

2.0 16V	03/00-	G4JP	1997	12.7x65; 29x173; mit Spanndämpfer, Spannrolle	SK-1746	BTK	
2.7 V6 24V	03/00-	G6BA	2656	32x207	SK-1669	BTK	
2.7 V6 24V	03/00-	G6BA-G	2656	32x207	SK-1669AQ1	BTKW	
2.7 V6 24V	03/00-	G6BA	2656	32x207; mit Spanndämpfer, Spannrolle	SK-1749	BTK	
2.0 16V	03/00-	G4JP	1997		0-N055	TB [DG]	
2.0 16V	03/00-	G4JP	1997		0-N1127	TB [TE]	
2.0 16V	03/00-	G4JP	1997		0-N1498	TB [TE]	
2.7 V6 24V	03/00-	G6BA	2656		0-N1677	VB [BT]	S
2.7 V6 24V	03/00-	G6BA-G	2656		0-N1678	VB [DG]	

i10 (PA)

1.1	12/07-	G4HG	1086	20x101	SK-1626	BTK	
1.1	12/07-	G4HG	1086		0-N1366	TB [TE]	
1.1 CRDi	01/08-	D3FA	1120		0-N1813	VB [BT]	S
1.1 CRDi	01/08-	D3FA	1120	Rippenanzahl: 5	0-N2375	VB [DG]	
1.1 CRDi	01/08-	D3FA	1120		0-N2429	VB [DG]	

i20 (PB, PBT)

1.1 CRDi	03/12-	D3FA	1120		0-N1813	VB [BT]	S
1.1 CRDi	03/12-	D3FA	1120	für Fahrzeuge mit Start-Stopp-Funktion	0-N2214	VB [BT]	S
1.1 CRDi	03/12-	D3FA	1120	Rippenanzahl: 5	0-N2375	VB [DG]	
1.1 CRDi	03/12-	D3FA	1120		0-N2429	VB [DG]	
1.4	09/08-	G4FA	1396		0-N1987	VB [DG]	
1.4	09/08-	G4FA	1396		0-N2202	VB [BT]	S
1.4 CRDi	08/08-	D4FC	1396		0-N1813	VB [BT]	S
1.4 CRDi	08/08-	D4FC	1396	für Fahrzeuge mit Start-Stopp-Funktion	0-N2214	VB [BT]	S
1.4 CRDi	08/08-	D4FC	1396	Rippenanzahl: 5	0-N2375	VB [DG]	
1.4 CRDi	08/08-	D4FC	1396		0-N2429	VB [DG]	
1.6	09/08-	G4FC	1591		0-N1987	VB [DG]	
1.6	09/08-	G4FC	1591		0-N2202	VB [BT]	S
1.6 CRDi	09/08-	D4FB	1582		0-N1813	VB [BT]	S
1.6 CRDi	09/08-	D4FB	1582	für Fahrzeuge mit Start-Stopp-Funktion	0-N2214	VB [BT]	S
1.6 CRDi	09/08-	D4FB	1582	Rippenanzahl: 5	0-N2375	VB [DG]	
1.6 CRDi	09/08-	D4FB	1582		0-N2429	VB [DG]	

i20 (GB)

1.1 CRDi	11/14-	D3FA	1120	für Fahrzeuge mit Start-Stopp-Funktion	0-N2214	VB [BT]	S
1.1 CRDi	11/14-	D3FA	1120		0-N2429	VB [DG]	
1.4 CRDi	11/14-	D4FC	1396	für Fahrzeuge mit Start-Stopp-Funktion	0-N2214	VB [BT]	S
1.4 CRDi	11/14-	D4FC	1396		0-N2429	VB [DG]	

i20 Coupe

1.4 CRDi	05/15-	D4FC	1396	für Fahrzeuge mit Start-Stopp-Funktion	0-N2214	VB [BT]	S
1.4 CRDi	05/15-	D4FC	1396		0-N2429	VB [DG]	

i30 (FD)

2.0	10/07-11/11	G4GC, G4GC-G	1975	25.4x113	SK-1684	BTK	
2.0 CRDi	10/07-11/11	D4EA	1991	28x123	SK-1654	BTK	
2.0 CRDi	10/07-11/11	D4EA	1991	28x123; 02/2008 →	SK-1654	BTK	
2.0 CRDi	10/07-11/11	D4EA	1991	28x123	SK-1654AQ2	BTKW	
2.0	10/07-11/11	G4GC, G4GC-G	1975		0-N1374	TB [DG]	
2.0	10/07-11/11	G4GC, G4GC-G	1975		0-N1619	TB [TE]	
2.0 CRDi	10/07-11/11	D4EA	1991		0-N1499	TB [BT]	S
2.0 CRDi	10/07-11/11	D4EA	1991	02/2008 →	0-N1499	TB [BT]	S
2.0 CRDi	10/07-11/11	D4EA	1991		0-N1500	TB [DG]	
1.4	10/07-11/11	G4FA	1396		0-N1987	VB [DG]	
1.4	10/07-11/11	G4FA	1396		0-N2202	VB [BT]	S
1.6	10/07-11/11	G4FC	1591		0-N1987	VB [DG]	
1.6	10/07-11/11	G4FC	1591		0-N2202	VB [BT]	S
1.6 CRDi	10/07-11/11	D4FB	1582		0-N1813	VB [BT]	S
1.6 CRDi	10/07-11/11	D4FB	1582	für Fahrzeuge mit Start-Stopp-Funktion	0-N2214	VB [BT]	S
1.6 CRDi	10/07-11/11	D4FB	1582	Rippenanzahl: 5	0-N2375	VB [DG]	
1.6 CRDi	10/07-11/11	D4FB	1582		0-N2429	VB [DG]	
2.0	10/07-11/11	G4GC, G4GC-G	1975		0-N1815	VB [BT]	S
2.0	10/07-11/11	G4GC, G4GC-G	1975		0-N1854	VB [BT]	
2.0 CRDi	10/07-11/11	D4EA	1991		0-N1547	VB [DG]	
2.0 CRDi	10/07-11/11	D4EA	1991		0-N1814	VB [DG]	
2.0 CRDi	10/07-11/11	D4EA	1991		0-N1815	VB [BT]	S

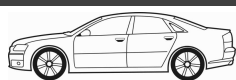

CM³



Art. Nr.

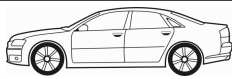

i30 CW (FD)							
2.0	02/08-06/12	G4GC, G4GC-G	1975	25.4x113		SK-1684	BTK
2.0 CRDi	02/08-06/12	D4EA	1991	28x123		SK-1654	BTK
2.0 CRDi	02/08-06/12	D4EA	1991	28x123		SK-1654AQ2	BTKW
2.0	02/08-06/12	G4GC, G4GC-G	1975			0-N1374	TB [DG]
2.0	02/08-06/12	G4GC, G4GC-G	1975			0-N1619	TB [TE]
2.0 CRDi	02/08-06/12	D4EA	1991			0-N1499	TB [BT] S
2.0 CRDi	02/08-06/12	D4EA	1991			0-N1500	TB [DG]
1.4	10/07-06/12	G4FA	1396			0-N1987	VB [DG]
1.4	10/07-06/12	G4FA	1396			0-N2202	VB [BT] S
1.6	02/08-06/12	G4FC	1591			0-N1987	VB [DG]
1.6	02/08-06/12	G4FC	1591			0-N2202	VB [BT] S
1.6 CRDi	02/08-06/12	D4FB	1582			0-N1813	VB [BT] S
1.6 CRDi	02/08-06/12	D4FB	1582	für Fahrzeuge mit Start-Stopp-Funktion		0-N2214	VB [BT] S
1.6 CRDi	02/08-06/12	D4FB	1582	Rippenanzahl: 5		0-N2375	VB [DG]
1.6 CRDi	02/08-06/12	D4FB	1582			0-N2429	VB [DG]
2.0	02/08-06/12	G4GC, G4GC-G	1975			0-N1815	VB [BT] S
2.0	02/08-06/12	G4GC, G4GC-G	1975			0-N1854	VB [BT]
2.0 CRDi	02/08-06/12	D4EA	1991			0-N1547	VB [DG]
2.0 CRDi	02/08-06/12	D4EA	1991	※		0-N1814	VB [DG]
2.0 CRDi	02/08-06/12	D4EA	1991			0-N1815	VB [BT] S
i30 (GD)							
1.4	12/11-	G4FA	1396			0-N1987	VB [DG]
1.4	12/11-	G4FA	1396			0-N2202	VB [BT] S
1.4 CRDi	12/11-	D4FC	1396			0-N1813	VB [BT] S
1.4 CRDi	12/11-	D4FC	1396	für Fahrzeuge mit Start-Stopp-Funktion		0-N2214	VB [BT] S
1.4 CRDi	12/11-	D4FC	1396	Rippenanzahl: 5		0-N2375	VB [DG]
1.4 CRDi	12/11-	D4FC	1396			0-N2429	VB [DG]
1.6 CRDi	11/11-	D4FB	1582	für Fahrzeuge mit Start-Stopp-Funktion		0-N2214	VB [BT] S
1.6 CRDi	11/11-	D4FB	1582			0-N2429	VB [DG]
1.6 CRDi	12/11-	D4FB	1582			0-N1813	VB [BT] S
1.6 CRDi	12/11-	D4FB	1582	Rippenanzahl: 5		0-N2375	VB [DG]
1.6, 1.6 GDI	12/11-	G4FC, G4FD, G4FG	1591			0-N1987	VB [DG]
1.6, 1.6 GDI	12/11-	G4FC, G4FD	1591			0-N2202	VB [BT] S
i30 Coupe							
1.4	05/13-	G4FA	1396			0-N1987	VB [DG]
1.4 CRDi	05/13-	D4FC	1396			0-N1813	VB [BT] S
1.4 CRDi	05/13-	D4FC	1396	für Fahrzeuge mit Start-Stopp-Funktion		0-N2214	VB [BT] S
1.4 CRDi	05/13-	D4FC	1396	Rippenanzahl: 5		0-N2375	VB [DG]
1.4 CRDi	05/13-	D4FC	1396			0-N2429	VB [DG]
1.6 CRDi	05/13-	D4FB	1582			0-N1813	VB [BT] S
1.6 CRDi	05/13-	D4FB	1582	für Fahrzeuge mit Start-Stopp-Funktion		0-N2214	VB [BT] S
1.6 CRDi	05/13-	D4FB	1582	Rippenanzahl: 5		0-N2375	VB [DG]
1.6 CRDi	05/13-	D4FB	1582			0-N2429	VB [DG]
1.6 GDI	05/13-	G4FD	1591			0-N1987	VB [DG]
i30 CW (GD)							
1.4	06/12-	G4FA	1396			0-N1987	VB [DG]
1.4 CRDi	06/12-	D4FC	1396			0-N1813	VB [BT] S
1.4 CRDi	06/12-	D4FC	1396	für Fahrzeuge mit Start-Stopp-Funktion		0-N2214	VB [BT] S
1.4 CRDi	06/12-	D4FC	1396	Rippenanzahl: 5		0-N2375	VB [DG]
1.4 CRDi	06/12-	D4FC	1396			0-N2429	VB [DG]
1.6 CRDi	06/12-	D4FB, D4FB-5P	1582			0-N1813	VB [BT] S
1.6 CRDi	06/12-	D4FB, D4FB-5P	1582	für Fahrzeuge mit Start-Stopp-Funktion		0-N2214	VB [BT] S
1.6 CRDi	06/12-	D4FB, D4FB-5P	1582	Rippenanzahl: 5		0-N2375	VB [DG]
1.6 CRDi	06/12-	D4FB, D4FB-5P	1582			0-N2429	VB [DG]
1.6, 1.6 GDI	06/12-	G4FD, G4FG	1591			0-N1987	VB [DG]
i40 (VF)							
1.6 GDI	03/12-	G4FD	1591			0-N1987	VB [DG]
1.6 GDI	03/12-	G4FD	1591			0-N2202	VB [BT] S
1.7 CRDi	03/12-	D4FD	1685			0-N1813	VB [BT] S
1.7 CRDi	03/12-	D4FD	1685	für Fahrzeuge mit Start-Stopp-Funktion		0-N2214	VB [BT] S
1.7 CRDi	03/12-	D4FD	1685	Rippenanzahl: 5		0-N2375	VB [DG]
1.7 CRDi	03/12-	D4FD	1685			0-N2429	VB [DG]

CM³

Art. Nr.



ohne Halter

i40 CW (VF)							
1.6 GDI	07/11-	G4FD	1591			0-N1987	VB [DG]
1.6 GDI	07/11-	G4FD	1591			0-N2202	VB [BT] S
1.7 CRDi	07/11-	D4FD	1685			0-N1813	VB [BT] S
1.7 CRDi	07/11-	D4FD	1685	für Fahrzeuge mit Start-Stopp-Funktion		0-N2214	VB [BT] S
1.7 CRDi	07/11-	D4FD	1685	Rippenanzahl: 5		0-N2375	VB [DG]
1.7 CRDi	07/11-	D4FD	1685			0-N2429	VB [DG]
ix20 (JC)							
1.4	11/10-	G4FA	1396			0-N1987	VB [DG]
1.4	11/10-	G4FA	1396			0-N2202	VB [BT] S
1.4 CRDi	11/10-	D4FC, D4FC-M	1396			0-N1813	VB [BT] S
1.4 CRDi	11/10-	D4FC, D4FC-M	1396	für Fahrzeuge mit Start-Stopp-Funktion		0-N2214	VB [BT] S
1.4 CRDi	11/10-	D4FC, D4FC-M	1396	Rippenanzahl: 5		0-N2375	VB [DG]
1.4 CRDi	11/10-	D4FC, D4FC-M	1396			0-N2429	VB [DG]
1.6	11/10-	G4FC	1591			0-N1987	VB [DG]
1.6	11/10-	G4FC	1591			0-N2202	VB [BT] S
1.6 CRDi	06/11-	D4FB	1582			0-N1813	VB [BT] S
1.6 CRDi	06/11-	D4FB	1582	für Fahrzeuge mit Start-Stopp-Funktion		0-N2214	VB [BT] S
1.6 CRDi	06/11-	D4FB	1582	Rippenanzahl: 5		0-N2375	VB [DG]
1.6 CRDi	06/11-	D4FB	1582			0-N2429	VB [DG]
ix35 (LM, EL, ELH)							
1.6	11/10-	G4FD	1591			0-N1987	VB [DG]
1.6	11/10-	G4FD	1591			0-N2202	VB [BT] S
1.7 CRDi	11/10-	D4FD	1685			0-N1813	VB [BT] S
1.7 CRDi	11/10-	D4FD	1685	für Fahrzeuge mit Start-Stopp-Funktion		0-N2214	VB [BT] S
1.7 CRDi	11/10-	D4FD	1685	Rippenanzahl: 5		0-N2375	VB [DG]
1.7 CRDi	11/10-	D4FD	1685			0-N2429	VB [DG]
2.0 CRDi, 2.0 CRDi Allrad, 2.0 CRDi AWD	01/10-	D4HA	1995			0-N2247	VB [BT] S
2.0 CRDi, 2.0 CRDi Allrad, 2.0 CRDi AWD	01/10-	D4HA	1995			0-N2248	VB [DG]
2.0 CRDi, 2.0 CRDi Allrad, 2.0 CRDi AWD	01/10-	D4HA	1995			0-N2249	VB [DG]
2.0 CRDi, 2.0 CRDi Allrad, 2.0 CRDi AWD	01/10-	D4HA	1995	Rippenanzahl: 6		0-N2377	VB [DG]
2.0, 2.0 Allrad	01/10-	G4KD	1998			0-N2108	VB [BT] S
2.0, 2.0 Allrad, 2.0 CVVT	08/09-	G4KD	1998			0-N2021	VB [DG]
2.4 DCVVT-I 4WD, 2.4 GDi 4WD	07/10-12/13	G4KE, G4KJ	2359			0-N2021	VB [DG]
LANTRA I (J-1)							
1.5 i.e.	10/90-11/95	G15B, G4DJ	1468	19x92		SK-1242	BTK
1.6 i.e. 16V	10/90-11/95	G4CR	1596	12.7x65; 29x151; → 05/1995		SK-1310	BTK
1.6 i.e. 16V	10/90-11/95	G4CR	1596	12.7x65		SK-1649	BTK
1.8 i.e. 16V	10/90-11/95	G4CN	1836	29x153; 12.7x65		SK-1555	BTK
1.8 i.e. 16V	10/90-11/95	G4CN	1836	12.7x65		SK-1649	BTK
1.5 i.e.	10/90-11/95	G15B, G4DJ	1468			0-N986	TB [TE]
1.6 i.e. 16V	10/90-11/95	G4CR	1596			0-N054	TB [TE]
1.6 i.e. 16V	10/90-11/95	G4CR	1596			0-N055	TB [DG]
1.6 i.e. 16V	10/90-11/95	G4CR	1596			0-N179	TB [TE]
1.6 i.e. 16V	10/90-11/95	G4CR	1596			0-N1971	TB [BT]
1.8 i.e. 16V	10/90-11/95	G4CN	1836			0-N054	TB [TE]
1.8 i.e. 16V	10/90-11/95	G4CN	1836			0-N055	TB [DG]
1.8 i.e. 16V	10/90-11/95	G4CN	1836			0-N179	TB [TE]
1.8 i.e. 16V	10/90-11/95	G4CN	1836			0-N1971	TB [BT]
LANTRA II (J-2)							
1.5 12V	12/96-09/00	G4EK	1495	22x92; → 11/1998		SK-1320	BTK
1.5 12V	12/96-09/00	G4EK	1495	22x110; 11/1998 → 05/2000		SK-1439	BTK
1.6 16V, 1.6 i	11/95-09/00	4G61, G4GR	1599	25x111		SK-1440	BTK
1.8 16V	11/95-09/00	G4GM	1795	25x111		SK-1440	BTK
1.9 D	03/98-09/00	DJY	1905	25.4x136		SK-1022	BTK
2.0	04/97-05/00	G4JP	1997	25x113		SK-1656	BTK
2.0 16V	08/96-09/00	G4GF	1975	25.4x113; 04/1997 → 05/2000		SK-1651	BTK
2.0 16V	08/96-09/00	G4GF	1975	25x113; 04/1997 →		SK-1656	BTK
1.5 12V	12/96-09/00	G4EK	1495			0-N975	TB [TE]
1.6 16V, 1.6 i	11/95-09/00	4G61, G4GR	1599			0-N1374	TB [DG]
1.6 16V, 1.6 i	11/95-09/00	4G61, G4GR	1599			0-N1561	TB [TE]
1.8 16V	11/95-09/00	G4GM	1795			0-N1374	TB [DG]
1.8 16V	11/95-09/00	G4GM	1795			0-N1561	TB [TE]
1.9 D	03/98-09/00	DJY	1905			0-N900	TB [DG]
1.9 D	03/98-09/00	DJY	1905			0-N901	TB [TE]



CM³



Art. Nr.



LANTRA II (J-2)							
2.0 16V	08/96-09/00	G4GF	1975			0-N1374	TB [DG]
2.0 16V	08/96-09/00	G4GF	1975			0-N1561	TB [TE]
1.6 16V, 1.6 i	11/95-09/00	4G61, G4GR	1599			0-N1854	VB [BT]
1.8 16V	11/95-09/00	G4GM	1795			0-N1854	VB [BT]
2.0 16V	08/96-09/00	G4GF	1975			0-N1854	VB [BT]

LANTRA II Wagon (J-2)							
1.5 12V	04/97-10/00	G4EK	1495	22x92; → 11/1998		SK-1320	BTK
1.5 12V	04/97-10/00	G4EK	1495	22x110; 11/1998 → 05/2000		SK-1439	BTK
1.6 16V, 1.6 i	02/96-10/00	4G61, G4GR	1599	25x111		SK-1440	BTK
1.8 16V	02/96-10/00	G4GM	1795	25x111		SK-1440	BTK
1.9 D	03/98-10/00	DJY	1905	25.4x136		SK-1022	BTK
2.0	04/97-05/00	G4JP	1997	25x113		SK-1656	BTK
2.0 16V	12/96-10/00	G4GF	1975	25.4x113; 04/1997 → 05/2000		SK-1651	BTK
2.0 16V	12/96-10/00	G4GF	1975	25x113		SK-1656	BTK
1.5 12V	04/97-10/00	G4EK	1495			0-N975	TB [TE]
1.6 16V, 1.6 i	02/96-10/00	4G61, G4GR	1599			0-N1374	TB [DG]
1.6 16V, 1.6 i	02/96-10/00	4G61, G4GR	1599			0-N1561	TB [TE]
1.8 16V	02/96-10/00	G4GM	1795			0-N1374	TB [DG]
1.8 16V	02/96-10/00	G4GM	1795			0-N1561	TB [TE]
1.9 D	03/98-10/00	DJY	1905			0-N900	TB [DG]
1.9 D	03/98-10/00	DJY	1905			0-N901	TB [TE]
2.0 16V	12/96-10/00	G4GF	1975			0-N1374	TB [DG]
2.0 16V	12/96-10/00	G4GF	1975			0-N1561	TB [TE]
1.6 16V, 1.6 i	02/96-10/00	4G61, G4GR	1599			0-N1854	VB [BT]
1.8 16V	02/96-10/00	G4GM	1795			0-N1854	VB [BT]
2.0 16V	12/96-10/00	G4GF	1975			0-N1854	VB [BT]

MATRIX (FC)							
1.5 CRDi	10/01-08/10	D3EA	1496	28x123		SK-1654	BTK
1.5 CRDi	10/01-08/10	D3EA	1496	28x123		SK-1654AQ1	BTKW
1.6	06/01-08/10	G4ED-G, G4ED-L	1599	22x105		SK-1634	BTK
1.6	06/01-08/10	G4ED-G, G4ED-L	1599	22x105		SK-1634AQ1	BTKW
1.8	06/01-08/10	G4GB-G	1795	25x111		SK-1440	BTK
1.5 CRDi	10/01-08/10	D3EA	1496			0-N1499	TB [BT] S
1.5 CRDi	10/01-08/10	D3EA	1496			0-N1500	TB [DG]
1.6	06/01-08/10	G4ED-G, G4ED-L	1599			0-N1370	TB [DG]
1.6	06/01-08/10	G4ED-G, G4ED-L	1599			0-N975	TB [TE]
1.8	06/01-08/10	G4GB-G	1795			0-N1374	TB [DG]
1.8	06/01-08/10	G4GB-G	1795			0-N1561	TB [TE]
1.8	06/01-08/10	G4GB-G	1795	05/2006 →		0-N1619	TB [TE]
1.5 CRDi	10/01-08/10	D3EA	1496			0-N1547	VB [DG]
1.5 CRDi	10/01-08/10	D3EA	1496	※		0-N1814	VB [DG]
1.5 CRDi	10/01-08/10	D3EA	1496			0-N1815	VB [BT] S
1.5 CRDi VGT	08/05-08/10	D4FA	1493	※		0-N1814	VB [DG]
1.5 CRDi, 1.5 CRDi VGT	12/04-08/10	D4FA	1493			0-N1813	VB [BT] S
1.5 CRDi, 1.5 CRDi VGT	12/04-08/10	D4FA	1493	Rippenanzahl: 5		0-N2375	VB [DG]
1.5 CRDi, 1.5 CRDi VGT	12/04-08/10	D4FA	1493			0-N2429	VB [DG]
1.6	06/01-08/10	G4ED-G	1599	※		0-N1814	VB [DG]
1.6	06/01-08/10	G4ED-G, G4ED-L	1599			0-N1854	VB [BT]
1.8	06/01-08/10	G4GB-G	1795			0-N1854	VB [BT]

PONY (X-1)							
1.3	10/85-09/89	G13B	1299	19.05x92		SK-1317	BTK

PONY Stufenheck (X-1)							
1.3	10/85-09/89	G13B	1299	19.05x92		SK-1317	BTK
1.5	10/85-09/89	G15B, G4DJ	1468	19.05x92		SK-1317	BTK

PONY (X-2)							
1.3	10/89-01/95	G4DG	1299	19x92; 01/1990 →		SK-1242	BTK
1.5	10/89-01/95	G15B, G4DJ	1468	19.05x92; → 12/1989		SK-1317	BTK
1.5, 1.5 i	10/89-01/95	G15B, G4DJ	1468	19x92; 01/1990 →		SK-1242	BTK
1.3	10/89-01/95	G4DG	1299	08/1994 →		0-N975	TB [TE]
1.3	10/89-01/95	G4DG	1299	→ 07/1994		0-N986	TB [TE]
1.5, 1.5 i	10/89-01/95	G15B, G4DJ	1468	08/1994 →		0-N975	TB [TE]
1.5, 1.5 i	10/89-01/95	G15B, G4DJ	1468	→ 07/1994		0-N986	TB [TE]

CM³

Art. Nr.

**PONY / EXCEL Stufenheck (X-2)**

1.3	09/89-08/94	G4DG	1298	19.05x92; → 12/1989	SK-1317	BTK	
1.5, 1.5 i	01/90-01/95	G15B, G4DJ	1468	19x92	SK-1242	BTK	
1.3	01/90-01/95	G4DG	1299	08/1994 →	0-N975	TB [TE]	
1.5, 1.5 i	01/90-01/95	G15B, G4DJ	1468	08/1994 →	0-N975	TB [TE]	
1.5, 1.5 i	01/90-01/95	G15B, G4DJ	1468	→ 07/1994	0-N986	TB [TE]	

PORTER Bus

2.5 TD	07/94-04/04	D4BH	2477	25.4x163; 19x99	SK-1306	BTK	
2.5 TD	07/94-04/04	D4BA	2476	25.4x163; 19x99; 06/1996 →	SK-1306	BTK	
2.4	03/96-04/04	G4CS	2351		0-N186	TB [TE]	
2.5 TD	07/94-04/04	D4BA	2476		0-N061	TB [TE]	
2.5 TD	07/94-04/04	D4BH	2477		0-N061	TB [TE]	
2.5 TD	07/94-04/04	D4BA	2476		0-N184	TB [TE]	
2.5 TD	07/94-04/04	D4BH	2477		0-N184	TB [TE]	
2.5 CRDi	02/03-04/04	D4CB	2497		0-N1552	VB [BT]	S

PORTER Kasten

2.5 TCi, 2.5 TD	07/94-04/04	D4BH	2477	25.4x163; 19x99	SK-1306	BTK	
2.5 TD	07/94-04/04	D4BA	2476	25.4x163; 19x99; 06/1996 →	SK-1306	BTK	
2.6 TD	07/94-04/04	D4BB	2607	25.4x163; 19x99	SK-1306	BTK	
2.4	03/96-04/04	G4CS	2351		0-N186	TB [TE]	
2.5 TCi, 2.5 TD	07/94-04/04	D4BH	2477		0-N061	TB [TE]	
2.5 TCi, 2.5 TD	07/94-04/04	D4BH	2477		0-N184	TB [TE]	
2.5 TD	07/94-04/04	D4BA	2476		0-N061	TB [TE]	
2.5 TD	07/94-04/04	D4BA	2476		0-N184	TB [TE]	
2.6 TD	07/94-04/04	D4BB	2607		0-N061	TB [TE]	
2.6 TD	07/94-04/04	D4BB	2607		0-N184	TB [TE]	
2.5 CRDi	02/03-04/04	D4CB	2497		0-N1552	VB [BT]	S

PORTER Pick-up

2.5 TD	07/94-04/04	D4BH	2477	25.4x163; 19x99	SK-1306	BTK	
2.5 TD	07/94-04/04	D4BA	2476	25.4x163; 19x99; 06/1996 →	SK-1306	BTK	
2.6 TD	07/94-04/04	D4BB	2607	25.4x163; 19x99	SK-1306	BTK	
2.4	03/96-04/04	G4CS	2351		0-N186	TB [TE]	
2.5 TD	07/94-04/04	D4BA	2476		0-N061	TB [TE]	
2.5 TD	07/94-04/04	D4BH	2477		0-N061	TB [TE]	
2.5 TD	07/94-04/04	D4BA	2476		0-N184	TB [TE]	
2.5 TD	07/94-04/04	D4BH	2477		0-N184	TB [TE]	
2.6 TD	07/94-04/04	D4BB	2607		0-N061	TB [TE]	
2.6 TD	07/94-04/04	D4BB	2607		0-N184	TB [TE]	
2.5 CRDi	02/03-04/04	D4CB	2497		0-N1552	VB [BT]	S

PORTER Kasten

2.5 TCi, 2.5 TD	05/04-	D4BH	2477	25.4x163; 19x99	SK-1306	BTK	
2.5 TCi, 2.5 TD	05/04-	D4BH	2477		0-N061	TB [TE]	
2.5 TCi, 2.5 TD	05/04-	D4BH	2477		0-N184	TB [TE]	
2.5 CRDi	05/04-	D4CB	2497		0-N1552	VB [BT]	S

S COUPE (SLC)

1.5 i	02/90-05/96	G15B, G4DJ	1468	19x92	SK-1242	BTK	
1.5 i, 1.5 i Turbo	04/91-05/96	G4EK, G4EK-TC	1495	19x92; 07/1993 →	SK-1242	BTK	
1.5 i, 1.5 i Turbo	04/91-05/96	G4EK, G4EK-TC	1495	22x92; 07/1993 →	SK-1320	BTK	
1.5 i	02/90-05/96	G15B, G4DJ	1468		0-N986	TB [TE]	
1.5 i, 1.5 i Turbo	04/91-05/96	G4EK, G4EK-TC	1495		0-N975	TB [TE]	

SANTA FÉ I (SM)

2.0	08/01-03/06	G4BP	1997	29x173; 12.7x65; → 12/2005	SK-1653	BTK	
2.0	08/01-03/06	G4BP	1997	12.7x65; 29x173; mit Spanndämpfer, Spannrolle	SK-1746	BTK	
2.0 CRDi, 2.0 CRDi 4x4, 2.0 CRDi Allrad	04/01-03/06	D4EA	1991	28x123	SK-1654	BTK	
2.0 CRDi, 2.0 CRDi 4x4, 2.0 CRDi Allrad	04/01-03/06	D4EA	1991	28x123	SK-1654AQ1	BTKW	
2.2 CRDi	10/05-03/06	D4EB	2188	28x123	SK-1654	BTK	
2.7 4x4	11/00-03/06	G6EA	2656	32x207; 03/2001 → 12/2005	SK-1669	BTK	
2.7 4x4, 2.7 V6 4x4	11/00-03/06	G6BA-G, G6EA	2656	32x207; mit Spanndämpfer, Spannrolle	SK-1749	BTK	
2.7, 2.7 4x4, 2.7 V6 4x4	02/01-03/06	G6BA-G, G6EA	2656	32x207; Nockenwelle: DOHC; → 12/2005	SK-1669	BTK	
2.7, 2.7 V6 4x4	02/01-03/06	G6BA-G, G6EA	2656	32x207	SK-1669AQ1	BTKW	
2.0	08/01-03/06	G4BP	1997		0-N055	TB [DG]	
2.0	08/01-03/06	G4BP	1997	→ 12/2005	0-N1127	TB [TE]	
2.0	08/01-03/06	G4BP	1997		0-N1498	TB [TE]	

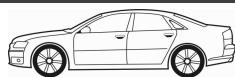

CM³



Art. Nr.



SANTA FÉ I (SM)								
2.0 CRDi, 2.0 CRDi 4x4, 2.0 CRDi Allrad	04/01-03/06	D4EA	1991			0-N1499	TB [BT]	S
2.0 CRDi, 2.0 CRDi 4x4, 2.0 CRDi Allrad	04/01-03/06	D4EA	1991			0-N1500	TB [DG]	
2.2 CRDi	10/05-03/06	D4EB	2188			0-N1499	TB [BT]	S
2.2 CRDi	10/05-03/06	D4EB	2188			0-N1500	TB [DG]	
2.4 16V, 2.4 16V 4x4	02/01-03/06	G4JS-G	2351			0-N055	TB [DG]	
2.4 16V, 2.4 16V 4x4	02/01-03/06	G4JS-G	2351	→ 12/2005		0-N1127	TB [TE]	
2.4 16V, 2.4 16V 4x4	02/01-03/06	G4JS-G	2351			0-N1498	TB [TE]	
2.7 4x4, 2.7 V6 4x4	11/00-03/06	G6BA-G, G6EA	2656	→ 12/2005; Spannrollenbetätigung: hydraulisch		0-N2428	TB [VD]	
2.7, 2.7 4x4	11/00-03/06	G6EA	2656			0-N2326	TB [TE]	
2.7, 2.7 4x4	11/00-03/06	G6EA	2656			0-N2416	TB [VD]	
2.7, 2.7 4x4, 2.7 V6 4x4	02/01-03/06	G6BA-G, G6EA	2656			0-N1576	TB [TE]	
2.7, 2.7 V6 4x4	02/01-03/06	G6BA-G, G6EA	2656			0-N1577	TB [DG]	
3.5, 3.5 4x4	09/03-02/06	G6CU	3497			0-N185	TB [TE]	
3.5, 3.5 4x4	09/03-02/06	G6CU	3497			0-N189	TB [DG]	
2.0	08/01-03/06	G4BP	1997	→ 12/2005		0-N1583	TB [BT]	
2.0 CRDi Allrad	11/03-02/06	D4EA	1991	☞		0-N1814	VB [DG]	
2.0 CRDi, 2.0 CRDi 4x4	04/01-03/06	D4EA	1991	→ 12/2005; ☞		0-N1814	VB [DG]	
2.0 CRDi, 2.0 CRDi 4x4, 2.0 CRDi Allrad	04/01-03/06	D4EA	1991			0-N1547	VB [DG]	
2.0 CRDi, 2.0 CRDi 4x4, 2.0 CRDi Allrad	04/01-03/06	D4EA	1991			0-N1815	VB [BT]	S
2.2 CRDi	10/05-03/06	D4EB	2188	☞		0-N1814	VB [DG]	
2.4 16V, 2.4 16V 4x4	02/01-03/06	G4JS-G	2351	→ 12/2005		0-N1583	TB [BT]	
2.4 16V, 2.4 16V 4x4	02/01-03/06	G4JS-G	2351			0-N1853	VB [BT]	
2.7 V6 4x4	02/01-03/06	G6BA-G	2656			0-N1677	VB [BT]	S
2.7, 2.7 4x4	11/00-03/06	G6EA	2656			0-N2231	VB [BT]	S
2.7, 2.7 V6 4x4	02/01-03/06	G6BA-G, G6EA	2656			0-N1678	VB [DG]	
SANTA FÉ II (CM)								
2.0 CRDi, 2.0 CRDi 4x4	12/10-	D4HA	1995	28x123		SK-1654	BTK	
2.0 CRDi, 2.0 CRDi 4x4	12/10-	D4HA	1995	28x123		SK-1654AQ2	BTKW	
2.2 CRDi, 2.2 CRDi 4x4	01/09-	D4HB	2199	28x123		SK-1654	BTK	
2.2 CRDi, 2.2 CRDi 4x4, 2.2 CRDi GLS, 2.2 CRDi GLS 4x4	10/05-03/06	D4EB	2188	28x123		SK-1654	BTK	
2.2 CRDi, 2.2 CRDi 4x4, 2.2 CRDi GLS, 2.2 CRDi GLS 4x4	03/06-	D4EB	2188	28x123		SK-1654AQ2	BTKW	
2.7 V6 GLS, 2.7 V6 GLS 4x4	03/06-	G6EA	2656	32x219		SK-1739	BTK	
2.7 V6 GLS, 2.7 V6 GLS 4x4	03/06-	G6EA	2656	32x219; mit Spanndämpfer, Spannrolle		SK-1740	BTK	
2.7, 2.7 4x4	03/06-	G6BA	2657	32x207		SK-1669AQ1	BTKW	
2.7, 2.7 4x4	03/06-	G6BA	2657	32x219		SK-1739	BTK	
2.7, 2.7 4x4	03/06-	G6BA	2657	32x219; mit Spanndämpfer, Spannrolle		SK-1740	BTK	
2.0 CRDi	12/10-	D4HA	1995	→ 08/2012		0-N1499	TB [BT]	S
2.0 CRDi 4x4	12/10-	D4HA	1995	→ 12/2012		0-N1499	TB [BT]	S
2.2 CRDi, 2.2 CRDi 4x4	01/09-	D4HB	2199			0-N1499	TB [BT]	S
2.2 CRDi, 2.2 CRDi 4x4, 2.2 CRDi GLS, 2.2 CRDi GLS 4x4	10/05-03/06	D4EB	2188			0-N1499	TB [BT]	S
2.2 CRDi, 2.2 CRDi 4x4, 2.2 CRDi GLS, 2.2 CRDi GLS 4x4	10/05-03/06	D4EB	2188			0-N1500	TB [DG]	
2.7 V6 GLS, 2.7 V6 GLS 4x4	03/06-	G6EA	2656			0-N1576	TB [TE]	
2.7 V6 GLS, 2.7 V6 GLS 4x4	03/06-	G6EA	2656			0-N2326	TB [TE]	
2.7 V6 GLS, 2.7 V6 GLS 4x4	03/06-	G6EA	2656			0-N2416	TB [VD]	
2.7, 2.7 4x4	03/06-	G6BA	2657			0-N1576	TB [TE]	
2.7, 2.7 4x4	03/06-	G6BA	2657			0-N1577	TB [DG]	
2.0 CRDi, 2.0 CRDi 4x4	03/06-	D4HA	1995			0-N2247	VB [BT]	S
2.0 CRDi, 2.0 CRDi 4x4	12/10-	D4HA	1995			0-N2248	VB [DG]	
2.0 CRDi, 2.0 CRDi 4x4	12/10-	D4HA	1995	Rippenanzahl: 6		0-N2377	VB [DG]	
2.2 CRDi 4x4	10/05-03/06	D4EB	2188	☞		0-N1814	VB [DG]	
2.2 CRDi, 2.2 CRDi 4x4	01/09-	D4HB	2199			0-N2247	VB [BT]	S
2.2 CRDi, 2.2 CRDi 4x4	01/09-	D4HB	2199			0-N2248	VB [DG]	
2.2 CRDi, 2.2 CRDi 4x4	01/09-	D4HB	2199	Rippenanzahl: 6		0-N2377	VB [DG]	
2.2 CRDi, 2.2 CRDi 4x4, 2.2 CRDi GLS, 2.2 CRDi GLS 4x4	03/06-	D4EB	2188			0-N1547	VB [DG]	
2.2 CRDi, 2.2 CRDi 4x4, 2.2 CRDi GLS, 2.2 CRDi GLS 4x4	03/06-	D4EB	2188	→ 07/2008; ☞		0-N1814	VB [DG]	
2.2 CRDi, 2.2 CRDi 4x4, 2.2 CRDi GLS, 2.2 CRDi GLS 4x4	03/06-	D4EB	2188			0-N1815	VB [BT]	S
2.4, 2.4 4x4	07/10-	G4KE	2359			0-N2021	VB [DG]	
2.4, 2.4 4x4	07/10-	G4KE	2359			0-N2108	VB [BT]	S
2.7 V6 GLS, 2.7 V6 GLS 4x4	03/06-	G6EA	2656			0-N2231	VB [BT]	S

CM³

Art. Nr.



ohne Halter

SANTA FÉ II (CM)										
2.7, 2.7 4x4	03/06-	G6BA	2657					0-N1678	VB [DG]	
SANTA FÉ III (DM)										
2.0 CRDi, 2.0 CRDi 4WD	09/12-	D4HA	1995					0-N2247	VB [BT]	S
2.0 CRDi, 2.0 CRDi 4WD	09/12-	D4HA	1995					0-N2248	VB [DG]	
2.0 CRDi, 2.0 CRDi 4WD	09/12-	D4HA	1995					0-N2249	VB [DG]	
2.0 CRDi, 2.0 CRDi 4WD	09/12-	D4HA	1995	Rippenanzahl: 6				0-N2377	VB [DG]	
2.2 CRDi, 2.2 CRDi 4WD	09/12-	D4HB	2199					0-N2247	VB [BT]	S
2.2 CRDi, 2.2 CRDi 4WD	09/12-	D4HB	2199					0-N2248	VB [DG]	
2.2 CRDi, 2.2 CRDi 4WD	09/12-	D4HB	2199					0-N2249	VB [DG]	
2.2 CRDi, 2.2 CRDi 4WD	09/12-	D4HB	2199	Rippenanzahl: 6				0-N2377	VB [DG]	
2.4, 2.4 4WD	09/12-	G4KJ	2359					0-N2021	VB [DG]	
GRAND SANTA FÉ										
2.2 CRDi AWD	06/13-	D4HB	2199					0-N2247	VB [BT]	S
2.2 CRDi AWD	06/13-	D4HB	2199					0-N2248	VB [DG]	
2.2 CRDi AWD	06/13-	D4HB	2199	Rippenanzahl: 6				0-N2377	VB [DG]	
SANTAMO										
2.0 16V, 2.0 16V 4x4	05/99-	G4CP, G4JP	1997	29x153; 12.7x65; → 10/2002				SK-1555	BTK	
2.0 16V, 2.0 16V 4x4	05/99-	G4CP, G4JP	1997					0-N054	TB [TE]	
2.0 16V, 2.0 16V 4x4	05/99-	G4CP, G4JP	1997					0-N055	TB [DG]	
2.0 16V, 2.0 16V 4x4	05/99-	G4CP, G4JP	1997					0-N179	TB [TE]	
2.0 16V, 2.0 16V 4x4	05/99-	G4CP, G4JP	1997					0-N1971	TB [BT]	
SONATA II (Y-2)										
1.8 i	09/88-10/93	4G62	1796	24x122; 12.7x55; 07/1993 →				SK-1312	BTK	
2.0 i	01/91-10/93	G4CP-U	1997	19x122; → 07/1993				SK-1240S	BTK	
2.0 i	01/91-10/93	G4CP-U	1997	24x122; 12.7x55; 07/1993 →				SK-1312	BTK	
2.0 i 16V	01/91-10/93	G4CP-D	1997	29x153; 12.7x65				SK-1555	BTK	
2.0 i 16V	01/91-10/93	G4CP-D	1997	12.7x65				SK-1649	BTK	
2.4 i	09/88-08/91	G4CS	2351	19x123				SK-1237S	BTK	
3.0 i V6	01/91-10/93	G6AT	2972	25.4x149				SK-1308	BTK	
1.8 i	09/88-10/93	4G62	1796					0-N183	TB [TE]	
2.0 i	09/88-10/93	G4CP, G4CP-U	1997					0-N183	TB [TE]	
2.0 i	01/91-10/93	G4CP-U	1997					0-N059	TB [TE]	
2.0 i 16V	01/91-10/93	G4CP-D	1997					0-N054	TB [TE]	
2.0 i 16V	01/91-10/93	G4CP-D	1997					0-N055	TB [DG]	
2.0 i 16V	01/91-10/93	G4CP-D	1997					0-N179	TB [TE]	
2.0 i 16V	01/91-10/93	G4CP-D	1997					0-N1971	TB [BT]	
2.4 i	09/88-08/91	G4CS	2351					0-N183	TB [TE]	
3.0 i V6	01/91-10/93	G6AT	2972					0-N064	TB [TE]	
3.0 i V6	01/91-10/93	G6AT	2972					0-N1521	VB [DG]	
SONATA III (Y-3)										
1.8 i	05/93-06/98	G4CM	1796	24x122; 12.7x55; → 10/1995				SK-1312	BTK	
2.0 i	06/94-08/96	G4CP	1997	24x122; 12.7x55; → 10/1995				SK-1312	BTK	
2.0 i	08/96-06/98	G4EP	1997	19x122				SK-1240S	BTK	
2.0 i 16V	05/93-06/98	G4CP-D	1997	29x153; 12.7x65; → 02/1996				SK-1555	BTK	
2.0 i 16V	05/93-06/98	G4CP-D	1997	12.7x65; → 02/1996				SK-1649	BTK	
2.0 i 16V	06/96-06/98	G4CP-DM	1997	29x153; 12.7x65; Nockenwelle: DOHC				SK-1555	BTK	
3.0 i V6	05/93-06/98	G6AT	2972	25.4x149				SK-1308	BTK	
1.8 GLS	07/96-05/98	G4DM	1795	→ 04/1998				0-N1127	TB [TE]	
1.8 GLS	07/96-05/98	G4DM	1795					0-N183	TB [TE]	
1.8 i	05/93-06/98	G4CM	1796	03/1996 → 04/1998				0-N1127	TB [TE]	
1.8 i	05/93-06/98	G4CM	1796					0-N183	TB [TE]	
2.0 i	06/94-08/96	G4CP	1997					0-N063	TB [TE]	
2.0 i	06/94-08/96	G4CP	1997	03/1996 →				0-N1127	TB [TE]	
2.0 i	06/94-08/96	G4CP	1997					0-N186	TB [TE]	
2.0 i	08/96-06/98	G4EP	1997					0-N059	TB [TE]	
2.0 i	08/96-06/98	G4EP	1997					0-N183	TB [TE]	
2.0 i 16V	05/93-06/98	G4CP-D, G4CP-DM	1997					0-N054	TB [TE]	
2.0 i 16V	05/93-06/98	G4CP-D, G4CP-DM	1997					0-N055	TB [DG]	
2.0 i 16V	05/93-06/98	G4CP-D	1997	03/1996 → 04/1998				0-N1127	TB [TE]	
2.0 i 16V	05/93-06/98	G4CP-D	1997					0-N179	TB [TE]	
2.0 i 16V	05/93-06/98	G4CP-D, G4CP-DM	1997					0-N1971	TB [BT]	
2.0 i, 2.0 i 16V	06/96-06/98	G4CP-DM, G4EP	1997	→ 04/1998				0-N1127	TB [TE]	
3.0 i V6	05/93-06/98	G6AT	2972					0-N064	TB [TE]	

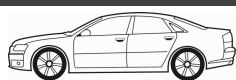

CM³



Art. Nr.



SONATA III (Y-3)							
3.0 i V6	05/93-06/98	G6AT	2972			0-N1521	VB [DG]
SONATA IV (EF)							
2.0 16V	06/98-11/04	G4CP, G4JP-EG, G4JP-G	1997	29x173; 12.7x65		SK-1653	BTK
2.0 16V	06/98-11/04	G4CP, G4JP-EG, G4JP-G	1997	12.7x65; 29x173; mit Spanndämpfer, Spannrolle		SK-1746	BTK
2.4 16V	03/98-10/01	G4BS	2351	19x123		SK-1237S	BTK
2.5 V6 24V	06/98-10/01	G6BV-G	2493	32x207; 11/1999 →		SK-1669	BTK
2.5 V6 24V	06/98-10/01	G6BV-G	2493	32x207		SK-1669AQ1	BTKW
2.5 V6 24V	06/98-10/01	G6BV-G	2493	32x207; mit Spanndämpfer, Spannrolle		SK-1749	BTK
2.7 i V6, 2.7 V6	10/01-05/05	G6BA, G6BA-G, G6BA-Y	2656	32x207		SK-1669AQ1	BTKW
2.7 V6	10/01-11/04	G6BA, G6BA-G	2656	32x207		SK-1669	BTK
2.7 V6	10/01-11/04	G6BA-G	2656	32x207; mit Spanndämpfer, Spannrolle		SK-1749	BTK
2.0 16V	06/98-11/04	G4CP, G4JP-EG, G4JP-G	1997			0-N055	TB [DG]
2.0 16V	06/98-10/01	G4JP-G	1997	01/1999 →		0-N1127	TB [TE]
2.0 16V	06/98-11/04	G4CP, G4JP-EG, G4JP-G	1997			0-N1498	TB [TE]
2.0 16V	10/01-11/04	G4CP, G4JP-EG	1997			0-N1127	TB [TE]
2.0 CRDi Dynamic	10/01-11/04	D4EA	1991			0-N1499	TB [BT] S
2.0 CRDi Dynamic	10/01-11/04	D4EA	1991			0-N1500	TB [DG]
2.2 CRDi	06/02-11/04	D4EB	2188			0-N1499	TB [BT] S
2.2 CRDi	06/02-11/04	D4EB	2188			0-N1500	TB [DG]
2.4 16V	03/98-10/01	G4BS	2351			0-N055	TB [DG]
2.4 16V	03/98-10/01	G4BS	2351	01/1999 →		0-N1127	TB [TE]
2.4 16V	03/98-10/01	G4BS	2351			0-N1498	TB [TE]
2.5 V6 24V	06/98-10/01	G6BV-G	2493			0-N1576	TB [TE]
2.5 V6 24V	06/98-10/01	G6BV-G	2493			0-N1577	TB [DG]
2.5 V6 24V	06/98-10/01	G6BV-G	2493	01/1999 → 04/2001; Spannrollenbetätigung: hydraulisch		0-N2428	TB [VD]
2.7 V6	10/01-11/04	G6BA-G	2656			0-N1576	TB [TE]
2.7 V6	10/01-11/04	G6BA-G	2656			0-N1577	TB [DG]
2.0 16V	06/98-10/01	G4JP-G	1997	01/1999 →		0-N1583	TB [BT]
2.0 16V	10/01-11/04	G4CP, G4JP-EG	1997			0-N1583	TB [BT]
2.0 CRDi Dynamic	10/01-11/04	D4EA	1991			0-N1547	VB [DG]
2.0 CRDi Dynamic	10/01-11/04	D4EA	1991	☞		0-N1814	VB [DG]
2.0 CRDi Dynamic	10/01-11/04	D4EA	1991			0-N1815	VB [BT] S
2.2 CRDi	06/02-11/04	D4EB	2188			0-N1547	VB [DG]
2.2 CRDi	06/02-11/04	D4EB	2188	☞		0-N1814	VB [DG]
2.2 CRDi	06/02-11/04	D4EB	2188			0-N1815	VB [BT] S
2.4 16V	03/98-10/01	G4BS	2351	01/1999 → 04/2001		0-N1583	TB [BT]
2.5 V6 24V	06/98-10/01	G6BV-G	2493			0-N1677	VB [BT] S
2.5 V6 24V	06/98-10/01	G6BV-G	2493			0-N1678	VB [DG]
2.7 i V6, 2.7 V6	10/01-05/05	G6BA, G6BA-G, G6BA-Y	2656			0-N1677	VB [BT] S
2.7 i V6, 2.7 V6	10/01-05/05	G6BA, G6BA-G, G6BA-Y	2656			0-N1678	VB [DG]
SONATA V (NF)							
2.0 CRDi	02/06-12/10	D4EA	1991	28x123		SK-1654	BTK
2.0 CRDi	02/06-12/10	D4EA	1991	28x123		SK-1654AQ2	BTKW
2.0 CRDi	02/06-12/10	D4EA	1991			0-N1499	TB [BT] S
2.0 CRDi	02/06-12/10	D4EA	1991			0-N1500	TB [DG]
2.0 CRDi	02/06-12/10	D4EA	1991			0-N1547	VB [DG]
2.0 CRDi	02/06-12/10	D4EA	1991	→ 11/2010; ☞		0-N1814	VB [DG]
2.0 CRDi	02/06-12/10	D4EA	1991			0-N1815	VB [BT] S
2.0 GLSi, 2.0 VVTi GLS	05/05-12/10	G4KA, G4KD	1998			0-N2021	VB [DG]
2.0 VVTi GLS	05/05-12/10	G4KA, G4KD	1998			0-N2108	VB [BT] S
2.4	01/05-12/10	G4KC, G4KE	2359			0-N2021	VB [DG]
2.4	01/05-12/10	G4KC, G4KE	2359			0-N2108	VB [BT] S
3.3	01/05-12/10	G6DB	3342			0-N1990	VB [DG]
3.3	01/05-12/10	G6DB	3342			0-N2250	VB [BT] S
SONATA VI (YF)							
2.0	01/09-	G4KD	1998			0-N2108	VB [BT] S
2.0 Hybrid	09/14-	G4NA	1999			0-N2021	VB [DG]
2.0, 2.0 i	01/09-	G4KD	1998			0-N2021	VB [DG]
2.4	01/09-	G4KC	2359			0-N2021	VB [DG]
2.4	01/09-	G4KC	2359			0-N2108	VB [BT] S
SONATA VII (LF)							
2.4	09/14-	G4KJ	2359			0-N2021	VB [DG]

CM³

Art. Nr.



ohne Halter

TERRACAN (HP)

2.5 D	06/01-10/03	D4BH	2476	25.4x163; 19x99	SK-1306	BTK
2.5 D	06/01-10/03	D4BH	2477	25.4x163; 19x99	SK-1306	BTK
2.9 CRDi, 2.9 CRDi 4WD	11/01-12/06	J3	2902	30x152	SK-1716	BTK
3.5 i V6 4WD	12/01-12/06	G6CU	3497	32x259; 04/2002 → 09/2003	SK-1718	BTK
3.5 i V6 4WD	12/01-12/06	G6CU	3497	32x259; 10/2002 →	SK-1718	BTK
2.5 D	06/01-10/03	D4BH	2477		0-N061	TB [TE]
2.5 D	06/01-10/03	D4BH	2477		0-N184	TB [TE]
2.5 D, 2.5 TD	06/01-12/06	D4BH	2476		0-N061	TB [TE]
2.5 D, 2.5 TD	06/01-12/06	D4BH	2476		0-N184	TB [TE]
2.9 CRDi, 2.9 CRDi 4WD	11/01-12/06	J3	2902		0-N1375	TB [DG]
2.9 CRDi, 2.9 CRDi 4WD	11/01-12/06	J3	2902		0-N1376	TB [DG]
2.9 CRDi, 2.9 CRDi 4WD	11/01-12/06	J3	2902		0-N1550	TB [DG]
2.9 CRDi, 2.9 CRDi 4WD	11/01-12/06	J3	2902		0-N1760	TB [TE]
3.5 i V6 4WD	12/01-12/06	G6CU	3497		0-N185	TB [TE]
3.5 i V6 4WD	12/01-12/06	G6CU	3497		0-N189	TB [DG]
2.9 CRDi 4WD	12/01-12/06	J3	2902		0-N1389	VB [DG]
2.9 CRDi 4WD	12/01-12/06	J3	2902		0-N1467S	VB [TE]
3.5 i V6 4WD	12/01-12/06	G6CU	3497		0-N1521	VB [DG]

TIBURON Coupe

2.0 CVVT	10/06-12/08	G4GC	1975	25.4x113	SK-1684	BTK
1.6 CVVT	10/06-12/08	G4ED-G	1599		0-N1370	TB [DG]
1.6 CVVT	10/06-12/08	G4ED-G	1599		0-N975	TB [TE]
2.0 CVVT	10/06-12/08	G4GC	1975		0-N1374	TB [DG]
2.0 CVVT	10/06-12/08	G4GC	1975		0-N1619	TB [TE]
1.6 CVVT	10/06-12/08	G4ED-G	1599		0-N1854	VB [BT]

TIBURON [USA] Coupe

2.7	01/03-12/06		2656	32x207	SK-1669AQ1	BTKW
2.7	01/03-12/06		2656		0-N1678	VB [DG]

TRAJET (FO)

2.0	03/00-07/08	G4JP-G	1997	29x173; 12.7x65	SK-1653	BTK
2.0	03/00-07/08	G4JP-G	1997	12.7x65; 29x173; mit Spanndämpfer, Spannrolle	SK-1746	BTK
2.0	11/03-07/08	G4GC	1975	29x173; 12.7x65	SK-1653	BTK
2.0	11/03-07/08	G4GC, G4GC-G	1975	12.7x65; 29x173; → 01/2004; mit Spanndämpfer, Spannrolle	SK-1746	BTK
2.0	01/04-07/08	G4GC-G	1975	25.4x113	SK-1651	BTK
2.0	01/04-07/08	G4GC-G	1975	29x173; 12.7x65; → 02/2004	SK-1653	BTK
2.0	01/04-07/08	G4GC-G	1975	25x113; 11/2006 →	SK-1656	BTK
2.0	01/04-07/08	G4GC-G	1975	25.4x113; 05/2006 →	SK-1684	BTK
2.0 CRDi	04/01-07/08	D4EA	1991	28x123	SK-1654	BTK
2.0 CRDi	04/01-07/08	D4EA	1991	28x123; → 01/2006	SK-1654AQ1	BTKW
2.0 CRDi	04/01-07/08	D4EA	1991	28x123; 01/2006 →	SK-1654AQ2	BTKW
2.7 V6	09/00-07/08	G6BA-G	2656	32x207; Nockenwelle: DOHC; → 01/2004	SK-1669	BTK
2.7 V6	09/00-07/08	G6BA-G	2656	32x207; → 06/2007	SK-1669AQ1	BTKW
2.0	03/00-07/08	G4JP-G	1997		0-N055	TB [DG]
2.0	03/00-07/08	G4JP-G	1997	→ 02/2004	0-N1127	TB [TE]
2.0	03/00-07/08	G4JP-G	1997		0-N1498	TB [TE]
2.0	11/03-07/08	G4GC, G4GC-G	1975	→ 02/2004	0-N1127	TB [TE]
2.0	11/03-07/08	G4GC, G4GC-G	1975		0-N1374	TB [DG]
2.0	11/03-07/08	G4GC, G4GC-G	1975		0-N1561	TB [TE]
2.0	11/03-07/08	G4GC, G4GC-G	1975	05/2006 →	0-N1619	TB [TE]
2.0 CRDi	04/01-07/08	D4EA	1991		0-N1499	TB [BT] S
2.0 CRDi	04/01-07/08	D4EA	1991		0-N1500	TB [DG]
2.7 V6	09/00-07/08	G6BA-G	2656		0-N1576	TB [TE]
2.7 V6	09/00-07/08	G6BA-G	2656		0-N1577	TB [DG]
2.7 V6	09/00-07/08	G6BA-G	2656	→ 06/2007; Spannrollenbetätigung: hydraulisch	0-N2428	TB [VD]
2.0	03/00-07/08	G4JP-G	1997	→ 02/2004	0-N1583	TB [BT]
2.0	03/00-07/08	G4JP-G	1997		0-N1854	VB [BT]
2.0	11/03-07/08	G4GC, G4GC-G	1975	→ 02/2004	0-N1583	TB [BT]
2.0	11/03-07/08	G4GC, G4GC-G	1975		0-N1854	VB [BT]
2.0 CRDi	04/01-07/08	D4EA	1991		0-N1547	VB [DG]
2.0 CRDi	04/01-07/08	D4EA	1991	→ 06/2007; ✖	0-N1814	VB [DG]
2.0 CRDi	04/01-07/08	D4EA	1991		0-N1815	VB [BT] S
2.0 CRDi	08/05-07/08	D4EA	1991	✖	0-N1814	VB [DG]



CM³



Art. Nr.



ohne Halter

TRAJET (FO)							
2.7 V6	09/00-07/08	G6BA-G	2656			0-N1677	VB [BT] S
2.7 V6	09/00-07/08	G6BA-G	2656			0-N1678	VB [DG]
TUCSON (JM)							
2.0 CRDi, 2.0 CRDi Allrad	08/04-03/10	D4EA, D4EA-F, D4EA-V, D4EA-V	1991	28x123		SK-1654	BTK
2.0 CRDi, 2.0 CRDi Allrad	08/04-03/10	D4EA	1991	28x123; → 01/2006		SK-1654AQ1	BTKW
2.0 CRDi, 2.0 CRDi Allrad	08/04-03/10	D4EA	1991	28x123; 01/2006 →		SK-1654AQ2	BTKW
2.0 CRDi, 2.0 CRDi Allrad	01/06-03/10	D4EA, D4EA-F, D4EA-V, D4EA-V	1991	28x123		SK-1654AQ2	BTKW
2.0, 2.0 Allrad	08/04-03/10	G4GC	1975	25.4x113		SK-1651	BTK
2.0, 2.0 Allrad	08/04-03/10	G4GC	1975	25x113; → 05/2006		SK-1656	BTK
2.0, 2.0 Allrad	08/04-03/10	G4GC	1975	25.4x113; 05/2006 →		SK-1684	BTK
2.7 Allrad	08/04-03/10	G6BA-G	2656	32x207; Nockenwelle: DOHC		SK-1669	BTK
2.7 Allrad	08/04-03/10	G6BA-G	2656	32x207; → 12/2006		SK-1669AQ1	BTKW
2.7 Allrad	08/04-03/10	G6BA-G	2656	32x207; mit Spanndämpfer, Spannrolle		SK-1749	BTK
2.0 CRDi, 2.0 CRDi Allrad	08/04-03/10	D4EA, D4EA-F, D4EA-V, D4EA-V	1991			0-N1499	TB [BT] S
2.0 CRDi, 2.0 CRDi Allrad	08/04-03/10	D4EA, D4EA-F, D4EA-V, D4EA-V	1991			0-N1500	TB [DG]
2.0, 2.0 Allrad	08/04-03/10	G4GC	1975			0-N1374	TB [DG]
2.0, 2.0 Allrad	08/04-03/10	G4GC	1975	→ 05/2006		0-N1561	TB [TE]
2.0, 2.0 Allrad	08/04-03/10	G4GC	1975	05/2006 →		0-N1619	TB [TE]
2.7 Allrad	08/04-03/10	G6BA-G	2656			0-N1576	TB [TE]
2.7 Allrad	08/04-03/10	G6BA-G	2656			0-N1577	TB [DG]
2.7 Allrad	08/04-03/10	G6BA-G	2656	Spannrollenbetätigung: hydraulisch		0-N2428	TB [VD]
2.0 CRDi, 2.0 CRDi Allrad	08/04-03/10	D4EA, D4EA-F, D4EA-V, D4EA-V	1991			0-N1547	VB [DG]
2.0 CRDi, 2.0 CRDi Allrad	08/04-03/10	D4EA, D4EA-F, D4EA-V, D4EA-V	1991	✳		0-N1814	VB [DG]
2.0 CRDi, 2.0 CRDi Allrad	08/04-03/10	D4EA, D4EA-F, D4EA-V, D4EA-V	1991			0-N1815	VB [BT] S
2.0, 2.0 Allrad	08/04-03/10	G4GC	1975			0-N1854	VB [BT]
2.7 Allrad	08/04-03/10	G6BA-G	2656			0-N1677	VB [BT] S
2.7 Allrad	08/04-03/10	G6BA-G	2656			0-N1678	VB [DG]
TUCSON (TLE)							
1.7 CRDI	06/15-	D4FD	1685	für Fahrzeuge mit Start-Stopp-Funktion		0-N2214	VB [BT] S
1.7 CRDI	06/15-	D4FD	1685			0-N2429	VB [DG]
VELOSTER (FS)							
1.6, 1.6 GDI, 1.6 MPI, 1.6 T-GDI	03/11-	G4FC, G4FD, G4FG, G4FG, G4FJ	1591			0-N1987	VB [DG]
XG (XG)							
25	12/98-12/05	G6AV	2493	32x207		SK-1669	BTK
25	12/98-12/05	G6AV	2493	32x207		SK-1669AQ1	BTKW
25	12/98-12/05	G6AV	2493	32x207; mit Spanndämpfer, Spannrolle		SK-1749	BTK
25	12/98-12/05	G6AV	2493	32x207; mit Spanndämpfer, Spannrolle; Baumuster: Grandeur		SK-1749	BTK
350	10/02-12/05	G6CU	3497	32x259; → 12/2005		SK-1718	BTK
25	12/98-12/05	G6AV	2493			0-N1576	TB [TE]
25	12/98-12/05	G6AV	2493			0-N1577	TB [DG]
25	12/98-12/05	G6AV	2493	→ 11/2005; Spannrollenbetätigung: hydraulisch		0-N2428	TB [VD]
3.0	09/99-09/03	G6CT-G	2972			0-N185	TB [TE]
3.0, 30/300	12/98-12/05	G6CT, G6CT-G	2972			0-N189	TB [DG]
30/300	12/98-12/05	G6CT-G	2972			0-N185	TB [TE]
350	10/02-12/05	G6CU	3497			0-N185	TB [TE]
350	10/02-12/05	G6CU	3497			0-N189	TB [DG]
25	12/98-12/05	G6AV	2493			0-N1677	VB [BT] S
25	12/98-12/05	G6AV	2493			0-N1678	VB [DG]



CM³



Art. Nr.



ohne Halter

ACCENT

1.4	02/06-	G4EE	1399	22x105		SK-1634	BTK	
1.6	02/06-	G4ED	1599	22x105		SK-1634	BTK	
1.4	02/06-	G4EE	1399			0-N1370	TB [DG]	
1.4	02/06-	G4EE	1399			0-N975	TB [TE]	
1.6	02/06-	G4ED	1599			0-N1370	TB [DG]	
1.6	02/06-	G4ED	1599			0-N975	TB [TE]	

ELANTRA Stufenheck

1.6	12/03-	G4ED-G, G4GA	1599	22x105; 04/2006 →		SK-1634	BTK	
1.6	12/03-	G4ED-G, G4GA	1599			0-N1374	TB [DG]	
1.8	12/03-	G4GB	1795			0-N1374	TB [DG]	

SONATA (EF)

2.0	12/02-07/07	14GC, G4GC	1975			0-N1374	TB [DG]	
2.7	12/02-07/07	G6BA	2656			0-N1374	TB [DG]	
2.7	12/02-07/07	G6BA	2656			0-N1678	VB [DG]	

TUCSON Geländewagen geschlossen

2.0	05/05-	G4GC	1975			0-N1374	TB [DG]	
2.7 AWD	05/05-	G6BA	2656			0-N1678	VB [DG]	



CM³



Art. Nr.



ohne Halter

TERRACAN Geländewagen geschlossen

3.5 AWD	03/03-12/08	G6CU	3497	32x259; → 12/2005	SK-1718	BTK
---------	-------------	------	------	-------------------	---------	-----



OPTIMAL®

INFINITI

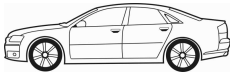

CM³



Art. Nr.



ohne Halter

FX							
30d	04/10-	V9X	2993			0-N2085	VB [BT] S
J30							
3.0	01/92-12/97	VG30DE	2960	01/1995 →		0-N024	TB [TE]
I30							
3.0	01/97-	VQ30DE	2988			0-N024	TB [TE]
M (Y51)							
30d	03/10-	V9X	2993			0-N2085	VB [BT] S
QX4							
3.3	01/97-	VG33E	3275			0-N024	TB [TE]

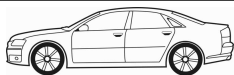

CM³



Art. Nr.



ohne Halter

ELBA (146)

1.4 i.e.	09/94-12/96	146 C5.000, 146 D5.000	1372	15x138	SK-1031	BTK	
1.5 i.e.	08/92-09/94	149 C1.000	1498	19.05x118	SK-1138	BTK	
1.6 i.e.	09/94-12/96	146 C6.000, 146 D6.000	1580	15x138	SK-1031	BTK	
1.7 D	08/91-12/96	146 B2.000	1697	22x168; 02/1992 →	SK-1032	BTK	



CM³



Art. Nr.



ohne Halter

SANTA FE (CM)

2.2 CRDi, 2.2 CRDi AWD	09/06-	D4EB	2188	28x123	SK-1654	BTK	
2.2 CRDi, 2.2 CRDi AWD	09/06-	D4EB	2188	28x123	SK-1654AQ2	BTKW	
2.7, 2.7 AWD	09/06-	G6EA	2656	32x219	SK-1739	BTK	
2.7, 2.7 AWD	09/06-	G6EA	2656	32x219; mit Spanndämpfer, Spannrolle	SK-1740	BTK	
2.2 CRDi, 2.2 CRDi AWD	09/06-	D4EB	2188		0-N1499	TB [BT]	S

CM³

Art. Nr.



ohne Halter

ASCENDER							
4.2	03/03-	LL8	4157			0-N1685	VB [DG]
CAMPO (KB)							
2.5 D , 2.5 D 4WD	01/83-12/90	4JA1	2499	32x119		SK-1260	BTK
2.2 D , 2.2 D 4WD	01/83-12/90	C223	2238			0-N048	TB [TE]
2.5 D , 2.5 D 4WD	01/83-12/90	4JA1	2499			0-N049	TB [TE]
2.5 D , 2.5 D 4WD	01/83-12/90	4JA1	2499			0-N050	TB [DG]
D-MAX (8DH)							
3.5 V6 24V 4x4	05/02-	6VE1	3494			0-N1765	TB [BT] S
FARGO Bus							
1.8	01/83-12/86	4ZB1	1817			0-N042	TB [TE]
2.0	01/86-12/88	4ZC1	1994			0-N042	TB [TE]
GEMINI (JT)							
1.5 D, 1.5 TD	02/88-12/90	4EC1, 4EC1T	1488	25x136; mit Zubehör		SK-1054	BTK
1.5 D, 1.5 TD	02/88-12/90	4EC1, 4EC1T	1488			0-N878	TB [DG]
1.5 D, 1.5 TD	02/88-12/90	4EC1, 4EC1T	1488			0-N879	TB [TE]
GEMINI Stufenheck (JT)							
1.5 D, 1.5 TD	02/88-12/89	4EC1, 4EC1T	1488	25x136; mit Zubehör		SK-1054	BTK
1.5 D, 1.5 TD	02/88-12/89	4EC1, 4EC1T	1488			0-N878	TB [DG]
1.5 D, 1.5 TD	02/88-12/89	4EC1, 4EC1T	1488			0-N879	TB [TE]
MIDI Bus (94000, 98000)							
2.0 , 2.0 4WD	01/89-	4ZC1	1995			0-N042	TB [TE]
2.0 TD	01/89-	4FC1T	1995			0-N046	TB [DG]
2.0 TD	01/89-	4FC1T	1995			0-N047	TB [TE]
2.2 D , 2.2 D 4WD	01/89-	4FD1	2189			0-N046	TB [DG]
2.2 D , 2.2 D 4WD	01/89-	4FD1	2189			0-N047	TB [TE]
2.4 D	01/94-	4FG1T	2380			0-N046	TB [DG]
2.4 D	01/94-	4FG1T	2380			0-N047	TB [TE]
MIDI Kasten (98000N)							
2.0, 2.0 4WD	06/88-	4ZC1	1995			0-N042	TB [TE]
2.2 D, 2.2 D 4WD	09/88-	4FD1	2189			0-N046	TB [DG]
2.2 D, 2.2 D 4WD	09/88-	4FD1	2189			0-N047	TB [TE]
2.4 TD	02/94-	4FG1T	2380			0-N046	TB [DG]
2.4 TD	02/94-	4FG1T	2380			0-N047	TB [TE]
MIDI Van (94000, 98000)							
2.0 , 2.0 4WD	01/89-	4ZC1	1995			0-N042	TB [TE]
2.0 TD	01/89-	4FC1T	1995			0-N046	TB [DG]
2.0 TD	01/89-	4FC1T	1995			0-N047	TB [TE]
2.2 D , 2.2 D 4WD	01/89-	4FD1	2189			0-N046	TB [DG]
2.2 D , 2.2 D 4WD	01/89-	4FD1	2189			0-N047	TB [TE]
2.4 TD	01/94-	4FG1T	2380			0-N046	TB [DG]
2.4 TD	01/94-	4FG1T	2380			0-N047	TB [TE]
PIAZZA (JR_)							
2.0 Turbo	06/85-12/90	4ZC1-T	1995			0-N042	TB [TE]
2.0 Turbo	09/85-08/90	4ZC1-T	1994			0-N042	TB [TE]
TROOPER (UBS)							
2.8 TD	10/87-12/91	4JB1T	2771	32x119		SK-1260	BTK
2.8 TD	10/88-12/91	4JB1-TC	2772	32x119		SK-1260	BTK
2.8 TD	10/87-12/91	4JB1T	2771			0-N049	TB [TE]
2.8 TD	10/87-12/91	4JB1T	2771			0-N050	TB [DG]
2.8 TD	10/88-12/91	4JB1-TC	2772			0-N049	TB [TE]
2.8 TD	10/88-12/91	4JB1-TC	2772			0-N050	TB [DG]
TROOPER Soft Top (UBS)							
2.2 TD	03/84-12/91	C223T	2238			0-N048	TB [TE]
2.3	11/85-12/91	4ZD1	2254			0-N042	TB [TE]
2.6 i	10/87-12/91	4ZE1	2559			0-N045	TB [TE]
TROOPER (UB)							
3.1 TD	08/91-07/98	4JG2 T	3059	32x119		SK-1260	BTK
3.2	08/91-07/98	6VD1	3165			0-N1768	TB [BT]
3.2	08/91-07/98	6VD1	3165			0-N2167	TB [DG]



OPTIMAL®

ISUZU



CM³



Art. Nr.



ohne Halter

TROOPER Soft Top (UB)

3.1 TD	08/91-07/98	4JG2 T	3059	32x119	SK-1260	BTK	
3.2	08/91-07/98	6VD1	3165		0-N1768	TB [BT]	
3.2	08/91-07/98	6VD1	3165		0-N2167	TB [DG]	

TROOPER

3.0 DTI	05/98-	4JX1	2999		0-N2168	TB [TE]	
3.5 V6 24V	04/00-	6VE1	3498		0-N1765	TB [BT]	S
3.5 V6 24V	04/00-	6VE1	3498		0-N1687	VB [DG]	
3.5 V6 24V	04/00-	6VE1	3498		0-N1689	VB [DG]	

TROOPER Soft Top

3.0 DTI	04/00-	4JX1T	2999		0-N2168	TB [TE]	
3.5 V6 24V	04/00-	6VE1	3494		0-N1765	TB [BT]	S
3.5 V6 24V	04/00-	6VE1	3494		0-N1687	VB [DG]	
3.5 V6 24V	04/00-	6VE1	3494		0-N1689	VB [DG]	

WIZARD (_U_)

3.0 TD Allrad	06/98-08/02	4JX1-TC	2999		0-N2168	TB [TE]	
---------------	-------------	---------	------	--	----------------	---------	--



CM³



Art. Nr.



ohne Halter

DAILY I Kasten/Kombi							
30-8, 35-8, 40-8 V	01/78-12/89	8140.61.200	2445	30x152		SK-1657	BTK
35-10	01/85-12/89	8140.21.200	2445	30x153; → 1307400		SK-1045	BTK
35-10	01/85-12/89	8140.21.200	2445	30x153; :1307401→		SK-1046	BTK
49-10 V	01/85-12/89	8140.21.200	2445	30x153		SK-1045	BTK
30-8, 35-10, 35-8, 40-10 V, 40-8 V, 45-10, 49-10 V	01/78-12/89	8140.21.200, 8140.27 S, 8140.61.200	2445			0-N1617	TB [BT]
30-8, 35-10, 35-8, 40-10 V, 40-8 V, 45-10, 49-10 V	01/78-12/89	8140.21.200, 8140.27 S, 8140.61.200	2445			0-N816	TB [DG]
30-8, 35-8, 40-8 V	01/78-12/89	8140.61.200	2445			0-N821	TB [DG]

DAILY I Pritsche/Fahrgestell							
30-8, 35-8, 40-8	01/78-12/89	8140.61.200	2445	30x152		SK-1657	BTK
35-10	01/85-12/89	8140.21.200	2445	30x153; → 1307400		SK-1045	BTK
35-10	01/85-12/89	8140.21.200	2445	30x153; :1307401→		SK-1046	BTK
45-10, 49-10	01/85-12/89	8140.21.200	2445	30x153		SK-1045	BTK
30-8, 35-10, 35-8, 40-10, 40-8, 45-10, 49-10	01/78-12/89	8140.21.200, 8140.27 S, 8140.61.200	2445			0-N1617	TB [BT]
30-8, 35-10, 35-8, 40-10, 40-8, 45-10, 49-10	01/78-12/89	8140.21.200, 8140.27 S, 8140.61.200	2445			0-N816	TB [DG]
30-8, 35-8, 40-8	01/78-12/89	8140.61.200	2445			0-N821	TB [DG]

DAILY II Bus							
A 40-10	01/91-12/96	8140.27.2720	2499	30x153; → 01/1996; :1307400→		SK-1046	BTK
A 40-10	09/96-05/99	8140.23.	2798	30x154; → 12/1999; Baumuster: 95719111, 95719131		SK-1153	BTK
A 40-10, A 40-12, A 45-10	05/96-05/99	8140.23., 8140.43.	2798	mit Spanndämpfer, Spannrolle		SK-1681	BTK
A 40-12	05/96-05/99	8140.43.	2798	30x154; → 12/1999; Baumuster: 95819311, 95819315		SK-1153	BTK
A 45-10	01/91-04/96	8140.27.2720	2499	30x153; :1307400→		SK-1046	BTK
A 45-10	05/96-05/99	8140.23.	2798	30x154; → 12/1999; Baumuster: 95739111, 95739131		SK-1153	BTK
A 45-12	06/90-04/96	8140.47.2711, 8140.47.2721	2499	30x153		SK-1046	BTK
A 45-12	05/96-05/99	8140.43.	2798	30x154; → 12/1999; Baumuster: 95839211, 95839231		SK-1153	BTK
A 45-12	05/96-05/99	8140.43.	2798	mit Spanndämpfer, Spannrolle; Baumuster: Daily A45. 12		SK-1681	BTK
A 45-12	05/96-05/99	8140.43.	2798	mit Spanndämpfer, Spannrolle; Baumuster: Daily A45. 12P		SK-1681	BTK
A 40-10, A 40-12, A 45-10, A 45-12	05/96-05/99	8140.23., 8140.43.	2798			0-N1617	TB [BT]
A 40-10, A 40-12, A 45-10, A 45-12	05/96-05/99	8140.23., 8140.43.	2798			0-N816	TB [DG]
A 40-10, A 45-10, A 45-12	06/90-12/96	8140.27.2720, 8140.47.2711, 8140.47.2721	2499			0-N1617	TB [BT]
A 40-10, A 45-10, A 45-12	06/90-12/96	8140.27.2720, 8140.47.2711, 8140.47.2721	2499			0-N816	TB [DG]

DAILY II Kasten/Kombi							
30-10, 30-10 C, 35-10, 35-12, 49-12 V, 59-12 V	02/95-05/99	8140.23., 8140.43.	2798	mit Spanndämpfer, Spannrolle		SK-1681	BTK
30-10, 30-10 C, 35-10, 40-10 4x4, 59-12 V	01/96-05/99	8140.23., 8140.43.	2798	30x154		SK-1153	BTK
30-8	01/89-08/98	8140.67F., 8140.67F.3710, 8140.67F.3711, 8140.67F.3713, 8140.67F.3721	2499	30x152		SK-1035	BTK
30-8, 30-8 V, 35-8	09/98-05/99	8140.63.	2798	30x152		SK-1035	BTK
30-8, 30-8 V, 35-8	09/98-05/99	8140.63.	2798	30x153		SK-1046	BTK
30-8, 35-10	01/89-08/98	8140.07.2700, 8140.07.2712, 8140.47R.2790	2499	30x153; 01/1990 →; :1307401→		SK-1046	BTK
30-8, 35-10, 35-8, 49-10 V	01/89-08/98	8140.07.2700, 8140.07.2712, 8140.27.2700, 8140.47R.2790, 8140.47R.2790	2499	30x153; → 1307400		SK-1045	BTK
30-8, 35-8	01/89-08/98	8140.67F	2499	30x152; :1307401→		SK-1035	BTK
30-8, 35-8	01/89-08/98	8140.07.2700, 8140.07.2712	2499	30x153; :1307401→		SK-1046	BTK
35-10	01/89-08/98	8140.47R	2499	30x153; 01/1990 →		SK-1046	BTK
35-12, 40-12 V, 49-12 V, 59-12 V	01/90-04/96	8140.47.2700, 8140.47.2700, 8140.47.2711, 8140.47S, 8140.47.2700, 8140.47S, 8140.47.2711, 8140.47.2721	2499	30x153		SK-1046	BTK
35-8, 40-10 V, 45-10 V	01/89-08/98	8140.07.2700, 8140.07.2712, 8140.27.2720	2499	30x153; :1307401→		SK-1046	BTK
49-10 V	01/89-04/96	8140.27.2700, 8140.47R.2790	2499	30x153; 01/1990 →; :1307401→; Baumuster: 13054204, 13054211		SK-1046	BTK
49-10 V	01/89-04/96	8140.27.2700, 8140.47R.2790	2499	:1307401→; mit Spanndämpfer, Spannrolle		SK-1679	BTK
49-12 V	05/96-05/99	8140.43.	2798	30x154; → 12/1999; Baumuster: 15154204, 15154211		SK-1153	BTK
30-10, 30-10 C, 30-8, 30-8 V, 35-10, 35-8, 40-10 4x4, 49-12 V, 59-12 V	01/96-05/99	8140.23., 8140.43., 8140.63.	2798			0-N1617	TB [BT]
30-10, 30-10 C, 30-8, 30-8 V, 35-10, 35-8, 40-10 4x4, 49-12 V, 59-12 V	01/96-05/99	8140.23., 8140.43., 8140.63.	2798			0-N816	TB [DG]



OPTIMAL®

IVECO



CM³



Art. Nr.



ohne Halter

DAILY II Kasten/Kombi

30-8	01/89-08/98	8140.67F., 8140.67F.3710, 8140.67F.3711, 8140.67F.3713, 8140.67F.3721	2499		0-N821	TB [DG]
30-8, 35-10, 35-12, 35-8, 40-10 V, 40-12 V, 45-10 V, 49-10 V, 49-12 V, 59-12 V	01/89-08/98	8140.07.2700, 8140.07.2712, 8140.27.2700, 8140.47R.2790, 8140.27.2720, 8140.47.2700, 8140.47.2711, 8140.47S, 8140.47.2700, 8140.47S, 8140.47.2711, 8140.47.2721, 8140.47R, 8140.47R.2790, 8140.67F., 8140.67F., 8140.67F.3701, 8140.67F.3710, 814	2499		0-N1617	TB [BT]
30-8, 35-10, 35-12, 35-8, 40-10 V, 40-12 V, 45-10 V, 49-10 V, 49-12 V, 59-12 V	01/89-08/98	8140.07.2700, 8140.07.2712, 8140.27.2700, 8140.47R.2790, 8140.27.2720, 8140.47.2700, 8140.47.2700, 8140.47.2711, 8140.47S, 8140.47.2700, 8140.47S, 8140.47.2711, 8140.47.2721, 8140.47R, 8140.47R.2790, 8140.67F., 8140.67F.3710, 8140.67F.3711, 8140.67F.3713,	2499		0-N816	TB [DG]
30-8, 35-8	01/89-08/98	8140.07.2700, 8140.07.2712	2499		0-N816	TB [DG]
30-8, 35-8	01/89-08/98	8140.67F	2499		0-N821	TB [DG]
30-8, 30-8 V, 35-8	09/98-05/99	8140.63.	2798		0-N144	VB [DG]

DAILY II Kipper

35-10 K, 35-12 K, 49-10 K, 49-12 K, 59-12 K	05/96-05/99	8140.23., 8140.43.	2798	mit Spanndämpfer, Spannrolle	SK-1681	BTK
35-10 K, 35-12 K, 59-12 K	05/96-05/99	8140.23., 8140.43.	2798	30x154	SK-1153	BTK
35-8 K	09/98-05/99	8140.63.	2798	30x152	SK-1035	BTK
35-8 K	09/98-05/99	8140.63.	2798	30x153	SK-1046	BTK
45-10, 49-12 K, 59-12 K	06/90-04/96	8140.27.2720, 8140.47.2700, 8140.47.2711, 8140.47.2711, 8140.47.2721	2499	30x153	SK-1046	BTK
49-10 K	01/89-04/96	8140.27.2700, 8140.47R.2790	2499	30x153; :→1307400	SK-1045	BTK
49-10 K	01/89-04/96	8140.27.2700, 8140.47R.2790	2499	30x153; 01/1990 →; :1307401→	SK-1046	BTK
49-10 K	01/89-04/96	8140.27.2700, 8140.47R.2790	2499	:1307401→; mit Spanndämpfer, Spannrolle	SK-1679	BTK
49-10 K	05/96-05/99	8140.23.	2798	30x154; → 12/1999; Baumuster: 15051204, 15051211	SK-1153	BTK
49-12 K	05/96-05/99	8140.43.	2798	30x154; → 12/1999; Baumuster: 15151204, 15151211	SK-1153	BTK
35-10 K, 35-12 K, 35-8 K, 49-10 K, 49-12 K, 59-12 K	05/96-05/99	8140.23., 8140.43., 8140.63.	2798		0-N1617	TB [BT]
35-10 K, 35-12 K, 35-8 K, 49-10 K, 49-12 K, 59-12 K	05/96-05/99	8140.23., 8140.43., 8140.63.	2798		0-N816	TB [DG]
45-10, 49-10 K, 49-12 K, 59-12 K	01/89-04/96	8140.27.2700, 8140.47R.2790, 8140.27.2720, 8140.47.2700, 8140.47.2711, 8140.47.2711, 8140.47.2721	2499		0-N1617	TB [BT]
45-10, 49-10 K, 49-12 K, 59-12 K	01/89-04/96	8140.27.2700, 8140.47R.2790, 8140.27.2720, 8140.47.2700, 8140.47.2711, 8140.47.2711, 8140.47.2721	2499		0-N816	TB [DG]
35-8 K	09/98-05/99	8140.63.	2798		0-N144	VB [DG]

DAILY II Pritsche/Fahrgestell

30-10, 35-10, 35-12, 40-10 W 4x4, 59-12	01/96-05/99	8140.23., 8140.43.	2798	30x154	SK-1153	BTK
30-10, 35-10, 35-12, 49-10, 49-12, 59-12	01/96-05/99	8140.23., 8140.43.	2798	mit Spanndämpfer, Spannrolle	SK-1681	BTK
30-8	01/92-08/98	8140.67F., 8140.67F.3710, 8140.67F.3711, 8140.67F.3713, 8140.67F.3721	2499	30x152	SK-1035	BTK
30-8	01/92-08/98	8140.07.2700	2499	30x153	SK-1046	BTK
30-8	01/92-08/98	814007.67F	2499	30x153; :1307401→	SK-1046	BTK
30-8, 35-10, 35-8, 49-10	01/89-08/98	8140.07.2700, 8140.07.2700, 8140.07.2712, 8140.27.2700, 8140.47R.2790, 8140.47R.2790, 8140.97.2781	2499	30x153; :→1307400	SK-1045	BTK
30-8, 35-8	01/89-08/98	8140.67F	2499	30x152; :1307401→	SK-1035	BTK
30-8, 35-8	09/98-05/99	8140.63.	2798	30x152	SK-1035	BTK
30-8, 35-8	09/98-05/99	8140.63.	2798	30x153	SK-1046	BTK
35-10	01/89-12/96	8140.47R	2499	30x153; 01/1990 →	SK-1046	BTK
35-10	01/89-12/96	8140.97.2781	2499	30x153; 01/1990 →; :1307401→	SK-1046	BTK
35-10, 35-8	01/89-08/98	8140.07.2700, 8140.07.2712, 8140.97.2781	2499	30x153; 01/1990 →; :1307401→	SK-1046	BTK
35-12, 40-12, 49-12, 59-12	01/90-04/96	8140.47.2700, 8140.47.2700, 8140.47.2711, 8140.47.2711, 8140.47.2721	2499	30x153	SK-1046	BTK
35-8	01/89-08/98	8140.07.2700, 8140.07.2712	2499	30x153; :1307401→	SK-1046	BTK
45-10	01/89-04/96	8140.27.2720	2499	30x153; :1307401→	SK-1046	BTK
49-10	01/89-04/96	8140.27.2700, 8140.47R.2790	2499	30x153; 01/1990 →; :1307401→;	SK-1046	BTK
49-10	01/89-04/96	8140.27.2700, 8140.47R.2790	2499	:1307401→; mit Spanndämpfer, Spannrolle	SK-1679	BTK

CM³

Art. Nr.



ohne Halter

DAILY II Pritsche/Fahrgestell							
49-10	05/96-05/99	8140.23.	2798	30x154; Baumuster: 15051204, 15051211	SK-1153	BTK	
49-12	05/96-05/99	8140.43.	2798	30x154; Baumuster: 15151204, 15151211	SK-1153	BTK	
30-10, 30-8, 35-10, 35-12, 35-8, 40-10 W 4x4, 49-10, 49-12, 59-12	01/96-05/99	8140.23., 8140.43., 8140.63.	2798		0-N1617	TB [BT]	
30-10, 30-8, 35-10, 35-12, 35-8, 40-10 W 4x4, 49-10, 49-12, 59-12	01/96-05/99	8140.23., 8140.43., 8140.63.	2798		0-N816	TB [DG]	
30-8	01/92-08/98	8140.07.2700	2499		0-N816	TB [DG]	
30-8	01/92-08/98	8140.67F., 8140.67F.3710, 8140.67F.3711, 8140.67F.3713, 8140.67F.3721	2499		0-N821	TB [DG]	
30-8, 35-10, 35-12, 35-8, 40-12, 45-10, 49- 10, 49-12, 59-12	01/89-08/98	8140.07.2700, 8140.07.2700, 8140.07.2712, 8140.27.2700, 8140.47R.2790, 8140.27.2720, 8140.47.2700, 8140.47.2700, 8140.47.2711, 8140.47.2711, 8140.47.2721, 8140.47R.2790, 8140.67F., 8140.67F., 8140.67F.3710, 8140.67F.3711, 8140.67F.3713, 8140.67F.3721, 814	2499		0-N1617	TB [BT]	
30-8, 35-10, 35-12, 35-8, 40-12, 45-10, 49- 10, 49-12, 59-12	01/89-08/98	8140.07.2700, 8140.07.2700, 8140.07.2712, 8140.27.2700, 8140.47R.2790, 8140.27.2720, 8140.47.2700, 8140.47.2700, 8140.47.2711, 8140.47.2711, 8140.47.2721, 8140.47R.2790, 8140.67F., 8140.67F.3710, 8140.67F.3711, 8140.67F.3713, 8140.67F.3721, 8140.97.2781	2499		0-N816	TB [DG]	
30-8, 35-8	01/89-08/98	8140.67F	2499		0-N821	TB [DG]	
35-8	01/89-08/98	8140.07.2700, 8140.07.2712	2499		0-N816	TB [DG]	
30-8, 35-8	09/98-05/99	8140.63.	2798		0-N144	VB [DG]	
DAILY III Bus							
35 S 12	01/03-05/06	F1AE0481B	2287	30x178	SK-1610AQ1	BTKW	
DAILY III Kasten/Kombi							
2.8 CNG, 35 S 11 V, 35 C 11 V	05/99-07/07	8140.43C, 8149.03	2798	mit Spanndämpfer, Spannrolle; Baumuster: Daily 35C11	SK-1681	BTK	
2.8 CNG, 35 S 11 V, 35 C 11 V	05/99-07/07	8140.43C, 8149.03	2798	mit Spanndämpfer, Spannrolle; Baumuster: Daily 35S11	SK-1681	BTK	
2.8 CNG, 35 S 11 V, 35 C 11 V	05/99-07/07	8140.43C, 8149.03	2798	mit Spanndämpfer, Spannrolle; Baumuster: Daily 35S11P	SK-1681	BTK	
2.8 CNG, 50 C 11	05/99-07/07	8140.43C, 8149.03	2798	mit Spanndämpfer, Spannrolle; Baumuster: Daily 50C11	SK-1681	BTK	
2.8 CNG, 50 C 11	05/99-07/07	8140.43C, 8149.03	2798	mit Spanndämpfer, Spannrolle; Baumuster: Daily 50C11P	SK-1681	BTK	
29 L 10 V, 29 L 12 V, 29 L 14, 35 S 10	09/02-07/07	F1AE0481A, F1AE0481B, F1AE0481M	2287	30x178	SK-1610AQ1	BTKW	
29 L 10 V, 29 L 12 V, 35 C 12 V, 35 S 12 V, 35 S 10	09/02-07/07	F1AE0481A, F1AE0481B	2287	30x178; 06/2006 →	SK-1610	BTK	
29 L 11 V	05/99-07/07	8140.43C	2798	mit Spanndämpfer, Spannrolle; Baumuster: Daily 29L11	SK-1681	BTK	
29 L 11 V	05/99-07/07	8140.43C	2798	mit Spanndämpfer, Spannrolle; Baumuster: Daily 29L11P	SK-1681	BTK	
29 L 11 V, 29 L 13, 29 L 9 V, 35 S 11 V, 35 C 11 V, 35 S 13 V, 35 C 13 V, 35 S 15 V, 35 C 15 V, 35 S 9 V, 35 C 9 V, 40 C 15, 50 C 11, 50 C 13, 50 C 15, 65 C 15	05/99-07/07	8140.43C, 8140.43N, 8140.43R, 8140.43S, 8140.63.	2798	30x152	SK-1035	BTK	
29 L 11 V, 35 S 11 V, 35 C 11 V, 50 C 11	05/99-07/07	8140.43C	2798	30x154; für OE: 99456477	SK-1153	BTK	
29 L 14, 35 C 14, 35 S 14	01/05-04/06	F1AE0481M	2287	30x178	SK-1610	BTK	
29 L 9 V	05/99-07/07	8140.63.	2798	30x153	SK-1046	BTK	
35 C 12 V, 35 S 12 V	09/02-07/07	F1AE0481B	2287	30x178; Baumuster: 35C12	SK-1610AQ1	BTKW	
35 C 12 V, 35 S 12 V	09/02-07/07	F1AE0481B	2287	30x178; Baumuster: Daily 35C12P	SK-1610AQ1	BTKW	
35 C 12 V, 35 S 12 V	09/02-07/07	F1AE0481B	2287	30x178; Baumuster: Daily 35S12	SK-1610AQ1	BTKW	
35 C 12 V, 35 S 12 V	09/02-07/07	F1AE0481B	2287	30x178; Baumuster: Daily 35S12P	SK-1610AQ1	BTKW	
35 C 14, 35 S 14	01/05-04/06	F1AE0481M	2287	30x178; Baumuster: Daily 35S14	SK-1610AQ1	BTKW	
35 C 14, 35 S 14	01/05-04/06	F1AE0481M	2287	30x178; Baumuster: Daily 35S14P	SK-1610AQ1	BTKW	
35 S 11 V, 35 C 11 V	05/99-07/07	8140.43C	2798	30x152; 07/1999 →; für OE: 99456476; mit Spanndämpfer, Spannrolle	SK-1680	BTK	
35 S 11 V, 35 C 11 V	05/99-07/07	8140.43C	2798	mit Spanndämpfer, Spannrolle; Baumuster: Daily 35C11P	SK-1681	BTK	
35 S 13 V, 35 C 13 V, 50 C 11	05/99-07/07	8140.43C, 8140.43S	2798	30x152; 07/1999 → 12/2006; mit Spanndämpfer, Spannrolle	SK-1680	BTK	
35 S 9 V	11/01-04/06	8140.43R	2798	30x153; ohne Spanndämpfer, Spannrolle	SK-1046	BTK	
35 S 9 V	11/01-04/06	8140.43R	2798	mit Spanndämpfer, Spannrolle	SK-1679	BTK	
35 S 9 V, 35 C 9 V	05/99-07/07	8140.63.	2798	30x153; → 12/2006	SK-1046	BTK	
35 S 9 V, 35 C 9 V	05/99-07/07	8140.63.	2798	→ 12/2006; mit Spanndämpfer, Spannrolle	SK-1679	BTK	
50 C 15, 65 C 15	01/01-04/06	8140.43N	2798	30x152; mit Spanndämpfer, Spannrolle	SK-1680	BTK	



OPTIMAL®

IVECO



CM³



Art. Nr.



DAILY III Kasten/Kombi								
29 L 10 V, 29 L 12 V, 29 L 14, 35 C 12 V, 35 S 12 V, 35 C 14, 35 S 14, 35 S 10, 40 C 14	09/02-07/07	F1AE0481A, F1AE0481B, F1AE0481M	2287			0-N1352	TB [DG]	
29 L 10 V, 29 L 12 V, 35 C 12 V, 35 S 12 V, 35 S 10	09/02-07/07	F1AE0481A, F1AE0481B	2287			0-N1351	TB [TE]	
29 L 11 V, 29 L 13, 29 L 9 V, 35 S 11 V, 35 C 11 V, 35 S 13 V, 35 C 13 V, 35 S 15 V, 35 C 15 V, 35 S 9 V, 35 C 9 V, 50 C 11, 50 C 13	05/99-07/07	8140.43C, 8140.43N, 8140.43S, 8140.63.	2798			0-N1617	TB [BT]	
29 L 11 V, 29 L 13, 29 L 9 V, 35 S 11 V, 35 C 11 V, 35 S 13 V, 35 C 13 V, 35 S 15 V, 35 C 15 V, 35 S 9 V, 35 C 9 V, 50 C 11, 50 C 13	05/99-07/07	8140.43C, 8140.43N, 8140.43S, 8140.63.	2798			0-N816	TB [DG]	
29 L 13, 35 S 13 V, 35 C 13 V, 35 S 15 V, 35 C 15 V, 50 C 13	05/99-07/07	8140.43N, 8140.43S	2798			0-N821	TB [DG]	
29 L 10 V, 29 L 12 V, 29 L 14, 35 C 12 V, 35 S 12 V, 35 C 14, 35 S 14, 35 S 10, 40 C 14	09/02-07/07	F1AE0481A, F1AE0481B, F1AE0481M	2287			0-N1483	VB [BT]	S
29 L 10 V, 29 L 12 V, 29 L 14, 35 C 12 V, 35 S 12 V, 35 C 14, 35 S 14, 35 S 10, 40 C 14	09/02-07/07	F1AE0481A, F1AE0481B, F1AE0481M	2287			0-N1806	VB [BT]	
29 L 10 V, 29 L 12 V, 35 C 12 V, 35 S 12 V, 35 S 10	09/02-07/07	F1AE0481A, F1AE0481B	2287			0-N1597	VB [DG]	
29 L 11 V, 29 L 13, 29 L 9 V, 35 S 11 V, 35 C 11 V, 35 S 13 V, 35 C 13 V, 35 S 15 V, 35 C 15 V, 35 S 9 V, 35 C 9 V, 35 C 9 V, 40 C 13, 40 C 15, 50 C 11, 50 C 13, 50 C 15, 65 C 15	05/99-07/07	8140.43C, 8140.43N, 8140.43R, 8140.43S, 8140.63.	2798			0-N144	VB [DG]	
29 L 11 V, 29 L 13, 29 L 9 V, 35 S 11 V, 35 C 11 V, 35 S 13 V, 35 C 13 V, 35 S 15 V, 35 C 15 V, 35 S 9 V, 35 C 9 V, 35 C 9 V, 40 C 13, 40 C 15, 50 C 11, 50 C 13, 50 C 15, 65 C 15	05/99-07/07	8140.43C, 8140.43N, 8140.43R, 8140.43S, 8140.63.	2798			0-N1480S	VB [TE]	
35 C 14, 35 C 17, 35 S 17, 40 C 14, 40 C 17, 40 S 17, 50 C 14, 50 C 17, 65 C 14, 65 C 17	09/04-04/06	F1CE0481A, F1CE0481B	2998	mit Anbaumaterial		0-N1711S	VB [TE]	
DAILY III Pritsche/Fahrgestell								
29 L 10, 29 L 12, 29 L 14	09/02-04/06	F1AE0481A, F1AE0481B, F1AE0481M	2287	30x178		SK-1610AQ1	BTKW	
29 L 10, 29 L 12, 29 L 14, 35 C 10 V, 35 S 10 V, 35 C 12, 35 S 12, 35 C 14, 35 S 14	09/02-04/06	F1AE0481A, F1AE0481B, F1AE0481M	2287	30x178		SK-1610	BTK	
29 L 11	05/99-04/06	8140.43C	2798	mit Spanndämpfer, Spannrolle; Baumuster: Daily 29L11		SK-1681	BTK	
29 L 11	05/99-04/06	8140.43C	2798	mit Spanndämpfer, Spannrolle; Baumuster: Daily 29L11P		SK-1681	BTK	
29 L 11, 29 L 13, 29 L 9, 35 C 15, 35 C 9, 35 S 9, 35 S 11, 35 C 11, 35 S 13, 35 C 13, 35 S 9, 35 C 9, 40 C 15, 50 C 11, 50 C 13, 50 C 15, 65 C 15	05/99-04/06	8140.43B, 8140.43C, 8140.43C, 8140.43N, 8140.43R, 8140.43S, 8140.63.	2798	30x152		SK-1035	BTK	
29 L 11, 35 S 11, 35 C 11	05/99-04/06	8140.43B, 8140.43C, 8140.43C	2798	30x154; für OE: 99456477		SK-1153	BTK	
29 L 9	05/99-04/06	8140.63.	2798	30x153		SK-1046	BTK	
35 C 10 V, 35 S 10 V	09/02-04/06	F1AE0481A	2287	30x178; Baumuster: 35C10		SK-1610AQ1	BTKW	
35 C 10 V, 35 S 10 V	09/02-04/06	F1AE0481A	2287	30x178; Baumuster: Daily 35S10		SK-1610AQ1	BTKW	
35 C 12, 35 S 12	09/02-04/06	F1AE0481B	2287	30x178; Baumuster: 35C12		SK-1610AQ1	BTKW	
35 C 12, 35 S 12	09/02-04/06	F1AE0481B	2287	30x178; Baumuster: Daily 35S12		SK-1610AQ1	BTKW	
35 C 14, 35 S 14	01/05-04/06	F1AE0481M	2287	30x178; Baumuster: Daily 35C14		SK-1610AQ1	BTKW	
35 C 14, 35 S 14	01/05-04/06	F1AE0481M	2287	30x178; Baumuster: Daily 35S14		SK-1610AQ1	BTKW	
35 C 14, 35 S 14	01/05-04/06	F1AE0481M	2287	30x178; Baumuster: Daily 35S14P		SK-1610AQ1	BTKW	
35 C 9, 35 S 9	11/01-04/06	8140.43R	2798	30x152; mit Spanndämpfer, Spannrolle		SK-1680	BTK	
35 S 11, 35 C 11	05/99-04/06	8140.43C	2798	mit Spanndämpfer, Spannrolle; Baumuster: Daily 35C11		SK-1681	BTK	
35 S 11, 35 C 11	05/99-04/06	8140.43C	2798	mit Spanndämpfer, Spannrolle; Baumuster: Daily 35C11P		SK-1681	BTK	
35 S 11, 35 C 11	05/99-04/06	8140.43C	2798	mit Spanndämpfer, Spannrolle; Baumuster: Daily 35S11		SK-1681	BTK	
35 S 11, 35 C 11	05/99-04/06	8140.43C	2798	mit Spanndämpfer, Spannrolle; Baumuster: Daily 35S11P		SK-1681	BTK	
35 S 13, 35 C 13, 50 C 11	05/99-04/06	8140.43C, 8140.43S	2798	30x152; 07/1999 → 12/2006; mit Spanndämpfer, Spannrolle		SK-1680	BTK	
35 S 9, 35 C 9	05/99-04/06	8140.63.	2798	30x153; → 12/2006		SK-1046	BTK	
35 S 9, 35 C 9	05/99-04/06	8140.63.	2798	→ 12/2006; mit Spanndämpfer, Spannrolle		SK-1679	BTK	
50 C 11	05/99-04/06	8140.43C	2798	30x154; → 12/2006; für OE: 99456477		SK-1153	BTK	
50 C 11	05/99-04/06	8140.43C	2798	mit Spanndämpfer, Spannrolle; Baumuster: Daily 50C11		SK-1681	BTK	

CM³

Art. Nr.



ohne Halter

DAILY III Pritsche/Fahrgestell							
50 C 11	05/99-04/06	8140.43C	2798	mit Spanndämpfer, Spannrolle; Baumuster: Daily 50C11P	SK-1681	BTK	
50 C 15, 65 C 15	01/01-04/06	8140.43N	2798	30x152; → 12/2006; mit Spanndämpfer, Spannrolle	SK-1680	BTK	
29 L 10, 29 L 12, 29 L 14, 35 C 10 V, 35 S 10 V, 35 C 12, 35 S 12	09/02-04/06	F1AE0481A, F1AE0481B, F1AE0481M	2287		0-N1351	TB [TE]	
29 L 10, 29 L 12, 29 L 14, 35 C 10 V, 35 S 10 V, 35 C 12, 35 S 12, 35 C 14, 35 S 14, 40 C 14	09/02-04/06	F1AE0481A, F1AE0481B, F1AE0481M	2287		0-N1352	TB [DG]	
29 L 11, 29 L 13, 29 L 9, 35 C 15, 35 S 11, 35 C 11, 35 S 13, 35 C 13, 35 S 9, 35 C 9, 50 C 11, 50 C 13, 50 C 15, 65 C 15	05/99-04/06	8140.43B, 8140.43C, 8140.43N, 8140.43S, 8140.63.	2798		0-N1617	TB [BT]	
29 L 11, 29 L 13, 29 L 9, 35 C 15, 35 S 11, 35 C 11, 35 S 13, 35 C 13, 35 S 9, 35 C 9, 50 C 11, 50 C 13, 50 C 15, 65 C 15	05/99-04/06	8140.43B, 8140.43C, 8140.43N, 8140.43S, 8140.63.	2798		0-N816	TB [DG]	
29 L 13, 35 C 15, 35 S 13, 35 C 13, 50 C 13, 50 C 15, 65 C 15	05/99-04/06	8140.43N, 8140.43S	2798		0-N821	TB [DG]	
29 L 10, 29 L 12, 29 L 14, 35 C 10 V, 35 S 10 V, 35 C 12, 35 S 12	09/02-04/06	F1AE0481A, F1AE0481B, F1AE0481M	2287		0-N1597	VB [DG]	
29 L 10, 29 L 12, 29 L 14, 35 C 10 V, 35 S 10 V, 35 C 12, 35 S 12, 35 C 14, 35 S 14, 40 C 14	09/02-04/06	F1AE0481A, F1AE0481B, F1AE0481M	2287		0-N1483	VB [BT]	S
29 L 10, 29 L 12, 29 L 14, 35 C 10 V, 35 S 10 V, 35 C 12, 35 S 12, 35 C 14, 35 S 14, 40 C 14	09/02-04/06	F1AE0481A, F1AE0481B, F1AE0481M	2287		0-N1806	VB [BT]	
29 L 11, 29 L 13, 29 L 9, 35 C 15, 35 C 9, 35 S 9, 35 S 11, 35 C 11, 35 S 13, 35 C 13, 35 S 9, 35 C 9, 40 C 13, 40 C 15, 50 C 11, 50 C 13, 50 C 15, 65 C 15	05/99-04/06	8140.43B, 8140.43C, 8140.43N, 8140.43R, 8140.43S, 8140.63.	2798		0-N144	VB [DG]	
29 L 11, 29 L 13, 29 L 9, 35 C 15, 35 C 9, 35 S 9, 35 S 11, 35 C 11, 35 S 13, 35 C 13, 35 S 9, 35 C 9, 40 C 13, 40 C 15, 50 C 11, 50 C 13, 50 C 15, 65 C 15	05/99-04/06	8140.43B, 8140.43C, 8140.43N, 8140.43R, 8140.43S, 8140.63.	2798		0-N1480S	VB [TE]	
35 C 14, 35 C 17, 35 S 17, 40 C 14, 40 C 17, 40 S 17, 50 C 14, 50 C 17, 65 C 14, 65 C 17	09/04-04/06	F1CE0481A, F1CE0481B	2998	mit Anbaumaterial	0-N1711S	VB [TE]	
DAILY IV Bus							
35S14, 35S14 /P	05/06-08/11	F1AE0481HA	2287	30x178	SK-1610	BTK	
35S14, 35S14 /P	05/06-08/11	F1AE0481HA	2287	30x178; Baumuster: Daily 35S14	SK-1610AQ1	BTKW	
35S14, 35S14 /P	05/06-08/11	F1AE0481HA	2287	30x178; Baumuster: Daily 35S14P	SK-1610AQ1	BTKW	
35S14, 35S14 /P	05/06-08/11	F1AE0481HA	2287		0-N1352	TB [DG]	
35S14 G	07/09-08/11	F1CE0441A	2998	mit Anbaumaterial	0-N1711S	VB [TE]	
35S14, 35S14 /P	05/06-08/11	F1AE0481HA	2287		0-N1483	VB [BT]	S
35S14, 35S14 /P	05/06-08/11	F1AE0481HA	2287		0-N1806	VB [BT]	
DAILY IV Kasten/Kombi							
29L10 V, 29L12 V, 29L12 V/P, 29L14 C, 29L14 C/P, 29L14 V, 29L14 V/P, 35C10, 35S10, 35C12 V, 35C12 V/P, 35S12 V, 35S12 V/P, 35S14 C, 35S14 C/P, 35S14 V, 35S14 V/P, 35C14 V, 35C14 V/P, 40C10 V, 40C12 V, 40C14 V/P	05/06-08/11	F1AE0481FA, F1AE0481GA, F1AE0481HA	2287	30x178	SK-1610	BTK	
29L10 V, 29L12 V, 29L12 V/P, 29L14 C, 29L14 C/P, 29L14 V, 29L14 V/P, 40C10 V, 40C11 V	05/06-08/11	F1AE0481FA, F1AE0481GA, F1AE0481HA	2287	30x178	SK-1610AQ1	BTKW	
35C10, 35S10	05/06-08/11	F1AE0481FA	2287	30x178; Baumuster: 35C10	SK-1610AQ1	BTKW	
35C10, 35S10	05/06-08/11	F1AE0481FA	2287	30x178; Baumuster: Daily 35S10	SK-1610AQ1	BTKW	
35C11 V, 35S11 V	07/07-08/11	F1AE0481FA	2287	30x178; Baumuster: Daily 35C11	SK-1610AQ1	BTKW	
35C11 V, 35S11 V	07/07-08/11	F1AE0481FA	2287	30x178; Baumuster: Daily 35S11	SK-1610AQ1	BTKW	
35C11 V, 35S11 V, 35C13 V, 35C13 V/P, 35S13 V, 35S13 V/P, 40C11 V, 40C13 V, 40C13 V/P	07/07-08/11	F1AE0481FA, F1AE0481GA	2287	30x178; 09/2009 →	SK-1610	BTK	
35C12 V, 35C12 V/P, 35S12 V, 35S12 V/P	05/06-08/11	F1AE0481GA	2287	30x178; Baumuster: 35C12	SK-1610AQ1	BTKW	
35C12 V, 35C12 V/P, 35S12 V, 35S12 V/P	05/06-08/11	F1AE0481GA	2287	30x178; Baumuster: 35C12H	SK-1610AQ1	BTKW	
35C12 V, 35C12 V/P, 35S12 V, 35S12 V/P	05/06-08/11	F1AE0481GA	2287	30x178; Baumuster: Daily 35C12P	SK-1610AQ1	BTKW	
35C12 V, 35C12 V/P, 35S12 V, 35S12 V/P	05/06-08/11	F1AE0481GA	2287	30x178; Baumuster: Daily 35S12	SK-1610AQ1	BTKW	
35C12 V, 35C12 V/P, 35S12 V, 35S12 V/P	05/06-08/11	F1AE0481GA	2287	30x178; Baumuster: Daily 35S12H	SK-1610AQ1	BTKW	
35C12 V, 35C12 V/P, 35S12 V, 35S12 V/P	05/06-08/11	F1AE0481GA	2287	30x178; Baumuster: Daily 35S12P	SK-1610AQ1	BTKW	
35C13 V, 35C13 V/P, 35S13 V, 35S13 V/P	07/07-08/11	F1AE0481GA	2287	30x178; Baumuster: Daily 35C13	SK-1610AQ1	BTKW	
35C13 V, 35C13 V/P, 35S13 V, 35S13 V/P	07/07-08/11	F1AE0481GA	2287	30x178; Baumuster: Daily 35C13P	SK-1610AQ1	BTKW	
35C13 V, 35C13 V/P, 35S13 V, 35S13 V/P	07/07-08/11	F1AE0481GA	2287	30x178; Baumuster: Daily 35S13	SK-1610AQ1	BTKW	
35C13 V, 35C13 V/P, 35S13 V, 35S13 V/P	07/07-08/11	F1AE0481GA	2287	30x178; Baumuster: Daily 35S13P	SK-1610AQ1	BTKW	
35S14 C, 35S14 C/P, 35S14 V, 35S14 V/P, 35C14 V, 35C14 V/P	05/06-08/11	F1AE0481HA	2287	30x178; Baumuster: Daily 35C14	SK-1610AQ1	BTKW	



CM³



Art. Nr.



ohne Halter

DAILY IV Kasten/Kombi

35S14 C, 35S14 C/P, 35S14 V, 35S14 V/P, 35C14 V, 35C14 V/P	05/06-08/11	F1AE0481HA	2287	30x178; Baumuster: Daily 35S14	SK-1610AQ1	BTKW	
35S14 C, 35S14 C/P, 35S14 V, 35S14 V/P, 35C14 V, 35C14 V/P	05/06-08/11	F1AE0481HA	2287	30x178; Baumuster: Daily 35S14P	SK-1610AQ1	BTKW	
40C12 V, 40C14 V/P	05/06-08/11	F1AE0481GA	2287	30x178; Baumuster: Daily 40C12	SK-1610AQ1	BTKW	
40C12 V, 40C14 V/P	05/06-08/11	F1AE0481GA	2287	30x178; Baumuster: Daily 40C12P	SK-1610AQ1	BTKW	
40C13 V, 40C13 V/P	07/07-08/11	F1AE0481GA	2287	30x178; Baumuster: Daily 40C13	SK-1610AQ1	BTKW	
40C13 V, 40C13 V/P	07/07-08/11	F1AE0481GA	2287	30x178; Baumuster: Daily 40C13P	SK-1610AQ1	BTKW	
29L10 V, 29L12 V, 29L12 V/P, 29L14 C, 29L14 C/P, 29L14 V, 29L14 V/P, 35C10, 35S10, 35C11 V, 35S11 V, 35C12 V, 35C12 V/P, 35S12 V, 35S12 V/P, 35C13 V, 35C13 V/P, 35S13 V, 35S13 V/P, 35S14 C, 35S14 C/P, 35S14 V, 35S14 V/P, 35C14 V, 35C14 V/P, 40C10 V, 40C11	05/06-08/11	F1AE0481FA, F1AE0481GA, F1AE0481HA	2287		0-N1352	TB [DG]	
29L10 V, 29L12 V, 29L12 V/P, 29L14 C, 29L14 C/P, 29L14 V, 29L14 V/P, 35C10, 35S10, 35C12 V, 35C12 V/P, 35S12 V, 35S12 V/P, 35S14 C, 35S14 C/P, 35S14 V, 35S14 V/P, 35C14 V, 35C14 V/P, 40C10 V, 40C12 V, 40C14 V/P	05/06-08/11	F1AE0481FA, F1AE0481GA, F1AE0481HA	2287		0-N1351	TB [TE]	
29L10 V, 29L12 V, 29L12 V/P, 29L14 C, 29L14 C/P, 29L14 V, 29L14 V/P, 35C10, 35S10, 35C11 V, 35S11 V, 35C12 V, 35C12 V/P, 35S12 V, 35S12 V/P, 35C13 V, 35C13 V/P, 35S13 V, 35S13 V/P, 35S14 C, 35S14 C/P, 35S14 V, 35S14 V/P, 35C14 V, 35C14 V/P, 40C10 V, 40C11	05/06-08/11	F1AE0481FA, F1AE0481GA, F1AE0481HA	2287		0-N1483	VB [BT]	S
29L10 V, 29L12 V, 29L12 V/P, 29L14 C, 29L14 C/P, 29L14 V, 29L14 V/P, 35C10, 35S10, 35C11 V, 35S11 V, 35C12 V, 35C12 V/P, 35S12 V, 35S12 V/P, 35C13 V, 35C13 V/P, 35S13 V, 35S13 V/P, 35S14 C, 35S14 C/P, 35S14 V, 35S14 V/P, 35C14 V, 35C14 V/P, 40C10 V, 40C11	05/06-08/11	F1AE0481FA, F1AE0481GA, F1AE0481HA	2287		0-N1806	VB [BT]	
29L10 V, 29L12 V, 29L12 V/P, 29L14 C, 29L14 C/P, 29L14 V, 29L14 V/P, 35C10, 35S10, 35C12 V, 35C12 V/P, 35S12 V, 35S12 V/P, 35S14 C, 35S14 C/P, 35S14 V, 35S14 V/P, 35C14 V, 35C14 V/P, 40C10 V, 40C12 V, 40C14 V/P	05/06-08/11	F1AE0481FA, F1AE0481GA, F1AE0481HA	2287		0-N1597	VB [DG]	
35C14 GV, 35C14 GV/P, 35S14 GV, 35S14 GV/P, 35C14 V, 35C14 V/P, 35S14 V, 35S14 V/P, 35C15 V, 35C15 V/P, 35C17 V, 35C17 V/P, 35S17 V, 35S17 V/P, 35C18 V, 35C18 V/P, 35S18 V, 35S18 V/P, 35S15, 40C14 GV, 40C14 GV/P, 40C14 V, 40C14 V/P, 40C15 V, 40C15 V/P, 40	05/06-08/11	F1CE0441A, F1CE0481FA, F1CE0481HA, F1CE0481HC, F1CE0481L, F1CE3481LC	2998	mit Anbaumaterial	0-N1711S	VB [TE]	
35C15 V, 35C15 V/P	05/06-08/11	F1CE0481FA	2998		0-N1597	VB [DG]	
35C15 V, 35C15 V/P, 35C18 V, 35C18 V/P, 35S18 V, 35S18 V/P, 40C15 V, 40C15 V/P, 40C18 V, 40C18 V/P, 45C15 V, 45C18, 50C15 V, 50C15 V/P, 50C18 V, 50C18 V/P, 60C15 V, 60C18, 65C15, 65C18	05/06-08/11	F1CE0481FA, F1CE0481HA, F1CE0481HC	2998		0-N1714	VB [BT]	S

DAILY IV Kipper

35C10 K	05/06-08/11	F1AE0481FA	2287	30x178; Baumuster: 35C10	SK-1610AQ1	BTKW	
35C10 K, 35C12	05/06-08/11	F1AE0481FA, F1AE0481GA	2287	30x178	SK-1610	BTK	
35C11 K, 35C11 DK, 35S11 K, 35S11 DK, 35C13 K, 35C13 DK, 35S13 K, 35S13 DK, 35S14 K, 35S14 DK	07/07-08/11	F1AE0481FA, F1AE0481GA, F1AE0481HA	2287	30x178; 09/2009 →	SK-1610	BTK	
35C11 K, 35C11 DK, 35S11 K, 35S11 DK, 35S14 K, 35S14 DK	07/07-08/11	F1AE0481FA, F1AE0481HA	2287	30x178	SK-1610AQ1	BTKW	
35C12	05/06-08/11	F1AE0481GA	2287	30x178; Baumuster: 35C12	SK-1610AQ1	BTKW	
35C13 K, 35C13 DK, 35S13 K, 35S13 DK	07/07-08/11	F1AE0481GA	2287	30x178; Baumuster: Daily 35C13	SK-1610AQ1	BTKW	
35C10 K, 35C11 K, 35C11 DK, 35S11 K, 35S11 DK, 35C12, 35C13 K, 35C13 DK, 35S13 K, 35S13 DK, 35S14 K, 35S14 DK	05/06-08/11	F1AE0481FA, F1AE0481GA, F1AE0481HA	2287		0-N1352	TB [DG]	
35C10 K, 35C12	05/06-08/11	F1AE0481FA, F1AE0481GA	2287		0-N1351	TB [TE]	
35C10 K, 35C11 K, 35C11 DK, 35S11 K, 35S11 DK, 35C12, 35C13 K, 35C13 DK, 35S13 K, 35S13 DK, 35S14 K, 35S14 DK	05/06-08/11	F1AE0481FA, F1AE0481GA, F1AE0481HA	2287		0-N1483	VB [BT]	S



CM³



Art. Nr.



ohne Halter

DAILY IV Kipper									
35C10 K, 35C11 K, 35C11 DK, 35S11 K, 35S11 DK, 35C12, 35C13 K, 35C13 DK, 35S13 K, 35S13 DK, 35S14 K, 35S14 DK	05/06-08/11	F1AE0481FA, F1AE0481GA, F1AE0481HA	2287			0-N1806	VB [BT]		
35C10 K, 35C12	05/06-08/11	F1AE0481FA, F1AE0481GA	2287			0-N1597	VB [DG]		
35C14 K, 35C14 DK, 35S14 K, 35S14 DK, 35C15, 35C17 K, 35C17 DK, 35S17 K, 35S17 DK, 35C18, 40C14 K, 40C14 DK, 40C17 K, 40C17 DK, 50C14 K, 50C14 DK, 50C15, 50C17 K, 50C17 DK, 50C18, 60C14 K, 60C14 DK, 60C15, 60C17 K, 60C17 DK, 60C18, 65C14 K, 65C14 DK, 65C1	05/06-08/11	F1CE0481FA, F1CE0481HA, F1CE0481HC, F1CE3481LC	2998	mit Anbaumaterial		0-N1711S	VB [TE]		
35C15, 35C18, 50C15, 50C18, 60C15, 60C18	05/06-08/11	F1CE0481FA, F1CE0481HA, F1CE0481HC	2998			0-N1714	VB [BT]	S	
DAILY IV Pritsche/Fahrgestell									
29L10, 29L12, 29L14, 35C10, 35S10, 35C12, 35S12, 35C14, 35S14, 35S14 /P, 40C10, 40C12	05/06-08/11	F1AE0481FA, F1AE0481GA, F1AE0481HA	2287	30x178		SK-1610	BTK		
29L10, 29L12, 29L14, 40C10, 40C11, 40C11 D	05/06-08/11	F1AE0481FA, F1AE0481GA, F1AE0481HA	2287	30x178		SK-1610AQ1	BTKW		
35C10, 35S10	05/06-08/11	F1AE0481FA	2287	30x178; Baumuster: 35C10		SK-1610AQ1	BTKW		
35C10, 35S10	05/06-08/11	F1AE0481FA	2287	30x178; Baumuster: Daily 35S10		SK-1610AQ1	BTKW		
35C11, 35S11, 35S11 D, 35S11 /P	07/07-08/11	F1AE0481FA	2287	30x178; Baumuster: Daily 35C11		SK-1610AQ1	BTKW		
35C11, 35S11, 35S11 D, 35S11 /P	07/07-08/11	F1AE0481FA	2287	30x178; Baumuster: Daily 35S11		SK-1610AQ1	BTKW		
35C11, 35S11, 35S11 D, 35S11 /P	07/07-08/11	F1AE0481FA	2287	30x178; Baumuster: Daily 35S11P		SK-1610AQ1	BTKW		
35C11, 35S11, 35S11 D, 35S11 /P, 35C13, 35C13 /P, 35S13 D, 35S13, 35S13 /P, 40C11, 40C11 D, 40C13, 40C13 /P	07/07-08/11	F1AE0481FA, F1AE0481GA	2287	30x178; 09/2009 →		SK-1610	BTK		
35C12, 35S12	05/06-08/11	F1AE0481GA	2287	30x178; Baumuster: 35C12		SK-1610AQ1	BTKW		
35C12, 35S12	05/06-08/11	F1AE0481GA	2287	30x178; Baumuster: 35C12H		SK-1610AQ1	BTKW		
35C12, 35S12	05/06-08/11	F1AE0481GA	2287	30x178; Baumuster: Daily 35C12P		SK-1610AQ1	BTKW		
35C12, 35S12	05/06-08/11	F1AE0481GA	2287	30x178; Baumuster: Daily 35S12		SK-1610AQ1	BTKW		
35C12, 35S12	05/06-08/11	F1AE0481GA	2287	30x178; Baumuster: Daily 35S12H		SK-1610AQ1	BTKW		
35C12, 35S12	05/06-08/11	F1AE0481GA	2287	30x178; Baumuster: Daily 35S12P		SK-1610AQ1	BTKW		
35C13, 35C13 /P, 35S13 D, 35S13, 35S13 /P	07/07-08/11	F1AE0481GA	2287	30x178; Baumuster: Daily 35C13		SK-1610AQ1	BTKW		
35C13, 35C13 /P, 35S13 D, 35S13, 35S13 /P	07/07-08/11	F1AE0481GA	2287	30x178; Baumuster: Daily 35C13P		SK-1610AQ1	BTKW		
35C13, 35C13 /P, 35S13 D, 35S13, 35S13 /P	07/07-08/11	F1AE0481GA	2287	30x178; Baumuster: Daily 35S13		SK-1610AQ1	BTKW		
35C13, 35C13 /P, 35S13 D, 35S13, 35S13 /P	07/07-08/11	F1AE0481GA	2287	30x178; Baumuster: Daily 35S13P		SK-1610AQ1	BTKW		
35C14, 35S14, 35S14 /P	05/06-08/11	F1AE0481HA	2287	30x178; Baumuster: Daily 35C14		SK-1610AQ1	BTKW		
35C14, 35S14, 35S14 /P	05/06-08/11	F1AE0481HA	2287	30x178; Baumuster: Daily 35S14		SK-1610AQ1	BTKW		
35C14, 35S14, 35S14 /P	05/06-08/11	F1AE0481HA	2287	30x178; Baumuster: Daily 35S14P		SK-1610AQ1	BTKW		
40C12	05/06-08/11	F1AE0481GA	2287	30x178; Baumuster: Daily 40C12		SK-1610AQ1	BTKW		
40C12	05/06-08/11	F1AE0481GA	2287	30x178; Baumuster: Daily 40C12P		SK-1610AQ1	BTKW		
40C13, 40C13 /P	07/07-08/11	F1AE0481GA	2287	30x178; Baumuster: Daily 40C13		SK-1610AQ1	BTKW		
40C13, 40C13 /P	07/07-08/11	F1AE0481GA	2287	30x178; Baumuster: Daily 40C13P		SK-1610AQ1	BTKW		
29L10, 29L12, 29L14, 35C10, 35S10, 35C11, 35S11, 35S11 D, 35S11 /P, 35C12, 35S12, 35C13, 35C13 /P, 35S13 D, 35S13, 35S13 /P, 35C14, 35S14, 35S14 /P, 40C10, 40C11, 40C11 D, 40C12, 40C13, 40C13 /P	05/06-08/11	F1AE0481FA, F1AE0481GA, F1AE0481HA	2287			0-N1352	TB [DG]		
29L10, 29L12, 29L14, 35C10, 35S10, 35C12, 35S12, 35C14, 35S14, 35S14 /P, 40C10, 40C12	05/06-08/11	F1AE0481FA, F1AE0481GA, F1AE0481HA	2287			0-N1351	TB [TE]		
29L10, 29L12, 29L14, 35C10, 35S10, 35C11, 35S11, 35S11 D, 35S11 /P, 35C12, 35S12, 35C13, 35C13 /P, 35S13 D, 35S13, 35S13 /P, 35C14, 35S14, 35S14 /P, 40C10, 40C11, 40C11 D, 40C12, 40C13, 40C13 /P	05/06-08/11	F1AE0481FA, F1AE0481GA, F1AE0481HA	2287			0-N1483	VB [BT]	S	
29L10, 29L12, 29L14, 35C10, 35S10, 35C11, 35S11, 35S11 D, 35S11 /P, 35C12, 35S12, 35C13, 35C13 /P, 35S13 D, 35S13, 35S13 /P, 35C14, 35S14, 35S14 /P, 40C10, 40C11, 40C11 D, 40C12, 40C13, 40C13 /P	05/06-08/11	F1AE0481FA, F1AE0481GA, F1AE0481HA	2287			0-N1806	VB [BT]		
29L10, 29L12, 29L14, 35C10, 35S10, 35C12, 35S12, 35C14, 35S14, 35S14 /P, 40C10, 40C12	05/06-08/11	F1AE0481FA, F1AE0481GA, F1AE0481HA	2287			0-N1597	VB [DG]		



OPTIMAL®

IVECO

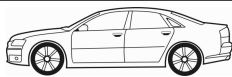

CM³



Art. Nr.



ohne Halter

DAILY IV Pritsche/Fahrgestell							
35C14 G, 35C14 G/P, 35S14 G, 35S14 G/P, 35C14 GD, 35S14 GD, 35C14, 35C14 /P, 35S14, 35S14 /P, 35S14 D/P, 35C15, 35C17, 35C17 /P, 35S17, 35S17 /P, 35S17 D, 35C18, 35S18, 35S17 W, 35S17 WD, 40C14 G, 40C14 G/P, 40C14, 40C14 /P, 40C15, 40C17, 40C17 /	05/06-08/11	F1CE0441A, F1CE0481FA, F1CE0481HA, F1CE0481HC, F1CE3481LC	2998	mit Anbaumaterial		0-N1711S	VB [TE]
35C15	05/06-08/11	F1CE0481FA	2998			0-N1597	VB [DG]
35C15, 35C18, 35S18, 40C15, 40C18, 45C15, 45C18, 45C18 /P, 45C18 D, 45C18 D/P, 50C15, 50C18, 60C15, 60C15 /P, 60C15 D, 60C15 D/P, 60C18, 65C15, 65C15 /P, 65C15 D, 65C15 D/P, 65C18	05/06-08/11	F1CE0481FA, F1CE0481HA, F1CE0481HC	2998			0-N1714	VB [BT] S

DAILY V Kasten/Kombi							
29L11 V, 35C11 V, 35S11 V, 40C11 V	09/11-02/14	F1AE3481A	2287	30x178; Baumuster: Daily 29L11		SK-1610	BTK
29L11 V, 35C11 V, 35S11 V, 40C11 V	09/11-02/14	F1AE3481A	2287	30x178; Baumuster: Daily 35C11		SK-1610	BTK
29L11 V, 35C11 V, 35S11 V, 40C11 V	09/11-02/14	F1AE3481A	2287	30x178; Baumuster: Daily 35S11		SK-1610	BTK
29L11 V, 35C11 V, 35S11 V, 40C11 V	09/11-02/14	F1AE3481A	2287	30x178; Baumuster: Daily 40C11		SK-1610	BTK
29L11 V, 35C11 V, 35S11 V, 40C11 V	09/11-02/14	F1AE3481A	2287	30x178; Baumuster: Daily 29L11		SK-1610AQ1	BTKW
29L11 V, 35C11 V, 35S11 V, 40C11 V	09/11-02/14	F1AE3481A	2287	30x178; Baumuster: Daily 29S11		SK-1610AQ1	BTKW
29L11 V, 35C11 V, 35S11 V, 40C11 V	09/11-02/14	F1AE3481A	2287	30x178; Baumuster: Daily 35C11		SK-1610AQ1	BTKW
29L11 V, 35C11 V, 35S11 V, 40C11 V	09/11-02/14	F1AE3481A	2287	30x178; Baumuster: Daily 35S11		SK-1610AQ1	BTKW
29L11 V, 35C11 V, 35S11 V, 40C11 V	09/11-02/14	F1AE3481A	2287	30x178; Baumuster: Daily 40C11		SK-1610AQ1	BTKW
29L13 V, 35C13 V, 35S13 V, 40C13 V, 40S13 V	09/11-02/14	F1AE3481B	2287	30x178; Baumuster: Daily 35C13		SK-1610	BTK
29L13 V, 35C13 V, 35S13 V, 40C13 V, 40S13 V	09/11-02/14	F1AE3481B	2287	30x178; Baumuster: Daily 35C13P		SK-1610	BTK
29L13 V, 35C13 V, 35S13 V, 40C13 V, 40S13 V	09/11-02/14	F1AE3481B	2287	30x178; Baumuster: Daily 35S13		SK-1610	BTK
29L13 V, 35C13 V, 35S13 V, 40C13 V, 40S13 V	09/11-02/14	F1AE3481B	2287	30x178; Baumuster: Daily 35S13P		SK-1610	BTK
29L13 V, 35C13 V, 35S13 V, 40C13 V, 40S13 V	09/11-02/14	F1AE3481B	2287	30x178; Baumuster: Daily 40C13		SK-1610	BTK
29L13 V, 35C13 V, 35S13 V, 40C13 V, 40S13 V	09/11-02/14	F1AE3481B	2287	30x178; Baumuster: Daily 40C13P		SK-1610	BTK
29L13 V, 35C13 V, 35S13 V, 40C13 V, 40S13 V	09/11-02/14	F1AE3481B	2287	30x178; Baumuster: Daily 35C13		SK-1610AQ1	BTKW
29L13 V, 35C13 V, 35S13 V, 40C13 V, 40S13 V	09/11-02/14	F1AE3481B	2287	30x178; Baumuster: Daily 35C13P		SK-1610AQ1	BTKW
29L13 V, 35C13 V, 35S13 V, 40C13 V, 40S13 V	09/11-02/14	F1AE3481B	2287	30x178; Baumuster: Daily 35S13		SK-1610AQ1	BTKW
29L13 V, 35C13 V, 35S13 V, 40C13 V, 40S13 V	09/11-02/14	F1AE3481B	2287	30x178; Baumuster: Daily 35S13P		SK-1610AQ1	BTKW
29L13 V, 35C13 V, 35S13 V, 40C13 V, 40S13 V	09/11-02/14	F1AE3481B	2287	30x178; Baumuster: Daily 40C13		SK-1610AQ1	BTKW
29L13 V, 35C13 V, 35S13 V, 40C13 V, 40S13 V	09/11-02/14	F1AE3481B	2287	30x178; Baumuster: Daily 40C13P		SK-1610AQ1	BTKW
29L11 V, 35C11 V, 35S11 V, 40C11 V, 29L13 V, 35C13 V, 35S13 V, 40C13 V, 40S13 V, 29L15 V, 35C15L V, 40C15L V, 50C15L V	09/11-02/14	F1AE3481A, F1AE3481B, F1AE3481C	2287			0-N1352	TB [DG]
29L11 V, 35C11 V, 35S11 V, 40C11 V, 29L13 V, 35C13 V, 35S13 V, 40C13 V, 40S13 V, 29L15 V, 35C15L V, 40C15L V, 50C15L V	09/11-02/14	F1AE3481A, F1AE3481B, F1AE3481C	2287			0-N1483	VB [BT] S
29L11 V, 35C11 V, 35S11 V, 40C11 V, 29L13 V, 35C13 V, 35S13 V, 40C13 V, 40S13 V, 29L15 V, 35C15L V, 40C15L V, 50C15L V	09/11-02/14	F1AE3481A, F1AE3481B, F1AE3481C	2287			0-N1806	VB [BT]
35C15 V, 40C15 V, 35C17 V, 35S17 V, 40C17 V, 45C17 V, 50C17 V, 60C17 V, 35C21 V, 35S21 V, 40C21 V, 45C21 V, 50C21 V	09/11-02/14	F1CE3481C, F1CE3481K, F1CE3481D, F1CE3481J, F1CE3481L	2998	mit Anbaumaterial		0-N1711S	VB [TE]

DAILY V Kipper							
35C11K, 35S11DKP	09/11-02/14	F1AE3481A	2287	30x178; Baumuster: Daily 35C11		SK-1610AQ1	BTKW
35C11K, 35S11DKP, 35C13K, 35C13DKP	09/11-02/14	F1AE3481A, F1AE3481B	2287	30x178		SK-1610	BTK
35C13K, 35C13DKP	09/11-02/14	F1AE3481B	2287	30x178; Baumuster: Daily 35C13		SK-1610AQ1	BTKW
35C11K, 35S11DKP, 35C13K, 35C13DKP	09/11-02/14	F1AE3481A, F1AE3481B	2287			0-N1352	TB [DG]
35C11K, 35S11DKP, 35C13K, 35C13DKP	09/11-02/14	F1AE3481A, F1AE3481B	2287			0-N1483	VB [BT] S
35C11K, 35S11DKP, 35C13K, 35C13DKP	09/11-02/14	F1AE3481A, F1AE3481B	2287			0-N1806	VB [BT]



CM³



Art. Nr.



DAILY V Kipper

35C15K, 35S15DKP, 50C15K, 60C15K, 65C15DK, 70C15K, 35C17K, 35S17DKP, 50C17K, 65C17DK 70C17K, 35S21DKP	09/11-02/14	F1CE3481C, F1CE3481K, F1CE3481D, F1CE3481L	2998	mit Anbaumaterial	0-N1711S	VB [TE]
---	-------------	--	------	-------------------	----------	---------

DAILY V Pritsche/Fahrgestell

26L11, 26L11D, 35C11D, 35S11, 40C11	09/11-02/14	F1AE3481A	2287	30x178; Baumuster: Daily 29L11	SK-1610	BTK
26L11, 26L11D, 35C11D, 35S11, 40C11	09/11-02/14	F1AE3481A	2287	30x178; Baumuster: Daily 35C11	SK-1610	BTK
26L11, 26L11D, 35C11D, 35S11, 40C11	09/11-02/14	F1AE3481A	2287	30x178; Baumuster: Daily 35S11	SK-1610	BTK
26L11, 26L11D, 35C11D, 35S11, 40C11	09/11-02/14	F1AE3481A	2287	30x178; Baumuster: Daily 35S11P	SK-1610	BTK
26L11, 26L11D, 35C11D, 35S11, 40C11	09/11-02/14	F1AE3481A	2287	30x178; Baumuster: Daily 40C11	SK-1610	BTK
26L11, 26L11D, 35C11D, 35S11, 40C11	09/11-02/14	F1AE3481A	2287	30x178; Baumuster: Daily 29L11	SK-1610AQ1	BTKW
26L11, 26L11D, 35C11D, 35S11, 40C11	09/11-02/14	F1AE3481A	2287	30x178; Baumuster: Daily 35C11	SK-1610AQ1	BTKW
26L11, 26L11D, 35C11D, 35S11, 40C11	09/11-02/14	F1AE3481A	2287	30x178; Baumuster: Daily 35S11	SK-1610AQ1	BTKW
26L11, 26L11D, 35C11D, 35S11, 40C11	09/11-02/14	F1AE3481A	2287	30x178; Baumuster: Daily 35S11P	SK-1610AQ1	BTKW
26L11, 26L11D, 35C11D, 35S11, 40C11	09/11-02/14	F1AE3481A	2287	30x178; Baumuster: Daily 40C11	SK-1610AQ1	BTKW
29L13, 29L13D, 35C13D, 40C13	09/11-02/14	F1AE3481B	2287	30x178; Baumuster: Daily 35S13	SK-1610	BTK
29L13, 29L13D, 35C13D, 40C13	09/11-02/14	F1AE3481B	2287	30x178; Baumuster: Daily 35S13P	SK-1610	BTK
29L13, 29L13D, 35C13D, 40C13	09/11-02/14	F1AE3481B	2287	30x178; Baumuster: Daily 40C13	SK-1610	BTK
29L13, 29L13D, 35C13D, 40C13	09/11-02/14	F1AE3481B	2287	30x178; Baumuster: Daily 40C13P	SK-1610	BTK
29L13, 29L13D, 35C13D, 40C13	09/11-02/14	F1AE3481B	2287	30x178; Baumuster: Daily 35S13	SK-1610AQ1	BTKW
29L13, 29L13D, 35C13D, 40C13	09/11-02/14	F1AE3481B	2287	30x178; Baumuster: Daily 35S13P	SK-1610AQ1	BTKW
29L13, 29L13D, 35C13D, 40C13	09/11-02/14	F1AE3481B	2287	30x178; Baumuster: Daily 40C13	SK-1610AQ1	BTKW
29L13, 29L13D, 35C13D, 40C13	09/11-02/14	F1AE3481B	2287	30x178; Baumuster: Daily 40C13P	SK-1610AQ1	BTKW
29L13, 29L13D, 35C13D, 40C13, 29L15 V, 35C15L V, 40C15L V, 50C15L V	09/11-02/14	F1AE3481B, F1AE3481C	2287	30x178; Baumuster: Daily 35C13	SK-1610	BTK
29L13, 29L13D, 35C13D, 40C13, 29L15 V, 35C15L V, 40C15L V, 50C15L V	09/11-02/14	F1AE3481B, F1AE3481C	2287	30x178; Baumuster: Daily 35C13P	SK-1610	BTK
29L13, 29L13D, 35C13D, 40C13, 29L15 V, 35C15L V, 40C15L V, 50C15L V	09/11-02/14	F1AE3481B, F1AE3481C	2287	30x178; Baumuster: Daily 35C13	SK-1610AQ1	BTKW
29L13, 29L13D, 35C13D, 40C13, 29L15 V, 35C15L V, 40C15L V, 50C15L V	09/11-02/14	F1AE3481B, F1AE3481C	2287	30x178; Baumuster: Daily 35C13P	SK-1610AQ1	BTKW
29L15 V, 35C15L V, 40C15L V, 50C15L V	09/11-02/14	F1AE3481C	2287	30x178; Baumuster: 29L15	SK-1610	BTK
29L15 V, 35C15L V, 40C15L V, 50C15L V	09/11-02/14	F1AE3481C	2287	30x178; Baumuster: Daily 35C15	SK-1610	BTK
29L15 V, 35C15L V, 40C15L V, 50C15L V	09/11-02/14	F1AE3481C	2287	30x178; Baumuster: Daily 35S15	SK-1610	BTK
29L15 V, 35C15L V, 40C15L V, 50C15L V	09/11-02/14	F1AE3481C	2287	30x178; Baumuster: Daily 35S15P	SK-1610	BTK
29L15 V, 35C15L V, 40C15L V, 50C15L V	09/11-02/14	F1AE3481C	2287	30x178; Baumuster: 29L15	SK-1610AQ1	BTKW
29L15 V, 35C15L V, 40C15L V, 50C15L V	09/11-02/14	F1AE3481C	2287	30x178; Baumuster: Daily 35C15	SK-1610AQ1	BTKW
29L15 V, 35C15L V, 40C15L V, 50C15L V	09/11-02/14	F1AE3481C	2287	30x178; Baumuster: Daily 35S15	SK-1610AQ1	BTKW
29L15 V, 35C15L V, 40C15L V, 50C15L V	09/11-02/14	F1AE3481C	2287	30x178; Baumuster: Daily 35S15P	SK-1610AQ1	BTKW
26L11, 26L11D, 35C11D, 35S11, 40C11, 29L13, 29L13D, 35C13D, 40C13	09/11-02/14	F1AE3481A, F1AE3481B	2287		0-N1352	TB [DG]
26L11, 26L11D, 35C11D, 35S11, 40C11, 29L13, 29L13D, 35C13D, 40C13	09/11-02/14	F1AE3481A, F1AE3481B	2287		0-N1483	VB [BT] S
26L11, 26L11D, 35C11D, 35S11, 40C11, 29L13, 29L13D, 35C13D, 40C13	09/11-02/14	F1AE3481A, F1AE3481B	2287		0-N1806	VB [BT]
35C15, 35C15D, 35S15, 40C15, 45C15, 50C15, 60C15, 70C15, 35C17, 35C17D, 35S17, 40C17, 45C17, 50C17, 60C17, 70C17, 35C21, 35S21, 40C21, 45C21, 50C21, 60C21, 70C21	09/11-02/14	F1CE3481C, F1CE3481K, F1CE3481D, F1CE3481J, F1CE3481L	2998	mit Anbaumaterial	0-N1711S	VB [TE]

DAILY VI Kasten/Kombi

33S11, 35S11, 35C11	03/14-	F1AE3481A, F1AFL411A	2287	30x178; Baumuster: 33S11	SK-1610	BTK
33S11, 35S11, 35C11	03/14-	F1AE3481A, F1AFL411A	2287	30x178; Baumuster: Daily 35C11	SK-1610	BTK
33S11, 35S11, 35C11	03/14-	F1AE3481A, F1AFL411A	2287	30x178; Baumuster: Daily 35S11	SK-1610	BTK
33S11, 35S11, 35C11	03/14-	F1AE3481A, F1AFL411A	2287	30x178; Baumuster: 33S11	SK-1610AQ1	BTKW
33S11, 35S11, 35C11	03/14-	F1AE3481A, F1AFL411A	2287	30x178; Baumuster: Daily 35C11	SK-1610AQ1	BTKW
33S11, 35S11, 35C11	03/14-	F1AE3481A, F1AFL411A	2287	30x178; Baumuster: Daily 35S11	SK-1610AQ1	BTKW
33S13, 35S13, 35C13	03/14-	F1AFL411B	2287	30x178; Baumuster: 33S13	SK-1610	BTK
33S13, 35S13, 35C13	03/14-	F1AFL411B	2287	30x178; Baumuster: 33S13P	SK-1610	BTK
33S13, 35S13, 35C13	03/14-	F1AFL411B	2287	30x178; Baumuster: Daily 35C13	SK-1610	BTK
33S13, 35S13, 35C13	03/14-	F1AFL411B	2287	30x178; Baumuster: Daily 35C13P	SK-1610	BTK
33S13, 35S13, 35C13	03/14-	F1AFL411B	2287	30x178; Baumuster: Daily 35S13	SK-1610	BTK
33S13, 35S13, 35C13	03/14-	F1AFL411B	2287	30x178; Baumuster: Daily 35S13P	SK-1610	BTK
33S13, 35S13, 35C13	03/14-	F1AFL411B	2287	30x178; Baumuster: 33S13	SK-1610AQ1	BTKW
33S13, 35S13, 35C13	03/14-	F1AFL411B	2287	30x178; Baumuster: 33S13P	SK-1610AQ1	BTKW
33S13, 35S13, 35C13	03/14-	F1AFL411B	2287	30x178; Baumuster: Daily 35C13	SK-1610AQ1	BTKW
33S13, 35S13, 35C13	03/14-	F1AFL411B	2287	30x178; Baumuster: Daily 35C13P	SK-1610AQ1	BTKW
33S13, 35S13, 35C13	03/14-	F1AFL411B	2287	30x178; Baumuster: Daily 35S13	SK-1610AQ1	BTKW
33S13, 35S13, 35C13	03/14-	F1AFL411B	2287	30x178; Baumuster: Daily 35S13P	SK-1610AQ1	BTKW



OPTIMAL®

IVECO



CM³



Art. Nr.



ohne Halter

DAILY VI Kasten/Kombi

33S15, 35S15, 35C15	03/14-	F1AE3481C, F1AFL411C	2287	30x178; Baumuster: 33S15	SK-1610	BTK
33S15, 35S15, 35C15	03/14-	F1AE3481C, F1AFL411C	2287	30x178; Baumuster: 33S15P	SK-1610	BTK
33S15, 35S15, 35C15	03/14-	F1AE3481C, F1AFL411C	2287	30x178; Baumuster: Daily 35C15	SK-1610	BTK
33S15, 35S15, 35C15	03/14-	F1AE3481C, F1AFL411C	2287	30x178; Baumuster: Daily 35C15P	SK-1610	BTK
33S15, 35S15, 35C15	03/14-	F1AE3481C, F1AFL411C	2287	30x178; Baumuster: Daily 35S15	SK-1610	BTK
33S15, 35S15, 35C15	03/14-	F1AE3481C, F1AFL411C	2287	30x178; Baumuster: Daily 35S15P	SK-1610	BTK
33S15, 35S15, 35C15	03/14-	F1AE3481C, F1AFL411C	2287	30x178; Baumuster: 33S15	SK-1610AQ1	BTKW
33S15, 35S15, 35C15	03/14-	F1AE3481C, F1AFL411C	2287	30x178; Baumuster: 33S15P	SK-1610AQ1	BTKW
33S15, 35S15, 35C15	03/14-	F1AE3481C, F1AFL411C	2287	30x178; Baumuster: Daily 35C15	SK-1610AQ1	BTKW
33S15, 35S15, 35C15	03/14-	F1AE3481C, F1AFL411C	2287	30x178; Baumuster: Daily 35C15P	SK-1610AQ1	BTKW
33S15, 35S15, 35C15	03/14-	F1AE3481C, F1AFL411C	2287	30x178; Baumuster: Daily 35S15	SK-1610AQ1	BTKW
33S15, 35S15, 35C15	03/14-	F1AE3481C, F1AFL411C	2287	30x178; Baumuster: Daily 35S15P	SK-1610AQ1	BTKW

DAILY VI Pritsche/Fahrgestell

33S11, 35S11, 35C11	03/14-	F1AE3481A, F1AFL411A	2287	30x178; Baumuster: 33S11	SK-1610	BTK
33S11, 35S11, 35C11	03/14-	F1AE3481A, F1AFL411A	2287	30x178; Baumuster: Daily 35C11	SK-1610	BTK
33S11, 35S11, 35C11	03/14-	F1AE3481A, F1AFL411A	2287	30x178; Baumuster: Daily 35S11	SK-1610	BTK
33S11, 35S11, 35C11	03/14-	F1AE3481A, F1AFL411A	2287	30x178; Baumuster: Daily 35S11P	SK-1610	BTK
33S11, 35S11, 35C11	03/14-	F1AE3481A, F1AFL411A	2287	30x178; Baumuster: 33S11	SK-1610AQ1	BTKW
33S11, 35S11, 35C11	03/14-	F1AE3481A, F1AFL411A	2287	30x178; Baumuster: Daily 35C11	SK-1610AQ1	BTKW
33S11, 35S11, 35C11	03/14-	F1AE3481A, F1AFL411A	2287	30x178; Baumuster: Daily 35S11	SK-1610AQ1	BTKW
33S11, 35S11, 35C11	03/14-	F1AE3481A, F1AFL411A	2287	30x178; Baumuster: Daily 35S11P	SK-1610AQ1	BTKW
33S13, 35S13, 35C13	03/14-	F1AE3481B, F1AFL411B	2287	30x178; Baumuster: 33S13	SK-1610	BTK
33S13, 35S13, 35C13	03/14-	F1AE3481B, F1AFL411B	2287	30x178; Baumuster: 33S13P	SK-1610	BTK
33S13, 35S13, 35C13	03/14-	F1AE3481B, F1AFL411B	2287	30x178; Baumuster: Daily 35C13	SK-1610	BTK
33S13, 35S13, 35C13	03/14-	F1AE3481B, F1AFL411B	2287	30x178; Baumuster: Daily 35C13P	SK-1610	BTK
33S13, 35S13, 35C13	03/14-	F1AE3481B, F1AFL411B	2287	30x178; Baumuster: Daily 35S13	SK-1610	BTK
33S13, 35S13, 35C13	03/14-	F1AE3481B, F1AFL411B	2287	30x178; Baumuster: Daily 35S13P	SK-1610	BTK
33S13, 35S13, 35C13	03/14-	F1AE3481B, F1AFL411B	2287	30x178; Baumuster: 33S13	SK-1610AQ1	BTKW
33S13, 35S13, 35C13	03/14-	F1AE3481B, F1AFL411B	2287	30x178; Baumuster: 33S13P	SK-1610AQ1	BTKW
33S13, 35S13, 35C13	03/14-	F1AE3481B, F1AFL411B	2287	30x178; Baumuster: Daily 35C13	SK-1610AQ1	BTKW
33S13, 35S13, 35C13	03/14-	F1AE3481B, F1AFL411B	2287	30x178; Baumuster: Daily 35C13P	SK-1610AQ1	BTKW
33S13, 35S13, 35C13	03/14-	F1AE3481B, F1AFL411B	2287	30x178; Baumuster: Daily 35S13	SK-1610AQ1	BTKW
33S13, 35S13, 35C13	03/14-	F1AE3481B, F1AFL411B	2287	30x178; Baumuster: Daily 35S13P	SK-1610AQ1	BTKW
33S15, 35S15, 35C15	03/14-	F1AE3481C, F1AFL411C	2287	30x178; Baumuster: 33S15	SK-1610	BTK
33S15, 35S15, 35C15	03/14-	F1AE3481C, F1AFL411C	2287	30x178; Baumuster: 33S15P	SK-1610	BTK
33S15, 35S15, 35C15	03/14-	F1AE3481C, F1AFL411C	2287	30x178; Baumuster: Daily 35C15	SK-1610	BTK
33S15, 35S15, 35C15	03/14-	F1AE3481C, F1AFL411C	2287	30x178; Baumuster: Daily 35C15P	SK-1610	BTK
33S15, 35S15, 35C15	03/14-	F1AE3481C, F1AFL411C	2287	30x178; Baumuster: Daily 35S15	SK-1610	BTK
33S15, 35S15, 35C15	03/14-	F1AE3481C, F1AFL411C	2287	30x178; Baumuster: Daily 35S15P	SK-1610	BTK
33S15, 35S15, 35C15	03/14-	F1AE3481C, F1AFL411C	2287	30x178; Baumuster: 33S15	SK-1610AQ1	BTKW
33S15, 35S15, 35C15	03/14-	F1AE3481C, F1AFL411C	2287	30x178; Baumuster: 33S15P	SK-1610AQ1	BTKW
33S15, 35S15, 35C15	03/14-	F1AE3481C, F1AFL411C	2287	30x178; Baumuster: Daily 35C15	SK-1610AQ1	BTKW
33S15, 35S15, 35C15	03/14-	F1AE3481C, F1AFL411C	2287	30x178; Baumuster: Daily 35C15P	SK-1610AQ1	BTKW
33S15, 35S15, 35C15	03/14-	F1AE3481C, F1AFL411C	2287	30x178; Baumuster: Daily 35S15	SK-1610AQ1	BTKW
33S15, 35S15, 35C15	03/14-	F1AE3481C, F1AFL411C	2287	30x178; Baumuster: Daily 35S15P	SK-1610AQ1	BTKW

MASSIF Pick-up

3.0 HPI, 3.0 HPT	10/08-02/11	F1CE0481FA, F1CE0481HA	2998	mit Anbaumaterial	0-N1711S	VB [TE]
------------------	-------------	------------------------	------	-------------------	----------	---------

MASSIF Single Cab

3.0 HPI, 3.0 HPT	10/08-02/11	F1CE0481FA, F1CE0481HA	2998	mit Anbaumaterial	0-N1711S	VB [TE]
------------------	-------------	------------------------	------	-------------------	----------	---------

MASSIF Station Wagon

3.0 HPI, 3.0 HPT	10/08-02/11	F1CE0481FA, F1CE0481HA	2998	mit Anbaumaterial	0-N1711S	VB [TE]
------------------	-------------	------------------------	------	-------------------	----------	---------



CM³



Art. Nr.



ohne Halter

S-TYPE (CCX)							
2.7 D	06/04-10/07	AJD	2720	29x195; 20x85; → 07/2008	SK-1675	BTK	
2.7 D	06/04-10/07	AJD	2720	29x195	SK-1742	BTK	
2.7 D	06/04-10/07	AJD	2720		0-N1613	TB [TE]	
2.7 D	06/04-10/07	AJD	2720		0-N1614	TB [TE]	
2.7 D	06/04-10/07	AJD	2720		0-N1615	TB [DG]	
2.5 V6	04/02-10/07		2497	ch.L76000→	0-N2281	VB [BT]	S
3.0 V6	01/99-10/07	AJ-V6, FB	2967	ch.L76000→	0-N2281	VB [BT]	S
4.0 V8	01/99-04/02	AJ-V8	3996		0-N1684	VB [DG]	
4.0 V8	01/99-04/02	AJ-V8	3996	ch.M45255→	0-N2281	VB [BT]	S
4.2 V8, R 4,2 V8	04/02-10/07	AJ8FT	4196	ch.M45255→	0-N2281	VB [BT]	S
XF (_J05_, CC9)							
2.7 D	03/08-04/15	AJD	2720	29x195; 20x85	SK-1675	BTK	
2.7 D	03/08-04/15	AJD	2720	29x195	SK-1742	BTK	
3.0 D	03/09-04/15	306DT, AJV6D, AJV6D	2993	29x195	SK-1742	BTK	
2.7 D	03/08-04/15	AJD	2720		0-N1613	TB [TE]	
2.7 D	03/08-04/15	AJD	2720		0-N1614	TB [TE]	
2.7 D	03/08-04/15	AJD	2720		0-N1615	TB [DG]	
3.0 D	03/09-04/15	306DT, AJV6D, AJV6D	2993		0-N1614	TB [TE]	
3.0 D, 3.0 D AWD	03/09-04/15	306DT, AJV6D, AJV6D	2993		0-N1613	TB [TE]	
3.0 D, 3.0 D AWD	03/09-04/15	306DT, AJV6D, AJV6D	2993		0-N1615	TB [DG]	
3.0	03/08-04/15	AJ6WG, FB	2967		0-N2281	VB [BT]	S
4.2, 4.2 Kompressor	03/08-04/15	SV82G, SV8TS	4196		0-N2281	VB [BT]	S
XF SPORTBRAKE (CC9)							
3.0 D	09/12-04/14	306DT, AJV6D	2993	29x195	SK-1742	BTK	
3.0 D	09/12-04/14	306DT, AJV6D	2993		0-N1613	TB [TE]	
3.0 D	09/12-04/14	306DT, AJV6D	2993		0-N1615	TB [DG]	
XJ (NAW, NBW)							
R 4.0	07/97-05/03	DC	3996		0-N2281	VB [BT]	S
XJ (N3_, X350, X358)							
6 2,7 D	10/05-03/09	AJD	2720	29x195; 20x85	SK-1675	BTK	
6 2,7 D	10/05-03/09	AJD	2720	29x195	SK-1742	BTK	
6 2,7 D	10/05-03/09	AJD	2720		0-N1613	TB [TE]	
6 2,7 D	10/05-03/09	AJD	2720		0-N1614	TB [TE]	
6 2,7 D	10/05-03/09	AJD	2720		0-N1615	TB [DG]	
6 3.0	05/03-03/09	AJ-V6	2967		0-N2281	VB [BT]	S
8 3.5	05/03-03/09		3555		0-N2281	VB [BT]	S
8 4.2, R 4.2	05/03-03/09	AJ8FT	4196		0-N2281	VB [BT]	S
XJ (NNA_, X35_, _J12_, _J24_)							
3.0 V6 D	10/09-	AJV6D	2993	29x195	SK-1742	BTK	
3.0 V6 D	10/09-	AJV6D	2993		0-N1613	TB [TE]	
3.0 V6 D	10/09-	AJV6D	2993		0-N1615	TB [DG]	
3.0	01/11-	AJ-V6	2967		0-N2281	VB [BT]	S
XK 8 Convertible (QDV)							
4.0	02/98-07/05	EC	3996		0-N2281	VB [BT]	S
4.2, R 4,2	08/02-07/05	AJ8FT	4196		0-N2281	VB [BT]	S
XK 8 Coupe (QEV)							
4.0	02/98-07/05	EC	3996		0-N2281	VB [BT]	S
4.2, R 4,2	08/02-07/05	AJ8FT	4196		0-N2281	VB [BT]	S
XK Cabriolet (_J43_, QQ6_)							
3.6	10/07-07/14		3555		0-N2281	VB [BT]	S
4.2 XK8, 4.2 XKR	03/06-07/14	AJ8FT, SV8TS	4196		0-N2281	VB [BT]	S
XK Coupe (QQ6_, _J43_)							
3.5 XK	07/07-07/14		3555		0-N2281	VB [BT]	S
4.2 XK8, 4.2 XKR	03/06-07/14	AJ8FT, SV8TS	4196		0-N2281	VB [BT]	S
X-TYPE (CF1)							
2.0 V6	03/02-10/05		2099		0-N2281	VB [BT]	S
2.5 V6	06/01-11/09		2495		0-N2281	VB [BT]	S
3.0 V6	06/01-11/07	AJ-V6	2967		0-N2281	VB [BT]	S
X-TYPE Estate (CF1_)							
2.0 V6	11/03-03/09		2099		0-N2281	VB [BT]	S
2.5	02/04-12/09		2495		0-N2281	VB [BT]	S



OPTIMAL®

JAGUAR

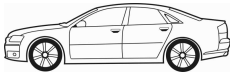

CM³



Art. Nr.



ohne Halter

X-TYPE Estate (CF1_)

3.0	02/04-12/09	AJ-V6	2967		0-N2281	VB [BT]	S
-----	-------------	-------	------	--	---------	---------	---

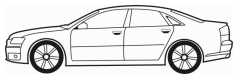

CM³



Art. Nr.



CHEROKEE (XJ)

2.1 D 4x4, 2.1 TD	10/84-09/01	J8S, J8S 742	2068	25x148	SK-1014	BTK	
2.1 D 4x4, 2.1 TD	10/86-09/92	J8S, J8S 742	2068	25x148	SK-1063	BTK	
2.1 TD	10/84-09/01	J8S	2068	25x148; 10/1986 → 09/1994	SK-1063	BTK	
2.1 D 4x4, 2.1 TD	10/84-09/01	J8S, J8S 742	2068		0-N857	TB [DG]	
2.1 D 4x4, 2.1 TD	10/84-09/01	J8S, J8S 742	2068	mit Anbaumaterial	0-N913	TB [TE]	

CHEROKEE (KJ)

2.4 4WD	09/01-01/08	ED1	2429	28x146; → 09/2005	SK-1700	BTK	
2.4 Laredo	10/01-09/04	ED1	2429	28x146	SK-1700	BTK	
2.5 CRD 4WD	09/01-01/08	R 425 DOHC	2499	28x220	SK-1673	BTK	
2.8 CRD 4WD	11/02-01/08	ENR	2776	28x220	SK-1673	BTK	
2.4 4WD	09/01-01/08	ED1	2429	→ 09/2005	0-N1962	TB [DG]	
2.4 4WD, 2.4 Laredo	09/01-01/08	ED1	2429	12/2001 →	0-N1838S	TB [TE]	
2.4 Laredo	10/01-09/04	ED1	2429		0-N1962	TB [DG]	
2.5 CRD 4WD	09/01-01/08	R 425 DOHC	2499		0-N1411	TB [DG]	
2.5 CRD 4WD	09/01-01/08	R 425 DOHC	2499		0-N1612	TB [TE]	
2.8 CRD 4WD	11/02-01/08	ENR	2776		0-N1411	TB [DG]	
2.8 CRD 4WD	11/02-01/08	ENR	2776		0-N1612	TB [TE]	
2.4 4WD, 2.4 Laredo	09/01-01/08	ED1	2429		0-N2406	VB [BT]	S
2.5 CRD 4WD	09/01-01/08	R 425 DOHC	2499		0-N1423	VB [DG]	
2.5 CRD 4WD	09/01-01/08	R 425 DOHC	2499	→ 01/2004	0-N2151	VB [BT]	S
2.5 CRD 4WD	09/01-01/08	R 425 DOHC	2499	01/2004 →	0-N2203	VB [BT]	S
2.8 CRD 4WD	11/02-01/08	ENR	2776		0-N1423	VB [DG]	
2.8 CRD 4WD	11/02-01/08	ENR	2776	01/2004 →	0-N2203	VB [BT]	S
2.8 CRD 4WD	11/02-01/08	ENR	2776		0-N2261	VB [BT]	S
2.8 CRD 4WD	11/04-01/08	ENR	2776		0-N2203	VB [BT]	S

CHEROKEE (KK)

2.8 CRD 4WD	05/08-	ENS	2777	25x171; Baumuster: Liberty	SK-1734	BTK	
2.8 CRDi 4WD	01/10-	ENS	2777	25x171	SK-1734	BTK	
2.8 CRD 4WD	05/08-	ENS	2777		0-N1612	TB [TE]	
2.8 CRD 4WD, 2.8 CRDi 4WD	05/08-	ENS	2777		0-N2329	TB [TE]	
2.8 CRD 4WD, 2.8 CRDi 4WD	05/08-	ENS	2777		0-N2203	VB [BT]	S

CHEROKEE (KL)

2.0 CRD, 2.0 CRD 4x4	04/14-	EBT	1956		0-N2149	TB [DG]	
----------------------	--------	-----	------	--	---------	---------	--

COMANCHE (MJ)

2.1 D, 2.1 D 4x4	01/86-09/90	J8S-814	2068	25x148	SK-1014	BTK	
2.1 D, 2.1 D 4x4	01/86-09/90	J8S-814	2068	25x148	SK-1063	BTK	

COMMANDER (XK)

3.0 CRD	04/06-12/10	EXL	2987		0-N1560	VB [DG]	
3.0 CRD	04/06-12/10	EXL	2987		0-N1902	VB [BT]	S
3.7 V6	09/05-12/10	EKG	3701		0-N1684	VB [DG]	
3.7 V6	09/05-12/10	EKG	3701		0-N1690	VB [DG]	
3.7 V6	09/05-12/10	EKG	3701		0-N2257	VB [BT]	
3.7 V6	09/05-12/10	EKG	3701		0-N2257S1	VB [DG]	
3.7 V6	09/05-12/10	EKG	3701		0-N2257S2	VB [DG]	
4.7 V8	09/05-12/10	EVA	4701		0-N1684	VB [DG]	
4.7 V8	09/05-12/10	EVA	4701		0-N1690	VB [DG]	
4.7 V8	09/05-12/10	EVA	4701		0-N2257	VB [BT]	
4.7 V8	09/05-12/10	EVA	4701		0-N2257S1	VB [DG]	
4.7 V8	09/05-12/10	EVA	4701		0-N2257S2	VB [DG]	
5.7 V8	09/05-12/10	EZB	5654		0-N1686	VB [DG]	

COMPASS (MK49)

2.0 CRD	08/06-	ECD	1968	30x141; 02/2007 →; mit Zubehör	SK-1595	BTK	
2.0 CRD	08/06-	ECE	1968	30x141; 02/2007 →; mit Zubehör	SK-1595	BTK	
2.0 CRD 4x4	09/06-	ECE	1968	30x141; 02/2007 →; mit Zubehör	SK-1595	BTK	
2.0 CRD, 2.0 CRD 4x4	08/06-	ECD, ECE, ECE	1968	30x141; mit Zubehör	SK-1595AQ1	BTKW	
2.0 CRD	08/06-	ECD	1968		0-N1335	TB [TE]	
2.0 CRD 4x4	09/06-	ECE	1968		0-N1335	TB [TE]	
2.0 CRD, 2.0 CRD 4x4	08/06-	ECD, ECE, ECE	1968		0-N1046	TB [DG]	
2.0 CRD, 2.0 CRD 4x4	08/06-	ECD, ECE, ECE	1968		0-N1336	TB [DG]	
2.0	05/11-	ECN	1998		0-N2048	VB [DG]	
2.0	05/11-	ECN	1998		0-N2112	VB [BT]	S
2.0 CRD, 2.0 CRD 4x4	08/06-	ECD, ECE, ECE	1968		0-N2364	VB [DG]	
2.0 CRD, 2.0 CRD 4x4	08/06-	ECD, ECE, ECE	1968		0-N2397	VB [BT]	S

CM³

Art. Nr.

**COMPASS (MK49)**

2.2 CRD 4x4	12/10-	OM 651.925	2143		0-N2205	VB [DG]	
2.2 CRD 4x4	12/10-	OM 651.925	2143	für Fahrzeuge mit Start-Stopp-Funktion	0-N2422	VB [BT]	S
2.2 CRD, 2.2 CRD 4x4	12/10-	ENE, OM 651.925	2143		0-N2238	VB [DG]	
2.4, 2.4 4x4	08/06-	ED3, ERZ	2359		0-N2048	VB [DG]	
2.4, 2.4 4x4	08/06-	ED3, ERZ	2359		0-N2112	VB [BT]	S

GRAND CHEROKEE I (ZJ)

5.2	10/95-04/99	Y01	5216		0-N1839	VB [BT]	S
5.2 i	01/92-04/99	ELF	5210	09/1992 →	0-N1839	VB [BT]	S
5.2, 5.2 4WD, 5.2 i, 5.2 Limited 4x4	09/92-04/99	ELF, Y	5210		0-N1839	VB [BT]	S
5.9 i	08/97-04/99		5901		0-N1839	VB [BT]	S

GRAND CHEROKEE II (WJ, WG)

3.7 Laredo	10/04-09/05	EKG	3700		0-N1684	VB [DG]	
3.7 Laredo	10/04-09/05	EKG	3700		0-N1690	VB [DG]	
4.7	10/04-09/05	EVA	4701	→ 09/2007	0-N1684	VB [DG]	
4.7	10/04-09/05	EVA	4701	→ 09/2007	0-N1690	VB [DG]	
4.7 V8 4x4	06/03-09/05	EVA	4701	Baumuster: 2004	0-N2257	VB [BT]	
4.7 V8 4x4	06/03-09/05	EVA	4701	Baumuster: 2004	0-N2257S1	VB [DG]	
4.7 V8 4x4	06/03-09/05	EVA	4701	Baumuster: 2004	0-N2257S2	VB [DG]	
4.7 V8, 4.7 V8 4x4	04/99-09/05	EVA, EVC	4701		0-N1684	VB [DG]	
4.7 V8, 4.7 V8 4x4	04/99-09/05	EVA, EVC	4701		0-N1690	VB [DG]	
4.7, 4.7 V8	04/99-09/05	EVA, EVC	4701		0-N2257	VB [BT]	
4.7, 4.7 V8	04/99-09/05	EVA, EVC	4701		0-N2257S1	VB [DG]	
4.7, 4.7 V8	04/99-09/05	EVA, EVC	4701		0-N2257S2	VB [DG]	

GRAND CHEROKEE III (WH, WK)

3.0 CRD	06/05-12/10	EXL	2987		0-N1560	VB [DG]	
3.0 CRD	06/05-12/10	EXL	2987		0-N1902	VB [BT]	S
3.7 V6	06/05-12/10	EKG	3701		0-N1684	VB [DG]	
3.7 V6	06/05-12/10	EKG	3701		0-N1690	VB [DG]	
3.7 V6	06/05-12/10	EKG	3701		0-N2257	VB [BT]	
3.7 V6	06/05-12/10	EKG	3701		0-N2257S1	VB [DG]	
3.7 V6	06/05-12/10	EKG	3701		0-N2257S2	VB [DG]	
4.7 V8	06/05-12/10	EVA, EVA, EVE	4701		0-N2257	VB [BT]	
4.7 V8	06/05-12/10	EVA, EVA, EVE	4701		0-N2257S1	VB [DG]	
4.7 V8	06/05-12/10	EVA, EVA, EVE	4701		0-N2257S2	VB [DG]	
5.7 V8	06/05-12/10	EZB	5654		0-N1686	VB [DG]	
6.1 SRT8	03/06-12/10	ESF	6059	10/2006 →; Baumuster: 2007	0-N1686	VB [DG]	

LIBERTY [USA] Sport Utility

2.4, 2.4 4x4	01/02-12/05	ED1	2425	01/2003 →	0-N1838S	TB [TE]	
2.4, 2.4 4x4	01/02-12/05	ED1	2425		0-N2406	VB [BT]	S

PATRIOT (MK74)

2.0 CRD	02/07-	ECD	1968	30x141; mit Zubehör	SK-1595	BTK	
2.0 CRD	02/07-	ECE	1968	30x141; mit Zubehör	SK-1595	BTK	
2.0 CRD 4WD	02/07-	ECD, ECE	1968	30x141; mit Zubehör	SK-1595	BTK	
2.0 CRD, 2.0 CRD 4WD	02/07-	ECD, ECE	1968	30x141; mit Zubehör	SK-1595AQ1	BTKW	
2.0 CRD 4WD	02/07-	ECD, ECE	1968		0-N1046	TB [DG]	
2.0 CRD 4WD	02/07-	ECD	1968		0-N1335	TB [TE]	
2.0 CRD 4WD	02/07-	ECD, ECE	1968		0-N1336	TB [DG]	
2.0	01/11-	ECN	1998		0-N2048	VB [DG]	
2.0	01/11-	ECN	1998		0-N2112	VB [BT]	S
2.0 CRD, 2.0 CRD 4WD	02/07-	ECD, ECE	1968		0-N2364	VB [DG]	
2.0 CRD, 2.0 CRD 4WD	02/07-	ECD, ECE	1968		0-N2397	VB [BT]	S
2.2 CRD 4WD	01/11-	ENE	2143		0-N2238	VB [DG]	
2.4, 2.4 4WD, 2.4 Eco + 4WD	01/08-	ED3	2359		0-N2048	VB [DG]	
2.4, 2.4 4WD, 2.4 Eco + 4WD	01/08-	ED3	2359		0-N2112	VB [BT]	S

RENEGADE Geländewagen geschlossen (BU)

2.0 CRD 4x4	07/14-	EBT	1956	24x199	SK-1586	BTK	
1.6 CRD	07/14-	EJK	1598		0-N2149	TB [DG]	
2.0 CRD 4x4	07/14-	EBT	1956		0-N2149	TB [DG]	

WRANGLER [USA] Sport Utility

2.4 X	01/03-12/06		2425	01/2003 →	0-N1838S	TB [TE]	
2.4 X	01/03-12/06		2425		0-N2406	VB [BT]	S



CM³



Art. Nr.



ohne Halter

WRANGLER II (TJ)

2.4	11/02-04/07	ED1	2429	28x146	SK-1700	BTK	
2.8 CRDi	11/06-04/07	ENS	2776	25x171	SK-1734	BTK	
2.4	11/02-04/07	ED1	2429		0-N1838S	TB [TE]	
2.4	11/02-04/07	ED1	2429		0-N1962	TB [DG]	
2.8 CRDi	11/06-04/07	ENS	2776		0-N1612	TB [TE]	
2.8 CRDi	11/06-04/07	ENS	2776		0-N2329	TB [TE]	
2.4	11/02-04/07	ED1	2429	*	0-N1695	VB [DG]	
2.4	11/02-04/07	ED1	2429		0-N2406	VB [BT]	S
2.8 CRDi	11/06-04/07	ENS	2776		0-N2203	VB [BT]	S

WRANGLER III (JK)

2.8 CRD	04/07-	ENS	2777	25x171	SK-1734	BTK	
2.8 CRD	11/10-	ENS	2776	25x171	SK-1734	BTK	
2.8 CRD	04/07-	ENS	2777		0-N1612	TB [TE]	
2.8 CRD	04/07-	ENS	2777		0-N2329	TB [TE]	
2.8 CRD	11/10-	ENS	2776		0-N1612	TB [TE]	
2.8 CRD	11/10-	ENS	2776		0-N2329	TB [TE]	
2.8 CRD	04/07-	ENS	2777		0-N2203	VB [BT]	S
2.8 CRD	11/10-	ENS	2776		0-N2203	VB [BT]	S
3.6 V6	10/11-	ERB	3604		0-N2048	VB [DG]	

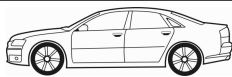
CM³

Art. Nr.



AVELLA								
1.3	11/95-12/01	B3	1324	22x107		SK-1225	BTK	
1.5	02/97-12/01		1498	22x107		SK-1225	BTK	
AVELLA Schrägheck								
1.5	02/97-12/01		1498	22x107		SK-1225	BTK	
BESTA Kasten								
2.2 D	02/96-12/03	R2	2184	25x164		SK-1302	BTK	
2.2 D	02/96-12/03	R2	2184			0-N092	TB [TE]	
BONGO Bus								
2.4 TDCi	10/03-	D4BH	2477	25.4x163; 19x99		SK-1306	BTK	
2.9 TDiC	10/03-	HJ3	2902	30x152		SK-1716	BTK	
BONGO Großraumlimousine								
2.4 TDCi	10/03-	D4BH	2477	25.4x163; 19x99		SK-1306	BTK	
2.9 TDiC, 2.9 TDiC 4WD	10/03-	HJ3	2902	30x152		SK-1716	BTK	
BONGO Pritsche/Fahrgestell								
2.4 TDCi	10/03-	D4BH	2477	25.4x163; 19x99		SK-1306	BTK	
2.9 TDiC, 2.9 TDiC 4WD	10/03-	HJ3	2902	30x152		SK-1716	BTK	
BORREGO								
3.8 4WD	06/08-	G6DA	3778			0-N1990	VB [DG]	
CADENZA								
2.7	01/10-	G6BA	2656	32x207		SK-1669AQ1	BTKW	
2.4 GDI	01/10-	G4KC	2359			0-N2021	VB [DG]	
2.7	01/10-	G6BA	2656			0-N1678	VB [DG]	
3.5 CVVT	01/10-	G6DC	3470			0-N1990	VB [DG]	
CARENS I (FC)								
1.8 i	11/00-07/02	T8	1793	22x154		SK-1444	BTK	
1.8 i	11/00-07/02	T8	1793			0-N070	TB [DG]	
1.8 i	11/00-07/02	T8	1793			0-N1373	TB [TE]	
CARENS II (FJ)								
1.6	07/02-	GA6D	1594	22x137		SK-1652	BTK	
1.8	07/02-	TB	1793	22x154		SK-1444	BTK	
2.0 CRDi	07/02-	D4EA	1991	28x123		SK-1654	BTK	
2.0 CRDi	07/02-	D4EA	1991	28x123; → 05/2005		SK-1654AQ1	BTKW	
2.0 CRDi	07/02-	D4EA	1991	28x123; 05/2005 →		SK-1654AQ2	BTKW	
2.0 CRDi	11/05-	D4EA	1991	28x123; 05/2006 →		SK-1654	BTK	
2.0 CRDi	11/05-	D4EA	1991	28x123		SK-1654AQ2	BTKW	
2.0 CVVT	08/04-	G4GC	1975	25.4x113; → 04/2006		SK-1651	BTK	
2.0 CVVT	08/04-	G4GC	1975	25x113		SK-1656	BTK	
2.0 CVVT	08/04-	G4GC	1975	25.4x113; 05/2006 →		SK-1684	BTK	
1.6	07/02-	GA6D	1594			0-N069	TB [TE]	
1.6	07/02-	GA6D	1594			0-N070	TB [DG]	
1.8	07/02-	TB	1793			0-N070	TB [DG]	
1.8	07/02-	TB	1793			0-N1373	TB [TE]	
2.0 CRDi	07/02-	D4EA	1991			0-N1499	TB [BT]	S
2.0 CRDi	07/02-	D4EA	1991			0-N1500	TB [DG]	
2.0 CVVT	08/04-	G4GC	1975			0-N1374	TB [DG]	
2.0 CVVT	08/04-	G4GC	1975	→ 05/2006		0-N1561	TB [TE]	
2.0 CVVT	08/04-	G4GC	1975	05/2006 →		0-N1619	TB [TE]	
2.0 CRDi	07/02-	D4EA	1991			0-N1547	VB [DG]	
2.0 CRDi	07/02-	D4EA	1991	→ 08/2006;		0-N1814	VB [DG]	
2.0 CRDi	07/02-	D4EA	1991			0-N1815	VB [BT]	S
CARENS III (UN)								
2.0 CRDi 115, 2.0 CRDi 135, 2.0 CRDi 140	09/06-	D4EA	1991	28x123		SK-1654	BTK	
2.0 CRDi 115, 2.0 CRDi 135, 2.0 CRDi 140	09/06-	D4EA	1991	28x123		SK-1654AQ2	BTKW	
2.0 CRDi 115, 2.0 CRDi 135, 2.0 CRDi 140	09/06-	D4EA	1991			0-N1499	TB [BT]	S
2.0 CRDi 115, 2.0 CRDi 135, 2.0 CRDi 140	09/06-	D4EA	1991			0-N1500	TB [DG]	
1.6 CRDi 110, 1.6 CRDi 128	10/10-	D4FB	1582			0-N1813	VB [BT]	S
1.6 CRDi 110, 1.6 CRDi 128	10/10-	D4FB	1582	für Fahrzeuge mit Start-Stopp-Funktion		0-N2214	VB [BT]	S
1.6 CRDi 110, 1.6 CRDi 128	10/10-	D4FB	1582	Rippenanzahl: 5		0-N2375	VB [DG]	
1.6 CRDi 110, 1.6 CRDi 128	10/10-	D4FB	1582			0-N2429	VB [DG]	
1.6 CVVT	08/09-	G4FC	1591			0-N1987	VB [DG]	
1.6 CVVT	08/09-	G4FC	1591			0-N2202	VB [BT]	S

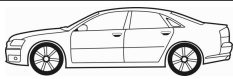

CM³



Art. Nr.



CARENS III (UN)

2.0 CRDi 115, 2.0 CRDi 135, 2.0 CRDi 140	09/06-	D4EA	1991		0-N1547	VB [DG]	
2.0 CRDi 115, 2.0 CRDi 135, 2.0 CRDi 140	09/06-	D4EA	1991	✳	0-N1814	VB [DG]	
2.0 CRDi 115, 2.0 CRDi 135, 2.0 CRDi 140	09/06-	D4EA	1991		0-N1815	VB [BT]	S
2.0 CVVT	09/06-	G4KA	1998		0-N2021	VB [DG]	
2.0 CVVT	09/06-	G4KA	1998		0-N2108	VB [BT]	S

CARENS IV

1.6	03/13-	G4FD	1591		0-N1987	VB [DG]	
1.7 CRDi	03/13-	D4FD-L	1685		0-N1813	VB [BT]	S
1.7 CRDi	03/13-	D4FD-L	1685	für Fahrzeuge mit Start-Stopp-Funktion	0-N2214	VB [BT]	S
1.7 CRDi	03/13-	D4FD-L	1685	Rippenanzahl: 5	0-N2375	VB [DG]	
1.7 CRDi	03/13-	D4FD-L	1685		0-N2429	VB [DG]	

CARNIVAL I (UP)

2.5 i, 2.5 V6	08/99-10/01	KRV6, KV6	2497	28x176; 22x59	SK-1672	BTK	
2.9 TD	08/99-10/01	J3	2903	30x152; 07/2000 →	SK-1716	BTK	
2.5 V6	08/99-10/01	KRV6	2497		0-N1579	TB [TE]	
2.5 V6	08/99-10/01	KRV6	2497		0-N1580	TB [TE]	
2.5 V6	08/99-10/01	KRV6	2497		0-N1581	TB [TE]	
2.5 V6	08/99-10/01	KRV6	2497		0-N1582	TB [DG]	
2.5 V6	08/99-10/01	KRV6	2497		0-N1826	TB [BT]	
2.9 TD	08/99-10/01	J3	2903		0-N1375	TB [DG]	
2.9 TD	08/99-10/01	J3	2903		0-N1376	TB [DG]	
2.9 TD	08/99-10/01	J3	2903		0-N1550	TB [DG]	
2.9 TD	08/99-10/01	J3	2903	→ 06/2000	0-N1759	TB [BT]	
2.9 TD	08/99-10/01	J3	2903	06/2000 →	0-N1760	TB [TE]	
2.9 TD	08/99-10/01	J3	2903	→ 06/2000	0-N1769	TB [BT]	
2.5 i, 2.5 V6	08/99-10/01	KRV6, KV6	2497		0-N1855	VB [BT]	S
2.5 i, 2.5 V6	08/99-10/01	KRV6, KV6	2497		0-N1856	VB [BT]	S
2.9 TD	08/99-10/01	J3	2903		0-N1389	VB [DG]	
2.9 TD	08/99-10/01	J3	2903	07/2000 →	0-N1467S	VB [TE]	
2.9 TD	08/99-10/01	J3	2903	→ 06/2000	0-N1551	VB [TE]	S
2.9 TD	08/99-10/01	J3	2903		0-N1988	VB [DG]	

CARNIVAL II (GQ)

2.4	12/01-10/06		2351	28x176; 22x59; → 11/2005	SK-1672	BTK	
2.5 V6	10/01-	K5	2497	28x176; 22x59; → 11/2005	SK-1672	BTK	
2.7	07/04-10/06		2656	32x207	SK-1669AQ1	BTKW	
2.9 CRDi	10/01-	J3	2902	30x152	SK-1716	BTK	
2.9 TD	01/99-	J3	2903	30x152; 06/2000 →	SK-1716	BTK	
2.5 V6	10/01-	K5	2497		0-N1579	TB [TE]	
2.5 V6	10/01-	K5	2497		0-N1580	TB [TE]	
2.5 V6	10/01-	K5	2497		0-N1581	TB [TE]	
2.5 V6	10/01-	K5	2497		0-N1582	TB [DG]	
2.5 V6	10/01-	K5	2497		0-N1826	TB [BT]	
2.9 CRDi	10/01-	J3	2902		0-N1375	TB [DG]	
2.9 CRDi	10/01-	J3	2902		0-N1376	TB [DG]	
2.9 CRDi	10/01-	J3	2902		0-N1550	TB [DG]	
2.9 CRDi	10/01-	J3	2902		0-N1760	TB [TE]	
2.9 TD	01/99-	J3	2903		0-N1375	TB [DG]	
2.9 TD	01/99-	J3	2903		0-N1376	TB [DG]	
2.9 TD	01/99-	J3	2903		0-N1550	TB [DG]	
2.9 TD	01/99-	J3	2903		0-N1760	TB [TE]	
3.5	07/02-	G6CU	3497		0-N185	TB [TE]	
3.5	07/02-	G6CU	3497		0-N189	TB [DG]	
2.5 V6	10/01-	K5	2497		0-N1855	VB [BT]	S
2.5 V6	10/01-	K5	2497		0-N1856	VB [BT]	S
2.7	07/04-10/06		2656		0-N1678	VB [DG]	
2.9 CRDi	10/01-	J3	2902		0-N1389	VB [DG]	
2.9 CRDi	10/01-	J3	2902		0-N1467S	VB [TE]	
2.9 CRDi	10/01-	J3	2902		0-N1988	VB [DG]	

CARNIVAL / GRAND CARNIVAL III (VQ)

2.7 V6	06/06-	G6EA	2656	32x219	SK-1739	BTK	
2.7 V6	06/06-	G6EA	2656	32x219; mit Spanndämpfer, Spannrolle	SK-1740	BTK	
2.7 V6	06/06-	G6EA	2656		0-N1576	TB [TE]	
2.7 V6	06/06-	G6EA	2656		0-N2326	TB [TE]	
2.7 V6	06/06-	G6EA	2656		0-N2416	TB [VD]	



CM³



Art. Nr.



CARNIVAL / GRAND CARNIVAL III (VQ)

2.9 CRDi, 2.9 CRDi LX	06/06-	J3	2902		0-N1375	TB [DG]	
2.9 CRDi, 2.9 CRDi LX	06/06-	J3	2902		0-N1376	TB [DG]	
2.9 CRDi, 2.9 CRDi LX	06/06-	J3	2902		0-N1550	TB [DG]	
2.9 CRDi, 2.9 CRDi LX	06/06-	J3	2902		0-N1760	TB [TE]	
2.2 CRDi	01/10-	D4HB	2199		0-N2247	VB [BT]	S
2.2 CRDi	01/10-	D4HB	2199		0-N2248	VB [DG]	
2.2 CRDi	01/10-	D4HB	2199		0-N2249	VB [DG]	
2.2 CRDi	01/10-	D4HB	2199	Rippenanzahl: 6	0-N2377	VB [DG]	
2.7 V6	06/06-	G6EA	2656		0-N2231	VB [BT]	S
2.9 CRDi	06/06-	J3	2902		0-N1389	VB [DG]	
2.9 CRDi	06/06-	J3	2902		0-N1467S	VB [TE]	

CEE'D Schrägheck (ED)

2.0	12/06-12/12	G4GC	1975	25.4x113	SK-1684	BTK	
2.0 CRDi, 2.0 CRDi 140	06/07-12/12	D4EA, D4EA-F	1991	28x123	SK-1654	BTK	
2.0 CRDi, 2.0 CRDi 140	06/07-12/12	D4EA, D4EA-F	1991	28x123	SK-1654AQ2	BTKW	
2.0	12/06-12/12	G4GC	1975		0-N1374	TB [DG]	
2.0	12/06-12/12	G4GC	1975		0-N1619	TB [TE]	
2.0 CRDi 140	09/07-12/12	D4EA-F	1991		0-N1499	TB [BT]	S
2.0 CRDi 140	09/07-12/12	D4EA-F	1991		0-N1500	TB [DG]	
1.4, 1.4 CVVT	12/06-12/12	G4FA, G4FA-L	1396		0-N1987	VB [DG]	
1.4, 1.4 CVVT	12/06-12/12	G4FA, G4FA-L	1396		0-N2202	VB [BT]	S
1.6 CRDi 115, 1.6 CRDi 128, 1.6 CRDi 90	12/06-12/12	D4FB, D4FB-L	1582		0-N1813	VB [BT]	S
1.6 CRDi 115, 1.6 CRDi 128, 1.6 CRDi 90	12/06-12/12	D4FB, D4FB-L	1582	für Fahrzeuge mit Start-Stopp-Funktion	0-N2214	VB [BT]	S
1.6 CRDi 115, 1.6 CRDi 128, 1.6 CRDi 90	12/06-12/12	D4FB, D4FB-L	1582	Rippenanzahl: 5	0-N2375	VB [DG]	
1.6 CRDi 115, 1.6 CRDi 128, 1.6 CRDi 90	12/06-12/12	D4FB, D4FB-L	1582		0-N2429	VB [DG]	
1.6, 1.6 CVVT	12/06-12/12	G4FC	1591		0-N1987	VB [DG]	
1.6, 1.6 CVVT	12/06-12/12	G4FC	1591		0-N2202	VB [BT]	S
2.0 CRDi 140	09/07-12/12	D4EA-F	1991	☞	0-N1814	VB [DG]	
2.0 CRDi 140	09/07-12/12	D4EA-F	1991		0-N1815	VB [BT]	S

CEE'D SW (ED)

2.0	09/07-12/12	G4GC	1975	25.4x113	SK-1684	BTK	
2.0 CRDi 140	09/07-12/12	D4EA-F	1991	28x123	SK-1654	BTK	
2.0 CRDi 140	09/07-12/12	D4EA-F	1991	28x123	SK-1654AQ2	BTKW	
2.0	09/07-12/12	G4GC	1975		0-N1374	TB [DG]	
2.0	09/07-12/12	G4GC	1975		0-N1619	TB [TE]	
2.0 CRDi 140	09/07-12/12	D4EA-F	1991		0-N1499	TB [BT]	S
2.0 CRDi 140	09/07-12/12	D4EA-F	1991		0-N1500	TB [DG]	
1.4, 1.4 CVVT	09/07-12/12	G4FA, G4FA-L	1396		0-N1987	VB [DG]	
1.4, 1.4 CVVT	09/07-12/12	G4FA, G4FA-L	1396		0-N2202	VB [BT]	S
1.6 CRDi 115, 1.6 CRDi 128, 1.6 CRDi 90	09/07-12/12	D4FB, D4FB-L	1582		0-N1813	VB [BT]	S
1.6 CRDi 115, 1.6 CRDi 128, 1.6 CRDi 90	09/07-12/12	D4FB, D4FB-L	1582	für Fahrzeuge mit Start-Stopp-Funktion	0-N2214	VB [BT]	S
1.6 CRDi 115, 1.6 CRDi 128, 1.6 CRDi 90	09/07-12/12	D4FB, D4FB-L	1582	Rippenanzahl: 5	0-N2375	VB [DG]	
1.6 CRDi 115, 1.6 CRDi 128, 1.6 CRDi 90	09/07-12/12	D4FB, D4FB-L	1582		0-N2429	VB [DG]	
1.6, 1.6 CVVT	09/07-12/12	G4FC	1591		0-N1987	VB [DG]	
1.6, 1.6 CVVT	09/07-12/12	G4FC	1591		0-N2202	VB [BT]	S
2.0 CRDi 140	09/07-12/12	D4EA-F	1991	☞	0-N1814	VB [DG]	
2.0 CRDi 140	09/07-12/12	D4EA-F	1991		0-N1815	VB [BT]	S

CEE'D (JD)

1.4 CRDi 90	05/12-	D4FC	1396		0-N1813	VB [BT]	S
1.4 CRDi 90	05/12-	D4FC	1396	für Fahrzeuge mit Start-Stopp-Funktion	0-N2214	VB [BT]	S
1.4 CRDi 90	05/12-	D4FC	1396	Rippenanzahl: 5	0-N2375	VB [DG]	
1.4 CRDi 90	05/12-	D4FC	1396		0-N2429	VB [DG]	
1.4 CVVT	05/12-	G4FA-L	1396		0-N1987	VB [DG]	
1.6 CRDi 110, 1.6 CRDi 115, 1.6 CRDi 128, 1.6 CRDi 136, 1.6 CRDi 90	05/12-	D4FB, D4FB-L	1582	für Fahrzeuge mit Start-Stopp-Funktion	0-N2214	VB [BT]	S
1.6 CRDi 110, 1.6 CRDi 115, 1.6 CRDi 128, 1.6 CRDi 136, 1.6 CRDi 90	05/12-	D4FB, D4FB-L	1582		0-N2429	VB [DG]	
1.6 CRDi 110, 1.6 CRDi 115, 1.6 CRDi 128, 1.6 CRDi 90	05/12-	D4FB, D4FB-L	1582		0-N1813	VB [BT]	S
1.6 CRDi 110, 1.6 CRDi 115, 1.6 CRDi 128, 1.6 CRDi 90	05/12-	D4FB, D4FB-L	1582	Rippenanzahl: 5	0-N2375	VB [DG]	
1.6 CVVT, 1.6 GDI, 1.6 GT	05/12-	G4FC, G4FD, G4FJ	1591		0-N1987	VB [DG]	

CEE'D Sportswagon (JD)

1.4 CRDi	09/12-	D4FC	1396		0-N1813	VB [BT]	S
1.4 CRDi	09/12-	D4FC	1396	für Fahrzeuge mit Start-Stopp-Funktion	0-N2214	VB [BT]	S

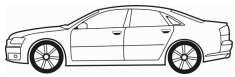

CM³



Art. Nr.



CEE'D Sportswagon (JD)

1.4 CRDi	09/12-	D4FC	1396	Rippenanzahl: 5	0-N2375	VB [DG]	
1.4 CRDi	09/12-	D4FC	1396		0-N2429	VB [DG]	
1.4 CVVT	09/12-	G4FA-L	1396		0-N1987	VB [DG]	
1.6 CRDi	09/12-	D4FB	1582		0-N1813	VB [BT]	S
1.6 CRDi	09/12-	D4FB	1582	Rippenanzahl: 5	0-N2375	VB [DG]	
1.6 CRDi, 1.6 CRDi 136	09/12-	D4FB	1582	für Fahrzeuge mit Start-Stopp-Funktion	0-N2214	VB [BT]	S
1.6 CRDi, 1.6 CRDi 136	09/12-	D4FB	1582		0-N2429	VB [DG]	
1.6 GDI	09/12-	G4FD	1591		0-N1987	VB [DG]	

CERATO (LD)

1.6	07/04-	G4ED	1599	22x105	SK-1634	BTK	
1.6	07/04-	G4ED	1599	22x105	SK-1634AQ1	BTKW	
2.0	04/04-	G4GC	1975	25.4x113	SK-1651	BTK	
2.0	04/04-	G4GC	1975	25x113; → 04/2006	SK-1656	BTK	
2.0	04/04-	G4GC	1975	25.4x113; 05/2006 →	SK-1684	BTK	
2.0 CRDi	04/04-	D4EA	1991	28x123	SK-1654	BTK	
2.0 CRDi	04/04-	D4EA	1991	28x123; → 05/2005	SK-1654AQ1	BTKW	
2.0 CRDi	04/04-	D4EA	1991	28x123; 05/2005 →	SK-1654AQ2	BTKW	
1.6	07/04-	G4ED	1599		0-N1370	TB [DG]	
1.6	07/04-	G4ED	1599		0-N975	TB [TE]	
1.8	08/05-	G4GB	1795		0-N1374	TB [DG]	
1.8	08/05-	G4GB	1795	05/2006 →	0-N1619	TB [TE]	
2.0	04/04-	G4GC	1975		0-N1374	TB [DG]	
2.0	04/04-	G4GC	1975	→ 05/2006	0-N1561	TB [TE]	
2.0	04/04-	G4GC	1975	05/2006 →	0-N1619	TB [TE]	
2.0 CRDi	04/04-	D4EA	1991		0-N1499	TB [BT]	S
2.0 CRDi	04/04-	D4EA	1991		0-N1500	TB [DG]	
1.5 CRDi	07/05-	D4FA	1493		0-N1813	VB [BT]	S
1.5 CRDi	07/05-	D4FA	1493	Rippenanzahl: 5	0-N2375	VB [DG]	
1.5 CRDi	07/05-	D4FA	1493		0-N2429	VB [DG]	
1.6	07/04-	G4ED	1599		0-N1854	VB [BT]	
1.6	05/06-	G4FC	1591		0-N1987	VB [DG]	
1.6	05/06-	G4FC	1591		0-N2202	VB [BT]	S
1.6 CRDi	06/05-	D4FB	1582		0-N1813	VB [BT]	S
1.6 CRDi	06/05-	D4FB	1582	Rippenanzahl: 5	0-N2375	VB [DG]	
1.6 CRDi	06/05-	D4FB	1582		0-N2429	VB [DG]	
2.0	04/04-	G4GC	1975		0-N2021	VB [DG]	
2.0 CRDi	04/04-	D4EA	1991		0-N1547	VB [DG]	
2.0 CRDi	04/04-	D4EA	1991	✳	0-N1814	VB [DG]	
2.0 CRDi	04/04-	D4EA	1991		0-N1815	VB [BT]	S

CERATO Stufenheck (LD)

1.6	04/04-	G4ED	1599	22x105	SK-1634	BTK	
1.6	04/04-	G4ED	1599	22x105	SK-1634AQ1	BTKW	
2.0	04/04-	G4GC	1975	25.4x113	SK-1651	BTK	
2.0	04/04-	G4GC	1975	25x113; → 04/2006	SK-1656	BTK	
2.0	04/04-	G4GC	1975	25.4x113; 05/2006 →	SK-1684	BTK	
2.0 CRDi	04/04-	D4EA	1991	28x123	SK-1654	BTK	
2.0 CRDi	04/04-	D4EA	1991	28x123; → 05/2005	SK-1654AQ1	BTKW	
2.0 CRDi	04/04-	D4EA	1991	28x123; 05/2005 →	SK-1654AQ2	BTKW	
1.6	04/04-	G4ED	1599		0-N1370	TB [DG]	
1.6	04/04-	G4ED	1599		0-N975	TB [TE]	
1.8 CVVT	05/05-	G4GB	1795		0-N1374	TB [DG]	
1.8 CVVT	05/05-	G4GB	1795	05/2006 →	0-N1619	TB [TE]	
2.0	04/04-	G4GC	1975		0-N1374	TB [DG]	
2.0	04/04-	G4GC	1975	→ 05/2006	0-N1561	TB [TE]	
2.0	04/04-	G4GC	1975	05/2006 →	0-N1619	TB [TE]	
2.0 CRDi	04/04-	D4EA	1991		0-N1499	TB [BT]	S
2.0 CRDi	04/04-	D4EA	1991		0-N1500	TB [DG]	
1.5 CRDi	07/05-	D4FA	1493		0-N1813	VB [BT]	S
1.5 CRDi	07/05-	D4FA	1493	Rippenanzahl: 5	0-N2375	VB [DG]	
1.5 CRDi	07/05-	D4FA	1493		0-N2429	VB [DG]	
1.6	04/04-	G4ED	1599		0-N1854	VB [BT]	
1.6	05/06-	G4FC	1591		0-N1987	VB [DG]	
1.6	05/06-	G4FC	1591		0-N2202	VB [BT]	S
1.6 CRDi	06/05-	D4FB	1582		0-N1813	VB [BT]	S

CM³

Art. Nr.

**CERATO Stufenheck (LD)**

1.6 CRDi	06/05-	D4FB	1582	Rippenanzahl: 5	0-N2375	VB [DG]	
1.6 CRDi	06/05-	D4FB	1582		0-N2429	VB [DG]	
2.0	04/04-	G4GC	1975		0-N2021	VB [DG]	
2.0 CRDi	04/04-	D4EA	1991		0-N1547	VB [DG]	
2.0 CRDi	04/04-	D4EA	1991	☞	0-N1814	VB [DG]	
2.0 CRDi	04/04-	D4EA	1991		0-N1815	VB [BT]	S

CERATO II Stufenheck (TD)

1.6 CVVT	02/09-	G4FC	1591		0-N2202	VB [BT]	S
1.6, 1.6 CVVT	02/09-	G4FC	1591		0-N1987	VB [DG]	
2.0	01/09-	G4KD	1998		0-N2021	VB [DG]	
2.0	01/09-	G4KD	1998		0-N2108	VB [BT]	S

CERATO KOUP (TD)

1.6 CVVT	10/09-	G4FC, G4FJ	1591		0-N1987	VB [DG]	
1.6 CVVT	10/09-	G4FC	1591		0-N2202	VB [BT]	S
2.0	01/09-	G4KD	1998		0-N2021	VB [DG]	

CERATO Stufenheck

1.6 MPI	06/13-	G4FC	1591		0-N1987	VB [DG]	
1.6 VGT	09/12-	D4FB	1582		0-N1813	VB [BT]	S
1.6 VGT	09/12-	D4FB	1582	Rippenanzahl: 5	0-N2375	VB [DG]	
1.6 VGT	09/12-	D4FB	1582		0-N2429	VB [DG]	

CLARUS (K9A)

1.8 i 16V	07/96-	T8	1793	22x154	SK-1444	BTK	
2.0 i 16V	07/96-	FE (16V)	1998	25x168	SK-1231	BTK	
1.8 i 16V	07/96-	T8	1793		0-N070	TB [DG]	
1.8 i 16V	07/96-	T8	1793		0-N072	TB [TE]	
1.8 i 16V	07/96-	T8	1793		0-N1373	TB [TE]	
2.0 i 16V	07/96-	FE (16V)	1998		0-N073	TB [TE]	
2.0 i 16V	07/96-	FE (16V)	1998		0-N075	TB [DG]	

CLARUS Kombi (GC)

1.8 i 16V	05/98-	T8	1793	22x154; 03/1999 →	SK-1444	BTK	
2.0 i 16V	05/98-	FE (16V)	1998	25x168; 03/1999 →	SK-1231	BTK	
1.8 i 16V	05/98-	T8	1793		0-N070	TB [DG]	
1.8 i 16V	05/98-	T8	1793		0-N072	TB [TE]	
1.8 i 16V	05/98-	T8	1793		0-N1373	TB [TE]	
2.0 i 16V	05/98-	FE (16V)	1998		0-N073	TB [TE]	
2.0 i 16V	05/98-	FE (16V)	1998		0-N075	TB [DG]	

CONCORD Stufenheck

2.0	10/91-02/97		1991	25x135; mit Zubehör	SK-1221	BTK	
-----	-------------	--	------	---------------------	---------	-----	--

JOICE

2.0	02/00-	G4CP	1997		0-N073	TB [TE]	
2.0	02/00-	G4CP	1997		0-N075	TB [DG]	

K2500 (SD)

2.5 D	01/03-	D4BH	2476	25.4x163; 19x99; → 10/2003	SK-1306	BTK	
2.5 D	01/03-	D4BH	2476		0-N061	TB [TE]	
2.5 D	01/03-	D4BH	2476		0-N184	TB [TE]	

K2900

2.9 D	01/08-	J3	2902	30x152; → 03/2010	SK-1716	BTK	
-------	--------	----	------	-------------------	---------	-----	--

MAGENTIS (GD)

2.0	05/01-	G4JP	1997	29x173; 12.7x65	SK-1653	BTK	
2.0	05/01-	G4JP	1997	12.7x65; 29x173; mit Spanndämpfer, Spannrolle; Baumuster: Magentis	SK-1746	BTK	
2.0	05/01-	G4JP	1997	12.7x65; 29x173; mit Spanndämpfer, Spannrolle; Baumuster: Optima	SK-1746	BTK	
2.5 V6	05/01-	G6BV	2493	32x207	SK-1669	BTK	
2.5 V6	05/01-	G6BV	2493	32x207	SK-1669AQ1	BTKW	
2.5 V6	05/01-	G6BV	2493	32x207; mit Spanndämpfer, Spannrolle; Baumuster: Magentis	SK-1749	BTK	
2.5 V6	05/01-	G6BV	2493	32x207; mit Spanndämpfer, Spannrolle; Baumuster: Optima	SK-1749	BTK	
2.7 V6	04/04-	G6BA	2656	32x207	SK-1669AQ1	BTKW	
2.0	05/01-	G4JP	1997		0-N055	TB [DG]	
2.0	05/01-	G4JP	1997		0-N1127	TB [TE]	
2.0	05/01-	G4JP	1997		0-N1498	TB [TE]	

CM³

Art. Nr.



MAGENTIS (GD)							
2.5 V6	05/01-	G6BV	2493		0-N1576	TB [TE]	
2.5 V6	05/01-	G6BV	2493		0-N1577	TB [DG]	
2.5 V6	05/01-	G6BV	2493	→ 09/2005; Spannrollenbetätigung: hydraulisch	0-N2428	TB [VD]	
2.5 V6	05/01-	G6BV	2493		0-N1677	VB [BT]	S
2.5 V6	05/01-	G6BV	2493		0-N1678	VB [DG]	
2.7 V6	04/04-	G6BA	2656		0-N1677	VB [BT]	S
2.7 V6	04/04-	G6BA	2656		0-N1678	VB [DG]	

MAGENTIS (MG)							
2.0 CRDi	11/05-12/08	D4EA	1991	28x123	SK-1654	BTK	
2.0 CRDi	11/05-12/08	D4EA	1991	28x123	SK-1654AQ2	BTKW	
2.0 CRDi	04/06-	D4EA	1991	28x123; 07/2009 →	SK-1654	BTK	
2.7, 2.7 V6	11/05-	G6EA	2656	32x219	SK-1739	BTK	
2.7, 2.7 V6	11/05-	G6EA	2656	32x219; mit Spanndämpfer, Spannrolle	SK-1740	BTK	
2.0 CRDi	11/05-12/08	D4EA	1991		0-N1499	TB [BT]	S
2.0 CRDi	11/05-12/08	D4EA	1991		0-N1500	TB [DG]	
2.7, 2.7 V6	11/05-	G6EA	2656		0-N1576	TB [TE]	
2.7, 2.7 V6	11/05-	G6EA	2656		0-N2326	TB [TE]	
2.7, 2.7 V6	11/05-	G6EA	2656		0-N2416	TB [VD]	
2.0	11/05-	G4KA, G4KD	1998		0-N2021	VB [DG]	
2.0	11/05-	G4KA, G4KD	1998		0-N2108	VB [BT]	S
2.0 CRDi	11/05-12/08	D4EA	1991		0-N1547	VB [DG]	
2.0 CRDi	11/05-12/08	D4EA	1991		0-N1815	VB [BT]	S
2.0 CRDi	04/06-	D4EA	1991	*	0-N1814	VB [DG]	
2.7, 2.7 V6	11/05-	G6EA	2656		0-N2231	VB [BT]	S

OPIRUS (GH)							
2.7	10/03-09/06	G6BA	2656	32x207	SK-1669AQ1	BTKW	
3.5	09/03-	G6CU	3497	32x259; → 09/2006	SK-1718	BTK	
2.7	10/06-	G6EA	2656		0-N2326	TB [TE]	
2.7	10/06-	G6EA	2656		0-N2416	TB [VD]	
3.5	09/03-	G6CU	3497		0-N185	TB [TE]	
3.5	09/03-	G6CU	3497		0-N189	TB [DG]	
2.7	10/03-09/06	G6BA	2656		0-N1677	VB [BT]	S
2.7	10/03-09/06	G6BA	2656		0-N1678	VB [DG]	
2.7	10/06-	G6EA	2656		0-N2231	VB [BT]	S
3.8 V6	10/06-	G6DA	3778		0-N1990	VB [DG]	
3.8 V6	10/06-	G6DA	3778		0-N2250	VB [BT]	S

OPTIMA							
1.7 CRDi	03/12-	D4FD-L	1685		0-N1813	VB [BT]	S
1.7 CRDi	03/12-	D4FD-L	1685	für Fahrzeuge mit Start-Stopp-Funktion	0-N2214	VB [BT]	S
1.7 CRDi	03/12-	D4FD-L	1685	Rippenanzahl: 5	0-N2375	VB [DG]	
1.7 CRDi	03/12-	D4FD-L	1685		0-N2429	VB [DG]	
2.0	09/10-		1998		0-N2021	VB [DG]	
2.0, 2.0 CVVL, 2.0 CVVT Hybrid	03/12-	G4KD	1999		0-N2021	VB [DG]	
2.4, 2.4 Hybrid	09/10-	G4KJ	2359		0-N2021	VB [DG]	

PICANTO (BA)							
1.0	04/04-	G4HE	999	20x101	SK-1626	BTK	
1.1	04/04-	G4HG	1086	20x101	SK-1626	BTK	
1.0	04/04-	G4HE	999		0-N1366	TB [TE]	
1.1	04/04-	G4HG	1086		0-N1366	TB [TE]	
1.1 CRDi	11/05-	D3FA	1120		0-N1813	VB [BT]	S
1.1 CRDi	11/05-	D3FA	1120	Rippenanzahl: 5	0-N2375	VB [DG]	
1.1 CRDi	11/05-	D3FA	1120		0-N2429	VB [DG]	

PREGIO Bus							
2.5 D	08/95-09/04	D4BH	2477	25.4x163; 19x99; 08/1996 →	SK-1306	BTK	
2.5 D	08/95-09/04	D4BH	2477		0-N061	TB [TE]	
2.5 D	08/95-09/04	D4BH	2477		0-N184	TB [TE]	

PREGIO Kasten (TB)							
2.5 Tci D	09/02-	D4BH	2476	25.4x163; 19x99; → 10/2005	SK-1306	BTK	
2.5 Tci D	09/02-	D4BH	2476		0-N061	TB [TE]	
2.5 Tci D	09/02-	D4BH	2476		0-N184	TB [TE]	

PRIDE (DA)							
1.1 i	01/91-	B1	1138	22x107	SK-1225	BTK	

CM³

Art. Nr.

**PRIDE (DA)**

1.3 16V	01/90-	B3	1324	22x107; 06/1990 →	SK-1225	BTK	
1.3, 1.3 16V	01/90-05/97	B3	1324	22x107	SK-1225	BTK	
1.1 i	01/91-	B1	1138		0-N983	TB [TE]	
1.3 16V, 1.3 i	01/90-	B3	1324		0-N983	TB [TE]	
1.4 LX	03/05-	G4EE	1399		0-N1370	TB [DG]	
1.4 LX	03/05-	G4EE	1399		0-N975	TB [TE]	
1.6 CVVT LX	03/05-	G4ED	1599		0-N1370	TB [DG]	
1.6 CVVT LX	03/05-	G4ED	1599		0-N975	TB [TE]	
1.4 LX	03/05-	G4EE	1399		0-N1854	VB [BT]	
1.5 CRDi LX	03/05-	D4FA	1493		0-N1813	VB [BT]	S
1.5 CRDi LX	03/05-	D4FA	1493	Rippenanzahl: 5	0-N2375	VB [DG]	
1.5 CRDi LX	03/05-	D4FA	1493		0-N2429	VB [DG]	
1.6 CVVT LX	03/05-	G4ED	1599		0-N1854	VB [BT]	

PRIDE Kombi

1.3	08/99-	B3A5	1324	22x107	SK-1225	BTK	
1.3	08/99-	B3A5	1324		0-N983	TB [TE]	

PRIDE Van (DA)

1.3 16V	04/92-06/99	B3	1324	22x107	SK-1225	BTK	
---------	-------------	----	------	--------	---------	-----	--

PRO CEE'D (JD)

1.4 CRDi	03/13-	D4FC	1396		0-N1813	VB [BT]	S
1.4 CRDi	03/13-	D4FC	1396	für Fahrzeuge mit Start-Stopp-Funktion	0-N2214	VB [BT]	S
1.4 CRDi	03/13-	D4FC	1396	Rippenanzahl: 5	0-N2375	VB [DG]	
1.4 CRDi	03/13-	D4FC	1396		0-N2429	VB [DG]	
1.4 CVVT	03/13-	G4FA-L	1396		0-N1987	VB [DG]	
1.6 CRDi	03/13-	D4FB	1582		0-N1813	VB [BT]	S
1.6 CRDi	03/13-	D4FB	1582	Rippenanzahl: 5	0-N2375	VB [DG]	
1.6 CRDi, 1.6 CRDi 136	03/13-	D4FB	1582	für Fahrzeuge mit Start-Stopp-Funktion	0-N2214	VB [BT]	S
1.6 CRDi, 1.6 CRDi 136	03/13-	D4FB	1582		0-N2429	VB [DG]	
1.6 GDI, 1.6 GT	03/13-	G4FD, G4FJ	1591		0-N1987	VB [DG]	

PRO CEE'D (ED)

2.0 CRDi 140	02/08-09/12	D4EA-F	1991	28x123	SK-1654	BTK	
2.0 CRDi 140	02/08-09/12	D4EA-F	1991	28x123	SK-1654AQ2	BTKW	
2.0, 2.0 LPG	02/08-09/12	G4GC	1975	25.4x113	SK-1684	BTK	
2.0 CRDi 140	02/08-09/12	D4EA-F	1991		0-N1499	TB [BT]	S
2.0 CRDi 140	02/08-09/12	D4EA-F	1991		0-N1500	TB [DG]	
2.0, 2.0 LPG	02/08-09/12	G4GC	1975		0-N1374	TB [DG]	
2.0, 2.0 LPG	02/08-09/12	G4GC	1975		0-N1619	TB [TE]	
1.4, 1.4 CVVT	02/08-09/12	G4FA, G4FA-L	1396		0-N1987	VB [DG]	
1.4, 1.4 CVVT	02/08-09/12	G4FA, G4FA-L	1396		0-N2202	VB [BT]	S
1.6 CRDi 115, 1.6 CRDi 128, 1.6 CRDi 90	02/08-09/12	D4FB, D4FB-L	1582		0-N1813	VB [BT]	S
1.6 CRDi 115, 1.6 CRDi 128, 1.6 CRDi 90	02/08-09/12	D4FB, D4FB-L	1582	für Fahrzeuge mit Start-Stopp-Funktion	0-N2214	VB [BT]	S
1.6 CRDi 115, 1.6 CRDi 128, 1.6 CRDi 90	02/08-09/12	D4FB, D4FB-L	1582	Rippenanzahl: 5	0-N2375	VB [DG]	
1.6 CRDi 115, 1.6 CRDi 128, 1.6 CRDi 90	02/08-09/12	D4FB, D4FB-L	1582		0-N2429	VB [DG]	
1.6, 1.6 CVVT	02/08-02/13	G4FC	1591		0-N1987	VB [DG]	
1.6, 1.6 CVVT	02/08-02/13	G4FC	1591		0-N2202	VB [BT]	S
2.0 CRDi 140	02/08-09/12	D4EA-F	1991	⊗	0-N1814	VB [DG]	
2.0 CRDi 140	02/08-09/12	D4EA-F	1991		0-N1815	VB [BT]	S

RETONA (CE)

2.0 16V	05/00-	FE (16V)	1998	25x168	SK-1231	BTK	
2.0 16V	05/00-	FE (16V)	1998		0-N073	TB [TE]	
2.0 16V	05/00-	FE (16V)	1998		0-N075	TB [DG]	
2.0 TD	06/99-	RF	1998		0-N1948	TB [TE]	

RIO Stufenheck (DC_)

1.3	09/00-02/05	A3E	1343	22x107	SK-1225	BTK	
1.5, 1.5 16V	09/00-02/05	A5D	1493	22x137	SK-1652	BTK	
1.3	09/00-02/05	A3E	1343		0-N983	TB [TE]	
1.5 16V	09/00-02/05	A5D	1493		0-N069	TB [TE]	
1.5 16V	09/00-02/05	A5D	1493		0-N070	TB [DG]	

RIO Kombi (DC)

1.3	08/00-02/05	A3E	1343	22x107	SK-1225	BTK	
1.5 16V	08/00-02/05	A5D	1493	22x137	SK-1652	BTK	
1.3	08/00-02/05	A3E	1343		0-N983	TB [TE]	
1.5 16V	08/00-02/05	A5D	1493		0-N069	TB [TE]	

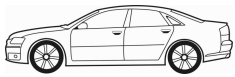

CM³



Art. Nr.



RIO Kombi (DC)							
1.5 16V	08/00-02/05	A5D	1493			0-N070	TB [DG]

RIO II (JB)							
1.4 16V	03/05-	G4EE	1399	22x105		SK-1634	BTK
1.4 16V	03/05-	G4EE	1399	22x105		SK-1634AQ1	BTKW
1.6 CVVT	03/05-	G4ED	1599	22x105		SK-1634	BTK
1.6 CVVT	03/05-	G4ED	1599	22x105		SK-1634AQ1	BTKW
1.4 16V	03/05-	G4EE	1399			0-N1370	TB [DG]
1.4 16V	03/05-	G4EE	1399			0-N975	TB [TE]
1.6 CVVT	03/05-	G4ED	1599			0-N1370	TB [DG]
1.6 CVVT	03/05-	G4ED	1599			0-N975	TB [TE]
1.4 16V	03/05-	G4EE	1399			0-N1854	VB [BT]
1.5 CRDi	03/05-	D4FA	1493			0-N1813	VB [BT] S
1.5 CRDi	03/05-	D4FA	1493	Rippenanzahl: 5		0-N2375	VB [DG]
1.5 CRDi	03/05-	D4FA	1493			0-N2429	VB [DG]
1.6 CVVT	03/05-	G4ED	1599			0-N1854	VB [BT]

RIO II Stufenheck (JB)							
1.4 16V	03/05-	G4EE	1399	22x105		SK-1634	BTK
1.4 16V	03/05-	G4EE	1399	22x105		SK-1634AQ1	BTKW
1.6 16V	03/05-	G4ED	1599	22x105		SK-1634	BTK
1.6 16V	03/05-	G4ED	1599	22x105		SK-1634AQ1	BTKW
1.4 16V	03/05-	G4EE	1399			0-N1370	TB [DG]
1.4 16V	03/05-	G4EE	1399			0-N975	TB [TE]
1.6 16V	03/05-	G4ED	1599			0-N1370	TB [DG]
1.6 16V	03/05-	G4ED	1599			0-N975	TB [TE]
1.4 16V	03/05-	G4EE	1399			0-N1854	VB [BT]
1.5 CRDi	03/05-	D4FA	1493			0-N1813	VB [BT] S
1.5 CRDi	03/05-	D4FA	1493	Rippenanzahl: 5		0-N2375	VB [DG]
1.5 CRDi	03/05-	D4FA	1493			0-N2429	VB [DG]
1.6 16V	03/05-	G4ED	1599			0-N1854	VB [BT]

RIO III (UB)							
1.1 CRDi	09/11-	D3FA	1120			0-N1813	VB [BT] S
1.1 CRDi	09/11-	D3FA	1120	für Fahrzeuge mit Start-Stopp-Funktion		0-N2214	VB [BT] S
1.1 CRDi	09/11-	D3FA	1120	Rippenanzahl: 5		0-N2375	VB [DG]
1.1 CRDi	09/11-	D3FA	1120			0-N2429	VB [DG]
1.4 CRDi	09/11-	D4FC	1396			0-N1813	VB [BT] S
1.4 CRDi	09/11-	D4FC	1396	für Fahrzeuge mit Start-Stopp-Funktion		0-N2214	VB [BT] S
1.4 CRDi	09/11-	D4FC	1396	Rippenanzahl: 5		0-N2375	VB [DG]
1.4 CRDi	09/11-	D4FC	1396			0-N2429	VB [DG]
1.4 CVVT	09/11-	G4FA	1396			0-N1987	VB [DG]
1.4 CVVT	09/11-	G4FA	1396			0-N2202	VB [BT] S
1.6 CVVT	06/12-	G4FC	1591			0-N1987	VB [DG]

RIO III Stufenheck (UB)							
1.4 CVVT	10/11-	G4FA	1396			0-N1987	VB [DG]
1.6 CVVT	06/12-	G4FC	1591			0-N1987	VB [DG]

SEPHIA (FA)							
1.5 i	02/96-10/97	B5	1498	22x145; Nockenwelle: DOHC		SK-1224	BTK
1.5 i	02/96-10/97	B5	1498	22x107		SK-1225	BTK
1.8 i 16V	01/95-10/97	OK24N, OK26Y	1793	22x154		SK-1444	BTK
1.5 i	02/96-10/97	B5	1498			0-N070	TB [DG]
1.5 i	02/96-10/97	B5	1498			0-N983	TB [TE]
1.6 i	01/95-10/97	B6	1598			0-N983	TB [TE]
1.8 i 16V	01/95-10/97	OK24N, OK26Y	1793			0-N070	TB [DG]
1.8 i 16V	01/95-10/97	OK24N, OK26Y	1793			0-N1373	TB [TE]

SEPHIA Stufenheck (FA)							
1.5 i	02/96-10/97	B5	1498	22x145; Nockenwelle: DOHC		SK-1224	BTK
1.5 i	02/96-10/97	B5	1498	22x107		SK-1225	BTK
1.6 i	09/93-10/97	B6	1598	22x107		SK-1225	BTK
1.8 i 16V	01/95-10/97	OK24N, OK26Y	1793	22x154; 03/1997 →		SK-1444	BTK
1.5 i	02/96-10/97	B5	1498			0-N070	TB [DG]
1.5 i	02/96-10/97	B5	1498			0-N983	TB [TE]
1.6 i	09/93-10/97	B6	1598			0-N983	TB [TE]
1.8 i 16V	01/95-10/97	OK24N, OK26Y	1793			0-N070	TB [DG]
1.8 i 16V	01/95-10/97	OK24N, OK26Y	1793			0-N1373	TB [TE]

CM³

Art. Nr.

**SHUMA (FB)**

1.5 i 16V	10/97-03/01	BFD, ZYVE	1498	22x145	SK-1224	BTK	
1.6	01/01-12/01	GA6D	1594	22x137	SK-1652	BTK	
1.8 i 16V	10/97-03/01	T8	1793	22x154; 02/1998 →	SK-1444	BTK	
1.5 i 16V	10/97-03/01	BFD, ZYVE	1498		0-N069	TB [TE]	
1.5 i 16V	10/97-03/01	BFD, ZYVE	1498		0-N070	TB [DG]	
1.6	01/01-12/01	GA6D	1594		0-N069	TB [TE]	
1.6	01/01-12/01	GA6D	1594		0-N070	TB [DG]	
1.8 i 16V	10/97-03/01	T8	1793		0-N070	TB [DG]	
1.8 i 16V	10/97-03/01	T8	1793		0-N1373	TB [TE]	

SHUMA Stufenheck (FB)

1.5	03/96-12/98	OK280	1498	22x107	SK-1225	BTK	
1.5 i 16V	10/97-10/01	BFD, ZYVE	1498	22x145; 02/1998 →	SK-1224	BTK	
1.5, 1.5 i 16V	03/96-10/01	BFD, ZYVE, OK280	1498		0-N069	TB [TE]	
1.5, 1.5 i 16V	03/96-10/01	BFD, ZYVE, OK280	1498		0-N070	TB [DG]	
1.8 GX	05/99-10/01		1798		0-N070	TB [DG]	

SHUMA II (FB)

1.6	05/01-08/04	GA6D	1594	22x137	SK-1652	BTK	
1.8	04/03-08/04	T8	1793	22x154	SK-1444	BTK	
1.6	05/01-08/04	GA6D	1594		0-N069	TB [TE]	
1.6	05/01-08/04	GA6D	1594		0-N070	TB [DG]	
1.8	05/01-08/04	T8	1793		0-N070	TB [DG]	
1.8	04/03-08/04	T8	1793		0-N1373	TB [TE]	

SHUMA II Stufenheck (FB)

1.6	05/01-05/04	GA6D	1594	22x137	SK-1652	BTK	
1.6	05/01-05/04	GA6D	1594		0-N069	TB [TE]	
1.6	05/01-05/04	GA6D	1594		0-N070	TB [DG]	

SORENTO [USA] Sport Utility

3.5	01/03-12/03		3497		0-N185	TB [TE]	
-----	-------------	--	------	--	--------	---------	--

SORENTO I (JC)

3.5 V6	08/02-	G6CU	3497	32x259; → 08/2006	SK-1718	BTK	
2.4	08/02-	G4JS	2351		0-N055	TB [DG]	
2.4	08/02-	G4JS	2351		0-N1127	TB [TE]	
2.4	08/02-	G4JS	2351		0-N1498	TB [TE]	
3.5 V6	08/02-	G6CU	3497		0-N185	TB [TE]	
3.5 V6	08/02-	G6CU	3497		0-N189	TB [DG]	
2.4	08/02-	G4JS	2351	→ 04/2006	0-N1583	TB [BT]	
2.4	08/02-	G4JS	2351		0-N1853	VB [BT]	
2.5 CRDi	08/02-	D4CB	2497		0-N1552	VB [BT]	S
2.5 CRDi	08/02-	D4CB	2497	→ 04/2006; für Fahrzeuge mit Servolenkung	0-N1553	VB [DG]	
3.3 V6	11/07-	G6DB	3342		0-N1990	VB [DG]	
3.3 V6	11/07-	G6DB	3342		0-N2250	VB [BT]	S
3.5 V6	08/02-	G6CU	3497		0-N1521	VB [DG]	
3.8 4WD	09/06-	G6DA	3778		0-N2250	VB [BT]	S

SORENTO II (XM)

2.0 CRDi, 2.0 CRDi 4WD	11/10-	D4HA	1995		0-N2247	VB [BT]	S
2.0 CRDi, 2.0 CRDi 4WD	11/10-	D4HA	1995		0-N2248	VB [DG]	
2.0 CRDi, 2.0 CRDi 4WD	11/10-	D4HA	1995		0-N2249	VB [DG]	
2.0 CRDi, 2.0 CRDi 4WD	11/10-	D4HA	1995	Rippenanzahl: 6	0-N2377	VB [DG]	
2.2 CRDi, 2.2 CRDi 4WD	11/09-	D4HB	2199		0-N2247	VB [BT]	S
2.2 CRDi, 2.2 CRDi 4WD	11/09-	D4HB	2199		0-N2248	VB [DG]	
2.2 CRDi, 2.2 CRDi 4WD	11/09-	D4HB	2199		0-N2249	VB [DG]	
2.2 CRDi, 2.2 CRDi 4WD	11/09-	D4HB	2199	Rippenanzahl: 6	0-N2377	VB [DG]	
2.4 CVVT, 2.4 CVVT 4WD	11/09-	G4KE	2359		0-N2108	VB [BT]	S
2.4 CVVT, 2.4 CVVT 4WD, 2.4 GDI, 2.4 GDI 4WD	11/09-	G4KE, G4KJ	2359		0-N2021	VB [DG]	

SORENTO III

2.2 CRDi, 2.2 CRDi 4WD	01/15-	D4HB	2199		0-N2247	VB [BT]	S
------------------------	--------	------	------	--	---------	---------	---

SOUL (AM)

1.6 CRDi 115, 1.6 CRDi 128	02/09-	D4FB	1582		0-N1813	VB [BT]	S
1.6 CRDi 115, 1.6 CRDi 128	02/09-	D4FB	1582	für Fahrzeuge mit Start-Stopp-Funktion	0-N2214	VB [BT]	S
1.6 CRDi 115, 1.6 CRDi 128	02/09-	D4FB	1582	Rippenanzahl: 5	0-N2375	VB [DG]	
1.6 CRDi 115, 1.6 CRDi 128	02/09-	D4FB	1582		0-N2429	VB [DG]	

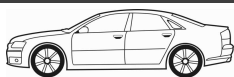
CM³

Art. Nr.

**SOUL (AM)**

1.6 CVVT, 1.6 GDI	02/09-	G4FC, G4FD	1591		0-N2202	VB [BT]	S
1.6, 1.6 CVVT, 1.6 GDI	02/09-12/10	G4FC, G4FD, G4FG	1591		0-N1987	VB [DG]	

SOUL II (PS)

1.6 CRDi 128, 1.6 CRDi 136	02/14-	D4FB	1582	für Fahrzeuge mit Start-Stopp-Funktion	0-N2214	VB [BT]	S
1.6 CRDi 128, 1.6 CRDi 136	02/14-	D4FB	1582		0-N2429	VB [DG]	
1.6 GDI	02/14-	G4FD	1591	für Fahrzeuge mit elektrischer Servolenkung	0-N1987	VB [DG]	

SPORTAGE (K00)

2.0 TD 4WD	10/97-08/03	RF	1998	30x162	SK-1228	BTK	
2.0, 2.0 4WD, 2.0 i 16V, 2.0 i 16V 4WD	04/94-08/03	FE (16V)	1998	25x168	SK-1231	BTK	
2.0 TD 4WD	10/97-08/03	RF	1998		0-N1948	TB [TE]	
2.0, 2.0 4WD, 2.0 i 16V, 2.0 i 16V 4WD	04/94-08/03	FE (16V)	1998		0-N075	TB [DG]	
2.0, 2.0 4WD, 2.0 i 16V, 2.0 i 16V 4WD, 2.0 i 4WD	04/94-08/03	FE (16V), FE (8V)	1998		0-N073	TB [TE]	

SPORTAGE (JE_, KM_)

2.0 16V 4WD, 2.0 i 16V	09/04-	G4GC	1975	25.4x113	SK-1651	BTK	
2.0 16V 4WD, 2.0 i 16V	09/04-	G4GC	1975	25x113; → 05/2006	SK-1656	BTK	
2.0 16V 4WD, 2.0 i 16V	09/04-	G4GC	1975	25.4x113; 05/2006 →	SK-1684	BTK	
2.0 CRDi, 2.0 CRDi 4WD	09/04-	D4EA, D4EA-F, D4EA-V, D4EA-V	1991	28x123	SK-1654	BTK	
2.0 CRDi, 2.0 CRDi 4WD	09/04-	D4EA	1991	28x123; → 05/2005	SK-1654AQ1	BTKW	
2.0 CRDi, 2.0 CRDi 4WD	09/04-	D4EA	1991	28x123; 05/2005 →	SK-1654AQ2	BTKW	
2.0 CRDi, 2.0 CRDi 4WD	01/06-	D4EA	1991	28x123; 01/2009 →	SK-1654	BTK	
2.0 CRDi, 2.0 CRDi 4WD	01/06-	D4EA, D4EA-F, D4EA-V, D4EA-V	1991	28x123	SK-1654AQ2	BTKW	
2.0 CRDi, 2.0 CRDi 4WD	09/08-	D4EA	1991	28x123; Baumuster: Van	SK-1654AQ2	BTKW	
2.7 V6 4WD	09/04-	G6BA	2656	32x207; Nockenwelle: DOHC	SK-1669	BTK	
2.7 V6 4WD	09/04-	G6BA	2656	32x207; → 01/2006	SK-1669AQ1	BTKW	
2.7 V6 4WD	09/04-	G6BA	2656	32x207; mit Spanndämpfer, Spannrolle	SK-1749	BTK	
2.0 16V 4WD, 2.0 i 16V	09/04-	G4GC	1975		0-N1374	TB [DG]	
2.0 16V 4WD, 2.0 i 16V	09/04-	G4GC	1975	→ 05/2006	0-N1561	TB [TE]	
2.0 16V 4WD, 2.0 i 16V	09/04-	G4GC	1975	05/2006 →	0-N1619	TB [TE]	
2.0 CRDi, 2.0 CRDi 4WD	09/04-	D4EA, D4EA-F, D4EA-V, D4EA-V	1991		0-N1499	TB [BT]	S
2.0 CRDi, 2.0 CRDi 4WD	09/04-	D4EA, D4EA-F, D4EA-V, D4EA-V	1991		0-N1500	TB [DG]	
2.7 V6 4WD	09/04-	G6BA	2656		0-N1576	TB [TE]	
2.7 V6 4WD	09/04-	G6BA	2656		0-N1577	TB [DG]	
2.7 V6 4WD	09/04-	G6BA	2656	→ 05/2010; Spannrollenbetätigung: hydraulisch	0-N2428	TB [VD]	
2.0 CRDi, 2.0 CRDi 4WD	09/04-	D4EA, D4EA-F, D4EA-V, D4EA-V	1991		0-N1547	VB [DG]	
2.0 CRDi, 2.0 CRDi 4WD	09/04-	D4EA, D4EA-F, D4EA-V, D4EA-V	1991	→ 05/2010; ✱	0-N1814	VB [DG]	
2.0 CRDi, 2.0 CRDi 4WD	09/04-	D4EA, D4EA-F, D4EA-V, D4EA-V	1991		0-N1815	VB [BT]	S
2.0 CRDi, 2.0 CRDi 4WD	01/06-	D4EA	1991	✱	0-N1814	VB [DG]	
2.7 V6 4WD	09/04-	G6BA	2656		0-N1677	VB [BT]	S
2.7 V6 4WD	09/04-	G6BA	2656		0-N1678	VB [DG]	

SPORTAGE (SL)

1.6 GDI	02/11-	G4FD	1591		0-N1987	VB [DG]	
1.6 GDI	02/11-	G4FD	1591		0-N2202	VB [BT]	S
1.7 CRDi	12/10-	D4FD-L	1685		0-N1813	VB [BT]	S
1.7 CRDi	12/10-	D4FD-L	1685	für Fahrzeuge mit Start-Stopp-Funktion	0-N2214	VB [BT]	S
1.7 CRDi	12/10-	D4FD-L	1685	Rippenanzahl: 5	0-N2375	VB [DG]	
1.7 CRDi	12/10-	D4FD-L	1685		0-N2429	VB [DG]	
2.0 CRDi, 2.0 CRDi AWD	07/10-	D4HA	1995		0-N2247	VB [BT]	S
2.0 CRDi, 2.0 CRDi AWD	07/10-	D4HA	1995		0-N2248	VB [DG]	
2.0 CRDi, 2.0 CRDi AWD	07/10-	D4HA	1995		0-N2249	VB [DG]	
2.0 CRDi, 2.0 CRDi AWD	07/10-	D4HA	1995	Rippenanzahl: 6	0-N2377	VB [DG]	
2.0 CVVT, 2.0 CVVT AWD	07/10-	G4KD	1998		0-N2021	VB [DG]	
2.0 CVVT, 2.0 CVVT AWD	07/10-	G4KD	1998		0-N2108	VB [BT]	S

VENGA (YN)

1.4 CRDi 75, 1.4 CRDi 90	02/10-	D4FC	1396		0-N1813	VB [BT]	S
1.4 CRDi 75, 1.4 CRDi 90	02/10-	D4FC	1396	für Fahrzeuge mit Start-Stopp-Funktion	0-N2214	VB [BT]	S
1.4 CRDi 75, 1.4 CRDi 90	02/10-	D4FC	1396	Rippenanzahl: 5	0-N2375	VB [DG]	
1.4 CRDi 75, 1.4 CRDi 90	02/10-	D4FC	1396		0-N2429	VB [DG]	
1.4 CVVT	02/10-	G4FA-L	1396		0-N1987	VB [DG]	
1.4 CVVT	02/10-	G4FA-L	1396		0-N2202	VB [BT]	S
1.6 CRDi 115, 1.6 CRDi 128	02/10-	D4FB	1582		0-N1813	VB [BT]	S
1.6 CRDi 115, 1.6 CRDi 128	02/10-	D4FB	1582	für Fahrzeuge mit Start-Stopp-Funktion	0-N2214	VB [BT]	S
1.6 CRDi 115, 1.6 CRDi 128	02/10-	D4FB	1582	Rippenanzahl: 5	0-N2375	VB [DG]	



OPTIMAL®

KIA



CM³



Art. Nr.



VENGA (YN)

1.6 CRDi 115, 1.6 CRDi 128	02/10-	D4FB	1582		0-N2429	VB [DG]	
1.6 CVVT	02/10-	G4FC	1591		0-N1987	VB [DG]	
1.6 CVVT	02/10-	G4FC	1591		0-N2202	VB [BT]	S



CM³



Art. Nr.



ohne Halter

CARNIVAL Großraumlimousine							
3.5	07/04-12/10	G6CU	3497			0-N185	TB [TE]
CERATO							
1.6	05/05-08/06	G4ED	1599			0-N1370	TB [DG]
1.6	05/05-08/06	G4ED	1599			0-N975	TB [TE]
1.8	05/05-	G4GB	1795			0-N1374	TB [DG]
OPTIMA							
1.8	08/05-	G4GB	1795			0-N1374	TB [DG]
2.0	09/04-	G4GC	1975			0-N1374	TB [DG]
QIANLIMA							
1.3	12/02-04/07	G4EA	1341			0-N975	TB [TE]
1.6	12/02-04/07	G4ED	1599			0-N1370	TB [DG]
1.6	12/02-04/07	G4ED	1599			0-N975	TB [TE]
RIO							
1.6	01/07-	G4ED	1599	22x105		SK-1634	BTK
1.4	01/07-	G4EE	1399			0-N1370	TB [DG]
1.4	01/07-	G4EE	1399			0-N975	TB [TE]
1.6	01/07-	G4ED	1599			0-N1370	TB [DG]
1.6	01/07-	G4ED	1599			0-N975	TB [TE]
SPORTAGE Geländewagen geschlossen							
2.0	11/07-	G4GC	1975			0-N1374	TB [DG]

CM³

Art. Nr.



ohne Halter

110								
1.5	01/95-	BA3 2111	1499	19x111	SK-1185	BTK		
1.5	01/95-	BA3 2111, VAZ-2111	1499	19x111	SK-1711	BTK		
1.5 16V	01/95-	VAZ-2112	1499	25.4x136	SK-1715	BTK		
1.6	01/00-	VAZ-21114, VAZ-21124	1596	19x111	SK-1711	BTK		
2.0 i	08/96-	C 20 XE	1998	24x176; Baumuster: Vega	SK-1165	BTK		
1.5	01/95-	BA3 2111, VAZ-2111	1499		0-N1917	TB [TE]		
1.5 16V	01/95-	VAZ-2112	1499		0-N1911	TB [TE]		
1.5 16V	01/95-	VAZ-2112	1499		0-N1914	TB [DG]		
1.6	01/00-	VAZ-21114, VAZ-21124	1596		0-N1917	TB [TE]		
2.0 i	08/96-	C 20 XE	1998		0-N100	TB [TE]		
2.0 i	08/96-	C 20 XE	1998		0-N906	TB [DG]		
2.0 i	08/96-	C 20 XE	1998		0-N907	TB [DG]		
2.0 i	08/96-	C 20 XE	1998		0-N1422	VB [BT]		S
111								
1.5	01/96-	VAZ-2111	1499	19x111; 01/1997 →	SK-1711	BTK		
1.5	10/00-	VAZ-2111	1499	19x111	SK-1711	BTK		
1.5 16V	01/95-	VAZ-2112	1499	25.4x136	SK-1715	BTK		
1.6	01/05-	VAZ-21114	1596	19x111; 09/2006 →	SK-1711	BTK		
1.6	03/06-	VAZ-21124	1596	25.4x136; 09/2006 →	SK-1715	BTK		
1.5	01/96-	VAZ-2111	1499	01/1997 →	0-N1917	TB [TE]		
1.5	10/00-	VAZ-2111	1499		0-N1917	TB [TE]		
1.5 16V	01/95-	VAZ-2112	1499		0-N1911	TB [TE]		
1.5 16V	01/95-	VAZ-2112	1499		0-N1914	TB [DG]		
1.6	01/05-	VAZ-21114	1596	09/2006 →	0-N1917	TB [TE]		
112								
1.5	01/95-	VAZ-2111	1499	19x111; 02/2002 →	SK-1711	BTK		
1.5	10/00-	VAZ-2111	1499	19x111	SK-1711	BTK		
1.5 16V	01/95-	VAZ-2112	1499	25.4x136	SK-1715	BTK		
1.6	01/05-	VAZ-21114	1596	19x111	SK-1711	BTK		
1.6	03/06-	VAZ-21124	1596	19x111; → 12/2008	SK-1711	BTK		
1.5	01/95-	VAZ-2111	1499	02/2002 →	0-N1917	TB [TE]		
1.5	10/00-	VAZ-2111	1499		0-N1917	TB [TE]		
1.5 16V	01/95-	VAZ-2112	1499		0-N1911	TB [TE]		
1.5 16V	01/95-	VAZ-2112	1499		0-N1914	TB [DG]		
1.6	01/05-	VAZ-21114	1596		0-N1917	TB [TE]		
1.6	03/06-	VAZ-21124	1596	→ 12/2008	0-N1917	TB [TE]		
GRANTA (2190)								
1.6	10/11-	VAZ-21126	1596	22x137	SK-1691	BTK		
1.6	10/11-	VAZ-11186	1596	17x113	SK-1731	BTK		
1.6	10/11-	VAZ-11186	1596		0-N2376	TB [TE]		
KALINA Kombi (1117)								
1.4 16V, 1.4 16V LPG	11/08-	VAZ-11194	1390	22x137	SK-1691	BTK		
1.6	10/04-	VAZ-21114	1596	19x111	SK-1711	BTK		
1.6	01/10-	VAZ1110	1596	25.4x136	SK-1715	BTK		
1.4 16V, 1.4 16V LPG	11/08-	VAZ-11194	1390		0-N2044	TB [DG]		
1.4 16V, 1.4 16V LPG	11/08-	VAZ-11194	1390		0-N2056	TB [TE]		
1.6	10/04-	VAZ-21114	1596		0-N1917	TB [TE]		
1.6	10/04-	VAZ-21114	1596		0-N2044	TB [DG]		
1.6	10/04-	VAZ-21114	1596		0-N2056	TB [TE]		
1.4 16V, 1.4 16V LPG	11/08-	VAZ-11194	1390		0-N1450	VB [DG]		
1.6	10/04-	VAZ-21114	1596		0-N1450	VB [DG]		
KALINA Schrägheck (1119)								
1.4 16V, 1.4 16V LPG	11/08-	VAZ-11194	1390	22x137	SK-1691	BTK		
1.6	01/10-	VAZ1110	1596	19x111	SK-1711	BTK		
1.6, 1.6 16V	10/04-	VAZ-21114	1596	25.4x136; 09/2006 →	SK-1715	BTK		
1.4 16V, 1.4 16V LPG	11/08-	VAZ-11194	1390		0-N2044	TB [DG]		
1.4 16V, 1.4 16V LPG	11/08-	VAZ-11194	1390		0-N2056	TB [TE]		
1.6	01/10-	VAZ1110	1596		0-N1917	TB [TE]		
1.6, 1.6 16V	10/04-	VAZ-21114	1596		0-N2044	TB [DG]		
1.6, 1.6 16V	10/04-	VAZ-21114	1596		0-N2056	TB [TE]		
1.4 16V, 1.4 16V LPG	11/08-	VAZ-11194	1390		0-N1450	VB [DG]		
1.6, 1.6 16V	10/04-	VAZ-21114	1596		0-N1450	VB [DG]		

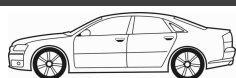
CM³

Art. Nr.



KALINA Stufenheck (1118)							
1.4 16V, 1.4 16V LPG	11/08-	VAZ-11194	1390	22x137	SK-1691	BTK	
1.6	10/04-	VAZ-21114, VAZ-21124	1596	25.4x136; 01/2005 →	SK-1715	BTK	
1.6	01/10-	VAZ1110	1596	19x111	SK-1711	BTK	
1.6 16V	10/04-		1596	25.4x136; 09/2006 →	SK-1715	BTK	
1.4 16V, 1.4 16V LPG	11/08-	VAZ-11194	1390		0-N2044	TB [DG]	
1.4 16V, 1.4 16V LPG	11/08-	VAZ-11194	1390		0-N2056	TB [TE]	
1.6	01/10-	VAZ1110	1596		0-N1917	TB [TE]	
1.6, 1.6 16V	10/04-	VAZ-21114, VAZ-21124	1596		0-N2044	TB [DG]	
1.6, 1.6 16V	10/04-	VAZ-21114, VAZ-21124	1596		0-N2056	TB [TE]	
1.4 16V, 1.4 16V LPG	11/08-	VAZ-11194	1390		0-N1450	VB [DG]	
1.6, 1.6 16V	10/04-	VAZ-21114, VAZ-21124	1596		0-N1450	VB [DG]	
KALINA Kombi (2194)							
1.6	11/13-	VAZ-11186	1596	17x113	SK-1731	BTK	
1.6	11/13-	VAZ-11186	1596		0-N2376	TB [TE]	
KALINA Schrägheck (2192)							
1.6	06/13-	VAZ-11186	1596	17x113	SK-1731	BTK	
1.6	06/13-	VAZ-11186	1596		0-N2376	TB [TE]	
LARGUS Kasten							
1.6	03/12-	VAZ- K4M	1598	27x132; mit Zubehör	SK-1088	BTK	
1.6	03/12-	VAZ- K4M	1598	27x132; mit Zubehör	SK-1088AQ1	BTKW	
1.6	03/12-	VAZ-K7M	1598	17.3x96	SK-1704AQ1	BTKW	
1.6	03/12-	K4M	1598		0-N262	TB [DG]	
LARGUS Kombi							
1.6	03/12-	VAZ- K4M	1598	27x132; mit Zubehör	SK-1088	BTK	
1.6	03/12-	VAZ- K4M	1598	27x132; mit Zubehör	SK-1088AQ1	BTKW	
1.6	03/12-	VAZ-K7M	1598	17.3x96	SK-1704	BTK	
1.6	03/12-	VAZ-K7M	1598	17.3x96	SK-1704AQ1	BTKW	
1.6	03/12-	K4M	1598		0-N262	TB [DG]	
NIVA (2121)							
1900 Diesel	01/93-	XUD9A	1905	25.39x136; → 12/1993	SK-1007	BTK	
1900 Diesel	01/93-	XUD9A	1905	25.4x136; 11/1994 →	SK-1022	BTK	
1900 Diesel	01/99-	XUD9SD	1905	25.4x136; Baumuster: 2121	SK-1022	BTK	
1900 Diesel	01/93-	XUD9A	1905	→ 01/1994	0-N813	TB [TE]	
1900 Diesel	01/93-	XUD9A	1905	→ 01/1994	0-N814	TB [DG]	
1900 Diesel	01/93-	XUD9A	1905	02/1994 →	0-N900	TB [DG]	
1900 Diesel	01/93-	XUD9A	1905	02/1994 →	0-N901	TB [TE]	
TAIGA II (2123)							
1.7, 1.7 LPG	09/02-	BA3 21214	1690		0-N1450	VB [DG]	
NOVA (2105)							
1200 Junior/L	09/81-	BA3 2101	1198		0-N912	TB [TE]	
1300 Spezial/L	05/81-	BA3 2105	1294		0-N912	TB [TE]	
1500 S	06/89-	BA3 21083	1499		0-N912	TB [TE]	
1500 Special	03/85-	BA3 2103	1452		0-N912	TB [TE]	
NOVA Kombi (2104)							
1300	09/85-12/91	BA3 2105	1294		0-N912	TB [TE]	
1500	09/85-02/93	BA3 2103	1458		0-N912	TB [TE]	
1500	08/94-	BA3 2103	1451		0-N912	TB [TE]	
OKA (1111)							
0.8	02/88-	B6113E	750	19x111	SK-1185	BTK	
PRIORA Kombi (2171)							
1.6	10/09-	BA3 21703, VAZ-21126	1596	22x137	SK-1691	BTK	
1.6	10/09-	BA3 21703	1596	19x111	SK-1711	BTK	
1.6	10/09-	BA3 21703	1596		0-N1917	TB [TE]	
PRIORA Schrägheck (2172)							
1.6	12/08-	BA3 21703, VAZ-21126	1596	22x137	SK-1691	BTK	
1.6	12/08-	BA3 21703	1596	19x111	SK-1711	BTK	
1.6 LPG	12/08-	VAZ-21126	1596	22x137; 03/2009 →	SK-1691	BTK	
1.6	12/08-	BA3 21703	1596		0-N1917	TB [TE]	
1.6, 1.6 LPG	12/08-	VAZ-21126	1596		0-N2044	TB [DG]	
1.6, 1.6 LPG	12/08-	VAZ-21126	1596		0-N2056	TB [TE]	



CM³



Art. Nr.



ohne Halter

PRIORA Stufenheck (2170)

1.6	12/08-	BA3 21703	1596	19x111	SK-1711	BTK
1.6, 1.6 LPG	12/08-	BA3 21703, VAZ-21126	1596	22x137	SK-1691	BTK
1.6	12/08-	BA3 21703	1596		0-N1917	TB [TE]
1.6, 1.6 LPG	12/08-	VAZ-21126	1596		0-N2044	TB [DG]
1.6, 1.6 LPG	12/08-	VAZ-21126	1596		0-N2056	TB [TE]

SAMARA (2108, 2109, 2115)

1.5	04/96-	VAZ-2111	1499	19x111; 01/2000 →	SK-1185	BTK
1.5	04/96-	VAZ-2111	1499	19x111; 01/2000 →	SK-1711	BTK
1100	02/88-12/94	BA3 21081	1100	19x111	SK-1185	BTK
1100	02/88-12/94	BA3 21081	1100	19x111	SK-1711	BTK
1100	02/96-	BA3 21081	1099	19x111	SK-1185	BTK
1100	02/96-	BA3 21081	1099	19x111	SK-1711	BTK
1300	01/86-12/94	BA3 2108, BA3 21115	1288	19x111	SK-1185	BTK
1300	01/86-12/94	BA3 2108	1288	19x111; 09/1991 →	SK-1711	BTK
1300	01/88-	BA3 2108, BA3 21115	1288	19x111	SK-1711	BTK
1500	01/88-	BA3 21083, BA3 2111	1499	19x111	SK-1185	BTK
1500	01/88-	BA3 21083, BA3 2111	1499	19x111	SK-1711	BTK
1500	09/91-	BA3 21083	1500	19x111	SK-1185	BTK
1500	09/91-	BA3 21083	1500	19x111; 01/1994 →	SK-1711	BTK
1.5	04/96-	VAZ-2111	1499	01/2000 →	0-N1917	TB [TE]
1100	02/88-12/94	BA3 21081	1100		0-N1917	TB [TE]
1100	02/88-12/94	BA3 21081	1100		0-N912	TB [TE]
1100	02/96-	BA3 21081	1099		0-N1917	TB [TE]
1100	02/96-	BA3 21081	1099		0-N912	TB [TE]
1300	01/86-12/94	BA3 2108	1288	09/1991 →	0-N1917	TB [TE]
1300	01/86-12/94	BA3 2108, BA3 21115	1288		0-N912	TB [TE]
1300	01/88-	BA3 2108, BA3 21115	1288		0-N1917	TB [TE]
1500	01/86-	BA3 21083	1499		0-N912	TB [TE]
1500	01/88-	BA3 21083, BA3 2111	1499		0-N1917	TB [TE]
1500	09/91-	BA3 21083	1500	01/1994 →	0-N1917	TB [TE]
1500	09/91-	BA3 21083	1500		0-N912	TB [TE]

SAMARA FORMA (21099)

1100	07/91-	BA3 21081	1100	19x111	SK-1185	BTK
1100	07/91-	BA3 21081	1100	19x111	SK-1711	BTK
1300	05/89-07/97	BA3 2108, BA3 21115	1288	19x111	SK-1185	BTK
1300	05/89-07/97	BA3 2108	1288	19x111; 06/1990 →	SK-1711	BTK
1300	05/90-	BA3 2108, BA3 21115	1288	19x111	SK-1711	BTK
1500	07/91-	BA3 21083	1500	19x111	SK-1185	BTK
1500	07/91-	BA3 21083	1500	19x111	SK-1711	BTK
1500	11/94-	BA3 2111	1499	19x111	SK-1185	BTK
1500	11/94-	BA3 2111	1499	19x111	SK-1711	BTK
1100	07/91-	BA3 21081	1100		0-N1917	TB [TE]
1100	07/91-	BA3 21081	1100		0-N912	TB [TE]
1300	05/89-07/97	BA3 2108	1288	06/1990 →	0-N1917	TB [TE]
1300	05/89-07/97	BA3 2108, BA3 21115	1288		0-N912	TB [TE]
1300	05/90-	BA3 2108, BA3 21115	1288		0-N1917	TB [TE]
1500	07/91-	BA3 21083	1500		0-N912	TB [TE]
1500	09/91-	BA3 21083	1500		0-N1917	TB [TE]
1500	11/94-	BA3 2111	1499		0-N1917	TB [TE]

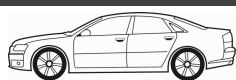

CM³



Art. Nr.



ohne Halter

DEDRA (835)							
1.6 16V	01/96-07/99	182 A4.000	1581	25x158; 02/1997 →	SK-1076	BTK	
1.6 i.e., 1.6 LE	08/89-07/99	159 B9.000, 835 A1.000, 835 A1.046, 835 C1.000	1581	15x138	SK-1031	BTK	
1.8 16V LE, 1.8 GT 16V	03/96-07/99	182 A2.000, 183 A1.000	1747	24x168	SK-1361	BTK	
1.8 16V LE, 1.8 GT 16V	03/96-07/99	182 A2.000, 183 A1.000	1747	24x168	SK-1361AQ1	BTKW	
1.8 16V LE, 1.8 GT 16V	03/96-07/99	182 A2.000, 183 A1.000	1747	15x130	SK-1664	BTK	
1.8 16V LE, 1.8 GT 16V	03/96-07/99	182 A2.000, 183 A1.000	1747	24x168; 15x130	SK-1755	BTK	
1.8 16V LE, 1.8 GT 16V	03/96-07/99	182 A2.000, 183 A1.000	1747	24x168; 15x130	SK-1755AQ1	BTKW	
1.8 i.e.	09/89-06/94	835 A2.000	1756	18x142	SK-1151	BTK	
1.8 i.e.	09/89-07/99	835 A2.046, 835 C5.000	1756	18x142; → 06/1994	SK-1151	BTK	
1.8 i.e.	07/94-07/99	836 A5.000	1756	18x142; → 08/1997	SK-1151	BTK	
1.9 TDS	04/89-07/99	160 D1.000, 835 A4.000, 835 A4.046	1929	22x173; 09/1989 →	SK-1033	BTK	
2.0 16V	07/94-07/99	836 A3.000	1995	18x173	SK-1050	BTK	
2.0 HF Integrale, 2.0 i.e., 2.0 i.e. Turbo Integrale, 2.0 Turbo	09/89-07/94	835 A5.000, 835 A7.000, 835 A7.046, 835 A8.000	1995	18x142	SK-1151	BTK	
2.0 i.e.	09/89-07/99	835 A5.046	1995	18x142; → 08/1997	SK-1151	BTK	
2.0 i.e. Turbo	04/91-07/99	835 A8.046	1995	18x142; → 06/1994	SK-1151	BTK	
1.6 16V	01/96-07/99	182 A4.000	1581		0-N208	TB [TE]	
1.6 16V	01/96-07/99	182 A4.000	1581		0-N951	TB [DG]	
1.6 i.e., 1.6 LE	08/89-07/99	159 B9.000, 835 A1.000, 835 A1.046, 835 C1.000	1581		0-N822	TB [TE]	
1.8 16V LE	03/96-07/99	182 A2.000	1747		0-N114	TB [TE]	
1.8 16V LE, 1.8 GT 16V	03/96-07/99	182 A2.000, 183 A1.000	1747		0-N1572	TB [TE]	
1.8 16V LE, 1.8 GT 16V	03/96-07/99	182 A2.000, 183 A1.000	1747		0-N938	TB [DG]	
1.8 GT 16V	03/96-07/99	183 A1.000	1747	→ 04/1998	0-N114	TB [TE]	
1.8 GT 16V	03/96-07/99	183 A1.000	1747	04/1998 →	0-N194	TB [TE]	
1.8 i.e.	09/89-07/99	835 A2.000, 835 A2.046, 835 C5.000, 836 A5.000	1756		0-N832	TB [TE]	
1.9 TDS	04/89-07/99	160 D1.000, 835 A4.000, 835 A4.046	1929		0-N835	TB [TE]	
1.9 TDS	04/89-07/99	160 D1.000, 835 A4.000, 835 A4.046	1929		0-N889	TB [DG]	
2.0 16V	07/94-07/99	836 A3.000	1995		0-N818	TB [TE]	
2.0 HF Integrale, 2.0 i.e., 2.0 i.e. Turbo, 2.0 i.e. Turbo Integrale, 2.0 Turbo	09/89-07/99	835 A5.000, 835 A5.046, 835 A7.000, 835 A7.046, 835 A8.000, 835 A8.046	1995		0-N832	TB [TE]	
1.6 16V, 1.6 i.e., 1.6 LE	08/89-07/99	159 B9.000, 182 A4.000, 835 A1.000, 835 A1.046, 835 C1.000	1581		0-N187	VB [DG]	
1.8 16V LE, 1.8 GT 16V	03/96-07/99	182 A2.000, 183 A1.000	1747		0-N1407	VB [BT]	S
1.8 16V LE, 1.8 GT 16V	03/96-07/99	182 A2.000, 183 A1.000	1747	✳	0-N1628	VB [DG]	
1.9 TDS	04/89-07/99	160 D1.000, 835 A4.000, 835 A4.046	1929	✳:→933346; ✳	0-N1629	VB [DG]	
1.9 TDS	04/89-07/99	160 D1.000, 835 A4.000, 835 A4.046	1929	✳:→933347	0-N187	VB [DG]	
DEDRA SW (835)							
1.6	10/94-07/99	159 B9.000	1581	15x138	SK-1031	BTK	
1.6 16V	01/96-07/99	182 A4.000	1581	25x158; 02/1997 →	SK-1076	BTK	
1.8 16V LE, 1.8 GT 16V	03/96-07/99	182 A2.000, 183 A1.000	1747	24x168	SK-1361	BTK	
1.8 16V LE, 1.8 GT 16V	03/96-07/99	182 A2.000, 183 A1.000	1747	24x168	SK-1361AQ1	BTKW	
1.8 16V LE, 1.8 GT 16V	03/96-07/99	182 A2.000, 183 A1.000	1747	15x130	SK-1664	BTK	
1.8 16V LE, 1.8 GT 16V	03/96-07/99	182 A2.000, 183 A1.000	1747	24x168; 15x130	SK-1755	BTK	
1.8 16V LE, 1.8 GT 16V	03/96-07/99	182 A2.000, 183 A1.000	1747	24x168; 15x130	SK-1755AQ1	BTKW	
1.8 i.e.	07/94-07/99	836 A5.000	1756	18x142; → 08/1997	SK-1151	BTK	
1.9 TDS	07/94-07/99	160 D1.000, 835 A4.000	1929	22x173	SK-1033	BTK	
2.0 16V, 2.0 Integrale	07/94-07/99	836 A3.000	1995	18x173	SK-1050	BTK	
1.6	10/94-07/99	159 B9.000	1581		0-N822	TB [TE]	
1.6 16V	01/96-07/99	182 A4.000	1581		0-N208	TB [TE]	
1.6 16V	01/96-07/99	182 A4.000	1581		0-N951	TB [DG]	
1.8 16V LE	03/96-07/99	182 A2.000	1747		0-N114	TB [TE]	
1.8 16V LE, 1.8 GT 16V	03/96-07/99	182 A2.000, 183 A1.000	1747		0-N1572	TB [TE]	
1.8 16V LE, 1.8 GT 16V	03/96-07/99	182 A2.000, 183 A1.000	1747		0-N938	TB [DG]	
1.8 GT 16V	03/96-07/99	183 A1.000	1747	→ 04/1998	0-N114	TB [TE]	
1.8 GT 16V	03/96-07/99	183 A1.000	1747	04/1998 →	0-N194	TB [TE]	
1.8 i.e.	07/94-07/99	836 A5.000	1756		0-N832	TB [TE]	
1.9 TDS	07/94-07/99	160 D1.000, 835 A4.000	1929		0-N835	TB [TE]	
1.9 TDS	07/94-07/99	160 D1.000, 835 A4.000	1929		0-N889	TB [DG]	
2.0 16V, 2.0 Integrale	07/94-07/99	836 A3.000	1995		0-N818	TB [TE]	
1.6, 1.6 16V	10/94-07/99	159 B9.000, 182 A4.000	1581		0-N187	VB [DG]	
1.8 16V LE, 1.8 GT 16V	03/96-07/99	182 A2.000, 183 A1.000	1747		0-N1407	VB [BT]	S
1.8 16V LE, 1.8 GT 16V	03/96-07/99	182 A2.000, 183 A1.000	1747	✳	0-N1628	VB [DG]	
1.9 TDS	07/94-07/99	160 D1.000, 835 A4.000	1929	✳:→933346; ✳	0-N1629	VB [DG]	



OPTIMAL®

LANCIA



CM³



Art. Nr.



ohne Halter

DEDRA SW (835)								
1.9 TDS	07/94-07/99	160 D1.000, 835 A4.000	1929	:933347→		0-N187	VB [DG]	
DELTA I (831AB0)								
1.5	09/79-12/92	831 A1.000, 831 B1.000	1498	19.05x118; :5782816→		SK-1138	BTK	
1.6 GT i.e., 1.6 HF Turbo	10/83-08/92	149 C2.000, 831 A7.000, 831 B3.000, 831 B7.000, 831 B7.046	1585	18x138		SK-1445	BTK	
1.9 Turbo DS	10/86-12/89	831 D1.000	1929	25.4x126		SK-1145S	BTK	
2.0 16V HF Evo Integrale, 2.0 16V HF Integrale	03/89-01/94	831 D5.000, 831 E5.000, 831 E5.046	1995	18x173		SK-1050	BTK	
2.0 16V HF Evo Integrale, 2.0 16V HF Integrale	03/89-01/94	831 D5.000, 831 E5.000, 831 E5.046	1995	18x145		SK-1546S	BTK	
2.0 HF Integrale	11/86-02/89	831 B5.000, 831 C5.000	1995	18x142		SK-1151	BTK	
1.3	09/79-08/92	831 A2.000, 831 B.000	1301	:8752816→		0-N818	TB [TE]	
1.5	09/79-12/92	831 A1.000, 831 B1.000	1498	:8752816→		0-N818	TB [TE]	
1.6 GT i.e., 1.6 HF Turbo	08/86-08/92	149 C2.000, 831 B3.000, 831 B7.000, 831 B7.046	1585			0-N823	TB [TE]	
1.9 Turbo DS	10/86-12/89	831 D1.000	1929			0-N826	TB [TE]	
2.0 16V HF Evo Integrale, 2.0 16V HF Integrale	03/89-01/94	831 D5.000, 831 E5.000, 831 E5.046	1995			0-N818	TB [TE]	
2.0 HF Integrale	11/86-12/92	831 B5.000, 831 C5.000, 831 C5.046	1995			0-N832	TB [TE]	
DELTA II (836)								
1.4 i.e.	10/94-08/99	160 A1.046, 836 A4.000	1372	15x138		SK-1031	BTK	
1.6 i.e.	06/93-08/99	835 C1.000	1581	15x138; 11/1993 →		SK-1031	BTK	
1.6 i.e.	03/96-08/99	182 A6.000	1581	25x158		SK-1076	BTK	
1.6 i.e. 16V	01/96-08/99	182 A4.000	1581	25x158; 09/1996 →		SK-1076	BTK	
1.8	02/96-09/99	182 A2.000	1747	18x142		SK-1151	BTK	
1.8 i.e.	06/93-08/99	835 C2.000	1756	18x142; 11/1993 →		SK-1151	BTK	
1.8 i.e.	07/94-08/99	835 C4.000, 836 A6.000, 836 C4.000	1756	18x142; → 08/1996		SK-1151	BTK	
1.8 i.e. 16V	03/96-08/99	182 A2.000	1747	24x168		SK-1361	BTK	
1.8 i.e. 16V	03/96-08/99	182 A2.000	1747	24x168		SK-1361AQ1	BTKW	
1.8 i.e. 16V	03/96-08/99	182 A2.000	1747	24x168; 15x130		SK-1755	BTK	
1.8 i.e. 16V	03/96-08/99	182 A2.000	1747	24x168; 15x130		SK-1755AQ1	BTKW	
1.8 i.e. 16V, 1.8 i.e. 16V GT	03/96-08/99	182 A2.000, 183 A1.000	1747	15x130		SK-1664	BTK	
1.8 i.e. 16V GT	03/96-08/99	183 A1.000	1747	24x168; → 04/1998		SK-1361	BTK	
1.8 i.e. 16V GT	03/96-08/99	183 A1.000	1747	24x168; → 04/1998		SK-1361AQ1	BTKW	
1.8 i.e. 16V GT	03/96-08/99	183 A1.000	1747	24x168; 05/1998 →		SK-1410	BTK	
1.8 i.e. 16V GT	03/96-08/99	183 A1.000	1747	24x168; 05/1998 →		SK-1410AQ1	BTKW	
1.8 i.e. 16V GT	03/96-08/99	183 A1.000	1747	24x168; 15x130; → 04/1998		SK-1755	BTK	
1.8 i.e. 16V GT	03/96-08/99	183 A1.000	1747	24x168; 15x130; → 04/1998		SK-1755AQ1	BTKW	
1.8 i.e. 16V GT	03/96-08/99	183 A1.000	1747	24x168; 15x130; 05/1998 →		SK-1756	BTK	
1.9 TD	10/94-08/99	160 D1.000, 835 A4.000	1929	22x173		SK-1033	BTK	
2.0 16V, 2.0 16V Turbo	06/93-08/99	175 A4.000, 836 A2.000, 836 A3.000	1995	18x173		SK-1050	BTK	
1.4 i.e.	10/94-08/99	160 A1.046, 836 A4.000	1372			0-N822	TB [TE]	
1.6 i.e.	06/93-08/99	835 C1.000	1581			0-N822	TB [TE]	
1.6 i.e., 1.6 i.e. 16V	01/96-08/99	182 A4.000, 182 A6.000	1581			0-N208	TB [TE]	
1.6 i.e., 1.6 i.e. 16V	01/96-08/99	182 A4.000, 182 A6.000	1581			0-N951	TB [DG]	
1.8 i.e.	06/93-08/99	835 C2.000, 835 C4.000, 836 A6.000, 836 C4.000	1756			0-N832	TB [TE]	
1.8 i.e. 16V	03/96-08/99	182 A2.000	1747			0-N114	TB [TE]	
1.8 i.e. 16V, 1.8 i.e. 16V GT	03/96-08/99	182 A2.000, 183 A1.000	1747			0-N1572	TB [TE]	
1.8 i.e. 16V, 1.8 i.e. 16V GT	03/96-08/99	182 A2.000, 183 A1.000	1747			0-N938	TB [DG]	
1.8 i.e. 16V GT	03/96-08/99	183 A1.000	1747	→ 04/1998		0-N114	TB [TE]	
1.8 i.e. 16V GT	03/96-08/99	183 A1.000	1747	04/1998 →		0-N194	TB [TE]	
1.9 TD	10/94-08/99	160 D1.000, 835 A4.000	1929			0-N835	TB [TE]	
1.9 TD	10/94-08/99	160 D1.000, 835 A4.000	1929			0-N889	TB [DG]	
2.0 16V, 2.0 16V Turbo	06/93-08/99	175 A4.000, 836 A2.000, 836 A3.000	1995			0-N818	TB [TE]	
1.4 i.e.	10/94-08/99	160 A1.046, 836 A4.000	1372			0-N187	VB [DG]	
1.6 i.e., 1.6 i.e. 16V	06/93-08/99	182 A4.000, 182 A6.000, 835 C1.000	1581			0-N187	VB [DG]	
1.8 i.e. 16V, 1.8 i.e. 16V GT	03/96-08/99	182 A2.000, 183 A1.000	1747			0-N1407	VB [BT]	S
1.8 i.e. 16V, 1.8 i.e. 16V GT	03/96-08/99	182 A2.000, 183 A1.000	1747			0-N1628	VB [DG]	
1.9 TD	10/94-08/99	160 D1.000, 835 A4.000	1929			0-N187	VB [DG]	
DELTA III (844)								
1.4 Bifuel	07/11-08/14	198 A4.000	1368	22x124		SK-1412	BTK	
1.4, 1.4 16V	09/08-08/14	198 A1.000, 198 A4.000, 198 A7.000	1368	22x124; Baumuster: 844		SK-1412	BTK	
1.4, 1.4 16V, 1.4 Bifuel	09/08-08/14	198 A1.000, 198 A4.000, 198 A7.000	1368	22x124		SK-1412AQ2	BTKW	
1.6 D Multijet	08/08-08/14	955 A4.000	1598	24x194; 09/2008 →		SK-1693	BTK	
1.6 D Multijet	08/08-08/14	198 A2.000, 944 A 3.000, 955 A4.000	1598	24x194		SK-1693AQ1	BTKW	



CM³



Art. Nr.



DELTA III (844)

1.6 D Multijet	09/08-08/14	198 A2.000, 944 A 3.000	1598	24x194	SK-1693	BTK	
1.8	01/09-08/14	939 B1.000	1742	24x171	SK-1733	BTK	
1.8	01/09-08/14	939 B1.000	1742	24x171	SK-1733AQ1	BTKW	
1.9 D Multijet	01/09-08/14	844 A1.000	1910	24x199	SK-1586	BTK	
1.9 D Multijet	01/09-08/14	844 A1.000	1910	24x199	SK-1586AQ1	BTKW	
2.0 D Multijet	09/08-08/14	198 A5.000, 198 A8.000, 844 A2.000	1956	24x199	SK-1586	BTK	
2.0 D Multijet	09/08-08/14	198 A5.000, 198 A8.000, 844 A2.000	1956	24x199	SK-1586AQ1	BTKW	
1.4, 1.4 16V, 1.4 Bifuel	09/08-08/14	198 A1.000, 198 A4.000, 198 A7.000	1368		0-N195	TB [TE]	
1.6 D Multijet	08/08-08/14	198 A2.000, 944 A 3.000, 955 A4.000	1598		0-N2149	TB [DG]	
1.6 D Multijet	09/08-08/14	198 A2.000	1598		0-N115	TB [TE]	
1.8	01/09-08/14	939 B1.000	1742		0-N2149	TB [DG]	
1.8	01/09-08/14	939 B1.000	1742		0-N2150	TB [TE]	
1.9 D Multijet	01/09-08/14	844 A1.000	1910		0-N115	TB [TE]	
1.9 D Multijet	01/09-08/14	844 A1.000	1910		0-N2149	TB [DG]	
2.0 D Multijet	09/08-08/14	198 A5.000, 198 A8.000	1956		0-N115	TB [TE]	
2.0 D Multijet	09/08-08/14	198 A5.000, 198 A8.000, 844 A2.000	1956		0-N2149	TB [DG]	
1.4, 1.4 16V, 1.4 Bifuel	09/08-08/14	198 A1.000, 198 A4.000, 198 A7.000	1368		0-N1517	VB [BT]	S
1.6 D Multijet	09/08-08/14	198 A2.000	1598	→ 12/2009	0-N1503	VB [BT]	S
1.6 D Multijet	09/08-08/14	198 A2.000	1598	→ 12/2009; *	0-N1522	VB [DG]	
1.6 D Multijet	09/08-08/14	198 A2.000	1598	12/2009 →	0-N2030	VB [BT]	S
1.6 D Multijet	09/08-08/14	198 A2.000	1598	→ 12/2009; Rippenanzahl: 6	0-N2122	VB [DG]	
1.8	01/09-08/14	939 B1.000	1742		0-N2030	VB [BT]	S
1.8	01/09-08/14	939 B1.000	1742	Rippenanzahl: 6	0-N2122	VB [DG]	
1.9 D Multijet	01/09-08/14	844 A1.000	1910	→ 12/2009	0-N1503	VB [BT]	S
1.9 D Multijet	01/09-08/14	844 A1.000	1910	→ 12/2009; *	0-N1522	VB [DG]	
1.9 D Multijet	01/09-08/14	844 A1.000	1910	12/2009 →	0-N2030	VB [BT]	S
1.9 D Multijet	01/09-08/14	844 A1.000	1910	→ 12/2009; Rippenanzahl: 6	0-N2122	VB [DG]	
2.0 D Multijet	09/08-08/14	198 A5.000, 198 A8.000	1956	→ 12/2009	0-N1503	VB [BT]	S
2.0 D Multijet	09/08-08/14	198 A5.000, 198 A8.000	1956	→ 12/2009; *	0-N1522	VB [DG]	
2.0 D Multijet	09/08-08/14	198 A5.000, 198 A8.000	1956	12/2009 →	0-N2030	VB [BT]	S
2.0 D Multijet	09/08-08/14	198 A5.000, 198 A8.000	1956	→ 12/2009; Rippenanzahl: 6	0-N2122	VB [DG]	

FLAVIA Cabriolet (JS)

2.4	03/12-12/14	EDG	2360		0-N2048	VB [DG]	
2.4	03/12-12/14	EDG	2360		0-N2112	VB [BT]	S

KAPPA (838A)

2.0 16V Turbo	02/95-10/01	838 A4.000	1995	18x173	SK-1050	BTK	
2.0 20V , 2.0 20V Turbo	10/94-10/01	175 A3.000, 838 A1.000, 838 A6.000	1998	24x167	SK-1411	BTK	
2.4 20V	08/94-10/01	838 A2.000, 838 A2.027	2446	24x168; 06/1995 →	SK-1446	BTK	
2.4 JTD	06/98-10/01	838 A8.000	2387	24x190; Baumuster: 838AL1AA	SK-1112	BTK	
2.4 JTD	06/98-10/01	838 A8.000	2387	24x190	SK-1112AQ1	BTKW	
2.4 T.DS	08/94-10/01	838 A3.000, 838 A7.000	2387	24x193	SK-1080	BTK	
2.4 T.DS	08/94-10/01	838 A3.000, 838 A7.000	2387	24x193; mit Zubehör	SK-1646	BTK	
2.4 T.DS	08/94-10/01	838 A3.000, 838 A7.000	2387	24x193	SK-1646AQ1	BTKW	
2.0 16V Turbo	02/95-10/01	838 A4.000	1995		0-N818	TB [TE]	
2.0 20V , 2.0 20V Turbo	10/94-10/01	175 A3.000, 838 A1.000, 838 A6.000	1998		0-N196	TB [TE]	
2.0 20V , 2.0 20V Turbo	10/94-10/01	175 A3.000, 838 A1.000, 838 A6.000	1998		0-N950	TB [DG]	
2.4 20V	08/94-10/01	838 A2.000, 838 A2.027	2446		0-N196	TB [TE]	
2.4 20V	08/94-10/01	838 A2.000, 838 A2.027	2446		0-N950	TB [DG]	
2.4 JTD , 2.4 T.DS	08/94-10/01	838 A3.000, 838 A7.000, 838 A8.000	2387		0-N115	TB [TE]	
2.4 JTD , 2.4 T.DS	08/94-10/01	838 A3.000, 838 A7.000, 838 A8.000	2387		0-N950	TB [DG]	
3.0 24V	08/94-10/01	838 B.000	2959		0-N1092	TB [TE]	
3.0 24V	08/94-10/01	838 B.000	2959	07/1995 →	0-N1093	TB [DG]	
2.0 16V Turbo	02/95-10/01	838 A4.000	1995		0-N1652	VB [BT]	
2.0 20V	10/94-10/01	838 A1.000, 838 A6.000	1998	EMMA:577837 →; †	0-N1490S	VB [TE]	
2.0 20V	10/94-10/01	838 A1.000, 838 A6.000	1998	EMMA: →577836; mit Anbaumaterial	0-N1593	VB [BT]	S
2.0 20V , 2.0 20V Turbo	10/94-10/01	175 A3.000, 838 A1.000, 838 A6.000	1998		0-N1404	VB [DG]	
2.0 20V , 2.0 20V Turbo	10/94-10/01	175 A3.000, 838 A1.000, 838 A6.000	1998		0-N1652	VB [BT]	
2.0 20V , 2.0 20V Turbo	10/94-10/01	175 A3.000, 838 A1.000, 838 A6.000	1998		0-N1916	VB [BT]	
2.0 20V Turbo	06/98-10/01	175 A3.000	1998	†	0-N1490S	VB [TE]	
2.4 20V	08/94-10/01	838 A2.000, 838 A2.027	2446		0-N1404	VB [DG]	
2.4 20V	08/94-10/01	838 A2.000, 838 A2.027	2446	EMMA:577837 →; †	0-N1490S	VB [TE]	
2.4 20V	08/94-10/01	838 A2.000, 838 A2.027	2446	EMMA: →577836; mit Anbaumaterial	0-N1593	VB [BT]	S
2.4 20V	08/94-10/01	838 A2.000, 838 A2.027	2446		0-N1652	VB [BT]	
2.4 20V	08/94-10/01	838 A2.000, 838 A2.027	2446		0-N1916	VB [BT]	



OPTIMAL®

LANCIA



CM³



Art. Nr.



KAPPA (838A)

2.4 JTD	06/98-10/01	838 A8.000	2387	‡		0-N1490S	VB [TE]	
2.4 JTD , 2.4 T.DS	08/94-10/01	838 A3.000, 838 A7.000, 838 A8.000	2387			0-N1404	VB [DG]	
2.4 JTD , 2.4 T.DS	08/94-10/01	838 A3.000, 838 A7.000, 838 A8.000	2387			0-N1652	VB [BT]	
2.4 JTD , 2.4 T.DS	08/94-10/01	838 A3.000, 838 A7.000, 838 A8.000	2387			0-N1916	VB [BT]	
2.4 T.DS	08/94-10/01	838 A3.000, 838 A7.000	2387		577837 →; ‡	0-N1490S	VB [TE]	
2.4 T.DS	08/94-10/01	838 A3.000, 838 A7.000	2387		→577836; mit Anbaumaterial	0-N1593	VB [BT]	S
3.0 24V	08/94-10/01	838 B.000	2959		07/1995 →	0-N1594	VB [DG]	
3.0 24V	08/94-10/01	838 B.000	2959		07/1995 →; ‡	0-N1595	VB [BT]	S

KAPPA Coupe (838)

2.0 16V Turbo	11/96-03/01	838 A4.000	1995		18x173	SK-1050	BTK	
2.0 20V Turbo	06/98-03/01	175 A3.000	1998		24x167	SK-1411	BTK	
2.4 20V	11/96-03/01	838 A2.000	2446		24x168; 02/1997 →	SK-1446	BTK	
2.0 16V Turbo	11/96-03/01	838 A4.000	1995			0-N818	TB [TE]	
2.0 20V , 2.0 20V Turbo	07/96-03/01	175 A3.000, 838 A6.000	1998			0-N196	TB [TE]	
2.0 20V , 2.0 20V Turbo	07/96-03/01	175 A3.000, 838 A6.000	1998			0-N950	TB [DG]	
2.4 20V	11/96-03/01	838 A2.000	2446			0-N196	TB [TE]	
2.4 20V	11/96-03/01	838 A2.000	2446			0-N950	TB [DG]	
3.0 24V	11/96-03/01	838 B.000	2959			0-N1092	TB [TE]	
3.0 24V	11/96-03/01	838 B.000	2959			0-N1093	TB [DG]	
2.0 16V Turbo	11/96-03/01	838 A4.000	1995			0-N1652	VB [BT]	
2.0 20V	07/96-03/01	838 A6.000	1998		577837 →; ‡	0-N1490S	VB [TE]	
2.0 20V	07/96-03/01	838 A6.000	1998		→577836; mit Anbaumaterial	0-N1593	VB [BT]	S
2.0 20V Turbo	06/98-03/01	175 A3.000	1998	‡		0-N1490S	VB [TE]	
2.0 20V , 2.0 20V Turbo	07/96-03/01	175 A3.000, 838 A6.000	1998			0-N1404	VB [DG]	
2.0 20V , 2.0 20V Turbo	07/96-03/01	175 A3.000, 838 A6.000	1998			0-N1652	VB [BT]	
2.0 20V , 2.0 20V Turbo	07/96-03/01	175 A3.000, 838 A6.000	1998			0-N1916	VB [BT]	
2.4 20V	11/96-03/01	838 A2.000	2446			0-N1404	VB [DG]	
2.4 20V	11/96-03/01	838 A2.000	2446		577837 →; ‡	0-N1490S	VB [TE]	
2.4 20V	11/96-03/01	838 A2.000	2446		→577836; mit Anbaumaterial	0-N1593	VB [BT]	S
2.4 20V	11/96-03/01	838 A2.000	2446			0-N1652	VB [BT]	
2.4 20V	11/96-03/01	838 A2.000	2446			0-N1916	VB [BT]	
3.0 24V	11/96-03/01	838 B.000	2959			0-N1594	VB [DG]	
3.0 24V	11/96-03/01	838 B.000	2959	‡		0-N1595	VB [BT]	S

KAPPA SW (838B)

2.0 16V Turbo	07/96-10/01	838 A4.000	1995		18x173	SK-1050	BTK	
2.0 20V , 2.0 20V Turbo	07/96-10/01	175 A3.000, 838 A6.000	1998		24x167	SK-1411	BTK	
2.4 20V	07/96-10/01	838 A2.000	2446		24x168	SK-1446	BTK	
2.4 JTD	06/98-10/01	838 A8.000	2387		24x190; Baumuster: 838BL1AA	SK-1112	BTK	
2.4 JTD	06/98-10/01	838 A8.000	2387		24x190	SK-1112AQ1	BTKW	
2.4 T.DS	07/96-10/01	838 A3.000, 838 A7.000	2387		24x193	SK-1080	BTK	
2.4 T.DS	07/96-10/01	838 A3.000, 838 A7.000	2387		24x193; mit Zubehör	SK-1646	BTK	
2.4 T.DS	07/96-10/01	838 A3.000, 838 A7.000	2387		24x193	SK-1646AQ1	BTKW	
2.0 16V Turbo	07/96-10/01	838 A4.000	1995			0-N818	TB [TE]	
2.0 20V , 2.0 20V Turbo	07/96-10/01	175 A3.000, 838 A6.000	1998			0-N196	TB [TE]	
2.0 20V , 2.0 20V Turbo	07/96-10/01	175 A3.000, 838 A6.000	1998			0-N950	TB [DG]	
2.4 20V	07/96-10/01	838 A2.000	2446			0-N196	TB [TE]	
2.4 20V	07/96-10/01	838 A2.000	2446			0-N950	TB [DG]	
2.4 JTD , 2.4 T.DS	07/96-10/01	838 A3.000, 838 A7.000, 838 A8.000	2387			0-N115	TB [TE]	
2.4 JTD , 2.4 T.DS	07/96-10/01	838 A3.000, 838 A7.000, 838 A8.000	2387			0-N950	TB [DG]	
3.0 24V	07/96-10/01	838 B.000	2959			0-N1092	TB [TE]	
3.0 24V	07/96-10/01	838 B.000	2959			0-N1093	TB [DG]	
2.0 16V Turbo	07/96-10/01	838 A4.000	1995			0-N1652	VB [BT]	
2.0 20V	07/96-10/01	838 A6.000	1998		577837 →; ‡	0-N1490S	VB [TE]	
2.0 20V	07/96-10/01	838 A6.000	1998		→577836; mit Anbaumaterial	0-N1593	VB [BT]	S
2.0 20V , 2.0 20V Turbo	07/96-10/01	175 A3.000, 838 A6.000	1998			0-N1404	VB [DG]	
2.0 20V , 2.0 20V Turbo	07/96-10/01	175 A3.000, 838 A6.000	1998			0-N1652	VB [BT]	
2.0 20V , 2.0 20V Turbo	07/96-10/01	175 A3.000, 838 A6.000	1998			0-N1916	VB [BT]	
2.0 20V Turbo	06/98-10/01	175 A3.000	1998	‡		0-N1490S	VB [TE]	
2.4 20V	07/96-10/01	838 A2.000	2446			0-N1404	VB [DG]	
2.4 20V	07/96-10/01	838 A2.000	2446		577837 →; ‡	0-N1490S	VB [TE]	
2.4 20V	07/96-10/01	838 A2.000	2446		→577836; mit Anbaumaterial	0-N1593	VB [BT]	S
2.4 20V	07/96-10/01	838 A2.000	2446			0-N1652	VB [BT]	
2.4 20V	07/96-10/01	838 A2.000	2446			0-N1916	VB [BT]	
2.4 JTD	06/98-10/01	838 A8.000	2387	‡		0-N1490S	VB [TE]	



CM³



Art. Nr.



ohne Halter

KAPPA SW (838B)							
2.4 JTD , 2.4 T.DS	07/96-10/01	838 A3.000, 838 A7.000, 838 A8.000	2387			0-N1404	VB [DG]
2.4 JTD , 2.4 T.DS	07/96-10/01	838 A3.000, 838 A7.000, 838 A8.000	2387			0-N1652	VB [BT]
2.4 JTD , 2.4 T.DS	07/96-10/01	838 A3.000, 838 A7.000, 838 A8.000	2387			0-N1916	VB [BT]
2.4 T.DS	07/96-10/01	838 A3.000, 838 A7.000	2387	:577837→; †		0-N1490S	VB [TE]
2.4 T.DS	07/96-10/01	838 A3.000, 838 A7.000	2387	:-→577836; mit Anbaumaterial		0-N1593	VB [BT] S
3.0 24V	07/96-10/01	838 B.000	2959			0-N1594	VB [DG]
3.0 24V	07/96-10/01	838 B.000	2959	†		0-N1595	VB [BT] S
LYBRA (839AX)							
1.6	10/00-10/05	182 B6.000	1596	25x158		SK-1076	BTK
1.6 16V	07/99-10/05	182 A4.000	1581	25x158		SK-1076	BTK
1.8 16V	07/99-10/05	839 A4.000, 839 A7.000, 839 A9.000	1747	24x168		SK-1410	BTK
1.8 16V	07/99-10/05	839 A4.000, 839 A7.000, 839 A9.000	1747	24x168		SK-1410AQ1	BTKW
1.8 16V	07/99-10/05	839 A4.000, 839 A7.000, 839 A9.000	1747	15x130		SK-1664	BTK
1.8 16V	07/99-10/05	839 A4.000, 839 A7.000, 839 A9.000	1747	24x168; 15x130		SK-1756	BTK
1.9 JTD	07/99-10/05	937 A2.000, AR 32302, AR 37101	1910	24x190; mit Zubehör		SK-1629	BTK
1.9 JTD	07/99-10/05	937 A2.000, AR 32302, AR 37101	1910	24x190; mit Zubehör		SK-1629AQ1	BTKW
2.0 20V	07/99-09/00	182 B7.000	1998	24x167		SK-1411	BTK
2.0 20V	09/00-10/05	185 A8.000	1998	24x166		SK-1637	BTK
2.4 JTD	07/99-02/01	839 A5.000	2387	24x190; Baumuster: 839AXE1A		SK-1112	BTK
2.4 JTD	07/99-10/05	839 A5.000, AR 32501, 839 A6.000, 841 C.000	2387	24x190		SK-1112AQ1	BTKW
2.4 JTD	09/00-05/02	839 A6.000	2387	24x190; Baumuster: 839AXL1A		SK-1112	BTK
2.4 JTD	05/02-10/05	841 C.000	2387	24x190; Baumuster: 839AX		SK-1112	BTK
1.6 16V	07/99-10/05	182 A4.000	1581			0-N208	TB [TE]
1.6 16V	07/99-10/05	182 A4.000	1581			0-N951	TB [DG]
1.8 16V	07/99-10/05	839 A4.000, 839 A7.000, 839 A9.000	1747			0-N1572	TB [TE]
1.8 16V	07/99-10/05	839 A4.000, 839 A7.000, 839 A9.000	1747			0-N194	TB [TE]
1.8 16V	07/99-10/05	839 A4.000, 839 A7.000, 839 A9.000	1747			0-N938	TB [DG]
1.9 JTD	07/99-10/05	937 A2.000, AR 32302, AR 37101	1910			0-N115	TB [TE]
1.9 JTD	07/99-05/01	AR 32302, AR 37101	1910			0-N1326	TB [DG]
1.9 JTD	05/01-10/05	937 A2.000	1910	:-→4130907		0-N1326	TB [DG]
1.9 JTD	05/01-10/05	937 A2.000	1910	:4130908→		0-N2149	TB [DG]
2.0 20V	07/99-10/05	182 B7.000, 185 A8.000	1998			0-N196	TB [TE]
2.0 20V	07/99-10/05	182 B7.000, 185 A8.000	1998			0-N950	TB [DG]
2.4 JTD	07/99-10/05	839 A5.000, AR 32501, 839 A6.000, 841 C.000	2387			0-N115	TB [TE]
2.4 JTD	07/99-10/05	839 A5.000, AR 32501, 839 A6.000, 841 C.000	2387			0-N950	TB [DG]
3.8 AWD	10/01-10/05	192 A2.000	2446			0-N189	TB [DG]
1.6 16V	07/99-10/05	182 A4.000	1581	02/2000 →		0-N1450	VB [DG]
1.6 16V	07/99-10/05	182 A4.000	1581	→ 02/2000		0-N187	VB [DG]
1.8 16V	07/99-10/05	839 A4.000, 839 A7.000, 839 A9.000	1747	☼		0-N1628	VB [DG]
1.8 16V	07/99-10/05	839 A9.000	1747			0-N2117	VB [BT] S
1.9 JTD	07/99-10/05	937 A2.000, AR 32302, AR 37101	1910			0-N1415	VB [DG]
1.9 JTD	07/99-10/05	937 A2.000, AR 32302, AR 37101	1910			0-N1487	VB [BT] S
2.0 20V	07/99-10/05	182 B7.000, 185 A8.000	1998			0-N1596	VB [DG]
2.0 20V	07/99-10/05	182 B7.000, 185 A8.000	1998			0-N1599	VB [BT] S
2.0 20V	07/99-10/05	182 B7.000, 185 A8.000	1998			0-N1916	VB [BT]
2.0 20V	07/99-10/05	182 B7.000, 185 A8.000	1998			0-N1966	VB [DG]
2.4 JTD	07/99-10/05	839 A5.000, AR 32501, 839 A6.000, 841 C.000	2387			0-N1404	VB [DG]
2.4 JTD	07/99-10/05	839 A5.000, AR 32501, 839 A6.000, 841 C.000	2387	†		0-N1490S	VB [TE]
2.4 JTD	07/99-10/05	839 A5.000, AR 32501, 839 A6.000, 841 C.000	2387			0-N1894	VB [BT]
2.4 JTD	07/99-10/05	839 A5.000, AR 32501, 839 A6.000, 841 C.000	2387			0-N1916	VB [BT]
LYBRA SW (839BX)							
1.6	10/00-10/05	182 B6.000	1596	25x158		SK-1076	BTK
1.6 16V	07/99-10/05	182 A4.000	1581	25x158		SK-1076	BTK
1.8 16V	07/99-10/05	839 A4.000, 839 A7.000	1747	24x168		SK-1410	BTK
1.8 16V	07/99-10/05	839 A4.000, 839 A7.000	1747	24x168		SK-1410AQ1	BTKW
1.8 16V	07/99-10/05	839 A4.000, 839 A7.000	1747	15x130		SK-1664	BTK
1.8 16V	07/99-10/05	839 A4.000, 839 A7.000	1747	24x168; 15x130		SK-1756	BTK
1.9 JTD	07/99-10/05	937 A2.000, AR 32302, AR 37101	1910	24x190; mit Zubehör		SK-1629	BTK
1.9 JTD	07/99-10/05	937 A2.000, AR 32302, AR 37101	1910	24x190; mit Zubehör		SK-1629AQ1	BTKW



OPTIMAL®

LANCIA



CM³



Art. Nr.



LYBRA SW (839BX)

2.0 20V	07/99-09/00	182 B7.000	1998	24x167	SK-1411	BTK
2.0 20V	09/00-10/05	185 A8.000	1998	24x166	SK-1637	BTK
2.4 JTD	10/99-09/00	839 A5.000	2387	24x190; Baumuster: 839BXE1A	SK-1112	BTK
2.4 JTD	10/99-10/05	839 A5.000, AR 32501, 839 A6.000, 841 C.000	2387	24x190	SK-1112AQ1	BTKW
2.4 JTD	09/00-10/05	839 A6.000	2387	24x190; Baumuster: 839BXL1A	SK-1112	BTK
2.4 JTD	05/02-10/05	841 C.000	2387	24x190; Baumuster: 839BX	SK-1112	BTK
1.6 16V	07/99-10/05	182 A4.000	1581		0-N208	TB [TE]
1.6 16V	07/99-10/05	182 A4.000	1581		0-N951	TB [DG]
1.8 16V	07/99-10/05	839 A4.000, 839 A7.000	1747		0-N1572	TB [TE]
1.8 16V	07/99-10/05	839 A4.000, 839 A7.000	1747		0-N194	TB [TE]
1.8 16V	07/99-10/05	839 A4.000, 839 A7.000	1747		0-N938	TB [DG]
1.9 JTD	07/99-10/05	937 A2.000, AR 32302, AR 37101	1910		0-N115	TB [TE]
1.9 JTD	07/99-05/01	AR 32302, AR 37101	1910		0-N1326	TB [DG]
1.9 JTD	05/01-10/05	937 A2.000	1910	ENGIN: →4130907	0-N1326	TB [DG]
1.9 JTD	05/01-10/05	937 A2.000	1910	ENGIN: 4130908 →	0-N2149	TB [DG]
2.0 20V	07/99-10/05	182 B7.000, 185 A8.000	1998		0-N196	TB [TE]
2.0 20V	07/99-10/05	182 B7.000, 185 A8.000	1998		0-N950	TB [DG]
2.4 JTD	10/99-10/05	839 A5.000, AR 32501, 839 A6.000, 841 C.000	2387		0-N115	TB [TE]
2.4 JTD	10/99-10/05	839 A5.000, AR 32501, 839 A6.000, 841 C.000	2387		0-N950	TB [DG]
1.6 16V	07/99-10/05	182 A4.000	1581	02/2000 →	0-N1450	VB [DG]
1.6 16V	07/99-10/05	182 A4.000	1581	→ 02/2000	0-N187	VB [DG]
1.8 16V	07/99-10/05	839 A4.000, 839 A7.000	1747	✳	0-N1628	VB [DG]
1.9 JTD	07/99-10/05	937 A2.000, AR 32302, AR 37101	1910		0-N1415	VB [DG]
1.9 JTD	07/99-10/05	937 A2.000, AR 32302, AR 37101	1910		0-N1487	VB [BT] S
2.0 20V	07/99-10/05	182 B7.000, 185 A8.000	1998		0-N1596	VB [DG]
2.0 20V	07/99-10/05	182 B7.000, 185 A8.000	1998		0-N1599	VB [BT] S
2.0 20V	07/99-10/05	182 B7.000, 185 A8.000	1998		0-N1916	VB [BT]
2.0 20V	07/99-10/05	182 B7.000, 185 A8.000	1998		0-N1966	VB [DG]
2.4 JTD	10/99-10/05	839 A5.000, AR 32501, 839 A6.000, 841 C.000	2387		0-N1404	VB [DG]
2.4 JTD	10/99-10/05	839 A5.000, AR 32501, 839 A6.000, 841 C.000	2387	†	0-N1490S	VB [TE]
2.4 JTD	10/99-10/05	839 A5.000, AR 32501, 839 A6.000, 841 C.000	2387		0-N1894	VB [BT]
2.4 JTD	09/00-10/05	839 A6.000, 841 C.000	2387		0-N1916	VB [BT]

MUSA (350)

1.4	10/04-09/12	192 B2.000, 843 A 1.000	1368	22x124; Baumuster: 350	SK-1412	BTK
1.4	10/04-09/12	192 B2.000, 843 A 1.000	1368	22x124	SK-1412AQ2	BTKW
1.4	09/05-09/12	350 A1.000	1368	22x129; → 06/2008	SK-1677AQ1	BTKW
1.4, 1.4 LPG	09/05-09/12	350 A1.000	1368	22x129	SK-1677	BTK
1.6 D Multijet	07/08-09/12	350 A2.000, 350 A2.000, 350 A3.000	1598	24x194	SK-1693	BTK
1.6 D Multijet	07/08-09/12	350 A2.000, 350 A2.000, 350 A3.000	1598	24x194	SK-1693AQ1	BTKW
1.9 D Multijet	10/04-09/12	188 B2.000	1910	24x190; mit Zubehör	SK-1629	BTK
1.9 D Multijet	10/04-09/12	188 B2.000	1910	24x190; mit Zubehör	SK-1629AQ1	BTKW
1.4	10/04-09/12	192 B2.000, 843 A 1.000	1368		0-N195	TB [TE]
1.4, 1.4 LPG	09/05-09/12	350 A1.000	1368		0-N1616	TB [TE]
1.6 D Multijet	07/08-09/12	350 A2.000	1598		0-N115	TB [TE]
1.6 D Multijet	07/08-09/12	350 A2.000, 350 A2.000, 350 A3.000	1598		0-N2149	TB [DG]
1.9 D Multijet	10/04-09/12	188 B2.000	1910		0-N115	TB [TE]
1.9 D Multijet	10/04-09/12	188 B2.000	1910		0-N2149	TB [DG]
1.3 D Multijet	10/04-09/12	188 A9.000, 199 A3.000, 199 B1.000	1248		0-N1478S	VB [TE]
1.4, 1.4 LPG	10/04-09/12	192 B2.000, 350 A1.000, 843 A 1.000	1368		0-N1517	VB [BT] S
1.6 D Multijet	07/08-09/12	350 A2.000	1598		0-N1503	VB [BT] S
1.6 D Multijet	07/08-09/12	350 A3.000	1598		0-N1503	VB [BT] S
1.6 D Multijet	07/08-09/12	350 A2.000, 350 A2.000, 350 A3.000	1598		0-N1522	VB [DG]
1.6 D Multijet	07/08-09/12	350 A2.000, 350 A2.000, 350 A3.000	1598	Rippenanzahl: 6	0-N2122	VB [DG]
1.9 D Multijet	10/04-09/12	188 B2.000	1910		0-N1408	VB [DG]
1.9 D Multijet	10/04-09/12	188 B2.000	1910		0-N1415	VB [DG]
1.9 D Multijet	10/04-09/12	188 B2.000	1910		0-N1487	VB [BT] S

PHEDRA (179)

2.0	09/02-11/10	RFN (EW10J4)	1997	25.4x153	SK-1482	BTK
2.0	09/02-11/10	RFN (EW10J4)	1997	25.4x153	SK-1482AQ1	BTKW
2.0 D Multijet, 2.0 JTD	06/06-11/10	RHK (DW10UTED4), RHR (DW10BTED4)	1997	25.4x116	SK-1594	BTK

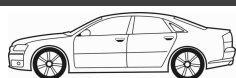

CM³



Art. Nr.



PHEDRA (179)							
2.0 D Multijet, 2.0 JTD	06/06-11/10	RHK (DW10UTED4), RHR (DW10BTED4)	1997	25.4x116		SK-1594AQ1	BTKW
2.0 JTD	09/02-11/10	RHW (DW10ATED4)	1997	25.4x144; Baumuster: 179AXB1A		SK-1534	BTK
2.0 JTD	09/02-11/10	RHM (DW10ATED4), RHW (DW10ATED4)	1997	25.4x144		SK-1534AQ1	BTKW
2.0 JTD	07/03-11/10	RHM (DW10ATED4)	1997	25.4x144; Baumuster: 179		SK-1534	BTK
2.2 D Multijet	03/08-11/10	4HS, 4HT	2179	25.4x118		SK-1692	BTK
2.2 D Multijet, 2.2 JTD	04/06-11/10	4HP, 4HR, 4HS, 4HT	2179	25.4x118		SK-1692AQ1	BTKW
2.2 JTD	09/02-11/10	4HW (DW12ATED4)	2179	25.4x146; → 04/2004		SK-1394	BTK
2.2 JTD	09/02-11/10	4HW (DW12ATED4)	2179	25.4x146; → 04/2004		SK-1394AQ1	BTKW
2.2 JTD	09/02-11/10	4HW (DW12ATED4)	2179	25.4x146; 05/2004 →; Baumuster: 179AXC1A		SK-1614	BTK
2.2 JTD	09/02-11/10	4HW (DW12ATED4)	2179	25.4x146; 05/2004 →		SK-1614AQ1	BTKW
2.2 JTD	04/06-11/10	4HP, 4HR	2179	25.4x118; 12/2007 →		SK-1692	BTK
3.0 V6	09/02-11/10	ES9 J4S	2946	32x259		SK-1483	BTK
3.0 V6	09/02-11/10	ES9 J4S	2946	32x259		SK-1483AQ1	BTKW
2.0	09/02-11/10	RFN (EW10J4)	1997			0-N1057	TB [TE]
2.0	09/02-11/10	RFN (EW10J4)	1997			0-N1065	TB [DG]
2.0 D Multijet, 2.0 JTD	06/06-11/10	RHK (DW10UTED4), RHR (DW10BTED4)	1997			0-N1334	TB [DG]
2.0 JTD	09/02-11/10	RHM (DW10ATED4), RHW (DW10ATED4)	1997			0-N118P	TB [TE]
2.0 JTD	09/02-11/10	RHM (DW10ATED4), RHW (DW10ATED4)	1997			0-N119P	TB [DG]
2.2 D Multijet, 2.2 JTD	04/06-11/10	4HP, 4HR, 4HS, 4HT	2179			0-N1334	TB [DG]
2.2 D Multijet, 2.2 JTD	04/06-11/10	4HP, 4HR, 4HS, 4HT	2179			0-N2018	TB [BT]
2.2 JTD	09/02-11/10	4HW (DW12ATED4)	2179	→ 12/2003		0-N118P	TB [TE]
2.2 JTD	09/02-11/10	4HW (DW12ATED4)	2179			0-N119P	TB [DG]
2.2 JTD	09/02-11/10	4HW (DW12ATED4)	2179	01/2004 →		0-N1357	TB [TE]
3.0 V6	09/02-11/10	ES9 J4S	2946			0-N1056	TB [TE]
3.0 V6	09/02-11/10	ES9 J4S	2946			0-N170	TB [DG]
3.0 V6	09/02-11/10	ES9 J4S	2946			0-N171	TB [DG]
2.0	09/02-11/10	RFN (EW10J4)	1997			0-N1391	VB [BT] S
2.0	09/02-11/10	RFN (EW10J4)	1997			0-N1416	VB [DG]
2.0	09/02-11/10	RFN (EW10J4)	1997	11/2004 →		0-N2276	VB [DG]
2.0 D Multijet, 2.0 JTD	06/06-11/10	RHK (DW10UTED4), RHR (DW10BTED4)	1997			0-N1327	VB [BT]
2.0 D Multijet, 2.0 JTD	06/06-11/10	RHK (DW10UTED4), RHR (DW10BTED4)	1997	→ 07/2007; VET→11194		0-N2037	VB [BT] S
2.0 D Multijet, 2.0 JTD	06/06-11/10	RHK (DW10UTED4), RHR (DW10BTED4)	1997	07/2007 →; VET11195→		0-N2046	VB [BT] S
2.0 JTD	09/02-11/10	RHM (DW10ATED4), RHW (DW10ATED4)	1997			0-N1320	VB [TE]
2.0 JTD	09/02-11/10	RHM (DW10ATED4), RHW (DW10ATED4)	1997			0-N1493	VB [BT] S
2.2 D Multijet, 2.2 JTD	04/06-11/10	4HP, 4HR, 4HS, 4HT	2179			0-N2042	VB [BT] S
2.2 JTD	09/02-11/10	4HW (DW12ATED4)	2179			0-N1413	VB [DG]
2.2 JTD	09/02-11/10	4HW (DW12ATED4)	2179			0-N1493	VB [BT] S
3.0 V6	09/02-11/10	ES9 J4S	2946			0-N1449	VB [TE]
3.0 V6	09/02-11/10	ES9 J4S	2946			0-N1473	VB [BT] S
3.0 V6	09/02-11/10	ES9 J4S	2946			0-N1757	VB [VD]
PRISMA (831AB0)							
1.5	01/83-04/86	831 A1.000	1498	19.05x118; :5782816→		SK-1138	BTK
1.5	09/85-02/92	138 C2.048, 831 B1.048, 831 B1.000	1498	19.05x118		SK-1138	BTK
1.6, 1.6 i.e., 1.6 i.e. Super	05/86-02/92	149 C2.000, 831 B6.000, 831 B7.000	1585	18x138		SK-1445	BTK
1.5	01/83-02/92	138 C2.048, 831 B1.048, 831 A1.000, 831 B1.000	1498	:8752816→		0-N818	TB [TE]
1.6, 1.6 i.e., 1.6 i.e. Super	05/86-02/92	149 C2.000, 831 B6.000, 831 B7.000	1585			0-N823	TB [TE]
1.9 Diesel	01/83-02/92	831 D.000	1911			0-N826	TB [TE]
1.9 Turbo Diesel	05/85-12/89	831 D1.000	1928			0-N826	TB [TE]
2.0 i.e. 4WD	04/86-12/89	831 B4.000	1995			0-N832	TB [TE]
THEMA (834)							
2000 16V, 2000 16V Turbo, 2000 i.e. 16V, 2000 i.e. 16V Turbo	05/88-07/94	834 B2.000, 834 B2.246, 834 C1.000, 834 C1.246, 834 F1.000, 834 F2.000	1995	18x173		SK-1050	BTK
2000 i.e., 2000 i.e. 16V Turbo, 2000 i.e. Turbo	07/86-05/92	834 B.146, 834 C.146, 834 C1.246	1995	18x142		SK-1151	BTK
2000 i.e., 2000 i.e. Turbo	11/84-09/88	834 B.000, 834 C.000	1995	18x142		SK-1155	BTK
2000 i.e. 16V	05/88-08/92	834 B2.000	1995	18x142; 04/1989 →		SK-1151	BTK
2500 Turbo DS	06/88-05/92	8144.97	2499	19x95		SK-1154	BTK
2500 Turbo DS	05/92-07/94	8144.97 Y	2500	19x95		SK-1154	BTK
2000 16V, 2000 16V Turbo, 2000 i.e. 16V, 2000 i.e. 16V Turbo	05/88-07/94	834 B2.000, 834 B2.246, 834 C1.000, 834 C1.246, 834 F1.000, 834 F2.000	1995			0-N818	TB [TE]
2000 i.e., 2000 i.e.	11/84-05/92	834 B.000, 834 B.048, 834 B.146, 834 B1.000	1995	:→570151		0-N823	TB [TE]
2000 i.e., 2000 i.e.	11/84-05/92	834 B.000, 834 B.048, 834 B.146, 834 B1.000	1995	:570152→		0-N832	TB [TE]



OPTIMAL®

LANCIA



CM³



Art. Nr.



THEMA (834)

2000 i.e. Turbo , 2000 i.e.Turbo	11/84-05/90	834 C.000, 834 C.146	1995		0-N832	TB [TE]	
2500 Turbo D	11/84-09/88	8144.91	2445		0-N949	TB [TE]	
2500 Turbo DS	05/88-07/94	8144.97S, 8144.97 Y	2500		0-N949	TB [TE]	
2500 Turbo DS	06/88-05/92	8144.97	2499		0-N949	TB [TE]	

THEMA SW (834)

2000 16V , 2000 i.e. 16V , 2000 i.e. 16V Turbo , 2000 Turbo 16V	12/88-07/94	834 B2.000, 834 B2.246, 834 C1.000, 834 C1.246, 834 F1.000, 834 F2.000	1995	18x173		SK-1050	BTK	
2000 i.e. 16V , 2000 Turbo	01/89-08/92	834 B2.000, 834 C.146	1995	18x142		SK-1151	BTK	
2000 i.e. 16V Turbo	04/89-03/93	834 C1.246	1995	18x142; → 09/1992		SK-1151	BTK	
2500 Turbo DS	06/88-05/92	8144.97	2499	19x95		SK-1154	BTK	
2500 Turbo DS	09/92-07/94	8144.97 Y	2500	19x95		SK-1154	BTK	
2000 16V , 2000 i.e. 16V , 2000 i.e. 16V Turbo , 2000 Turbo 16V	12/88-07/94	834 B2.000, 834 B2.246, 834 C1.000, 834 C1.246, 834 F1.000, 834 F2.000	1995			0-N818	TB [TE]	
2000 Turbo	01/89-03/92	834 C.146	1995			0-N832	TB [TE]	
2500 Turbo DS	03/87-09/90	8144.91	2445			0-N949	TB [TE]	
2500 Turbo DS	05/88-07/94	8144.97S, 8144.97 Y	2500			0-N949	TB [TE]	
2500 Turbo DS	06/88-05/92	8144.97	2499			0-N949	TB [TE]	

THESES (841AX)

2.0 Turbo	07/02-07/09	841 E.000	1998	24x166		SK-1637	BTK	
2.4	07/02-07/09	841 D.000	2446	24x168		SK-1446	BTK	
2.4 D Multijet	04/06-07/09	841 P.000	2387	24x199		SK-1587	BTK	
2.4 D Multijet	04/06-07/09	841 P.000	2387	24x199		SK-1587AQ1	BTKW	
2.4 JTD	07/02-07/09	841 C.000	2387	24x190; Baumuster: 841AXD1B02		SK-1112	BTK	
2.4 JTD	07/02-07/09	841 C.000	2387	24x190		SK-1112AQ1	BTKW	
2.4 JTD	05/03-07/09	841 G.000	2387	24x198; 08/2003 →		SK-1367	BTK	
2.4 JTD	05/03-07/09	841 G.000, 841 M.000, 841 N.000	2387	24x198		SK-1367AQ1	BTKW	
2.4 JTD	09/03-07/09	841 M.000, 841 N.000	2387	24x198		SK-1367	BTK	
2.0 Turbo	07/02-07/09	841 E.000	1998			0-N196	TB [TE]	
2.0 Turbo	07/02-07/09	841 E.000	1998			0-N950	TB [DG]	
2.4	07/02-07/09	841 D.000	2446			0-N196	TB [TE]	
2.4	07/02-07/09	841 D.000	2446			0-N950	TB [DG]	
2.4 D Multijet, 2.4 JTD	07/02-07/09	841 C.000, 841 G.000, 841 P.000	2387			0-N115	TB [TE]	
2.4 D Multijet, 2.4 JTD	07/02-07/09	841 C.000, 841 G.000, 841 P.000	2387			0-N950	TB [DG]	
3.0 V6	07/02-07/09	841 A.000	2959			0-N1092	TB [TE]	
3.0 V6	07/02-07/09	841 A.000	2959			0-N1093	TB [DG]	
3.2 V6	05/03-07/09	841 L.000	3179			0-N1092	TB [TE]	
3.2 V6	05/03-07/09	841 L.000	3179			0-N1093	TB [DG]	
2.0 Turbo	07/02-07/09	841 E.000	1998			0-N1404	VB [DG]	
2.0 Turbo	07/02-07/09	841 E.000	1998	†		0-N1490S	VB [TE]	
2.0 Turbo	07/02-07/09	841 E.000	1998			0-N1652	VB [BT]	
2.0 Turbo	07/02-07/09	841 E.000	1998			0-N1916	VB [BT]	
2.4	07/02-07/09	841 D.000	2446			0-N1404	VB [DG]	
2.4	07/02-07/09	841 D.000	2446	†		0-N1490S	VB [TE]	
2.4	07/02-07/09	841 D.000	2446			0-N1652	VB [BT]	
2.4	07/02-07/09	841 D.000	2446			0-N1916	VB [BT]	
2.4 D Multijet, 2.4 JTD	07/02-07/09	841 C.000, 841 G.000, 841 P.000	2387			0-N1404	VB [DG]	
2.4 D Multijet, 2.4 JTD	07/02-07/09	841 C.000, 841 P.000	2387	†		0-N1490S	VB [TE]	
2.4 D Multijet, 2.4 JTD	07/02-07/09	841 C.000, 841 G.000, 841 P.000	2387			0-N1652	VB [BT]	
2.4 D Multijet, 2.4 JTD	07/02-07/09	841 C.000, 841 G.000, 841 P.000	2387			0-N1916	VB [BT]	
3.0 V6	07/02-07/09	841 A.000	2959			0-N1408	VB [DG]	
3.0 V6	07/02-07/09	841 A.000	2959			0-N1594	VB [DG]	
3.0 V6	07/02-07/09	841 A.000	2959	†		0-N1595	VB [BT]	S
3.2 V6	05/03-07/09	841 L.000	3179			0-N1408	VB [DG]	
3.2 V6	05/03-07/09	841 L.000	3179			0-N1594	VB [DG]	
3.2 V6	05/03-07/09	841 L.000	3179	†		0-N1595	VB [BT]	S

VOYAGER Großraumlimousine (RT)

2.8 CRD	09/11-	ENS	2776			0-N2329	TB [TE]	
---------	--------	-----	------	--	--	----------------	---------	--

Y (840A)

1.1	11/95-09/03	176 B2.000	1108	15x104; → 9042883		SK-1023	BTK	
1.1	11/95-09/03	176 B2.000	1108	15x125; → 9042884 →		SK-1421	BTK	
1.1	11/95-09/03	176 B2.000	1108	15x125; → 9042884 →		SK-1421AQ1	BTKW	
1.1	11/95-09/03	176 B2.000	1108	15x104; → 9042883		SK-1665	BTK	
1.1	11/95-09/03	176 B2.000	1108	15x104; → 03/1999; → 9042883		SK-1665AQ1	BTKW	
1.2	03/96-09/03	840 A3.000	1242	15x108; → 9042883		SK-1043	BTK	



CM³



Art. Nr.



ohne Halter

Y (840A)							
1.2	03/96-09/03	188 A4.000, 840 A3.000	1242	15x108; → 03/1999; : →9042883	SK-1043AQ1	BTKW	
1.2	03/96-09/03	188 A4.000	1242	15x129	SK-1418	BTK	
1.2	03/96-09/03	840 A3.000	1242	15x129; :9042883 →	SK-1418	BTK	
1.2	03/96-09/03	188 A4.000	1242	15x129	SK-1418AQ1	BTKW	
1.2	03/96-09/03	840 A3.000	1242	15x129; :9042883 →	SK-1418AQ1	BTKW	
1.2 16V	04/97-09/03	176 B9.000	1242	22x124	SK-1412	BTK	
1.2 16V	04/97-09/03	176 B9.000	1242	22x124; → 04/1999	SK-1412AQ1	BTKW	
1.2 16V	04/97-09/03	176 B9.000	1242	22x124; 04/1999 →	SK-1412AQ2	BTKW	
1.2 16V	10/00-09/03	188 A5.000	1242	22x124; Baumuster: 840AG1A	SK-1412	BTK	
1.2 16V	10/00-09/03	188 A5.000	1242	22x124	SK-1412AQ2	BTKW	
1.4 12V	03/96-09/03	840 A2.000, 840 A4.000	1370	18x134	SK-1345	BTK	
1.1	11/95-09/03	176 B2.000	1108		0-N822	TB [TE]	
1.2	03/96-09/03	188 A4.000, 840 A3.000	1242		0-N822	TB [TE]	
1.2 16V	04/97-09/03	176 B9.000, 188 A5.000	1242		0-N195	TB [TE]	
1.4 12V	03/96-09/03	840 A2.000, 840 A4.000	1370		0-N113	TB [TE]	
1.2	03/96-09/03	188 A4.000	1242		0-N1398	VB [DG]	
1.2	03/96-09/03	188 A4.000	1242		0-N1481	VB [BT]	S
1.2	03/96-09/03	188 A4.000	1242		0-N1598	VB [DG]	
1.2 16V	10/00-09/03	188 A5.000	1242		0-N1398	VB [DG]	
1.2 16V	10/00-09/03	188 A5.000	1242		0-N1481	VB [BT]	S
1.2 16V	10/00-09/03	188 A5.000	1242		0-N1598	VB [DG]	
1.4 12V	03/96-09/03	840 A2.000, 840 A4.000	1370		0-N1403	VB [DG]	
1.4 12V	03/96-09/03	840 A4.000	1370		0-N1407	VB [BT]	S
1.4 12V	10/96-09/03	840 A2.000	1370		0-N1407	VB [BT]	S
Y10 (156)							
1.0 Fire, 1.0 Fire 4WD	03/85-02/92	156 A2.000, 156 A2.000, 156 A2.246, 156 A2.100, 156 A2.246	999	15x104	SK-1023	BTK	
1.0 Fire, 1.0 Fire 4WD	03/85-02/92	156 A2.000, 156 A2.000, 156 A2.246, 156 A2.100, 156 A2.246	999	15x104	SK-1665AQ1	BTKW	
1.1 Avenue, 1.1 Avenue 4WD	01/95-12/95	176 B2.000	1108	15x104	SK-1665	BTK	
1.1 Avenue, 1.1 Avenue 4WD, 1.1 i.e., 1.1 i.e. 4WD, 1.1 i.e. Fire, 1.1 i.e. Fire 4WD	07/89-12/95	156 C.000, 156 C.046, 176 B2.000	1108	15x104	SK-1023	BTK	
1.1 Avenue, 1.1 Avenue 4WD, 1.1 i.e. Fire, 1.1 i.e. Fire 4WD	07/89-12/95	156 C.046, 176 B2.000	1108	15x104	SK-1665AQ1	BTKW	
1.3 i.e. Fire	11/87-05/93	156 B.000	1301	15x120; → 02/1992	SK-1449	BTK	
1.3 i.e. Fire	02/89-12/95	146 A 5.046, 156 B.000	1297	15x120; → 02/1992	SK-1449	BTK	
1.0 Fire, 1.0 Fire 4WD	03/85-02/92	156 A2.000, 156 A2.000, 156 A2.246, 156 A2.100, 156 A2.246	999		0-N822	TB [TE]	
1.0 Turbo	03/85-02/89	156 A1.000	1049		0-N850	TB [TE]	
1.1 Avenue, 1.1 Avenue 4WD, 1.1 i.e., 1.1 i.e. 4WD, 1.1 i.e. Fire, 1.1 i.e. Fire 4WD	07/89-12/95	156 C.000, 156 C.046, 176 B2.000	1108		0-N822	TB [TE]	
1.3 i.e. Fire	11/87-05/93	156 B.000	1301	02/1992 →	0-N822	TB [TE]	
1.3 i.e. Fire	11/87-05/93	156 B.000	1301	→ 02/1992	0-N850	TB [TE]	
1.3 i.e. Fire	02/89-12/95	146 A 5.046, 156 B.000	1297	02/1992 →	0-N822	TB [TE]	
1.3 i.e. Fire	02/89-12/95	146 A 5.046, 156 B.000	1297	→ 02/1992	0-N850	TB [TE]	
YPSILON (843)							
1.2	10/03-12/11	188 A5.000	1242	22x124; Baumuster: 843	SK-1412	BTK	
1.2	10/03-12/11	188 A5.000	1242	22x124	SK-1412AQ2	BTKW	
1.2	10/03-12/11	188 A4.000	1242	15x129; → 08/2004; : →2533528; Baumuster: 843	SK-1418	BTK	
1.2	10/03-12/11	188 A4.000	1242	15x129; → 08/2004; : →2533528	SK-1418AQ1	BTKW	
1.2	10/03-12/11	188 A4.000	1242	22x129; :2533529 →	SK-1677	BTK	
1.2	10/03-12/11	188 A4.000	1242	22x129; → 06/2008; :2533529 →	SK-1677AQ1	BTKW	
1.2	08/10-12/11	169 A4.000	1242	22x129	SK-1677	BTK	
1.4	02/06-12/11	350 A1.000	1368	22x129; 07/2006 →	SK-1677	BTK	
1.4	02/06-12/11	350 A1.000	1368	22x129; → 06/2008	SK-1677AQ1	BTKW	
1.4 16V	10/03-12/11	843 A 1.000	1368	22x124; Baumuster: 843	SK-1412	BTK	
1.4 16V	10/03-12/11	843 A 1.000	1368	22x124	SK-1412AQ2	BTKW	
1.4 LPG	11/10-12/11	350 A1.000	1368	22x129	SK-1677	BTK	
1.2	10/03-12/11	188 A4.000	1242	:2533529 →	0-N1616	TB [TE]	
1.2	10/03-12/11	188 A5.000	1242		0-N195	TB [TE]	
1.2	10/03-12/11	188 A4.000	1242	: →2533528	0-N822	TB [TE]	
1.2	08/10-12/11	169 A4.000	1242		0-N1616	TB [TE]	
1.4 16V	10/03-12/11	843 A 1.000	1368		0-N195	TB [TE]	
1.4, 1.4 LPG	02/06-12/11	350 A1.000	1368		0-N1616	TB [TE]	



CM³



Art. Nr.



ohne Halter

YPSILON (843)								
1.2	10/03-12/11	169 A4.000, 188 A4.000, 188 A5.000	1242			0-N1517	VB [BT]	S
1.3 D Multijet, 1.3 JTD	10/03-12/11	188 A9.000, 199 A2.000, 199 A3.000	1248			0-N1478S	VB [TE]	
1.4, 1.4 16V, 1.4 LPG	10/03-12/11	350 A1.000, 843 A 1.000	1368			0-N1517	VB [BT]	S
YPSILON (312, 846)								
1.2, 1.2 Bifuel	05/11-	169 A4.000	1242	22x129		SK-1677	BTK	
1.2, 1.2 Bifuel	05/11-	169 A4.000	1242			0-N1616	TB [TE]	
1.2, 1.2 Bifuel	05/11-	169 A4.000	1242			0-N1517	VB [BT]	S
1.3 Multijet	05/11-	199 B1.000	1248			0-N1478S	VB [TE]	
ZETA (220)								
2.0 16V	05/98-07/00	RFV (XU10J4R)	1998	25x136		SK-1082	BTK	
2.0 16V	05/98-07/00	RFV (XU10J4R)	1998	25x136		SK-1082AQ2	BTKW	
2.0 16V	07/00-09/02	RFN	1997	25.4x153		SK-1482	BTK	
2.0 16V	07/00-09/02	RFN	1997	25.4x153		SK-1482AQ1	BTKW	
2.0 JTD	09/99-09/02	RHW (DW10ATED4)	1997	25x141; → 04/2000; mit Zubehör		SK-1085	BTK	
2.0 JTD	09/99-09/02	RHW (DW10ATED4), RHZ (DW10ATED), RHZ (DW10ATED)	1997	25.4x141; mit Zubehör		SK-1085AQ1	BTKW	
2.0 JTD	09/99-09/02	RHW (DW10ATED4)	1997	25.4x144		SK-1534	BTK	
2.0 JTD	09/99-09/02	RHW (DW10ATED4)	1997	25.4x144		SK-1534AQ1	BTKW	
2.0 JTD	04/00-09/02	RHZ (DW10ATED), RHZ (DW10ATED)	1997	25x141; mit Zubehör; Baumuster: 220		SK-1085	BTK	
2.0 Turbo	05/95-09/02	RGX (XU10J2TE)	1998	17x114		SK-1019	BTK	
2.1 TD	05/96-09/99	P 8 C	2088	25.4x149		SK-1017	BTK	
2.1 TD	05/96-09/99	P 8 C	2088	25x149		SK-1017AQ1	BTKW	
2.0 16V	05/98-07/00	RFV (XU10J4R)	1998			0-N862	TB [DG]	
2.0 16V	05/98-07/00	RFV (XU10J4R)	1998			0-N943	TB [TE]	
2.0 16V	07/00-09/02	RFN	1997			0-N1057	TB [TE]	
2.0 16V	07/00-09/02	RFN	1997			0-N1065	TB [DG]	
2.0 JTD	09/99-09/02	RHW (DW10ATED4), RHZ (DW10ATED), RHZ (DW10ATED)	1997			0-N118P	TB [TE]	
2.0 JTD	09/99-09/02	RHW (DW10ATED4)	1997			0-N119P	TB [DG]	
2.0 JTD	04/00-09/02	RHZ (DW10ATED), RHZ (DW10ATED)	1997			0-N1381	TB [DG]	
2.0 Turbo	05/95-09/02	RGX (XU10J2TE)	1998			0-N811	TB [TE]	
2.1 TD	05/96-09/99	P 8 C	2088			0-N862	TB [DG]	
2.1 TD	05/96-09/99	P 8 C	2088			0-N871	TB [TE]	
2.0 16V	05/98-07/00	RFV (XU10J4R)	1998	✳		0-N1463S	VB [DG]	
2.0 16V	05/98-07/00	RFV (XU10J4R)	1998	✳		0-N1713	VB [BT]	
2.0 16V	05/98-07/00	RFV (XU10J4R)	1998	✳		0-N1722	VB [DG]	
2.0 16V	07/00-09/02	RFN	1997			0-N1391	VB [BT]	S
2.0 16V	07/00-09/02	RFN	1997			0-N1416	VB [DG]	
2.0 16V, 2.0 Turbo	05/95-09/02	RFV (XU10J4R), RGX (XU10J2TE)	1998	✳		0-N1484	VB [BT]	S
2.0 JTD	09/99-09/02	RHW (DW10ATED4), RHZ (DW10ATED), RHZ (DW10ATED)	1997			0-N1320	VB [TE]	
2.0 JTD	09/99-09/02	RHW (DW10ATED4), RHZ (DW10ATED), RHZ (DW10ATED)	1997			0-N1493	VB [BT]	S
2.0 JTD	04/00-09/02	RHZ (DW10ATED), RHZ (DW10ATED)	1997	✳		0-N151	VB [DG]	
2.0 JTD	04/00-09/02	RHZ (DW10ATED), RHZ (DW10ATED)	1997	✳		0-N1748	VB [BT]	
2.0 Turbo	05/95-09/02	RGX (XU10J2TE)	1998	→ 02/1997		0-N124	VB [TE]	
2.0 Turbo	05/95-09/02	RGX (XU10J2TE)	1998	→ 02/1997; ✳		0-N1405	VB [DG]	
2.0 Turbo	05/95-09/02	RGX (XU10J2TE)	1998	03/1997 →; ✳		0-N1463S	VB [DG]	
2.0 Turbo	05/95-09/02	RGX (XU10J2TE)	1998	03/1997 →; ✳		0-N1713	VB [BT]	
2.0 Turbo	05/95-09/02	RGX (XU10J2TE)	1998	03/1997 →; ✳		0-N1722	VB [DG]	
2.1 TD	05/96-09/99	P 8 C	2088			0-N1320	VB [TE]	
2.1 TD	05/96-09/99	P 8 C	2088	✳		0-N1472	VB [BT]	S
2.1 TD	05/96-09/99	P 8 C	2088	✳		0-N1747	VB [VD]	
2.1 TD	05/96-09/99	P 8 C	2088			0-N931	VB [TE]	



CM³



Art. Nr.



ohne Halter

DEFENDER Cabrio (LD)							
2.5 90 TDI	09/90-	16L	2495	30x118; ch.→VA117353; Baumuster: Defender 110	SK-1450	BTK	
2.5 90 TDI	09/90-	16L	2495	30x118; ch.→VA117353; Baumuster: Defender 130	SK-1450	BTK	
2.5 90 TDI	09/90-	11 L, 16 L, 23 L	2495	30x118; ch.→VA117353; Baumuster: Defender 90	SK-1450	BTK	
2.5 90 TDI	09/90-	16L	2495	30x118; ch.VA117354→; Baumuster: Defender 110	SK-1533	BTK	
2.5 90 TDI	09/90-	16L	2495	30x118; ch.VA117354→; Baumuster: Defender 130	SK-1533	BTK	
2.5 90 TDI	09/90-	11 L, 16 L, 23 L	2495	30x118; ch.VA117354→; Baumuster: Defender 90	SK-1533	BTK	
2.5 90 TDI	09/90-	16L, 23L	2495	ch.VA117355→	0-N1239	TB [DG]	
2.5 90 TDI	09/90-	16L, 23L	2495	ch.VA117355→	0-N1256	TB [TE]	
2.5 90 TDI	09/90-	11L	2495		0-N891	TB [TE]	
2.5 90 TDI	09/90-	16L, 23L	2495	ch.→VA117354	0-N892	TB [DG]	
2.5 90 TDI	09/90-	11 L, 16 L, 23 L	2495		0-N968	TB [TE]	
2.2 Td4	08/11-	ZSD-422	2198	☼	0-N2277	VB [DG]	
2.4 Td4	05/07-	ZSD-424	2402	☼	0-N2277	VB [DG]	
2.5 90 TDI	09/90-	16L, 23L	2495		0-N1857	VB [BT]	S
DEFENDER Pick-up (LD_)							
2.2 Td4	08/11-	ZSD-422	2198	☼	0-N2277	VB [DG]	
2.4 Td4	05/07-	ZSD-424	2402	☼	0-N2277	VB [DG]	
DEFENDER Pritsche/Fahrgestell (LD)							
2.2 Td4	08/11-	ZSD-422	2198	☼	0-N2277	VB [DG]	
DEFENDER Station Wagon (LD)							
2.5 90,110 TDI	09/90-12/98	16L, 23L	2495	30x118; ch.→VA117353; Baumuster: Defender 110	SK-1450	BTK	
2.5 90,110 TDI	09/90-12/98	16L, 23L	2495	30x118; ch.→VA117353; Baumuster: Defender 90	SK-1450	BTK	
2.5 90,110 TDI	09/90-12/98	16L, 23L	2495	30x118; ch.VA117354→; Baumuster: Defender 110	SK-1533	BTK	
2.5 90,110 TDI	09/90-12/98	16L, 23L	2495	30x118; ch.VA117354→; Baumuster: Defender 90	SK-1533	BTK	
2.5 90,110 TDI	09/90-12/98	16L, 23L	2495	ch.VA117355→	0-N1239	TB [DG]	
2.5 90,110 TDI	09/90-12/98	16L, 23L	2495	ch.VA117355→	0-N1256	TB [TE]	
2.5 90,110 TDI	09/90-12/98	11L	2495		0-N891	TB [TE]	
2.5 90,110 TDI	09/90-12/98	16L, 23L	2495	ch.→VA117354	0-N892	TB [DG]	
2.5 90,110 TDI	09/90-12/98	11 L, 16 L, 23 L	2495		0-N968	TB [TE]	
2.2 Td4	08/11-	ZSD-422	2198	☼	0-N2277	VB [DG]	
2.4 Td4	05/07-	ZSD-424	2402	☼	0-N2277	VB [DG]	
2.5 90,110 TDI	09/90-12/98	16L, 23L	2495		0-N1857	VB [BT]	S
DISCOVERY I (LJ, LG)							
2.0 16 V	06/89-10/98	20 T4H	1994	22x132	SK-1500	BTK	
2.5 D 4x4	07/94-10/98	19 L, 22 L	2495	30x118; ch.→VA560897	SK-1450	BTK	
2.5 D 4x4	07/94-10/98	19 L, 22 L	2495	30x118; ch.VA560898→	SK-1533	BTK	
2.0 16 V	06/89-10/98	20 T4H	1994		0-N1243	TB [TE]	
2.5 D 4x4	07/94-10/98	19 L, 22 L	2495		0-N1239	TB [DG]	
2.5 D 4x4	07/94-10/98	19 L, 22 L	2495		0-N1256	TB [TE]	
2.5 D 4x4	07/94-10/98	19 L, 22 L	2495		0-N892	TB [DG]	
2.5 TDI	10/89-10/98	12 L, 17 L, 19 L, 21 L	2496	ch.VA560898→	0-N1239	TB [DG]	
2.5 TDI	10/89-10/98	12 L, 17 L, 19 L, 21 L	2496	ch.VA560898→	0-N1256	TB [TE]	
2.5 TDI	10/89-10/98	12 L, 17 L, 19 L, 21 L	2496	ch.→VLA081991	0-N891	TB [TE]	
2.5 TDI	10/89-10/98	12 L, 17 L, 19 L, 21 L	2496	ch.→VA560897	0-N892	TB [DG]	
2.5 TDI	10/89-10/98	12 L, 17 L, 19 L, 21 L	2496		0-N968	TB [TE]	
2.5 D 4x4	07/94-10/98	19 L, 22 L	2495		0-N1857	VB [BT]	S
2.5 D 4x4	07/94-10/98	19 L, 22 L	2495	Rippenanzahl: 4; ☼	0-N2054	VB [DG]	
2.5 TDI	10/89-10/98	12 L, 17 L, 19 L, 21 L	2496	Rippenanzahl: 4; ☼	0-N2054	VB [DG]	
3.9 V8	09/93-10/98	35 D, 36 D	3947	ch.(V)MA081991→	0-N2053	VB [BT]	S
DISCOVERY II (LJ, LT)							
4.0 V8	11/98-06/04	56 D	3950		0-N2053	VB [BT]	S
DISCOVERY III (TAA, LA_)							
2.7 TD	07/04-09/09	276DT	2720	29x195	SK-1742	BTK	
2.7 TD	07/04-09/09	276DT	2720		0-N1613	TB [TE]	
2.7 TD	07/04-09/09	276DT	2720		0-N1614	TB [TE]	
2.7 TD	07/04-09/09	276DT	2720		0-N1615	TB [DG]	



CM³



Art. Nr.



ohne Halter

DISCOVERY III (TAA, LA_)								
4.4	07/04-09/09	448PN	4394			0-N2281	VB [BT]	S
DISCOVERY IV (LA)								
2.7 TD	09/09-	276DT	2720	29x195		SK-1742	BTK	
3.0 SDV6, 3.0 TD	09/09-	306DT, 306DT, 30DDTX, 30DDTX	2993	29x195		SK-1742	BTK	
2.7 TD	09/09-	276DT	2720			0-N1613	TB [TE]	
2.7 TD	09/09-	276DT	2720			0-N1614	TB [TE]	
2.7 TD	09/09-	276DT	2720			0-N1615	TB [DG]	
3.0 SDV6, 3.0 TD	09/09-	306DT, 306DT, 30DDTX, 30DDTX	2993			0-N1613	TB [TE]	
3.0 SDV6, 3.0 TD	09/09-	306DT, 306DT, 30DDTX, 30DDTX	2993			0-N1614	TB [TE]	
3.0 SDV6, 3.0 TD	09/09-	306DT, 306DT, 30DDTX, 30DDTX	2993			0-N1615	TB [DG]	
FREELANDER (LN)								
1.8 16V, 1.8 i 16V	02/98-10/06	18 K4F	1796	26x145		SK-1504	BTK	
1.8 16V, 1.8 i 16V	02/98-10/06	18 K4F	1796	26x143		SK-1706	BTK	
1.8 16V, 1.8 i 16V	02/98-10/06	18 K4F	1796	26x143; Spannrollenbetätigung: manuell		SK-1706AQ1	BTKW	
2.0 DI	02/98-11/00	20 T2N	1994	30x112; 24x78; :17N000187→		SK-1552	BTK	
2.5 V6	11/00-10/06	25 K4F	2497	22x58; 28x176; ohne Spanndämpfer, Spannrolle		SK-1502	BTK	
1.8 16V, 1.8 i 16V	02/98-10/06	18 K4F	1796			0-N1272	TB [TE]	
1.8 16V, 1.8 i 16V	02/98-10/06	18 K4F	1796			0-N894	TB [TE]	
2.0 DI	02/98-11/00	20 T2N	1994			0-N1120	TB [TE]	
2.0 DI	02/98-11/00	20 T2N	1994			0-N1122	TB [DG]	
2.0 DI	02/98-11/00	20 T2N	1994			0-N1273	TB [TE]	
2.5 V6	11/00-10/06	25 K4F	2497			0-N1248	TB [DG]	
2.5 V6	11/00-10/06	25 K4F	2497			0-N1261	TB [TE]	
1.8 16V, 1.8 i 16V	02/98-10/06	18 K4F	1796			0-N1393	VB [DG]	
1.8 16V, 1.8 i 16V	02/98-10/06	18 K4F	1796			0-N1643	VB [BT]	S
1.8 16V, 1.8 i 16V	02/98-10/06	18 K4F	1796	ch.XA504881→;		0-N1659	VB [BT]	S
2.0 DI	02/98-11/00	20 T2N	1994			0-N1393	VB [DG]	
2.0 DI	02/98-11/00	20 T2N	1994			0-N1535	VB [BT]	S
2.0 Td4	11/00-10/06	204D3, M 47	1951			0-N1396	VB [DG]	
2.0 Td4	11/00-10/06	204D3, M 47	1951			0-N1514	VB [BT]	S
2.0 Td4	11/00-10/06	204D3, M 47	1951			0-N1834	VB [BT]	S
2.5 V6	11/00-10/06	25 K4F	2497			0-N1735	VB [DG]	
2.5 V6	11/00-10/06	25 K4F	2497			0-N1742	VB [BT]	S
FREELANDER Soft Top (LN_)								
1.8 i 16V	02/98-10/06	18 K4F	1796	26x145		SK-1504	BTK	
1.8 i 16V	02/98-10/06	18 K4F	1796	26x143; → 09/2000		SK-1706	BTK	
1.8 i 16V	02/98-10/06	18 K4F	1796	26x143; Spannrollenbetätigung: manuell		SK-1706AQ1	BTKW	
2.0 DI	02/98-10/06	20 T2N	1994	30x112; 24x78; :17N000187→		SK-1552	BTK	
1.8 i 16V	02/98-10/06	18 K4F	1796			0-N1272	TB [TE]	
1.8 i 16V	02/98-10/06	18 K4F	1796			0-N894	TB [TE]	
2.0 DI	02/98-10/06	20 T2N	1994			0-N1120	TB [TE]	
2.0 DI	02/98-10/06	20 T2N	1994			0-N1122	TB [DG]	
2.0 DI	02/98-10/06	20 T2N	1994			0-N1273	TB [TE]	
1.8 i 16V	02/98-10/06	18 K4F	1796			0-N1393	VB [DG]	
1.8 i 16V	02/98-10/06	18 K4F	1796			0-N1643	VB [BT]	S
1.8 i 16V	02/98-10/06	18 K4F	1796	ch.XA504881→;		0-N1659	VB [BT]	S
2.0 DI	02/98-10/06	20 T2N	1994			0-N1393	VB [DG]	
2.0 DI	02/98-10/06	20 T2N	1994			0-N1535	VB [BT]	S
FREELANDER 2 (FA_, LF_)								
2.2 SD4, 2.2 TD4, 2.2 TD4 4x4	10/06-10/14	224DT, 224DT, DW12BTED4	2179	25.4x118		SK-1692	BTK	
2.2 SD4, 2.2 TD4, 2.2 TD4 4x4	10/06-10/14	224DT, 224DT, DW12BTED4	2179	25.4x118		SK-1692AQ1	BTKW	
2.2 SD4, 2.2 TD4, 2.2 TD4 4x4	10/06-10/14	224DT, 224DT, DW12BTED4	2179			0-N1334	TB [DG]	
2.2 SD4, 2.2 TD4, 2.2 TD4 4x4	10/06-10/14	224DT, 224DT, DW12BTED4	2179			0-N2018	TB [BT]	
2.2 SD4, 2.2 TD4, 2.2 TD4 4x4	10/06-10/14	224DT, 224DT, DW12BTED4	2179			0-N1963	VB [DG]	
2.2 SD4, 2.2 TD4, 2.2 TD4 4x4	10/06-10/14	224DT, 224DT, DW12BTED4	2179			0-N2116	VB [BT]	S
2.2 TD4, 2.2 TD4 4x4	10/06-10/14	DW12BTED4	2179			0-N2116	VB [BT]	S
3.2	10/06-10/14	B 6324 S	3192			0-N2242	VB [BT]	S
3.2	10/06-10/14	B 6324 S	3192			0-N2243	VB [DG]	
RANGE ROVER EVOQUE (LV)								
2.2 eD4, 2.2 SD4, 2.2 TD4	06/11-	224DT	2179	25.4x118		SK-1692	BTK	
2.2 eD4, 2.2 SD4, 2.2 TD4	06/11-	224DT	2179	25.4x118		SK-1692AQ1	BTKW	
2.2 eD4, 2.2 SD4, 2.2 TD4	06/11-	224DT	2179			0-N1334	TB [DG]	
2.2 eD4, 2.2 SD4, 2.2 TD4	06/11-	224DT	2179			0-N2018	TB [BT]	



CM³



Art. Nr.



ohne Halter

RANGE ROVER EVOQUE (LV)							
2.2 eD4, 2.2 SD4, 2.2 TD4	06/11-	224DT	2179			0-N2116	VB [BT] S
RANGE ROVER I (AE, AN, HAA, HAB, HAM, HBM, RE, RN)							
3.9 KAT, 3.9 Vogue SEI	11/88-07/94	35 D, 36 D, 37 D, 38 D	3950			0-N2053	VB [BT] S
RANGE ROVER II (LP)							
2.5 TD	07/94-03/02	25 6T (BMW)	2497			0-N1857	VB [BT] S
2.5 TD	07/94-03/02	25 6T (BMW)	2497	Rippenanzahl: 4		0-N2054	VB [DG]
3.9	07/94-03/02	42 D	3947	Rippenanzahl: 7; ❄		0-N1809	VB [BT] S
4.6	07/94-03/02	46 D	4553	Rippenanzahl: 7; ❄		0-N1809	VB [BT] S
4.6	06/98-03/02	60 D	4554	Rippenanzahl: 7; ❄		0-N1809	VB [BT] S
4.6	06/98-03/02	60 D	4554			0-N2053	VB [BT] S
RANGE ROVER III (LM)							
3.0 TD 6	03/02-08/12	306D1	2926			0-N1396	VB [DG]
3.0 TD 6	03/02-08/12	306D1	2926			0-N1834	VB [BT] S
3.0 TD 6	03/02-08/12	306D1	2926			0-N1900	VB [BT]
3.0 TD 6	03/02-08/12	306D1	2926			0-N1912	VB [BT] S
3.0 TD 6	03/02-08/12	306D1	2926			0-N1923	VB [BT]
4.2	05/05-08/12	428PS	4197			0-N2281	VB [BT] S
4.4	03/02-08/12	M62 B44	4398			0-N1508	VB [BT] S
4.4	03/02-08/12	M62 B44	4398			0-N1669	VB [BT] S
4.4	03/02-08/12	M62 B44	4398			0-N1787	VB [VD]
4.4	08/04-08/12	448PN	4394			0-N2281	VB [BT] S
4.4	05/05-08/12	448PN	4394			0-N1669	VB [BT] S
4.4	05/05-08/12	448PN	4394			0-N1787	VB [VD]
RANGE ROVER IV (LG)							
3.0 Hybrid 4x4, 3.0 TD, 3.0 TD 4x4, 3.0 TD Hybrid 4x4	08/12-	306DT	2993	29x195		SK-1742	BTK
3.0 TD	08/12-	306DT	2993			0-N1615	TB [DG]
RANGE ROVER SPORT (LS)							
2.7 TDVM	02/05-03/13	276DT	2720	29x195		SK-1742	BTK
3.0 TD, 3.0 TD V6	09/09-03/13	306DT, 30DDTX	2993	29x195		SK-1742	BTK
2.7 TDVM	02/05-03/13	276DT	2720			0-N1613	TB [TE]
2.7 TDVM	02/05-03/13	276DT	2720			0-N1614	TB [TE]
2.7 TDVM	02/05-03/13	276DT	2720			0-N1615	TB [DG]
3.0 TD, 3.0 TD V6	09/09-03/13	306DT, 30DDTX	2993			0-N1613	TB [TE]
3.0 TD, 3.0 TD V6	09/09-03/13	306DT, 30DDTX	2993			0-N1614	TB [TE]
3.0 TD, 3.0 TD V6	09/09-03/13	306DT, 30DDTX	2993			0-N1615	TB [DG]
4.2	02/05-03/13	428PS	4197			0-N2281	VB [BT] S
4.4	02/05-03/13	448PN	4394			0-N2281	VB [BT] S
RANGE ROVER SPORT (LW)							
3.0 SDV6 Hybrid 4x4, 3.0 TD 4x4, 3.0 TD Hybrid 4x4	04/13-	306DT, 30DDTX	2993	29x195		SK-1742	BTK
3.0 TD 4x4	04/13-	306DT, 30DDTX	2993			0-N1615	TB [DG]



CM³



Art. Nr.



ohne Halter

CONVOY Bus

2.5 D	04/96-02/02	EN 55, ET 70	2498	27.6x130	SK-1351	BTK	
2.5 D	10/97-04/09	4EB, 4HB	2496	27.6x130	SK-1351	BTK	

CONVOY Kasten

2.5 D, 2.5 DI	04/96-04/09	EN 55, ET 70	2498	27.6x130	SK-1351	BTK	
2.5 TDI	10/98-04/09	ET 70	2496	27.6x130	SK-1351	BTK	

CONVOY Pritsche/Fahrgestell

2.5 D, 2.5 DI	04/96-04/09	EN 55	2498	27.6x130	SK-1351	BTK	
2.5 TDI	10/98-04/09	ET 70	2496	27.6x130	SK-1351	BTK	

CUB

2.3 D	08/98-09/01	LD23	2283		0-N030	TB [TE]	
2.3 D	08/98-09/01	LD23	2283		0-N031	TB [DG]	

MAXUS Bus

2.5 CDi	02/05-12/09	VM39C, VM39C, VM40C	2499	28x220	SK-1673	BTK	
2.5 CDi	02/05-12/09	VM39C, VM39C, VM40C	2499		0-N1411	TB [DG]	
2.5 CDi	02/05-12/09	VM39C, VM39C, VM40C	2499		0-N1612	TB [TE]	

MAXUS Kasten

2.5 CDi	02/05-12/08	VM39C, VM40C	2499	28x220	SK-1673	BTK	
2.5 CDi	02/05-12/08	VM39C, VM40C	2499		0-N1411	TB [DG]	
2.5 CDi	02/05-12/08	VM39C, VM40C	2499		0-N1612	TB [TE]	

CM³

Art. Nr.



ES (VCV10_, F1, F2, VZV21_)							
250	12/89-09/91	2VZ-FE	2507	32x179		SK-1278	BTK
300	09/91-12/97	3VZ-FE	2959	32x191		SK-1274	BTK
250	12/89-09/91	2VZ-FE	2507			0-N993	TB [TE]
250	12/89-09/91	2VZ-FE	2507			0-N994	TB [DG]
300	09/91-12/97	3VZ-FE	2959			0-N993	TB [TE]
300	09/91-12/97	3VZ-FE	2959			0-N994	TB [DG]
ES (MCV_, VZV_)							
3.0	10/96-07/01	1MZ-FE	2995	32x211		SK-1289	BTK
ES (GSV4_, ACV4_)							
3.5	05/06-06/12	2GR-FE	3456			0-N1728	VB [DG]
3.5	05/06-06/12	2GR-FE	3456			0-N2032	VB [BT] S
ES (AVV6_, GSV6_, ASV6_)							
350	06/12-	2GR-FE	3456			0-N1728	VB [DG]
350	06/12-	2GR-FE	3456			0-N2032	VB [BT] S
GS (JZS147)							
300	03/93-08/97	2JZ-GE	2997			0-N1549	TB [TE]
300	03/93-08/97	2JZ-GE	2997			0-N1877	VB [BT] S
GS (UZS161, JZS160, UZS160_)							
400	12/97-11/00	1UZ-FE	3969	34x211		SK-1703	BTK
430	11/00-03/05	3UZ-FE	4293	34x211		SK-1703	BTK
300, 300 T3	08/97-03/05	2JZ-GE	2997			0-N1549	TB [TE]
400	12/97-11/00	1UZ-FE	3969			0-N1823	TB [BT]
400	12/97-11/00	1UZ-FE	3969			0-N1883	TB [BT] S
400	12/97-11/00	1UZ-FE	3969			0-N2058	TB [DG]
430	11/00-03/05	3UZ-FE	4293			0-N1823	TB [BT]
430	11/00-03/05	3UZ-FE	4293			0-N1883	TB [BT] S
430	11/00-03/05	3UZ-FE	4293			0-N2058	TB [DG]
300, 300 T3	08/97-03/05	2JZ-GE	2997			0-N1877	VB [BT] S
400	12/97-11/00	1UZ-FE	3969	→ 01/2000		0-N1877	VB [BT] S
400	12/97-11/00	1UZ-FE	3969	Rippenanzahl: 6		0-N2186	VB [DG]
400	12/97-11/00	1UZ-FE	3969	01/2000 →		0-N2187	VB [BT]
400	12/97-11/00	1UZ-FE	3969	01/2000 →		0-N2189S	VB [DG]
430	11/00-03/05	3UZ-FE	4293	Rippenanzahl: 6		0-N2186	VB [DG]
430	11/00-03/05	3UZ-FE	4293			0-N2187	VB [BT]
430	11/00-03/05	3UZ-FE	4293			0-N2189S	VB [DG]
GS (GRS19_, UZS19_, GWS19_, URS19_)							
4.3 VVTi, 430	04/05-11/11	3UZ-FE	4293	34x211		SK-1703	BTK
4.3 VVTi, 430	04/05-11/11	3UZ-FE	4293			0-N1823	TB [BT]
4.3 VVTi, 430	04/05-11/11	3UZ-FE	4293			0-N1883	TB [BT] S
4.3 VVTi, 430	04/05-11/11	3UZ-FE	4293			0-N2058	TB [DG]
3.0	04/05-11/11	3GR-FSE	2995	✳		0-N1728	VB [DG]
300	04/05-11/11	3GR-FSE	2995	✳		0-N1728	VB [DG]
300	04/05-11/11	3GR-FSE	2995			0-N2032	VB [BT] S
350, 350 AWD, 450 h	02/06-11/11	2GR-FSE	3456			0-N1728	VB [DG]
4.3 VVTi, 430	04/05-11/11	3UZ-FE	4293	Rippenanzahl: 6		0-N2186	VB [DG]
4.3 VVTi, 430	04/05-11/11	3UZ-FE	4293			0-N2187	VB [BT]
4.3 VVTi, 430	04/05-11/11	3UZ-FE	4293			0-N2189S	VB [DG]
450 h	02/06-11/11	2GR-FSE	3456	✳		0-N1728	VB [DG]
GS (GRL1_, GWL1_)							
GS 250	01/12-	4GR-FSE	2499			0-N1728	VB [DG]
GS 350, GS 350 AWD	01/12-	2GR-FSE	3456			0-N1728	VB [DG]
GX (_J12_)							
470	11/01-11/09	2UZ-FE	4664	34x211		SK-1703	BTK
470	11/01-11/09	2UZ-FE	4664			0-N2187	VB [BT]
470	11/01-11/09	2UZ-FE	4664			0-N2189S	VB [DG]
IS I (JCE1_, GXE1_)							
300	09/01-07/05	2JZ-GE	2997			0-N1549	TB [TE]
200	04/99-07/05	1G-FE	1988			0-N1725	VB [DG]
300	09/01-07/05	2JZ-GE	2997			0-N1877	VB [BT] S
IS SportCross							
300	10/01-10/05	2JZ-GE	2997			0-N1549	TB [TE]

CM³

Art. Nr.



ohne Halter

IS SportCross									
200	10/02-10/05	1G-FE	1988	→ 07/2005		0-N1725	VB [DG]		
300	10/01-10/05	2JZ-GE	2997			0-N1877	VB [BT]	S	
IS III (GSE3_, AVE3_)									
250	04/13-	4GR-FSE	2499			0-N1728	VB [DG]		
IS II (GSE2_, ALE2_, USE2_)									
200d, 220 d	10/05-	2AD-FHV, 2AD-FTV	2231			0-N1482S	VB [TE]		
200d, 220 d	10/05-	2AD-FHV, 2AD-FTV	2231	→ 03/2011		0-N2040	VB [DG]		
200d, 220 d	10/05-	2AD-FHV, 2AD-FTV	2231			0-N2051	VB [DG]		
250	10/05-	4GR-FSE	2499	⚙		0-N1728	VB [DG]		
250	10/05-	4GR-FSE	2499			0-N2032	VB [BT]	S	
250 AWD	10/05-	4GR-FSE	2499		Antriebsart: Heckantrieb; für Fahrzeuge mit Automatikgetriebe	0-N2032	VB [BT]	S	
250, 250 AWD	11/10-	4GR-FSE	2499			0-N1728	VB [DG]		
350	10/05-	2GR-FSE	3456			0-N1728	VB [DG]		
350	10/05-	2GR-FSE	3456			0-N2032	VB [BT]	S	
350 AWD	10/05-	2GR-FSE	3456		Antriebsart: Heckantrieb; für Fahrzeuge mit Automatikgetriebe	0-N2032	VB [BT]	S	
IS C (GSE2_)									
250	04/09-	4GR-FSE	2499	⚙		0-N1728	VB [DG]		
250	04/09-	4GR-FSE	2499			0-N2032	VB [BT]	S	
250	08/10-	4GR-FSE	2499			0-N1728	VB [DG]		
300	11/10-	3GR-FE	2995			0-N1728	VB [DG]		
350	04/09-	2GR-FSE	3456		Antriebsart: Heckantrieb; für Fahrzeuge mit Automatikgetriebe	0-N2032	VB [BT]	S	
350	11/10-	2GR-FSE	3456			0-N1728	VB [DG]		
LS (UCF10)									
400	12/89-12/94	1UZ-FE	3969			0-N1823	TB [BT]		
400	12/89-12/94	1UZ-FE	3969			0-N2058	TB [DG]		
400	12/89-12/94	1UZ-FE	3969		mit Grundträger	0-N2319	TB [TE]		
400	12/89-12/94	1UZ-FE	3969		Rippenanzahl: 6	0-N2186	VB [DG]		
400	12/89-12/94	1UZ-FE	3969			0-N2187	VB [BT]		
400	12/89-12/94	1UZ-FE	3969			0-N2189S	VB [DG]		
LS (UCF20)									
4.0, 400	09/97-10/00	1UZ-FE	3969	34x211		SK-1703	BTK		
400	12/94-08/97	1UZ-FE	3969	34x211; 07/1997 →		SK-1703	BTK		
400	09/98-10/00	1UZ-FE	3969	34x211; 10/1998 →		SK-1703	BTK		
4.0, 400	12/94-10/00	1UZ-FE	3969			0-N1823	TB [BT]		
4.0, 400	12/94-10/00	1UZ-FE	3969			0-N2058	TB [DG]		
4.0, 400	09/97-10/00	1UZ-FE	3969			0-N1883	TB [BT]	S	
400	12/94-08/97	1UZ-FE	3969		mit Grundträger	0-N2319	TB [TE]		
4.0, 400	12/94-10/00	1UZ-FE	3969		Rippenanzahl: 6	0-N2186	VB [DG]		
4.0, 400	12/94-10/00	1UZ-FE	3969			0-N2187	VB [BT]		
4.0, 400	12/94-10/00	1UZ-FE	3969			0-N2189S	VB [DG]		
LS (UCF30)									
430	10/00-08/06	3UZ-FE	4293	34x211		SK-1703	BTK		
430	10/00-08/06	3UZ-FE	4293			0-N1823	TB [BT]		
430	10/00-08/06	3UZ-FE	4293			0-N1883	TB [BT]	S	
430	10/00-08/06	3UZ-FE	4293			0-N2058	TB [DG]		
430	10/00-08/06	3UZ-FE	4293		Rippenanzahl: 6	0-N2186	VB [DG]		
430	10/00-08/06	3UZ-FE	4293			0-N2187	VB [BT]		
430	10/00-08/06	3UZ-FE	4293			0-N2189S	VB [DG]		
LX (UZJ100)									
470 4x4	09/01-03/08	2UZ-FE	4664	34x211		SK-1703	BTK		
470 4x4	05/98-03/08	2UZ-FE	4664			0-N1823	TB [BT]		
470 4x4	05/98-03/08	2UZ-FE	4664			0-N1883	TB [BT]	S	
470 4x4	05/98-03/08	2UZ-FE	4664			0-N2187	VB [BT]		
470 4x4	05/98-03/08	2UZ-FE	4664			0-N2189S	VB [DG]		
RX (MCU15)									
3.0 2WD, 300 V6	07/00-05/03	1MZ-FE	2995	32x211		SK-1289	BTK		
300 V6	10/00-05/03	1MZ-FE	2995			0-N993	TB [TE]		
300 V6	10/00-05/03	1MZ-FE	2995			0-N994	TB [DG]		
RX (MHU3_, GSU3_, MCU3_)									
300	05/03-12/08	1MZ-FE	2995			0-N1761	TB [BT]		



CM³



Art. Nr.



ohne Halter

RX (MHU3_, GSU3_, MCU3_)							
300	05/03-12/08	1MZ-FE	2995		0-N994	TB [DG]	
400h 4WD, 400h FWD	09/04-12/08	3MZ-FE	3311		0-N1761	TB [BT]	
400h 4WD, 400h FWD	09/04-12/08	3MZ-FE	3311		0-N994	TB [DG]	
350	02/06-12/08	2GR-FE	3456	✳	0-N1728	VB [DG]	
350	02/06-12/08	2GR-FE	3456		0-N2032	VB [BT]	S
350 FWD	01/06-12/08	2GR-FE	3456	Antriebsart: Heckantrieb; für Fahrzeuge mit Automatikgetriebe	0-N2032	VB [BT]	S
RX (GGL1_, GYL1_, AGL1_)							
350 AWD	12/08-10/15	2GR-FE, 2GR-FXE	3456	✳	0-N1728	VB [DG]	
350, 350 AWD	12/08-10/15	2GR-FE, 2GR-FXE	3456		0-N1728	VB [DG]	
350, 350 AWD	12/08-10/15	2GR-FE, 2GR-FXE	3456		0-N2032	VB [BT]	S
SC (UZZ40_)							
430	05/01-07/10	3UZ-FE	4293	34x211	SK-1703	BTK	
430	05/01-07/10	3UZ-FE	4293	34x211; 01/2009 →	SK-1703	BTK	
430	05/01-07/10	3UZ-FE	4293		0-N1823	TB [BT]	
430	05/01-07/10	3UZ-FE	4293		0-N1883	TB [BT]	S
430	05/01-07/10	3UZ-FE	4293		0-N2058	TB [DG]	
430	05/01-07/10	3UZ-FE	4293	Rippenanzahl: 6	0-N2186	VB [DG]	
430	05/01-07/10	3UZ-FE	4293		0-N2187	VB [BT]	
430	05/01-07/10	3UZ-FE	4293		0-N2189S	VB [DG]	



OPTIMAL®

LINCOLN

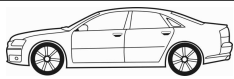

CM³



Art. Nr.



ohne Halter

LS						
3.0 V6 24V	05/98-		2967		0-N1684	VB [DG]
4.0	09/02-08/06		3950	09/2003 →	0-N1684	VB [DG]
4.0 V8 32V	05/98-		3950		0-N1684	VB [DG]
MARK VIII Coupe						
4.6	10/92-12/98		4601		0-N1685	VB [DG]
NAVIGATOR						
5.4, 5.4 Allrad	05/97-12/02		5403	⊛	0-N1718	VB [DG]



CM³



Art. Nr.



ohne Halter

2 ELEVEN							
1.8	04/07-07/11	ZZZ-GE	1796			0-N1462	VB [BT] S
ELISE							
1.8 16V	08/95-11/00	18 K4F	1796	23x143; → 08/1998; mit Zubehör; Spannrollenbetätigung: manuell		SK-1067	BTK
1.8 16V	08/95-11/00	18 K4F	1796	26x145; 09/1998 →		SK-1504	BTK
1.8, 111 S	03/99-11/00	18 K4K	1796	26x143		SK-1507	BTK
111 S	03/99-11/00	18 K4K	1796	26x143; → 08/2000		SK-1706	BTK
1.8 16V, 111 S	08/95-11/00	18 K4F, 18 K4K	1796			0-N894	TB [TE]
1.8, 1.8 16V	08/95-11/00	18 K4F	1796			0-N1272	TB [TE]
1.8, 1.8 16V	08/95-11/00	18 K4F	1796			0-N1412	VB [TE]
1.8, 1.8 16V	08/95-11/00	18 K4F	1796			0-N1584	VB [TE]
ELISE							
1.8	11/00-08/05	18 K4F, 1ZZ-FE	1796	23x143; mit Zubehör; Spannrollenbetätigung: manuell		SK-1067	BTK
1.8	11/00-08/05	18 K4F, 1ZZ-FE	1796	26x145		SK-1504	BTK
1.8	05/02-		1796	26x143		SK-1706	BTK
1.8, 111 S	05/02-	18 K4K	1796	26x143		SK-1507	BTK
1.8	11/00-08/05	18 K4F	1796	manuell		0-N894	TB [TE]
1.8	05/02-	4KF	1796	manuell		0-N894	TB [TE]
1.8, 1.8 16V	11/00-08/05	18 K4F	1796			0-N1272	TB [TE]
1.8, 1.8 16V	11/00-08/05	18 K4F	1796			0-N1412	VB [TE]
1.8, 1.8 16V	11/00-08/05	18 K4F	1796			0-N1584	VB [TE]
EUROPA S							
2.0 Turbo	07/06-	Z 20 LER	1998			0-N127	TB [DG]
2.0 Turbo	07/06-	Z 20 LER	1998			0-N1369	TB [TE]
2.0 Turbo	07/06-	Z 20 LER	1998			0-N1574	TB [DG]
2.0 Turbo	07/06-	Z 20 LER	1998			0-N1422	VB [BT] S
EVORA							
3.5, 3.5 S	05/09-	2GR-FE	3456			0-N1728	VB [DG]
3.5, 3.5 S	05/09-	2GR-FE	3456			0-N2032	VB [BT] S
EXIGE							
3.5 S	06/12-	2GR-FE	3456			0-N1728	VB [DG]
3.5 S	06/12-	2GR-FE	3456			0-N2032	VB [BT] S

CM³

Art. Nr.



ohne Halter

2 (DY)

1.2, 1.25	02/03-	FUJA	1242	22x117; 02/2005 →; mit Zubehör	SK-1659AQ1	BTKW	
1.25	04/03-	FUJA	1242	22x117; → 02/2005; mit Zubehör	SK-1077	BTK	
1.25	04/03-	FUJA	1242	22x117; → 02/2005; mit Zubehör	SK-1077AQ1	BTKW	
1.25	04/03-	FUJA	1242	22x117; 02/2005 → 06/2007; mit Zubehör	SK-1659	BTK	
1.3 L	04/03-06/07	ZJ04	1348	22x117; → 02/2005; mit Zubehör	SK-1077	BTK	
1.3 L	04/03-06/07	ZJ04	1348	22x117; → 02/2005; mit Zubehör	SK-1077AQ1	BTKW	
1.3 L	04/03-06/07	ZJ04	1348	22x117; 02/2005 → 06/2007; mit Zubehör	SK-1659	BTK	
1.3 L	04/03-06/07	ZJ04	1348	22x117; 02/2005 → 06/2007; mit Zubehör	SK-1659AQ1	BTKW	
1.4	02/03-	FXJA	1388	22x117; 02/2005 →; mit Zubehör	SK-1659AQ1	BTKW	
1.4	04/03-	FXJA	1388	22x117; → 02/2005; mit Zubehör	SK-1077	BTK	
1.4	04/03-	FXJA	1388	22x117; → 02/2005; mit Zubehör	SK-1077AQ1	BTKW	
1.4	04/03-	FXJA	1388	22x117; 02/2005 → 06/2007; mit Zubehör	SK-1659	BTK	
1.4 CD	04/03-	F6JA, F6JB	1399	25.4x144	SK-1391	BTK	
1.4 CD	04/03-	F6JA, F6JB	1399	25.4x144	SK-1391AQ1	BTKW	
1.6	02/03-	FYJA	1596	22x117; 02/2005 →; mit Zubehör	SK-1659AQ1	BTKW	
1.6	04/03-	FYJA	1596	22x117; → 02/2005; mit Zubehör	SK-1077	BTK	
1.6	04/03-	FYJA	1596	22x117; → 02/2005; mit Zubehör	SK-1077AQ1	BTKW	
1.6	04/03-	FYJA	1596	22x117; 02/2005 → 06/2007; mit Zubehör	SK-1659	BTK	
1.2, 1.25	02/03-	FUJA	1242	02/2005 →	0-N1564	TB [TE]	
1.25	04/03-	FUJA	1242		0-N294	TB [TE]	
1.4	02/03-	FXJA	1388	02/2005 →	0-N1564	TB [TE]	
1.4	04/03-	FXJA	1388		0-N294	TB [TE]	
1.4 CD	04/03-	F6JA, F6JB	1399		0-N1062	TB [TE]	
1.4 CD	04/03-	F6JA, F6JB	1399		0-N1066	TB [DG]	
1.4 CD	04/03-	F6JA, F6JB	1399		0-N2382	TB [DG]	
1.6	02/03-	FYJA	1596	02/2005 →	0-N1564	TB [TE]	
1.6	04/03-	FYJA	1596		0-N294	TB [TE]	
1.4	02/03-	FXJA	1388	Rippenanzahl: 6	0-N2104	VB [BT]	S
1.4 CD	04/03-	F6JA, F6JB	1399		0-N1418	VB [DG]	
1.4 CD	04/03-	F6JA, F6JB	1399	✘	0-N1420	VB [DG]	
1.4 CD	04/03-	F6JA, F6JB	1399		0-N1636	VB [BT]	S
1.5	04/03-	ZY-VE	1498		0-N2035	VB [BT]	S
1.5	04/03-	ZY-VE	1498	✘	0-N2286	VB [DG]	
1.6	02/03-	FYJA	1596	Rippenanzahl: 6	0-N2104	VB [BT]	S

2 (DE)

1.4 MZR-CD	01/08-06/15	Y404	1399	25.4x144; → 12/2008	SK-1391	BTK	
1.4 MZR-CD	01/08-06/15	Y404	1399	25.4x144; → 12/2008	SK-1391AQ1	BTKW	
1.6 MZ-CD	10/08-06/15	Y406, Y646	1560	25x137; → 05/2010	SK-1424	BTK	
1.6 MZ-CD	10/08-06/15	Y406, Y646	1560	25x137; → 05/2010	SK-1424AQ1	BTKW	
1.6 MZ-CD	06/11-06/15	Y655, Y661	1560	25x141; → 12/2011	SK-1728	BTK	
1.6 MZ-CD	06/11-06/15	Y655, Y661	1560	25x141; → 12/2011	SK-1728AQ1	BTKW	
1.4 MZR-CD	01/08-06/15	Y404	1399		0-N1062	TB [TE]	
1.4 MZR-CD	01/08-06/15	Y404	1399		0-N1066	TB [DG]	
1.4 MZR-CD	01/08-06/15	Y404	1399		0-N2382	TB [DG]	
1.6 MZ-CD	10/08-06/15	Y406, Y646	1560	→ 06/2010	0-N1062	TB [TE]	
1.6 MZ-CD	10/08-06/15	Y406, Y646	1560		0-N1066	TB [DG]	
1.6 MZ-CD	10/08-06/15	Y406, Y646, Y655, Y661	1560		0-N2382	TB [DG]	
1.6 MZ-CD	06/11-06/15	Y655, Y661	1560	→ 07/2011	0-N2224	TB [TE]	
1.3, 1.3 MZR	10/07-06/15	ZJ-VE	1349		0-N2035	VB [BT]	S
1.3, 1.3 MZR	10/07-06/15	ZJ-VE	1349	✘	0-N2286	VB [DG]	
1.4 MZR-CD	01/08-06/15	Y404	1399	→ 04/2010	0-N1339	VB [BT]	S
1.4 MZR-CD	01/08-06/15	Y404	1399		0-N1418	VB [DG]	
1.5, 1.5 MZR	10/07-06/15	ZY05, ZY66, ZY-DE, ZY-VE	1498		0-N2035	VB [BT]	S
1.5, 1.5 MZR	10/07-06/15	ZY05, ZY66, ZY-DE, ZY-VE	1498	✘	0-N2286	VB [DG]	
1.6 MZ-CD	10/08-06/15	Y406, Y646	1560	→ 04/2010	0-N1339	VB [BT]	S
1.6 MZ-CD	10/08-06/15	Y406, Y646	1560		0-N1418	VB [DG]	

2 Stufenheck (DE)

1.5 i	05/10-06/15	ZY-DE	1498		0-N2035	VB [BT]	S
-------	-------------	-------	------	--	---------	---------	---

3 (BK)

1.4	02/04-06/09	FXJA	1388	22x117; mit Zubehör	SK-1077	BTK	
1.4	02/04-06/09	FXJA	1388	22x117; mit Zubehör	SK-1077AQ1	BTKW	
1.4	02/04-06/09	FXJA	1388	22x117; 02/2005 →; mit Zubehör	SK-1659AQ1	BTKW	
1.6 Di Turbo, 1.6 MZ-CD	06/04-12/09	Y406, Y601	1560	25x137	SK-1424	BTK	
1.6 Di Turbo, 1.6 MZ-CD	06/04-12/09	Y406, Y601	1560	25x137	SK-1424AQ1	BTKW	

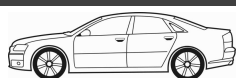

CM³



Art. Nr.



3 (BK)							
2.0 MZR-CD	12/06-06/09	RF7J	1998	30x150; 09/2007 →	SK-1678	BTK	
2.0 MZR-CD	12/06-06/09	RF7J	1998	30x150	SK-1678AQ1	BTKW	
2.0 MZR-CD	12/06-06/09	RF7J	1998	30x150; mit Spanndämpfer, Spannrolle	SK-1741	BTK	
2.0 MZR-CD	12/06-06/09	RF7J	1998	30x150; mit Spanndämpfer, Spannrolle	SK-1741AQ1	BTKW	
1.6 DI Turbo	06/04-06/09	Y601	1560		0-N1062	TB [TE]	
1.6 DI Turbo	06/04-06/09	Y601	1560		0-N1066	TB [DG]	
1.6 DI Turbo, 1.6 MZ-CD	06/04-12/09	Y406, Y601	1560		0-N2382	TB [DG]	
2.0 MZR-CD	12/06-06/09	RF7J	1998	nur in Verbindung mit: RFY0-12-715	0-N1377	TB [DG]	
2.0 MZR-CD	12/06-06/09	RF7J	1998		0-N1378	TB [TE]	
2.0 MZR-CD	12/06-06/09	RF7J	1998		0-N1936	TB [BT]	
1.4	10/03-06/09	ZJ-VE	1349	Rippenanzahl: 6	0-N2104	VB [BT]	S
1.4	10/03-06/09	ZJ-VE	1349	✘	0-N2286	VB [DG]	
1.4	02/04-06/09	FXJA	1388	Rippenanzahl: 6	0-N2104	VB [BT]	S
1.6	10/03-06/09	B6ZE	1598	Rippenanzahl: 6	0-N2104	VB [BT]	S
1.6	10/03-06/09	B6ZE	1598	✘	0-N2286	VB [DG]	
1.6 DI Turbo	06/04-06/09	Y601	1560		0-N1339	VB [BT]	S
1.6 DI Turbo	06/04-06/09	Y601	1560		0-N1418	VB [DG]	
1.6 MZ-CD	06/06-12/09	Y406	1560	✘	0-N1418	VB [DG]	
2.0	10/03-06/09	LF17	1999	✘	0-N1639	VB [BT]	S
2.0	10/03-06/09	LF17	1999	✘	0-N2034	VB [BT]	S
2.0 MZR-CD	12/06-06/09	RF7J	1998		0-N2113	VB [BT]	S
2.0 MZR-CD	12/06-06/09	RF7J	1998	09/2007 →	0-N2244	VB [DG]	
2.3 DiSi Turbo MPS	06/06-06/09	L3YH	2261	→ 01/2009; Rippenanzahl: 6; ✘	0-N1811	VB [BT]	S
2.3 DiSi Turbo MPS, 2.3 MPS, 2.3 MZR, 2.3 MZR Sport	10/03-06/09	L3N9, L3-VDT, L3-VE, L3YH, L3YS, L3YT	2261		0-N1859	VB [DG]	
2.3 MPS	12/06-06/09	L3N9, L3-VDT	2261	Rippenanzahl: 6; ✘	0-N1811	VB [BT]	S
2.3 MZR, 2.3 MZR Sport	10/03-06/09	L3-VE, L3YS, L3YT	2261	Rippenanzahl: 6	0-N1811	VB [BT]	S
3 Stufenheck (BK)							
1.6 DI Turbo	06/04-06/09	Y601	1560	25x137	SK-1424	BTK	
1.6 DI Turbo	06/04-06/09	Y601	1560	25x137	SK-1424AQ1	BTKW	
2.0 MZR-CD	12/06-06/09	RF7J	1998	30x150; 09/2007 →	SK-1678	BTK	
2.0 MZR-CD	12/06-06/09	RF7J	1998	30x150	SK-1678AQ1	BTKW	
2.0 MZR-CD	12/06-06/09	RF7J	1998	30x150; mit Spanndämpfer, Spannrolle	SK-1741	BTK	
2.0 MZR-CD	12/06-06/09	RF7J	1998	30x150; mit Spanndämpfer, Spannrolle	SK-1741AQ1	BTKW	
1.6 DI Turbo	06/04-06/09	Y601	1560		0-N1062	TB [TE]	
1.6 DI Turbo	06/04-06/09	Y601	1560		0-N1066	TB [DG]	
1.6 DI Turbo	06/04-06/09	Y601	1560		0-N2382	TB [DG]	
2.0 MZR-CD	12/06-06/09	RF7J	1998	nur in Verbindung mit: RFY0-12-715	0-N1377	TB [DG]	
2.0 MZR-CD	12/06-06/09	RF7J	1998		0-N1378	TB [TE]	
2.0 MZR-CD	12/06-06/09	RF7J	1998		0-N1936	TB [BT]	
1.6	02/04-06/09	Z6	1598	Rippenanzahl: 6	0-N2104	VB [BT]	S
1.6	02/04-06/09	Z6	1598	✘	0-N2286	VB [DG]	
1.6 DI Turbo	06/04-06/09	Y601	1560		0-N1339	VB [BT]	S
1.6 DI Turbo	06/04-06/09	Y601	1560		0-N1418	VB [DG]	
2.0	02/04-06/09	LF17	1999	✘	0-N1639	VB [BT]	S
2.0	02/04-06/09	LF17	1999	✘	0-N2034	VB [BT]	S
2.0	04/04-06/06	LF17	1999	✘	0-N2286	VB [DG]	
2.0 MZR-CD	12/06-06/09	RF7J	1998		0-N2113	VB [BT]	S
2.0 MZR-CD	12/06-06/09	RF7J	1998	09/2007 →	0-N2244	VB [DG]	
2.3	06/00-03/09	L3-VE	2261	Rippenanzahl: 6	0-N1811	VB [BT]	S
2.3	06/00-03/09	L3-VE	2261		0-N1859	VB [DG]	
3 (BL)							
1.6 MZR CD	11/10-	Y650, Y655	1560	25x141; → 06/2011	SK-1728	BTK	
1.6 MZR CD	11/10-	Y650, Y655	1560	25x141; → 06/2011	SK-1728AQ1	BTKW	
1.6 MZR-CD	12/08-	Y601, Y642	1560	25x137	SK-1424	BTK	
1.6 MZR-CD	12/08-	Y601, Y642	1560	25x137	SK-1424AQ1	BTKW	
1.6 MZR CD	11/10-	DV6C	1560		0-N2382	TB [DG]	
1.6 MZR CD, 1.6 MZR-CD	12/08-	Y601, Y642, Y650, Y655	1560		0-N1062	TB [TE]	
1.6 MZR CD, 1.6 MZR-CD	12/08-	Y601, Y642, Y650, Y655	1560		0-N1066	TB [DG]	
1.6 MZR CD, 1.6 MZR-CD	12/08-	Y601, Y642, Y650, Y655	1560	→ 06/2011; Ganganzahl: 6-Gang	0-N2224	TB [TE]	
1.6 MZR-CD	12/08-	Y601, Y642	1560		0-N2382	TB [DG]	
1.6 MZR	06/09-	Z6	1598	✘	0-N2286	VB [DG]	
1.6 MZR	06/09-	Z6	1598		0-N2394	VB [BT]	S
1.6 MZR-CD	12/08-	Y601, Y642	1560		0-N1339	VB [BT]	S
2.0 MZR, 2.0 MZR DISI	06/09-	LF17, LF-DE, LF5H, LF5W	1999	✘	0-N1639	VB [BT]	S

CM³

Art. Nr.

**3 (BL)**

2.0 MZR, 2.0 MZR DISI	06/09-	LF17, LF-DE, LF5H, LF5W	1999	5		0-N2034	VB [BT]	S
2.2 MZR-CD	06/09-	R2AA	2184			0-N2244	VB [DG]	
2.2 MZR-CD	06/09-	R2AA	2184			0-N2395	VB [BT]	S
2.3 MPS Turbo	06/09-	L3KG, L3-VDT	2261	Rippenanzahl: 6		0-N1858	VB [BT]	S
2.3 MPS Turbo	06/09-	L3KG, L3-VDT	2261			0-N1859	VB [DG]	
2.3 MPS Turbo	06/09-	L3KG, L3-VDT	2261	für Fahrzeuge mit elektrischer Servolenkung		0-N2302S	VB [DG]	

3 Stufenheck (BL)

1.6 MZR CD	12/08-	Y642	1560	25x137		SK-1424	BTK	
1.6 MZR CD	12/08-	Y642	1560	25x137		SK-1424AQ1	BTKW	
1.6 MZR CD	11/10-	Y650, Y655	1560	25x141; → 06/2011		SK-1728	BTK	
1.6 MZR CD	11/10-	Y650, Y655	1560	25x141; → 06/2011		SK-1728AQ1	BTKW	
1.6 MZR CD	12/08-	Y642, Y650, Y655	1560			0-N1062	TB [TE]	
1.6 MZR CD	12/08-	Y642	1560	→ 06/2011; Ganganzahl: 6-Gang		0-N2224	TB [TE]	
1.6 MZR CD	12/08-	Y642	1560			0-N2382	TB [DG]	
1.6 MZR CD	11/10-	Y650, Y655	1560			0-N2224	TB [TE]	
1.6 MZR CD	11/10-	DV6C	1560			0-N2382	TB [DG]	
1.6 MZR	06/09-	Z6	1598	8		0-N2286	VB [DG]	
1.6 MZR	06/09-	Z6	1598			0-N2394	VB [BT]	S
1.6 MZR CD	12/08-	Y642	1560			0-N1339	VB [BT]	S
2.0 MZR, 2.0 MZR DISI	06/09-	LF17, LF-DE, LF5H, LF5W	1999	5		0-N1639	VB [BT]	S
2.0 MZR, 2.0 MZR DISI	06/09-	LF17, LF-DE, LF5H, LF5W	1999	5		0-N2034	VB [BT]	S
2.2 MZR-CD	06/09-	R2AA	2184			0-N2244	VB [DG]	
2.2 MZR-CD	06/09-	R2AA	2184			0-N2395	VB [BT]	S

5 (CR19)

2.0 CD	03/05-	RF7J	1998	30x150		SK-1678	BTK	
2.0 CD	03/05-	RF7J	1998	30x150		SK-1678AQ1	BTKW	
2.0 CD	03/05-	RF7J	1998	30x150; mit Spanndämpfer, Spannrolle		SK-1741	BTK	
2.0 CD	03/05-	RF7J	1998	30x150; mit Spanndämpfer, Spannrolle		SK-1741AQ1	BTKW	
2.0 CD	03/05-	RF7J	1998	nur in Verbindung mit: RFY0-12-715		0-N1377	TB [DG]	
2.0 CD	03/05-	RF7J	1998			0-N1378	TB [TE]	
2.0 CD	03/05-	RF7J	1998			0-N1936	TB [BT]	
1.8	03/05-	L823	1798	5		0-N1639	VB [BT]	S
1.8	03/05-	L823	1798			0-N2034	VB [BT]	S
2.0	03/05-	LFF7	1999	5		0-N1639	VB [BT]	S
2.0	03/05-	LFF7	1999			0-N2034	VB [BT]	S
2.0 CD	03/05-	RF7J	1998			0-N2113	VB [BT]	S
2.0 CD	03/05-	RF7J	1998	8		0-N2244	VB [DG]	
2.0 CD	03/05-	RF7J	1998	8		0-N2311	VB [DG]	
2.3	02/05-		2261	5		0-N1639	VB [BT]	S
2.3	02/05-		2261	5		0-N2034	VB [BT]	S

5 (CW)

1.6 CD	09/10-	Y650, Y655	1560	25x141; → 06/2011		SK-1728	BTK	
1.6 CD	09/10-	Y650, Y655	1560	25x141; → 06/2011		SK-1728AQ1	BTKW	
1.6 CD	09/10-	Y650, Y655	1560	→ 06/2011		0-N2224	TB [TE]	
1.6 CD	09/10-	Y650, Y655	1560			0-N2382	TB [DG]	
1.8 MZR	09/10-	L850	1798	5		0-N1639	VB [BT]	S
2.0	09/10-	LF5H, LFZB	1999	5		0-N1639	VB [BT]	S
2.0	09/10-	LF5H	1999	5		0-N2034	VB [BT]	S

6 (GG)

2.0 DI	06/02-08/07	RF5C	1998	30x153; 10/2002 → 02/2005		SK-1674	BTK	
2.0 DI	06/02-08/07	RF5C	1998	30x153; → 02/2005		SK-1674AQ1	BTKW	
2.0 DI	06/02-08/07	RF5C	1998	30x150; 03/2005 →		SK-1678	BTK	
2.0 DI	06/02-08/07	RF5C	1998	30x150; 03/2005 →		SK-1678AQ1	BTKW	
2.0 DI	06/02-08/07	RF5C	1998	30x150; 03/2005 →; mit Spanndämpfer, Spannrolle		SK-1741	BTK	
2.0 DI	06/02-08/07	RF5C	1998	30x150; 03/2005 →; mit Spanndämpfer, Spannrolle		SK-1741AQ1	BTKW	
2.0 DI	08/02-08/07	RF5C	1998	30x153; → 02/2005		SK-1674	BTK	
2.0 DI	06/05-08/07	RF7J	1998	30x150		SK-1678	BTK	
2.0 DI	06/05-08/07	RF7J	1998	30x150		SK-1678AQ1	BTKW	
2.0 DI	06/05-08/07	RF7J	1998	30x150; mit Spanndämpfer, Spannrolle		SK-1741	BTK	
2.0 DI	06/05-08/07	RF7J	1998	30x150; mit Spanndämpfer, Spannrolle		SK-1741AQ1	BTKW	
2.0 DI	06/02-08/07	RF5C, RF7J	1998	nur in Verbindung mit: RFY0-12-715		0-N1377	TB [DG]	
2.0 DI	06/02-08/07	RF5C, RF7J	1998			0-N1378	TB [TE]	

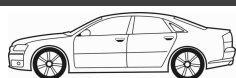

CM³



Art. Nr.



ohne Halter

6 (GG)								
2.0 DI	06/02-08/07	RF5C, RF7J	1998			0-N1936	TB [BT]	
1.8	08/02-08/07	L813, L823, L828	1798	Rippenanzahl: 6;		0-N1811	VB [BT]	S
1.8	08/02-08/07	L813, L823, L828	1798	Rippenanzahl: 6;		0-N1858	VB [BT]	S
1.8	08/02-08/07	L813, L823, L828	1798			0-N1859	VB [DG]	
2.0	06/02-08/07	LF17, LF18, LFF7	1999	Rippenanzahl: 6;		0-N1811	VB [BT]	S
2.0	06/02-08/07	LF17, LF18	1999	Rippenanzahl: 6;		0-N1858	VB [BT]	S
2.0	06/02-08/07	LF17, LF18, LFF7	1999			0-N1859	VB [DG]	
2.0	03/05-08/07	LFF7	1999	Rippenanzahl: 6		0-N1858	VB [BT]	S
2.0 DI	06/02-08/07	RF5C	1998			0-N2114	VB [BT]	S
2.0 DI	06/02-08/07	RF5C	1998	10/2002 →		0-N2244	VB [DG]	
2.0 DI	06/02-08/07	RF5C	1998	→ 02/2005;		0-N2311	VB [DG]	
2.0 DI	08/02-08/07	RF5C, RF7J	1998			0-N2244	VB [DG]	
2.0 DI	06/05-08/07	RF7J	1998			0-N2113	VB [BT]	S
2.3	06/02-08/07	L3C1	2261	Rippenanzahl: 6;		0-N1858	VB [BT]	S
2.3, 2.3 MPS Turbo	06/02-08/07	L3C1, L3KG	2261	Rippenanzahl: 6;		0-N1811	VB [BT]	S
2.3, 2.3 MPS Turbo	06/02-08/07	L3C1, L3KG	2261			0-N1859	VB [DG]	
2.3, 2.3 MPS Turbo	03/05-08/07	L3C1, L3KG	2261	Rippenanzahl: 6		0-N1858	VB [BT]	S
6 Hatchback (GG)								
2.0 DI	08/02-08/07	RF5C	1998	30x153; → 02/2005		SK-1674	BTK	
2.0 DI	08/02-08/07	RF5C	1998	30x153; → 02/2005		SK-1674AQ1	BTKW	
2.0 DI	08/02-08/07	RF5C	1998	30x150; 03/2005 →		SK-1678	BTK	
2.0 DI	08/02-08/07	RF5C	1998	30x150; 03/2005 →		SK-1678AQ1	BTKW	
2.0 DI	08/02-08/07	RF5C	1998	30x150; 03/2005 →; mit Spanndämpfer, Spannrolle		SK-1741	BTK	
2.0 DI	08/02-08/07	RF5C	1998	30x150; 03/2005 →; mit Spanndämpfer, Spannrolle		SK-1741AQ1	BTKW	
2.0 DI	06/05-08/07	RF7J	1998	30x150		SK-1678	BTK	
2.0 DI	06/05-08/07	RF7J	1998	30x150		SK-1678AQ1	BTKW	
2.0 DI	06/05-08/07	RF7J	1998	30x150; mit Spanndämpfer, Spannrolle		SK-1741	BTK	
2.0 DI	06/05-08/07	RF7J	1998	30x150; mit Spanndämpfer, Spannrolle		SK-1741AQ1	BTKW	
2.0 DI	08/02-08/07	RF5C, RF7J	1998	nur in Verbindung mit: RFY0-12-715		0-N1377	TB [DG]	
2.0 DI	08/02-08/07	RF5C, RF7J	1998			0-N1378	TB [TE]	
2.0 DI	08/02-08/07	RF5C, RF7J	1998			0-N1936	TB [BT]	
1.8	08/02-08/07	L813	1798	Rippenanzahl: 6;		0-N1811	VB [BT]	S
1.8	08/02-08/07	L813	1798	Rippenanzahl: 6;		0-N1858	VB [BT]	S
1.8	08/02-08/07	L813	1798			0-N1859	VB [DG]	
2.0	08/02-08/07	LF17, LF18, LFF7	1999	Rippenanzahl: 6;		0-N1811	VB [BT]	S
2.0	08/02-08/07	LF17, LF18	1999	Rippenanzahl: 6;		0-N1858	VB [BT]	S
2.0	08/02-08/07	LF17, LF18, LFF7	1999			0-N1859	VB [DG]	
2.0	03/05-08/07	LFF7	1999	Rippenanzahl: 6		0-N1858	VB [BT]	S
2.0 DI	08/02-08/07	RF5C	1998			0-N2114	VB [BT]	S
2.0 DI	08/02-08/07	RF5C, RF7J	1998			0-N2244	VB [DG]	
2.0 DI	08/02-08/07	RF5C	1998	→ 02/2005;		0-N2311	VB [DG]	
2.0 DI	06/05-08/07	RF7J	1998			0-N2113	VB [BT]	S
2.3	08/02-08/07	L3C1	2261	Rippenanzahl: 6;		0-N1811	VB [BT]	S
2.3	08/02-08/07	L3C1	2261	Rippenanzahl: 6;		0-N1858	VB [BT]	S
2.3	08/02-08/07	L3C1	2261			0-N1859	VB [DG]	
6 Station Wagon (GY)								
2.0 CiTD 4x4, 2.0 DI	08/02-08/07	RF5C	1998	30x153		SK-1674	BTK	
2.0 CiTD 4x4, 2.0 DI	08/02-08/07	RF5C	1998	30x153		SK-1674AQ1	BTKW	
2.0 DI	08/02-08/07	RF5C	1998	30x153; → 02/2005		SK-1674	BTK	
2.0 DI	08/02-08/07	RF5C	1998	30x153; → 02/2005		SK-1674AQ1	BTKW	
2.0 DI	08/02-08/07	RF5C	1998	30x150; 03/2005 →		SK-1678	BTK	
2.0 DI	08/02-08/07	RF5C	1998	30x150; 03/2005 →		SK-1678AQ1	BTKW	
2.0 DI	08/02-08/07	RF5C	1998	30x150; 03/2005 →; mit Spanndämpfer, Spannrolle		SK-1741	BTK	
2.0 DI	08/02-08/07	RF5C	1998	30x150; 03/2005 →; mit Spanndämpfer, Spannrolle		SK-1741AQ1	BTKW	
2.0 DI	06/05-08/07	RF7J	1998	30x150		SK-1678	BTK	
2.0 DI	06/05-08/07	RF7J	1998	30x150		SK-1678AQ1	BTKW	
2.0 DI	06/05-08/07	RF7J	1998	30x150; mit Spanndämpfer, Spannrolle		SK-1741	BTK	
2.0 DI	06/05-08/07	RF7J	1998	30x150; mit Spanndämpfer, Spannrolle		SK-1741AQ1	BTKW	
2.0 CiTD 4x4, 2.0 DI	08/02-08/07	RF5C, RF7J	1998			0-N1378	TB [TE]	
2.0 CiTD 4x4, 2.0 DI	08/02-08/07	RF5C, RF7J	1998			0-N1936	TB [BT]	
2.0 DI	08/02-08/07	RF5C, RF7J	1998	nur in Verbindung mit: RFY0-12-715		0-N1377	TB [DG]	

CM³

Art. Nr.



ohne Halter

6 Station Wagon (GY)

1.8	08/02-08/07	L813	1798	Rippenanzahl: 6; ☼	0-N1811	VB [BT]	S
1.8	08/02-08/07	L813	1798	Rippenanzahl: 6; ☼	0-N1858	VB [BT]	S
1.8	08/02-08/07	L813	1798		0-N1859	VB [DG]	
2.0	08/02-08/07	LF17, LF18, LFF7	1999	Rippenanzahl: 6; ☼	0-N1811	VB [BT]	S
2.0	08/02-08/07	LF17, LF18	1999	Rippenanzahl: 6; ☼	0-N1858	VB [BT]	S
2.0	08/02-08/07	LF17, LF18, LFF7	1999		0-N1859	VB [DG]	
2.0	03/05-08/07	LFF7	1999	Rippenanzahl: 6	0-N1858	VB [BT]	S
2.0 CiTD 4x4, 2.0 DI	08/02-08/07	RF5C	1998		0-N2114	VB [BT]	S
2.0 CiTD 4x4, 2.0 DI	08/02-08/07	RF5C, RF7J	1998		0-N2244	VB [DG]	
2.0 CiTD 4x4, 2.0 DI	08/02-08/07	RF5C	1998	☼	0-N2311	VB [DG]	
2.0 DI	08/02-08/07	RF5C	1998	→ 02/2005; ☼	0-N2311	VB [DG]	
2.0 DI	06/05-08/07	RF7J	1998		0-N2113	VB [BT]	S
2.3, 2.3 AWD	08/02-08/07	L3C1	2261	Rippenanzahl: 6; ☼	0-N1811	VB [BT]	S
2.3, 2.3 AWD	08/02-08/07	L3C1	2261	Rippenanzahl: 6; ☼	0-N1858	VB [BT]	S
2.3, 2.3 AWD	08/02-08/07	L3C1	2261		0-N1859	VB [DG]	

6 (GH)

2.0 MZR-CD	08/07-	RF7J	1998	30x150	SK-1678	BTK	
2.0 MZR-CD	08/07-	RF7J	1998	30x150	SK-1678AQ1	BTKW	
2.0 MZR-CD	08/07-	RF7J	1998	30x150; mit Spanndämpfer, Spannrolle	SK-1741	BTK	
2.0 MZR-CD	08/07-	RF7J	1998	30x150; mit Spanndämpfer, Spannrolle	SK-1741AQ1	BTKW	
2.0 MZR-CD	08/07-	RF7J	1998	nur in Verbindung mit: RFY0-12-715	0-N1377	TB [DG]	
2.0 MZR-CD	08/07-	RF7J	1998		0-N1378	TB [TE]	
2.0 MZR-CD	08/07-	RF7J	1998		0-N1936	TB [BT]	
1.8 MZR	08/07-	L813	1798	Rippenanzahl: 6	0-N1858	VB [BT]	S
1.8 MZR	08/07-	L813	1798		0-N1859	VB [DG]	
1.8 MZR	08/07-	L813	1798	für Fahrzeuge mit elektrischer Servolenkung	0-N2302S	VB [DG]	
2.0 MZR	08/07-	LF17	1999	Rippenanzahl: 6	0-N1858	VB [BT]	S
2.0 MZR	08/07-	LF17	1999		0-N1859	VB [DG]	
2.0 MZR	08/07-	LF17, LF-DE	1999	für Fahrzeuge mit elektrischer Servolenkung	0-N2302S	VB [DG]	
2.0 MZR-CD	08/07-	RF7J	1998		0-N2113	VB [BT]	S
2.0 MZR-CD	08/07-	RF7J	1998		0-N2244	VB [DG]	
2.2 D	01/10-	R2AA, R2BF	2183		0-N2244	VB [DG]	
2.2 D	01/10-	R2AA, R2BF	2183		0-N2395	VB [BT]	S
2.2 MZR-CD	01/09-12/12	R2AA, R2BF	2184	11/2009 →	0-N2244	VB [DG]	
2.2 MZR-CD	01/09-12/12	R2AA, R2BF	2184		0-N2395	VB [BT]	S
2.5 MZR	08/07-	L5-VE	2488	Rippenanzahl: 6	0-N1858	VB [BT]	S
2.5 MZR	08/07-	L5-VE	2488		0-N1859	VB [DG]	

6 Sport Kombi (GH)

2.0 MZR-CD	02/08-	RF7J	1998	30x150	SK-1678	BTK	
2.0 MZR-CD	02/08-	RF7J	1998	30x150; → 12/2009	SK-1678AQ1	BTKW	
2.0 MZR-CD	02/08-	RF7J	1998	30x150; → 12/2009; mit Spanndämpfer, Spannrolle	SK-1741	BTK	
2.0 MZR-CD	02/08-	RF7J	1998	30x150; → 12/2009; mit Spanndämpfer, Spannrolle	SK-1741AQ1	BTKW	
2.0 MZR-CD	02/08-	RF7J	1998	nur in Verbindung mit: RFY0-12-715	0-N1377	TB [DG]	
2.0 MZR-CD	02/08-	RF7J	1998		0-N1378	TB [TE]	
2.0 MZR-CD	02/08-	RF7J	1998		0-N1936	TB [BT]	
1.8 MZR	02/08-	L813	1798	Rippenanzahl: 6	0-N1858	VB [BT]	S
1.8 MZR	02/08-	L813	1798		0-N1859	VB [DG]	
1.8 MZR	02/08-	L813	1798	für Fahrzeuge mit elektrischer Servolenkung	0-N2302S	VB [DG]	
2.0 MZR	02/08-	LF17	1999	Rippenanzahl: 6	0-N1858	VB [BT]	S
2.0 MZR	02/08-	LF17	1999		0-N1859	VB [DG]	
2.0 MZR	02/08-	LF17, LF-DE	1999	für Fahrzeuge mit elektrischer Servolenkung	0-N2302S	VB [DG]	
2.0 MZR-CD	02/08-	RF7J	1998		0-N2113	VB [BT]	S
2.0 MZR-CD	02/08-	RF7J	1998		0-N2244	VB [DG]	
2.2 D, 2.2 MRZ-CD	01/10-	R2AA, R2BF	2183		0-N2244	VB [DG]	
2.2 D, 2.2 MRZ-CD	01/10-	R2AA, R2BF	2183		0-N2395	VB [BT]	S
2.2 MZR-CD	01/09-	R2AA, R2BF	2184		0-N2244	VB [DG]	
2.2 MZR-CD	01/09-	R2AA, R2BF	2184		0-N2395	VB [BT]	S
2.5 MZR	02/08-	L5-VE	2488	Rippenanzahl: 6	0-N1858	VB [BT]	S
2.5 MZR	02/08-	L5-VE	2488		0-N1859	VB [DG]	

6 Sport (GH)

2.0 MZR-CD	08/07-	RF7J	1998	30x150	SK-1678	BTK	
2.0 MZR-CD	08/07-	RF7J	1998	30x150	SK-1678AQ1	BTKW	
2.0 MZR-CD	08/07-	RF7J	1998	30x150; mit Spanndämpfer, Spannrolle	SK-1741	BTK	



CM³



Art. Nr.



6 Sport (GH)

2.0 MZR-CD	08/07-	RF7J	1998	30x150; mit Spanndämpfer, Spannrolle	SK-1741AQ1	BTKW	
2.0 MZR-CD	08/07-	RF7J	1998	nur in Verbindung mit: RFY0-12-715	0-N1377	TB [DG]	
2.0 MZR-CD	08/07-	RF7J	1998		0-N1378	TB [TE]	
2.0 MZR-CD	08/07-	RF7J	1998		0-N1936	TB [BT]	
1.8 MZR	08/07-	L813	1798	Rippenanzahl: 6	0-N1858	VB [BT]	S
1.8 MZR	08/07-	L813	1798		0-N1859	VB [DG]	
1.8 MZR	08/07-	L813	1798	für Fahrzeuge mit elektrischer Servolenkung	0-N2302S	VB [DG]	
2.0 MZR	08/07-	LF17	1999	Rippenanzahl: 6	0-N1858	VB [BT]	S
2.0 MZR	08/07-	LF17	1999		0-N1859	VB [DG]	
2.0 MZR	08/07-	LF17, LF-DE	1999	für Fahrzeuge mit elektrischer Servolenkung	0-N2302S	VB [DG]	
2.0 MZR-CD	08/07-	RF7J	1998		0-N2113	VB [BT]	S
2.0 MZR-CD	08/07-	RF7J	1998		0-N2244	VB [DG]	
2.2 D, 2.2 MZR-CD	01/10-	R2AA, R2BF	2183		0-N2244	VB [DG]	
2.2 D, 2.2 MZR-CD	01/10-	R2AA, R2BF	2183		0-N2395	VB [BT]	S
2.2 MZR-CD	01/09-	R2AA, R2BF	2184	11/2009 →	0-N2244	VB [DG]	
2.2 MZR-CD	01/09-	R2AA, R2BF	2184		0-N2395	VB [BT]	S
2.5 MZR	08/07-	L5-VE	2488	Rippenanzahl: 6	0-N1858	VB [BT]	S
2.5 MZR	08/07-	L5-VE	2488		0-N1859	VB [DG]	

6 Kombi (GJ, GH)

2.2 D	12/12-	SHY1	2191		0-N1378	TB [TE]	
2.2 D	12/12-	SHY1	2191		0-N1936	TB [BT]	

6 Stufenheck (GJ, GH)

2.2 D	12/12-	SHY1	2191		0-N1378	TB [TE]	
2.2 D	12/12-	SHY1	2191		0-N1936	TB [BT]	

121 I (DA)

1.1	10/87-10/90	B1, B116	1139	22x107; DA13-124778	SK-1223	BTK	
1.1	10/87-10/90	B1, B116	1139	22x107; ch.DA13-124779→	SK-1225	BTK	
1.3	10/87-11/90	B3	1324	22x107; DA13-124778	SK-1223	BTK	
1.3	10/87-11/90	B3	1324	22x107; ch.DA13-124779→	SK-1225	BTK	
1.5	11/87-03/89	B518, B573	1498	22x107	SK-1225	BTK	
1.1	10/87-10/90	B1, B116	1139		0-N983	TB [TE]	
1.3	10/87-11/90	B3	1324		0-N983	TB [TE]	

121 II (DB)

1.1	11/90-10/93	B1	1138	22x107	SK-1225	BTK	
1.3 16V, 1.3 i 16V	11/90-03/96	B3 (16V)	1324	22x107	SK-1225	BTK	
1.3 16V, 1.3 i 16V	11/90-03/96	B3 (16V)	1324		0-N983	TB [TE]	

121 III (JASM, JBSM)

1.25	03/96-04/03	DHF, DHG	1242	22x117; 02/1997 →; mit Zubehör	SK-1077	BTK	
1.25	03/96-04/03	DHF, DHG	1242	22x117; 02/1997 →; mit Zubehör	SK-1077AQ1	BTKW	
1.25	03/96-04/03	DHF, DHG	1242	22x117; → 02/1997	SK-1105	BTK	
1.8 D	03/96-04/03	RTJ, RTK	1753	22x116; 22x85; → 10/1997	SK-1042	BTK	
1.8 D	03/96-04/03	RTJ, RTK	1753	22x116; 22x85; → 01/1997	SK-1042AQ1	BTKW	
1.8 D	03/96-04/03	RTJ, RTK	1753	22x116; 22x85; 10/1997 →; mit Zubehör	SK-1078	BTK	
1.8 D	03/96-04/03	RTJ, RTK	1753	22x116; 22x85; 01/1997 →	SK-1078AQ1	BTKW	
1.25	03/96-04/03	DHF, DHG	1242	: →7203	0-N1260	TB [TE]	
1.25	03/96-04/03	DHF, DHG	1242	02/1997 →	0-N294	TB [TE]	
1.3	03/96-04/03	J4R, J4T, JJK, JJM	1299	→ 05/1999	0-N983	TB [TE]	
1.8 D	03/96-04/03	RTJ, RTK	1753	01/1998 →	0-N089	TB [TE]	
1.8 D	03/96-04/03	RTJ, RTK	1753	01/1998 →	0-N123	TB [TE]	
1.8 D	03/96-04/03	RTJ, RTK	1753	→ 12/1997	0-N902	TB [DG]	
1.8 D	03/96-04/03	RTJ, RTK	1753		0-N915	TB [TE]	
1.8 D	03/96-04/03	RTJ, RTK	1753	→ 12/1997	0-N985	TB [TE]	
1.25	03/96-04/03	DHF, DHG	1242		0-N1385	VB [DG]	
1.25	03/96-04/03	DHF, DHG	1242	→ 10/2002; Rippenanzahl: 6; für Fahrzeuge mit Servolenkung,	0-N1897	VB [BT]	S
1.25	03/96-04/03	DHF, DHG	1242	→ 10/2002; Rippenanzahl: 6; , für Fahrzeuge ohne Servolenkung	0-N1897	VB [BT]	S
1.25	03/96-04/03	DHF, DHG	1242	→ 10/2002; Rippenanzahl: 6; , für Fahrzeuge ohne Servolenkung	0-N1897	VB [BT]	S
1.3	03/96-04/03	J4R, J4T, JJK, JJM	1299	→ 01/1999; , für Fahrzeuge mit Servolenkung	0-N1385	VB [DG]	
1.8 D	03/96-04/03	RTJ, RTK	1753		0-N1501	VB [BT]	S
1.8 D	03/96-04/03	RTJ, RTK	1753		0-N2022	VB [BT]	S



CM³



Art. Nr.



ohne Halter

323 I (FA)								
1.3	01/77-05/80	T, TC	1272	22x107		SK-1223	BTK	
323 II (BD)								
1.3	11/80-10/89	E3	1296	22x107; ch.→BF...-563073		SK-1223	BTK	
1.3	11/80-10/89	E3	1296	22x107; ch.BF...-563074→		SK-1225	BTK	
323 II Hatchback (BD)								
1.3	11/80-10/89	E3	1296	22x107; ch.→BF...-563073		SK-1223	BTK	
1.3	11/80-10/89	E3	1296	22x107; ch.BF...-563074→		SK-1225	BTK	
323 III (BF)								
1.3	08/85-05/89	E3	1296	22x107; ch.→BF...-563073; 04/1987 →		SK-1223	BTK	
1.3	08/85-05/89	E3	1296	22x107; ch.BF...-563074→; 04/1987 →		SK-1225	BTK	
1.4	04/87-07/89	B3	1324	22x107; ch.→BF...-563073		SK-1223	BTK	
1.4	04/87-07/89	B3	1324	22x107; ch.BF...-563074→		SK-1225	BTK	
1.5	09/87-10/89	B5	1498	22x107; ch.→BF1-563073		SK-1223	BTK	
1.5	09/87-10/89	B5	1498	22x107; ch.BF1-563074→		SK-1225	BTK	
1.5, 1.5 i, 1.5 i Turbo	08/85-05/89	E5, E5E2, E5E3	1490	22x107; ch.→BF1-563073; 05/1986 →		SK-1223	BTK	
1.5, 1.5 i, 1.5 i Turbo	08/85-05/89	E5, E5E2, E5E3	1490	22x107; ch.BF1-563074→; 05/1986 →		SK-1225	BTK	
1.6 GT	01/86-12/88	B6 (SOHC)	1598	22x107; ch.BF1-143150→		SK-1223	BTK	
1.6 GT	11/86-10/89	B6 (SOHC)	1597	22x107; ch.BF1-143150→; BF1-563073; → 02/1989		SK-1223	BTK	
1.6 GT	11/86-10/89	B6 (SOHC)	1597	22x107; ch.BF1-563074→; 02/1989 →		SK-1225	BTK	
1.6 GT Turbo	10/85-11/91	B6T	1598	22x145; ch.BF1-563074→; 04/1987 →		SK-1224	BTK	
1.7 D	09/86-05/89	PN27, PN46	1720	25x152		SK-1453	BTK	
1.3	08/85-05/89	E3	1296	04/1987 →		0-N983	TB [TE]	
1.5	08/85-05/89	E5	1490	04/1987 →		0-N983	TB [TE]	
1.5	09/87-10/89	B5	1498			0-N983	TB [TE]	
1.5 i	08/85-05/89	E5E3	1490			0-N983	TB [TE]	
1.6 GT	01/86-12/88	B6 (SOHC)	1598			0-N983	TB [TE]	
1.6 GT	11/86-10/89	B6 (SOHC)	1597			0-N983	TB [TE]	
1.6 GT Turbo	10/85-11/91	B6T	1598			0-N069	TB [TE]	
1.6 GT Turbo	10/85-11/91	B6T	1598			0-N070	TB [DG]	
1.7 D	09/86-05/89	PN27, PN46	1720			0-N180	TB [TE]	
323 III Hatchback (BF)								
1.3	09/85-12/87	E3	1296	22x107; ch.→BF...-563073; 04/1987 →		SK-1223	BTK	
1.3	09/85-12/87	E3	1296	22x107; ch.BF...-563074→; 04/1987 →		SK-1225	BTK	
1.3 i, 1.4	09/85-10/89	B3, B3E	1324	22x107; ch.→BF...-563073		SK-1223	BTK	
1.3 i, 1.4	09/85-10/89	B3, B3E	1324	22x107; ch.BF...-563074→		SK-1225	BTK	
1.5	09/87-10/89	B5	1498	22x107; ch.→BF1-563073		SK-1223	BTK	
1.5	09/87-10/89	B5	1498	22x107; ch.BF1-563074→		SK-1225	BTK	
1.5 i Turbo	08/85-05/89	E5E2	1490	22x107; ch.→BF1-563073; 04/1987 →		SK-1223	BTK	
1.5 i Turbo	08/85-05/89	E5E2	1490	22x107; ch.BF1-563074→; 04/1987 →		SK-1225	BTK	
1.5, 1.5 i	08/85-05/89	E5, E5E3	1490	22x107; ch.→BF1-563073; 05/1986 →		SK-1223	BTK	
1.5, 1.5 i	08/85-05/89	E5, E5E3	1490	22x107; ch.BF1-563074→; 05/1986 →		SK-1225	BTK	
1.6 GT	08/85-08/93	B6 (SOHC)	1598	22x107; ch.BF1-143150→; BF1-563073; → 02/1989		SK-1223	BTK	
1.6 GT	08/85-08/93	B6 (SOHC)	1598	22x107; ch.BF1-563074→; 02/1989 →		SK-1225	BTK	
1.6 GT Turbo	10/85-08/93	B6T	1598	22x145; ch.BF1-563074→; 04/1987 →		SK-1224	BTK	
1.6 GT Turbo 4WD	08/87-10/89	B6F2	1597	22x145; ch.BF1-563074→		SK-1224	BTK	
1.6 GT Turbo 4WD	10/87-11/91	B6T	1598	22x145; ch.BF1-563074→		SK-1224	BTK	
1.6, 1.6 GT	09/87-10/89	B6 (SOHC), B68	1597	22x107; ch.BF1-143150→; BF1-563073; → 02/1989		SK-1223	BTK	
1.6, 1.6 GT	09/87-10/89	B6 (SOHC), B68	1597	22x107; ch.BF1-563074→; 02/1989 →		SK-1225	BTK	
1.7 D	04/86-05/89	PN27, PN46	1720	25x152		SK-1453	BTK	
1.3	09/85-12/87	E3	1296	04/1987 →		0-N983	TB [TE]	
1.4	09/87-10/89	B3	1324			0-N983	TB [TE]	
1.5	08/85-05/89	E5	1490	04/1987 →		0-N983	TB [TE]	
1.5	09/87-10/89	B5	1498			0-N983	TB [TE]	
1.5 i	08/85-05/89	E5E3	1490			0-N983	TB [TE]	
1.6 GT	08/85-08/93	B6 (SOHC)	1598			0-N983	TB [TE]	
1.6 GT Turbo, 1.6 GT Turbo 4WD	10/85-08/93	B6T	1598			0-N069	TB [TE]	
1.6 GT Turbo, 1.6 GT Turbo 4WD	10/85-08/93	B6T	1598			0-N070	TB [DG]	
1.6 GT Turbo 4WD	08/87-10/89	B6F2	1597			0-N069	TB [TE]	
1.6 GT Turbo 4WD	08/87-10/89	B6F2	1597			0-N070	TB [DG]	
1.6, 1.6 GT	09/87-10/89	B6 (SOHC), B68	1597			0-N983	TB [TE]	
1.7 D	04/86-05/89	PN27, PN46	1720			0-N180	TB [TE]	

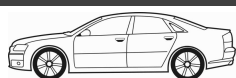

CM³



Art. Nr.



323 III Station Wagon (BW)

1.3	07/86-04/90	E3	1296	22x107; ch.→BW...-414121; 07/1987 → 02/1989	SK-1223	BTK
1.3	07/86-04/90	E3	1296	22x107; ch.BW...-414122→; 02/1989 →	SK-1225	BTK
1.5	01/87-05/89	B5, B50, B53	1498	22x107; ch.→BW...-414121; 07/1987 → 02/1989	SK-1223	BTK
1.5	01/87-05/89	B5, B50, B53	1498	22x107; ch.BW...-414122→; 02/1989 →	SK-1225	BTK
1.6	09/86-10/95	B6 (SOHC), B65M, B6E	1598	22x107; ch.→BW...-414121; → 02/1989	SK-1223	BTK
1.6	09/86-10/95	B6 (SOHC), B65M, B6E	1598	22x107; ch.BW...-414122→; 02/1989 →	SK-1225	BTK
1.6 4x4	05/90-03/93	B65M, B6E	1598	22x107	SK-1225	BTK
1.7 D	11/86-03/93	PN26, PN26, PN54	1720	25x152	SK-1453	BTK
1.5	05/86-05/89	B50, B53, E5	1490		0-N983	TB [TE]
1.5	01/87-05/89	B5, B50, B53	1498		0-N983	TB [TE]
1.6	09/87-10/89	B68	1597		0-N983	TB [TE]
1.6, 1.6 4x4	09/86-10/95	B6 (SOHC), B65M, B6E, B65M, B6E	1598		0-N983	TB [TE]
1.7 D	11/86-03/93	PN26, PN26, PN54	1720		0-N180	TB [TE]

323 C IV (BG)

1.3, 1.3 16V	09/89-07/94	B3 (16V), B3E	1324	22x107	SK-1225	BTK
1.6	09/93-09/00	B67K	1597	22x107	SK-1225	BTK
1.6, 1.6 16V	09/89-10/94	B6, B6E	1598	22x107	SK-1225	BTK
1.7 D	08/89-07/94	PN54	1720	25x152	SK-1453	BTK
1.8 16V	09/89-03/93	BP22	1840	22x145; Nockenwelle: DOHC; Baumuster: BG	SK-1224	BTK
1.8 16V GT	09/89-03/93	BP (DOHC)	1840	22x145; 04/1990 →	SK-1224	BTK
1.8 16V, 1.8 16V 4WD, 1.8 16V GT, 1.8 16V Turbo 4WD	09/89-07/94	BP, BP (DOHC), BP Turbo, BP22, BP31	1840	22x107; Nockenwelle: SOHC/OHC	SK-1225	BTK
1.8, 1.8 16V 4WD, 1.8 16V Turbo 4WD	09/89-07/94	BP, BP Turbo, BP21	1840	22x145	SK-1224	BTK
1.3, 1.3 16V	09/89-07/94	B3 (16V), B3E	1324		0-N983	TB [TE]
1.6, 1.6 16V	09/89-10/94	B6, B6E	1598		0-N983	TB [TE]
1.7 D	08/89-07/94	PN54	1720		0-N180	TB [TE]
1.8 16V 4WD	11/91-12/93	BP	1840		0-N983	TB [TE]
1.8 16V GT, 1.8 16V Turbo 4WD	09/89-07/94	BP (DOHC), BP Turbo	1840		0-N069	TB [TE]
1.8 16V GT, 1.8 16V Turbo 4WD	09/89-07/94	BP (DOHC), BP Turbo	1840		0-N070	TB [DG]

323 F IV (BG)

1.6	04/87-08/93	B6 (SOHC)	1597	22x107; ch.BF1-143150→; BF1-563073; → 02/1989	SK-1223	BTK
1.6	04/87-08/93	B6 (SOHC)	1597	22x107; ch.BF1-563074→; 02/1989 →	SK-1225	BTK
1.6	04/91-04/94	B67J, B67K, B67L	1597	22x107	SK-1225	BTK
1.6, 1.6 16V	09/89-10/94	B6, B6E	1598	22x107	SK-1225	BTK
1.8 16V, 1.8 16V GT	08/89-07/94	BP (DOHC), BP31	1840	22x145	SK-1224	BTK
1.8 16V, 1.8 4WD	08/89-07/94	BP, BPC	1840	22x107	SK-1225	BTK
1.6, 1.6 16V	09/89-10/94	B6, B6E	1598		0-N983	TB [TE]
1.8 16V GT	08/89-07/94	BP (DOHC)	1840		0-N069	TB [TE]
1.8 16V GT	08/89-07/94	BP (DOHC)	1840		0-N070	TB [DG]
1.8 16V, 1.8 4WD	08/89-07/94	BP, BPC	1840		0-N983	TB [TE]

323 S IV (BG)

1.3, 1.3 16V	09/89-07/94	B3 (16V), B383, B3E	1324	22x107	SK-1225	BTK
1.6, 1.6 16V	08/89-10/94	B6, B6E	1598	22x107	SK-1225	BTK
1.7 D	08/89-07/94	PN46, PN54, PN62	1720	25x152	SK-1453	BTK
1.8 16V	08/89-07/94	BP52	1840	22x107; 04/1991 →	SK-1225	BTK
1.8 16V 4WD	09/91-07/94	BP52	1840	22x107	SK-1225	BTK
1.8 16V GT, 1.8 16V Turbo 4WD	06/89-07/94	BP (DOHC), BP Turbo	1840	22x145	SK-1224	BTK
1.3, 1.3 16V	09/89-07/94	B3 (16V), B383, B3E	1324		0-N983	TB [TE]
1.6, 1.6 16V	08/89-10/94	B6, B6E	1598		0-N983	TB [TE]
1.7 D	08/89-07/94	PN46, PN54, PN62	1720		0-N180	TB [TE]
1.8 16V	08/89-07/94	BP52	1840		0-N983	TB [TE]
1.8 16V GT, 1.8 16V Turbo 4WD	06/89-07/94	BP (DOHC), BP Turbo	1840		0-N069	TB [TE]
1.8 16V GT, 1.8 16V Turbo 4WD	06/89-07/94	BP (DOHC), BP Turbo	1840		0-N070	TB [DG]

323 C V (BA)

1.3 16V	08/94-09/98	B3 (16V)	1324	22x107	SK-1225	BTK
1.5 16V	08/94-09/98	Z5-DE	1489	22x125; BA1...-605120; → 10/1997	SK-1233	BTK
1.5 16V	08/94-09/98	Z5-DE	1489	22x123; ch.BA1...-605121→; 10/1997 →	SK-1627	BTK
1.8 16V	08/94-09/98	BP-ZE	1840	22x145	SK-1224	BTK
1.3 16V	08/94-09/98	B3 (16V)	1324		0-N983	TB [TE]
1.5 16V	08/94-09/98	Z5-DE	1489		0-N069	TB [TE]
1.5 16V	08/94-09/98	Z5-DE	1489		0-N070	TB [DG]

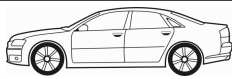

CM³



Art. Nr.



323 C V (BA)

1.5 16V	08/94-09/98	Z5-DE	1489	ch.→BA1-605120; → 10/1997	0-N1380	TB [DG]
1.8 16V	08/94-09/98	BP-ZE	1840		0-N069	TB [TE]
1.8 16V	08/94-09/98	BP-ZE	1840		0-N070	TB [DG]

323 F V (BA)

1.5 16V	07/94-09/98	Z5-DE	1489	22x125; BA1...-605120; → 10/1997	SK-1233	BTK
1.5 16V	07/94-09/98	Z5-DE	1489	22x123; ch.BA1...-605121→; 10/1997 →	SK-1627	BTK
1.8 16V	08/94-09/98	BP-ZE	1840	22x145	SK-1224	BTK
2.0 24V	08/94-09/98	KF	1995	30x192; 01/1995 →	SK-1457	BTK
1.5 16V	07/94-09/98	Z5-DE	1489		0-N069	TB [TE]
1.5 16V	07/94-09/98	Z5-DE	1489		0-N070	TB [DG]
1.5 16V	07/94-09/98	Z5-DE	1489	ch.→BA1-605120; → 10/1997	0-N1380	TB [DG]
1.8 16V	08/94-09/98	BP-ZE	1840		0-N069	TB [TE]
1.8 16V	08/94-09/98	BP-ZE	1840		0-N070	TB [DG]
2.0 24V	08/94-09/98	KF	1995	mit Anbaumaterial	0-N079	TB [TE]
2.0 24V	08/94-09/98	KF	1995		0-N080	TB [DG]
2.0 24V	08/94-09/98	KF	1995		0-N081	TB [DG]
2.0 24V	08/94-09/98	KF	1995		0-N2160	TB [BT]
2.0 24V	08/94-09/98	KF	1995		0-N2024	VB [TE]
2.0 24V	08/94-09/98	KF	1995		0-N2041	VB [DG]

323 P V (BA)

1.3 16V	10/96-09/98	B3 (16V)	1324	22x107	SK-1225	BTK
1.5 16V	10/96-09/98	Z5-DE	1489	22x125; BA1...-605120; → 10/1997	SK-1233	BTK
1.5 16V	10/96-09/98	Z5-DE	1489	22x123; ch.BA1...-605121→; 10/1997 →	SK-1627	BTK
1.3 16V	10/96-09/98	B3 (16V)	1324		0-N983	TB [TE]
1.5 16V	10/96-09/98	Z5-DE	1489		0-N069	TB [TE]
1.5 16V	10/96-09/98	Z5-DE	1489		0-N070	TB [DG]
1.5 16V	10/96-09/98	Z5-DE	1489	ch.→BA1-605120; → 10/1997	0-N1380	TB [DG]
2.0 D	10/96-09/98	RF1G	1998		0-N1816	TB [DG]
2.0 D	10/96-09/98	RF1G	1998		0-N1825	TB [BT]

323 S V (BA)

1.3 16V	08/94-09/98	B3 (16V)	1324	22x107	SK-1225	BTK
1.5 16V	08/94-09/98	Z5-DE	1489	22x125; BA1...-605120; → 10/1997	SK-1233	BTK
1.5 16V	08/94-09/98	Z5-DE	1489	22x123; ch.BA1...-605121→; 10/1997 →	SK-1627	BTK
1.6	08/94-09/98	B6 (DOHC)	1598	22x145	SK-1224	BTK
1.6 TD	05/94-09/98	4EE1-T	1686	25x136; 11/1994 →; mit Zubehör	SK-1168	BTK
1.8 16V	08/94-09/98	BP-ZE	1840	22x145	SK-1224	BTK
2.0	07/94-09/98	ZKF48, ZKF49	1995	25x135; mit Zubehör	SK-1221	BTK
1.3 16V	08/94-09/98	B3 (16V)	1324		0-N983	TB [TE]
1.5 16V	08/94-09/98	Z5-DE	1489		0-N069	TB [TE]
1.5 16V	08/94-09/98	Z5-DE	1489		0-N070	TB [DG]
1.5 16V	08/94-09/98	Z5-DE	1489	ch.→BA1-605120; → 10/1997	0-N1380	TB [DG]
1.6 TD	05/94-09/98	4EE1-T	1686		0-N126	TB [TE]
1.6 TD	05/94-09/98	4EE1-T	1686		0-N878	TB [DG]
1.8 16V	08/94-09/98	BP-ZE	1840		0-N069	TB [TE]
1.8 16V	08/94-09/98	BP-ZE	1840		0-N070	TB [DG]
2.0 D	10/96-09/98	RF1G	1998		0-N1816	TB [DG]
2.0 D	10/96-09/98	RF1G	1998		0-N1825	TB [BT]

323 F VI (BJ)

1.4, 1.4 16V	09/98-05/04	B3 (16V), B3 ME	1324	22x107	SK-1225	BTK
1.5 16V	09/98-01/01	ZL05, ZL06	1498	22x123	SK-1627	BTK
1.6	01/01-05/04	ZM	1598	22x123	SK-1627	BTK
1.8 Astina, 1.9 16V	09/98-05/04	BP (DOHC), FP, FP55	1840	25x133	SK-1222	BTK
2.0	01/01-05/04	FS7E, FS7G	1991	25x135; mit Zubehör	SK-1221	BTK
2.0 TD	09/98-12/01		1998	27x153	SK-1671	BTK
2.0 TD	09/98-05/04	RF4F	1998	27x153	SK-1671AQ1	BTKW
2.0 TD	01/01-05/04	RF4F	1998	27x153; → 10/2003	SK-1671	BTK
1.4, 1.4 16V	09/98-05/04	B3 (16V), B3 ME	1324		0-N983	TB [TE]
1.5 16V	09/98-01/01	ZL05, ZL06	1498		0-N069	TB [TE]
1.5 16V	09/98-01/01	ZL05, ZL06	1498		0-N070	TB [DG]
1.6	01/01-05/04	ZM	1598		0-N069	TB [TE]
1.6	01/01-05/04	ZM	1598		0-N070	TB [DG]
1.8 Astina, 1.9 16V	09/98-05/04	BP (DOHC), FP, FP55	1840		0-N076	TB [TE]
1.9 16V	09/98-01/01	FP, FP55	1840		0-N077	TB [DG]
2.0	01/01-05/04	FS7E, FS7G	1991		0-N077	TB [DG]

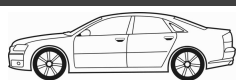

CM³



Art. Nr.



323 F VI (BJ)							
2.0	01/01-05/04	FS7E, FS7G	1991			0-N078	TB [TE]
2.0 D	09/98-05/04	RF1G	1998			0-N1816	TB [DG]
2.0 D	09/98-05/04	RF1G	1998			0-N1825	TB [BT]
2.0 TD	09/98-05/04	RF4F	1998			0-N1379	TB [TE]
2.0 TD	09/98-05/04	RF4F	1998			0-N1578	TB [DG]
2.0 TD	09/98-05/04	RF4F	1998			0-N1936	TB [BT]

323 S VI (BJ)							
1.4, 1.4 16V	09/98-05/04	B3 (16V), B3 ME	1324	22x107		SK-1225	BTK
1.5 16V	09/98-01/01	ZL05, ZL06	1498	22x123		SK-1627	BTK
1.6	09/98-05/04	B6 (DOHC), ZM	1598	22x123		SK-1627	BTK
1.8 Protege, 1.9 16V	05/98-05/04	BP (DOHC), FP, FP55	1840	25x133		SK-1222	BTK
2.0	02/00-05/04	FS, FS7E, FS7G	1991	25x135; mit Zubehör		SK-1221	BTK
2.0 DiTD, 2.0 TD	09/98-05/04	RF3F, RF4F	1998	27x153		SK-1671	BTK
2.0 DiTD, 2.0 TD	09/98-05/04	RF3F, RF4F	1998	27x153		SK-1671AQ1	BTKW
1.4, 1.4 16V	09/98-05/04	B3 (16V), B3 ME	1324			0-N983	TB [TE]
1.5, 1.5 16V	05/98-05/04	ZL05, ZL06	1498			0-N069	TB [TE]
1.5, 1.5 16V	05/98-05/04	ZL05, ZL06	1498			0-N070	TB [DG]
1.6	01/01-05/04	ZM	1598			0-N069	TB [TE]
1.6	01/01-05/04	ZM	1598			0-N070	TB [DG]
1.8 Protege, 1.9 16V	05/98-05/04	BP (DOHC), FP, FP55	1840			0-N076	TB [TE]
1.8 Protege, 1.9 16V	05/98-05/04	BP (DOHC), FP, FP55	1840			0-N077	TB [DG]
2.0	01/01-05/04	FS7E, FS7G	1991			0-N077	TB [DG]
2.0	01/01-05/04	FS7E, FS7G	1991			0-N078	TB [TE]
2.0 D	09/98-05/04	RF1G	1998			0-N1816	TB [DG]
2.0 D	09/98-05/04	RF1G	1998			0-N1825	TB [BT]
2.0 DiTD, 2.0 TD	09/98-05/04	RF3F, RF4F	1998			0-N1379	TB [TE]
2.0 DiTD, 2.0 TD	09/98-05/04	RF3F, RF4F	1998			0-N1578	TB [DG]
2.0 DiTD, 2.0 TD	09/98-05/04	RF3F, RF4F	1998			0-N1936	TB [BT]

626 II (GC)							
2.0	03/83-09/87	FE (8V)	1998	22x109; 08/1985 →		SK-1219	BTK
2.0, 2.0 i Turbo	01/86-10/87	FE (8V), FET	1998	22x109		SK-1219	BTK
1.6	11/82-06/87	F6	1587			0-N071	TB [TE]
1.6	11/82-06/87	F6	1587	01/1985 →		0-N072	TB [TE]
2.0	03/83-09/87	FE (8V)	1998	→ 06/1985		0-N071	TB [TE]
2.0	03/83-09/87	FE (8V)	1998	07/1985 →		0-N072	TB [TE]
2.0	01/86-09/87	FE (8V)	1998			0-N072	TB [TE]
2.0 D	01/83-06/87	RF46	1998			0-N027	TB [TE]
2.0 D	01/83-06/87	RF46	1998			0-N082	TB [TE]

626 II Coupe (GC)							
2.0	01/86-10/87	FE (8V)	1998	25x108		SK-1227	BTK
2.0, 2.0 i Turbo	02/83-10/87	FE (8V), FET	1998	22x109		SK-1219	BTK

626 II Hatchback (GC)							
2.0	03/83-09/87	FE (8V)	1998	22x109; 08/1985 →		SK-1219	BTK
2.0, 2.0 i Turbo	01/85-10/87	FE (8V), FET	1998	22x109		SK-1219	BTK
1.6	03/83-09/87	F6, F603, F658	1587			0-N071	TB [TE]
1.6	03/83-09/87	F6	1587	01/1985 →		0-N072	TB [TE]
1.6	03/83-09/87	F603, F658	1587	07/1985 → 12/1986		0-N072	TB [TE]
2.0	03/83-09/87	FE (8V)	1998	→ 06/1985		0-N071	TB [TE]
2.0	03/83-09/87	FE (8V)	1998	07/1985 →		0-N072	TB [TE]
2.0	01/85-09/87	FE (8V)	1998			0-N072	TB [TE]
2.0 D	03/84-06/87	RF46	1998			0-N027	TB [TE]
2.0 D	03/84-06/87	RF46	1998			0-N082	TB [TE]

626 III (GD)							
2.0	09/87-10/90	FE (12V)	1998	22x109		SK-1219	BTK
2.0 12V	09/87-05/92	FE (12V)	1998	22x109; 08/1988 →		SK-1219	BTK
2.0 16V	07/87-05/92	FE (16V)	1998	25x168		SK-1231	BTK
2.0 D	07/87-07/91	RF-N	1998	30x162		SK-1228	BTK
2.2 12V	11/87-07/91	F2	2184	25x110		SK-1226	BTK
1.8	11/87-05/92	F8 (12V)	1789			0-N073	TB [TE]
1.8	11/87-05/92	F8 (12V)	1789			0-N074	TB [DG]
2.0 12V	09/87-05/92	FE (12V)	1998			0-N072	TB [TE]
2.0 16V	11/87-05/92	FE (16V)	1998			0-N075	TB [DG]
2.0 D	07/87-07/91	RF-N	1998			0-N083	TB [TE]

CM³

Art. Nr.



ohne Halter

626 III (GD)

2.0 D	07/87-07/91	RF-N	1998		0-N084	TB [DG]
2.0, 2.0 12V	09/87-05/92	FE (12V)	1998		0-N074	TB [DG]
2.0, 2.0 12V, 2.0 16V	09/87-05/92	FE (12V), FE (16V)	1998		0-N073	TB [TE]
2.2 12V	11/87-07/91	F2	2184		0-N072	TB [TE]
2.2 12V	11/87-07/91	F2	2184		0-N073	TB [TE]
2.2 12V	11/87-07/91	F2	2184		0-N074	TB [DG]

626 III Coupe (GD)

2.0	09/87-10/90	FE (8V)	1998	22x109	SK-1219	BTK
2.0 12V	09/87-12/88	FE (12V)	1998	25x108	SK-1227	BTK
2.0 16V	12/87-10/90	FE (16V)	1998	25x168	SK-1231	BTK
2.2 12V	04/88-12/91	F2	2184	25x110	SK-1226	BTK
2.0 12V	09/87-12/88	FE (12V)	1998		0-N072	TB [TE]
2.0 16V	12/87-10/90	FE (16V)	1998		0-N075	TB [DG]
2.0, 2.0 12V	09/87-10/90	FE (12V), FE (8V)	1998		0-N074	TB [DG]
2.0, 2.0 12V, 2.0 16V	09/87-10/90	FE (12V), FE (16V), FE (8V)	1998		0-N073	TB [TE]
2.2 12V	04/88-12/91	F2	2184		0-N072	TB [TE]
2.2 12V	04/88-12/91	F2	2184		0-N073	TB [TE]
2.2 12V	04/88-12/91	F2	2184		0-N074	TB [DG]

626 III Hatchback (GD)

2.0	09/87-10/90	FE (8V)	1998	22x109	SK-1219	BTK
2.0 12V	11/87-05/92	FE (12V)	1998	25x108	SK-1227	BTK
2.0 16V, 2.0 4x4	06/87-07/91	FE (16V), FEFL	1998	25x168	SK-1231	BTK
2.0 D	07/87-07/91	RF-N	1998	30x162	SK-1228	BTK
2.2 12V, 2.2 12V 4WD	11/87-04/92	F2	2184	25x110	SK-1226	BTK
1.8	11/87-05/92	F8 (12V)	1789		0-N073	TB [TE]
1.8	11/87-05/92	F8 (12V)	1789		0-N074	TB [DG]
2.0 12V	11/87-05/92	FE (12V)	1998		0-N072	TB [TE]
2.0 16V	11/87-10/90	FE (16V)	1998		0-N075	TB [DG]
2.0 D	07/87-07/91	RF-N	1998		0-N083	TB [TE]
2.0 D	07/87-07/91	RF-N	1998		0-N084	TB [DG]
2.0, 2.0 12V	09/87-05/92	FE (12V), FE (8V)	1998		0-N074	TB [DG]
2.0, 2.0 12V, 2.0 16V	09/87-05/92	FE (12V), FE (16V), FE (8V)	1998		0-N073	TB [TE]
2.2 12V	06/88-04/92	F2	2184		0-N073	TB [TE]
2.2 12V	06/88-04/92	F2	2184		0-N074	TB [DG]
2.2 12V, 2.2 12V 4WD	11/87-04/92	F2	2184		0-N072	TB [TE]

626 III Station Wagon (GV)

2.0	10/88-09/97	FE (8V)	1998	25x108	SK-1227	BTK
2.0 12V	09/87-01/90	FE (12V)	1998	25x108; 03/1988 →	SK-1227	BTK
2.0 16V, 2.0 i 16V	01/88-09/97	FE (16V), FECM	1998	25x168	SK-1231	BTK
2.0 D, 2.0 D Complex	09/88-09/97	RF-CX, RFG5, RF-N	1998	30x162	SK-1228	BTK
2.2 12V, 2.2 12V 4WD	03/89-11/96	F2, F2, F2L1	2184	25x110	SK-1226	BTK
2.0	10/88-09/97	FE (8V)	1998		0-N074	TB [DG]
2.0 16V, 2.0 i 16V	01/88-09/97	FE (16V), FECM	1998		0-N075	TB [DG]
2.0 D, 2.0 D Complex	09/88-09/97	RF-CX, RFG5, RF-N	1998		0-N083	TB [TE]
2.0 D, 2.0 D Complex	09/88-09/97	RF-CX, RFG5, RF-N	1998		0-N084	TB [DG]
2.0 i 16V	11/94-09/97	FECM	1998		0-N078	TB [TE]
2.0, 2.0 12V	09/87-09/97	FE (12V), FE (8V)	1998		0-N072	TB [TE]
2.0, 2.0 16V, 2.0 i 16V	01/88-09/97	FE (16V), FE (8V), FECM	1998		0-N073	TB [TE]
2.2 12V, 2.2 12V 4WD	03/89-11/96	F2, F2, F2L1	2184		0-N072	TB [TE]
2.2 12V, 2.2 12V 4WD	03/89-11/96	F2, F2, F2L1	2184		0-N073	TB [TE]
2.2 12V, 2.2 12V 4WD	03/89-11/96	F2, F2, F2L1	2184		0-N074	TB [DG]

626 IV (GE)

1.8 i	01/92-06/97	FP	1840	25x133	SK-1222	BTK
2.0 D, 2.0 D GLX Complex	10/92-06/97	RF OHC, RF55	1998	30x162	SK-1228	BTK
2.0 i, 2.0 i 4WD	01/92-04/97	FS	1991	25x135; mit Zubehör	SK-1221	BTK
1.8 i	01/92-04/97	FP	1840		0-N076	TB [TE]
1.8 i	01/92-06/97	FP	1840		0-N077	TB [DG]
2.0 D GLX Complex	10/92-04/97	RF OHC	1998		0-N083	TB [TE]
2.0 D GLX Complex	10/92-04/97	RF OHC	1998		0-N084	TB [DG]
2.0 i, 2.0 i 4WD	01/92-04/97	FS	1991		0-N077	TB [DG]
2.0 i, 2.0 i 4WD	01/92-04/97	FS	1991		0-N078	TB [TE]

626 IV Hatchback (GE)

1.8	08/91-04/97	FP, FP01LP	1840	25x133	SK-1222	BTK
-----	-------------	------------	------	--------	---------	-----

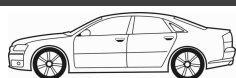

CM³



Art. Nr.



626 IV Hatchback (GE)							
2.0 D GLX Complex	01/93-04/97	RF55	1998	30x162		SK-1228	BTK
2.0 i, 2.0 i 4WD	08/91-04/97	FS	1991	25x135; mit Zubehör		SK-1221	BTK
2.5 24V	01/92-04/97	KL	2497	30x192		SK-1457	BTK
1.8	08/91-04/97	FP, FP01LP	1840			0-N076	TB [TE]
1.8	08/91-04/97	FP, FP01LP	1840			0-N077	TB [DG]
2.0 D GLX Complex	01/93-04/97	RF55	1998			0-N083	TB [TE]
2.0 D GLX Complex	01/93-04/97	RF55	1998			0-N084	TB [DG]
2.0 i, 2.0 i 4WD	08/91-04/97	FS	1991			0-N077	TB [DG]
2.0 i, 2.0 i 4WD	08/91-04/97	FS	1991			0-N078	TB [TE]
2.5 24V	01/92-04/97	KL	2497	mit Anbaumaterial		0-N079	TB [TE]
2.5 24V	01/92-04/97	KL	2497			0-N080	TB [DG]
2.5 24V	01/92-04/97	KL	2497			0-N081	TB [DG]
2.5 24V	01/92-04/97	KL	2497			0-N2160	TB [BT]
2.5 24V	01/92-04/97	KL	2497			0-N2024	VB [TE]
2.5 24V	01/92-04/97	KL	2497			0-N2041	VB [DG]
626 V (GF)							
1.8	05/97-10/02	FP9A, FPY3	1840	25x133		SK-1222	BTK
2.0	05/97-10/02	FS	1991	25x135; mit Zubehör		SK-1221	BTK
2.0	04/98-10/02	FS2C	1991	25x135; 08/1999 →; mit Zubehör		SK-1221	BTK
2.0 DITD	04/98-10/02	RF3F	1998	27x153; 04/1999 → 04/2002		SK-1671	BTK
2.0 DITD, 2.0 TD, 2.0 Turbo DI	04/98-10/02	RF3F, RF59	1998	27x153		SK-1671AQ1	BTKW
2.0 TD, 2.0 Turbo DI	04/98-10/02	RF59	1998	27x153		SK-1671	BTK
1.8	05/97-10/02	FP9A, FPY3	1840			0-N076	TB [TE]
1.8	05/97-10/02	FP9A, FPY3	1840			0-N077	TB [DG]
2.0	05/97-10/02	FS, FS2C	1991			0-N077	TB [DG]
2.0	05/97-10/02	FS, FS2C	1991			0-N078	TB [TE]
2.0 DITD, 2.0 TD, 2.0 Turbo DI	04/98-10/02	RF3F, RF59	1998			0-N1379	TB [TE]
2.0 DITD, 2.0 TD, 2.0 Turbo DI	04/98-10/02	RF3F, RF59	1998			0-N1578	TB [DG]
2.0 DITD, 2.0 TD, 2.0 Turbo DI	04/98-10/02	RF3F, RF59	1998			0-N1936	TB [BT]
626 V Hatchback (GF)							
1.8	05/97-10/02	FP, FPY3	1840	25x133		SK-1222	BTK
2.0 DITD, 2.0 TD, 2.0 Turbo DI	04/98-10/02	RF3F	1998	27x153		SK-1671	BTK
2.0 DITD, 2.0 TD, 2.0 Turbo DI	04/98-10/02	RF3F	1998	27x153		SK-1671AQ1	BTKW
2.0, 2.0 H.P.	05/97-10/02	FS, FS2C	1991	25x135; mit Zubehör		SK-1221	BTK
1.8	05/97-10/02	FP, FPY3	1840			0-N076	TB [TE]
1.8	05/97-10/02	FP, FPY3	1840			0-N077	TB [DG]
2.0 DITD, 2.0 TD, 2.0 Turbo DI	04/98-10/02	RF3F	1998			0-N1379	TB [TE]
2.0 DITD, 2.0 TD, 2.0 Turbo DI	04/98-10/02	RF3F	1998			0-N1578	TB [DG]
2.0 DITD, 2.0 TD, 2.0 Turbo DI	04/98-10/02	RF3F	1998			0-N1936	TB [BT]
2.0, 2.0 H.P.	05/97-10/02	FS, FS2C	1991			0-N077	TB [DG]
2.0, 2.0 H.P.	05/97-10/02	FS, FS2C	1991			0-N078	TB [TE]
626 V Station Wagon (GW)							
1.8	02/98-10/02	FP9A, FPY3	1840	25x133		SK-1222	BTK
2.0 DITD, 2.0 TD, 2.0 Turbo DI	04/98-10/02	RF3F, RF4F	1998	27x153		SK-1671	BTK
2.0 DITD, 2.0 TD, 2.0 Turbo DI	04/98-10/02	RF3F, RF4F	1998	27x153		SK-1671AQ1	BTKW
2.0, 2.0 H.P.	02/98-10/02	FS, FS2C	1991	25x135; mit Zubehör		SK-1221	BTK
1.8	02/98-10/02	FP9A, FPY3	1840			0-N076	TB [TE]
1.8	02/98-10/02	FP9A, FPY3	1840			0-N077	TB [DG]
2.0 DITD, 2.0 TD, 2.0 Turbo DI	04/98-10/02	RF3F, RF4F	1998			0-N1379	TB [TE]
2.0 DITD, 2.0 TD, 2.0 Turbo DI	04/98-10/02	RF3F, RF4F	1998			0-N1578	TB [DG]
2.0 DITD, 2.0 TD, 2.0 Turbo DI	04/98-10/02	RF3F, RF4F	1998			0-N1936	TB [BT]
2.0 Turbo DI	04/98-10/02	RF4F	1998			0-N077	TB [DG]
2.0, 2.0 H.P.	02/98-10/02	FS, FS2C	1991			0-N077	TB [DG]
2.0, 2.0 H.P.	02/98-10/02	FS, FS2C	1991			0-N078	TB [TE]
929 II (HB)							
2.0	05/82-03/84	HEE, MA	1970			0-N072	TB [TE]
2.0, 2.0 i GLX	03/84-07/87	FE (8V)	1998			0-N071	TB [TE]
2.0, 2.0 i GLX	03/84-07/87	FE (8V)	1998	ch.EP-554513, ES-555011 → 02/1987		0-N072	TB [TE]
929 II Coupe (HB)							
2.0	05/82-03/84	HEE, MA	1970			0-N072	TB [TE]
2.0, 2.0 i Turbo	03/84-07/87	FE (8V), FET	1998			0-N071	TB [TE]
2.0, 2.0 i Turbo	03/84-07/87	FE (8V), FET	1998	ch.EP-554513, ES-555011 → 02/1987		0-N072	TB [TE]

CM³

Art. Nr.

**929 II Kombi (HV)**

2.0	01/83-12/87	HEE, MA	1970	25x108; 12/1986 →	SK-1227	BTK	
2.0	01/83-12/87	HEE, MA	1970		0-N072	TB [TE]	

929 III (HC)

2.0	06/87-12/88	FE (8V), FEFA	1998	25x108	SK-1227	BTK	
2.2 12V, 2.2 i	05/87-06/91	F2, F21, F2E, F2-C, F2-EGI	2184	25x110	SK-1226	BTK	
2.0	06/87-12/88	FE (8V), FEFA	1998		0-N073	TB [TE]	
2.0	06/87-12/88	FE (8V), FEFA	1998		0-N074	TB [DG]	
2.2 12V, 2.2 i	05/87-06/91	F2, F21, F2E, F2-C, F2-EGI	2184		0-N072	TB [TE]	
2.2 12V, 2.2 i	05/87-06/91	F2, F21, F2E, F2-C, F2-EGI	2184		0-N073	TB [TE]	
2.2 12V, 2.2 i	05/87-06/91	F2, F21, F2E, F2-C, F2-EGI	2184		0-N074	TB [DG]	
3.0, 3.0 i	06/87-06/91	JE, JE3	2954		0-N085	TB [DG]	
3.0, 3.0 i	06/87-06/91	JE, JE3	2954		0-N086	TB [DG]	
3.0, 3.0 i	06/87-06/91	JE, JE3	2954		0-N087	TB [TE]	
3.0, 3.0 i	06/87-06/91	JE, JE3	2954	Nockenwelle: DOHC	0-N088	TB [DG]	
3.0, 3.0 i	06/87-06/91	JE, JE3	2954		0-N2159	VB [VD]	

929 IV (HD)

3.0 i	07/91-03/96	JEZE	2954		0-N090	TB [DG]	
3.0 i	07/91-03/96	JEZE	2954		0-N091	TB [DG]	

B-SERIE (UD)

1.6	10/81-12/84	H629	1587	22x106; ch.500212→	SK-1232	BTK	
1.6	10/81-12/84	H629	1587	ch.500212→	0-N072	TB [TE]	

B-SERIE (UF)

2.0	01/85-03/96	FE (8V)	1998	22x109	SK-1219	BTK	
2.2	03/85-10/91	S2	2209	25x110	SK-1226	BTK	
2.2	08/91-12/96	F2IB, F2L8	2184	25x110	SK-1226	BTK	
2.2 12V	04/96-01/99		2184	25x110; → 10/1998	SK-1226	BTK	
2.2 D	01/85-03/96	R290	2184	25x164	SK-1302	BTK	
2.5 D	02/96-06/99		2499	30x101	SK-1751	BTK	
2.5 D	04/96-02/99	WL31	2499	30x101; Baumuster: Proceed	SK-1751	BTK	
2.5 D 4WD	02/96-06/99		2500	30x101; Baumuster: Proceed	SK-1751	BTK	
2.5 D 4WD	09/98-06/99	WL31	2500	30x101	SK-1750	BTK	
2.0	01/85-03/96	FE (8V)	1998	ch.505518→	0-N072	TB [TE]	
2.5 D 4WD	02/96-06/99	WL31	2500		0-N1824	TB [BT]	
2.5 D, 2.5 D 4WD	02/96-06/99	WL31	2499		0-N1824	TB [BT]	

B-SERIE Pritsche/Fahrgestell (UF)

2.2 D	01/88-03/96	R290	2184	25x164	SK-1302	BTK	
-------	-------------	------	------	--------	---------	-----	--

B-SERIE (UN)

2.2 8V 4WD	06/99-	JL22	2148	25x110	SK-1226	BTK	
2.2, 2.2 4WD	02/99-08/02	F2R4, R5A2	2184	25x110	SK-1226	BTK	
2.5 D 4WD	02/99-03/05	WLE9, WLF5	2499	30x101	SK-1750	BTK	
2.5 D 4WD	11/99-12/01	WLE7	2499	30x101; Baumuster: Proceed	SK-1750	BTK	
2.5 D, 2.5 D 4WD	06/99-11/06	MD25NA	2500	30x101; Baumuster: Proceed	SK-1750	BTK	
2.5 D, 2.5 D 4WD	12/02-11/06	WLE7	2500	30x101	SK-1750	BTK	
2.5 D, 2.5 D 4WD, 2.5 TD 4WD	06/99-07/06	MD25TI, WLE7	2499	30x101; Baumuster: Bounty	SK-1750	BTK	
2.5 D, 2.5 D 4WD, 2.5 TD 4WD	06/99-07/06	MD25TI, WLE7	2499	30x101; Baumuster: Drifter	SK-1750	BTK	
2.5 TD	02/99-03/05	WL-T (12 V)	2500	30x101; Baumuster: Bravo	SK-1750	BTK	
2.5 TD 4WD	06/99-07/06	MD25TI	2499	30x101; Baumuster: Bravo	SK-1750	BTK	
2.5 D, 2.5 D 4WD, 2.5 TD	02/99-11/06	MD25NA, WLE7, WL-T (12 V)	2500		0-N2225	TB [TE]	
2.5 D, 2.5 D 4WD, 2.5 TD 4WD	02/99-07/06	MD25TI, WLE7, WLE9, WLF5	2499		0-N2225	TB [TE]	

BT-50 (CD, UN)

2.5 MRZ-CD 4x4	12/06-	WLAA	2499		0-N1666	TB [BT]	
2.5 MRZ-CD 4x4	12/06-	WLAA	2499	Nockenwelle: SOHC/OHC; → 12/2007	0-N2225	TB [TE]	
3.0 CDVi, 3.0 CDVi 4x4	12/06-	WEAT	2953		0-N1666	TB [BT]	

BT-50 Pritsche/Fahrgestell (CD, UN)

2.5 CDVi	12/06-	WLAT (16 V)	2500	Nockenwelle: SOHC/OHC; → 12/2007	0-N2225	TB [TE]	
----------	--------	-------------	------	----------------------------------	---------	---------	--

CX-7 (ER)

2.2 MZR-CD, 2.2 MZR-CD AWD	09/09-	R2AA	2184		0-N2244	VB [DG]	
2.2 MZR-CD, 2.2 MZR-CD AWD	09/09-	R2AA	2184		0-N2395	VB [BT]	S
2.3 DISI	01/12-	L3Y7	2260	Rippenanzahl: 6	0-N1858	VB [BT]	S
2.3 MZR DISI Turbo	10/07-	L3-VDT	2261	Rippenanzahl: 6	0-N1858	VB [BT]	S
2.3 MZR DISI Turbo	10/07-	L3-VDT	2261		0-N1859	VB [DG]	

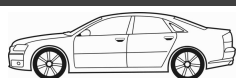

CM³



Art. Nr.



DEMIO (DW)							
1.3 16V, 1.3 i 16V	08/98-07/03	B3 (16V), B3 ME	1324	22x107		SK-1225	BTK
1.5 16V	04/00-07/03	B5 E	1498	22x107		SK-1225	BTK
1.3 16V, 1.3 i 16V	08/98-07/03	B3 (16V), B3 ME	1324			0-N983	TB [TE]
1.5 16V	04/00-07/03	B5 E	1498			0-N983	TB [TE]
E-SERIE Bus (SR1)							
E2000	11/84-05/94	FE (8V), FE18, FEV4	1998	22x109		SK-1219	BTK
E2000 4WD	10/88-09/89	FE (8V), FE18, FEBN	1998	25x108		SK-1227	BTK
E2200 D	01/84-02/88	R207	2169	25x164		SK-1302	BTK
E2000	11/84-05/94	FE (8V), FE18, FEV4	1998			0-N073	TB [TE]
E2000	11/84-05/94	FE (8V), FE18, FEV4	1998			0-N074	TB [DG]
E2000, E2000 4WD	11/84-05/94	FE (8V), FE18, FEBN, FE (8V), FE18, FEV4	1998	ch.X081-508516, Y0E1-516783→; X081-600000, Y0E1-600000		0-N072	TB [TE]
E2200 D	01/84-02/88	R207	2169			0-N092	TB [TE]
E-SERIE Kasten (SR2)							
2200 D 4WD, E2200 D	03/91-05/03	R203, R207	2184	25x164; → 03/1997		SK-1302	BTK
E2000, E2000 4WD	05/85-05/03	FE (8V), FE (8V), FE60, FE61, FE18, FE58, FECK, FEY7, FEY9	1998	25x108		SK-1227	BTK
E2200 D	05/85-02/88	R203, R207	2184	25x164		SK-1302	BTK
2200 D 4WD, E2200 D	03/91-05/03	R203, R207	2184	→ 03/1997		0-N092	TB [TE]
2200 D 4WD, E2200 D	03/91-05/03	R203, R207	2184	04/1997 →		0-N1216	TB [TE]
E2000	05/85-04/89	FE18, FE58	1998	ch.X081-508516, Y0E1-516783→; X081-600000, Y0E1-600000		0-N072	TB [TE]
E2000	05/85-05/03	FE (8V), FE (8V), FE60, FE61, FE18, FE58	1998			0-N073	TB [TE]
E2000	05/85-05/03	FE (8V), FE (8V), FE60, FE61, FE18, FE58	1998			0-N074	TB [DG]
E2200 D	05/85-02/88	R203, R207	2184			0-N092	TB [TE]
E2200 D, E2200 D 4WD	02/97-05/03	R2	2184			0-N1216	TB [TE]
E-SERIE Pritsche/Fahrgestell (SD1)							
E2000	01/83-07/91	FECK	1998	25x108; 06/1983 →		SK-1227	BTK
E2000	11/88-08/98	FEBN, FEY7, FEY9	1998	25x108		SK-1227	BTK
E2200	11/88-03/97	R281	2184	25x164		SK-1302	BTK
E2200	11/88-03/97	R281	2184			0-N092	TB [TE]
E-SERIE Großraumlimousine (SG)							
2.0 i	08/99-10/01	FE (12V)	1998	25x108		SK-1227	BTK
2.5 i	08/99-10/01	WLTDT	2499	25x108		SK-1227	BTK
E-SERIE Pritsche/Fahrgestell (SD1, SL)							
E2000	09/99-09/04	FE (12V)	1998	25x108		SK-1227	BTK
E2200	09/99-07/04	R21N	2184			0-N1216	TB [TE]
MPV I (LV)							
2.5 TD	05/96-09/99	WL-T	2500	30x101		SK-1751	BTK
2.5 TD	05/96-09/99	WL-T	2500			0-N1824	TB [BT]
3.0 i V6	11/89-09/99	JE94, JE94, JE96	2954			0-N085	TB [DG]
3.0 i V6	11/89-09/99	JE94, JE96	2954	→ 12/1997		0-N086	TB [DG]
3.0 i V6	11/89-09/99	JE94, JE94, JE96	2954	01/1998 →		0-N2383	TB [DG]
3.0 i V6	03/95-09/99	JE94	2954			0-N086	TB [DG]
3.0 i V6	11/89-09/99	JE94, JE94, JE96	2954			0-N2159	VB [VD]
MPV II (LW)							
2.0	09/99-07/02	FS, FS-DS	1991	25x135; mit Zubehör		SK-1221	BTK
2.0 DI	07/02-02/06	RF5C	1998	30x153		SK-1674	BTK
2.0 DI	07/02-02/06	RF5C	1998	30x153		SK-1674AQ1	BTKW
2.0	09/99-07/02	FS, FS-DS	1991			0-N077	TB [DG]
2.0	09/99-07/02	FS, FS-DS	1991			0-N078	TB [TE]
2.0 DI	07/02-02/06	RF5C	1998	nur in Verbindung mit: RFY0-12-715		0-N1377	TB [DG]
2.0 DI	07/02-02/06	RF5C	1998			0-N1378	TB [TE]
2.0 DI	07/02-02/06	RF5C	1998			0-N1936	TB [BT]
2.0 DI	07/02-02/06	RF5C	1998			0-N2113	VB [BT] S
2.0 DI	07/02-02/06	RF5C	1998			0-N2244	VB [DG]
2.3	07/02-02/06	L3	2261	Rippenanzahl: 6		0-N1811	VB [BT] S
2.3	07/02-02/06	L3	2261			0-N1859	VB [DG]
MPV III (LY)							
2.3, 2.3 4WD	02/06-	L3-VE	2261	Rippenanzahl: 6		0-N1811	VB [BT] S
MX-3 (EC)							
1.6 i	07/91-10/97	B69	1598	22x145; Nockenwelle: DOHC; 11/1993 →		SK-1224	BTK
1.6 i	07/91-10/97	B69	1598	22x107		SK-1225	BTK

CM³

Art. Nr.



ohne Halter

MX-3 (EC)

1.6 i	01/94-10/97	B6D	1598	22x145; Nockenwelle: DOHC	SK-1224	BTK
1.8 i V6	01/92-10/97	K819, K838	1845	30x192	SK-1457	BTK
1.6 i	07/91-10/97	B69	1598		0-N983	TB [TE]
1.6 i	01/94-10/97	B6D	1598		0-N069	TB [TE]
1.6 i	01/94-10/97	B6D	1598		0-N070	TB [DG]
1.8 i V6	01/92-10/97	K819, K838	1845	mit Anbaumaterial	0-N079	TB [TE]
1.8 i V6	01/92-10/97	K819, K838	1845		0-N080	TB [DG]
1.8 i V6	01/92-10/97	K819, K838	1845		0-N081	TB [DG]
1.8 i V6	01/92-10/97	K819, K838, K8-ZE	1845		0-N2160	TB [BT]
1.8 i V6	01/92-10/97	K819, K838	1845		0-N2024	VB [TE]

MX-5 I (NA)

1.6	05/90-04/98	8AN1, B64F	1598	22x145	SK-1224	BTK
1.8	09/93-12/97	BPF1	1839	22x145	SK-1224	BTK
1.8	02/94-04/98	BP (DOHC), BPF1	1840	22x145	SK-1224	BTK
1.6	05/90-01/94	B64F	1598		0-N069	TB [TE]
1.6	05/90-01/94	B64F	1598		0-N070	TB [DG]
1.6	01/95-04/98	8AN1	1598		0-N983	TB [TE]
1.8	09/93-12/97	BPF1	1839		0-N069	TB [TE]
1.8	09/93-12/97	BPF1	1839		0-N070	TB [DG]
1.8	02/94-04/98	BP (DOHC), BPF1	1840		0-N069	TB [TE]
1.8	02/94-04/98	BP (DOHC), BPF1	1840		0-N070	TB [DG]

MX-5 II (NB)

1.6 16V	05/98-10/05	B6D	1598	22x145	SK-1224	BTK
1.8	01/98-10/05	BP6J, BPD	1839	22x145	SK-1224	BTK
1.8 16V	05/98-10/05	BPD, BPD, BP-ZE, BP-ZE	1840	22x145	SK-1224	BTK
1.6 16V	05/98-10/05	B6D	1598		0-N069	TB [TE]
1.6 16V	05/98-10/05	B6D	1598		0-N070	TB [DG]
1.8	01/98-10/05	BP6J, BPD	1839		0-N069	TB [TE]
1.8	01/98-10/05	BP6J, BPD	1839		0-N070	TB [DG]
1.8 16V, 1.8 i Turbo	05/98-10/05	BP Turbo, BPD, BPD, BP-ZE, BP-ZE	1840		0-N069	TB [TE]
1.8 16V, 1.8 i Turbo	05/98-10/05	BP Turbo, BPD, BPD, BP-ZE, BP-ZE	1840		0-N070	TB [DG]

MX-5 III (NC)

1.8	03/05-	L828, L8-DE	1798	→ 10/2008; Rippenanzahl: 6	0-N1811	VB [BT] S
1.8	03/05-	L828, L8-DE	1798	10/2008 →; Rippenanzahl: 6;	0-N1811	VB [BT] S
1.8	03/05-	L828, L8-DE	1798		0-N1859	VB [DG]
2.0	09/08-	LF62, LF-DE	1999	→ 10/2008; Rippenanzahl: 6	0-N1811	VB [BT] S
2.0	09/08-	LF62, LF-DE	1999	10/2008 →; Rippenanzahl: 6;	0-N1811	VB [BT] S
2.0	09/08-	LF62, LF-DE	1999		0-N1859	VB [DG]

MX-6 (GE)

2.0	02/92-02/97	FS	1991	25x135; 02/1993 →; mit Zubehör	SK-1221	BTK
2.5 24V	02/92-02/97	KL	2497	30x192; 02/1993 →	SK-1457	BTK
2.5 24V	02/93-11/95	KL	2497	30x192	SK-1457	BTK
2.5 i 24V	08/94-02/97	KL	2497	30x192; 12/1995 →	SK-1457	BTK
2.0	02/92-02/97	FS	1991		0-N077	TB [DG]
2.0	02/92-02/97	FS	1991		0-N078	TB [TE]
2.5 24V, 2.5 i 24V	02/92-02/97	KL	2497	mit Anbaumaterial	0-N079	TB [TE]
2.5 24V, 2.5 i 24V	02/92-02/97	KL	2497		0-N080	TB [DG]
2.5 24V, 2.5 i 24V	02/92-02/97	KL	2497		0-N081	TB [DG]
2.5 24V, 2.5 i 24V	02/92-02/97	KL	2497		0-N2160	TB [BT]
2.5 24V, 2.5 i 24V	02/92-02/97	KL	2497		0-N2024	VB [TE]
2.5 24V, 2.5 i 24V	02/92-02/97	KL	2497		0-N2041	VB [DG]

PREMACY (CP)

1.8, 1.9	07/99-03/05	FP	1840	25x133	SK-1222	BTK
2.0	11/01-03/05	FS7E, FS7G	1991	25x135; mit Zubehör	SK-1221	BTK
2.0 TD	10/99-03/05	RF3F, RF4F	1998	27x153	SK-1671	BTK
2.0 TD	10/99-03/05	RF3F, RF4F	1998	27x153	SK-1671AQ1	BTKW
1.8, 1.9	07/99-03/05	FP	1840		0-N076	TB [TE]
1.8, 1.9	07/99-03/05	FP	1840		0-N077	TB [DG]
2.0	11/01-03/05	FS7E, FS7G	1991		0-N077	TB [DG]
2.0	11/01-03/05	FS7E, FS7G	1991		0-N078	TB [TE]
2.0	02/05-03/05	LFF7	1999		0-N077	TB [DG]
2.0 TD	10/99-03/05	RF3F, RF4F	1998		0-N077	TB [DG]
2.0 TD	10/99-03/05	RF3F, RF4F	1998		0-N1379	TB [TE]

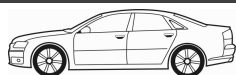

CM³



Art. Nr.



ohne Halter

PREMACY (CP)							
2.0 TD	10/99-03/05	RF3F, RF4F	1998		0-N1578	TB [DG]	
2.0 TD	10/99-03/05	RF3F, RF4F	1998		0-N1936	TB [BT]	
TRIBUTE (EP)							
2.0, 2.0 4WD	03/00-05/08	YF	1989	25.4x129	SK-1748	BTK	
2.0, 2.0 4WD	03/00-05/08	YF	1989		0-N1778	TB [BT]	
2.0, 2.0 4WD	03/00-05/08	YF	1989		0-N291	TB [DG]	
2.0, 2.0 4WD	03/00-05/08	YF	1989	Rippenanzahl: 6	0-N1435	VB [BT]	S
2.0, 2.0 4WD	03/00-05/08	YF	1989	11/2000 →	0-N1686	VB [DG]	
2.0, 2.0 4WD	03/00-05/08	YF	1989		0-N1716	VB [DG]	
XEDOS 6 (CA)							
1.6 16V	08/92-10/99	B6 (DOHC), B69	1598	22x145	SK-1224	BTK	
2.0 V6	01/92-10/99	KF1	1995	30x192	SK-1457	BTK	
1.6 16V	08/92-10/99	B6 (DOHC), B69	1598		0-N069	TB [TE]	
1.6 16V	08/92-10/99	B6 (DOHC), B69	1598		0-N070	TB [DG]	
2.0 V6	01/92-10/99	KF1	1995	mit Anbaumaterial	0-N079	TB [TE]	
2.0 V6	01/92-10/99	KF1	1995		0-N080	TB [DG]	
2.0 V6	01/92-10/99	KF1	1995		0-N081	TB [DG]	
2.0 V6	01/92-10/99	KF1	1995		0-N2160	TB [BT]	
2.0 V6	01/92-10/99	KF1	1995		0-N2024	VB [TE]	
2.0 V6	01/92-10/99	KF1	1995		0-N2041	VB [DG]	
XEDOS 9 (TA)							
2.0 24V	08/93-01/00	KF	1995	30x192	SK-1457	BTK	
2.5 24V, 2.5 V6	07/93-09/02	KL	2497	30x192	SK-1457	BTK	
2.0 24V	08/93-01/00	KF	1995	mit Anbaumaterial	0-N079	TB [TE]	
2.0 24V	08/93-01/00	KF	1995		0-N080	TB [DG]	
2.0 24V	08/93-01/00	KF	1995		0-N081	TB [DG]	
2.0, 2.0 24V	08/93-08/00	KF	1995		0-N2160	TB [BT]	
2.5	09/00-09/02	KL-ZE	2496		0-N2160	TB [BT]	
2.5 24V, 2.5 V6	07/93-09/02	KL	2497	mit Anbaumaterial	0-N079	TB [TE]	
2.5 24V, 2.5 V6	07/93-09/02	KL	2497		0-N080	TB [DG]	
2.5 24V, 2.5 V6	07/93-09/02	KL	2497		0-N081	TB [DG]	
2.5 24V, 2.5 V6	07/93-09/02	KL	2497		0-N2160	TB [BT]	
2.0, 2.0 24V	08/93-08/00	KF	1995		0-N2024	VB [TE]	
2.0, 2.0 24V	08/93-08/00	KF	1995		0-N2041	VB [DG]	
2.5	09/00-09/02	KL-ZE	2496		0-N2024	VB [TE]	
2.5	09/00-09/02	KL-ZE	2496		0-N2041	VB [DG]	
2.5 24V, 2.5 V6	07/93-09/02	KL	2497		0-N2024	VB [TE]	
2.5 24V, 2.5 V6	07/93-09/02	KL	2497		0-N2041	VB [DG]	



OPTIMAL®

MAZDA (CHANGAN)



CM³



Art. Nr.



ohne Halter

2						
1.3	10/07-	ZJ-VR	1348		0-N2035	VB [BT] S
1.5	10/07-	ZY-VE	1498		0-N2035	VB [BT] S
2 Stufenheck						
1.3	06/08-	ZJ, ZJ-VR	1348		0-N2035	VB [BT] S
1.5	06/08-	ZY-VE	1498		0-N2035	VB [BT] S



CM³



Art. Nr.



ohne Halter

6							
2.0	04/03-	LFD	1999	Rippenanzahl: 6; ☼	0-N1811	VB [BT]	S
2.0	04/03-	LFD	1999	Rippenanzahl: 6; ☼	0-N1858	VB [BT]	S
2.0	04/03-	LFD	1999		0-N1859	VB [DG]	
6 Kombi							
2.0	04/03-	LFX	1999	Rippenanzahl: 6; ☼	0-N1811	VB [BT]	S
2.0	04/03-	LFX	1999	Rippenanzahl: 6; ☼	0-N1858	VB [BT]	S
2.0	04/03-	LFX	1999		0-N1859	VB [DG]	
2.3	04/03-	L3X	2261	Rippenanzahl: 6; ☼	0-N1811	VB [BT]	S
2.3	04/03-	L3X	2261	Rippenanzahl: 6; ☼	0-N1858	VB [BT]	S
2.3	04/03-	L3X	2261		0-N1859	VB [DG]	

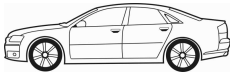

CM³



Art. Nr.



ohne Halter

CLUB

1.4 i	01/92-06/99		1361	17x108; 03/1994 →	SK-1004	BTK	
1.4 i 4x4	01/92-06/99		1361	17x108; 09/1995 →	SK-1004	BTK	
1.5 D, 1.5 D 4x4	01/94-06/99		1527	25.4x136	SK-1040	BTK	
1.5 D, 1.5 D 4x4	01/94-06/99		1527	25.4x136	SK-1040AQ1	BTKW	

CLUB II

1.4 i	06/99-		1361	17x108	SK-1004	BTK	
-------	--------	--	------	--------	----------------	-----	--

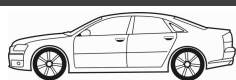

CM³



Art. Nr.



ohne Halter

190 (W201)							
2.0	09/84-05/90	M 102.924	1996	mit Anbaumaterial; ☼	0-N1013	VB [BT]	S
2.0, E 2.0	10/82-08/93	M 102.924, M 102.961, M 102.962, M 102.962	1996	mit Anbaumaterial; für Fahrzeuge mit Servolenkung	0-N1013	VB [BT]	S
2.0, E 2.0	10/82-08/93	M 102.924, M 102.961, M 102.962, M 102.962	1996	☼:021734 →; ☼; ☼	0-N2144	VB [VD]	
2.0, E 2.0	10/82-08/93	M 102.924, M 102.961, M 102.962, M 102.962	1996	☼:054115 →; ☼; ☼	0-N2144	VB [VD]	
2.0, E 2.0	10/82-08/93	M 102.924, M 102.961, M 102.962, M 102.962	1996	☼:000255 →; ☼: →021733; ☼	0-N2145	VB [VD]	
2.0, E 2.0	10/82-08/93	M 102.924, M 102.961, M 102.962, M 102.962	1996	☼:000935 →; ☼: →054114	0-N2145	VB [VD]	
2.0, E 2.0	10/82-08/93	M 102.924, M 102.961, M 102.962, M 102.962	1996		0-N846	VB [TE]	
2.0, E 2.0	10/82-08/93	M 102.924, M 102.961, M 102.962, M 102.962	1996	für Fahrzeuge ohne Servolenkung	0-N847	VB [TE]	
2.3, 2.3 E	10/82-09/88	M 102.985	2299	mit Anbaumaterial; für Fahrzeuge mit Servolenkung	0-N1013	VB [BT]	S
2.3, 2.3 E	10/82-09/88	M 102.985	2299	für Fahrzeuge ohne Servolenkung	0-N847	VB [TE]	
D 2.0	08/83-08/93	OM 601.911	1997		0-N1289	VB [BT]	
D 2.0	08/83-08/93	OM 601.911	1997	hydraulisch	0-N1926	VB [VD]	
D 2.0	08/83-08/93	OM 601.911	1997		0-N846	VB [TE]	
D 2.0	08/83-08/93	OM 601.911	1997		0-N847	VB [TE]	
D 2.5, Turbo-D 2.5	04/85-08/93	OM 602.911, OM 602.961	2497		0-N1289	VB [BT]	
D 2.5, Turbo-D 2.5	04/85-08/93	OM 602.911, OM 602.961	2497	hydraulisch	0-N1926	VB [VD]	
D 2.5, Turbo-D 2.5	04/85-08/93	OM 602.911, OM 602.961	2497		0-N846	VB [TE]	
E 1.8	04/90-08/93	M 102.910	1797	mit Anbaumaterial; für Fahrzeuge mit Servolenkung	0-N1013	VB [BT]	S
E 1.8	04/90-08/93	M 102.910	1797	☼:021734 →; ☼; ☼	0-N2144	VB [VD]	
E 1.8	04/90-08/93	M 102.910	1797	☼:054115 →; ☼; ☼	0-N2144	VB [VD]	
E 1.8	04/90-08/93	M 102.910	1797		0-N846	VB [TE]	
E 2.3	09/86-08/93	M 102.985	2298	mit Anbaumaterial; für Fahrzeuge mit Servolenkung	0-N1013	VB [BT]	S
E 2.3	09/86-08/93	M 102.985	2298	für Fahrzeuge ohne Servolenkung	0-N847	VB [TE]	
E 2.3, E 2.3-16	04/84-08/93	M 102.983, M 102.985	2298		0-N846	VB [TE]	
E 2.3-16	04/84-08/88	M 102.983	2298		0-N1625	VB [BT]	S
E 2.5-16	09/88-08/93	M 102.990	2498		0-N1625	VB [BT]	S
E 2.5-16	09/88-08/93	M 102.990	2498		0-N846	VB [TE]	
E 2.6	09/86-08/93	M 103.942	2597		0-N1011	VB [BT]	S
E 2.6	09/86-08/93	M 103.942	2597		0-N1278	VB [TE]	
E 2.6	09/86-08/93	M 103.942	2597		0-N2146	VB [VD]	
D 2.0	08/83-08/93	OM 601.911	1997		0-N565592	FB [TE]	
D 2.5, Turbo-D 2.5	04/85-08/93	OM 602.911, OM 602.961	2497		0-N565592	FB [TE]	
A-KLASSE (W168)							
A 140	07/97-08/04	M 166.940	1397		0-N1388	VB [TE]	
A 140	07/97-08/04	M 166.940	1397	☼	0-N1395	VB [DG]	
A 140	07/97-08/04	M 166.940	1397	☼	0-N1723	VB [DG]	
A 140	07/97-08/04	M 166.940	1397	☼	0-N1946	VB [BT]	
A 140	07/97-08/04	M 166.940	1397	☼	0-N1946S1	VB [TE]	
A 140	07/97-08/04	M 166.940	1397	☼	0-N1946S2	VB [TE]	
A 140, A 160	07/97-08/04	M 166.960	1598		0-N1388	VB [TE]	
A 140, A 160	07/97-08/04	M 166.960	1598	☼	0-N1395	VB [DG]	
A 140, A 160	07/97-08/04	M 166.960	1598	☼	0-N1723	VB [DG]	
A 140, A 160	07/97-08/04	M 166.960	1598	☼	0-N1946	VB [BT]	
A 140, A 160	07/97-08/04	M 166.960	1598	☼	0-N1946S1	VB [TE]	
A 140, A 160	07/97-08/04	M 166.960	1598	☼	0-N1946S2	VB [TE]	
A 160 CDI, A 170 CDI	07/98-08/04	OM 668.940, OM 668.941, OM 668.942	1689		0-N1388	VB [TE]	
A 160 CDI, A 170 CDI	07/98-08/04	OM 668.940, OM 668.941, OM 668.942	1689		0-N1395	VB [DG]	
A 160 CDI, A 170 CDI	07/98-02/01	OM 668.940, OM 668.941	1689	J568589; ☼	0-N1397	VB [DG]	
A 160 CDI, A 170 CDI	07/98-08/04	OM 668.940, OM 668.941, OM 668.942	1689	☼	0-N1723	VB [DG]	
A 160 CDI, A 170 CDI	07/98-02/01	OM 668.940, OM 668.941	1689	ch.J568590 →; ☼	0-N1744	VB [DG]	
A 160 CDI, A 170 CDI	07/98-02/01	OM 668.940, OM 668.941	1689	ch.J568590 →; ☼	0-N1941	VB [BT]	
A 160 CDI, A 170 CDI	07/98-02/01	OM 668.940, OM 668.941	1689	ch.J568590 →; ☼	0-N1941S1	VB [TE]	
A 160 CDI, A 170 CDI	07/98-02/01	OM 668.940, OM 668.941	1689	ch.J568590 →; ☼	0-N1941S2	VB [TE]	
A 160 CDI, A 170 CDI	07/98-02/01	OM 668.940, OM 668.941	1689	ch.J568590 →; ☼	0-N1941S3	VB [TE]	
A 160 CDI, A 170 CDI	07/98-02/01	OM 668.940, OM 668.941	1689	J568589; nur in Verbindung mit: 0-N1397; ☼	0-N1946	VB [BT]	
A 160 CDI, A 170 CDI	07/98-02/01	OM 668.940, OM 668.941	1689	J568589; ☼	0-N1946S1	VB [TE]	
A 160 CDI, A 170 CDI	07/98-02/01	OM 668.940, OM 668.941	1689	J568589; ☼	0-N1946S2	VB [TE]	
A 160 CDI, A 170 CDI	02/01-08/04	OM 668.940, OM 668.942	1689	→ 04/2003; ☼	0-N1744	VB [DG]	



CM³



Art. Nr.



A-KLASSE (W168)

A 160 CDI , A 170 CDI	02/01-08/04	OM 668.940, OM 668.942	1689	☼	0-N1941	VB [BT]
A 160 CDI , A 170 CDI	02/01-08/04	OM 668.940, OM 668.942	1689	☼	0-N1941S1	VB [TE]
A 160 CDI , A 170 CDI	02/01-08/04	OM 668.940, OM 668.942	1689	☼	0-N1941S2	VB [TE]
A 160 CDI , A 170 CDI	02/01-08/04	OM 668.940, OM 668.942	1689	☼	0-N1941S3	VB [TE]
A 190	03/99-08/04	M 166.990	1898		0-N1388	VB [TE]
A 190	03/99-08/04	M 166.990	1898	☼	0-N1395	VB [DG]
A 190	03/99-08/04	M 166.990	1898	☼	0-N1723	VB [DG]
A 190	03/99-08/04	M 166.990	1898	☼	0-N1946	VB [BT]
A 190	03/99-08/04	M 166.990	1898	☼	0-N1946S1	VB [TE]
A 190	03/99-08/04	M 166.990	1898	☼	0-N1946S2	VB [TE]
A 210	03/02-08/04	M 166.995	2084		0-N1388	VB [TE]
A 210	03/02-08/04	M 166.995	2084	☼	0-N1395	VB [DG]
A 210	03/02-08/04	M 166.995	2084	☼	0-N1723	VB [DG]
A 210	03/02-08/04	M 166.995	2084	☼	0-N1946	VB [BT]
A 210	03/02-08/04	M 166.995	2084	☼	0-N1946S1	VB [TE]
A 210	03/02-08/04	M 166.995	2084	☼	0-N1946S2	VB [TE]

A-KLASSE (W169)

A 150 , A 160	09/04-06/12	M 266.920	1498		0-N1388	VB [TE]
A 150 , A 160	09/04-06/12	M 266.920	1498	☼	0-N1395	VB [DG]
A 150 , A 160	09/04-06/12	M 266.920	1498	☼	0-N1397	VB [DG]
A 150 , A 160	09/04-06/12	M 266.920	1498	☼	0-N1723	VB [DG]
A 150 , A 160	09/04-06/12	M 266.920	1498	☼	0-N2246	VB [BT]
A 150 , A 160	09/04-06/12	M 266.920	1498	☼	0-N2246S1	VB [DG]
A 150 , A 160	09/04-06/12	M 266.920	1498	☼	0-N2246S2	VB [DG]
A 150 , A 160	09/04-06/12	M 266.920	1498	☼	0-N2246S3	VB [DG]
A 150 , A 160	09/04-06/12	M 266.920	1498	☼	0-N2367	VB [DG]
A 150 , A 160	09/04-06/12	M 266.920	1498	☼, für Fahrzeuge mit Start-Stopp-Funktion	0-N2401	VB [BT]
A 150 , A 160	09/04-06/12	M 266.920	1498	☼, für Fahrzeuge mit Start-Stopp-Funktion	0-N2401S1	VB [DG]
A 150 , A 160	09/04-06/12	M 266.920	1498	☼, für Fahrzeuge mit Start-Stopp-Funktion	0-N2401S2	VB [DG]
A 160 CDI , A 180 CDI , A 200 CDI	09/04-06/12	OM 640.940, OM 640.941, OM 640.942	1991		0-N1388	VB [TE]
A 160 CDI , A 180 CDI , A 200 CDI	09/04-06/12	OM 640.940, OM 640.941, OM 640.942	1991	☼	0-N1395	VB [DG]
A 160 CDI , A 180 CDI , A 200 CDI	09/04-06/12	OM 640.940, OM 640.941, OM 640.942	1991	☼	0-N1397	VB [DG]
A 160 CDI , A 180 CDI , A 200 CDI	09/04-06/12	OM 640.940, OM 640.941, OM 640.942	1991	☼	0-N1723	VB [DG]
A 160 CDI , A 180 CDI , A 200 CDI	09/04-06/12	OM 640.940, OM 640.941, OM 640.942	1991	☼	0-N2245	VB [BT]
A 160 CDI , A 180 CDI , A 200 CDI	09/04-06/12	OM 640.940, OM 640.941, OM 640.942	1991	☼	0-N2245S1	VB [DG]
A 160 CDI , A 180 CDI , A 200 CDI	09/04-06/12	OM 640.940, OM 640.941, OM 640.942	1991	☼	0-N2245S2	VB [DG]
A 160 CDI , A 180 CDI , A 200 CDI	09/04-06/12	OM 640.940, OM 640.941, OM 640.942	1991	☼	0-N2245S3	VB [DG]
A 170 , A 180	09/04-06/12	M 266.940	1699		0-N1388	VB [TE]
A 170 , A 180	09/04-06/12	M 266.940	1699	☼	0-N1395	VB [DG]
A 170 , A 180	09/04-06/12	M 266.940	1699	☼	0-N1397	VB [DG]
A 170 , A 180	09/04-06/12	M 266.940	1699	☼	0-N1723	VB [DG]
A 170 , A 180	09/04-06/12	M 266.940	1699	☼	0-N2246	VB [BT]
A 170 , A 180	09/04-06/12	M 266.940	1699	☼	0-N2246S1	VB [DG]
A 170 , A 180	09/04-06/12	M 266.940	1699	☼	0-N2246S2	VB [DG]
A 170 , A 180	09/04-06/12	M 266.940	1699	☼	0-N2246S3	VB [DG]
A 170 , A 180	09/04-06/12	M 266.940	1699	☼	0-N2367	VB [DG]
A 170 , A 180	09/04-06/12	M 266.940	1699	☼, für Fahrzeuge mit Start-Stopp-Funktion	0-N2401	VB [BT]
A 170 , A 180	09/04-06/12	M 266.940	1699	☼, für Fahrzeuge mit Start-Stopp-Funktion	0-N2401S1	VB [DG]
A 170 , A 180	09/04-06/12	M 266.940	1699	☼, für Fahrzeuge mit Start-Stopp-Funktion	0-N2401S2	VB [DG]
A 200 , A 200 TURBO	09/04-06/12	M 266.960, M 266.980	2034		0-N1388	VB [TE]
A 200 , A 200 TURBO	09/04-06/12	M 266.960, M 266.980	2034	☼	0-N1395	VB [DG]
A 200 , A 200 TURBO	09/04-06/12	M 266.960, M 266.980	2034	☼	0-N1397	VB [DG]
A 200 , A 200 TURBO	09/04-06/12	M 266.960, M 266.980	2034	☼	0-N1723	VB [DG]
A 200 , A 200 TURBO	09/04-06/12	M 266.960, M 266.980	2034	☼	0-N2246	VB [BT]
A 200 , A 200 TURBO	09/04-06/12	M 266.960, M 266.980	2034	☼	0-N2246S1	VB [DG]
A 200 , A 200 TURBO	09/04-06/12	M 266.960, M 266.980	2034	☼	0-N2246S2	VB [DG]
A 200 , A 200 TURBO	09/04-06/12	M 266.960, M 266.980	2034	☼	0-N2246S3	VB [DG]
A 200 , A 200 TURBO	09/04-06/12	M 266.960, M 266.980	2034	☼	0-N2367	VB [DG]

A-KLASSE (W176)

A 160 CDI, A 180 CDI	06/12-	OM 607.951	1461	27x119	SK-1730	BTK
A 160 CDI, A 180 CDI	06/12-	OM 607.951	1461	27x119	SK-1730AQ1	BTKW
A 160 CDI, A 180 CDI	06/12-	OM 607.951	1461		0-N2423	TB [TE]
A 160 CDI, A 180 CDI	06/12-	OM 607.951	1461		0-N2290	VB [BT]
A 180 , A 200	06/12-	M 270.910	1595		0-N2310	VB [DG]

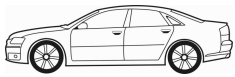

CM³



Art. Nr.



A-KLASSE (W176)							
A 180 CDI	06/12-	OM 607.951	1461	✳		0-N2253	VB [DG]
A 250 , A 250 4-matic	06/12-	M 270.920	1991			0-N2310	VB [DG]
B-KLASSE (W245)							
B 150 , B 160	03/05-11/11	M 266.920	1498			0-N1388	VB [TE]
B 150 , B 160	03/05-11/11	M 266.920	1498	✳		0-N1395	VB [DG]
B 150 , B 160	03/05-11/11	M 266.920	1498	✳		0-N1397	VB [DG]
B 150 , B 160	03/05-11/11	M 266.920	1498	✳		0-N1723	VB [DG]
B 150 , B 160	03/05-11/11	M 266.920	1498	✳		0-N2246	VB [BT]
B 150 , B 160	03/05-11/11	M 266.920	1498	✳		0-N2246S1	VB [DG]
B 150 , B 160	03/05-11/11	M 266.920	1498	✳		0-N2246S2	VB [DG]
B 150 , B 160	03/05-11/11	M 266.920	1498	✳		0-N2246S3	VB [DG]
B 150 , B 160	03/05-11/11	M 266.920	1498	✳		0-N2367	VB [DG]
B 150 , B 160	03/05-11/11	M 266.920	1498	✳	für Fahrzeuge mit Start-Stopp-Funktion	0-N2401	VB [BT]
B 150 , B 160	03/05-11/11	M 266.920	1498	✳	für Fahrzeuge mit Start-Stopp-Funktion	0-N2401S1	VB [DG]
B 150 , B 160	03/05-11/11	M 266.920	1498	✳	für Fahrzeuge mit Start-Stopp-Funktion	0-N2401S2	VB [DG]
B 170 , B 180	03/05-11/11	M 266.940	1699			0-N1388	VB [TE]
B 170 , B 180	03/05-11/11	M 266.940	1699	✳		0-N1395	VB [DG]
B 170 , B 180	03/05-11/11	M 266.940	1699	✳		0-N1397	VB [DG]
B 170 , B 180	03/05-11/11	M 266.940	1699	✳		0-N1723	VB [DG]
B 170 , B 180	03/05-11/11	M 266.940	1699	✳		0-N2246	VB [BT]
B 170 , B 180	03/05-11/11	M 266.940	1699	✳		0-N2246S1	VB [DG]
B 170 , B 180	03/05-11/11	M 266.940	1699	✳		0-N2246S2	VB [DG]
B 170 , B 180	03/05-11/11	M 266.940	1699	✳		0-N2246S3	VB [DG]
B 170 , B 180	03/05-11/11	M 266.940	1699	✳		0-N2367	VB [DG]
B 170 , B 180	03/05-11/11	M 266.940	1699	✳	für Fahrzeuge mit Start-Stopp-Funktion	0-N2401	VB [BT]
B 170 , B 180	03/05-11/11	M 266.940	1699	✳	für Fahrzeuge mit Start-Stopp-Funktion	0-N2401S1	VB [DG]
B 170 , B 180	03/05-11/11	M 266.940	1699	✳	für Fahrzeuge mit Start-Stopp-Funktion	0-N2401S2	VB [DG]
B 170 NGT , B 180 NGT , B 200 , B 200 TURBO	03/05-11/11	M 266.960, M 266.980	2034			0-N1388	VB [TE]
B 170 NGT , B 180 NGT , B 200 , B 200 TURBO	03/05-11/11	M 266.960, M 266.980	2034	✳		0-N1395	VB [DG]
B 170 NGT , B 180 NGT , B 200 , B 200 TURBO	03/05-11/11	M 266.960, M 266.980	2034	✳		0-N1397	VB [DG]
B 170 NGT , B 180 NGT , B 200 , B 200 TURBO	03/05-11/11	M 266.960, M 266.980	2034	✳		0-N1723	VB [DG]
B 170 NGT , B 180 NGT , B 200 , B 200 TURBO	03/05-11/11	M 266.960, M 266.980	2034	✳		0-N2246	VB [BT]
B 170 NGT , B 180 NGT , B 200 , B 200 TURBO	03/05-11/11	M 266.960, M 266.980	2034	✳		0-N2246S1	VB [DG]
B 170 NGT , B 180 NGT , B 200 , B 200 TURBO	03/05-11/11	M 266.960, M 266.980	2034	✳		0-N2246S2	VB [DG]
B 170 NGT , B 180 NGT , B 200 , B 200 TURBO	03/05-11/11	M 266.960, M 266.980	2034	✳		0-N2246S3	VB [DG]
B 170 NGT , B 180 NGT , B 200 , B 200 TURBO	03/05-11/11	M 266.960, M 266.980	2034	✳		0-N2367	VB [DG]
B 180 CDI , B 200 CDI	03/05-11/11	OM 640.940, OM 640.941	1991			0-N1388	VB [TE]
B 180 CDI , B 200 CDI	03/05-11/11	OM 640.940, OM 640.941	1991			0-N1395	VB [DG]
B 180 CDI , B 200 CDI	03/05-11/11	OM 640.940, OM 640.941	1991	✳		0-N1397	VB [DG]
B 180 CDI , B 200 CDI	03/05-11/11	OM 640.940, OM 640.941	1991	✳		0-N1723	VB [DG]
B 180 CDI , B 200 CDI	03/05-11/11	OM 640.940, OM 640.941	1991	✳		0-N2245	VB [BT]
B 180 CDI , B 200 CDI	03/05-11/11	OM 640.940, OM 640.941	1991	✳		0-N2245S1	VB [DG]
B 180 CDI , B 200 CDI	03/05-11/11	OM 640.940, OM 640.941	1991	✳		0-N2245S2	VB [DG]
B 180 CDI , B 200 CDI	03/05-11/11	OM 640.940, OM 640.941	1991	✳		0-N2245S3	VB [DG]
B-KLASSE (W246, W242)							
B 160 CDI, B 180 CDI	02/13-	OM 607.951	1461		27x119	SK-1730	BTK
B 160 CDI, B 180 CDI	02/13-	OM 607.951	1461		27x119	SK-1730AQ1	BTKW
B 160 CDI, B 180 CDI	02/13-	OM 607.951	1461			0-N2423	TB [TE]
B 160 CDI, B 180 CDI	02/13-	OM 607.951	1461			0-N2290	VB [BT]
B 180 , B 200	11/11-	M 270.910	1595			0-N2310	VB [DG]
B 180 CDI	02/13-	OM 607.951	1461	✳		0-N2253	VB [DG]
B 200 Natural Gas Drive, B 220 4-matic, B 250	05/12-	M 270.920	1991			0-N2310	VB [DG]
CABRIOLET (A124)							
300 CE-24	04/92-06/93	M 104.980	2960			0-N1011	VB [BT]
300 CE-24	04/92-06/93	M 104.980	2960			0-N1278	VB [TE]
300 CE-24	04/92-06/93	M 104.980	2960			0-N2146	VB [VD]
300 CE-24	04/92-06/93	M 104.980	2960		→21004	0-N847	VB [TE]



OPTIMAL®

MERCEDES-BENZ



CM³



Art. Nr.



ohne Halter

CABRIOLET (A124)

300 CE-24	04/92-06/93	M 104.980	2960	:→4956	0-N847	VB [TE]	
-----------	-------------	-----------	------	--------	---------------	---------	--

C-KLASSE (W202)

C 180	03/93-05/00	M 111.920, M 111.921, M 111.921	1799		0-N1703	VB [BT]	
C 180	03/93-05/00	M 111.920, M 111.921, M 111.921	1799		0-N1833	VB [TE]	
C 180	03/93-05/00	M 111.920, M 111.921	1799	06/1993 →	0-N1951	VB [VD]	
C 180	03/93-05/00	M 111.920, M 111.921, M 111.921	1799		0-N2418	VB [BT]	
C 180	11/94-05/00	M 111.921	1799		0-N1951	VB [VD]	
C 200 , C 200 Kompressor	01/94-05/00	M 111.941, M 111.945, M 111.944	1998		0-N1703	VB [BT]	
C 200 , C 200 Kompressor	01/94-05/00	M 111.941, M 111.945, M 111.944	1998		0-N1833	VB [TE]	
C 200 , C 200 Kompressor	01/94-05/00	M 111.941, M 111.945, M 111.944	1998		0-N1951	VB [VD]	
C 200 , C 200 Kompressor	01/94-05/00	M 111.941, M 111.945, M 111.944	1998		0-N2418	VB [BT]	
C 200 CDI , C 220 CDI	09/97-05/00	OM 611.960	2151	Rippenanzahl: 6	0-N1431	VB [DG]	
C 200 CDI , C 220 CDI	09/97-05/00	OM 611.960	2151		0-N1641	VB [BT]	S
C 200 D	03/93-05/00	OM 601.913	1997	:000483, 008286→	0-N1043	VB [BT]	
C 200 D	03/93-05/00	OM 601.913	1997		0-N1289	VB [BT]	
C 200 D	03/93-05/00	OM 601.913	1997	:→000482, 008285; hydraulisch	0-N1926	VB [VD]	
C 200 D	03/93-05/00	OM 601.913	1997	:000483, 008286→	0-N2147	VB [VD]	
C 200 D	03/93-05/00	OM 601.913, OM 604.915	1997		0-N846	VB [TE]	
C 200 D	03/93-05/00	OM 601.913	1997	für Fahrzeuge ohne Servolenkung	0-N847	VB [TE]	
C 200 D	10/96-05/00	OM 604.915	1997		0-N1043	VB [BT]	
C 200 D	10/96-05/00	OM 604.915	1997		0-N2147	VB [VD]	
C 200 Kompressor	10/95-05/00	M 111.944	1998		0-N1283	VB [TE]	
C 200 Kompressor	10/95-05/00	M 111.944	1998		0-N1442	VB [DG]	
C 200 Kompressor	10/95-05/00	M 111.944	1998		0-N2141	VB [TE]	
C 200 Kompressor	10/95-05/00	M 111.944	1998		0-N2148	VB [BT]	
C 220	03/93-05/00	M 111.961	2199	01/1995 → 12/1997	0-N1641	VB [BT]	S
C 220	03/93-05/00	M 111.961	2199		0-N1703	VB [BT]	
C 220	03/93-05/00	M 111.961	2199		0-N1833	VB [TE]	
C 220	03/93-05/00	M 111.961	2199	06/1993 →	0-N1951	VB [VD]	
C 220	03/93-05/00	M 111.961	2199		0-N2418	VB [BT]	
C 220 D	08/93-05/00	OM 604.910	2155		0-N1043	VB [BT]	
C 220 D	08/93-05/00	OM 604.910	2155		0-N2147	VB [VD]	
C 220 D	08/93-05/00	OM 604.910	2155		0-N846	VB [TE]	
C 230 , C 230 Kompressor	10/95-05/00	M 111.974, M 111.975	2295		0-N1703	VB [BT]	
C 230 , C 230 Kompressor	10/95-05/00	M 111.974, M 111.975	2295		0-N1833	VB [TE]	
C 230 , C 230 Kompressor	10/95-05/00	M 111.974, M 111.975	2295		0-N1951	VB [VD]	
C 230 , C 230 Kompressor	10/95-05/00	M 111.974, M 111.975	2295		0-N2418	VB [BT]	
C 230 Kompressor	10/95-05/00	M 111.975	2295		0-N1442	VB [DG]	
C 230 Kompressor	10/95-05/00	M 111.975	2295		0-N2141	VB [TE]	
C 230 Kompressor	10/95-05/00	M 111.975	2295		0-N2148	VB [BT]	
C 240	06/97-05/00	M 112.910	2398	Rippenanzahl: 6	0-N1431	VB [DG]	
C 240	06/97-05/00	M 112.910	2398		0-N1645	VB [BT]	S
C 240	06/97-05/00	M 112.910	2398		0-N2142	VB [VD]	
C 250 D , C 250 Turbo-D	05/93-05/00	OM 605.910, OM 605.960	2497		0-N1043	VB [BT]	
C 250 D , C 250 Turbo-D	05/93-05/00	OM 605.910, OM 605.960	2497		0-N2147	VB [VD]	
C 250 D , C 250 Turbo-D	05/93-05/00	OM 605.910, OM 605.960	2497		0-N846	VB [TE]	
C 280	05/93-05/00	M 104.941	2799	:→004058, 034966	0-N1011	VB [BT]	S
C 280	05/93-05/00	M 104.941	2799	:→004058, 034966	0-N1278	VB [TE]	
C 280	05/93-05/00	M 104.941	2799	:004059, 034967→	0-N1282	VB [TE]	
C 280	05/93-05/00	M 104.941	2799		0-N1283	VB [TE]	
C 280	05/93-05/00	M 104.941	2799	Rippenanzahl: 6	0-N1288	VB [DG]	
C 280	05/93-05/00	M 104.941	2799	:004059, 034967→; :→006600, 075764	0-N2141	VB [TE]	
C 280	05/93-05/00	M 104.941	2799	:→004058, 034966	0-N2146	VB [VD]	
C 280	06/97-05/00	M 112.920	2799	Rippenanzahl: 6	0-N1431	VB [DG]	
C 280	06/97-05/00	M 112.920	2799		0-N1645	VB [BT]	S
C 280	06/97-05/00	M 112.920	2799		0-N2142	VB [VD]	
C 36 AMG	05/94-05/00	M 104.941 (AMG 3.6)	3606	:→004058, 034966	0-N1011	VB [BT]	S
C 36 AMG	05/94-05/00	M 104.941 (AMG 3.6)	3606	:→004058, 034966	0-N1278	VB [TE]	
C 36 AMG	05/94-05/00	M 104.941 (AMG 3.6)	3606	:004059, 034967→	0-N1282	VB [TE]	
C 36 AMG	05/94-05/00	M 104.941 (AMG 3.6)	3606		0-N1283	VB [TE]	
C 36 AMG	05/94-05/00	M 104.941 (AMG 3.6)	3606	Rippenanzahl: 6	0-N1288	VB [DG]	
C 36 AMG	05/94-05/00	M 104.941 (AMG 3.6)	3606	:004059, 034967→; :→006600, 075764	0-N2141	VB [TE]	
C 36 AMG	05/94-05/00	M 104.941 (AMG 3.6)	3606	:→004058, 034966	0-N2146	VB [VD]	

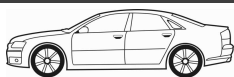

CM³



Art. Nr.



C-KLASSE (W202)							
C 43 AMG	08/97-05/00	M 113.944	4266	Rippenanzahl: 6		0-N1431	VB [DG]
C 43 AMG	08/97-05/00	M 113.944	4266			0-N1645	VB [BT] S
C 200 D	03/93-05/00	OM 601.913	1997	: →000482, 008285		0-N565592	FB [TE]
C-KLASSE Kombi (S202)							
C 180 T	06/96-09/00	M 111.920, M 111.921	1799			0-N1703	VB [BT]
C 180 T	06/96-09/00	M 111.920, M 111.921	1799			0-N1833	VB [TE]
C 180 T	06/96-09/00	M 111.920, M 111.921	1799			0-N1951	VB [VD]
C 180 T	06/96-09/00	M 111.920, M 111.921	1799			0-N2418	VB [BT]
C 180 T, C 200 T, C 200 T Kompressor	06/96-03/01	M 111.941, M 111.945, M 111.944, M 111.952, M 111.956	1998			0-N1703	VB [BT]
C 180 T, C 200 T, C 200 T Kompressor	06/96-03/01	M 111.941, M 111.945, M 111.944, M 111.952, M 111.956	1998			0-N1833	VB [TE]
C 180 T, C 200 T, C 200 T Kompressor	06/96-03/01	M 111.941, M 111.945, M 111.944, M 111.952, M 111.956	1998			0-N2418	VB [BT]
C 180 T, C 200 T Kompressor	11/96-03/01	M 111.944, M 111.952, M 111.956	1998			0-N1951	VB [VD]
C 200 T	06/96-03/01	M 111.941, M 111.945	1998	→ 10/2000		0-N1951	VB [VD]
C 200 T CDI, C 220 T CDI	09/97-03/01	OM 611.960	2151	Rippenanzahl: 6		0-N1431	VB [DG]
C 200 T CDI, C 220 T CDI	09/97-03/01	OM 611.960	2151			0-N1641	VB [BT] S
C 200 T D	10/96-03/01	OM 604.915	1997			0-N1043	VB [BT]
C 200 T D	10/96-03/01	OM 604.915	1997			0-N2147	VB [VD]
C 200 T D	10/96-03/01	OM 604.915	1997			0-N846	VB [TE]
C 200 T Kompressor	11/96-03/01	M 111.944, M 111.956	1998			0-N1283	VB [TE]
C 200 T Kompressor	11/96-03/01	M 111.944, M 111.956	1998			0-N1442	VB [DG]
C 200 T Kompressor	11/96-03/01	M 111.944	1998			0-N2141	VB [TE]
C 200 T Kompressor	11/96-03/01	M 111.944, M 111.956	1998			0-N2148	VB [BT]
C 220 T D	06/96-03/01	OM 604.910	2155			0-N1043	VB [BT]
C 220 T D	06/96-03/01	OM 604.910	2155			0-N2147	VB [VD]
C 220 T D	06/96-03/01	OM 604.910	2155			0-N846	VB [TE]
C 230 T	06/96-06/98	M 111.974	2295			0-N1951	VB [VD]
C 230 T, C 230 T Kompressor	06/96-09/00	M 111.974, M 111.975	2295			0-N1703	VB [BT]
C 230 T, C 230 T Kompressor	06/96-09/00	M 111.974, M 111.975	2295			0-N1833	VB [TE]
C 230 T, C 230 T Kompressor	06/96-09/00	M 111.974, M 111.975	2295			0-N2418	VB [BT]
C 230 T Kompressor	06/97-09/00	M 111.975	2295			0-N1442	VB [DG]
C 230 T Kompressor	06/97-09/00	M 111.975	2295	→ 10/1999		0-N1951	VB [VD]
C 230 T Kompressor	06/97-09/00	M 111.975	2295			0-N2141	VB [TE]
C 230 T Kompressor	06/97-09/00	M 111.975	2295			0-N2148	VB [BT]
C 240 T	06/97-09/00	M 112.910	2398	Rippenanzahl: 6		0-N1431	VB [DG]
C 240 T	06/97-09/00	M 112.910	2398			0-N1645	VB [BT] S
C 240 T	06/97-09/00	M 112.910	2398			0-N2142	VB [VD]
C 240 T	09/00-03/01	M 112.915	2597	Rippenanzahl: 6		0-N1431	VB [DG]
C 240 T	09/00-03/01	M 112.915	2597			0-N1645	VB [BT] S
C 240 T	09/00-03/01	M 112.915	2597			0-N2142	VB [VD]
C 250 T Turbo-D	06/96-03/01	OM 605.960	2497			0-N1043	VB [BT]
C 250 T Turbo-D	06/96-03/01	OM 605.960	2497			0-N2147	VB [VD]
C 250 T Turbo-D	06/96-03/01	OM 605.960	2497			0-N846	VB [TE]
C 280 T	06/97-03/01	M 112.920	2799	Rippenanzahl: 6		0-N1431	VB [DG]
C 280 T	06/97-03/01	M 112.920	2799			0-N1645	VB [BT] S
C 280 T	06/97-03/01	M 112.920	2799			0-N2142	VB [VD]
C 43 AMG	08/97-03/01	M 113.944	4266	Rippenanzahl: 6		0-N1431	VB [DG]
C 43 AMG	08/97-03/01	M 113.944	4266			0-N1645	VB [BT] S
C-KLASSE (W203)							
C 180, C 200 Kompressor	05/00-06/02	M 111.951, M 111.955	1998			0-N1703	VB [BT]
C 180, C 200 Kompressor	05/00-06/02	M 111.951, M 111.955	1998			0-N1833	VB [TE]
C 180, C 200 Kompressor	05/00-06/02	M 111.951, M 111.955	1998			0-N1951	VB [VD]
C 180, C 200 Kompressor	05/00-06/02	M 111.951, M 111.955	1998			0-N2418	VB [BT]
C 180 Kompressor, C 200 CGI Kompressor, C 200 Kompressor, C 230 Kompressor	05/02-02/07	M 271.940, M 271.942, M 271.946, M 271.948	1796			0-N1457	VB [DG]
C 180 Kompressor, C 200 CGI Kompressor, C 200 Kompressor, C 230 Kompressor	05/02-02/07	M 271.940, M 271.942, M 271.946, M 271.948	1796			0-N1587	VB [BT] S
C 180 Kompressor, C 200 CGI Kompressor, C 200 Kompressor, C 230 Kompressor	05/02-02/07	M 271.940, M 271.942, M 271.946, M 271.948	1796			0-N2206	VB [DG]
C 200 CDI	02/01-02/07	OM 646.962	2148	→ 06/2003;		0-N1489S	VB [TE]
C 200 CDI	02/01-02/07	OM 646.962	2148	06/2003 →		0-N1641	VB [BT] S
C 200 CDI, C 220 CDI	05/00-02/07	OM 611.962	2148	Rippenanzahl: 6		0-N1431	VB [DG]

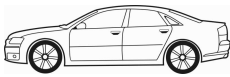

CM³



Art. Nr.



C-KLASSE (W203)

C 200 CDI , C 220 CDI	05/00-02/07	OM 611.962, OM 646.963	2148			0-N1641	VB [BT]	S
C 200 Kompressor	05/00-06/02	M 111.955	1998			0-N1283	VB [TE]	
C 200 Kompressor	05/00-06/02	M 111.955	1998			0-N1442	VB [DG]	
C 200 Kompressor	05/00-06/02	M 111.955	1998			0-N2148	VB [BT]	
C 230	01/05-02/07	M 272.920	2496	Rippenanzahl: 6		0-N1637	VB [DG]	
C 230	01/05-02/07	M 272.920	2496			0-N1670	VB [BT]	S
C 230	01/05-02/07	M 272.920	2496			0-N1746	VB [DG]	
C 230	01/05-02/07	M 272.920	2496			0-N2138	VB [DG]	
C 230	01/05-02/07	M 272.920	2496			0-N2143	VB [VD]	
C 240	05/00-02/07	M 112.912	2597			0-N2142	VB [VD]	
C 240 , C 240 4-matic	05/00-02/07	M 112.912, M 112.916	2597	Rippenanzahl: 6		0-N1431	VB [DG]	
C 240 , C 240 4-matic	05/00-02/07	M 112.912, M 112.916	2597			0-N1645	VB [BT]	S
C 270 CDI	12/00-02/07	OM 612.962	2685	Rippenanzahl: 6		0-N1431	VB [DG]	
C 270 CDI	12/00-02/07	OM 612.962	2685			0-N1641	VB [BT]	S
C 280 , C 280 4-matic	01/05-02/07	M 272.940, M 272.941	2996	Rippenanzahl: 6		0-N1637	VB [DG]	
C 280 , C 280 4-matic	01/05-02/07	M 272.940, M 272.941	2996			0-N1670	VB [BT]	S
C 280 , C 280 4-matic	01/05-02/07	M 272.940, M 272.941	2996		→:30058376	0-N1746	VB [DG]	
C 280 , C 280 4-matic	01/05-02/07	M 272.940, M 272.941	2996			0-N2138	VB [DG]	
C 280 , C 280 4-matic	01/05-02/07	M 272.940, M 272.941	2996			0-N2143	VB [VD]	
C 30 CDI AMG	01/03-02/07	OM 612.990	2950			0-N1641	VB [BT]	S
C 320	05/00-02/07	M 112.946	3199	Rippenanzahl: 6		0-N1431	VB [DG]	
C 320 , C 320 4-matic	05/00-02/07	M 112.946, M 112.953	3199			0-N1645	VB [BT]	S
C 320 CDI	01/05-02/07	OM 642.910	2987			0-N1560	VB [DG]	
C 320 CDI	01/05-02/07	OM 642.910	2987			0-N1902	VB [BT]	S
C 350 , C 350 4-matic	01/05-02/07	M 272.960, M 272.960, M 272.970	3498	Rippenanzahl: 6		0-N1637	VB [DG]	
C 350 , C 350 4-matic	01/05-02/07	M 272.960, M 272.960, M 272.970	3498			0-N1670	VB [BT]	S
C 350 , C 350 4-matic	01/05-02/07	M 272.960, M 272.960, M 272.970	3498		→:30058376	0-N1746	VB [DG]	
C 350 , C 350 4-matic	01/05-02/07	M 272.960, M 272.960, M 272.970	3498		02/2005 →; →:30058377 →	0-N2138	VB [DG]	
C 350 , C 350 4-matic	01/05-02/07	M 272.960, M 272.960, M 272.970	3498			0-N2143	VB [VD]	
C 55 AMG	02/04-02/07	M 113.988	5439	Rippenanzahl: 6		0-N1431	VB [DG]	
C 55 AMG	02/04-02/07	M 113.988	5439			0-N1645	VB [BT]	S

C-KLASSE Sportcoupe (CL203)

C 160 Kompressor , C 180 Kompressor , C 200 CGI Kompressor , C 200 Kompressor , C 220 , C 230 Kompressor	05/02-05/08	M 271.921, M 271.940, M 271.942, M 271.946, M 271.948	1796			0-N2206	VB [DG]	
C 160 Kompressor , C 180 Kompressor , C 200 CGI Kompressor , C 200 Kompressor , C 230 Kompressor	05/02-05/08	M 271.921, M 271.940, M 271.942, M 271.946, M 271.948	1796			0-N1457	VB [DG]	
C 160 Kompressor , C 180 Kompressor , C 200 CGI Kompressor , C 200 Kompressor , C 230 Kompressor	05/02-05/08	M 271.921, M 271.940, M 271.942, M 271.946, M 271.948	1796			0-N1587	VB [BT]	S
C 180 , C 200 Kompressor	03/01-05/02	M 111.951, M 111.955	1998			0-N1703	VB [BT]	
C 180 , C 200 Kompressor	03/01-05/02	M 111.951, M 111.955	1998			0-N1833	VB [TE]	
C 180 , C 200 Kompressor	03/01-05/02	M 111.951, M 111.955	1998			0-N1951	VB [VD]	
C 180 , C 200 Kompressor	03/01-05/02	M 111.951, M 111.955	1998			0-N2418	VB [BT]	
C 200 CDI , C 220 CDI	03/01-05/08	OM 611.962, OM 646.962, OM 646.963	2148			0-N1641	VB [BT]	S
C 200 Kompressor	03/01-05/02	M 111.955	1998			0-N1283	VB [TE]	
C 200 Kompressor	03/01-05/02	M 111.955	1998			0-N1442	VB [DG]	
C 200 Kompressor	03/01-05/02	M 111.955	1998			0-N2148	VB [BT]	
C 220 CDI	03/01-01/04	OM 611.962	2148	Rippenanzahl: 6		0-N1431	VB [DG]	
C 230	01/05-05/08	M 272.920	2496	Rippenanzahl: 6		0-N1637	VB [DG]	
C 230	01/05-05/08	M 272.920	2496			0-N1670	VB [BT]	S
C 230	01/05-05/08	M 272.920	2496		→:30058376	0-N1746	VB [DG]	
C 230	01/05-05/08	M 272.920	2496		02/2005 →; →:30058377 →	0-N2138	VB [DG]	
C 230	01/05-05/08	M 272.920	2496			0-N2143	VB [VD]	
C 230 Kompressor	03/01-05/02	M 111.981	2295			0-N1442	VB [DG]	
C 230 Kompressor	03/01-05/02	M 111.981	2295			0-N1703	VB [BT]	
C 230 Kompressor	03/01-05/02	M 111.981	2295			0-N1833	VB [TE]	
C 230 Kompressor	03/01-05/02	M 111.981	2295			0-N2141	VB [TE]	
C 230 Kompressor	03/01-05/02	M 111.981	2295			0-N2148	VB [BT]	
C 230 Kompressor	03/01-05/02	M 111.981	2295			0-N2418	VB [BT]	
C 30 CDI AMG	09/02-05/08	OM 612.990	2950			0-N1641	VB [BT]	S
C 320	09/02-05/08	M 112.946	3199	Rippenanzahl: 6		0-N1431	VB [DG]	
C 320	09/02-05/08	M 112.946	3199			0-N1645	VB [BT]	S
C 350	01/05-05/08	M 272.960	3498	Rippenanzahl: 6		0-N1637	VB [DG]	
C 350	01/05-05/08	M 272.960	3498			0-N1670	VB [BT]	S



CM³



Art. Nr.



C-KLASSE Sportcoupe (CL203)						
C 350	01/05-05/08	M 272.960	3498	:→30058376		0-N1746 VB [DG]
C 350	01/05-05/08	M 272.960	3498	02/2005 →; :30058377 →		0-N2138 VB [DG]
C 350	01/05-05/08	M 272.960	3498			0-N2143 VB [VD]
C-KLASSE Kombi (S203)						
C 180 , C 200 Kompressor	03/01-05/02	M 111.951, M 111.955	1998			0-N1703 VB [BT]
C 180 , C 200 Kompressor	03/01-05/02	M 111.951, M 111.955	1998			0-N1833 VB [TE]
C 180 , C 200 Kompressor	03/01-05/02	M 111.951, M 111.955	1998			0-N1951 VB [VD]
C 180 , C 200 Kompressor	03/01-05/02	M 111.951, M 111.955	1998			0-N2418 VB [BT]
C 180 Kompressor , C 200 CGI Kompressor , C 200 Kompressor , C 230 Kompressor	05/02-08/07	M 271.940, M 271.942, M 271.946, M 271.948	1796			0-N1457 VB [DG]
C 180 Kompressor , C 200 CGI Kompressor , C 200 Kompressor , C 230 Kompressor	05/02-08/07	M 271.940, M 271.942, M 271.946, M 271.948	1796			0-N1587 VB [BT] S
C 180 Kompressor , C 200 CGI Kompressor , C 200 Kompressor , C 230 Kompressor	05/02-08/07	M 271.940, M 271.942, M 271.946, M 271.948	1796			0-N2206 VB [DG]
C 200 CDI	03/01-08/07	OM 611.962, OM 646.962, OM 646.962	2148	→ 06/2003;		0-N1489S VB [TE]
C 200 CDI	03/01-08/07	OM 611.962, OM 646.962, OM 646.962	2148	06/2003 →		0-N1641 VB [BT] S
C 200 CDI , C 220 CDI	03/01-08/07	OM 611.962	2148	Rippenanzahl: 6		0-N1431 VB [DG]
C 200 CDI , C 220 CDI	03/01-08/07	OM 611.962, OM 646.963	2148			0-N1641 VB [BT] S
C 200 Kompressor	03/01-05/02	M 111.955	1998			0-N1283 VB [TE]
C 200 Kompressor	03/01-05/02	M 111.955	1998			0-N1442 VB [DG]
C 200 Kompressor	03/01-05/02	M 111.955	1998			0-N2148 VB [BT]
C 220 CDI	08/06-08/07	OM 646.963	2149			0-N1641 VB [BT] S
C 230	01/05-08/07	M 272.920	2496	Rippenanzahl: 6		0-N1637 VB [DG]
C 230	01/05-08/07	M 272.920	2496			0-N1670 VB [BT] S
C 230	01/05-08/07	M 272.920	2496	:→30058376		0-N1746 VB [DG]
C 230	01/05-08/07	M 272.920	2496			0-N2138 VB [DG]
C 230	01/05-08/07	M 272.920	2496			0-N2143 VB [VD]
C 240	03/01-08/07	M 112.912	2597			0-N2142 VB [VD]
C 240 , C 240 4-matic	03/01-08/07	M 112.912, M 112.916	2597	Rippenanzahl: 6		0-N1431 VB [DG]
C 240 , C 240 4-matic	03/01-08/07	M 112.912, M 112.916	2597			0-N1645 VB [BT] S
C 270 CDI	03/01-08/07	OM 612.962	2685	Rippenanzahl: 6		0-N1431 VB [DG]
C 270 CDI	03/01-08/07	OM 612.962	2685			0-N1641 VB [BT] S
C 280 , C 280 4-matic	01/05-08/07	M 272.940, M 272.941	2996	Rippenanzahl: 6		0-N1637 VB [DG]
C 280 , C 280 4-matic	01/05-08/07	M 272.940, M 272.941	2996			0-N1670 VB [BT] S
C 280 , C 280 4-matic	01/05-08/07	M 272.940, M 272.941	2996	:→30058376		0-N1746 VB [DG]
C 280 , C 280 4-matic	01/05-08/07	M 272.940, M 272.941	2996			0-N2138 VB [DG]
C 280 , C 280 4-matic	01/05-08/07	M 272.940, M 272.941	2996			0-N2143 VB [VD]
C 30 CDI AMG	01/03-08/07	OM 612.990	2950			0-N1641 VB [BT] S
C 320	03/01-08/07	M 112.946	3199	Rippenanzahl: 6		0-N1431 VB [DG]
C 320 , C 320 4-matic	03/01-08/07	M 112.946, M 112.953	3199			0-N1645 VB [BT] S
C 320 CDI	06/05-08/07	OM 642.910	2987			0-N1560 VB [DG]
C 320 CDI	06/05-08/07	OM 642.910	2987			0-N1902 VB [BT] S
C 350 , C 350 4-matic	01/05-08/07	M 272.960, M 272.970	3498	Rippenanzahl: 6		0-N1637 VB [DG]
C 350 , C 350 4-matic	01/05-08/07	M 272.960, M 272.970	3498			0-N1670 VB [BT] S
C 350 , C 350 4-matic	01/05-08/07	M 272.960, M 272.970	3498	:→30058376		0-N1746 VB [DG]
C 350 , C 350 4-matic	01/05-08/07	M 272.960, M 272.970	3498	02/2005 →; :30058377 →		0-N2138 VB [DG]
C 350 , C 350 4-matic	01/05-08/07	M 272.960, M 272.970	3498			0-N2143 VB [VD]
C 55 AMG	02/04-08/07	M 113.988	5439	Rippenanzahl: 6		0-N1431 VB [DG]
C 55 AMG	02/04-08/07	M 113.988	5439			0-N1645 VB [BT] S
C-KLASSE (W204)						
C 180 CDI , C 200 CDI , C 220 CDI , C 220 CDI 4-matic, C 250 CDI , C 250 CDI 4-matic	08/08-01/14	OM 651.911, OM 651.912, OM 651.913	2143			0-N2205 VB [DG]
C 180 CDI , C 200 CDI , C 220 CDI , C 220 CDI 4-matic, C 250 CDI , C 250 CDI 4-matic	08/08-01/14	OM 651.911, OM 651.912, OM 651.913	2143			0-N2238 VB [DG]
C 180 CDI , C 200 CDI , C 220 CDI , C 220 CDI 4-matic, C 250 CDI , C 250 CDI 4-matic	08/08-01/14	OM 651.911, OM 651.912, OM 651.913	2143	für Fahrzeuge mit Start-Stopp-Funktion		0-N2422 VB [BT] S
C 180 CDI , C 200 CDI , C 220 CDI , C 250 CDI , C 250 CDI 4-matic	08/08-01/14	OM 651.911, OM 651.912, OM 651.913	2143	für Fahrzeuge ohne Start-Stopp-Funktion		0-N2083 VB [BT] S
C 180 CGI	01/08-01/14	M 274.910	1595	11/2012 →		0-N2309 VB [BT] S
C 180 CGI	01/08-01/14	M 274.910	1595			0-N2310 VB [DG]
C 180 CGI , C 200 CGI , C 250 CGI	01/07-01/14	M 271.820, M 271.860	1796			0-N2119 VB [DG]



OPTIMAL®

MERCEDES-BENZ



CM³



Art. Nr.



ohne Halter

C-KLASSE (W204)

C 180 CGI , C 200 , C 200 CGI , C 250 CGI	01/07-01/14	M 271.820, M 271.860	1796	Rippenanzahl: 6	0-N2120	VB [DG]	
C 180 CGI , C 200 , C 200 CGI , C 250 CGI	01/07-01/14	M 271.820, M 271.860	1796		0-N2136	VB [BT]	S
C 180 Kompressor	01/08-01/14	M 271.910	1597	†	0-N1457	VB [DG]	
C 180 Kompressor	01/08-01/14	M 271.910	1597	→ 03/2009; :→31216219	0-N1587	VB [BT]	S
C 180 Kompressor	01/08-01/14	M 271.910	1597	:31216220→	0-N2136	VB [BT]	S
C 180 Kompressor	01/08-01/14	M 271.910	1597		0-N2206	VB [DG]	
C 180 Kompressor , C 200 Kompressor	01/07-01/14	M 271.950, M 271.952	1796	†	0-N1457	VB [DG]	
C 180 Kompressor , C 200 Kompressor	01/07-01/14	M 271.950, M 271.952	1796	→ 03/2009; :→31216219	0-N1587	VB [BT]	S
C 180 Kompressor , C 200 Kompressor	01/07-01/14	M 271.950, M 271.952	1796	:31216220→	0-N2136	VB [BT]	S
C 180 Kompressor , C 200 Kompressor	01/07-01/14	M 271.950, M 271.952	1796		0-N2206	VB [DG]	
C 200 CDI , C 220 CDI	01/07-12/10	OM 646.811, OM 646.811, OM 646.812	2148		0-N1641	VB [BT]	S
C 230 , C 230 4-matic	01/07-01/14	M 272.911, M 272.921	2496	Rippenanzahl: 6	0-N1637	VB [DG]	
C 230 , C 230 4-matic	01/07-01/14	M 272.911, M 272.921	2496		0-N1670	VB [BT]	S
C 230 , C 230 4-matic	01/07-01/14	M 272.911, M 272.921	2496		0-N2138	VB [DG]	
C 230 , C 230 4-matic	01/07-01/14	M 272.911, M 272.921	2496		0-N2143	VB [VD]	
C 280 , C 280 4-matic , C 300 , C 300 4-matic	01/07-01/14	M 272.947, M 272.948	2996	Rippenanzahl: 6	0-N1637	VB [DG]	
C 280 , C 280 4-matic , C 300 , C 300 4-matic	01/07-01/14	M 272.947, M 272.948	2996		0-N1670	VB [BT]	S
C 280 , C 280 4-matic , C 300 , C 300 4-matic	01/07-01/14	M 272.947, M 272.948	2996		0-N2138	VB [DG]	
C 280 , C 280 4-matic , C 300 , C 300 4-matic	01/07-01/14	M 272.947, M 272.948	2996		0-N2143	VB [VD]	
C 300 CDI 4-matic , C 320 CDI , C 320 CDI 4-matic , C 350 CDI , C 350 CDI 4-matic	01/07-01/14	OM 642.830, OM 642.832, OM 642.834, OM 642.960, OM 642.961	2987		0-N1560	VB [DG]	
C 300 CDI 4-matic , C 320 CDI , C 320 CDI 4-matic , C 350 CDI , C 350 CDI 4-matic	01/07-01/14	OM 642.830, OM 642.832, OM 642.960, OM 642.961	2987		0-N1902	VB [BT]	S
C 300 , C 300 4-matic , C 350 , C 350 4-matic	01/11-01/14	M 276.957	3498		0-N2368	VB [DG]	
C 300 , C 300 4-matic , C 350 , C 350 4-matic	01/11-01/14	M 276.957	3498		0-N2403	VB [BT]	S
C 350 , C 350 4-matic , C 350 CGI	01/07-01/14	M 272.961, M 272.971, M 272.982	3498	Rippenanzahl: 6	0-N1637	VB [DG]	
C 350 , C 350 4-matic , C 350 CGI	01/07-01/14	M 272.961, M 272.971, M 272.982	3498		0-N1670	VB [BT]	S
C 350 , C 350 4-matic , C 350 CGI	01/07-01/14	M 272.961, M 272.971, M 272.982	3498		0-N2138	VB [DG]	
C 350 , C 350 4-matic , C 350 CGI	01/07-01/14	M 272.961, M 272.971, M 272.982	3498		0-N2143	VB [VD]	
C 350 CDI	06/11-01/14	OM 642.834	2987	für Fahrzeuge mit Start-Stopp-Funktion	0-N2293	VB [BT]	S
C 63 AMG	02/08-01/14	M 156.985	6208	Rippenanzahl: 6	0-N2120	VB [DG]	

C-KLASSE Coupe (C204)

C 180	01/13-	M 274.910	1595		0-N2309	VB [BT]	S
C 180	01/13-	M 274.910	1595		0-N2310	VB [DG]	
C 180 , C 200 CGI , C 250	06/11-	M 271.820, M 271.860	1796	Rippenanzahl: 6	0-N2120	VB [DG]	
C 180 , C 250	06/11-	M 271.820, M 271.860	1796		0-N2119	VB [DG]	
C 180 , C 250	06/11-	M 271.820, M 271.860	1796		0-N2136	VB [BT]	S
C 220 CDI , C 250 CDI	06/11-	OM 651.911	2143	für Fahrzeuge ohne Start-Stopp-Funktion	0-N2083	VB [BT]	S
C 220 CDI , C 250 CDI	06/11-	OM 651.911	2143		0-N2205	VB [DG]	
C 220 CDI , C 250 CDI	06/11-	OM 651.911	2143		0-N2238	VB [DG]	
C 220 CDI , C 250 CDI	06/11-	OM 651.911	2143	für Fahrzeuge mit Start-Stopp-Funktion	0-N2422	VB [BT]	S
C 350 , C 350 4-matic	06/11-	M 276.957	3498		0-N2368	VB [DG]	
C 350 , C 350 4-matic	06/11-	M 276.957	3498		0-N2403	VB [BT]	S
C 63 AMG	06/11-	M 156.985	6208	Rippenanzahl: 6	0-N2120	VB [DG]	

C-KLASSE Kombi (S204)

C 180 CDI , C 200 CDI , C 220 CDI , C 220 CDI 4-matic , C 250 CDI , C 250 CDI 4-matic	12/08-08/14	OM 651.911, OM 651.912, OM 651.913	2143		0-N2205	VB [DG]	
C 180 CDI , C 200 CDI , C 220 CDI , C 220 CDI 4-matic , C 250 CDI , C 250 CDI 4-matic	12/08-08/14	OM 651.911, OM 651.912, OM 651.913	2143		0-N2238	VB [DG]	
C 180 CDI , C 200 CDI , C 220 CDI , C 220 CDI 4-matic , C 250 CDI , C 250 CDI 4-matic	12/08-08/14	OM 651.911, OM 651.912, OM 651.913	2143	für Fahrzeuge mit Start-Stopp-Funktion	0-N2422	VB [BT]	S
C 180 CDI , C 200 CDI , C 220 CDI , C 250 CDI 4-matic	12/08-08/14	OM 651.911, OM 651.912, OM 651.913	2143	für Fahrzeuge ohne Start-Stopp-Funktion	0-N2083	VB [BT]	S
C 180 CGI	02/12-08/14	M 274.910	1595	11/2012 →	0-N2309	VB [BT]	S
C 180 CGI	02/12-08/14	M 274.910	1595		0-N2310	VB [DG]	
C 180 CGI , C 200 CGI , C 250 CGI	08/07-08/14	M 271.820, M 271.820, M 271.860, M 271.860	1796	Rippenanzahl: 6	0-N2120	VB [DG]	

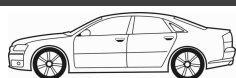

CM³



Art. Nr.



ohne Halter

C-KLASSE Kombi (S204)								
C 180 CGI , C 250 CGI	07/09-08/14	M 271.820, M 271.860	1796			0-N2119	VB [DG]	
C 180 CGI , C 250 CGI	07/09-08/14	M 271.820, M 271.860	1796			0-N2136	VB [BT]	S
C 180 Kompressor	08/07-08/14	M 271.952	1796	:31216220→		0-N2136	VB [BT]	S
C 180 Kompressor	01/08-08/14	M 271.910	1597			0-N1457	VB [DG]	
C 180 Kompressor	01/08-08/14	M 271.910	1597	→ 03/2009; :→31216219		0-N1587	VB [BT]	S
C 180 Kompressor	01/08-08/14	M 271.910	1597	:31216220→		0-N2136	VB [BT]	S
C 180 Kompressor	01/08-08/14	M 271.910	1597			0-N2206	VB [DG]	
C 180 Kompressor , C 200 Kompressor	08/07-08/14	M 271.950, M 271.952	1796			0-N1457	VB [DG]	
C 180 Kompressor , C 200 Kompressor	08/07-08/14	M 271.950, M 271.952	1796	→ 03/2009; :→31216219		0-N1587	VB [BT]	S
C 180 Kompressor , C 200 Kompressor	08/07-08/14	M 271.950, M 271.952	1796			0-N2206	VB [DG]	
C 200 CDI , C 220 CDI	08/07-12/11	OM 646.811	2148			0-N1641	VB [BT]	S
C 200 Kompressor	08/07-08/14	M 271.820, M 271.860	1796			0-N2119	VB [DG]	
C 200 Kompressor	08/07-08/14	M 271.820, M 271.860	1796	Rippenanzahl: 6		0-N2120	VB [DG]	
C 200 Kompressor	08/07-08/14	M 271.820, M 271.860	1796			0-N2136	VB [BT]	S
C 200 Kompressor	08/07-08/14	M 271.950	1796	:31216220→		0-N2136	VB [BT]	S
C 230	08/07-08/14	M 272.921	2496	Rippenanzahl: 6		0-N1637	VB [DG]	
C 230	08/07-08/14	M 272.921	2496			0-N1670	VB [BT]	S
C 230	08/07-08/14	M 272.921	2496			0-N2138	VB [DG]	
C 230	08/07-08/14	M 272.921	2496			0-N2143	VB [VD]	
C 250 CDI	01/09-08/14	OM 651.911	2143	05/2009 →; für Fahrzeuge ohne Start-Stopp-Funktion		0-N2083	VB [BT]	S
C 280	08/07-08/14	M 272.947	2996	Rippenanzahl: 6		0-N1637	VB [DG]	
C 280	08/07-08/14	M 272.947	2996			0-N1670	VB [BT]	S
C 280 , C 300	08/07-08/14	M 272.947	2996			0-N2138	VB [DG]	
C 280 , C 300	08/07-08/14	M 272.947	2996			0-N2143	VB [VD]	
C 320 CDI , C 320 CDI 4-matic , C 350 CDI , C 350 CDI 4-matic	08/07-08/14	OM 642.830, OM 642.832, OM 642.834, OM 642.960, OM 642.961	2987			0-N1560	VB [DG]	
C 320 CDI , C 320 CDI 4-matic , C 350 CDI , C 350 CDI 4-matic	08/07-08/14	OM 642.830, OM 642.832, OM 642.960, OM 642.961	2987			0-N1902	VB [BT]	S
C 350	08/07-08/14	M 272.961	3498	Rippenanzahl: 6		0-N1637	VB [DG]	
C 350	08/07-08/14	M 272.961	3498			0-N1670	VB [BT]	S
C 350	08/07-08/14	M 272.961	3498			0-N2138	VB [DG]	
C 350	08/07-08/14	M 272.961	3498			0-N2143	VB [VD]	
C 350 CDI	06/11-08/14	OM 642.834	2987	für Fahrzeuge mit Start-Stopp-Funktion		0-N2293	VB [BT]	S
C 350 CGI	06/11-08/14	M 276.957	3498			0-N2368	VB [DG]	
C 350 CGI	06/11-08/14	M 276.957	3498			0-N2403	VB [BT]	S
C 63 AMG	02/08-08/14	M 156.985	6208	Rippenanzahl: 6		0-N2120	VB [DG]	
C-KLASSE (W205)								
C 180	03/14-	M 274.910	1595			0-N2309	VB [BT]	S
C 200, C 250 CGI	12/13-	M 274.920	1991			0-N2309	VB [BT]	S
C 220 BlueTEC, C 250 BlueTEC, C 250 BlueTEC 4-matic	12/13-	OM 651.921	2143			0-N2307	VB [BT]	S
C-KLASSE Kombi (S205)								
C 180	09/14-	M 274.910	1595			0-N2309	VB [BT]	S
C 200, C 250	09/14-	M 274.920	1991			0-N2309	VB [BT]	S
CITAN Kasten (415)								
108 CDI, 109 CDI, 111 CDI	11/12-	OM 607.951	1461	27x119		SK-1730	BTK	
108 CDI, 109 CDI, 111 CDI	11/12-	OM 607.951	1461	27x119		SK-1730AQ1	BTKW	
108 CDI, 109 CDI, 111 CDI	11/12-	OM 607.951	1461			0-N2423	TB [TE]	
108 CDI, 109 CDI, 111 CDI	11/12-	OM 607.951	1461			0-N2253	VB [DG]	
108 CDI, 109 CDI, 111 CDI	11/12-	OM 607.951	1461			0-N2290	VB [BT]	S
112	06/13-	M 200.711	1192			0-N2253	VB [DG]	
CITAN Kombi / Tourer (415)								
108 CDI, 109 CDI, 111	11/12-	OM 607.951	1461	27x119		SK-1730	BTK	
108 CDI, 109 CDI, 111	11/12-	OM 607.951	1461	27x119		SK-1730AQ1	BTKW	
108 CDI, 109 CDI, 111	11/12-	OM 607.951	1461			0-N2423	TB [TE]	
108 CDI, 109 CDI, 111	11/12-	OM 607.951	1461			0-N2253	VB [DG]	
108 CDI, 109 CDI, 111	11/12-	OM 607.951	1461			0-N2290	VB [BT]	S
112	06/13-	M 200.711	1192			0-N2253	VB [DG]	
CITAN Mixto (415)								
109 CDI, 111 CDI	11/12-	OM 607.951	1461	27x119		SK-1730	BTK	
109 CDI, 111 CDI	11/12-	OM 607.951	1461	27x119		SK-1730AQ1	BTKW	
109 CDI, 111 CDI	11/12-	OM 607.951	1461			0-N2423	TB [TE]	
109 CDI, 111 CDI	11/12-	OM 607.951	1461			0-N2253	VB [DG]	



OPTIMAL®

MERCEDES-BENZ



CM³



Art. Nr.



CITAN Mixto (415)								
109 CDI, 111 CDI	11/12-	OM 607.951	1461			0-N2290	VB [BT]	S
CLA Coupe (C117)								
3.0	10/13-	OM 607.951	1461	27x119		SK-1730	BTK	
3.0	10/13-	OM 607.951	1461	27x119		SK-1730AQ1	BTKW	
3.0	10/13-	OM 607.951	1461			0-N2423	TB [TE]	
3.0	10/13-	OM 607.951	1461			0-N2290	VB [BT]	S
CLA 180, CLA 200	01/13-	M 270.910	1595			0-N2310	VB [DG]	
CLA 250, CLA 250 4-matic	01/13-	M 270.920, M 270.920, M 274.920	1991			0-N2310	VB [DG]	
CLA Shooting Brake (X117)								
CLA 180	07/15-	OM 607.951	1461	27x119		SK-1730	BTK	
CLA 180	07/15-	OM 607.951	1461	27x119		SK-1730AQ1	BTKW	
CLC-KLASSE (CL203)								
CLC 200 Kompressor	05/08-06/11	M 271.957	1796			0-N1256	TB [TE]	
CLC 160	02/09-06/11	M 271.911	1597	†		0-N1457	VB [DG]	
CLC 160	02/09-06/11	M 271.911	1597	→ 03/2009; :→31216219		0-N1587	VB [BT]	S
CLC 160	02/09-06/11	M 271.911	1597	:31216220→		0-N2136	VB [BT]	S
CLC 160	02/09-06/11	M 271.911	1597			0-N2206	VB [DG]	
CLC 180 Kompressor, CLC 200 Kompressor	05/08-06/11	M 271.946, M 271.957	1796	†		0-N1457	VB [DG]	
CLC 180 Kompressor, CLC 200 Kompressor	05/08-06/11	M 271.946, M 271.957	1796	→ 03/2009; :→31216219		0-N1587	VB [BT]	S
CLC 180 Kompressor, CLC 200 Kompressor	05/08-06/11	M 271.946, M 271.957	1796	:31216220→		0-N2136	VB [BT]	S
CLC 180 Kompressor, CLC 200 Kompressor	05/08-06/11	M 271.946, M 271.957	1796			0-N2206	VB [DG]	
CLC 200 CDI, CLC 220 CDI	05/08-06/11	OM 646.962, OM 646.963	2148			0-N1641	VB [BT]	S
CLC 230	05/08-06/11	M 272.920	2496	Rippenanzahl: 6		0-N1637	VB [DG]	
CLC 230	05/08-06/11	M 272.920	2496			0-N1670	VB [BT]	S
CLC 230	05/08-06/11	M 272.920	2496			0-N2138	VB [DG]	
CLC 230	05/08-06/11	M 272.920	2496			0-N2143	VB [VD]	
CLC 350	05/08-06/11	M 272.960	3498	Rippenanzahl: 6		0-N1637	VB [DG]	
CLC 350	05/08-06/11	M 272.960	3498			0-N1670	VB [BT]	S
CLC 350	05/08-06/11	M 272.960	3498			0-N2138	VB [DG]	
CLC 350	05/08-06/11	M 272.960	3498			0-N2143	VB [VD]	
CLK (C208)								
200	06/97-06/02	M 111.945	1998	→ 05/2000		0-N1951	VB [VD]	
200 Kompressor	06/97-06/02	M 111.944, M 111.956	1998			0-N1283	VB [TE]	
200 Kompressor	06/97-06/02	M 111.944, M 111.956	1998			0-N1442	VB [DG]	
200 Kompressor	06/97-06/02	M 111.944, M 111.956	1998			0-N1951	VB [VD]	
200 Kompressor	06/97-06/00	M 111.944	1998			0-N2141	VB [TE]	
200 Kompressor	06/97-06/02	M 111.944, M 111.956	1998			0-N2148	VB [BT]	
200, 200 Kompressor	06/97-06/02	M 111.944, M 111.945, M 111.956	1998			0-N1703	VB [BT]	
200, 200 Kompressor	06/97-06/02	M 111.944, M 111.945, M 111.956	1998			0-N1833	VB [TE]	
200, 200 Kompressor	06/97-06/02	M 111.944, M 111.945, M 111.956	1998			0-N2418	VB [BT]	
230 Kompressor	06/97-06/02	M 111.973, M 111.975, M 111.982	2295			0-N1442	VB [DG]	
230 Kompressor	06/97-06/02	M 111.973, M 111.975, M 111.982	2295			0-N1703	VB [BT]	
230 Kompressor	06/97-06/02	M 111.973, M 111.975, M 111.982	2295			0-N1833	VB [TE]	
230 Kompressor	06/97-06/02	M 111.973, M 111.975, M 111.982	2295			0-N1951	VB [VD]	
230 Kompressor	06/97-06/02	M 111.973, M 111.975, M 111.982	2295			0-N2141	VB [TE]	
230 Kompressor	06/97-06/02	M 111.973, M 111.975, M 111.982	2295			0-N2148	VB [BT]	
230 Kompressor	06/97-06/02	M 111.973, M 111.975, M 111.982	2295			0-N2418	VB [BT]	
320	06/97-06/02	M 112.940	3199	Rippenanzahl: 6		0-N1431	VB [DG]	
320	06/97-06/02	M 112.940	3199			0-N1645	VB [BT]	S
430	07/98-06/02	M 113.943	4266	Rippenanzahl: 6		0-N1431	VB [DG]	
430	07/98-06/02	M 113.943	4266			0-N1645	VB [BT]	S
5.4, 55 AMG	10/98-07/02	M 113.981, M 113.984, M 113.984	5439			0-N1645	VB [BT]	S
55 AMG	08/99-06/02	M 113.981, M 113.984	5439	Rippenanzahl: 6		0-N1431	VB [DG]	
CLK Cabriolet (A208)								
200 Kompressor	03/98-03/02	M 111.944, M 111.956	1998			0-N1283	VB [TE]	
200 Kompressor	03/98-03/02	M 111.944, M 111.956	1998			0-N1442	VB [DG]	
200 Kompressor	03/98-06/00	M 111.944	1998			0-N2141	VB [TE]	
200 Kompressor	03/98-03/02	M 111.944, M 111.956	1998			0-N2148	VB [BT]	
200 Kompressor	06/00-03/02	M 111.956	1998			0-N1951	VB [VD]	
200, 200 Kompressor	03/98-03/02	M 111.941, M 111.945, M 111.944, M 111.956	1998			0-N1703	VB [BT]	



CM³



Art. Nr.



CLK Cabriolet (A208)										
200, 200 Kompressor	03/98-03/02	M 111.941, M 111.945, M 111.944, M 111.956	1998					0-N1833	VB [TE]	
200, 200 Kompressor	03/98-03/02	M 111.941, M 111.945, M 111.944	1998	06/1998 →				0-N1951	VB [VD]	
200, 200 Kompressor	03/98-03/02	M 111.941, M 111.945, M 111.944, M 111.956	1998					0-N2418	VB [BT]	
230 Kompressor	03/98-03/02	M 111.973, M 111.975, M 111.982	2295					0-N1442	VB [DG]	
230 Kompressor	03/98-03/02	M 111.973, M 111.975, M 111.982	2295					0-N1703	VB [BT]	
230 Kompressor	03/98-03/02	M 111.973, M 111.975, M 111.982	2295					0-N1833	VB [TE]	
230 Kompressor	03/98-06/00	M 111.973, M 111.975	2295	06/1998 →				0-N1951	VB [VD]	
230 Kompressor	03/98-03/02	M 111.973, M 111.975, M 111.982	2295					0-N2141	VB [TE]	
230 Kompressor	03/98-03/02	M 111.973, M 111.975, M 111.982	2295					0-N2148	VB [BT]	
230 Kompressor	03/98-03/02	M 111.973, M 111.975, M 111.982	2295					0-N2418	VB [BT]	
230 Kompressor	06/00-03/02	M 111.982	2295					0-N1951	VB [VD]	
320	03/98-03/02	M 112.940	3199	Rippenanzahl: 6				0-N1431	VB [DG]	
320	03/98-03/02	M 112.940	3199					0-N1645	VB [BT]	S
430	09/98-03/02	M 113.943	4266	Rippenanzahl: 6				0-N1431	VB [DG]	
430	09/98-03/02	M 113.943	4266					0-N1645	VB [BT]	S
55 AMG	01/00-03/02	M 113.981, M 113.984	5439	Rippenanzahl: 6				0-N1431	VB [DG]	
55 AMG	01/00-03/02	M 113.981, M 113.984	5439					0-N1645	VB [BT]	S

CLK (C209)										
200 CGI , 200 Kompressor	09/02-05/09	M 271.940, M 271.942, M 271.955	1796	†				0-N1457	VB [DG]	
200 CGI , 200 Kompressor	09/02-05/09	M 271.940, M 271.942, M 271.955	1796	→ 03/2009				0-N1587	VB [BT]	S
200 CGI , 200 Kompressor	09/02-05/09	M 271.940, M 271.942, M 271.955	1796					0-N2136	VB [BT]	S
200 CGI , 200 Kompressor	09/02-05/09	M 271.940, M 271.942, M 271.955	1796					0-N2206	VB [DG]	
220 CDI	01/05-05/09	OM 646.966	2148					0-N1641	VB [BT]	S
240	06/02-05/09	M 112.912	2597	Rippenanzahl: 6				0-N1431	VB [DG]	
240	06/02-05/09	M 112.912	2597					0-N1645	VB [BT]	S
240	06/02-05/09	M 112.912	2597					0-N2142	VB [VD]	
270 CDI	10/02-05/09	OM 612.962	2685	Rippenanzahl: 6				0-N1431	VB [DG]	
270 CDI	10/02-05/09	OM 612.962, OM 612.967, OM 612.967	2685					0-N1641	VB [BT]	S
280	01/05-05/09	M 272.940	2996	Rippenanzahl: 6				0-N1637	VB [DG]	
280	01/05-05/09	M 272.940	2996					0-N1670	VB [BT]	S
280	01/05-05/09	M 272.940	2996	EMERSON: → 30058376				0-N1746	VB [DG]	
280	01/05-05/09	M 272.940	2996					0-N2138	VB [DG]	
280	01/05-05/09	M 272.940	2996					0-N2143	VB [VD]	
320	06/02-05/09	M 112.955	3199	Rippenanzahl: 6				0-N1431	VB [DG]	
320	06/02-05/09	M 112.955	3199					0-N1645	VB [BT]	S
320 CDI	01/05-05/09	OM 642.910	2987					0-N1560	VB [DG]	
320 CDI	01/05-05/09	OM 642.910	2987					0-N1902	VB [BT]	S
350	01/05-05/09	M 272.960	3498	Rippenanzahl: 6				0-N1637	VB [DG]	
350	01/05-05/09	M 272.960	3498					0-N1670	VB [BT]	S
350	01/05-05/09	M 272.960	3498	EMERSON: → 30058376				0-N1746	VB [DG]	
350	01/05-05/09	M 272.960	3498	02/2005 →; EMERSON: 30058377 →				0-N2138	VB [DG]	
350	01/05-05/09	M 272.960	3498					0-N2143	VB [VD]	
500	06/02-05/09	M 113.968	4966	Rippenanzahl: 6				0-N1431	VB [DG]	
500	06/02-05/09	M 113.968	4966					0-N1645	VB [BT]	S
55 AMG	09/02-05/09	M 113.987	5439	Rippenanzahl: 6				0-N1431	VB [DG]	
55 AMG	09/02-05/09	M 113.987	5439					0-N1645	VB [BT]	S

CLK Cabriolet (A209)										
CLK 200 CGI , CLK 200 Kompressor	02/03-03/10	M 271.940, M 271.942, M 271.955	1796	†				0-N1457	VB [DG]	
CLK 200 CGI , CLK 200 Kompressor	02/03-03/10	M 271.940, M 271.942, M 271.955	1796	→ 03/2009				0-N1587	VB [BT]	S
CLK 200 CGI , CLK 200 Kompressor	02/03-03/10	M 271.940, M 271.942, M 271.955	1796					0-N2136	VB [BT]	S
CLK 200 CGI , CLK 200 Kompressor	02/03-03/10	M 271.940, M 271.942, M 271.955	1796					0-N2206	VB [DG]	
CLK 240	02/03-03/10	M 112.912	2597	Rippenanzahl: 6				0-N1431	VB [DG]	
CLK 240	02/03-03/10	M 112.912	2597					0-N1645	VB [BT]	S
CLK 240	02/03-03/10	M 112.912	2597					0-N2142	VB [VD]	
CLK 280	01/05-03/10	M 272.940	2996	Rippenanzahl: 6				0-N1637	VB [DG]	
CLK 280	01/05-03/10	M 272.940	2996					0-N1670	VB [BT]	S
CLK 280	01/05-03/10	M 272.940	2996	EMERSON: → 30058376				0-N1746	VB [DG]	
CLK 280	01/05-03/10	M 272.940	2996					0-N2138	VB [DG]	
CLK 280	01/05-03/10	M 272.940	2996					0-N2143	VB [VD]	
CLK 320	02/03-03/10	M 112.955	3199	Rippenanzahl: 6				0-N1431	VB [DG]	
CLK 320	02/03-03/10	M 112.955	3199					0-N1645	VB [BT]	S
CLK 320 CDI	03/05-03/10	OM 642.910	2987					0-N1560	VB [DG]	
CLK 320 CDI	03/05-03/10	OM 642.910	2987					0-N1902	VB [BT]	S

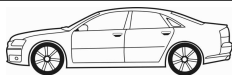

CM³



Art. Nr.



ohne Halter

CLK Cabriolet (A209)

CLK 350	01/05-03/10	M 272.960	3498	Rippenanzahl: 6	0-N1637	VB [DG]	
CLK 350	01/05-03/10	M 272.960	3498		0-N1670	VB [BT]	S
CLK 350	01/05-03/10	M 272.960	3498	ENGINE: →30058376	0-N1746	VB [DG]	
CLK 350	01/05-03/10	M 272.960	3498	02/2005 →; ENGINE:30058377→	0-N2138	VB [DG]	
CLK 350	01/05-03/10	M 272.960	3498		0-N2143	VB [VD]	
CLK 500	02/03-03/10	M 113.968	4966	Rippenanzahl: 6	0-N1431	VB [DG]	
CLK 500	02/03-03/10	M 113.968	4966		0-N1645	VB [BT]	S
CLK 500	06/06-03/10	M 273.967	5461		0-N2138	VB [DG]	
CLK 55 AMG	02/03-03/10	M 113.987	5439	Rippenanzahl: 6	0-N1431	VB [DG]	
CLK 55 AMG	02/03-03/10	M 113.987	5439		0-N1645	VB [BT]	S

CLS (C218)

CLS 220 BlueTEC, CLS 250 BlueTEC 4-matic, CLS 250 CDI	04/11-	OM 651.924	2143		0-N2205	VB [DG]	
CLS 220 BlueTEC, CLS 250 BlueTEC 4-matic, CLS 250 CDI	04/11-	OM 651.924	2143	für Fahrzeuge mit Hybridantrieb	0-N2306	VB [BT]	S
CLS 220 BlueTEC, CLS 250 BlueTEC 4-matic, CLS 250 CDI	04/11-	OM 651.924	2143	für Fahrzeuge mit Start-Stopp-Funktion	0-N2422	VB [BT]	S
CLS 250 CDI	04/11-	OM 651.924	2143	für Fahrzeuge ohne Start-Stopp-Funktion	0-N2083	VB [BT]	S
CLS 250 CDI	04/11-	OM 651.924	2143		0-N2238	VB [DG]	
CLS 350, CLS 400, CLS 400 4-matic	01/11-	M 276.850, M 276.952	3498		0-N2368	VB [DG]	
CLS 350, CLS 400, CLS 400 4-matic	01/11-	M 276.850, M 276.952	3498		0-N2403	VB [BT]	S
CLS 350 BlueTEC, CLS 350 BlueTEC 4-matic, CLS 350 CDI, CLS 350 CDI 4-matic	01/11-	OM 642.852, OM 642.853, OM 642.854, OM 642.858	2987		0-N1560	VB [DG]	
CLS 350 BlueTEC, CLS 350 BlueTEC 4-matic, CLS 350 CDI, CLS 350 CDI 4-matic	01/11-	OM 642.852, OM 642.853, OM 642.854, OM 642.858	2987	für Fahrzeuge mit Start-Stopp-Funktion	0-N2293	VB [BT]	S
CLS 350 CDI, CLS 350 CDI 4-matic	01/11-	OM 642.853, OM 642.854	2987		0-N1902	VB [BT]	S
CLS 400, CLS 400 4-matic	05/14-	M 276.820	2996		0-N2368	VB [DG]	
CLS 400, CLS 400 4-matic	05/14-	M 276.820	2996		0-N2403	VB [BT]	S
CLS 500, CLS 500 4-matic	02/11-	M 278.922	4663		0-N2284	VB [DG]	
CLS 63 AMG, CLS 63 AMG 4-matic	01/11-	M 157.981	5461		0-N2284	VB [DG]	

CLS (C219)

CLS 280, CLS 300	07/08-12/10	M 272.943	2996	Rippenanzahl: 6	0-N1637	VB [DG]	
CLS 280, CLS 300	07/08-12/10	M 272.943	2996		0-N1670	VB [BT]	S
CLS 280, CLS 300	07/08-12/10	M 272.943	2996		0-N2138	VB [DG]	
CLS 280, CLS 300	07/08-12/10	M 272.943	2996		0-N2143	VB [VD]	
CLS 320 CDI, CLS 350 CDI	01/05-12/10	OM 642.920	2987		0-N1560	VB [DG]	
CLS 320 CDI, CLS 350 CDI	01/05-12/10	OM 642.920	2987		0-N1902	VB [BT]	S
CLS 350	10/04-12/10	M 272.964	3498	→ 02/2005; ENGINE:→30058376	0-N1746	VB [DG]	
CLS 350	10/04-12/10	M 272.964	3498	02/2005 →; ENGINE:30058377→	0-N2138	VB [DG]	
CLS 350, CLS 350 CGI	10/04-12/10	M 272.964, M 272.985	3498	Rippenanzahl: 6	0-N1637	VB [DG]	
CLS 350, CLS 350 CGI	10/04-12/10	M 272.964, M 272.985	3498		0-N1670	VB [BT]	S
CLS 350, CLS 350 CGI	10/04-12/10	M 272.964, M 272.985	3498		0-N2143	VB [VD]	
CLS 350, CLS 350 CGI	04/06-12/10	M 272.985	3498		0-N2138	VB [DG]	
CLS 500	10/04-12/10	M 113.967	4966	Rippenanzahl: 6	0-N1431	VB [DG]	
CLS 500	10/04-12/10	M 113.967	4966		0-N1645	VB [BT]	S
CLS 500	04/06-12/10	M 273.960	5461	Rippenanzahl: 6	0-N1637	VB [DG]	
CLS 500	04/06-12/10	M 273.960	5461		0-N1670	VB [BT]	S
CLS 500	04/06-12/10	M 273.960	5461		0-N2138	VB [DG]	
CLS 55 AMG	01/05-12/10	M 113.990	5439		0-N1645	VB [BT]	S
CLS 63 AMG	04/06-12/10	M 156.983	6208	Rippenanzahl: 6	0-N2120	VB [DG]	

CLS Shooting Brake (X218)

CLS 220 BlueTEC, CLS 250 BlueTEC 4-matic, CLS 250 CDI	10/12-	OM 651.924	2143		0-N2205	VB [DG]	
CLS 220 BlueTEC, CLS 250 BlueTEC 4-matic, CLS 250 CDI	10/12-	OM 651.924	2143	für Fahrzeuge mit Hybridantrieb	0-N2306	VB [BT]	S
CLS 220 BlueTEC, CLS 250 BlueTEC 4-matic, CLS 250 CDI	10/12-	OM 651.924	2143	für Fahrzeuge mit Start-Stopp-Funktion	0-N2422	VB [BT]	S
CLS 250 CDI	10/12-	OM 651.924	2143		0-N2238	VB [DG]	
CLS 350, CLS 400, CLS 400 4-matic	10/12-	M 276.850, M 276.952	3498		0-N2368	VB [DG]	
CLS 350, CLS 400, CLS 400 4-matic	10/12-	M 276.850, M 276.952	3498		0-N2403	VB [BT]	S
CLS 350 BlueTEC, CLS 350 BlueTEC 4-matic, CLS 350 CDI, CLS 350 CDI 4-matic	10/12-	OM 642.853, OM 642.854, OM 642.858	2987		0-N1560	VB [DG]	
CLS 350 CDI, CLS 350 CDI 4-matic	10/12-	OM 642.853, OM 642.854	2987		0-N1902	VB [BT]	S
CLS 350 CDI, CLS 350 CDI 4-matic	10/12-	OM 642.853, OM 642.854	2987	für Fahrzeuge mit Start-Stopp-Funktion	0-N2293	VB [BT]	S



CM³



Art. Nr.



ohne Halter

CLS Shooting Brake (X218)								
CLS 400, CLS 400 4-matic	05/14-	M 276.820	2996			0-N2368	VB [DG]	
CLS 400, CLS 400 4-matic	05/14-	M 276.820	2996			0-N2403	VB [BT]	S
CLS 500, CLS 500 4-matic	10/12-	M 278.922	4663			0-N2284	VB [DG]	
CLS 63 AMG, CLS 63 AMG 4-matic	10/12-	M 157.981	5461			0-N2284	VB [DG]	
COUPE (C124)								
220 CE	10/92-05/93	M 111.960	2199			0-N1703	VB [BT]	
220 CE	10/92-05/93	M 111.960	2199			0-N1833	VB [TE]	
220 CE	10/92-05/93	M 111.960	2199			0-N1951	VB [VD]	
220 CE	10/92-05/93	M 111.960	2199			0-N2418	VB [BT]	
230 CE	03/87-12/92	M 102.982	2298	mit Anbaumaterial; für Fahrzeuge mit Servolenkung		0-N1013	VB [BT]	S
230 CE	03/87-12/92	M 102.982	2298	:086552→		0-N2144	VB [VD]	
230 CE	03/87-12/92	M 102.982	2298	:→086551		0-N2145	VB [VD]	
230 CE	03/87-12/92	M 102.982	2298			0-N846	VB [TE]	
230 CE	03/87-12/92	M 102.982	2298	für Fahrzeuge ohne Servolenkung		0-N847	VB [TE]	
300 CE, 300 CE-24	03/87-05/93	M 103.983, M 104.980	2960			0-N1011	VB [BT]	S
300 CE, 300 CE-24	03/87-05/93	M 103.983, M 104.980	2960			0-N1278	VB [TE]	
300 CE, 300 CE-24	03/87-05/93	M 103.983, M 104.980	2960			0-N2146	VB [VD]	
300 CE-24	09/89-12/92	M 104.980	2960	:→21004		0-N847	VB [TE]	
300 CE-24	09/89-12/92	M 104.980	2960	:→4956		0-N847	VB [TE]	
320 CE	10/92-05/93	M 104.992	3199	:→004356, 072236		0-N1011	VB [BT]	S
320 CE	10/92-05/93	M 104.992	3199	:→004356, 072236		0-N1278	VB [TE]	
320 CE	10/92-05/93	M 104.992	3199	:004357, 072237→		0-N1282	VB [TE]	
320 CE	10/92-05/93	M 104.992	3199			0-N1283	VB [TE]	
320 CE	10/92-05/93	M 104.992	3199	Rippenanzahl: 6		0-N1288	VB [DG]	
320 CE	10/92-05/93	M 104.992	3199	:004357, 072237→; :→005602, 102820		0-N2141	VB [TE]	
320 CE	10/92-05/93	M 104.992	3199	:→004356, 072237		0-N2146	VB [VD]	
E-KLASSE (W124)								
E 200	06/93-06/95	M 111.940	1998			0-N1703	VB [BT]	
E 200	06/93-06/95	M 111.940	1998			0-N1833	VB [TE]	
E 200	06/93-06/95	M 111.940	1998			0-N1951	VB [VD]	
E 200	06/93-06/95	M 111.940	1998			0-N2418	VB [BT]	
E 200 D	06/93-06/95	OM 601.912	1997	:021217, 204234→		0-N1043	VB [BT]	
E 200 D	06/93-06/95	OM 601.912	1997			0-N1289	VB [BT]	
E 200 D	06/93-06/95	OM 601.912	1997	:→021216, 204233; hydraulisch		0-N1926	VB [VD]	
E 200 D	06/93-06/95	OM 601.912	1997	:021217, 204234→		0-N2147	VB [VD]	
E 200 D	06/93-06/95	OM 601.912	1997			0-N846	VB [TE]	
E 200 D	06/93-06/95	OM 601.912	1997	für Fahrzeuge ohne Servolenkung		0-N847	VB [TE]	
E 220	06/93-06/95	M 111.960	2199			0-N1703	VB [BT]	
E 220	06/93-06/95	M 111.960	2199			0-N1833	VB [TE]	
E 220	06/93-06/95	M 111.960	2199			0-N1951	VB [VD]	
E 220	06/93-06/95	M 111.960	2199			0-N2418	VB [BT]	
E 250 D, E 250 Turbo-D	06/93-06/95	OM 602.962, OM 605.911	2497			0-N1043	VB [BT]	
E 250 D, E 250 Turbo-D	06/93-06/95	OM 602.962, OM 605.911	2497			0-N2147	VB [VD]	
E 250 D, E 250 Turbo-D	06/93-06/95	OM 602.962, OM 605.911	2497			0-N846	VB [TE]	
E 280, E 280 long	06/93-06/95	M 104.942	2799	:→005789, 048696		0-N1011	VB [BT]	S
E 280, E 280 long	06/93-06/95	M 104.942	2799	:→005789, 048696		0-N1278	VB [TE]	
E 280, E 280 long	06/93-06/95	M 104.942	2799	:005790, 048697→		0-N1282	VB [TE]	
E 280, E 280 long	06/93-06/95	M 104.942	2799	Rippenanzahl: 6		0-N1288	VB [DG]	
E 280, E 280 long	06/93-06/95	M 104.942	2799	:005790, 048697→		0-N2141	VB [TE]	
E 280, E 280 long	06/93-06/95	M 104.942	2799	:→005789, 048696		0-N2146	VB [VD]	
E 300 4-matic	06/93-06/95	M 103.985	2960			0-N1011	VB [BT]	S
E 300 4-matic	06/93-06/95	M 103.985	2960			0-N1278	VB [TE]	
E 300 4-matic	06/93-06/95	M 103.985	2960			0-N2146	VB [VD]	
E 300 D	07/93-06/95	OM 606.910	2996			0-N1043	VB [BT]	
E 300 D	07/93-06/95	OM 606.910	2996			0-N2147	VB [VD]	
E 300 D, E 300 Turbo-D, E 300 Turbo-D 4-matic	06/93-06/95	OM 603.960, OM 603.963, OM 606.910	2996			0-N846	VB [TE]	
E 300 Turbo-D, E 300 Turbo-D 4-matic	06/93-06/95	OM 603.960, OM 603.963	2996	:004191→		0-N1043	VB [BT]	
E 300 Turbo-D, E 300 Turbo-D 4-matic	06/93-06/95	OM 603.960, OM 603.963	2996	:048697→		0-N1043	VB [BT]	
E 300 Turbo-D, E 300 Turbo-D 4-matic	06/93-06/95	OM 603.960, OM 603.963	2996	:→004190, 049508		0-N1289	VB [BT]	
E 300 Turbo-D, E 300 Turbo-D 4-matic	06/93-06/95	OM 603.960, OM 603.963	2996	:→004190, 049508; hydraulisch		0-N1926	VB [VD]	
E 300 Turbo-D, E 300 Turbo-D 4-matic	06/93-06/95	OM 603.960, OM 603.963	2996	:004191→		0-N2147	VB [VD]	
E 300 Turbo-D, E 300 Turbo-D 4-matic	06/93-06/95	OM 603.960, OM 603.963	2996	:048697→		0-N2147	VB [VD]	



CM³



Art. Nr.



E-KLASSE (W124)							
E 320	06/93-06/95	M 104.992	3199	:→004356, 072236	0-N1011	VB [BT]	S
E 320	06/93-06/95	M 104.992	3199	:→004356, 072236	0-N1278	VB [TE]	
E 320	06/93-06/95	M 104.992	3199	:004357, 072237→	0-N1282	VB [TE]	
E 320	06/93-06/95	M 104.992	3199	Rippenanzahl: 6	0-N1283	VB [TE]	
E 320	06/93-06/95	M 104.992	3199	:004357, 072237→; :→005602, 102820	0-N1288	VB [DG]	
E 320	06/93-06/95	M 104.992	3199	:→004356, 072236	0-N2141	VB [TE]	
E 320	06/93-06/95	M 104.992	3199	:→004356, 072236	0-N2146	VB [VD]	
E 420	06/93-06/95	M 119.975, M 119.985	4196		0-N1860	VB [BT]	
E 420	06/93-06/95	M 119.975, M 119.985	4196		0-N2141	VB [TE]	
E 420	06/93-06/95	M 119.975, M 119.985	4196	für Fahrzeuge ohne Katalysator	0-N847	VB [TE]	
E 500	06/93-06/95	M 119.974	4973	:005782→	0-N1860	VB [BT]	
E 500	06/93-06/95	M 119.974	4973	:→005781	0-N1862	VB [BT]	
E 500	06/93-06/95	M 119.974	4973	:→005781; Rippenanzahl: 8	0-N1864	VB [DG]	
E 500	06/93-06/95	M 119.974	4973	:005782→	0-N2141	VB [TE]	
E 500	06/93-06/95	M 119.974	4973	für Fahrzeuge ohne Katalysator; :005782→	0-N847	VB [TE]	
E 200 D	06/93-06/95	OM 601.912	1997		0-N565592	FB [TE]	
E 300 Turbo-D, E 300 Turbo-D 4-matic	06/93-06/95	OM 603.960, OM 603.963	2996		0-N565592	FB [TE]	
E-KLASSE Cabriolet (A124)							
E 200	06/93-03/98	M 111.940	1998		0-N1703	VB [BT]	
E 200	06/93-03/98	M 111.940	1998		0-N1833	VB [TE]	
E 200	06/93-03/98	M 111.940	1998		0-N1951	VB [VD]	
E 200	06/93-03/98	M 111.940	1998		0-N2418	VB [BT]	
E 220	06/93-03/98	M 111.960	2199		0-N1703	VB [BT]	
E 220	06/93-03/98	M 111.960	2199		0-N1833	VB [TE]	
E 220	06/93-03/98	M 111.960	2199	→ 07/1996	0-N1951	VB [VD]	
E 220	06/93-03/98	M 111.960	2199		0-N2418	VB [BT]	
E 320	06/93-03/98	M 104.992, M 104.995	3199	:→004356, 072236	0-N1011	VB [BT]	S
E 320	06/93-03/98	M 104.992, M 104.995	3199	:→004356, 072236	0-N1278	VB [TE]	
E 320	06/93-03/98	M 104.992, M 104.995	3199	:004357, 072237→	0-N1282	VB [TE]	
E 320	06/93-03/98	M 104.992, M 104.995	3199		0-N1283	VB [TE]	
E 320	06/93-03/98	M 104.992, M 104.995	3199	Rippenanzahl: 6	0-N1288	VB [DG]	
E 320	06/93-03/98	M 104.992, M 104.995	3199	:004357, 072237→; :→005602, 102820	0-N2141	VB [TE]	
E 320	06/93-03/98	M 104.992, M 104.995	3199	:→004356, 072236	0-N2146	VB [VD]	
E 36 AMG	05/94-03/98	M 104.992 (AMG 3.6)	3606	:→004356, 072236	0-N1011	VB [BT]	S
E 36 AMG	05/94-03/98	M 104.992 (AMG 3.6)	3606	:→004356, 072236	0-N1278	VB [TE]	
E 36 AMG	05/94-03/98	M 104.992 (AMG 3.6)	3606	:004357, 072237→	0-N1282	VB [TE]	
E 36 AMG	05/94-03/98	M 104.992 (AMG 3.6)	3606		0-N1283	VB [TE]	
E 36 AMG	05/94-03/98	M 104.992 (AMG 3.6)	3606	Rippenanzahl: 6	0-N1288	VB [DG]	
E 36 AMG	05/94-03/98	M 104.992 (AMG 3.6)	3606	:004357, 072237→; :→005602, 102820	0-N2141	VB [TE]	
E 36 AMG	05/94-03/98	M 104.992 (AMG 3.6)	3606	:→004356, 072236	0-N2146	VB [VD]	
E-KLASSE Coupe (C124)							
E 200	06/93-06/97	M 111.940	1998		0-N1703	VB [BT]	
E 200	06/93-06/97	M 111.940	1998		0-N1833	VB [TE]	
E 200	06/93-06/97	M 111.940	1998	→ 07/1996	0-N1951	VB [VD]	
E 200	06/93-06/97	M 111.940	1998		0-N2418	VB [BT]	
E 220	06/93-06/97	M 111.960	2199		0-N1703	VB [BT]	
E 220	06/93-06/97	M 111.960	2199		0-N1833	VB [TE]	
E 220	06/93-06/97	M 111.960	2199	→ 07/1996	0-N1951	VB [VD]	
E 220	06/93-06/97	M 111.960	2199		0-N2418	VB [BT]	
E 320	06/93-06/97	M 104.992	3199	:→004356, 072236	0-N1011	VB [BT]	S
E 320	06/93-06/97	M 104.992	3199	:→004356, 072236	0-N1278	VB [TE]	
E 320	06/93-06/97	M 104.992	3199	:004357, 072237→	0-N1282	VB [TE]	
E 320	06/93-06/97	M 104.992	3199		0-N1283	VB [TE]	
E 320	06/93-06/97	M 104.992	3199	Rippenanzahl: 6	0-N1288	VB [DG]	
E 320	06/93-06/97	M 104.992	3199	:004357, 072237→; :→005602, 102820	0-N2141	VB [TE]	
E 320	06/93-06/97	M 104.992	3199	:→004356, 072237	0-N2146	VB [VD]	
E 36 AMG	06/93-06/97	M 104.992 (AMG 3.6)	3606	:→004356, 072236	0-N1011	VB [BT]	S
E 36 AMG	06/93-06/97	M 104.992 (AMG 3.6)	3606	:→004356, 072236	0-N1278	VB [TE]	
E 36 AMG	06/93-06/97	M 104.992 (AMG 3.6)	3606	:004357, 072237→	0-N1282	VB [TE]	
E 36 AMG	06/93-04/95	M 104.992 (AMG 3.6)	3606	:005603, 108821→	0-N1283	VB [TE]	
E 36 AMG	06/93-06/97	M 104.992 (AMG 3.6)	3606	Rippenanzahl: 6	0-N1288	VB [DG]	

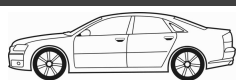

CM³



Art. Nr.



E-KLASSE Coupe (C124)							
E 36 AMG	06/93-06/97	M 104.992 (AMG 3.6)	3606	ENGINE:→004357, 072237→; ENGINE:→005602, 102820	0-N2141	VB [TE]	
E 36 AMG	06/93-04/95	M 104.992 (AMG 3.6)	3606	ENGINE:→004356, 072237	0-N2146	VB [VD]	
E 36 AMG	05/94-06/97	M 104.992 (AMG 3.6)	3606		0-N1283	VB [TE]	
E 36 AMG	05/94-06/97	M 104.992 (AMG 3.6)	3606	ENGINE:→004356, 072236	0-N2146	VB [VD]	
E-KLASSE Kombi (S124)							
E 200 T	06/93-06/96	M 111.940	1998		0-N1703	VB [BT]	
E 200 T	06/93-06/96	M 111.940	1998		0-N1833	VB [TE]	
E 200 T	06/93-06/96	M 111.940	1998	→ 01/1996	0-N1951	VB [VD]	
E 200 T	06/93-06/96	M 111.940	1998		0-N2418	VB [BT]	
E 220 T	06/93-06/96	M 111.960	2199		0-N1703	VB [BT]	
E 220 T	06/93-06/96	M 111.960	2199		0-N1833	VB [TE]	
E 220 T	06/93-06/96	M 111.960	2199	→ 01/1996	0-N1951	VB [VD]	
E 220 T	06/93-06/96	M 111.960	2199		0-N2418	VB [BT]	
E 250 T D , E 250 Turbo D	06/93-06/96	OM 602.962, OM 605.911	2497		0-N1043	VB [BT]	
E 250 T D , E 250 Turbo D	06/93-06/96	OM 602.962, OM 605.911	2497		0-N2147	VB [VD]	
E 250 T D , E 250 Turbo D	06/93-06/96	OM 602.962, OM 605.911	2497		0-N846	VB [TE]	
E 280 T	06/93-06/96	M 104.942	2799	ENGINE:→005789, 048696	0-N1011	VB [BT]	S
E 280 T	06/93-06/96	M 104.942	2799	ENGINE:→005789, 048696	0-N1278	VB [TE]	
E 280 T	06/93-06/96	M 104.942	2799	ENGINE:→005790, 048697→	0-N1282	VB [TE]	
E 280 T	06/93-06/96	M 104.942	2799	Rippenanzahl: 6	0-N1288	VB [DG]	
E 280 T	06/93-06/96	M 104.942	2799	ENGINE:→005790, 048697→	0-N2141	VB [TE]	
E 280 T	06/93-06/96	M 104.942	2799	ENGINE:→005789, 048696	0-N2146	VB [VD]	
E 300 T 4-matic , E 300 TE-24 AMG	06/93-06/96	M 103.985, M 104.980	2960		0-N1011	VB [BT]	S
E 300 T 4-matic , E 300 TE-24 AMG	06/93-06/96	M 103.985, M 104.980	2960		0-N1278	VB [TE]	
E 300 T 4-matic , E 300 TE-24 AMG	06/93-06/96	M 103.985, M 104.980	2960		0-N2146	VB [VD]	
E 300 T D	06/93-06/96	OM 606.910	2996		0-N1043	VB [BT]	
E 300 T D	06/93-06/96	OM 606.910	2996		0-N2147	VB [VD]	
E 300 T D , E 300 T Turbo-D , E 300 T Turbo-D 4-matic	06/93-06/96	OM 603.960, OM 603.963, OM 606.910	2996		0-N846	VB [TE]	
E 300 T Turbo-D , E 300 T Turbo-D 4-matic	06/93-06/96	OM 603.960, OM 603.963	2996	ENGINE:→004191→	0-N1043	VB [BT]	
E 300 T Turbo-D , E 300 T Turbo-D 4-matic	06/93-06/96	OM 603.960, OM 603.963	2996	ENGINE:→048697→	0-N1043	VB [BT]	
E 300 T Turbo-D , E 300 T Turbo-D 4-matic	06/93-06/96	OM 603.960, OM 603.963	2996	ENGINE:→004190, 049508	0-N1289	VB [BT]	
E 300 T Turbo-D , E 300 T Turbo-D 4-matic	06/93-06/96	OM 603.960, OM 603.963	2996	ENGINE:→004190, 049508; hydraulisch	0-N1926	VB [VD]	
E 300 T Turbo-D , E 300 T Turbo-D 4-matic	06/93-06/96	OM 603.960, OM 603.963	2996	ENGINE:→004191→	0-N2147	VB [VD]	
E 300 T Turbo-D , E 300 T Turbo-D 4-matic	06/93-06/96	OM 603.960, OM 603.963	2996	ENGINE:→048697→	0-N2147	VB [VD]	
E 300 TE-24 AMG	06/93-06/96	M 104.980	2960	ENGINE:→21004	0-N847	VB [TE]	
E 300 TE-24 AMG	06/93-06/96	M 104.980	2960	ENGINE:→4956	0-N847	VB [TE]	
E 320 T	06/93-06/96	M 104.992	3199	ENGINE:→004356, 072236	0-N1011	VB [BT]	S
E 320 T	06/93-06/96	M 104.992	3199	ENGINE:→004356, 072236	0-N1278	VB [TE]	
E 320 T	06/93-06/96	M 104.992	3199	ENGINE:→004357, 072237→	0-N1282	VB [TE]	
E 320 T	06/93-06/96	M 104.992	3199		0-N1283	VB [TE]	
E 320 T	06/93-06/96	M 104.992	3199	Rippenanzahl: 6	0-N1288	VB [DG]	
E 320 T	06/93-06/96	M 104.992	3199	ENGINE:→004357, 072237→; ENGINE:→005602, 102820	0-N2141	VB [TE]	
E 320 T	06/93-06/96	M 104.992	3199	ENGINE:→004356, 072236	0-N2146	VB [VD]	
E 36 T AMG	05/94-06/96	M 104.992 (AMG 3.6)	3606	ENGINE:→004356, 072236	0-N1011	VB [BT]	S
E 36 T AMG	05/94-06/96	M 104.992 (AMG 3.6)	3606	ENGINE:→004356, 072236	0-N1278	VB [TE]	
E 36 T AMG	05/94-06/96	M 104.992 (AMG 3.6)	3606	ENGINE:→004357, 072237→	0-N1282	VB [TE]	
E 36 T AMG	05/94-06/96	M 104.992 (AMG 3.6)	3606		0-N1283	VB [TE]	
E 36 T AMG	05/94-06/96	M 104.992 (AMG 3.6)	3606	Rippenanzahl: 6	0-N1288	VB [DG]	
E 36 T AMG	05/94-06/96	M 104.992 (AMG 3.6)	3606	ENGINE:→004357, 072237→; ENGINE:→005602, 102820	0-N2141	VB [TE]	
E 36 T AMG	05/94-06/96	M 104.992 (AMG 3.6)	3606	ENGINE:→004356, 072236	0-N2146	VB [VD]	
E 300 T Turbo-D , E 300 T Turbo-D 4-matic	06/93-06/96	OM 603.960, OM 603.963	2996		0-N565592	FB [TE]	
E-KLASSE (W210)							
E 200 , E 200 Kompressor	06/95-03/02	M 111.942, M 111.947, M 111.957	1998		0-N1703	VB [BT]	
E 200 , E 200 Kompressor	06/95-03/02	M 111.942, M 111.947, M 111.957	1998		0-N1833	VB [TE]	
E 200 , E 200 Kompressor	06/95-03/02	M 111.942, M 111.957	1998		0-N1951	VB [VD]	
E 200 , E 200 Kompressor	06/95-03/02	M 111.942, M 111.947, M 111.957	1998		0-N2418	VB [BT]	



OPTIMAL®

MERCEDES-BENZ



CM³



Art. Nr.



E-KLASSE (W210)

E 200 CDI , E 220 CDI	06/98-03/02	OM 611.961	2151	Rippenanzahl: 6	0-N1431	VB [DG]	
E 200 CDI , E 220 CDI	06/98-03/02	OM 611.961	2151		0-N1641	VB [BT]	S
E 200 CDI , E 220 CDI	07/99-03/02	OM 611.961	2148	Rippenanzahl: 6	0-N1431	VB [DG]	
E 200 CDI , E 220 CDI	07/99-03/02	OM 611.961	2148		0-N1641	VB [BT]	S
E 200 D	01/96-03/02	OM 604.917	1997		0-N1043	VB [BT]	
E 200 D	01/96-03/02	OM 604.917	1997		0-N2147	VB [VD]	
E 200 D	01/96-03/02	OM 604.917	1997		0-N846	VB [TE]	
E 200 Kompressor	06/97-03/02	M 111.947, M 111.957	1998		0-N1442	VB [DG]	
E 200 Kompressor	06/97-03/02	M 111.947	1998	→ 06/2000	0-N1951	VB [VD]	
E 200 Kompressor	06/97-03/02	M 111.947	1998		0-N2141	VB [TE]	
E 200 Kompressor	06/97-03/02	M 111.947, M 111.957	1998		0-N2148	VB [BT]	
E 200 Kompressor	08/00-03/02	M 111.957	1998		0-N1283	VB [TE]	
E 220 D	06/95-03/02	OM 604.912	2155		0-N1043	VB [BT]	
E 220 D	06/95-03/02	OM 604.912	2155		0-N2147	VB [VD]	
E 220 D	06/95-03/02	OM 604.912	2155		0-N846	VB [TE]	
E 230	06/95-06/97	M 111.970	2295		0-N1703	VB [BT]	
E 230	06/95-06/97	M 111.970	2295		0-N1833	VB [TE]	
E 230	06/95-06/97	M 111.970	2295		0-N1951	VB [VD]	
E 230	06/95-06/97	M 111.970	2295		0-N2418	VB [BT]	
E 240	06/97-08/00	M 112.911	2398	Rippenanzahl: 6	0-N1431	VB [DG]	
E 240	06/97-08/00	M 112.911	2398		0-N1645	VB [BT]	S
E 240	06/97-08/00	M 112.911	2398		0-N2142	VB [VD]	
E 240	08/00-03/02	M 112.914	2597	Rippenanzahl: 6	0-N1431	VB [DG]	
E 240	08/00-03/02	M 112.914	2597		0-N1645	VB [BT]	S
E 240	08/00-03/02	M 112.914	2597		0-N2142	VB [VD]	
E 250 D , E 250 Turbo-D	06/95-07/99	OM 605.912, OM 605.962	2497		0-N1043	VB [BT]	
E 250 D , E 250 Turbo-D	06/95-07/99	OM 605.912, OM 605.962	2497		0-N2147	VB [VD]	
E 250 D , E 250 Turbo-D	06/95-07/99	OM 605.912, OM 605.962	2497		0-N846	VB [TE]	
E 270 CDI	07/99-03/02	OM 612.961	2685	Rippenanzahl: 6	0-N1431	VB [DG]	
E 270 CDI	07/99-03/02	OM 612.961	2685		0-N1641	VB [BT]	S
E 280	01/96-06/97	M 104.945	2799		0-N1282	VB [TE]	
E 280	01/96-06/97	M 104.945	2799		0-N1283	VB [TE]	
E 280	01/96-06/97	M 104.945	2799	Rippenanzahl: 6	0-N1288	VB [DG]	
E 280	01/96-06/97	M 104.945	2799	EMERGENCY: →000500, 000627	0-N2141	VB [TE]	
E 280 , E 280 4-matic	12/96-03/02	M 112.921	2799	Rippenanzahl: 6	0-N1431	VB [DG]	
E 280 , E 280 4-matic	12/96-03/02	M 112.921	2799		0-N1645	VB [BT]	S
E 280 , E 280 4-matic	12/96-03/02	M 112.921	2799		0-N2142	VB [VD]	
E 290 Turbo-D	03/96-07/99	OM 602.982	2874		0-N1043	VB [BT]	
E 290 Turbo-D	03/96-07/99	OM 602.982	2874		0-N2147	VB [VD]	
E 290 Turbo-D	03/96-07/99	OM 602.982	2874		0-N846	VB [TE]	
E 290 Turbo-D	03/96-07/99	OM 602.982	2874	⚠	0-N847	VB [TE]	
E 300 D , E 300 Turbo-D	06/95-07/99	OM 606.912, OM 606.962	2996		0-N1043	VB [BT]	
E 300 D , E 300 Turbo-D	06/95-07/99	OM 606.912, OM 606.962	2996		0-N2147	VB [VD]	
E 300 D , E 300 Turbo-D	06/95-07/99	OM 606.912, OM 606.962	2996		0-N846	VB [TE]	
E 320	06/95-06/97	M 104.992, M 104.995	3199	EMERGENCY: →004356, 072236	0-N1011	VB [BT]	S
E 320	06/95-06/97	M 104.992, M 104.995	3199		0-N1282	VB [TE]	
E 320	06/95-06/97	M 104.992, M 104.995	3199		0-N1283	VB [TE]	
E 320	06/95-06/97	M 104.992, M 104.995	3199	Rippenanzahl: 6	0-N1288	VB [DG]	
E 320	06/95-06/97	M 104.992, M 104.995	3199	EMERGENCY: →034379	0-N2141	VB [TE]	
E 320 , E 320 4-matic	06/97-03/02	M 112.941	3199	Rippenanzahl: 6	0-N1431	VB [DG]	
E 320 , E 320 4-matic	06/97-03/02	M 112.941	3199		0-N1645	VB [BT]	S
E 320 , E 320 4-matic	06/97-03/02	M 112.941	3199		0-N2142	VB [VD]	
E 320 CDI	07/99-03/02	OM 613.961	3226	Rippenanzahl: 6	0-N1431	VB [DG]	
E 320 CDI	07/99-03/02	OM 613.961	3226		0-N1641	VB [BT]	S
E 420	01/96-06/97	M 119.985	4196	Rippenanzahl: 6	0-N1288	VB [DG]	
E 420	01/96-06/97	M 119.985	4196		0-N1860	VB [BT]	
E 420	01/96-06/97	M 119.985	4196		0-N2141	VB [TE]	
E 430 , E 430 4-matic	06/97-03/02	M 113.940	4266	Rippenanzahl: 6	0-N1431	VB [DG]	
E 430 , E 430 4-matic	06/97-03/02	M 113.940	4266		0-N1645	VB [BT]	S
E 430 , E 430 4-matic	06/97-03/02	M 113.940	4266		0-N2142	VB [VD]	
E 50 AMG	02/96-08/97	M 119.985 (AMG 5.0)	4973	Rippenanzahl: 6	0-N1288	VB [DG]	
E 50 AMG	02/96-08/97	M 119.985 (AMG 5.0)	4973		0-N1860	VB [BT]	
E 50 AMG	02/96-08/97	M 119.985 (AMG 5.0)	4973		0-N2141	VB [TE]	
E 55 AMG , E 55 AMG 4-matic	08/97-03/02	M 113.980	5439	Rippenanzahl: 6	0-N1431	VB [DG]	
E 55 AMG , E 55 AMG 4-matic	08/97-03/02	M 113.980	5439		0-N1645	VB [BT]	S



CM³



Art. Nr.



ohne Halter

E-KLASSE Kombi (S210)							
E 200 T , E 200 T Kompressor	06/96-03/03	M 111.942, M 111.947, M 111.957	1998			0-N1703	VB [BT]
E 200 T , E 200 T Kompressor	06/96-03/03	M 111.942, M 111.947, M 111.957	1998			0-N1833	VB [TE]
E 200 T , E 200 T Kompressor	06/96-03/03	M 111.942, M 111.957	1998			0-N1951	VB [VD]
E 200 T , E 200 T Kompressor	06/96-03/03	M 111.942, M 111.947, M 111.957	1998			0-N2418	VB [BT]
E 200 T Kompressor	06/97-03/03	M 111.947, M 111.957	1998			0-N1442	VB [DG]
E 200 T Kompressor	06/97-03/03	M 111.947	1998	11/1997 → 07/2000		0-N1951	VB [VD]
E 200 T Kompressor	06/97-03/03	M 111.947	1998			0-N2141	VB [TE]
E 200 T Kompressor	06/97-03/03	M 111.947, M 111.957	1998			0-N2148	VB [BT]
E 200 T Kompressor	08/00-03/03	M 111.957	1998			0-N1283	VB [TE]
E 220 T CDI	06/98-07/99	OM 611.961	2151	Rippenanzahl: 6		0-N1431	VB [DG]
E 220 T CDI	06/98-07/99	OM 611.961	2151			0-N1641	VB [BT] S
E 220 T CDI	07/99-03/03	OM 611.961	2148	Rippenanzahl: 6		0-N1431	VB [DG]
E 220 T CDI	07/99-03/03	OM 611.961	2148			0-N1641	VB [BT] S
E 230 T	06/96-06/97	M 111.970	2295			0-N1703	VB [BT]
E 230 T	06/96-06/97	M 111.970	2295			0-N1833	VB [TE]
E 230 T	06/96-06/97	M 111.970	2295			0-N1951	VB [VD]
E 230 T	06/96-06/97	M 111.970	2295			0-N2418	VB [BT]
E 240 T	06/97-03/03	M 112.911	2398	Rippenanzahl: 6		0-N1431	VB [DG]
E 240 T	06/97-03/03	M 112.911	2398			0-N1645	VB [BT] S
E 240 T	06/97-03/03	M 112.911	2398			0-N2142	VB [VD]
E 240 T	08/00-03/03	M 112.914	2597	Rippenanzahl: 6		0-N1431	VB [DG]
E 240 T	08/00-03/03	M 112.914	2597			0-N1645	VB [BT] S
E 240 T	08/00-03/03	M 112.914	2597			0-N2142	VB [VD]
E 250 T D , E 250 T Turbo-D	06/96-07/99	OM 605.912, OM 605.962	2497			0-N1043	VB [BT]
E 250 T D , E 250 T Turbo-D	06/96-07/99	OM 605.912, OM 605.962	2497			0-N2147	VB [VD]
E 250 T D , E 250 T Turbo-D	06/96-07/99	OM 605.912, OM 605.962	2497			0-N846	VB [TE]
E 270 T CDI	07/99-03/03	OM 612.961	2685	Rippenanzahl: 6		0-N1431	VB [DG]
E 270 T CDI	07/99-03/03	OM 612.961	2685			0-N1641	VB [BT] S
E 280 T , E 280 T 4-matic	12/96-03/03	M 112.921	2799	Rippenanzahl: 6		0-N1431	VB [DG]
E 280 T , E 280 T 4-matic	12/96-03/03	M 112.921	2799			0-N1645	VB [BT] S
E 280 T , E 280 T 4-matic	12/96-03/03	M 112.921	2799			0-N2142	VB [VD]
E 290 T Turbo-D	06/96-07/99	OM 602.982	2874			0-N1043	VB [BT]
E 290 T Turbo-D	06/96-07/99	OM 602.982	2874			0-N2147	VB [VD]
E 290 T Turbo-D	06/96-07/99	OM 602.982	2874			0-N846	VB [TE]
E 290 T Turbo-D	06/96-07/99	OM 602.982	2874	✳		0-N847	VB [TE]
E 300 T Turbo-D	12/96-07/99	OM 606.962	2996			0-N1043	VB [BT]
E 300 T Turbo-D	12/96-07/99	OM 606.962	2996			0-N2147	VB [VD]
E 300 T Turbo-D	12/96-07/99	OM 606.962	2996			0-N846	VB [TE]
E 320 T , E 320 T 4-matic	12/96-03/03	M 112.941	3199	Rippenanzahl: 6		0-N1431	VB [DG]
E 320 T , E 320 T 4-matic	12/96-03/03	M 112.941	3199			0-N1645	VB [BT] S
E 320 T , E 320 T 4-matic	12/96-03/03	M 112.941	3199			0-N2142	VB [VD]
E 320 T CDI	07/99-03/03	OM 613.961	3226	Rippenanzahl: 6		0-N1431	VB [DG]
E 320 T CDI	07/99-03/03	OM 613.961	3226			0-N1641	VB [BT] S
E 420 T	06/96-06/97	M 119.985	4196	Rippenanzahl: 6		0-N1288	VB [DG]
E 420 T	06/96-06/97	M 119.985	4196			0-N1860	VB [BT]
E 420 T	06/96-06/97	M 119.985	4196			0-N2141	VB [TE]
E 430 T , E 430 T 4-matic	06/97-03/03	M 113.940	4266	Rippenanzahl: 6		0-N1431	VB [DG]
E 430 T , E 430 T 4-matic	06/97-03/03	M 113.940	4266			0-N1645	VB [BT] S
E 430 T , E 430 T 4-matic	06/97-03/03	M 113.940	4266			0-N2142	VB [VD]
E 55 T AMG , E 55 T AMG 4-matic	08/97-03/03	M 113.980	5439	Rippenanzahl: 6		0-N1431	VB [DG]
E 55 T AMG , E 55 T AMG 4-matic	08/97-03/03	M 113.980	5439			0-N1645	VB [BT] S
E-KLASSE (W211)							
E200 NGT	03/04-12/08	M 271.941	1796			0-N1256	TB [TE]
3.5 4-matic	08/04-08/06	M 272.972	3498	→ 02/2005; → 30058376		0-N1746	VB [DG]
3.5 4-matic	08/04-08/06	M 272.972	3498	02/2005 →; : 30058377 →		0-N2138	VB [DG]
3.5 4-matic, E 350 , E 350 4-matic , E 350 CGI	08/04-12/08	M 272.964, M 272.972, M 272.985	3498	Rippenanzahl: 6		0-N1637	VB [DG]
3.5 4-matic, E 350 , E 350 4-matic , E 350 CGI	08/04-12/08	M 272.964, M 272.972, M 272.985	3498			0-N1670	VB [BT] S
3.5 4-matic, E 350 , E 350 4-matic , E 350 CGI	08/04-12/08	M 272.964, M 272.972, M 272.985	3498			0-N2143	VB [VD]
E 200 CDI , E 220 CDI	03/02-12/08	OM 646.820, OM 646.821, OM 646.951, OM 646.961	2148	Rippenanzahl: 6		0-N1431	VB [DG]
E 200 CDI , E 220 CDI	03/02-12/08	OM 646.951, OM 646.961	2148	→ 06/2003;		0-N1489S	VB [TE]
E 200 CDI , E 220 CDI	03/02-12/08	OM 646.951, OM 646.961	2148	06/2003 →		0-N1641	VB [BT] S
E 200 CDI , E 220 CDI	04/06-12/08	OM 646.820, OM 646.821	2148			0-N1641	VB [BT] S



OPTIMAL®

MERCEDES-BENZ



CM³



Art. Nr.



E-KLASSE (W211)							
E 200 CGI, E 200 Kompressor, E200 NGT	11/02-12/08	M 271.941, M 271.946, M 271.956	1796	†		0-N1457	VB [DG]
E 200 CGI, E 200 Kompressor, E200 NGT	11/02-12/08	M 271.941, M 271.946, M 271.956	1796			0-N1587	VB [BT] S
E 200 CGI, E 200 Kompressor, E200 NGT	11/02-12/08	M 271.941, M 271.946, M 271.956	1796			0-N2206	VB [DG]
E 220 CDI	03/03-12/08	OM 646.821	2149			0-N1641	VB [BT] S
E 230	09/07-12/08	M 272.922	2496	Rippenanzahl: 6		0-N1637	VB [DG]
E 230	09/07-12/08	M 272.922	2496			0-N1670	VB [BT] S
E 230	09/07-12/08	M 272.922	2496			0-N2138	VB [DG]
E 230	09/07-12/08	M 272.922	2496	†		0-N2143	VB [VD]
E 240, E 240 4-matic	03/02-12/08	M 112.913, M 112.917, M 112.917	2597	Rippenanzahl: 6		0-N1431	VB [DG]
E 240, E 240 4-matic	03/02-12/08	M 112.913, M 112.917, M 112.917	2597			0-N1645	VB [BT] S
E 240, E 240 4-matic	03/02-12/08	M 112.913, M 112.917, M 112.917	2597	†		0-N2142	VB [VD]
E 270 CDI	03/02-12/08	OM 647.961	2685	Rippenanzahl: 6		0-N1431	VB [DG]
E 270 CDI	03/02-12/08	OM 647.961	2685	→ 07/2003; †		0-N1489S	VB [TE]
E 270 CDI	03/02-12/08	OM 647.961	2685	07/2003 →		0-N1641	VB [BT] S
E 280	03/05-12/08	M 272.943	2996	†: → 30058376		0-N1746	VB [DG]
E 280, E 280 4-matic	03/05-12/08	M 272.943	2996	Rippenanzahl: 6		0-N1637	VB [DG]
E 280, E 280 4-matic	03/05-12/08	M 272.943	2996			0-N1670	VB [BT] S
E 280, E 280 4-matic	03/05-12/08	M 272.943	2996			0-N2138	VB [DG]
E 280, E 280 4-matic	03/05-12/08	M 272.943	2996	†		0-N2143	VB [VD]
E 280 CDI, E 280 CDI 4-matic, E 300 BlueTEC, E 320 CDI, E 320 CDI 4-matic	03/05-12/08	OM 642.910, OM 642.920, OM 642.921	2987			0-N1560	VB [DG]
E 280 CDI, E 280 CDI 4-matic, E 300 BlueTEC, E 320 CDI, E 320 CDI 4-matic	03/05-12/08	OM 642.910, OM 642.920, OM 642.921	2987			0-N1902	VB [BT] S
E 280 CDI, E 320 CDI	11/02-12/08	OM 648.961	3222	Rippenanzahl: 6		0-N1431	VB [DG]
E 280 CDI, E 320 CDI	11/02-12/08	OM 648.961	3222			0-N1641	VB [BT] S
E 320, E 320 4-matic	03/02-12/08	M 112.949, M 112.954	3199	Rippenanzahl: 6		0-N1431	VB [DG]
E 320, E 320 4-matic	03/02-12/08	M 112.949, M 112.954	3199			0-N1645	VB [BT] S
E 350, E 350 4-matic, E 350 CGI	03/05-12/08	M 272.964, M 272.972, M 272.985	3498			0-N2138	VB [DG]
E 400 CDI	02/03-12/08	OM 628.961	3996			0-N2193	VB [BT] S
E 400 CDI	02/03-12/08	OM 628.961	3996			0-N2218	VB [DG]
E 500, E 500 4-matic	03/02-12/08	M 113.967, M 113.969	4966	Rippenanzahl: 6		0-N1431	VB [DG]
E 500, E 500 4-matic	03/02-12/08	M 113.967, M 113.969	4966			0-N1645	VB [BT] S
E 500, E 500 4-matic	04/06-12/08	M 273.960, M 273.962	5461	Rippenanzahl: 6		0-N1637	VB [DG]
E 500, E 500 4-matic	04/06-12/08	M 273.960, M 273.962	5461			0-N1670	VB [BT] S
E 500, E 500 4-matic	04/06-12/08	M 273.960, M 273.962	5461			0-N2138	VB [DG]
E 55 AMG Kompressor	10/02-12/08	M 113.990	5439			0-N1645	VB [BT] S
E 63 AMG	03/06-12/08	M 156.983	6208	Rippenanzahl: 6		0-N2120	VB [DG]
E-KLASSE Kombi (S211)							
350 CGI, E 350 T, E 350 T 4-matic	03/05-07/09	M 272.964, M 272.972, M 272.985	3498	Rippenanzahl: 6		0-N1637	VB [DG]
350 CGI, E 350 T, E 350 T 4-matic	03/05-07/09	M 272.964, M 272.972, M 272.985	3498			0-N1670	VB [BT] S
350 CGI, E 350 T, E 350 T 4-matic	03/05-07/09	M 272.964, M 272.972, M 272.985	3498			0-N2138	VB [DG]
350 CGI, E 350 T, E 350 T 4-matic	03/05-07/09	M 272.964, M 272.972, M 272.985	3498	†		0-N2143	VB [VD]
E 200 CDI, E 220 CDI, E 220 T CDI	03/03-07/09	OM 646.821, OM 646.961	2148	Rippenanzahl: 6		0-N1431	VB [DG]
E 200 CDI, E 220 T CDI	03/03-07/09	OM 646.821	2148			0-N1641	VB [BT] S
E 200 Kompressor, E 200 T Kompressor	03/03-07/09	M 271.941, M 271.956	1796	†		0-N1457	VB [DG]
E 200 Kompressor, E 200 T Kompressor	03/03-07/09	M 271.941, M 271.956	1796	→ 03/2009		0-N1587	VB [BT] S
E 200 Kompressor, E 200 T Kompressor	03/03-07/09	M 271.941, M 271.956	1796			0-N2136	VB [BT] S
E 200 Kompressor, E 200 T Kompressor	03/03-07/09	M 271.941, M 271.956	1796			0-N2206	VB [DG]
E 220 CDI, E 220 T CDI	03/03-07/09	OM 646.961	2148	→ 06/2003; †		0-N1489S	VB [TE]
E 220 CDI, E 220 T CDI	03/03-07/09	OM 646.961	2148	06/2003 →		0-N1641	VB [BT] S
E 230 T	05/07-07/09	M 272.922	2496	Rippenanzahl: 6		0-N1637	VB [DG]
E 230 T	05/07-07/09	M 272.922	2496			0-N1670	VB [BT] S
E 230 T	05/07-07/09	M 272.922	2496			0-N2138	VB [DG]
E 230 T	05/07-07/09	M 272.922	2496	†		0-N2143	VB [VD]
E 240 T, E 240 T 4-matic	03/03-07/09	M 112.913, M 112.917	2597	Rippenanzahl: 6		0-N1431	VB [DG]
E 240 T, E 240 T 4-matic	03/03-07/09	M 112.913, M 112.917	2597			0-N1645	VB [BT] S
E 240 T, E 240 T 4-matic	03/03-07/09	M 112.913, M 112.917	2597	†		0-N2142	VB [VD]
E 270 T CDI	03/03-07/09	OM 647.961	2685	Rippenanzahl: 6		0-N1431	VB [DG]
E 270 T CDI	03/03-07/09	OM 647.961	2685	→ 07/2003; †		0-N1489S	VB [TE]
E 270 T CDI	03/03-07/09	OM 647.961	2685	07/2003 →		0-N1641	VB [BT] S
E 280 T, E 280 T 4-matic	03/05-07/09	M 272.943	2996	Rippenanzahl: 6		0-N1637	VB [DG]
E 280 T, E 280 T 4-matic	03/05-07/09	M 272.943	2996			0-N1670	VB [BT] S
E 280 T, E 280 T 4-matic	03/05-07/09	M 272.943	2996			0-N2138	VB [DG]



CM³



Art. Nr.



ohne Halter

E-KLASSE Kombi (S211)							
E 280 T , E 280 T 4-matic	03/05-07/09	M 272.943	2996			0-N2143	VB [VD]
E 280 T CDI , E 280 T CDI 4-matic , E 320 T CDI , E 320 T CDI 4-matic	03/05-07/09	OM 642.920, OM 642.921	2987			0-N1560	VB [DG]
E 280 T CDI , E 280 T CDI 4-matic , E 320 T CDI , E 320 T CDI 4-matic	03/05-07/09	OM 642.920, OM 642.921	2987			0-N1902	VB [BT] S
E 280 T CDI , E 320 T CDI	03/03-07/09	OM 648.961	3222	Rippenanzahl: 6		0-N1431	VB [DG]
E 280 T CDI , E 320 T CDI	03/03-07/09	OM 648.961	3222			0-N1641	VB [BT] S
E 320 T , E 320 T 4-matic	03/03-07/09	M 112.949, M 112.954	3199	Rippenanzahl: 6		0-N1431	VB [DG]
E 320 T , E 320 T 4-matic	03/03-07/09	M 112.949, M 112.954	3199			0-N1645	VB [BT] S
E 500 T , E 500 T 4-matic	10/03-07/09	M 113.967, M 113.969	4966	Rippenanzahl: 6		0-N1431	VB [DG]
E 500 T , E 500 T 4-matic	10/03-07/09	M 113.967, M 113.969	4966			0-N1645	VB [BT] S
E 500 T , E 500 T 4-matic	04/06-07/09	M 273.960, M 273.962	5461	Rippenanzahl: 6		0-N1637	VB [DG]
E 500 T , E 500 T 4-matic	04/06-07/09	M 273.960, M 273.962	5461			0-N1670	VB [BT] S
E 500 T , E 500 T 4-matic	04/06-07/09	M 273.960, M 273.962	5461			0-N2138	VB [DG]
E 55 T AMG Kompressor	07/03-07/09	M 113.990	5439			0-N1645	VB [BT] S
E 63 AMG	03/06-07/09	M 156.983	6208	Rippenanzahl: 6		0-N2120	VB [DG]
E-KLASSE (W212)							
E 200 CDI , E 220 BlueTEC, E 220 BlueTEC 4-matic, E 220 CDI , E 250 CDI , E 250 CDI 4-matic	01/09-	OM 651.924, OM 651.925	2143	für Fahrzeuge mit Start-Stopp-Funktion		0-N2422	VB [BT] S
E 200 CDI , E 220 BlueTEC, E 220 CDI , E 250 CDI , E 250 CDI 4-matic , E 300 Hybrid	01/09-	OM 651.924, OM 651.925	2143			0-N2205	VB [DG]
E 200 CDI , E 220 BlueTEC, E 220 CDI , E 250 CDI , E 250 CDI 4-matic , E 300 Hybrid	01/09-	OM 651.924, OM 651.925	2143	für Fahrzeuge mit Hybridantrieb		0-N2306	VB [BT] S
E 200 CDI , E 220 CDI , E 250 CDI	01/09-	OM 651.924, OM 651.925	2143	für Fahrzeuge ohne Start-Stopp-Funktion		0-N2083	VB [BT] S
E 200 CDI , E 220 CDI , E 250 CDI , E 250 CDI 4-matic , E 300 Hybrid	01/09-	OM 651.924, OM 651.925	2143			0-N2238	VB [DG]
E 200 CGI , E 250 CGI	01/09-	M 271.820, M 271.860, M 271.860	1796			0-N2119	VB [DG]
E 200 CGI , E 250 CGI	01/09-	M 271.820, M 271.860, M 271.860	1796	Rippenanzahl: 6		0-N2120	VB [DG]
E 200 CGI , E 250 CGI	01/09-	M 271.820, M 271.860, M 271.860	1796			0-N2136	VB [BT] S
E 200 NGT	03/11-	M 271.958	1796			0-N1457	VB [DG]
E 200 NGT	03/11-	M 271.958	1796			0-N2206	VB [DG]
E 200 , E 200 NGT, E 250	01/13-	M 274.920	1991			0-N2309	VB [BT] S
E 200 , E 200 NGT, E 250	01/13-	M 274.920	1991			0-N2310	VB [DG]
E 250 CDI 4-matic	01/09-	OM 651.924	2143	01/2011 →; für Fahrzeuge ohne Start-Stopp-Funktion		0-N2083	VB [BT] S
E 300	01/09-	M 272.952	2996			0-N2138	VB [DG]
E 300	01/09-	M 272.952	2996			0-N2143	VB [VD]
E 300 , E 300 4-matic , E 350 , E 350 4-matic , E 400 , E 400 4-matic	07/11-	M 276.850, M 276.952	3498			0-N2368	VB [DG]
E 300 , E 300 4-matic , E 350 , E 350 4-matic , E 400 , E 400 4-matic	07/11-	M 276.850, M 276.952	3498			0-N2403	VB [BT] S
E 300 CDI	03/11-	OM 642.852	2987	für Fahrzeuge mit Start-Stopp-Funktion		0-N2293	VB [BT] S
E 300 CDI , E 350 BlueTEC , E 350 BlueTEC 4-matic, E 350 CDI , E 350 CDI 4-matic	01/09-12/10	OM 642.850, OM 642.850, OM 642.852, OM 642.852, OM 642.852, OM 642.858, OM 642.856, OM 642.858	2987			0-N1560	VB [DG]
E 300 CDI , E 350 BlueTEC , E 350 CDI , E 350 CDI 4-matic	01/09-	OM 642.850, OM 642.850, OM 642.852, OM 642.852, OM 642.856, OM 642.858	2987			0-N1902	VB [BT] S
E 350 , E 350 4-matic , E 350 CGI	01/09-08/11	M 272.977, M 272.980, M 272.982, M 272.983	3498			0-N2138	VB [DG]
E 350 , E 350 4-matic , E 350 CGI	01/09-08/11	M 272.977, M 272.980, M 272.982, M 272.983	3498			0-N2143	VB [VD]
E 350 4-matic , E 350 CGI	01/09-08/11	M 272.977, M 272.982, M 272.983	3498	Rippenanzahl: 6		0-N1637	VB [DG]
E 350 4-matic , E 350 CGI	01/09-08/11	M 272.977, M 272.982, M 272.983	3498			0-N1670	VB [BT] S
E 350 BlueTEC, E 350 BlueTEC 4-matic, E 350 CDI , E 350 CDI 4-matic	03/11-	OM 642.852, OM 642.852, OM 642.858, OM 642.858	2987	für Fahrzeuge mit Start-Stopp-Funktion		0-N2293	VB [BT] S
E 400 , E 400 4-matic	01/13-	M 276.820	2996			0-N2368	VB [DG]
E 400 , E 400 4-matic	01/13-	M 276.820	2996			0-N2403	VB [BT] S
E 500 , E 500 4-matic	01/09-	M 273.970, M 273.971	5461	Rippenanzahl: 6		0-N1637	VB [DG]
E 500 , E 500 4-matic	01/09-	M 273.970, M 273.971	5461			0-N1670	VB [BT] S
E 500 , E 500 4-matic	01/09-	M 273.970, M 273.971	5461			0-N2138	VB [DG]
E 500 , E 500 4-matic	09/11-	M 278.922	4663			0-N2284	VB [DG]
E 63 AMG	12/09-	M 156.985	6208	Rippenanzahl: 6		0-N2120	VB [DG]
E 63 AMG	02/11-	M 157.981	5461			0-N2284	VB [DG]
E 63 AMG	02/11-	M 157.981	5461	05/2011 → 12/2015		0-N2284	VB [DG]
E 63 AMG	05/11-	M 156.985	6208			0-N2284	VB [DG]
E 63 AMG	02/13-	M 157.981	5461	06/2013 → 12/2015		0-N2284	VB [DG]
E 63 AMG 4-matic	02/11-	M 157.981	5461	01/2013 → 12/2015		0-N2284	VB [DG]



OPTIMAL®

MERCEDES-BENZ



CM³



Art. Nr.



E-KLASSE (W212)							
E 63 AMG 4-matic	02/13-	M 157.981	5461	→ 12/2015		0-N2284	VB [DG]
E-KLASSE Cabriolet (A207)							
E 200 CGI , E 250 CGI	01/10-	M 271.820, M 271.860, M 271.860	1796			0-N2119	VB [DG]
E 200 CGI , E 250 CGI	01/10-	M 271.820, M 271.860, M 271.860	1796	Rippenanzahl: 6		0-N2120	VB [DG]
E 200 CGI , E 250 CGI	01/10-	M 271.820, M 271.860, M 271.860	1796			0-N2136	VB [BT] S
E 200, E 250	03/13-	M 274.920	1991			0-N2309	VB [BT] S
E 200, E 250	03/13-	M 274.920	1991			0-N2310	VB [DG]
E 220 BlueTEC, E 220 CDI, E 250 CDI	01/10-	OM 651.911	2143			0-N2205	VB [DG]
E 220 BlueTEC, E 220 CDI, E 250 CDI	01/10-	OM 651.911	2143	für Fahrzeuge mit Start-Stopp-Funktion		0-N2422	VB [BT] S
E 220 CDI , E 250 CDI	01/10-	OM 651.911	2143	für Fahrzeuge ohne Start-Stopp-Funktion		0-N2083	VB [BT] S
E 220 CDI, E 250 CDI	01/10-	OM 651.911	2143			0-N2238	VB [DG]
E 300, E 350, E 400	04/11-	M 276.850, M 276.957	3498			0-N2368	VB [DG]
E 300, E 350, E 400	04/11-	M 276.850, M 276.957	3498			0-N2403	VB [BT] S
E 320, E 400	06/13-	M 276.820	2996			0-N2368	VB [DG]
E 320, E 400	06/13-	M 276.820	2996			0-N2403	VB [BT] S
E 350 BlueTEC, E 350 CDI	01/10-	OM 642.836, OM 642.838	2987			0-N1560	VB [DG]
E 350 BlueTEC, E 350 CDI	04/11-	OM 642.838	2987	für Fahrzeuge mit Start-Stopp-Funktion		0-N2293	VB [BT] S
E 350 CDI	01/10-	OM 642.836	2987			0-N1902	VB [BT] S
E 350 CGI	01/10-	M 272.982, M 272.984	3498	Rippenanzahl: 6		0-N1637	VB [DG]
E 350 CGI	01/10-	M 272.982, M 272.984	3498			0-N1670	VB [BT] S
E 350 CGI	01/10-	M 272.982, M 272.984	3498			0-N2138	VB [DG]
E 350 CGI	01/10-	M 272.982, M 272.984	3498			0-N2143	VB [VD]
E 500	01/10-	M 273.966	5461	Rippenanzahl: 6		0-N1637	VB [DG]
E 500	01/10-	M 273.966	5461			0-N1670	VB [BT] S
E 500	01/10-	M 273.966	5461			0-N2138	VB [DG]
E 550	09/11-	M 278.922	4663	Baumuster: E500		0-N2284	VB [DG]
E 550 CGI	09/11-	M 278.922	4663			0-N2284	VB [DG]
E-KLASSE Coupe (C207)							
E 200 CGI , E 250 CGI	01/09-	M 271.820, M 271.860, M 271.860	1796			0-N2119	VB [DG]
E 200 CGI , E 250 CGI	01/09-	M 271.820, M 271.860, M 271.860	1796	Rippenanzahl: 6		0-N2120	VB [DG]
E 200 CGI , E 250 CGI	01/09-	M 271.820, M 271.860, M 271.860	1796			0-N2136	VB [BT] S
E 200, E 250	06/13-	M 274.920	1991			0-N2309	VB [BT] S
E 200, E 250	06/13-	M 274.920	1991			0-N2310	VB [DG]
E 220 BlueTEC, E 220 CDI , E 250 CDI	01/09-	OM 651.911	2143	für Fahrzeuge mit Start-Stopp-Funktion		0-N2422	VB [BT] S
E 220 BlueTEC, E 220 CDI, E 250 CDI	01/09-	OM 651.911	2143			0-N2205	VB [DG]
E 220 CDI , E 250 CDI	01/09-	OM 651.911	2143	für Fahrzeuge ohne Start-Stopp-Funktion		0-N2083	VB [BT] S
E 220 CDI , E 250 CDI	01/09-	OM 651.911	2143			0-N2238	VB [DG]
E 300, E 350, E 350 4-matic, E 400	04/11-	M 276.850, M 276.957	3498			0-N2368	VB [DG]
E 300, E 350, E 350 4-matic, E 400	04/11-	M 276.850, M 276.957	3498			0-N2403	VB [BT] S
E 320, E 400	06/13-	M 276.820	2996			0-N2368	VB [DG]
E 320, E 400	06/13-	M 276.820	2996			0-N2403	VB [BT] S
E 350 , E 350 CGI	01/09-	M 272.982, M 272.984, M 272.988	3498			0-N2138	VB [DG]
E 350 , E 350 CGI	01/09-	M 272.982, M 272.984, M 272.988	3498			0-N2143	VB [VD]
E 350 BlueTEC, E 350 CDI	01/09-	OM 642.836, OM 642.838	2987			0-N1560	VB [DG]
E 350 BlueTEC, E 350 CDI	04/11-	OM 642.838	2987	für Fahrzeuge mit Start-Stopp-Funktion		0-N2293	VB [BT] S
E 350 CDI	01/09-	OM 642.836	2987			0-N1902	VB [BT] S
E 350 CGI	01/09-	M 272.982, M 272.984	3498	Rippenanzahl: 6		0-N1637	VB [DG]
E 350 CGI	01/09-	M 272.982, M 272.984	3498			0-N1670	VB [BT] S
E 500	01/09-	M 273.966	5461	Rippenanzahl: 6		0-N1637	VB [DG]
E 500	01/09-	M 273.966	5461			0-N1670	VB [BT] S
E 500	01/09-	M 273.966	5461			0-N2138	VB [DG]
E 550 CGI	09/11-	M 278.922	4663			0-N2284	VB [DG]
E-KLASSE Kombi (S212)							
E 200 CDI , E 220 BlueTEC 4-matic, E 220 CDI , E 250 CDI , E 250 CDI 4-matic	08/09-	OM 651.924, OM 651.925	2143	für Fahrzeuge mit Start-Stopp-Funktion		0-N2422	VB [BT] S
E 200 CDI , E 220 CDI , E 250 CDI , E 250 CDI 4-matic	11/09-	OM 651.924, OM 651.925	2143	für Fahrzeuge ohne Start-Stopp-Funktion		0-N2083	VB [BT] S
E 200 CDI , E 220 CDI, E 250 CDI , E 250 CDI 4-matic , E 300 Hybrid	08/09-	OM 651.924, OM 651.925	2143			0-N2205	VB [DG]
E 200 CDI , E 220 CDI, E 250 CDI , E 250 CDI 4-matic , E 300 Hybrid	08/09-	OM 651.924, OM 651.925	2143			0-N2238	VB [DG]
E 200 CDI , E 220 CDI, E 250 CDI , E 250 CDI 4-matic , E 300 Hybrid	08/09-	OM 651.924, OM 651.925	2143	für Fahrzeuge mit Hybridantrieb		0-N2306	VB [BT] S
E 200 CGI , E 250 CGI	11/09-	M 271.820, M 271.860, M 271.860	1796			0-N2119	VB [DG]
E 200 CGI , E 250 CGI	11/09-	M 271.820, M 271.860, M 271.860	1796	Rippenanzahl: 6		0-N2120	VB [DG]



CM³



Art. Nr.



E-KLASSE Kombi (S212)

E 200 CGI , E 250 CGI	11/09-	M 271.820, M 271.860, M 271.860	1796		0-N2136	VB [BT]	S
E 200, E 250	11/12-	M 274.920	1991		0-N2309	VB [BT]	S
E 200, E 250	11/12-	M 274.920	1991		0-N2310	VB [DG]	
E 300 , E 300 4-matic , E 350 , E 350 4-matic , E 400, E 400 4-matic	07/11-	M 276.850, M 276.952	3498		0-N2368	VB [DG]	
E 300 , E 300 4-matic , E 350 , E 350 4-matic , E 400, E 400 4-matic	07/11-	M 276.850, M 276.952	3498		0-N2403	VB [BT]	S
E 300 CDI , E 350 BlueTEC , E 350 BlueTEC 4-matic , E 350 CDI , E 350 CDI 4-matic	11/09-12/10	OM 642.850, OM 642.850, OM 642.852, OM 642.852, OM 642.852, OM 642.858, OM 642.856, OM 642.858	2987		0-N1560	VB [DG]	
E 350 , E 350 4-matic , E 350 CGI	08/09-	M 272.977, M 272.980, M 272.983	3498		0-N2138	VB [DG]	
E 350 , E 350 4-matic , E 350 CGI	08/09-	M 272.977, M 272.980, M 272.983	3498		0-N2143	VB [VD]	
E 350 4-matic , E 350 CGI	11/09-	M 272.977, M 272.983	3498	Rippenanzahl: 6	0-N1637	VB [DG]	
E 350 4-matic , E 350 CGI	11/09-	M 272.977, M 272.983	3498		0-N1670	VB [BT]	S
E 350 BlueTEC , E 350 CDI , E 350 CDI 4-matic	11/09-	OM 642.850, OM 642.852, OM 642.856, OM 642.858	2987		0-N1902	VB [BT]	S
E 350 BlueTEC , E 350 BlueTEC 4-matic, E 350 CDI , E 350 CDI 4-matic	07/11-	OM 642.852, OM 642.858	2987	für Fahrzeuge mit Start-Stopp-Funktion	0-N2293	VB [BT]	S
E 400, E 400 4-matic	01/13-	M 276.820	2996		0-N2368	VB [DG]	
E 400, E 400 4-matic	01/13-	M 276.820	2996		0-N2403	VB [BT]	S
E 500	11/09-	M 273.971	5461	Rippenanzahl: 6	0-N1637	VB [DG]	
E 500	11/09-	M 273.971	5461		0-N1670	VB [BT]	S
E 500	11/09-	M 273.971	5461		0-N2138	VB [DG]	
E 500 , E 500 4-matic	09/11-	M 278.922	4663		0-N2284	VB [DG]	
E 63 AMG	08/09-	M 156.985	6208	Rippenanzahl: 6	0-N2120	VB [DG]	
E 63 AMG	02/11-	M 157.981	5461		0-N2284	VB [DG]	
E 63 AMG	02/13-	M 157.981	5461	06/2013 →	0-N2284	VB [DG]	
E 63 AMG , E 63 AMG 4-matic	02/11-	M 157.980, M 157.981, M 157.981	5461		0-N2284	VB [DG]	
E 63 AMG 4-matic	02/11-	M 157.981	5461	01/2013 →	0-N2284	VB [DG]	

G-KLASSE (W460)

230 GE	05/87-08/92	M 102.979, M 102.987	2298		0-N1452	VB [TE]	
230 GE	05/87-08/92	M 102.979, M 102.987	2298		0-N846	VB [TE]	
250 GD	10/87-12/92	OM 602.930	2497	Rippenanzahl: 6; ☼	0-N1288	VB [DG]	
250 GD	10/87-12/92	OM 602.930	2497		0-N1289	VB [BT]	
250 GD	10/87-12/92	OM 602.930	2497	hydraulisch	0-N1926	VB [VD]	
250 GD	10/87-12/92	OM 602.930	2497		0-N846	VB [TE]	
300 GD	03/79-07/93	OM 603.912	2996		0-N1289	VB [BT]	
300 GD	03/79-07/93	OM 603.912	2996	hydraulisch	0-N1926	VB [VD]	
250 GD	10/87-12/92	OM 602.930	2497		0-N565592	FB [TE]	
300 GD	03/79-07/93	OM 603.912	2996		0-N565592	FB [TE]	

G-KLASSE (W461)

230 GE	02/93-	M 102.979	2298	mit Anbaumaterial	0-N1013	VB [BT]	S
230 GE	02/93-	M 102.979	2298		0-N1452	VB [TE]	
230 GE	02/93-	M 102.979, M 102.996, M 102.997	2298		0-N846	VB [TE]	
230 GE	06/93-	M 102.996, M 102.997	2298	mit Anbaumaterial; für Fahrzeuge mit Servolenkung	0-N1013	VB [BT]	S
230 GE	06/93-	M 102.996, M 102.997	2298	☼:021734 →; ☼	0-N2144	VB [VD]	
230 GE	06/93-	M 102.996, M 102.997	2298	☼:054115 →; ☼; ☼	0-N2144	VB [VD]	
230 GE	06/93-	M 102.996, M 102.997	2298	☼:000255 →; ☼: →021733; ☼; ☼	0-N2145	VB [VD]	
230 GE	06/93-	M 102.996, M 102.997	2298	☼:000935 →; ☼: →054114; ☼	0-N2145	VB [VD]	
230 GE	06/93-	M 102.996, M 102.997	2298	für Fahrzeuge ohne Servolenkung	0-N847	VB [TE]	
250 GD	02/90-	OM 602.939	2497	☼:010017 →	0-N1043	VB [BT]	
250 GD	02/90-	OM 602.939	2497	☼: →010016	0-N1289	VB [BT]	
250 GD	02/90-	OM 602.939	2497	☼: →010016; hydraulisch	0-N1452	VB [TE]	
250 GD	02/90-	OM 602.939	2497	☼:010017 →	0-N2147	VB [VD]	
290 GD/G 290 D	04/92-	OM 602.942	2874	☼:000036, 000581 →	0-N1043	VB [BT]	
290 GD/G 290 D	04/92-	OM 602.942	2874	Rippenanzahl: 6; ☼	0-N1288	VB [DG]	
290 GD/G 290 D	04/92-	OM 602.942	2874		0-N1289	VB [BT]	
290 GD/G 290 D	04/92-	OM 602.942	2874	☼: →000035, 000580; hydraulisch	0-N1926	VB [VD]	
290 GD/G 290 D	04/92-	OM 602.942	2874	☼:000036, 000581 →	0-N2147	VB [VD]	
290 GD/G 290 D	04/92-	OM 602.942	2874		0-N846	VB [TE]	
290 GD/G 290 D , G 290 TD	04/92-	OM 602.942, OM 602.983	2874		0-N1452	VB [TE]	
G 270 CDI	01/03-	OM 612.966	2685		0-N1641	VB [BT]	S
G 280 CDI, G 300 CDI	04/09-	OM 642.884	2987		0-N1560	VB [DG]	
G 280 CDI, G 300 CDI	04/09-	OM 642.884	2987		0-N1902	VB [BT]	S



OPTIMAL®

MERCEDES-BENZ

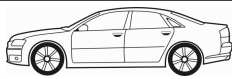

CM³



Art. Nr.



G-KLASSE (W461)							
G 290 TD	07/97-	OM 602.983	2874			0-N1043	VB [BT]
G 290 TD	07/97-	OM 602.983	2874			0-N2147	VB [VD]
G 290 TD	07/97-	OM 602.983	2874			0-N847	VB [TE]
250 GD	02/90-	OM 602.939	2497		→010016	0-N565592	FB [TE]
290 GD/G 290 D	04/92-	OM 602.942	2874		→000035, 000580	0-N565592	FB [TE]

G-KLASSE (W463)							
230 GE	06/90-06/93	M 102.989	2298	mit Anbaumaterial		0-N1013	VB [BT] S
230 GE	06/90-06/93	M 102.989	2298			0-N846	VB [TE]
250 GD	06/90-	OM 602.931	2497	Rippenanzahl: 6;		0-N1288	VB [DG]
250 GD	06/90-	OM 602.931	2497			0-N1289	VB [BT]
250 GD	06/90-	OM 602.931	2497	hydraulisch		0-N1926	VB [VD]
250 GD	06/90-	OM 602.931	2497			0-N846	VB [TE]
300 GD	09/89-	OM 603.931	2996		:001146, 003135→	0-N1043	VB [BT]
300 GD	09/89-	OM 603.931	2996	Rippenanzahl: 6;		0-N1288	VB [DG]
300 GD	09/89-	OM 603.931	2996			0-N1289	VB [BT]
300 GD	09/89-	OM 603.931	2996		→001145, 003134; hydraulisch	0-N1926	VB [VD]
300 GD	09/89-	OM 603.931	2996		:001146, 003135→	0-N2147	VB [VD]
300 GD , G 300 TD	09/89-	OM 603.931, OM 606.964	2996			0-N846	VB [TE]
300 GE	06/90-	M 103.987	2960			0-N1011	VB [BT] S
300 GE	06/90-	M 103.987	2960			0-N1278	VB [TE]
300 GE	06/90-	M 103.987	2960			0-N2146	VB [VD]
350 G Turbo D	09/91-	OM 603.972	3449		:002394→	0-N1043	VB [BT]
350 G Turbo D	09/91-	OM 603.972	3449	Rippenanzahl: 6;		0-N1288	VB [DG]
350 G Turbo D	09/91-	OM 603.972	3449			0-N1289	VB [BT]
350 G Turbo D	09/91-	OM 603.972	3449		→002393; hydraulisch	0-N1926	VB [VD]
350 G Turbo D	09/91-	OM 603.972	3449		:002394→	0-N2147	VB [VD]
350 G Turbo D	09/91-	OM 603.972	3449			0-N846	VB [TE]
AMG G 63, G 63 AMG, G 63 AMG 6x6	05/12-	M 157.980, M 157.984, M 157.984	5461			0-N2284	VB [DG]
G 270 CDI	10/01-	OM 612.965	2685	Rippenanzahl: 6		0-N1431	VB [DG]
G 270 CDI	10/01-	OM 612.965	2685	Rippenanzahl: 6;		0-N1436	VB [DG] S
G 270 CDI	10/01-	OM 612.965	2685	Rippenanzahl: 6;		0-N1437	VB [DG]
G 270 CDI	10/01-	OM 612.965	2685			0-N1641	VB [BT] S
G 300 TD	08/96-	OM 606.964	2996			0-N1043	VB [BT]
G 300 TD	08/96-	OM 606.964	2996			0-N2147	VB [VD]
G 320	09/94-12/97	M 104.996	3199			0-N1282	VB [TE]
G 320	09/94-12/97	M 104.996	3199			0-N1283	VB [TE]
G 320	09/94-12/97	M 104.996	3199	Rippenanzahl: 6		0-N1288	VB [DG]
G 320	09/94-12/97	M 104.996	3199		→002383	0-N2141	VB [TE]
G 320	07/97-	M 112.945	3199	Rippenanzahl: 6		0-N1431	VB [DG]
G 320	07/97-	M 112.945	3199			0-N1645	VB [BT] S
G 320 CDI	09/06-	OM 642.970	2987	11/2007 →;	:40777760→	0-N1560	VB [DG]
G 320 CDI	09/06-	OM 642.970	2987	11/2007 →		0-N1902	VB [BT] S
G 320 CDI	09/06-	OM 642.970	2987	→ 11/2007		0-N2132	VB [DG]
G 320 CDI	09/06-	OM 642.970	2987	→ 11/2007		0-N2219	VB [BT] S
G 350 CDI	07/11-	OM 642.886	2987			0-N1560	VB [DG]
G 36 AMG	01/95-	M 104.996 (AMG 3,6)	3606			0-N1282	VB [TE]
G 36 AMG	01/95-	M 104.996 (AMG 3,6)	3606		:002384→	0-N1283	VB [TE]
G 36 AMG	01/95-	M104.996	3606	Rippenanzahl: 6		0-N1288	VB [DG]
G 36 AMG	01/95-	M 104.996 (AMG 3,6)	3606		→002383	0-N2141	VB [TE]
G 400 CDI	12/00-	OM 628.962	3996			0-N2193	VB [BT] S
G 400 CDI	12/00-	OM 628.962	3996			0-N2218	VB [DG]
G 500	04/98-	M 113.962	4966	Rippenanzahl: 6		0-N1431	VB [DG]
G 500	04/98-	M 113.962	4966			0-N1645	VB [BT] S
G 55 AMG	04/99-	M 113.982	5439	Rippenanzahl: 6		0-N1431	VB [DG]
G 55 AMG	04/99-	M 113.982, M 113.993	5439			0-N1645	VB [BT] S
250 GD	06/90-	OM 602.931	2497			0-N565592	FB [TE]
300 GD	09/89-	OM 603.931	2996		→001145, 003134	0-N565592	FB [TE]
350 G Turbo D	09/91-	OM 603.972	3449		→002393	0-N565592	FB [TE]

G-KLASSE Geländewagen offen (W463)							
200 GE	01/90-07/93	M 102.965	1996	mit Anbaumaterial; für Fahrzeuge mit Servolenkung		0-N1013	VB [BT] S
230 GE	06/90-02/93	M 102.989	2298	mit Anbaumaterial		0-N1013	VB [BT] S
230 GE	06/90-02/93	M 102.989	2298			0-N846	VB [TE]
300 GD	12/90-09/97	OM 603.931	2996		:001146, 003135→	0-N1043	VB [BT]
300 GD	12/90-09/97	OM 603.931	2996	Rippenanzahl: 6;		0-N1288	VB [DG]

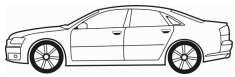

CM³



Art. Nr.



G-KLASSE Geländewagen offen (W463)

300 GD	12/90-09/97	OM 603.931	2996		0-N1289	VB [BT]	
300 GD	12/90-09/97	OM 603.931	2996	:→001145, 003134; hydraulisch	0-N1926	VB [VD]	
300 GD	12/90-09/97	OM 603.931	2996	:001146, 003135→	0-N2147	VB [VD]	
300 GD , G 300 TD	12/90-09/97	OM 603.931, OM 606.964	2996		0-N846	VB [TE]	
300 GE	09/89-09/97	M 103.987	2960		0-N1011	VB [BT]	S
300 GE	09/89-09/97	M 103.987	2960		0-N1278	VB [TE]	
300 GE	09/89-09/97	M 103.987	2960		0-N2146	VB [VD]	
320 GE	09/94-11/97	M 104.996	3199		0-N1282	VB [TE]	
320 GE	09/94-11/97	M 104.996	3199		0-N1283	VB [TE]	
320 GE	09/94-11/97	M 104.996	3199	Rippenanzahl: 6	0-N1288	VB [DG]	
320 GE	09/94-11/97	M 104.996	3199	:→002383	0-N2141	VB [TE]	
350 G Turbo-D	09/91-09/97	OM 603.972	3449	:002394→	0-N1043	VB [BT]	
350 G Turbo-D	09/91-09/97	OM 603.972	3449	Rippenanzahl: 6;	0-N1288	VB [DG]	
350 G Turbo-D	09/91-09/97	OM 603.972	3449		0-N1289	VB [BT]	
350 G Turbo-D	09/91-09/97	OM 603.972	3449	:→002393; hydraulisch	0-N1926	VB [VD]	
350 G Turbo-D	09/91-09/97	OM 603.972	3449	:002394→	0-N2147	VB [VD]	
350 G Turbo-D	09/91-09/97	OM 603.972	3449		0-N846	VB [TE]	
G 300 TD	09/96-	OM 606.964	2996		0-N1043	VB [BT]	
G 300 TD	09/96-	OM 606.964	2996		0-N2147	VB [VD]	
G 320	11/97-	M 112.945	3199	Rippenanzahl: 6	0-N1431	VB [DG]	
G 320	11/97-	M 112.945	3199		0-N1645	VB [BT]	S
G 320 CDI	09/06-	OM 642.970	2987	11/2007 →; :40777760→	0-N1560	VB [DG]	
G 320 CDI	09/06-	OM 642.970	2987	11/2007 →	0-N1902	VB [BT]	S
G 320 CDI	09/06-	OM 642.970	2987	→ 11/2007	0-N2132	VB [DG]	
G 320 CDI	09/06-	OM 642.970	2987	→ 11/2007	0-N2219	VB [BT]	S
G 350 CDI	07/11-	OM 642.886	2987		0-N1560	VB [DG]	
G 400 CDI	12/00-	OM 628.962	3996		0-N2193	VB [BT]	S
G 400 CDI	12/00-	OM 628.962	3996		0-N2218	VB [DG]	
G 500	04/98-	M 113.962	4966	Rippenanzahl: 6	0-N1431	VB [DG]	
G 500	04/98-	M 113.962	4966		0-N1645	VB [BT]	S
G 500	12/09-	M 273.963	5461	Rippenanzahl: 6	0-N1637	VB [DG]	
G 500	12/09-	M 273.963	5461		0-N1670	VB [BT]	S
G 500	12/09-	M 273.963	5461		0-N2138	VB [DG]	
300 GD	12/90-09/97	OM 603.931	2996	:→001145, 003134	0-N565592	FB [TE]	
350 G Turbo-D	09/91-09/97	OM 603.972	3449	:→002393	0-N565592	FB [TE]	

GL320 [USA]

GL 320 CDI 4-matic	01/09-12/09		2987		0-N1560	VB [DG]	
GL 320 CDI 4-matic	01/09-12/09		2987	→ 11/2007	0-N2219	VB [BT]	S

GL350 [USA]

GL 350 CDI 4-matic	01/10-12/10		2987		0-N1560	VB [DG]	
--------------------	-------------	--	------	--	---------	---------	--

GL-KLASSE (X164)

GL 320 CDI	09/06-05/09	OM 642.940	2987	11/2007 →; :40777760→	0-N1560	VB [DG]	
GL 320 CDI	09/06-05/09	OM 642.940	2987	11/2007 →; :40882550→	0-N1902	VB [BT]	S
GL 320 CDI	09/06-05/09	OM 642.940	2987	→ 11/2007; :→40582549	0-N2132	VB [DG]	
GL 320 CDI	09/06-05/09	OM 642.940	2987	→ 11/2007	0-N2219	VB [BT]	S
GL 350 CDI , GL 350 CDI BlueTEC	05/09-	OM 642.820, OM 642.822, OM 642.940	2987		0-N1560	VB [DG]	
GL 350 CDI , GL 350 CDI BlueTEC	05/09-	OM 642.820, OM 642.822, OM 642.940	2987		0-N1902	VB [BT]	S
GL 450	09/06-	M 273.923	4663	Rippenanzahl: 6	0-N1637	VB [DG]	
GL 450	09/06-	M 273.923	4663		0-N1670	VB [BT]	S
GL 450	09/06-	M 273.923	4663		0-N2138	VB [DG]	
GL 500	09/06-	M 273.963	5461	Rippenanzahl: 6	0-N1637	VB [DG]	
GL 500	09/06-	M 273.963	5461		0-N1670	VB [BT]	S
GL 500	09/06-	M 273.963	5461		0-N2138	VB [DG]	

GL-KLASSE (X166)

GL 350 BlueTec 4-matic	07/12-	OM 642.826	2987	für Fahrzeuge mit Start-Stopp-Funktion	0-N1560	VB [DG]	
GL 350 BlueTec 4-matic	07/12-	OM 642.826	2987	für Fahrzeuge mit Start-Stopp-Funktion	0-N2293	VB [BT]	S
GL 400 4-matic	08/13-	M 276.821	2996		0-N2368	VB [DG]	
GL 400 4-matic	08/13-	M 276.821	2996		0-N2403	VB [BT]	S
GL 500 4-matic	07/12-	M 278.928	4663		0-N2284	VB [DG]	
GL 63 AMG	07/12-	M 157.982	5461		0-N2284	VB [DG]	

GLS (X166)

500 4-matic	11/15-	M 278.928	4663		0-N2284	VB [DG]	
AMG 63 4-matic	11/15-	M 157.982	5461		0-N2284	VB [DG]	

CM³

Art. Nr.



GLK-KLASSE (X204)							
200 CDI	07/10-	OM 651.913, OM 651.916	2143			0-N2083	VB [BT] S
200 CDI , 220 CDI , 220 CDI 4-matic , 250 CDI 4-matic	12/08-	OM 651.912, OM 651.913, OM 651.916, OM 651.916	2143			0-N2205	VB [DG]
200 CDI , 220 CDI , 220 CDI 4-matic , 250 CDI 4-matic	12/08-	OM 651.912, OM 651.913, OM 651.916, OM 651.916	2143			0-N2238	VB [DG]
200 CDI , 220 CDI , 220 CDI 4-matic , 250 CDI 4-matic	12/08-	OM 651.912, OM 651.913, OM 651.916, OM 651.916	2143	für Fahrzeuge mit Start-Stopp-Funktion		0-N2422	VB [BT] S
200, 250, 250 4-matic	08/13-	M 274.920	1991			0-N2309	VB [BT] S
200, 250, 250 4-matic	08/13-	M 274.920	1991			0-N2310	VB [DG]
220 CDI , 220 CDI 4-matic , 250 CDI 4-matic	12/08-	OM 651.912, OM 651.916	2143	für Fahrzeuge ohne Start-Stopp-Funktion		0-N2083	VB [BT] S
280 4-matic , 300 4-matic	06/08-04/11	M 272.948	2996	Rippenanzahl: 6		0-N1637	VB [DG]
280 4-matic , 300 4-matic	06/08-04/11	M 272.948	2996			0-N1670	VB [BT] S
280 4-matic , 300 4-matic	06/08-04/11	M 272.948	2996			0-N2138	VB [DG]
280 4-matic , 300 4-matic	06/08-04/11	M 272.948	2996			0-N2143	VB [VD]
320 CDI 4-matic , 350 CDI 4-matic	06/08-05/10	OM 642.832, OM 642.835, OM 642.961	2987			0-N1560	VB [DG]
320 CDI 4-matic , 350 CDI 4-matic	06/08-05/10	OM 642.832, OM 642.961	2987			0-N1902	VB [BT] S
350 4-matic	06/08-04/11	M 272.971	3498	Rippenanzahl: 6		0-N1637	VB [DG]
350 4-matic	06/08-04/11	M 272.971	3498			0-N1670	VB [BT] S
350 4-matic	06/08-	M 276.957	3498			0-N2368	VB [DG]
350 4-matic	06/08-	M 276.957	3498			0-N2403	VB [BT] S
350 CDI 4-matic	07/12-	OM 642.835	2987	für Fahrzeuge mit Start-Stopp-Funktion		0-N2293	VB [BT] S
350, 350 4-matic	06/08-04/11	M 272.971, M 272.991	3498			0-N2138	VB [DG]
350, 350 4-matic	06/08-04/11	M 272.971, M 272.991	3498			0-N2143	VB [VD]
GLA-KLASSE (X156)							
GLA 180 CDI	07/14-	OM 607.951	1461	27x119		SK-1730	BTK
GLA 180 CDI	07/14-	OM 607.951	1461	27x119		SK-1730AQ1	BTKW
GLA 180 CDI	07/14-	OM 607.951	1461			0-N2423	TB [TE]
GLA 180 CDI	07/14-	OM 607.951	1461			0-N2290	VB [BT] S
GLE (W166)							
500 4-matic	04/15-	M 278.928	4663			0-N2284	VB [DG]
AMG 63 4-matic, AMG 63 S 4-matic	04/15-	M 157.982	5461			0-N2284	VB [DG]
GLE Coupe (C292)							
500 4-matic	10/15-	M 278.928	4663			0-N2284	VB [DG]
AMG 63 4-matic, AMG 63 S 4-matic	03/15-	M 157.982	5461			0-N2284	VB [DG]
KOMBI Kombi (S124)							
200 T , 200 TE	09/85-08/92	M 102.922, M 102.962, M 102.963	1996	mit Anbaumaterial; für Fahrzeuge mit Servolenkung		0-N1013	VB [BT] S
200 T , 200 TE	09/85-08/92	M 102.922, M 102.962, M 102.963	1996	:021734→; ; ; für Fahrzeuge mit Servolenkung		0-N2144	VB [VD]
200 T , 200 TE	09/85-08/92	M 102.922, M 102.962, M 102.963	1996	:054115→;		0-N2144	VB [VD]
200 T , 200 TE	09/85-08/92	M 102.922, M 102.963	1996	:000255→; :→021733; ; für Fahrzeuge mit Servolenkung		0-N2145	VB [VD]
200 T , 200 TE	09/85-08/92	M 102.922, M 102.962, M 102.963	1996	:000935→; :→054114;		0-N2145	VB [VD]
200 T , 200 TE	09/85-08/92	M 102.922, M 102.962, M 102.963	1996			0-N846	VB [TE]
200 T , 200 TE	09/85-08/92	M 102.922, M 102.962, M 102.963	1996	für Fahrzeuge ohne Servolenkung		0-N847	VB [TE]
200 T D	09/85-08/91	OM 601.912	1997	:021217, 204234→		0-N1043	VB [BT]
200 T D	09/85-08/91	OM 601.912	1997			0-N1289	VB [BT]
200 T D	09/85-08/91	OM 601.912	1997	:→021216, 204233; hydraulisch		0-N1926	VB [VD]
200 T D	09/85-08/91	OM 601.912	1997	:021217, 204234→		0-N2147	VB [VD]
200 T D	09/85-08/91	OM 601.912	1997			0-N846	VB [TE]
200 T D	09/85-08/91	OM 601.912	1997	für Fahrzeuge ohne Servolenkung		0-N847	VB [TE]
200 TE	05/86-06/93	M 111.940	1998			0-N1703	VB [BT]
200 TE	05/86-06/93	M 111.940	1998			0-N1833	VB [TE]
200 TE	05/86-06/93	M 111.940	1998			0-N2418	VB [BT]
200 TE	09/88-12/89	M 102.962	1996	:000255→; :→021733;		0-N2145	VB [VD]
220 TE	10/92-05/93	M 111.960	2199			0-N1703	VB [BT]
220 TE	10/92-05/93	M 111.960	2199			0-N1833	VB [TE]
220 TE	10/92-05/93	M 111.960	2199			0-N1951	VB [VD]
220 TE	10/92-05/93	M 111.960	2199			0-N2418	VB [BT]
230 TE	09/85-08/92	M 102.982	2298	mit Anbaumaterial; für Fahrzeuge mit Servolenkung		0-N1013	VB [BT] S
230 TE	09/85-08/92	M 102.982	2298	:086552→		0-N2144	VB [VD]
230 TE	09/85-08/92	M 102.982	2298	:→086551		0-N2145	VB [VD]
230 TE	09/85-08/92	M 102.982	2298			0-N846	VB [TE]
230 TE	09/85-08/92	M 102.982	2298	für Fahrzeuge ohne Servolenkung		0-N847	VB [TE]

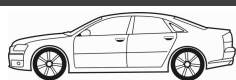

CM³



Art. Nr.



KOMBI Kombi (S124)							
250 T D , 250 TD Turbo	09/85-07/93	OM 602.912, OM 602.962	2497			0-N1289	VB [BT]
250 T D , 250 TD Turbo	09/85-07/93	OM 602.912, OM 602.962	2497	hydraulisch		0-N1926	VB [VD]
250 T D , 250 TD Turbo	09/85-07/93	OM 602.912, OM 602.962	2497			0-N846	VB [TE]
260 TE FGST.	09/85-08/92	M 103.940	2597			0-N1011	VB [BT] S
260 TE FGST.	09/85-08/92	M 103.940	2597			0-N1278	VB [TE]
260 TE FGST.	09/85-08/92	M 103.940	2597			0-N2146	VB [VD]
280 TE	10/92-06/93	M 104.942	2799	:→005789, 048696		0-N1011	VB [BT] S
280 TE	10/92-06/93	M 104.942	2799	:→005789, 048696		0-N1278	VB [TE]
280 TE	10/92-06/93	M 104.942	2799	:005790, 048697→		0-N1282	VB [TE]
280 TE	10/92-06/93	M 104.942	2799	Rippenanzahl: 6		0-N1288	VB [DG]
280 TE	10/92-06/93	M 104.942	2799	:005790, 048697→		0-N2141	VB [TE]
280 TE	10/92-06/93	M 104.942	2799	:→005789, 048696		0-N2146	VB [VD]
300 T D	09/86-06/93	OM 603.912	2996	hydraulisch		0-N1926	VB [VD]
300 T D , 300 T Turbo-D, 300 T Turbo-D 4-matic	09/86-06/93	OM 603.912, OM 603.960, OM 603.960, OM 603.963, OM 603.963	2996			0-N1289	VB [BT]
300 T Turbo-D	09/86-01/89	OM 603.963	2996	:004191→		0-N1043	VB [BT]
300 T Turbo-D	09/86-01/89	OM 603.960	2996	:048697→		0-N1043	VB [BT]
300 T Turbo-D	09/86-01/89	OM 603.960, OM 603.963	2996	:→004190, 049508; hydraulisch		0-N1926	VB [VD]
300 T Turbo-D	09/86-01/89	OM 603.963	2996	:004191→		0-N2147	VB [VD]
300 T Turbo-D	09/86-01/89	OM 603.960	2996	:048697→		0-N2147	VB [VD]
300 T Turbo-D , 300 T Turbo-D 4-matic	09/86-06/93	OM 603.960, OM 603.963	2996	:004191→		0-N1043	VB [BT]
300 T Turbo-D , 300 T Turbo-D 4-matic	09/86-06/93	OM 603.960, OM 603.963	2996	:048697→		0-N1043	VB [BT]
300 T Turbo-D , 300 T Turbo-D 4-matic	09/86-06/93	OM 603.960, OM 603.963	2996	:→004190, 049508; hydraulisch		0-N1926	VB [VD]
300 T Turbo-D , 300 T Turbo-D 4-matic	09/86-06/93	OM 603.960, OM 603.963	2996	:004191→		0-N2147	VB [VD]
300 T Turbo-D , 300 T Turbo-D 4-matic	09/86-06/93	OM 603.960, OM 603.963	2996	:048697→		0-N2147	VB [VD]
300 T Turbo-D, 300 T Turbo-D 4-matic	09/86-06/93	OM 603.960, OM 603.960, OM 603.963, OM 603.963	2996			0-N846	VB [TE]
300 TE , 300 TE 4-matic , 300 TE-24	01/86-06/93	M 103.983, M 103.985, M 104.980	2960			0-N1011	VB [BT] S
300 TE , 300 TE 4-matic , 300 TE-24	01/86-06/93	M 103.983, M 103.985, M 104.980	2960			0-N1278	VB [TE]
300 TE , 300 TE 4-matic , 300 TE-24	01/86-06/93	M 103.983, M 103.985, M 104.980	2960			0-N2146	VB [VD]
300 TE-24	09/89-08/92	M 104.980	2960	:→21004		0-N847	VB [TE]
300 TE-24	09/89-08/92	M 104.980	2960	:→4956		0-N847	VB [TE]
320 TE	10/92-06/93	M 104.992	3199	:→004356, 072236		0-N1011	VB [BT] S
320 TE	10/92-06/93	M 104.992	3199	:→004356, 072236		0-N1278	VB [TE]
320 TE	10/92-06/93	M 104.992	3199	:004357, 072237→		0-N1282	VB [TE]
320 TE	10/92-06/93	M 104.992	3199			0-N1283	VB [TE]
320 TE	10/92-06/93	M 104.992	3199	Rippenanzahl: 6		0-N1288	VB [DG]
320 TE	10/92-06/93	M 104.992	3199	:004357, 072237→; :→005602, 102820		0-N2141	VB [TE]
320 TE	10/92-06/93	M 104.992	3199	:→004356, 072237		0-N2146	VB [VD]
200 T D	09/85-08/91	OM 601.912	1997			0-N565592	FB [TE]
250 T D	09/85-06/93	OM 602.912	2497			0-N565592	FB [TE]
250 TD Turbo	03/88-07/93	OM 602.962	2497	:→004190		0-N565592	FB [TE]
300 T D , 300 T Turbo-D, 300 T Turbo-D 4-matic	09/86-06/93	OM 603.912, OM 603.960, OM 603.960, OM 603.963, OM 603.963	2996			0-N565592	FB [TE]
M-KLASSE (W166)							
ML 250 CDI BlueTEC 4-matic	06/11-	OM 651.960	2143			0-N2205	VB [DG]
ML 250 CDI BlueTEC 4-matic	06/11-	OM 651.960	2143			0-N2238	VB [DG]
ML 250 CDI BlueTEC 4-matic	06/11-	OM 651.960	2143	für Fahrzeuge mit Hybridantrieb		0-N2306	VB [BT] S
ML 300 4-matic, ML 350 4-matic	06/11-	M 276.955	3498			0-N2368	VB [DG]
ML 300 4-matic, ML 350 4-matic	06/11-	M 276.955	3498			0-N2403	VB [BT] S
ML 350 BlueTEC 4-matic	06/11-	OM 642.826	2987	für Fahrzeuge mit Start-Stopp-Funktion		0-N1560	VB [DG]
ML 350 BlueTEC 4-matic	06/11-	OM 642.826	2987	für Fahrzeuge mit Start-Stopp-Funktion		0-N2293	VB [BT] S
ML 400 4-matic	08/13-	M 276.821	2996			0-N2368	VB [DG]
ML 400 4-matic	08/13-	M 276.821	2996			0-N2403	VB [BT] S
ML 500 4-matic	02/12-	M 278.928	4663			0-N2284	VB [DG]
ML 63 AMG 4-matic	11/11-	M 157.980, M 157.982	5461			0-N2284	VB [DG]
R320 [USA]							
R 320 4-matic, R 320 CDI 4-matic	01/07-12/09		2987			0-N1560	VB [DG]
R 320 CDI 4-matic	01/07-12/08		2987	→ 11/2007		0-N2219	VB [BT] S
M-KLASSE (W163)							
ML 230	02/98-06/05	M 111.977	2295			0-N1703	VB [BT]
ML 230	02/98-06/05	M 111.977	2295			0-N1833	VB [TE]
ML 230	02/98-06/05	M 111.977	2295	→ 08/2000		0-N1951	VB [VD]
ML 230	02/98-06/05	M 111.977	2295			0-N2418	VB [BT]



OPTIMAL®

MERCEDES-BENZ



CM³



Art. Nr.



ohne Halter

M-KLASSE (W163)

ML 270 CDI	12/99-06/05	OM 612.963	2685	Rippenanzahl: 6	0-N1431	VB [DG]	
ML 270 CDI	12/99-06/05	OM 612.963	2685		0-N1641	VB [BT]	S
ML 320	02/98-08/02	M 112.942	3199	Rippenanzahl: 6	0-N1431	VB [DG]	
ML 320	02/98-08/02	M 112.942	3199		0-N1645	VB [BT]	S
ML 350	08/02-06/05	M 112.970	3724	Rippenanzahl: 6	0-N1431	VB [DG]	
ML 350	08/02-06/05	M 112.970	3724		0-N1645	VB [BT]	S
ML 400 CDI	09/01-06/05	OM 628.963	3996		0-N2193	VB [BT]	S
ML 400 CDI	09/01-06/05	OM 628.963	3996		0-N2218	VB [DG]	
ML 430	02/98-06/05	M 113.942	4266	Rippenanzahl: 6	0-N1431	VB [DG]	
ML 430	02/98-06/05	M 113.942	4266		0-N1645	VB [BT]	S
ML 500	09/01-06/05	M 113.964, M 113.965	4966	Rippenanzahl: 6	0-N1431	VB [DG]	
ML 500	09/01-06/05	M 113.964, M 113.965	4966		0-N1645	VB [BT]	S
ML 55 AMG	02/00-06/05	M 113.981	5439	Rippenanzahl: 6	0-N1431	VB [DG]	
ML 55 AMG	02/00-06/05	M 113.981	5439		0-N1645	VB [BT]	S

M-KLASSE (W164)

ML 280 CDI 4-matic, ML 320 CDI 4-matic	07/05-07/09	OM 642.940	2987	11/2007 →, ☎:40777760→	0-N1560	VB [DG]	
ML 280 CDI 4-matic, ML 320 CDI 4-matic	07/05-07/09	OM 642.940	2987	11/2007 →	0-N1902	VB [BT]	S
ML 280 CDI 4-matic, ML 320 CDI 4-matic	07/05-07/09	OM 642.940	2987	→ 11/2007	0-N2132	VB [DG]	
ML 280 CDI 4-matic, ML 320 CDI 4-matic	07/05-07/09	OM 642.940	2987	→ 11/2007	0-N2219	VB [BT]	S
ML 300 CDI 4-matic, ML 350 CDI 4-matic	07/09-	OM 642.820, OM 642.820, OM 642.820, OM 642.940	2987		0-N1560	VB [DG]	
ML 300 CDI 4-matic, ML 350 CDI 4-matic	07/09-	OM 642.820, OM 642.820, OM 642.820, OM 642.940	2987		0-N1902	VB [BT]	S
ML 350 4-matic	07/05-	M 272.967	3498	Rippenanzahl: 6	0-N1637	VB [DG]	
ML 350 4-matic	07/05-	M 272.967	3498		0-N1670	VB [BT]	S
ML 350 4-matic	07/05-	M 272.967	3498		0-N2138	VB [DG]	
ML 350 4-matic	07/05-	M 272.967	3498		0-N2143	VB [VD]	
ML 500 4-matic	07/05-	M 113.964	4966	Rippenanzahl: 6	0-N1431	VB [DG]	
ML 500 4-matic	07/05-	M 113.964	4966		0-N1645	VB [BT]	S
ML 500 4-matic	12/07-	M 273.963	5461	Rippenanzahl: 6	0-N1637	VB [DG]	
ML 500 4-matic	12/07-	M 273.963	5461		0-N1670	VB [BT]	S
ML 500 4-matic	12/07-	M 273.963	5461		0-N2138	VB [DG]	
ML 63 AMG 4-matic	01/06-	M 156.980	6208	Rippenanzahl: 6	0-N2120	VB [DG]	

R-KLASSE (W251, V251)

R 280, R 280 4-matic, R 300	01/07-	M 272.945	2996	Rippenanzahl: 6	0-N1637	VB [DG]	
R 280, R 280 4-matic, R 300	01/07-	M 272.945	2996		0-N1670	VB [BT]	S
R 280, R 280 4-matic, R 300	01/07-	M 272.945	2996		0-N2138	VB [DG]	
R 280, R 280 4-matic, R 300	01/07-	M 272.945	2996		0-N2143	VB [VD]	
R 280 CDI, R 280 CDI 4-matic, R 320 CDI 4-matic	01/06-	OM 642.870, OM 642.872, OM 642.950, OM 642.870, OM 642.950, OM 642.950	2987	11/2007 →	0-N1902	VB [BT]	S
R 280 CDI, R 280 CDI 4-matic, R 320 CDI 4-matic	01/06-	OM 642.870, OM 642.872, OM 642.950, OM 642.950	2987	→ 11/2007	0-N2132	VB [DG]	
R 280 CDI, R 280 CDI 4-matic, R 320 CDI 4-matic, R 350 CDI 4-matic	01/06-	OM 642.870, OM 642.872, OM 642.950, OM 642.870, OM 642.950, OM 642.950	2987	11/2007 →, ☎:40777760→	0-N1560	VB [DG]	
R 280 CDI, R 280 CDI 4-matic, R 320 CDI 4-matic, R 350 CDI 4-matic	01/06-	OM 642.870, OM 642.872, OM 642.950, OM 642.870, OM 642.950, OM 642.950	2987	→ 11/2007	0-N2219	VB [BT]	S
R 300 CDI, R 300 CDI 4-matic, R 350 CDI 4-matic	01/06-	OM 642.870, OM 642.872, OM 642.950, OM 642.870, OM 642.950, OM 642.872, OM 642.950	2987		0-N1902	VB [BT]	S
R 300 CDI, R 300 CDI 4-matic, R 350 CDI 4-matic	07/09-	OM 642.870, OM 642.872, OM 642.950, OM 642.872, OM 642.950	2987		0-N1560	VB [DG]	
R 350, R 350 4-matic	01/06-	M 272.967	3498	Rippenanzahl: 6	0-N1637	VB [DG]	
R 350, R 350 4-matic	01/06-	M 272.967	3498		0-N1670	VB [BT]	S
R 350, R 350 4-matic	01/06-	M 272.967	3498		0-N2138	VB [DG]	
R 350, R 350 4-matic	01/06-	M 272.967	3498		0-N2143	VB [VD]	
R 350 4-matic	01/06-	M 276.958	3498		0-N2368	VB [DG]	
R 350 4-matic	01/06-	M 276.958	3498		0-N2403	VB [BT]	S
R 500 4-matic	01/06-	M 113.971	4966	Rippenanzahl: 6	0-N1431	VB [DG]	
R 500 4-matic	01/06-	M 113.971	4966		0-N1645	VB [BT]	S
R 500 4-matic	01/07-	M 273.963	5461	Rippenanzahl: 6	0-N1637	VB [DG]	
R 500 4-matic	01/07-	M 273.963	5461		0-N1670	VB [BT]	S
R 500 4-matic	01/07-	M 273.963	5461		0-N2138	VB [DG]	
R 63 AMG	02/06-	M 156.980	6208	Rippenanzahl: 6	0-N2120	VB [DG]	

S-KLASSE (W126)

260 SE	09/85-06/91	M 103.941	2597		0-N1011	VB [BT]	S
260 SE	09/85-06/91	M 103.941	2597		0-N1278	VB [TE]	



CM³



Art. Nr.



ohne Halter

S-KLASSE (W126)							
260 SE	09/85-06/91	M 103.941	2597			0-N2146	VB [VD]
300 SE,SEL	09/85-06/91	M 103.981	2960			0-N1011	VB [BT] S
300 SE,SEL	09/85-06/91	M 103.981	2960			0-N1278	VB [TE]
300 SE,SEL	09/85-06/91	M 103.981	2960			0-N2146	VB [VD]
S-KLASSE (W140)							
300 SE,SEL/S320	03/91-10/98	M 104.990	3199			0-N1280	TB [TE]
300 SE 2.8 , S 280	01/93-10/98	M 104.944	2799	:→007447		0-N1011	VB [BT] S
300 SE 2.8 , S 280	01/93-10/98	M 104.944	2799	:→007447		0-N1278	VB [TE]
300 SE 2.8 , S 280	01/93-10/98	M 104.944	2799	:007448→		0-N1282	VB [TE]
300 SE 2.8 , S 280	01/93-10/98	M 104.944	2799			0-N1283	VB [TE]
300 SE 2.8 , S 280	01/93-10/98	M 104.944	2799	Rippenanzahl: 6		0-N1288	VB [DG]
300 SE 2.8 , S 280	01/93-10/98	M 104.944	2799	:007448→; :→016164		0-N2141	VB [TE]
300 SE 2.8 , S 280	01/93-10/98	M 104.944	2799	:→007447		0-N2146	VB [VD]
300 SE,SEL/S320	03/91-10/98	M 104.994	3199	:→031209		0-N1011	VB [BT] S
300 SE,SEL/S320	03/91-10/98	M 104.994	3199	:→031209		0-N1278	VB [TE]
300 SE,SEL/S320	03/91-10/98	M 104.994	3199	:031210→		0-N1282	VB [TE]
300 SE,SEL/S320	03/91-10/98	M 104.990, M 104.994	3199			0-N1283	VB [TE]
300 SE,SEL/S320	03/91-10/98	M 104.994	3199	Rippenanzahl: 6		0-N1288	VB [DG]
300 SE,SEL/S320	03/91-10/98	M 104.990	3199			0-N1861	VB [TE]
300 SE,SEL/S320	03/91-10/98	M 104.994	3199	:031210→; :→067244		0-N2141	VB [TE]
300 SE,SEL/S320	03/91-10/98	M 104.990	3199			0-N2146	VB [VD]
300 SE,SEL/S320	03/91-10/98	M 104.994	3199	:→031209		0-N2146	VB [VD]
400 SE,SEL/S420 , S 420	02/91-10/98	M 119.971	4196	:011683→		0-N1860	VB [BT]
400 SE,SEL/S420 , S 420	02/91-10/98	M 119.971	4196	:→011682		0-N1862	VB [BT]
400 SE,SEL/S420 , S 420	02/91-10/98	M 119.971	4196	:→011682; Rippenanzahl: 8		0-N1864	VB [DG]
400 SE,SEL/S420 , S 420	02/91-10/98	M 119.971	4196	:011683→		0-N2141	VB [TE]
400 SE,SEL/S420 , S 420	02/91-10/98	M 119.971	4196	für Fahrzeuge ohne Katalysator; :011683→; :→016096		0-N847	VB [TE]
500 SE,SEL	02/91-10/98	M 119.970	4973	:026391→		0-N1860	VB [BT]
500 SE,SEL	02/91-10/98	M 119.970	4973	:→026390		0-N1862	VB [BT]
500 SE,SEL	02/91-10/98	M 119.970	4973	:→026390; Rippenanzahl: 8		0-N1864	VB [DG]
500 SE,SEL	02/91-10/98	M 119.970	4973	:026391→		0-N2141	VB [TE]
500 SE,SEL	02/91-10/98	M 119.970	4973	für Fahrzeuge ohne Katalysator; :026391→; :→032287		0-N847	VB [TE]
600 SE,SEL , S 600	04/91-10/98	M 120.982	5987	Rippenanzahl: 6		0-N1288	VB [DG]
600 SE,SEL , S 600	04/91-10/98	M 120.980	5987			0-N1861	VB [TE]
S 300 Turbo-D	05/96-10/98	OM 606.961	2996			0-N1043	VB [BT]
S 300 Turbo-D	05/96-10/98	OM 606.961	2996			0-N2147	VB [VD]
S 300 Turbo-D	05/96-10/98	OM 606.961	2996			0-N846	VB [TE]
S 350 Turbo-D	01/93-10/98	OM 603.971	3449	:007422→		0-N1043	VB [BT]
S 350 Turbo-D	01/93-10/98	OM 603.971	3449			0-N1278	VB [TE]
S 350 Turbo-D	01/93-10/98	OM 603.971	3449	:→007421		0-N1289	VB [BT]
S 350 Turbo-D	01/93-10/98	OM 603.971	3449	:→007421; hydraulisch		0-N1926	VB [VD]
S 350 Turbo-D	01/93-10/98	OM 603.971	3449	:007422→		0-N2147	VB [VD]
S 350 Turbo-D	01/93-10/98	OM 603.971	3449			0-N846	VB [TE]
S 500	01/93-10/98	M 119.980	4973	Rippenanzahl: 6		0-N1288	VB [DG]
S 500	01/93-10/98	M 119.980	4973			0-N1860	VB [BT]
S 500	01/93-10/98	M 119.970	4973	:026391→		0-N1860	VB [BT]
S 500	01/93-10/98	M 119.970	4973	:→026390		0-N1862	VB [BT]
S 500	01/93-10/98	M 119.970	4973	:→026390; Rippenanzahl: 8		0-N1864	VB [DG]
S 500	01/93-10/98	M 119.980	4973			0-N2141	VB [TE]
S 500	01/93-10/98	M 119.970	4973	:026391→		0-N2141	VB [TE]
S 500	01/93-10/98	M 119.970	4973	für Fahrzeuge ohne Katalysator; :026391→; :→032287		0-N847	VB [TE]
S 350 Turbo-D	01/93-10/98	OM 603.971	3449	:→007421		0-N565592	FB [TE]
S-KLASSE Coupe (C140)							
SEC/CL 420	10/94-02/99	M 119.971, M 119.981	4196	Rippenanzahl: 6		0-N1288	VB [DG]
SEC/CL 420	10/94-02/99	M 119.971, M 119.981	4196	:011683→		0-N1860	VB [BT]
SEC/CL 420	10/94-02/99	M 119.971, M 119.981	4196	:→011682		0-N1862	VB [BT]
SEC/CL 420	10/94-02/99	M 119.971, M 119.981	4196	:→011682; Rippenanzahl: 8		0-N1864	VB [DG]
SEC/CL 420	10/94-02/99	M 119.971, M 119.981	4196	:011683→		0-N2141	VB [TE]
SEC/CL 420	10/94-02/99	M 119.971, M 119.981	4196	für Fahrzeuge ohne Katalysator; :011683→; :→016096		0-N847	VB [TE]
SEC/CL 500	10/92-02/99	M 119.970	4973	:026391→		0-N1860	VB [BT]
SEC/CL 500	10/92-02/99	M 119.970	4973	:→026390		0-N1862	VB [BT]



OPTIMAL®

MERCEDES-BENZ



CM³



Art. Nr.



S-KLASSE Coupe (C140)

SEC/CL 500	10/92-02/99	M 119.970	4973	: →026390; Rippenanzahl: 8	0-N1864	VB [DG]	
SEC/CL 500	10/92-02/99	M 119.970	4973	:026391 →	0-N2141	VB [TE]	
SEC/CL 500	10/92-02/99	M 119.970	4973	für Fahrzeuge ohne Katalysator; :026391 →; : →032287	0-N847	VB [TE]	
SEC/CL 600	09/92-02/99	M 120.982	5987	Rippenanzahl: 6	0-N1288	VB [DG]	
SEC/CL 600	09/92-02/99	M 120.980	5987		0-N1861	VB [TE]	

S-KLASSE (W220)

S 280	10/98-08/05	M 112.922	2799	Rippenanzahl: 6	0-N1431	VB [DG]	
S 280	10/98-08/05	M 112.922	2799		0-N1645	VB [BT]	S
S 280	10/98-08/05	M 112.922	2799		0-N2142	VB [VD]	
S 320	10/98-08/05	M 112.944	3199	Rippenanzahl: 6	0-N1431	VB [DG]	
S 320	10/98-08/05	M 112.944	3199		0-N1645	VB [BT]	S
S 320 CDI	08/99-08/05	OM 613.960, OM 648.960	3222	Rippenanzahl: 6	0-N1431	VB [DG]	
S 320 CDI	08/99-08/05	OM 613.960, OM 648.960	3222		0-N1641	VB [BT]	S
S 350 , S 350 4-matic	09/02-08/05	M 112.972, M 112.975	3724	Rippenanzahl: 6	0-N1431	VB [DG]	
S 350 , S 350 4-matic	09/02-08/05	M 112.972, M 112.975	3724		0-N1645	VB [BT]	S
S 400 CDI	06/00-08/05	OM 628.960	3996		0-N2193	VB [BT]	S
S 400 CDI	06/00-08/05	OM 628.960	3996		0-N2218	VB [DG]	
S 430	10/98-08/05	M 113.941	4266	für Fahrzeuge mit höhenverstellbarem Fahrwerk	0-N2142	VB [VD]	
S 430 , S 430 4-matic	10/98-08/05	M 113.941, M 113.948	4266	Rippenanzahl: 6	0-N1431	VB [DG]	
S 430 , S 430 4-matic	10/98-08/05	M 113.941, M 113.948	4266		0-N1645	VB [BT]	S
S 500	10/98-08/05	M 113.960, M 113.966	4966	für Fahrzeuge mit höhenverstellbarem Fahrwerk	0-N2142	VB [VD]	
S 500 , S 500 4-matic	10/98-08/05	M 113.960, M 113.966, M 113.966	4966	Rippenanzahl: 6	0-N1431	VB [DG]	
S 500 , S 500 4-matic	10/98-08/05	M 113.960, M 113.966, M 113.966	4966		0-N1645	VB [BT]	S
S 55 AMG	04/99-08/05	M 113.986	5439	Rippenanzahl: 6	0-N1431	VB [DG]	
S 55 AMG , S 55 AMG Kompressor	04/99-08/05	M 113.986, M 113.991	5439		0-N1645	VB [BT]	S
S 600	01/00-08/05	M 137.970	5786		0-N1560	VB [DG]	
S 600	01/00-08/05	M 137.970	5786	Rippenanzahl: 7	0-N2131	VB [DG]	
S 600	09/02-08/05	M 275.950	5513		0-N1560	VB [DG]	
S 600	09/02-08/05	M 275.950	5513	Rippenanzahl: 7	0-N2131	VB [DG]	
S 65 AMG	03/04-08/05	M 275.980	5980		0-N1560	VB [DG]	
S 65 AMG	03/04-08/05	M 275.980	5980	Rippenanzahl: 7	0-N2131	VB [DG]	

S-KLASSE Coupe (C215)

CL 500	03/99-03/06	M 113.960	4966	Rippenanzahl: 6	0-N1431	VB [DG]	
CL 500	03/99-03/06	M 113.960	4966		0-N1645	VB [BT]	S
CL 55 AMG	10/99-03/06	M 113.986	5439	Rippenanzahl: 6	0-N1431	VB [DG]	
CL 55 AMG , CL 55 AMG Kompressor	10/99-03/06	M 113.986, M 113.991	5439		0-N1645	VB [BT]	S
CL 600	03/99-03/06	M 137.970	5786		0-N1560	VB [DG]	
CL 600	03/99-03/06	M 137.970	5786	Rippenanzahl: 7	0-N2131	VB [DG]	
CL 600	09/02-03/06	M 275.950	5513		0-N1560	VB [DG]	
CL 600	09/02-03/06	M 275.950	5513	Rippenanzahl: 7	0-N2131	VB [DG]	
CL 65 AMG	09/03-03/06	M 275.980	5980		0-N1560	VB [DG]	
CL 65 AMG	09/03-03/06	M 275.980	5980	Rippenanzahl: 7	0-N2131	VB [DG]	

S-KLASSE (W221)

S 250 CDI	01/11-12/13	OM 651.961	2143	für Fahrzeuge ohne Start-Stopp-Funktion	0-N2083	VB [BT]	S
S 250 CDI	01/11-12/13	OM 651.961	2143		0-N2205	VB [DG]	
S 250 CDI	01/11-12/13	OM 651.961	2143		0-N2238	VB [DG]	
S 250 CDI	01/11-12/13	OM 651.961	2143	für Fahrzeuge mit Start-Stopp-Funktion	0-N2422	VB [BT]	S
S 320 CDI / S 350 CDI , S 320 CDI 4-matic	12/05-12/13	OM 642.930, OM 642.932	2987	Rippenanzahl: 6;	0-N1437	VB [DG]	
S 320 CDI / S 350 CDI , S 320 CDI 4-matic	12/05-12/13	OM 642.930, OM 642.932	2987	→ 11/2007	0-N2132	VB [DG]	
S 320 CDI, S 320 CDI / S 350 CDI , S 320 CDI 4-matic	10/05-12/13	OM 642.930, OM 642.932	2987	11/2007 →; :4077760 →	0-N1560	VB [DG]	
S 320 CDI, S 320 CDI / S 350 CDI , S 320 CDI 4-matic	10/05-12/13	OM 642.930, OM 642.932	2987	11/2007 →	0-N1902	VB [BT]	S
S 320 CDI, S 320 CDI / S 350 CDI , S 320 CDI 4-matic	10/05-12/13	OM 642.930, OM 642.932	2987	→ 11/2007	0-N2219	VB [BT]	S
S 350 , S 350 4-matic	10/05-12/13	M 272.965, M 272.975	3498	Rippenanzahl: 6;	0-N1437	VB [DG]	
S 350 , S 350 4-matic	10/05-12/13	M 272.965, M 272.975	3498	Rippenanzahl: 6	0-N1637	VB [DG]	
S 350 , S 350 4-matic , S 400 Hybrid	10/05-12/13	M 272.965, M 272.974, M 272.975	3498		0-N1670	VB [BT]	S
S 350 , S 350 4-matic , S 400 Hybrid	10/05-12/13	M 272.965, M 272.974, M 272.975	3498		0-N2138	VB [DG]	
S 350 , S 350 4-matic , S 400 Hybrid	10/05-12/13	M 272.965, M 272.974, M 272.975	3498		0-N2143	VB [VD]	
S 350 BlueTec , S 350 BlueTEC 4-matic	04/11-12/13	OM 642.862, OM 642.868	2987		0-N1902	VB [BT]	S



CM³



Art. Nr.



ohne Halter

S-KLASSE (W221)								
S 350 BlueTec, S 350 BlueTEC 4-matic, S 350 CDI	06/09-12/13	OM 642.862, OM 642.868, OM 642.930	2987				0-N1560	VB [DG]
S 350 CGI, S 350 CGI 4-matic	04/11-12/13	M 276.950	3498				0-N2368	VB [DG]
S 350 CGI, S 350 CGI 4-matic	04/11-12/13	M 276.950	3498				0-N2403	VB [BT] S
S 450, S 450 4-matic	12/05-12/13	M 273.922, M 273.924	4663	Rippenanzahl: 6;			0-N1437	VB [DG]
S 450, S 450 4-matic	12/05-12/13	M 273.922, M 273.924	4663	Rippenanzahl: 6			0-N1637	VB [DG]
S 450, S 450 4-matic	12/05-12/13	M 273.922, M 273.924	4663				0-N1670	VB [BT] S
S 450, S 450 4-matic	12/05-12/13	M 273.922, M 273.924	4663				0-N2138	VB [DG]
S 500, S 500 4-matic	10/05-12/13	M 273.961, M 273.961, M 273.968	5461	Rippenanzahl: 6;			0-N1437	VB [DG]
S 500, S 500 4-matic	10/05-12/13	M 273.961, M 273.961, M 273.968	5461	Rippenanzahl: 6			0-N1637	VB [DG]
S 500, S 500 4-matic	10/05-12/13	M 273.961, M 273.961, M 273.968	5461				0-N1670	VB [BT] S
S 500, S 500 4-matic	10/05-12/13	M 273.961, M 273.961, M 273.968	5461				0-N2138	VB [DG]
S 500 CGI, S 500 CGI 4-matic	03/11-12/13	M 278.932	4663				0-N2284	VB [DG]
S 600	12/05-12/13	M 275.953	5513				0-N1560	VB [DG]
S 600	12/05-12/13	M 275.953	5513	Rippenanzahl: 7			0-N2131	VB [DG]
S 63 AMG	10/06-12/13	M 156.984	6208	Rippenanzahl: 6			0-N2120	VB [DG]
S 63 AMG	03/11-12/13	M 157.980	5461				0-N2284	VB [DG]
S 65 AMG	12/05-12/13	M 275.982	5980				0-N1560	VB [DG]
S 65 AMG	12/05-12/13	M 275.982	5980	Rippenanzahl: 7			0-N2131	VB [DG]
S-KLASSE Cabriolet (A217)								
AMG S 63 4-matic	12/15-	M 157.985	5461				0-N2284	VB [DG]
S 500	12/15-	M 278.929	4663				0-N2284	VB [DG]
S-KLASSE Coupe (C216)								
CL 500, CL 500 4-matic	02/11-12/13	M 278.920	4663				0-N2284	VB [DG]
CL 600	05/06-12/13	M 275.953	5513				0-N1560	VB [DG]
CL 600	05/06-12/13	M 275.953	5513	Rippenanzahl: 7			0-N2131	VB [DG]
CL 63 AMG	10/06-12/13	M 156.984	6208	Rippenanzahl: 6			0-N2120	VB [DG]
CL 63 AMG	01/10-12/13	M 157.980	5461				0-N2284	VB [DG]
CL 65 AMG	10/06-12/13	M 275.982	5980				0-N1560	VB [DG]
CL 65 AMG	10/06-12/10	M 275.982	5980	Rippenanzahl: 7			0-N2131	VB [DG]
S-KLASSE Coupe (C217)								
S 500, S 500 4-matic	04/14-	M 278.929	4663				0-N2284	VB [DG]
S 63 AMG, S 63 AMG 4-matic	04/14-	M 157.985	5461				0-N2284	VB [DG]
SL (R107)								
300 SL	09/85-08/89	M 103.982	2960				0-N1011	VB [BT] S
300 SL	09/85-08/89	M 103.982	2960				0-N1278	VB [TE]
300 SL	09/85-08/89	M 103.982	2960				0-N2146	VB [VD]
SL (R129)								
280	08/93-10/01	M 104.943	2799	:→000900, 003620			0-N1011	VB [BT] S
280	08/93-10/01	M 104.943	2799	:→000900, 003620			0-N1278	VB [TE]
280	08/93-10/01	M 104.943	2799	:000901, 003621→			0-N1282	VB [TE]
280	08/93-10/01	M 104.943	2799				0-N1283	VB [TE]
280	08/93-10/01	M 104.943	2799	Rippenanzahl: 6			0-N1288	VB [DG]
280	08/93-10/01	M 104.943	2799	:000901, 003621→; :→001434, 006116			0-N2141	VB [TE]
280	08/93-10/01	M 104.943	2799	:→000900, 003620			0-N2146	VB [VD]
280	05/98-10/01	M 112.923, M 112.925	2799	Rippenanzahl: 6			0-N1431	VB [DG]
280	05/98-10/01	M 112.923, M 112.925	2799				0-N1645	VB [BT] S
280	05/98-10/01	M 112.923, M 112.925	2799				0-N2142	VB [VD]
300 SL, 300 SL-24	03/89-08/93	M 103.984, M 104.981	2960				0-N1011	VB [BT] S
300 SL, 300 SL-24	03/89-08/93	M 103.984, M 104.981	2960				0-N1278	VB [TE]
300 SL, 300 SL-24	03/89-08/93	M 103.984, M 104.981	2960	für Fahrzeuge mit Katalysator; Rippenanzahl: 6			0-N1288	VB [DG]
300 SL, 300 SL-24	03/89-08/93	M 103.984, M 104.981	2960				0-N2146	VB [VD]
300 SL, 300 SL-24	03/89-08/93	M 103.984, M 104.981	2960	für Fahrzeuge ohne Katalysator			0-N847	VB [TE]
320	09/93-10/01	M 104.991	3199	:→009985			0-N1011	VB [BT] S
320	09/93-10/01	M 104.991	3199	:→009985			0-N1278	VB [TE]
320	09/93-10/01	M 104.991	3199	:009986→			0-N1282	VB [TE]
320	09/93-10/01	M 104.991	3199				0-N1283	VB [TE]
320	09/93-10/01	M 104.991	3199	Rippenanzahl: 6			0-N1288	VB [DG]
320	09/93-10/01	M 104.991	3199	:009986→; :→020513			0-N2141	VB [TE]
320	09/93-10/01	M 104.991	3199	:→009985			0-N2146	VB [VD]
320	05/98-10/01	M 112.943	3199	Rippenanzahl: 6			0-N1431	VB [DG]
320	05/98-10/01	M 112.943	3199				0-N1645	VB [BT] S



OPTIMAL®

MERCEDES-BENZ



CM³



Art. Nr.



SL (R129)							
500	09/92-10/01	M 119.982	4973	Rippenanzahl: 6	0-N1288	VB [DG]	
500	09/92-10/01	M 119.972, M 119.982	4973		0-N1860	VB [BT]	
500	09/92-10/01	M 119.972, M 119.982	4973		0-N2141	VB [TE]	
500	09/92-10/01	M 119.972	4973		0-N847	VB [TE]	
500	05/98-10/01	M 113.961	4966	Rippenanzahl: 6	0-N1431	VB [DG]	
500	05/98-10/01	M 113.961	4966		0-N1645	VB [BT]	S
500 SL	09/89-08/92	M 119.972	4973		0-N1860	VB [BT]	
500 SL	09/89-08/92	M 119.972	4973		0-N2141	VB [TE]	
500 SL	09/89-08/92	M 119.960, M 119.972	4973		0-N846	VB [TE]	
500 SL	09/89-08/92	M 119.960, M 119.972	4973		0-N847	VB [TE]	
600	07/92-10/01	M 120.983	5987	Rippenanzahl: 6	0-N1288	VB [DG]	
600	07/92-10/01	M 120.981	5987		0-N1861	VB [TE]	
600 SL	02/92-08/94	M 120.981, M 120.983, M 120.983	5987		0-N1861	VB [TE]	
SL (R230)							
280, 300	03/08-01/12	M 272.949	2996	Rippenanzahl: 6	0-N1637	VB [DG]	
280, 300	03/08-01/12	M 272.949	2996		0-N1670	VB [BT]	S
280, 300	03/08-01/12	M 272.949	2996		0-N2138	VB [DG]	
280, 300	03/08-01/12	M 272.949	2996		0-N2143	VB [VD]	
350	03/03-01/12	M 112.973	3724	Rippenanzahl: 6	0-N1431	VB [DG]	
350	03/03-01/12	M 112.973	3724		0-N1645	VB [BT]	S
350	03/03-01/12	M 112.973	3724		0-N2142	VB [VD]	
350	03/06-01/12	M 272.966, M 272.968	3498	Rippenanzahl: 6	0-N1637	VB [DG]	
350	03/06-01/12	M 272.966, M 272.968	3498		0-N1670	VB [BT]	S
350	03/06-01/12	M 272.966, M 272.968	3498		0-N2138	VB [DG]	
350	03/06-01/12	M 272.966, M 272.968	3498		0-N2143	VB [VD]	
500	10/01-01/12	M 113.963	4966	Rippenanzahl: 6	0-N1431	VB [DG]	
500	10/01-01/12	M 113.963	4966		0-N1645	VB [BT]	S
500	03/06-01/12	M 273.965	5461	Rippenanzahl: 6	0-N1637	VB [DG]	
500	03/06-01/12	M 273.965	5461		0-N1670	VB [BT]	S
500	03/06-01/12	M 273.965	5461		0-N2138	VB [DG]	
55 AMG , 55 AMG Kompressor	10/01-01/12	M 113.992, M 113.995	5439		0-N1645	VB [BT]	S
600	04/03-01/12	M 275.951, M 275.954	5513		0-N1560	VB [DG]	
600	04/03-01/12	M 275.951, M 275.954	5513	Rippenanzahl: 7	0-N2131	VB [DG]	
63AMG	03/08-01/12	M 156.981	6208	Rippenanzahl: 6	0-N2120	VB [DG]	
65 AMG	03/04-01/12	M 275.981	5980		0-N1560	VB [DG]	
65 AMG	03/04-01/12	M 275.981	5980	Rippenanzahl: 7	0-N2131	VB [DG]	
SL (R231)							
350	02/12-	M 276.954	3498		0-N2368	VB [DG]	
350	02/12-	M 276.954	3498		0-N2403	VB [BT]	S
400	04/14-	M 276.825	2996		0-N2368	VB [DG]	
400	04/14-	M 276.825	2996		0-N2403	VB [BT]	S
500	01/12-	M 278.927	4663		0-N2284	VB [DG]	
63 AMG	01/12-	M 157.983	5461		0-N2284	VB [DG]	
SLK (R170)							
200	09/96-03/00	M 111.946	1998	→ 09/1999	0-N1951	VB [VD]	
200 Kompressor	10/96-04/04	M 111.943, M 111.958	1998		0-N1442	VB [DG]	
200 Kompressor	10/96-04/04	M 111.943, M 111.958	1998		0-N1951	VB [VD]	
200 Kompressor	10/96-03/00	M 111.943	1998		0-N2141	VB [TE]	
200 Kompressor	10/96-04/04	M 111.943, M 111.958	1998		0-N2148	VB [BT]	
200 Kompressor	03/00-04/04	M 111.958	1998		0-N1283	VB [TE]	
200, 200 Kompressor	09/96-04/04	M 111.943, M 111.946, M 111.958	1998		0-N1703	VB [BT]	
200, 200 Kompressor	09/96-04/04	M 111.943, M 111.946, M 111.958	1998		0-N1833	VB [TE]	
200, 200 Kompressor	09/96-04/04	M 111.943, M 111.946, M 111.958	1998		0-N2418	VB [BT]	
230 Kompressor	09/96-04/04	M 111.973, M 111.983	2295		0-N1442	VB [DG]	
230 Kompressor	09/96-04/04	M 111.973, M 111.983	2295		0-N1703	VB [BT]	
230 Kompressor	09/96-04/04	M 111.973, M 111.983	2295		0-N1833	VB [TE]	
230 Kompressor	09/96-03/00	M 111.973	2295		0-N1951	VB [VD]	
230 Kompressor	09/96-04/04	M 111.973, M 111.983	2295		0-N2141	VB [TE]	
230 Kompressor	09/96-04/04	M 111.973, M 111.983	2295		0-N2148	VB [BT]	
230 Kompressor	09/96-04/04	M 111.973, M 111.983	2295		0-N2418	VB [BT]	
230 Kompressor	03/00-04/04	M 111.983	2295	→ 01/2004	0-N1951	VB [VD]	
32 AMG Kompressor	03/01-04/04	M 112.960	3199		0-N1861	VB [TE]	
320	03/00-04/04	M 112.947	3199	Rippenanzahl: 6	0-N1431	VB [DG]	
320	03/00-04/04	M 112.947	3199		0-N1645	VB [BT]	S



CM³



Art. Nr.



ohne Halter

SLK (R170)							
320	03/00-04/04	M 112.947	3199			0-N2142	VB [VD]
SLK (R171)							
200 Kompressor	03/04-02/11	M 271.944	1795	†		0-N1457	VB [DG]
200 Kompressor	03/04-02/11	M 271.944	1795	→ 03/2009		0-N1587	VB [BT] S
200 Kompressor	03/04-02/11	M 271.944	1795			0-N2136	VB [BT] S
200 Kompressor	03/04-02/11	M 271.944	1795			0-N2206	VB [DG]
200 Kompressor	01/08-02/11	M 271.954	1796	†		0-N1457	VB [DG]
200 Kompressor	01/08-02/11	M 271.954	1796	→ 03/2009		0-N1587	VB [BT] S
200 Kompressor	01/08-02/11	M 271.954	1796			0-N2136	VB [BT] S
200 Kompressor	01/08-02/11	M 271.954	1796			0-N2206	VB [DG]
280	01/05-02/11	M 272.942	2996	Rippenanzahl: 6		0-N1637	VB [DG]
280	01/05-02/11	M 272.942	2996			0-N1670	VB [BT] S
280	01/05-02/11	M 272.942	2996	→ 30058376		0-N1746	VB [DG]
280, 300	01/05-02/11	M 272.942	2996			0-N2138	VB [DG]
280, 300	01/05-02/11	M 272.942	2996			0-N2143	VB [VD]
350	06/04-02/11	M 272.963, M 272.969	3498	Rippenanzahl: 6		0-N1637	VB [DG]
350	06/04-02/11	M 272.963, M 272.969	3498			0-N1670	VB [BT] S
350	06/04-02/11	M 272.963	3498	→ 02/2005; → 30058376		0-N1746	VB [DG]
350	06/04-02/11	M 272.963	3498	02/2005 →; : 30058377 →		0-N2138	VB [DG]
350	06/04-02/11	M 272.963, M 272.969	3498			0-N2143	VB [VD]
350	01/08-02/11	M 272.969	3498			0-N2138	VB [DG]
55 AMG	06/04-02/11	M 113.989	5439			0-N1645	VB [BT] S
SLK (R172)							
200, 250	02/11-	M 271.860, M 271.861	1796			0-N2119	VB [DG]
200, 250	02/11-	M 271.860, M 271.861	1796	Rippenanzahl: 6		0-N2120	VB [DG]
200, 250	02/11-	M 271.860, M 271.861	1796			0-N2136	VB [BT] S
250 CDI	01/12-	OM 651.980	2143	für Fahrzeuge ohne Start-Stopp-Funktion		0-N2083	VB [BT] S
250 CDI	01/12-	OM 651.980	2143			0-N2205	VB [DG]
250 CDI	01/12-	OM 651.980	2143			0-N2238	VB [DG]
250 CDI	01/12-	OM 651.980	2143			0-N2307	VB [BT] S
250 CDI	01/12-	OM 651.980	2143	für Fahrzeuge mit Start-Stopp-Funktion		0-N2422	VB [BT] S
350	02/11-	M 276.956	3498			0-N2368	VB [DG]
350	02/11-	M 276.956	3498			0-N2403	VB [BT] S
55 AMG	01/12-	M 152.980	5461			0-N2284	VB [DG]
SLR (R199)							
5.4, 5.4 722 Edition	04/04-	M 155.980	5439			0-N1560	VB [DG]
SLR ROADSTER (R199)							
5.4	10/06-	M 155.980	5439			0-N1560	VB [DG]
SLS AMG (C197)							
6.2, 6.2 GT	03/10-	M 159.980	6208	Rippenanzahl: 6		0-N2120	VB [DG]
SLS AMG Cabriolet (A197)							
6.2, 6.2 GT	06/11-	M 159.980	6208	Rippenanzahl: 6		0-N2120	VB [DG]
SPRINTER 2-t Bus (901, 902)							
208 CDI, 211 CDI, 213 CDI	04/00-05/06	OM 611.981, OM 611.987	2148	Rippenanzahl: 6		0-N1431	VB [DG]
208 CDI, 211 CDI, 213 CDI	04/00-05/06	OM 611.981, OM 611.987	2148	Rippenanzahl: 6;		0-N1436	VB [DG] S
208 CDI, 211 CDI, 213 CDI	04/00-05/06	OM 611.981, OM 611.987	2148	Rippenanzahl: 6;		0-N1437	VB [DG]
208 CDI, 211 CDI, 213 CDI	04/00-05/06	OM 611.981, OM 611.987	2148			0-N1641	VB [BT] S
208 D	02/95-04/00	OM 601.943	2299			0-N1043	VB [BT]
208 D	02/95-04/00	OM 601.943	2299	Rippenanzahl: 6; für Fahrzeuge ohne Servolenkung		0-N1288	VB [DG]
208 D	02/95-04/00	OM 601.943	2299	Rippenanzahl: 6;		0-N1288	VB [DG]
208 D	02/95-04/00	OM 601.943	2299			0-N2147	VB [VD]
208 D	02/95-04/00	OM 601.943	2299			0-N846	VB [TE]
208 D	02/95-04/00	OM 601.943	2299	für Fahrzeuge mit Servolenkung		0-N847	VB [TE]
208 D	02/95-04/00	OM 601.943	2299	für Fahrzeuge ohne Servolenkung		0-N847	VB [TE]
208 D	02/95-04/00	OM 601.943	2299			0-N847	VB [TE]
210 D, 212 D	02/95-04/00	OM 602.980	2874			0-N1043	VB [BT]
210 D, 212 D	02/95-04/00	OM 602.980	2874			0-N2147	VB [VD]
210 D, 212 D	02/95-04/00	OM 602.980	2874			0-N846	VB [TE]
210 D, 212 D	02/95-04/00	OM 602.980	2874			0-N847	VB [TE]
214, 214 NGT	02/95-05/06	M 111.979, M 111.984	2295			0-N1703	VB [BT]
214, 214 NGT	02/95-05/06	M 111.979, M 111.984	2295			0-N1833	VB [TE]
214, 214 NGT	02/95-05/06	M 111.979, M 111.984	2295			0-N1951	VB [VD]



OPTIMAL®

MERCEDES-BENZ



CM³



Art. Nr.



SPRINTER 2-t Bus (901, 902)

214, 214 NGT	02/95-05/06	M 111.979, M 111.984	2295		0-N2418	VB [BT]	
216 CDI	04/00-05/06	OM 612.981	2685	Rippenanzahl: 6	0-N1431	VB [DG]	
216 CDI	04/00-05/06	OM 612.981	2685	Rippenanzahl: 6;	0-N1436	VB [DG]	S
216 CDI	04/00-05/06	OM 612.981	2685	Rippenanzahl: 6;	0-N1437	VB [DG]	S
216 CDI	04/00-05/06	OM 612.981	2685		0-N1641	VB [BT]	S

SPRINTER 2-t Kasten (901, 902)

208 CDI, 211 CDI, 213 CDI	04/00-05/06	OM 611.981, OM 611.987	2148	Rippenanzahl: 6	0-N1431	VB [DG]	
208 CDI, 211 CDI, 213 CDI	04/00-05/06	OM 611.981, OM 611.987	2148	Rippenanzahl: 6;	0-N1436	VB [DG]	S
208 CDI, 211 CDI, 213 CDI	04/00-05/06	OM 611.981, OM 611.987	2148	Rippenanzahl: 6;	0-N1437	VB [DG]	S
208 CDI, 211 CDI, 213 CDI	04/00-05/06	OM 611.981, OM 611.987	2148		0-N1641	VB [BT]	S
208 D	02/95-04/00	OM 601.943	2299		0-N1043	VB [BT]	
208 D	02/95-04/00	OM 601.943	2299	Rippenanzahl: 6; für Fahrzeuge ohne Servolenkung	0-N1288	VB [DG]	
208 D	02/95-04/00	OM 601.943	2299	Rippenanzahl: 6;	0-N1288	VB [DG]	
208 D	02/95-04/00	OM 601.943	2299		0-N2147	VB [VD]	
208 D	02/95-04/00	OM 601.943	2299		0-N846	VB [TE]	
208 D	02/95-04/00	OM 601.943	2299	für Fahrzeuge mit Servolenkung	0-N847	VB [TE]	
208 D	02/95-04/00	OM 601.943	2299	für Fahrzeuge ohne Servolenkung	0-N847	VB [TE]	
208 D	02/95-04/00	OM 601.943	2299		0-N847	VB [TE]	
210 D, 212 D	02/95-04/00	OM 602.980	2874		0-N1043	VB [BT]	
210 D, 212 D	02/95-04/00	OM 602.980	2874		0-N2147	VB [VD]	
210 D, 212 D	02/95-04/00	OM 602.980	2874		0-N846	VB [TE]	
210 D, 212 D	02/95-04/00	OM 602.980	2874		0-N847	VB [TE]	
214, 214 NGT	02/95-05/06	M 111.979, M 111.984, M 111.984	2295		0-N1703	VB [BT]	
214, 214 NGT	02/95-05/06	M 111.979, M 111.984, M 111.984	2295		0-N1833	VB [TE]	
214, 214 NGT	02/95-05/06	M 111.979, M 111.984, M 111.984	2295		0-N1951	VB [VD]	
214, 214 NGT	02/95-05/06	M 111.979, M 111.984, M 111.984	2295		0-N2418	VB [BT]	
216 CDI	04/00-05/06	OM 612.981	2685	Rippenanzahl: 6	0-N1431	VB [DG]	
216 CDI	04/00-05/06	OM 612.981	2685	Rippenanzahl: 6;	0-N1436	VB [DG]	S
216 CDI	04/00-05/06	OM 612.981	2685	Rippenanzahl: 6;	0-N1437	VB [DG]	S
216 CDI	04/00-05/06	OM 612.981	2685		0-N1641	VB [BT]	S

SPRINTER 2-t Pritsche/Fahrgestell (901, 902)

208 CDI, 211 CDI, 213 CDI	04/00-05/06	OM 611.981, OM 611.987	2148	Rippenanzahl: 6	0-N1431	VB [DG]	
208 CDI, 211 CDI, 213 CDI	04/00-05/06	OM 611.981, OM 611.987	2148	Rippenanzahl: 6;	0-N1436	VB [DG]	S
208 CDI, 211 CDI, 213 CDI	04/00-05/06	OM 611.981, OM 611.987	2148	Rippenanzahl: 6;	0-N1437	VB [DG]	S
208 CDI, 211 CDI, 213 CDI	04/00-05/06	OM 611.981, OM 611.987	2148		0-N1641	VB [BT]	S
208 D	01/95-04/00	OM 601.943	2299		0-N1043	VB [BT]	
208 D	01/95-04/00	OM 601.943	2299	Rippenanzahl: 6; für Fahrzeuge ohne Servolenkung	0-N1288	VB [DG]	
208 D	01/95-04/00	OM 601.943	2299	Rippenanzahl: 6;	0-N1288	VB [DG]	
208 D	01/95-04/00	OM 601.943	2299		0-N2147	VB [VD]	
208 D	01/95-04/00	OM 601.943	2299		0-N846	VB [TE]	
208 D	01/95-04/00	OM 601.943	2299	für Fahrzeuge mit Servolenkung	0-N847	VB [TE]	
208 D	01/95-04/00	OM 601.943	2299	für Fahrzeuge ohne Servolenkung	0-N847	VB [TE]	
208 D	01/95-04/00	OM 601.943	2299		0-N847	VB [TE]	
210 D, 212 D	02/95-04/00	OM 602.980	2874		0-N1043	VB [BT]	
210 D, 212 D	02/95-04/00	OM 602.980	2874		0-N2147	VB [VD]	
210 D, 212 D	02/95-04/00	OM 602.980	2874		0-N846	VB [TE]	
210 D, 212 D	02/95-04/00	OM 602.980	2874		0-N847	VB [TE]	
214, 214 NGT	02/95-05/06	M 111.979, M 111.984	2295		0-N1703	VB [BT]	
214, 214 NGT	02/95-05/06	M 111.979, M 111.984	2295		0-N1833	VB [TE]	
214, 214 NGT	02/95-05/06	M 111.979, M 111.984	2295		0-N1951	VB [VD]	
214, 214 NGT	02/95-05/06	M 111.979, M 111.984	2295		0-N2418	VB [BT]	
216 CDI	04/00-05/06	OM 612.981	2685	Rippenanzahl: 6	0-N1431	VB [DG]	
216 CDI	04/00-05/06	OM 612.981	2685	Rippenanzahl: 6;	0-N1436	VB [DG]	S
216 CDI	04/00-05/06	OM 612.981	2685	Rippenanzahl: 6;	0-N1437	VB [DG]	S
216 CDI	04/00-05/06	OM 612.981	2685		0-N1641	VB [BT]	S

SPRINTER 3-t Bus (903)

2.9 TDi, 310 D 4x4, 312 D 2.9, 312 D 2.9 4x4	02/95-08/02	OM 602.980	2874		0-N1043	VB [BT]	
2.9 TDi, 310 D 4x4, 312 D 2.9, 312 D 2.9 4x4	02/95-08/02	OM 602.980	2874		0-N2147	VB [VD]	
2.9 TDi, 310 D 4x4, 312 D 2.9, 312 D 2.9 4x4	02/95-08/02	OM 602.980	2874		0-N847	VB [TE]	
308 CDI, 311 CDI, 311 CDI 4x4, 313 CDI, 313 CDI 4x4	04/00-05/06	OM 611.981, OM 611.987	2148	Rippenanzahl: 6	0-N1431	VB [DG]	



CM³



Art. Nr.



ohne Halter

SPRINTER 3-t Bus (903)								
308 CDI, 311 CDI, 311 CDI 4x4, 313 CDI, 313 CDI 4x4	04/00-05/06	OM 611.981, OM 611.987	2148	Rippenanzahl: 6; ☼	0-N1436	VB [DG]	S	
308 CDI, 311 CDI, 311 CDI 4x4, 313 CDI, 313 CDI 4x4	04/00-05/06	OM 611.981, OM 611.987	2148	Rippenanzahl: 6; ☼	0-N1437	VB [DG]		
308 CDI, 311 CDI, 311 CDI 4x4, 313 CDI, 313 CDI 4x4	04/00-05/06	OM 611.981, OM 611.987	2148		0-N1641	VB [BT]	S	
308 D	02/95-04/00	OM 601.943	2299		0-N1043	VB [BT]		
308 D	02/95-04/00	OM 601.943	2299	Rippenanzahl: 6; für Fahrzeuge ohne Servolenkung	0-N1288	VB [DG]		
308 D	02/95-04/00	OM 601.943	2299	Rippenanzahl: 6; ☼	0-N1288	VB [DG]		
308 D	02/95-04/00	OM 601.943	2299		0-N2147	VB [VD]		
308 D	02/95-04/00	OM 601.943	2299		0-N846	VB [TE]		
308 D	02/95-04/00	OM 601.943	2299	für Fahrzeuge mit Servolenkung	0-N847	VB [TE]		
308 D	02/95-04/00	OM 601.943	2299	für Fahrzeuge ohne Servolenkung	0-N847	VB [TE]		
308 D	02/95-04/00	OM 601.943	2299	☼	0-N847	VB [TE]		
310 D 4x4, 312 D 2.9, 312 D 2.9 4x4	02/95-08/02	OM 602.980	2874		0-N846	VB [TE]		
314, 314 4x4, 314 NGT	02/95-05/06	M 111.984	2295		0-N1703	VB [BT]		
314, 314 4x4, 314 NGT	02/95-05/06	M 111.984	2295		0-N1833	VB [TE]		
314, 314 4x4, 314 NGT	02/95-05/06	M 111.984	2295		0-N1951	VB [VD]		
314, 314 4x4, 314 NGT	02/95-05/06	M 111.984	2295		0-N2418	VB [BT]		
316 CDI, 316 CDI 4x4	04/00-05/06	OM 612.981	2685	Rippenanzahl: 6	0-N1431	VB [DG]		
316 CDI, 316 CDI 4x4	04/00-05/06	OM 612.981	2685	Rippenanzahl: 6; ☼	0-N1436	VB [DG]	S	
316 CDI, 316 CDI 4x4	04/00-05/06	OM 612.981	2685	Rippenanzahl: 6; ☼	0-N1437	VB [DG]		
316 CDI, 316 CDI 4x4	04/00-05/06	OM 612.981	2685		0-N1641	VB [BT]	S	
SPRINTER 3-t Kasten (903)								
308 CDI, 311 CDI, 311 CDI 4x4, 313 CDI, 313 CDI 4x4	04/00-05/06	OM 611.981, OM 611.987	2148	Rippenanzahl: 6	0-N1431	VB [DG]		
308 CDI, 311 CDI, 311 CDI 4x4, 313 CDI, 313 CDI 4x4	04/00-05/06	OM 611.981, OM 611.987	2148	Rippenanzahl: 6; ☼	0-N1436	VB [DG]	S	
308 CDI, 311 CDI, 311 CDI 4x4, 313 CDI, 313 CDI 4x4	04/00-05/06	OM 611.981, OM 611.987	2148	Rippenanzahl: 6; ☼	0-N1437	VB [DG]		
308 CDI, 311 CDI, 311 CDI 4x4, 313 CDI, 313 CDI 4x4	04/00-05/06	OM 611.981, OM 611.987	2148		0-N1641	VB [BT]	S	
308 D 2.3	02/95-04/00	OM 601.943	2299		0-N1043	VB [BT]		
308 D 2.3	02/95-04/00	OM 601.943	2299	Rippenanzahl: 6; für Fahrzeuge ohne Servolenkung	0-N1288	VB [DG]		
308 D 2.3	02/95-04/00	OM 601.943	2299	Rippenanzahl: 6; ☼	0-N1288	VB [DG]		
308 D 2.3	02/95-04/00	OM 601.943	2299		0-N2147	VB [VD]		
308 D 2.3	02/95-04/00	OM 601.943	2299		0-N846	VB [TE]		
308 D 2.3	02/95-04/00	OM 601.943	2299	für Fahrzeuge mit Servolenkung	0-N847	VB [TE]		
308 D 2.3	02/95-04/00	OM 601.943	2299	für Fahrzeuge ohne Servolenkung	0-N847	VB [TE]		
308 D 2.3	02/95-04/00	OM 601.943	2299	☼	0-N847	VB [TE]		
310 D 2.9, 312 D 2.9, 312 D 2.9 4x4	02/95-08/02	OM 602.980	2874		0-N1043	VB [BT]		
310 D 2.9, 312 D 2.9, 312 D 2.9 4x4	02/95-08/02	OM 602.980	2874		0-N2147	VB [VD]		
310 D 2.9, 312 D 2.9, 312 D 2.9 4x4	02/95-08/02	OM 602.980	2874		0-N846	VB [TE]		
310 D 2.9, 312 D 2.9, 312 D 2.9 4x4	02/95-08/02	OM 602.980	2874	☼	0-N847	VB [TE]		
314, 314 4x4, 314 NGT	02/95-05/06	M 111.979, M 111.984, M 111.984	2295		0-N1703	VB [BT]		
314, 314 4x4, 314 NGT	02/95-05/06	M 111.979, M 111.984, M 111.984	2295		0-N1833	VB [TE]		
314, 314 4x4, 314 NGT	02/95-05/06	M 111.979, M 111.984, M 111.984	2295		0-N1951	VB [VD]		
314, 314 4x4, 314 NGT	02/95-05/06	M 111.979, M 111.984, M 111.984	2295		0-N2418	VB [BT]		
316 CDI, 316 CDI 4x4	04/00-05/06	OM 612.981	2685	Rippenanzahl: 6	0-N1431	VB [DG]		
316 CDI, 316 CDI 4x4	04/00-05/06	OM 612.981	2685	Rippenanzahl: 6; ☼	0-N1436	VB [DG]	S	
316 CDI, 316 CDI 4x4	04/00-05/06	OM 612.981	2685	Rippenanzahl: 6; ☼	0-N1437	VB [DG]		
316 CDI, 316 CDI 4x4	04/00-05/06	OM 612.981	2685		0-N1641	VB [BT]	S	
SPRINTER 3-t Pritsche/Fahrgestell (903)								
308 CDI, 311 CDI, 311 CDI 4x4, 313 CDI, 313 CDI 4x4	04/00-05/06	OM 611.981, OM 611.987	2148	Rippenanzahl: 6	0-N1431	VB [DG]		
308 CDI, 311 CDI, 311 CDI 4x4, 313 CDI, 313 CDI 4x4	04/00-05/06	OM 611.981, OM 611.987	2148	Rippenanzahl: 6; ☼	0-N1436	VB [DG]	S	
308 CDI, 311 CDI, 311 CDI 4x4, 313 CDI, 313 CDI 4x4	04/00-05/06	OM 611.981, OM 611.987	2148	Rippenanzahl: 6; ☼	0-N1437	VB [DG]		
308 CDI, 311 CDI, 311 CDI 4x4, 313 CDI, 313 CDI 4x4	04/00-05/06	OM 611.981, OM 611.987	2148		0-N1641	VB [BT]	S	
308 D 2.3	02/95-04/00	OM 601.943	2299		0-N1043	VB [BT]		
308 D 2.3	02/95-04/00	OM 601.943	2299	Rippenanzahl: 6; für Fahrzeuge ohne Servolenkung	0-N1288	VB [DG]		
308 D 2.3	02/95-04/00	OM 601.943	2299	Rippenanzahl: 6; ☼	0-N1288	VB [DG]		
308 D 2.3	02/95-04/00	OM 601.943	2299		0-N2147	VB [VD]		



CM³



Art. Nr.



ohne Halter

SPRINTER 3-t Pritsche/Fahrgestell (903)

308 D 2.3	02/95-04/00	OM 601.943	2299		0-N846	VB [TE]	
308 D 2.3	02/95-04/00	OM 601.943	2299	für Fahrzeuge mit Servolenkung	0-N847	VB [TE]	
308 D 2.3	02/95-04/00	OM 601.943	2299	für Fahrzeuge ohne Servolenkung	0-N847	VB [TE]	
308 D 2.3	02/95-04/00	OM 601.943	2299	☼	0-N847	VB [TE]	
310 D 2.9, 312 D 2.9	02/95-04/00	OM 602.980	2874		0-N1043	VB [BT]	
310 D 2.9, 312 D 2.9	02/95-04/00	OM 602.980	2874		0-N2147	VB [VD]	
310 D 2.9, 312 D 2.9	02/95-04/00	OM 602.980	2874		0-N846	VB [TE]	
310 D 2.9, 312 D 2.9	02/95-04/00	OM 602.980	2874	☼	0-N847	VB [TE]	
314, 314 4x4, 314 NGT	02/95-05/06	M 111.984	2295		0-N1703	VB [BT]	
314, 314 4x4, 314 NGT	02/95-05/06	M 111.984	2295		0-N1833	VB [TE]	
314, 314 4x4, 314 NGT	02/95-05/06	M 111.984	2295		0-N1951	VB [VD]	
314, 314 4x4, 314 NGT	02/95-05/06	M 111.984	2295		0-N2418	VB [BT]	
316 CDI, 316 CDI 4x4	04/00-05/06	OM 612.981	2685	Rippenanzahl: 6	0-N1431	VB [DG]	
316 CDI, 316 CDI 4x4	04/00-05/06	OM 612.981	2685	Rippenanzahl: 6; ☼	0-N1436	VB [DG]	S
316 CDI, 316 CDI 4x4	04/00-05/06	OM 612.981	2685	Rippenanzahl: 6; ☼	0-N1437	VB [DG]	
316 CDI, 316 CDI 4x4	04/00-05/06	OM 612.981	2685		0-N1641	VB [BT]	S

SPRINTER 3-t Bus (906)

210 CDI	03/09-	OM 651.955	2143	Rippenanzahl: 6; ☼	0-N1437	VB [DG]	
210 CDI, 213 CDI, 216 CDI	06/06-	OM 651.955, OM 651.955, OM 651.956, OM 651.955, OM 651.957	2143		0-N2238	VB [DG]	
210 CDI, 213 CDI, 216 CDI	06/06-	OM 651.955, OM 651.955, OM 651.956, OM 651.955, OM 651.957	2143		0-N2296	VB [DG]	
210 CDI, 213 CDI, 216 CDI	06/06-	OM 651.955, OM 651.955, OM 651.956, OM 651.955, OM 651.957	2143	Rippenanzahl: 6	0-N2312	VB [DG]	
211 CDI, 215 CDI	06/06-	OM 646.985, OM 646.986, OM 646.989, OM 646.990	2148	Rippenanzahl: 6	0-N1431	VB [DG]	
211 CDI, 215 CDI	06/06-	OM 646.985, OM 646.986, OM 646.989, OM 646.990	2148		0-N1641	VB [BT]	S
213 CDI, 216 CDI	06/06-	OM 651.955, OM 651.956, OM 651.955, OM 651.957	2143	für Fahrzeuge ohne Start-Stopp-Funktion	0-N2086	VB [BT]	S
216	09/08-	M 271.951	1796	†	0-N1457	VB [DG]	
216	09/08-	M 271.951	1796	→ 03/2009; ☼:→31216219	0-N1587	VB [BT]	S
216	09/08-	M 271.951	1796	☼:31216220→	0-N2136	VB [BT]	S
216	09/08-	M 271.951	1796		0-N2206	VB [DG]	
224	06/06-	M 272.979	3498	Rippenanzahl: 6	0-N1637	VB [DG]	
224	06/06-	M 272.979	3498		0-N1670	VB [BT]	S
224	06/06-	M 272.979	3498		0-N2138	VB [DG]	
224	06/06-	M 272.979	3498	☼	0-N2143	VB [VD]	
224	06/06-	M 272.979	3498	☼	0-N2419	VB [DG]	

SPRINTER 3-t Kasten (906)

209 CDI, 211 CDI, 213 CDI, 215 CDI	06/06-	OM 646.984, OM 646.985, OM 646.986, OM 651.955, OM 646.989, OM 646.990	2148	Rippenanzahl: 6	0-N1431	VB [DG]	
209 CDI, 211 CDI, 213 CDI, 215 CDI	06/06-	OM 646.984, OM 646.985, OM 646.986, OM 651.955, OM 646.989, OM 646.990	2148		0-N1641	VB [BT]	S
210 CDI	03/09-	OM 651.955	2143		0-N2086	VB [BT]	S
210 CDI, 213 CDI, 216 CDI	06/06-	OM 651.955, OM 651.955, OM 651.956, OM 651.955, OM 651.957	2143		0-N2238	VB [DG]	
210 CDI, 213 CDI, 216 CDI	06/06-	OM 651.955, OM 651.955, OM 651.956, OM 651.955, OM 651.957	2143		0-N2296	VB [DG]	
210 CDI, 213 CDI, 216 CDI	06/06-	OM 651.955, OM 651.955, OM 651.956, OM 651.955, OM 651.957	2143	Rippenanzahl: 6	0-N2312	VB [DG]	
210 CDI, 216 CDI	03/09-	OM 651.955, OM 651.955, OM 651.957	2143	Rippenanzahl: 6; ☼	0-N1437	VB [DG]	
213 CDI, 216 CDI	06/06-	OM 651.955, OM 651.956, OM 651.955, OM 651.957	2143	für Fahrzeuge ohne Start-Stopp-Funktion	0-N2086	VB [BT]	S
216	09/08-	M 271.951	1796	†	0-N1457	VB [DG]	
216	09/08-	M 271.951	1796	→ 03/2009; ☼:→31216219	0-N1587	VB [BT]	S
216	09/08-	M 271.951	1796	☼:31216220→	0-N2136	VB [BT]	S
216	09/08-	M 271.951	1796		0-N2206	VB [DG]	
218 CDI, 219 CDI	06/06-	OM 642.896, OM 642.992	2987		0-N1560	VB [DG]	
218 CDI, 219 CDI	06/06-	OM 642.896, OM 642.992	2987	☼	0-N1710	VB [BT]	S
218 CDI, 219 CDI	06/06-	OM 642.896, OM 642.992	2987		0-N1902	VB [BT]	S
218 CDI, 219 CDI	06/06-	OM 642.896, OM 642.992	2987		0-N2227	VB [DG]	
218 CDI, 219 CDI	06/06-	OM 642.896	2987	für Fahrzeuge mit Start-Stopp-Funktion	0-N2293	VB [BT]	S
219 CDI	03/09-	OM 642.896, OM 642.992	2987		0-N2241	VB [BT]	S
224	06/06-	M 272.979	3498	Rippenanzahl: 6	0-N1637	VB [DG]	
224	06/06-	M 272.979	3498		0-N1670	VB [BT]	S
224	06/06-	M 272.979	3498		0-N2138	VB [DG]	
224	06/06-	M 272.979	3498	☼	0-N2143	VB [VD]	



CM³



Art. Nr.



ohne Halter

SPRINTER 3-t Kasten (906)							
224	06/06-	M 272.979	3498	☼		0-N2419	VB [DG]
SPRINTER 3-t Pritsche/Fahrgestell (906)							
209 CDI, 211 CDI, 213 CDI, 215 CDI	06/06-	OM 646.984, OM 646.985, OM 646.986, OM 646.989, OM 646.990	2148		Rippenanzahl: 6	0-N1431	VB [DG]
209 CDI, 211 CDI, 213 CDI, 215 CDI	06/06-	OM 646.984, OM 646.985, OM 646.986, OM 646.989, OM 646.990	2148			0-N1641	VB [BT] S
210 CDI	03/09-	OM 651.955	2143			0-N2086	VB [BT] S
210 CDI, 213 CDI, 216 CDI	03/09-	OM 651.955, OM 651.956, OM 651.957	2143			0-N2238	VB [DG]
210 CDI, 213 CDI, 216 CDI	03/09-	OM 651.955, OM 651.956, OM 651.957	2143			0-N2296	VB [DG]
210 CDI, 213 CDI, 216 CDI	03/09-	OM 651.955, OM 651.956, OM 651.957	2143		Rippenanzahl: 6	0-N2312	VB [DG]
210 CDI, 216 CDI	03/09-	OM 651.955, OM 651.957	2143		Rippenanzahl: 6; ☼	0-N1437	VB [DG]
213 CDI	03/09-	OM 651.956	2143		Rippenanzahl: 6	0-N1431	VB [DG]
213 CDI	03/09-	OM 651.956	2143			0-N1641	VB [BT] S
213 CDI, 216 CDI	03/09-	OM 651.956, OM 651.957	2143		für Fahrzeuge ohne Start-Stopp-Funktion	0-N2086	VB [BT] S
216	09/08-	M 271.951	1796	†		0-N1457	VB [DG]
216	09/08-	M 271.951	1796		→ 03/2009; ☼:→31216219	0-N1587	VB [BT] S
216	09/08-	M 271.951	1796	☼	☼:31216220→	0-N2136	VB [BT] S
216	09/08-	M 271.951	1796			0-N2206	VB [DG]
218 CDI, 219 CDI	06/06-	OM 642.896, OM 642.992, OM 642.896, OM 642.992, OM 642.993	2987			0-N1560	VB [DG]
218 CDI, 219 CDI	06/06-	OM 642.896, OM 642.992, OM 642.896, OM 642.992, OM 642.993	2987	☼		0-N1710	VB [BT] S
218 CDI, 219 CDI	06/06-	OM 642.896, OM 642.992, OM 642.896, OM 642.992, OM 642.993	2987			0-N1902	VB [BT] S
218 CDI, 219 CDI	06/06-	OM 642.896, OM 642.992, OM 642.896, OM 642.992, OM 642.993	2987			0-N2227	VB [DG]
218 CDI, 219 CDI	06/06-	OM 642.896	2987		für Fahrzeuge mit Start-Stopp-Funktion	0-N2293	VB [BT] S
219 CDI	03/09-	OM 642.896, OM 642.992	2987			0-N2241	VB [BT] S
224	06/06-	M 272.979	3498		Rippenanzahl: 6	0-N1637	VB [DG]
224	06/06-	M 272.979	3498			0-N1670	VB [BT] S
224	06/06-	M 272.979	3498			0-N2138	VB [DG]
224	06/06-	M 272.979	3498	☼		0-N2143	VB [VD]
224	06/06-	M 272.979	3498	☼		0-N2419	VB [DG]
SPRINTER 3,5-t Bus (906)							
310 CDI	03/09-	OM 651.955, OM 651.956	2143		Rippenanzahl: 6; ☼	0-N1437	VB [DG]
310 CDI, 313 CDI, 313 CDI 4x4	03/09-	OM 651.955, OM 651.956	2143			0-N2086	VB [BT] S
310 CDI, 313 CDI, 313 CDI 4x4, 316 CDI, 316 CDI 4x4	03/09-	OM 651.955, OM 651.956, OM 651.955, OM 651.957	2143			0-N2238	VB [DG]
310 CDI, 313 CDI, 313 CDI 4x4, 316 CDI, 316 CDI 4x4	03/09-	OM 651.955, OM 651.956, OM 651.955, OM 651.957	2143			0-N2296	VB [DG]
310 CDI, 313 CDI, 313 CDI 4x4, 316 CDI, 316 CDI 4x4	03/09-	OM 651.955, OM 651.956, OM 651.955, OM 651.957	2143		Rippenanzahl: 6	0-N2312	VB [DG]
311 CDI, 311 CDI 4x4, 315 CDI, 315 CDI 4x4	06/06-	OM 646.985, OM 646.989, OM 646.990	2148		Rippenanzahl: 6	0-N1431	VB [DG]
311 CDI, 311 CDI 4x4, 315 CDI, 315 CDI 4x4	06/06-	OM 646.985, OM 646.989, OM 646.990	2148			0-N1641	VB [BT] S
316 CDI, 316 CDI 4x4	08/11-	OM 651.955, OM 651.957	2143		für Fahrzeuge ohne Start-Stopp-Funktion	0-N2086	VB [BT] S
316, 316 NGT	09/08-	M 271.951	1796	†		0-N1457	VB [DG]
316, 316 NGT	09/08-	M 271.951	1796		→ 03/2009; ☼:→31216219	0-N1587	VB [BT] S
316, 316 NGT	09/08-	M 271.951	1796	☼	☼:31216220→	0-N2136	VB [BT] S
316, 316 NGT	09/08-	M 271.951	1796			0-N2206	VB [DG]
318 CDI, 318 CDI 4x4	02/08-	OM 642.896	2987		für Fahrzeuge mit Start-Stopp-Funktion	0-N2293	VB [BT] S
318 CDI, 318 CDI 4x4, 319 CDI	02/08-	OM 642.992	2987	☼		0-N1710	VB [BT] S
318 CDI, 318 CDI 4x4, 319 CDI, 319 CDI 4x4	02/08-	OM 642.896, OM 642.898, OM 642.992, OM 642.896, OM 642.992, OM 642.993	2987			0-N1560	VB [DG]
318 CDI, 318 CDI 4x4, 319 CDI, 319 CDI 4x4	02/08-	OM 642.896, OM 642.898, OM 642.992, OM 642.896, OM 642.992, OM 642.993	2987			0-N1902	VB [BT] S
318 CDI, 318 CDI 4x4, 319 CDI, 319 CDI 4x4	02/08-	OM 642.896, OM 642.898, OM 642.992, OM 642.896, OM 642.992, OM 642.993	2987			0-N2227	VB [DG]
319 CDI, 319 CDI 4x4	03/09-	OM 642.896, OM 642.898, OM 642.992	2987			0-N2241	VB [BT] S
319 CDI, 319 CDI 4x4	03/09-	OM 642.896, OM 642.898	2987		für Fahrzeuge mit Start-Stopp-Funktion	0-N2293	VB [BT] S
324	06/06-	M 272.979	3498		Rippenanzahl: 6	0-N1637	VB [DG]
324	06/06-	M 272.979	3498			0-N1670	VB [BT] S
324	06/06-	M 272.979	3498			0-N2138	VB [DG]
324	06/06-	M 272.979	3498	☼		0-N2143	VB [VD]
324	06/06-	M 272.979	3498	☼		0-N2419	VB [DG]



CM³



Art. Nr.



SPRINTER 3,5-t Kasten (906)									
309 CDI, 311 CDI, 311 CDI 4x4, 313 CDI, 315 CDI, 315 CDI 4x4	06/06-	OM 646.984, OM 646.985, OM 646.986, OM 651.955, OM 646.989, OM 646.990	2148	Rippenanzahl: 6	0-N1431	VB [DG]			
309 CDI, 311 CDI, 311 CDI 4x4, 313 CDI, 315 CDI, 315 CDI 4x4	06/06-	OM 646.984, OM 646.985, OM 646.986, OM 651.955, OM 646.989, OM 646.990	2148		0-N1641	VB [BT]	S		
310 CDI	03/09-	OM 651.955	2143		0-N2086	VB [BT]	S		
310 CDI, 313 CDI, 313 CDI 4x4, 316 CDI, 316 CDI 4x4	03/09-	OM 651.955, OM 651.955, OM 651.956, OM 651.955, OM 651.957	2143		0-N2238	VB [DG]			
310 CDI, 313 CDI, 313 CDI 4x4, 316 CDI, 316 CDI 4x4	03/09-	OM 651.955, OM 651.955, OM 651.956, OM 651.955, OM 651.957	2143		0-N2296	VB [DG]			
310 CDI, 313 CDI, 313 CDI 4x4, 316 CDI, 316 CDI 4x4	03/09-	OM 651.955, OM 651.955, OM 651.956, OM 651.955, OM 651.957	2143	Rippenanzahl: 6	0-N2312	VB [DG]			
310 CDI, 316 CDI, 316 CDI 4x4	03/09-	OM 651.955, OM 651.955, OM 651.957	2143	Rippenanzahl: 6; ☼	0-N1437	VB [DG]			
313 CDI, 313 CDI 4x4, 316 CDI, 316 CDI 4x4	03/09-	OM 651.955, OM 651.956, OM 651.955, OM 651.957	2143	für Fahrzeuge ohne Start-Stopp-Funktion	0-N2086	VB [BT]	S		
316, 316 LGT, 316 NGT	09/08-	M 271.951	1796	†	0-N1457	VB [DG]			
316, 316 LGT, 316 NGT	09/08-	M 271.951	1796	→ 03/2009; ☼: →31216219	0-N1587	VB [BT]	S		
316, 316 NGT	09/08-	M 271.951	1796	☼:31216220 →	0-N2136	VB [BT]	S		
316, 316 NGT	09/08-	M 271.951	1796		0-N2206	VB [DG]			
318 CDI, 318 CDI 4x4	06/06-	OM 642.896	2987	für Fahrzeuge mit Start-Stopp-Funktion	0-N2293	VB [BT]	S		
318 CDI, 318 CDI 4x4, 319 CDI, 319 CDI 4x4	06/06-	OM 642.896, OM 642.898, OM 642.992, OM 642.896, OM 642.992, OM 642.993	2987		0-N1560	VB [DG]			
318 CDI, 318 CDI 4x4, 319 CDI, 319 CDI 4x4	06/06-	OM 642.896, OM 642.898, OM 642.992, OM 642.896, OM 642.992, OM 642.993	2987		0-N1902	VB [BT]	S		
318 CDI, 318 CDI 4x4, 319 CDI, 319 CDI 4x4	06/06-	OM 642.896, OM 642.898, OM 642.992, OM 642.896, OM 642.992, OM 642.993	2987		0-N2227	VB [DG]			
318 CDI, 319 CDI	06/06-	OM 642.896, OM 642.898, OM 642.992, OM 642.896, OM 642.992, OM 642.993	2987	☼	0-N1710	VB [BT]	S		
318 CDI 4x4, 319 CDI 4x4	02/08-	OM 642.992	2987	☼	0-N1710	VB [BT]	S		
319 CDI, 319 CDI 4x4	03/09-	OM 642.896, OM 642.898, OM 642.992	2987		0-N2241	VB [BT]	S		
319 CDI, 319 CDI 4x4	03/09-	OM 642.896, OM 642.898	2987	für Fahrzeuge mit Start-Stopp-Funktion	0-N2293	VB [BT]	S		
324	06/06-	M 272.979	3498	Rippenanzahl: 6	0-N1637	VB [DG]			
324	06/06-	M 272.979	3498		0-N1670	VB [BT]	S		
324	06/06-	M 272.979	3498		0-N2138	VB [DG]			
324	06/06-	M 272.979	3498	☼	0-N2143	VB [VD]			
324	06/06-	M 272.979	3498	☼	0-N2419	VB [DG]			
SPRINTER 4-t Bus (904)									
408 CDI, 411 CDI, 413 CDI	04/00-05/06	OM 611.981, OM 611.987	2148	Rippenanzahl: 6	0-N1431	VB [DG]			
408 CDI, 411 CDI, 413 CDI	04/00-05/06	OM 611.981, OM 611.987	2148	Rippenanzahl: 6; ☼	0-N1436	VB [DG]	S		
408 CDI, 411 CDI, 413 CDI	04/00-05/06	OM 611.981, OM 611.987	2148	Rippenanzahl: 6; ☼	0-N1437	VB [DG]			
408 CDI, 411 CDI, 413 CDI	04/00-05/06	OM 611.981, OM 611.987	2148		0-N1641	VB [BT]	S		
414	02/96-05/06	M 111.979	2295		0-N1703	VB [BT]			
414	02/96-05/06	M 111.979	2295		0-N1833	VB [TE]			
414	02/96-05/06	M 111.979	2295		0-N1951	VB [VD]			
414	02/96-05/06	M 111.979	2295		0-N2418	VB [BT]			
416 CDI	04/00-05/06	OM 612.981	2685	Rippenanzahl: 6	0-N1431	VB [DG]			
416 CDI	04/00-05/06	OM 612.981	2685	Rippenanzahl: 6; ☼	0-N1436	VB [DG]	S		
416 CDI	04/00-05/06	OM 612.981	2685	Rippenanzahl: 6; ☼	0-N1437	VB [DG]			
416 CDI	04/00-05/06	OM 612.981	2685		0-N1641	VB [BT]	S		
SPRINTER 3,5-t Pritsche/Fahrgestell (906)									
309 CDI, 311 CDI, 311 CDI 4x4, 313 CDI, 315 CDI, 315 CDI 4x4	06/06-	OM 646.984, OM 646.985, OM 646.986, OM 646.989, OM 646.990	2148	Rippenanzahl: 6	0-N1431	VB [DG]			
309 CDI, 311 CDI, 311 CDI 4x4, 313 CDI, 315 CDI, 315 CDI 4x4	06/06-	OM 646.984, OM 646.985, OM 646.986, OM 646.989, OM 646.990	2148		0-N1641	VB [BT]	S		
310 CDI	03/09-	OM 651.955	2143		0-N2086	VB [BT]	S		
310 CDI, 313 CDI, 313 CDI 4x4, 316 CDI, 316 CDI 4x4	06/06-	OM 651.955, OM 651.955, OM 651.956, OM 651.955, OM 651.957	2143		0-N2238	VB [DG]			
310 CDI, 313 CDI, 313 CDI 4x4, 316 CDI, 316 CDI 4x4	06/06-	OM 651.955, OM 651.955, OM 651.956, OM 651.955, OM 651.957	2143		0-N2296	VB [DG]			
310 CDI, 313 CDI, 313 CDI 4x4, 316 CDI, 316 CDI 4x4	06/06-	OM 651.955, OM 651.955, OM 651.956, OM 651.955, OM 651.957	2143	Rippenanzahl: 6	0-N2312	VB [DG]			
310 CDI, 316 CDI, 316 CDI 4x4	03/09-	OM 651.955, OM 651.955, OM 651.957, OM 651.957	2143	Rippenanzahl: 6; ☼	0-N1437	VB [DG]			
313 CDI, 313 CDI 4x4, 316 CDI, 316 CDI 4x4	06/06-	OM 651.955, OM 651.956, OM 651.955, OM 651.957, OM 651.957	2143	für Fahrzeuge ohne Start-Stopp-Funktion	0-N2086	VB [BT]	S		
313 CDI 4x4	06/06-	OM 651.955, OM 651.956	2143	Rippenanzahl: 6	0-N1431	VB [DG]			
313 CDI 4x4	06/06-	OM 651.955, OM 651.956	2143		0-N1641	VB [BT]	S		
316, 316 LGT, 316 NGT	09/08-	M 271.951	1796	†	0-N1457	VB [DG]			
316, 316 LGT, 316 NGT	09/08-	M 271.951	1796	→ 03/2009; ☼: →31216219	0-N1587	VB [BT]	S		
316, 316 NGT	09/08-	M 271.951	1796	☼:31216220 →	0-N2136	VB [BT]	S		



CM³



Art. Nr.



ohne Halter

SPRINTER 3,5-t Pritsche/Fahrgestell (906)							
316, 316 NGT	09/08-	M 271.951	1796			0-N2206	VB [DG]
318 CDI, 318 CDI 4x4	06/06-	OM 642.896	2987	für Fahrzeuge mit Start-Stopp-Funktion		0-N2293	VB [BT] S
318 CDI, 318 CDI 4x4, 319 CDI	06/06-	OM 642.896, OM 642.898, OM 642.992, OM 642.896, OM 642.992, OM 642.993	2987	☼		0-N1710	VB [BT] S
318 CDI, 318 CDI 4x4, 319 CDI, 319 CDI 4x4	06/06-	OM 642.896, OM 642.898, OM 642.992, OM 642.896, OM 642.992, OM 642.993	2987			0-N1560	VB [DG]
318 CDI, 318 CDI 4x4, 319 CDI, 319 CDI 4x4	06/06-	OM 642.896, OM 642.898, OM 642.992, OM 642.896, OM 642.992, OM 642.993	2987			0-N1902	VB [BT] S
318 CDI, 318 CDI 4x4, 319 CDI, 319 CDI 4x4	06/06-	OM 642.896, OM 642.898, OM 642.992, OM 642.896, OM 642.992, OM 642.993	2987			0-N2227	VB [DG]
319 CDI	03/09-	OM 642.896, OM 642.898, OM 642.992	2987			0-N2241	VB [BT] S
319 CDI, 319 CDI 4x4	03/09-	OM 642.896, OM 642.898	2987	für Fahrzeuge mit Start-Stopp-Funktion		0-N2293	VB [BT] S
324	06/06-	M 272.979	3498	Rippenanzahl: 6		0-N1637	VB [DG]
324	06/06-	M 272.979	3498			0-N1670	VB [BT] S
324	06/06-	M 272.979	3498			0-N2138	VB [DG]
324	06/06-	M 272.979	3498	☼		0-N2143	VB [VD]
324	06/06-	M 272.979	3498	☼		0-N2419	VB [DG]
SPRINTER 4-t Kasten (904)							
408 CDI, 411 CDI, 411 CDI 4x4, 413 CDI, 413 CDI 4x4	04/00-05/06	OM 611.981, OM 611.987	2148	Rippenanzahl: 6		0-N1431	VB [DG]
408 CDI, 411 CDI, 411 CDI 4x4, 413 CDI, 413 CDI 4x4	04/00-05/06	OM 611.981, OM 611.987	2148	Rippenanzahl: 6; ☼		0-N1436	VB [DG] S
408 CDI, 411 CDI, 411 CDI 4x4, 413 CDI, 413 CDI 4x4	04/00-05/06	OM 611.981, OM 611.987	2148	Rippenanzahl: 6; ☼		0-N1437	VB [DG]
408 CDI, 411 CDI, 411 CDI 4x4, 413 CDI, 413 CDI 4x4	04/00-05/06	OM 611.981, OM 611.987	2148			0-N1641	VB [BT] S
408 D	02/96-05/06	OM 601.943	2299			0-N1043	VB [BT]
408 D	02/96-05/06	OM 601.943	2299	Rippenanzahl: 6; für Fahrzeuge ohne Servolenkung		0-N1288	VB [DG]
408 D	02/96-05/06	OM 601.943	2299	Rippenanzahl: 6; ☼		0-N1288	VB [DG]
408 D	02/96-05/06	OM 601.943	2299			0-N2147	VB [VD]
408 D	02/96-05/06	OM 601.943	2299			0-N846	VB [TE]
408 D	02/96-05/06	OM 601.943	2299	für Fahrzeuge mit Servolenkung		0-N847	VB [TE]
408 D	02/96-05/06	OM 601.943	2299	für Fahrzeuge ohne Servolenkung		0-N847	VB [TE]
408 D	02/96-05/06	OM 601.943	2299	☼		0-N847	VB [TE]
410 D, 410 D 4x4, 412 D, 412 D 4x4	02/96-05/06	OM 602.980	2874			0-N1043	VB [BT]
410 D, 410 D 4x4, 412 D, 412 D 4x4	02/96-05/06	OM 602.980	2874			0-N2147	VB [VD]
410 D, 410 D 4x4, 412 D, 412 D 4x4	02/96-05/06	OM 602.980	2874			0-N846	VB [TE]
410 D, 410 D 4x4, 412 D, 412 D 4x4	02/96-05/06	OM 602.980	2874	☼		0-N847	VB [TE]
414, 414 4x4	02/96-05/06	M 111.979	2295			0-N1703	VB [BT]
414, 414 4x4	02/96-05/06	M 111.979	2295			0-N1833	VB [TE]
414, 414 4x4	02/96-05/06	M 111.979	2295			0-N1951	VB [VD]
414, 414 4x4	02/96-05/06	M 111.979	2295			0-N2418	VB [BT]
416 CDI, 416 CDI 4x4	04/00-05/06	OM 612.981	2685	Rippenanzahl: 6		0-N1431	VB [DG]
416 CDI, 416 CDI 4x4	04/00-05/06	OM 612.981	2685	Rippenanzahl: 6; ☼		0-N1436	VB [DG] S
416 CDI, 416 CDI 4x4	04/00-05/06	OM 612.981	2685	Rippenanzahl: 6; ☼		0-N1437	VB [DG]
416 CDI, 416 CDI 4x4	04/00-05/06	OM 612.981	2685			0-N1641	VB [BT] S
SPRINTER 4-t Pritsche/Fahrgestell (904)							
408 CDI, 411 CDI, 411 CDI 4x4, 413 CDI, 413 CDI 4x4	04/00-05/06	OM 611.981, OM 611.987	2148	Rippenanzahl: 6		0-N1431	VB [DG]
408 CDI, 411 CDI, 411 CDI 4x4, 413 CDI, 413 CDI 4x4	04/00-05/06	OM 611.981, OM 611.987	2148	Rippenanzahl: 6; ☼		0-N1436	VB [DG] S
408 CDI, 411 CDI, 411 CDI 4x4, 413 CDI, 413 CDI 4x4	04/00-05/06	OM 611.981, OM 611.987	2148	Rippenanzahl: 6; ☼		0-N1437	VB [DG]
408 CDI, 411 CDI, 411 CDI 4x4, 413 CDI, 413 CDI 4x4	04/00-05/06	OM 611.981, OM 611.987	2148			0-N1641	VB [BT] S
408 D	02/96-05/06	OM 601.943	2299			0-N1043	VB [BT]
408 D	02/96-05/06	OM 601.943	2299	Rippenanzahl: 6; für Fahrzeuge ohne Servolenkung		0-N1288	VB [DG]
408 D	02/96-05/06	OM 601.943	2299	Rippenanzahl: 6; ☼		0-N1288	VB [DG]
408 D	02/96-05/06	OM 601.943	2299			0-N2147	VB [VD]
408 D	02/96-05/06	OM 601.943	2299			0-N846	VB [TE]
408 D	02/96-05/06	OM 601.943	2299	für Fahrzeuge mit Servolenkung		0-N847	VB [TE]
408 D	02/96-05/06	OM 601.943	2299	für Fahrzeuge ohne Servolenkung		0-N847	VB [TE]
408 D	02/96-05/06	OM 601.943	2299	☼		0-N847	VB [TE]
410 D, 410 D 4x4, 412 D, 412 D 4x4	02/96-05/06	OM 602.980	2874			0-N1043	VB [BT]
410 D, 410 D 4x4, 412 D, 412 D 4x4	02/96-05/06	OM 602.980	2874			0-N2147	VB [VD]
410 D, 410 D 4x4, 412 D, 412 D 4x4	02/96-05/06	OM 602.980	2874			0-N846	VB [TE]



OPTIMAL®

MERCEDES-BENZ

**CM³**

Art. Nr.



ohne Halter

SPRINTER 4-t Pritsche/Fahrgestell (904)

410 D, 410 D 4x4, 412 D, 412 D 4x4	02/96-05/06	OM 602.980	2874	☼		0-N847	VB [TE]	
414, 414 4x4	02/96-05/06	M 111.979	2295			0-N1703	VB [BT]	
414, 414 4x4	02/96-05/06	M 111.979	2295			0-N1833	VB [TE]	
414, 414 4x4	02/96-05/06	M 111.979	2295			0-N1951	VB [VD]	
414, 414 4x4	02/96-05/06	M 111.979	2295			0-N2418	VB [BT]	
416 CDI, 416 CDI 4x4	04/00-05/06	OM 612.981	2685		Rippenanzahl: 6	0-N1431	VB [DG]	
416 CDI, 416 CDI 4x4	04/00-05/06	OM 612.981	2685		Rippenanzahl: 6; ☼	0-N1436	VB [DG]	S
416 CDI, 416 CDI 4x4	04/00-05/06	OM 612.981	2685		Rippenanzahl: 6; ☼	0-N1437	VB [DG]	
416 CDI, 416 CDI 4x4	04/00-05/06	OM 612.981	2685			0-N1641	VB [BT]	S

SPRINTER 4,6-t Kasten (906)

411 CDI, 413 CDI, 415 CDI	06/06-	OM 646.985, OM 646.986, OM 646.989, OM 646.990	2148			0-N1641	VB [BT]	S
413 CDI	06/06-	OM 646.986	2148		Rippenanzahl: 6	0-N1431	VB [DG]	
413 CDI	06/06-	OM 646.986	2148		für Fahrzeuge ohne Start-Stopp-Funktion	0-N2086	VB [BT]	S
416 CDI	03/09-	OM 651.957	2143		Rippenanzahl: 6; ☼	0-N1437	VB [DG]	
416 CDI	03/09-	OM 651.957	2143		für Fahrzeuge ohne Start-Stopp-Funktion	0-N2086	VB [BT]	S
416 CDI	03/09-	OM 651.957	2143			0-N2238	VB [DG]	
416 CDI	03/09-	OM 651.957	2143			0-N2296	VB [DG]	
416 CDI	03/09-	OM 651.957	2143		Rippenanzahl: 6	0-N2312	VB [DG]	
418 CDI	06/09-	OM 642.896	2987		für Fahrzeuge mit Start-Stopp-Funktion	0-N2293	VB [BT]	S
418 CDI, 419 CDI	03/09-	OM 642.896, OM 642.992, OM 642.992	2987			0-N1560	VB [DG]	
419 CDI	03/09-	OM 642.992	2987	☼		0-N1710	VB [BT]	S
419 CDI	03/09-	OM 642.992	2987			0-N1902	VB [BT]	S
419 CDI	03/09-	OM 642.992	2987			0-N2227	VB [DG]	
419 CDI	03/09-	OM 642.992	2987			0-N2241	VB [BT]	S
424	06/06-	M 272.979	3498		Rippenanzahl: 6	0-N1637	VB [DG]	
424	06/06-	M 272.979	3498			0-N1670	VB [BT]	S
424	06/06-	M 272.979	3498			0-N2138	VB [DG]	
424	06/06-	M 272.979	3498	☼		0-N2143	VB [VD]	
424	06/06-	M 272.979	3498	☼		0-N2419	VB [DG]	

SPRINTER 4,6-t Pritsche/Fahrgestell (906)

411 CDI, 413 CDI, 415 CDI	06/06-	OM 646.985, OM 646.986, OM 646.989, OM 646.990	2148			0-N1641	VB [BT]	S
413 CDI	06/06-	OM 646.986	2148		Rippenanzahl: 6	0-N1431	VB [DG]	
413 CDI	06/06-	OM 646.986	2148		für Fahrzeuge ohne Start-Stopp-Funktion	0-N2086	VB [BT]	S
415 CDI	06/06-	OM 646.990	2148		Rippenanzahl: 6	0-N1431	VB [DG]	
416 CDI	03/09-	OM 651.957	2143		Rippenanzahl: 6; ☼	0-N1437	VB [DG]	
416 CDI	03/09-	OM 651.957	2143		für Fahrzeuge ohne Start-Stopp-Funktion	0-N2086	VB [BT]	S
416 CDI	03/09-	OM 651.957	2143			0-N2238	VB [DG]	
416 CDI	03/09-	OM 651.957	2143		Rippenanzahl: 6	0-N2312	VB [DG]	
418 CDI	06/06-	OM 642.992	2987	☼		0-N1710	VB [BT]	S
418 CDI	06/06-	OM 642.992	2987			0-N1902	VB [BT]	S
418 CDI	06/06-	OM 642.896	2987		für Fahrzeuge mit Start-Stopp-Funktion	0-N2293	VB [BT]	S
418 CDI, 419 CDI	06/06-	OM 642.896, OM 642.898, OM 642.992, OM 642.896, OM 642.992, OM 642.993	2987			0-N1560	VB [DG]	
418 CDI, 419 CDI	06/06-	OM 642.896, OM 642.898, OM 642.992, OM 642.896, OM 642.992, OM 642.993	2987			0-N2227	VB [DG]	
419 CDI	03/09-	OM 642.896, OM 642.898, OM 642.992	2987	☼		0-N1710	VB [BT]	S
419 CDI	03/09-	OM 642.896, OM 642.898, OM 642.992	2987			0-N1902	VB [BT]	S
419 CDI	03/09-	OM 642.896, OM 642.898, OM 642.992	2987			0-N2241	VB [BT]	S
419 CDI	03/09-	OM 642.896, OM 642.898	2987		für Fahrzeuge mit Start-Stopp-Funktion	0-N2293	VB [BT]	S
424	06/06-	M 272.979	3498		Rippenanzahl: 6	0-N1637	VB [DG]	
424	06/06-	M 272.979	3498			0-N1670	VB [BT]	S
424	06/06-	M 272.979	3498			0-N2138	VB [DG]	
424	06/06-	M 272.979	3498	☼		0-N2143	VB [VD]	
424	06/06-	M 272.979	3498	☼		0-N2419	VB [DG]	

SPRINTER 5-t Kasten (906)

509 CDI, 511 CDI, 511 CDI 4x4, 513 CDI, 515 CDI, 515 CDI 4x4	06/06-	OM 646.984, OM 646.985, OM 646.986, OM 646.986, OM 646.989, OM 646.990, OM 646.989, OM 646.990	2148			0-N1641	VB [BT]	S
509 CDI, 511 CDI, 513 CDI, 515 CDI	06/06-	OM 646.984, OM 646.985, OM 646.986, OM 646.986, OM 646.989, OM 646.990	2148		Rippenanzahl: 6	0-N1431	VB [DG]	
510 CDI	03/09-	OM 651.955	2143			0-N2086	VB [BT]	S
510 CDI, 513 CDI, 513 CDI 4x4, 516 CDI, 516 CDI 4x4	06/06-	OM 651.955, OM 651.955, OM 651.957, OM 651.956	2143			0-N2238	VB [DG]	

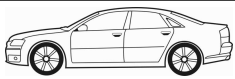

CM³



Art. Nr.



SPRINTER 5-t Kasten (906)

510 CDI, 513 CDI, 513 CDI 4x4, 516 CDI, 516 CDI 4x4	06/06-	OM 651.955, OM 651.955, OM 651.957, OM 651.956	2143		0-N2296	VB [DG]	
510 CDI, 513 CDI, 513 CDI 4x4, 516 CDI, 516 CDI 4x4	06/06-	OM 651.955, OM 651.955, OM 651.957, OM 651.956	2143	Rippenanzahl: 6	0-N2312	VB [DG]	
510 CDI, 516 CDI	03/09-	OM 651.955, OM 651.955, OM 651.957	2143	Rippenanzahl: 6;	0-N1437	VB [DG]	
513 CDI, 513 CDI 4x4, 516 CDI, 516 CDI 4x4	06/06-	OM 651.955, OM 651.957, OM 651.956	2143	für Fahrzeuge ohne Start-Stopp-Funktion	0-N2086	VB [BT]	S
518 CDI, 518 CDI 4x4	06/06-	OM 642.896	2987	für Fahrzeuge mit Start-Stopp-Funktion	0-N2293	VB [BT]	S
518 CDI, 518 CDI 4x4, 519 CDI, 519 CDI 4x4	06/06-	OM 642.896, OM 642.898, OM 642.992, OM 642.896, OM 642.992, OM 642.993	2987		0-N1560	VB [DG]	
518 CDI, 518 CDI 4x4, 519 CDI, 519 CDI 4x4	06/06-	OM 642.896, OM 642.898, OM 642.992, OM 642.896, OM 642.992, OM 642.993	2987		0-N1902	VB [BT]	S
518 CDI, 519 CDI	06/06-	OM 642.896, OM 642.898, OM 642.992, OM 642.896, OM 642.992, OM 642.993	2987		0-N1710	VB [BT]	S
518 CDI, 519 CDI	06/06-	OM 642.896, OM 642.898, OM 642.992, OM 642.896, OM 642.992, OM 642.993	2987		0-N2227	VB [DG]	
519 CDI, 519 CDI 4x4	03/09-	OM 642.896, OM 642.898, OM 642.992	2987		0-N2241	VB [BT]	S
519 CDI, 519 CDI 4x4	03/09-	OM 642.896, OM 642.898	2987	für Fahrzeuge mit Start-Stopp-Funktion	0-N2293	VB [BT]	S
524	06/06-	M 272.979	3498	Rippenanzahl: 6	0-N1637	VB [DG]	
524	06/06-	M 272.979	3498		0-N1670	VB [BT]	S
524	06/06-	M 272.979	3498		0-N2138	VB [DG]	
524	06/06-	M 272.979	3498		0-N2143	VB [VD]	
524	06/06-	M 272.979	3498		0-N2419	VB [DG]	

SPRINTER 5-t Pritsche/Fahrgestell (905)

616 CDI	04/01-05/06	OM 612.981	2685	Rippenanzahl: 6	0-N1431	VB [DG]	
616 CDI	04/01-05/06	OM 612.981	2685	Rippenanzahl: 6;	0-N1436	VB [DG]	S
616 CDI	04/01-05/06	OM 612.981	2685	Rippenanzahl: 6;	0-N1437	VB [DG]	
616 CDI	04/01-05/06	OM 612.981	2685		0-N1641	VB [BT]	S

SPRINTER 5-t Pritsche/Fahrgestell (906)

509 CDI, 511 CDI, 511 CDI 4x4, 513 CDI, 515 CDI, 515 CDI 4x4	06/06-	OM 646.984, OM 646.985, OM 646.986, OM 646.989, OM 646.990	2148		0-N1641	VB [BT]	S
509 CDI, 511 CDI, 513 CDI, 515 CDI	06/06-	OM 646.984, OM 646.985, OM 646.986, OM 646.989, OM 646.990	2148	Rippenanzahl: 6	0-N1431	VB [DG]	
510 CDI	03/09-	OM 651.955	2143		0-N2086	VB [BT]	S
510 CDI, 513 CDI, 513 CDI 4x4, 516 CDI, 516 CDI 4x4	06/06-	OM 651.955, OM 651.955, OM 651.956, OM 651.955, OM 651.957	2143		0-N2238	VB [DG]	
510 CDI, 513 CDI, 513 CDI 4x4, 516 CDI, 516 CDI 4x4	06/06-	OM 651.955, OM 651.955, OM 651.956, OM 651.955, OM 651.957	2143		0-N2296	VB [DG]	
510 CDI, 513 CDI, 513 CDI 4x4, 516 CDI, 516 CDI 4x4	06/06-	OM 651.955, OM 651.955, OM 651.956, OM 651.955, OM 651.957	2143	Rippenanzahl: 6	0-N2312	VB [DG]	
510 CDI, 516 CDI	03/09-	OM 651.955, OM 651.955, OM 651.957	2143	Rippenanzahl: 6;	0-N1437	VB [DG]	
513 CDI, 513 CDI 4x4, 516 CDI, 516 CDI 4x4	06/06-	OM 651.955, OM 651.956, OM 651.955, OM 651.957	2143	für Fahrzeuge ohne Start-Stopp-Funktion	0-N2086	VB [BT]	S
516, 516 NGT	09/08-	M 271.951	1796		0-N1457	VB [DG]	
516, 516 NGT	09/08-	M 271.951	1796	→ 03/2009; → 31216219	0-N1587	VB [BT]	S
516, 516 NGT	09/08-	M 271.951	1796	:31216220→	0-N2136	VB [BT]	S
516, 516 NGT	09/08-	M 271.951	1796		0-N2206	VB [DG]	
518 CDI, 518 CDI 4x4	06/06-	OM 642.896	2987	für Fahrzeuge mit Start-Stopp-Funktion	0-N2293	VB [BT]	S
518 CDI, 518 CDI 4x4, 519 CDI, 519 CDI 4x4	06/06-	OM 642.896, OM 642.898, OM 642.992, OM 642.896, OM 642.992, OM 642.993	2987		0-N1560	VB [DG]	
518 CDI, 518 CDI 4x4, 519 CDI, 519 CDI 4x4	06/06-	OM 642.896, OM 642.898, OM 642.992, OM 642.896, OM 642.992, OM 642.993	2987		0-N1902	VB [BT]	S
518 CDI, 519 CDI	06/06-	OM 642.896, OM 642.898, OM 642.992, OM 642.896, OM 642.992, OM 642.993	2987		0-N1710	VB [BT]	S
518 CDI, 519 CDI	06/06-	OM 642.896, OM 642.898, OM 642.992, OM 642.896, OM 642.992, OM 642.993	2987		0-N2227	VB [DG]	
519 CDI, 519 CDI 4x4	03/09-	OM 642.896, OM 642.898, OM 642.992	2987		0-N2241	VB [BT]	S
519 CDI, 519 CDI 4x4	03/09-	OM 642.896, OM 642.898	2987	für Fahrzeuge mit Start-Stopp-Funktion	0-N2293	VB [BT]	S
524	06/06-	M 272.979	3498	Rippenanzahl: 6	0-N1637	VB [DG]	
524	06/06-	M 272.979	3498		0-N1670	VB [BT]	S
524	06/06-	M 272.979	3498		0-N2138	VB [DG]	
524	06/06-	M 272.979	3498		0-N2143	VB [VD]	
524	06/06-	M 272.979	3498		0-N2419	VB [DG]	

SPRINTER Kipper (905)

616 CDI	04/01-	OM 612.981	2685	Rippenanzahl: 6	0-N1431	VB [DG]	
616 CDI	04/01-	OM 612.981	2685	Rippenanzahl: 6;	0-N1436	VB [DG]	S
616 CDI	04/01-	OM 612.981	2685	Rippenanzahl: 6;	0-N1437	VB [DG]	
616 CDI	04/01-	OM 612.981	2685		0-N1641	VB [BT]	S



OPTIMAL®

MERCEDES-BENZ



CM³



Art. Nr.



Stufenheck (W124)

200 D	12/84-06/93	OM 601.912	1997	ENGINE:021217, 204234→	0-N1043	VB [BT]	
200 D	12/84-06/93	OM 601.912	1997		0-N1289	VB [BT]	
200 D	12/84-06/93	OM 601.912	1997	ENGINE:→021216, 204233; hydraulisch	0-N1926	VB [VD]	
200 D	12/84-06/93	OM 601.912	1997	ENGINE:021217, 204234→	0-N2147	VB [VD]	
200 D	12/84-06/93	OM 601.912	1997		0-N846	VB [TE]	
200 D	12/84-06/93	OM 601.912	1997	für Fahrzeuge ohne Servolenkung	0-N847	VB [TE]	
200 E	10/92-06/93	M 111.940	1998		0-N1703	VB [BT]	
200 E	10/92-06/93	M 111.940	1998		0-N1833	VB [TE]	
200 E	10/92-06/93	M 111.940	1998		0-N2418	VB [BT]	
200, 200 E	12/85-08/92	M 102.922, M 102.963	1996	mit Anbaumaterial; für Fahrzeuge mit Servolenkung	0-N1013	VB [BT]	S
200, 200 E	12/85-08/92	M 102.922, M 102.963	1996	ENGINE:021734→; für Fahrzeuge mit Servolenkung	0-N2144	VB [VD]	
200, 200 E	12/85-08/92	M 102.922, M 102.963	1996	ENGINE:054115→;	0-N2144	VB [VD]	
200, 200 E	12/85-08/92	M 102.922, M 102.963	1996	ENGINE:000255→; ENGINE:→021733; für Fahrzeuge mit Servolenkung	0-N2145	VB [VD]	
200, 200 E	12/85-08/92	M 102.922, M 102.963	1996	ENGINE:000935→; ENGINE:→054114;	0-N2145	VB [VD]	
200, 200 E	12/85-08/92	M 102.922, M 102.963	1996		0-N846	VB [TE]	
200, 200 E	12/85-08/92	M 102.922, M 102.963	1996	für Fahrzeuge ohne Servolenkung	0-N847	VB [TE]	
220 E	10/92-06/93	M 111.960	2199		0-N1703	VB [BT]	
220 E	10/92-06/93	M 111.960	2199		0-N1833	VB [TE]	
220 E	10/92-06/93	M 111.960	2199		0-N1951	VB [VD]	
220 E	10/92-06/93	M 111.960	2199		0-N2418	VB [BT]	
230 E	12/84-06/93	M 102.982	2298	mit Anbaumaterial; für Fahrzeuge mit Servolenkung	0-N1013	VB [BT]	S
230 E	12/84-06/93	M 102.982	2298	ENGINE:086552→	0-N2144	VB [VD]	
230 E	12/84-06/93	M 102.982	2298	ENGINE:→086551	0-N2145	VB [VD]	
230 E	12/84-06/93	M 102.982	2298		0-N846	VB [TE]	
230 E	12/84-06/93	M 102.982	2298	für Fahrzeuge ohne Servolenkung	0-N847	VB [TE]	
250 D, 250 Turbo-D	04/85-06/93	OM 602.912, OM 602.962	2497		0-N1289	VB [BT]	
250 D, 250 Turbo-D	04/85-06/93	OM 602.912, OM 602.962	2497	hydraulisch	0-N1926	VB [VD]	
250 D, 250 Turbo-D	04/85-06/93	OM 602.912, OM 602.962	2497		0-N846	VB [TE]	
260 E, 260 E 4-matic	09/85-08/92	M 103.940, M 103.943	2597		0-N1011	VB [BT]	S
260 E, 260 E 4-matic	09/85-08/92	M 103.940, M 103.943	2597		0-N1278	VB [TE]	
260 E, 260 E 4-matic	09/85-08/92	M 103.940, M 103.943	2597		0-N2146	VB [VD]	
280 E	10/92-06/93	M 104.942	2799	ENGINE:→005789, 048696	0-N1011	VB [BT]	S
280 E	10/92-06/93	M 104.942	2799	ENGINE:→005789, 048696	0-N1278	VB [TE]	
280 E	10/92-06/93	M 104.942	2799	ENGINE:005790, 048697→	0-N1282	VB [TE]	
280 E	10/92-06/93	M 104.942	2799	Rippenanzahl: 6	0-N1288	VB [DG]	
280 E	10/92-06/93	M 104.942	2799	ENGINE:005790, 048697→	0-N2141	VB [TE]	
280 E	10/92-06/93	M 104.942	2799	ENGINE:→005789, 048696	0-N2146	VB [VD]	
300 D, 300 D 4-matic	12/84-06/93	OM 603.912, OM 603.913	2996	hydraulisch	0-N1926	VB [VD]	
300 D, 300 D 4-matic, 300 Turbo-D, 300 Turbo-D 4-matic	12/84-06/93	OM 603.912, OM 603.913, OM 603.960, OM 603.963	2996		0-N1289	VB [BT]	
300 E, 300 E 4-matic, 300 E-24	01/85-06/93	M 103.980, M 103.983, M 103.985, M 104.980	2960		0-N1011	VB [BT]	S
300 E, 300 E 4-matic, 300 E-24	01/85-06/93	M 103.980, M 103.983, M 103.985, M 104.980	2960		0-N1278	VB [TE]	
300 E, 300 E 4-matic, 300 E-24	01/85-06/93	M 103.980, M 103.983, M 103.985, M 104.980	2960		0-N2146	VB [VD]	
300 E-24	09/88-08/92	M 104.980	2960	ENGINE:→21004	0-N847	VB [TE]	
300 E-24	09/88-08/92	M 104.980	2960	ENGINE:→4956	0-N847	VB [TE]	
300 TD SD	06/91-05/93	OM 603.971	3449	ENGINE:007422→	0-N1043	VB [BT]	
300 TD SD	06/91-05/93	OM 603.971	3449		0-N1278	VB [TE]	
300 TD SD	06/91-05/93	OM 603.971	3449	ENGINE:→007421	0-N1289	VB [BT]	
300 TD SD	06/91-05/93	OM 603.971	3449	ENGINE:→007421; hydraulisch	0-N1926	VB [VD]	
300 TD SD	06/91-05/93	OM 603.971	3449	ENGINE:007422→	0-N2147	VB [VD]	
300 Turbo-D, 300 Turbo-D 4-matic	09/86-09/88	OM 603.963	2996	ENGINE:004191→	0-N1043	VB [BT]	
300 Turbo-D, 300 Turbo-D 4-matic	09/86-09/88	OM 603.960	2996	ENGINE:048697→	0-N1043	VB [BT]	
300 Turbo-D, 300 Turbo-D 4-matic	09/86-06/93	OM 603.960, OM 603.963	2996	ENGINE:→004190, 049508; hydraulisch	0-N1926	VB [VD]	
300 Turbo-D, 300 Turbo-D 4-matic	09/86-09/88	OM 603.963	2996	ENGINE:004191→	0-N2147	VB [VD]	
300 Turbo-D, 300 Turbo-D 4-matic	09/86-09/88	OM 603.960	2996	ENGINE:048697→	0-N2147	VB [VD]	
300 Turbo-D, 300 Turbo-D 4-matic	09/86-06/93	OM 603.960, OM 603.960, OM 603.963, OM 603.963	2996		0-N846	VB [TE]	
300 Turbo-D, 300 Turbo-D 4-matic	01/88-06/93	OM 603.960, OM 603.963	2996	ENGINE:004191→	0-N1043	VB [BT]	
300 Turbo-D, 300 Turbo-D 4-matic	01/88-06/93	OM 603.960, OM 603.963	2996	ENGINE:048697→	0-N1043	VB [BT]	
300 Turbo-D, 300 Turbo-D 4-matic	01/88-06/93	OM 603.960, OM 603.963	2996	ENGINE:→004190, 049508	0-N1289	VB [BT]	
300 Turbo-D, 300 Turbo-D 4-matic	01/88-06/93	OM 603.960, OM 603.963	2996	ENGINE:004191→	0-N2147	VB [VD]	

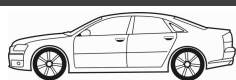

CM³



Art. Nr.



ohne Halter

Stufenheck (W124)							
300 Turbo-D , 300 Turbo-D 4-matic	01/88-06/93	OM 603.960, OM 603.963	2996	:048697→	0-N2147	VB [VD]	
320 E	10/92-06/93	M 104.992	3199	:→004356, 072236	0-N1011	VB [BT]	S
320 E	10/92-06/93	M 104.992	3199	:→004356, 072236	0-N1278	VB [TE]	
320 E	10/92-06/93	M 104.992	3199	:004357, 072237→	0-N1282	VB [TE]	
320 E	10/92-06/93	M 104.992	3199		0-N1283	VB [TE]	
320 E	10/92-06/93	M 104.992	3199	Rippenanzahl: 6	0-N1288	VB [DG]	
320 E	10/92-06/93	M 104.992	3199	:004357, 072237→; :→005602, 102820	0-N2141	VB [TE]	
320 E	10/92-06/93	M 104.992	3199	:→004356, 072237	0-N2146	VB [VD]	
400 E 4.2	10/92-06/93	M 119.975	4196		0-N1860	VB [BT]	
400 E 4.2	10/92-06/93	M 119.975	4196		0-N2141	VB [TE]	
400 E 4.2	10/92-06/93	M 119.975	4196	für Fahrzeuge ohne Katalysator	0-N847	VB [TE]	
500 E	01/91-06/93	M 119.974	4973	:005782→	0-N1860	VB [BT]	
500 E	01/91-06/93	M 119.974	4973	:→005781	0-N1862	VB [BT]	
500 E	01/91-06/93	M 119.974	4973	:→005781; Rippenanzahl: 8	0-N1864	VB [DG]	
500 E	01/91-06/93	M 119.974	4973	:005782→	0-N2141	VB [TE]	
500 E	01/91-06/93	M 119.974	4973	für Fahrzeuge ohne Katalysator; :005782→	0-N847	VB [TE]	
200 D	12/84-06/93	OM 601.912	1997		0-N565592	FB [TE]	
250 D , 250 Turbo-D	04/85-06/93	OM 602.912, OM 602.962	2497		0-N565592	FB [TE]	
300 D , 300 D 4-matic , 300 Turbo-D , 300 Turbo-D 4-matic	12/84-06/93	OM 603.912, OM 603.913, OM 603.960, OM 603.960, OM 603.963, OM 603.963	2996		0-N565592	FB [TE]	
T1 Bus (601)							
208 D 2.3	10/88-02/96	OM 601.940	2299		0-N1289	VB [BT]	
208 D 2.3	10/88-02/96	OM 601.940	2299	hydraulisch	0-N1926	VB [VD]	
208 D 2.3	10/88-02/96	OM 601.940	2299		0-N846	VB [TE]	
208 D 2.3	10/88-02/96	OM 601.940	2299	, für Fahrzeuge ohne Servolenkung	0-N847	VB [TE]	
210 2.3	07/82-02/96	M 102.942, M 102.945	2298	mit Anbaumaterial	0-N1013	VB [BT]	S
210 2.3	07/82-02/96	M 102.942, M 102.945	2298	:000647→;	0-N2144	VB [VD]	
210 2.3	07/82-02/96	M 102.942, M 102.945	2298	:006636→;	0-N2144	VB [VD]	
210 2.3	07/82-02/96	M 102.942, M 102.945	2298	:→000646;	0-N2145	VB [VD]	
210 2.3	07/82-02/96	M 102.942, M 102.945	2298	:→006635;	0-N2145	VB [VD]	
210 2.3	07/82-02/96	M 102.942, M 102.945	2298		0-N846	VB [TE]	
210 2.3	07/82-02/96	M 102.942, M 102.945	2298	, für Fahrzeuge ohne Servolenkung	0-N847	VB [TE]	
210 D 2.8	11/88-02/96	OM 602.940	2874		0-N1289	VB [BT]	
210 D 2.8	11/88-02/96	OM 602.940	2874	hydraulisch	0-N1926	VB [VD]	
210 D 2.8	11/88-02/96	OM 602.940	2874		0-N846	VB [TE]	
210 D 2.8	11/88-02/96	OM 602.940	2874	, für Fahrzeuge ohne Servolenkung	0-N847	VB [TE]	
208 D 2.3	10/88-02/96	OM 601.940	2299		0-N565592	FB [TE]	
210 D 2.8	11/88-02/96	OM 602.940	2874		0-N565592	FB [TE]	
T1 Kasten (601)							
208 D 2.3	10/88-02/96	OM 601.940	2299		0-N1289	VB [BT]	
208 D 2.3	10/88-02/96	OM 601.940	2299	hydraulisch	0-N1926	VB [VD]	
208 D 2.3	10/88-02/96	OM 601.940	2299		0-N846	VB [TE]	
208 D 2.3	10/88-02/96	OM 601.940	2299	, für Fahrzeuge ohne Servolenkung	0-N847	VB [TE]	
210 2.3	07/82-02/96	M 102.942, M 102.946, M 102.945	2298	mit Anbaumaterial	0-N1013	VB [BT]	S
210 2.3	07/82-02/96	M 102.942, M 102.946, M 102.945	2298	:000647→;	0-N2144	VB [VD]	
210 2.3	07/82-02/96	M 102.942, M 102.946, M 102.945	2298	:006636→;	0-N2144	VB [VD]	
210 2.3	07/82-02/96	M 102.942, M 102.946, M 102.945	2298	:→000646;	0-N2145	VB [VD]	
210 2.3	07/82-02/96	M 102.942, M 102.946, M 102.945	2298	:→006635;	0-N2145	VB [VD]	
210 2.3	07/82-02/96	M 102.942, M 102.946, M 102.945	2298		0-N846	VB [TE]	
210 2.3	07/82-02/96	M 102.942, M 102.946, M 102.945	2298	, für Fahrzeuge ohne Servolenkung	0-N847	VB [TE]	
210 D 2.8	10/88-02/96	OM 602.940	2874		0-N1289	VB [BT]	
210 D 2.8	10/88-02/96	OM 602.940	2874	hydraulisch	0-N1926	VB [VD]	
210 D 2.8	10/88-02/96	OM 602.940	2874		0-N846	VB [TE]	
210 D 2.8	10/88-02/96	OM 602.940	2874	, für Fahrzeuge ohne Servolenkung	0-N847	VB [TE]	
208 D 2.3	10/88-02/96	OM 601.940	2299		0-N565592	FB [TE]	
210 D 2.8	10/88-02/96	OM 602.940	2874		0-N565592	FB [TE]	
T1 Pritsche/Fahrgestell (601)							
208 D 2.3	11/88-02/96	OM 601.940	2299		0-N1289	VB [BT]	
208 D 2.3	11/88-02/96	OM 601.940	2299	hydraulisch	0-N1926	VB [VD]	
208 D 2.3	11/88-02/96	OM 601.940	2299		0-N846	VB [TE]	
208 D 2.3	11/88-02/96	OM 601.940	2299	, für Fahrzeuge ohne Servolenkung	0-N847	VB [TE]	
210 2.3	04/77-10/89	M 102.942	2298	mit Anbaumaterial	0-N1013	VB [BT]	S
210 2.3	04/77-10/89	M 102.942	2298	:000647→;	0-N2144	VB [VD]	



OPTIMAL®

MERCEDES-BENZ



CM³



Art. Nr.



T1 Pritsche/Fahrgestell (601)

210 2.3	04/77-10/89	M 102.942	2298	:006636→;	0-N2144	VB [VD]
210 2.3	04/77-10/89	M 102.942	2298	:→000646;	0-N2145	VB [VD]
210 2.3	04/77-10/89	M 102.942	2298	:→006635;	0-N2145	VB [VD]
210 2.3	04/77-10/89	M 102.942	2298		0-N846	VB [TE]
210 2.3	04/77-10/89	M 102.942	2298	, für Fahrzeuge ohne Servolenkung	0-N847	VB [TE]
210 D 2.8, 210 D 2.9	11/88-02/96	OM 602.940	2874		0-N1289	VB [BT]
210 D 2.8, 210 D 2.9	11/88-02/96	OM 602.940	2874	hydraulisch	0-N1926	VB [VD]
210 D 2.8, 210 D 2.9	11/88-02/96	OM 602.940	2874		0-N846	VB [TE]
210 D 2.8, 210 D 2.9	11/88-02/96	OM 602.940	2874	, für Fahrzeuge ohne Servolenkung	0-N847	VB [TE]
208 D 2.3	11/88-02/96	OM 601.940	2299		0-N565592	FB [TE]
210 D 2.8, 210 D 2.9	11/88-02/96	OM 602.940	2874		0-N565592	FB [TE]

T1 Bus (602)

308 D 2.3	06/89-02/96	OM 601.940	2299		0-N1289	VB [BT]
308 D 2.3	06/89-02/96	OM 601.940	2299	hydraulisch	0-N1926	VB [VD]
308 D 2.3	06/89-02/96	OM 601.940	2299		0-N846	VB [TE]
308 D 2.3	06/89-02/96	OM 601.940	2299	, für Fahrzeuge ohne Servolenkung	0-N847	VB [TE]
310 D 2.9	06/89-02/96	OM 602.940	2874		0-N1289	VB [BT]
310 D 2.9	06/89-02/96	OM 602.940	2874	hydraulisch	0-N1926	VB [VD]
310 D 2.9	06/89-02/96	OM 602.940	2874		0-N846	VB [TE]
310 D 2.9	06/89-02/96	OM 602.940	2874	, für Fahrzeuge ohne Servolenkung	0-N847	VB [TE]
308 D 2.3	06/89-02/96	OM 601.940	2299		0-N565592	FB [TE]
310 D 2.9	06/89-02/96	OM 602.940	2874		0-N565592	FB [TE]

T1 Kasten (602)

308 D 2.3	11/88-02/96	OM 601.940	2299		0-N1289	VB [BT]
308 D 2.3	11/88-02/96	OM 601.940	2299	hydraulisch	0-N1926	VB [VD]
308 D 2.3	11/88-02/96	OM 601.940	2299		0-N846	VB [TE]
308 D 2.3	11/88-02/96	OM 601.940	2299	, für Fahrzeuge ohne Servolenkung	0-N847	VB [TE]
310 D 2.9	06/89-02/96	OM 602.940	2874		0-N1289	VB [BT]
310 D 2.9	06/89-02/96	OM 602.940	2874	hydraulisch	0-N1926	VB [VD]
310 D 2.9	06/89-02/96	OM 602.940	2874		0-N846	VB [TE]
310 D 2.9	06/89-02/96	OM 602.940	2874	, für Fahrzeuge ohne Servolenkung	0-N847	VB [TE]
308 D 2.3	11/88-02/96	OM 601.940	2299		0-N565592	FB [TE]
310 D 2.9	06/89-02/96	OM 602.940	2874		0-N565592	FB [TE]

T1 Pritsche/Fahrgestell (602)

308 D 2.3	06/89-02/96	OM 601.940	2299		0-N1289	VB [BT]
308 D 2.3	06/89-02/96	OM 601.940	2299	hydraulisch	0-N1926	VB [VD]
308 D 2.3	06/89-02/96	OM 601.940	2299		0-N846	VB [TE]
308 D 2.3	06/89-02/96	OM 601.940	2299	, für Fahrzeuge ohne Servolenkung	0-N847	VB [TE]
310 D 2.9	06/89-02/96	OM 602.940	2874		0-N1289	VB [BT]
310 D 2.9	06/89-02/96	OM 602.940	2874	hydraulisch	0-N1926	VB [VD]
310 D 2.9	06/89-02/96	OM 602.940	2874		0-N846	VB [TE]
310 D 2.9	06/89-02/96	OM 602.940	2874	, für Fahrzeuge ohne Servolenkung	0-N847	VB [TE]
308 D 2.3	06/89-02/96	OM 601.940	2299		0-N565592	FB [TE]
310 D 2.9	06/89-02/96	OM 602.940	2874		0-N565592	FB [TE]

T1/TN Kasten/Kombi

408 D	11/88-06/95	OM 601.940	2299		0-N1289	VB [BT]
408 D	11/88-06/95	OM 601.940	2299	hydraulisch	0-N1926	VB [VD]
408 D	11/88-06/95	OM 601.940	2299		0-N846	VB [TE]
408 D	11/88-06/95	OM 601.940	2299	, für Fahrzeuge ohne Servolenkung	0-N847	VB [TE]
410	08/82-06/95	M 102.942, M 102.945	2298	mit Anbaumaterial	0-N1013	VB [BT] S
410	08/82-06/95	M 102.942, M 102.945	2298	:000647→;	0-N2144	VB [VD]
410	08/82-06/95	M 102.942, M 102.945	2298	:006637→;	0-N2144	VB [VD]
410	08/82-06/95	M 102.942, M 102.945	2298	:→000646;	0-N2145	VB [VD]
410	08/82-06/95	M 102.942, M 102.945	2298	:→006635;	0-N2145	VB [VD]
410	08/82-06/95	M 102.942, M 102.945	2298		0-N846	VB [TE]
410	08/82-06/95	M 102.942, M 102.945	2298	, für Fahrzeuge ohne Servolenkung	0-N847	VB [TE]
410 D	11/88-06/95	OM 602.940	2874		0-N1289	VB [BT]
410 D	11/88-06/95	OM 602.940	2874	hydraulisch	0-N1926	VB [VD]
410 D	11/88-06/95	OM 602.940	2874		0-N846	VB [TE]
410 D	11/88-06/95	OM 602.940	2874	, für Fahrzeuge ohne Servolenkung	0-N847	VB [TE]
408 D	11/88-06/95	OM 601.940	2299	:→004190	0-N565592	FB [TE]
410 D	11/88-06/95	OM 602.940	2874	:→004190	0-N565592	FB [TE]



CM³



Art. Nr.



T1/TN Pritsche/Fahrgestell							
408 D	11/88-06/95	OM 601.940	2299			0-N1289	VB [BT]
408 D	11/88-06/95	OM 601.940	2299	hydraulisch		0-N1926	VB [VD]
408 D	11/88-06/95	OM 601.940	2299			0-N846	VB [TE]
408 D	11/88-06/95	OM 601.940	2299	☼, für Fahrzeuge ohne Servolenkung		0-N847	VB [TE]
410	08/82-06/95	M 102.942, M 102.945	2298	mit Anbaumaterial		0-N1013	VB [BT] S
410	08/82-06/95	M 102.942, M 102.945	2298	:→000647→;		0-N2144	VB [VD]
410	08/82-06/95	M 102.942, M 102.945	2298	:→006637→;		0-N2144	VB [VD]
410	08/82-06/95	M 102.942, M 102.945	2298	:→000646;		0-N2145	VB [VD]
410	08/82-06/95	M 102.945	2298	:→006635;		0-N2145	VB [VD]
410	08/82-06/95	M 102.942	2298	:→006636;		0-N2145	VB [VD]
410	08/82-06/95	M 102.942, M 102.945	2298			0-N846	VB [TE]
410	08/82-06/95	M 102.942, M 102.945	2298	☼, für Fahrzeuge ohne Servolenkung		0-N847	VB [TE]
410 D	11/88-06/95	OM 602.940	2874			0-N1289	VB [BT]
410 D	11/88-06/95	OM 602.940	2874	hydraulisch		0-N1926	VB [VD]
410 D	11/88-06/95	OM 602.940	2874			0-N846	VB [TE]
410 D	11/88-06/95	OM 602.940	2874	☼, für Fahrzeuge ohne Servolenkung		0-N847	VB [TE]
408 D	11/88-06/95	OM 601.940	2299	:→049508		0-N565592	FB [TE]
410 D	11/88-06/95	OM 602.940	2874	:→049508		0-N565592	FB [TE]
T2/LN1 Kasten/Kombi							
508 D	03/89-12/94	OM 601.941	2299	Rippenanzahl: 6; ☼, für Fahrzeuge ohne Servolenkung		0-N1288	VB [DG]
508 D	03/89-12/94	OM 601.941	2299			0-N1289	VB [BT]
508 D	03/89-12/94	OM 601.941	2299	hydraulisch		0-N1926	VB [VD]
508 D	03/89-12/94	OM 601.941	2299			0-N846	VB [TE]
508 D	03/89-12/94	OM 601.941	2299	für Fahrzeuge ohne Servolenkung		0-N847	VB [TE]
510	04/86-12/94	M 102.946	2299	mit Anbaumaterial		0-N1013	VB [BT] S
508 D	03/89-12/94	OM 601.941	2299	:→049508		0-N565592	FB [TE]
T2/LN1 Kipper							
508 D	03/89-12/94	OM 601.941	2299	Rippenanzahl: 6; ☼, für Fahrzeuge ohne Servolenkung		0-N1288	VB [DG]
508 D	03/89-12/94	OM 601.941	2299			0-N1289	VB [BT]
508 D	03/89-12/94	OM 601.941	2299	hydraulisch		0-N1926	VB [VD]
508 D	03/89-12/94	OM 601.941	2299			0-N846	VB [TE]
508 D	03/89-12/94	OM 601.941	2299	für Fahrzeuge ohne Servolenkung		0-N847	VB [TE]
508 D	03/89-12/94	OM 601.941	2299	:→004190		0-N565592	FB [TE]
T2/LN1 Pritsche/Fahrgestell							
510	04/86-12/94	M 102.946	2299	mit Anbaumaterial		0-N1013	VB [BT] S
Vaneo (414)							
1.4	06/02-07/05	M 166.940	1397	☼		0-N1946	VB [BT]
1.4	06/02-07/05	M 166.940	1397	☼		0-N1946S1	VB [TE]
1.4	06/02-07/05	M 166.940	1397	☼		0-N1946S2	VB [TE]
1.6	02/02-07/05	M 166.961	1598	☼		0-N1388	VB [TE]
1.6	02/02-07/05	M 166.961	1598	☼		0-N1395	VB [DG]
1.6	02/02-07/05	M 166.961	1598	☼		0-N1723	VB [DG]
1.6	02/02-07/05	M 166.961	1598	☼		0-N1946	VB [BT]
1.6	02/02-07/05	M 166.961	1598	☼		0-N1946S1	VB [TE]
1.6	02/02-07/05	M 166.961	1598	☼		0-N1946S2	VB [TE]
1.7 CDI	02/02-07/05	OM 668.914	1689			0-N1388	VB [TE]
1.7 CDI	02/02-07/05	OM 668.914	1689			0-N1395	VB [DG]
1.7 CDI	02/02-07/05	OM 668.914	1689	☼		0-N1744	VB [DG]
1.7 CDI	02/02-07/05	OM 668.914	1689	☼		0-N1941	VB [BT]
1.7 CDI	02/02-07/05	OM 668.914	1689	☼		0-N1941S1	VB [TE]
1.7 CDI	02/02-07/05	OM 668.914	1689	☼		0-N1941S2	VB [TE]
1.7 CDI	02/02-07/05	OM 668.914	1689	☼		0-N1941S3	VB [TE]
1.7 CDI	02/02-07/05	OM 668.914	1689	Rippenanzahl: 5; ☼		0-N1972	VB [DG]
1.9	02/02-07/05	M 166.991	1898			0-N1388	VB [TE]
1.9	02/02-07/05	M 166.991	1898	☼		0-N1395	VB [DG]
1.9	02/02-07/05	M 166.991	1898	☼		0-N1723	VB [DG]
1.9	02/02-07/05	M 166.991	1898	☼		0-N1946	VB [BT]
1.9	02/02-07/05	M 166.991	1898	☼		0-N1946S1	VB [TE]
1.9	02/02-07/05	M 166.991	1898	☼		0-N1946S2	VB [TE]
VARIO Bus							
O 812	09/96-	OM 602.984, OM 602.985	2874			0-N1043	VB [BT]
O 812	09/96-	OM 602.984, OM 602.985	2874			0-N1278	VB [TE]



OPTIMAL®

MERCEDES-BENZ

**CM³**

Art. Nr.



VARIO Bus							
O 812	09/96-	OM 602.984, OM 602.985	2874			0-N2147	VB [VD]
O 812	09/96-	OM 602.984, OM 602.985	2874			0-N846	VB [TE]
O 812	09/96-	OM 602.984, OM 602.985	2874	☒		0-N847	VB [TE]
VARIO Kasten/Kombi							
512 D, 612 D, 812 D	09/96-	OM 602.984, OM 602.984, OM 602.985	2874			0-N1043	VB [BT]
512 D, 612 D, 812 D	09/96-	OM 602.984, OM 602.984, OM 602.985	2874			0-N2147	VB [VD]
512 D, 612 D, 812 D	09/96-	OM 602.984, OM 602.984, OM 602.985	2874			0-N846	VB [TE]
512 D, 612 D, 812 D	09/96-	OM 602.984, OM 602.984, OM 602.985	2874	☒		0-N847	VB [TE]
612 D, 812 D	09/96-	OM 602.984, OM 602.985	2874			0-N1278	VB [TE]
VARIO Kipper							
612 D, 812 D	09/96-	OM 602.984, OM 602.985	2874			0-N1043	VB [BT]
612 D, 812 D	09/96-	OM 602.984, OM 602.985	2874			0-N1278	VB [TE]
612 D, 812 D	09/96-	OM 602.984, OM 602.985	2874			0-N2147	VB [VD]
612 D, 812 D	09/96-	OM 602.984, OM 602.985	2874			0-N846	VB [TE]
612 D, 812 D	09/96-	OM 602.984, OM 602.985	2874	☒		0-N847	VB [TE]
VARIO Pritsche/Fahrgestell							
512 D, 612 D, 812 D	09/96-	OM 602.984, OM 602.984, OM 602.985	2874			0-N1043	VB [BT]
512 D, 612 D, 812 D	09/96-	OM 602.984, OM 602.984, OM 602.985	2874			0-N2147	VB [VD]
512 D, 612 D, 812 D	09/96-	OM 602.984, OM 602.984, OM 602.985	2874			0-N846	VB [TE]
512 D, 612 D, 812 D	09/96-	OM 602.984, OM 602.984, OM 602.985	2874	☒		0-N847	VB [TE]
612 D, 812 D	09/96-	OM 602.984, OM 602.985	2874			0-N1278	VB [TE]
V-KLASSE (638/2)							
V 200	02/97-07/03	M 111.948, M 111.950	1998			0-N1703	VB [BT]
V 200	02/97-07/03	M 111.948, M 111.950	1998			0-N1833	VB [TE]
V 200	02/97-07/03	M 111.948, M 111.950	1998			0-N1951	VB [VD]
V 200	02/97-07/03	M 111.948, M 111.950	1998			0-N2418	VB [BT]
V 200 CDI, V 220 CDI	03/99-07/03	OM 611.980	2151	Rippenanzahl: 6		0-N1431	VB [DG]
V 200 CDI, V 220 CDI	03/99-07/03	OM 611.980	2151	Rippenanzahl: 6; ☒		0-N1436	VB [DG] S
V 200 CDI, V 220 CDI	03/99-07/03	OM 611.980	2151			0-N1641	VB [BT] S
V 230	10/96-07/03	M 111.978	2295			0-N1703	VB [BT]
V 230	10/96-07/03	M 111.978	2295			0-N1833	VB [TE]
V 230	10/96-07/03	M 111.978	2295	→ 03/1999		0-N1951	VB [VD]
V 230	10/96-07/03	M 111.978	2295			0-N2418	VB [BT]
V 230 TD	09/96-07/03	OM 601.970	2299			0-N1043	VB [BT]
V 230 TD	09/96-07/03	OM 601.970	2299			0-N2147	VB [VD]
V 230 TD	09/96-07/03	OM 601.970	2299			0-N846	VB [TE]
V 230 TD	09/96-07/03	OM 601.970	2299			0-N847	VB [TE]
V 280	08/97-07/03	M 104.900	2792	Rippenanzahl: 7		0-N1657	VB [BT] S
V-KLASSE (W447)							
V 200 CDI, V 220 CDI, V 250 BlueTEC, V 250 BlueTEC / V 250 d 4-matic	03/14-	OM 651.950	2143			0-N2205	VB [DG]
VIANO (W639)							
3, 3.2	09/03-	M 112.951	3199	Rippenanzahl: 6		0-N1431	VB [DG]
3, 3.2	09/03-	M 112.951	3199			0-N1645	VB [BT] S
3.5	09/07-	M 272.978	3498	Rippenanzahl: 6		0-N1637	VB [DG]
3.5	09/07-	M 272.978	3498			0-N1670	VB [BT] S
3.5	09/07-	M 272.978	3498			0-N2138	VB [DG]
3.5	09/07-	M 272.978	3498	☒		0-N2143	VB [VD]
3.7	06/04-	M 112.976	3724	Rippenanzahl: 6		0-N1431	VB [DG]
3.7	06/04-	M 112.976	3724			0-N1645	VB [BT] S
CDI 2.0, CDI 2.0 4-matic, CDI 2.2, CDI 2.2 4-matic	09/03-	OM 646.980, OM 646.982, OM 646.982	2148	Rippenanzahl: 6		0-N1431	VB [DG]
CDI 2.0, CDI 2.0 4-matic, CDI 2.2, CDI 2.2 4-matic	09/03-	OM 646.980, OM 646.982, OM 646.982	2148			0-N1641	VB [BT] S
CDI 2.0, CDI 2.0 4-matic, CDI 2.2, CDI 2.2 4-matic	07/10-	OM 651.940	2143			0-N2086	VB [BT] S
CDI 2.0, CDI 2.0 4-matic, CDI 2.2, CDI 2.2 4-matic	07/10-	OM 651.940	2143			0-N2238	VB [DG]
CDI 2.0, CDI 2.0 4-matic, CDI 2.2, CDI 2.2 4-matic	07/10-	OM 651.940	2143			0-N2296	VB [DG]
CDI 2.0, CDI 2.0 4-matic, CDI 2.2, CDI 2.2 4-matic	07/10-	OM 651.940	2143	Rippenanzahl: 6		0-N2312	VB [DG]
CDI 3.0	03/06-	OM 642.990	2987			0-N1560	VB [DG]
CDI 3.0	03/06-	OM 642.990	2987			0-N1902	VB [BT] S
CDI 3.0	07/10-	651.940	2987			0-N2086	VB [BT] S



CM³



Art. Nr.



ohne Halter

VITO Bus (638)							
108 CDI 2.2	03/99-07/03	OM 611A (60 KW CDI)	2148			0-N1951	VB [VD]
108 CDI 2.2 , 110 CDI 2.2	03/99-07/03	OM 611A (60 KW CDI), OM 611LA (75 KW CDI)	2148	Rippenanzahl: 6		0-N1431	VB [DG]
108 CDI 2.2 , 110 CDI 2.2	03/99-07/03	OM 611A (60 KW CDI), OM 611LA (75 KW CDI)	2148			0-N1641	VB [BT] S
108 D 2.3	02/96-07/03	OM 601.942	2299	Rippenanzahl: 6; ⚡, für Fahrzeuge ohne Servolenkung		0-N1288	VB [DG]
108 D 2.3	02/96-07/03	OM 601.942	2299	für Fahrzeuge ohne Servolenkung		0-N847	VB [TE]
108 D 2.3 , 110 TD 2.3	02/96-07/03	OM 601.942, OM 601.970	2299			0-N1043	VB [BT]
108 D 2.3 , 110 TD 2.3	02/96-07/03	OM 601.942, OM 601.970	2299			0-N2147	VB [VD]
108 D 2.3 , 110 TD 2.3	02/96-07/03	OM 601.942, OM 601.970	2299			0-N846	VB [TE]
110 TD 2.3	02/96-07/03	OM 601.970	2299			0-N847	VB [TE]
112 CDI 2.2	03/99-07/03	OM 611.980	2151	Rippenanzahl: 6		0-N1431	VB [DG]
112 CDI 2.2	03/99-07/03	OM 611.980	2151	Rippenanzahl: 6; ⚡		0-N1436	VB [DG] S
112 CDI 2.2	03/99-07/03	OM 611.980	2151			0-N1641	VB [BT] S
113 2.0	02/96-07/03	M 111.948, M 111.950	1998			0-N1703	VB [BT]
113 2.0	02/96-07/03	M 111.948, M 111.950	1998			0-N1833	VB [TE]
113 2.0	02/96-07/03	M 111.948, M 111.950	1998			0-N1951	VB [VD]
113 2.0	02/96-07/03	M 111.948, M 111.950	1998			0-N2418	VB [BT]
114 2.3	12/96-07/03	M 111.978	2295			0-N1703	VB [BT]
114 2.3	12/96-07/03	M 111.978	2295			0-N1833	VB [TE]
114 2.3	12/96-07/03	M 111.978	2295			0-N1951	VB [VD]
114 2.3	12/96-07/03	M 111.978	2295			0-N2418	VB [BT]
VITO Kasten (638)							
108 CDI 2.2	03/99-07/03	OM 611A (60 KW CDI)	2151			0-N1951	VB [VD]
108 CDI 2.2 , 110 CDI 2.2 , 112 CDI 2.2	03/99-07/03	OM 611.980, OM 611A (60 KW CDI), OM 611LA (75 KW CDI)	2151	Rippenanzahl: 6		0-N1431	VB [DG]
108 CDI 2.2 , 110 CDI 2.2 , 112 CDI 2.2	03/99-07/03	OM 611.980, OM 611A (60 KW CDI), OM 611LA (75 KW CDI)	2151			0-N1641	VB [BT] S
108 D 2.3	03/97-07/03	OM 601.942	2299	Rippenanzahl: 6; ⚡, für Fahrzeuge ohne Servolenkung		0-N1288	VB [DG]
108 D 2.3	03/97-07/03	OM 601.942	2299	für Fahrzeuge ohne Servolenkung		0-N847	VB [TE]
108 D 2.3 , 110 D 2.3	03/97-07/03	OM 601.942, OM 601.970	2299			0-N1043	VB [BT]
108 D 2.3 , 110 D 2.3	03/97-07/03	OM 601.942, OM 601.970	2299			0-N2147	VB [VD]
108 D 2.3 , 110 D 2.3	03/97-07/03	OM 601.942, OM 601.970	2299			0-N846	VB [TE]
110 D 2.3	03/97-07/03	OM 601.970	2299			0-N847	VB [TE]
112 CDI 2.2	03/99-07/03	OM 611.980	2151	Rippenanzahl: 6; ⚡		0-N1436	VB [DG] S
113 2.0	03/97-07/03	M 111.948, M 111.950	1998			0-N1703	VB [BT]
113 2.0	03/97-07/03	M 111.948, M 111.950	1998			0-N1833	VB [TE]
113 2.0	03/97-07/03	M 111.948, M 111.950	1998			0-N1951	VB [VD]
113 2.0	03/97-07/03	M 111.948, M 111.950	1998			0-N2418	VB [BT]
114 2.3	03/97-07/03	M 111.978	2295			0-N1703	VB [BT]
114 2.3	03/97-07/03	M 111.978	2295			0-N1833	VB [TE]
114 2.3	03/97-07/03	M 111.978	2295			0-N1951	VB [VD]
114 2.3	03/97-07/03	M 111.978	2295			0-N2418	VB [BT]
VITO Kasten (W447)							
114 CDI, 116 CDI, 119 BlueTEC	10/14-	OM 651.950	2143			0-N2205	VB [DG]
VITO Mixto (W447)							
114 CDI, 116 CDI, 119 BlueTEC, 119 BlueTEC 4x4 (447.605)	10/14-	OM 651.950	2143			0-N2205	VB [DG]
VITO Tourer (W447)							
114 CDI, 116 CDI, 119 BlueTEC, 119 BlueTEC 4x4	10/14-	OM 651.950	2143			0-N2205	VB [DG]
VITO Bus (W639)							
109 CDI, 109 CDI 4x4, 111 CDI, 111 CDI 4x4, 115 CDI, 115 CDI 4x4	09/03-	OM 646.980, OM 646.980, OM 646.982, OM 646.981, OM 646.982, OM 646.983	2148	Rippenanzahl: 6		0-N1431	VB [DG]
109 CDI, 109 CDI 4x4, 111 CDI, 111 CDI 4x4, 115 CDI, 115 CDI 4x4	09/03-	OM 646.980, OM 646.980, OM 646.982, OM 646.981, OM 646.982, OM 646.983	2148			0-N1641	VB [BT] S
110 CDI	09/10-	OM 651.940	2143			0-N1641	VB [BT] S
110 CDI, 113 CDI, 113 CDI 4x4, 116 CDI, 116 CDI 4x4	09/10-	OM 651.940	2143			0-N2086	VB [BT] S
110 CDI, 113 CDI, 113 CDI 4x4, 116 CDI, 116 CDI 4x4	09/10-	OM 651.940	2143			0-N2238	VB [DG]
110 CDI, 113 CDI, 113 CDI 4x4, 116 CDI, 116 CDI 4x4	09/10-	OM 651.940	2143			0-N2296	VB [DG]
110 CDI, 113 CDI, 113 CDI 4x4, 116 CDI, 116 CDI 4x4	09/10-	OM 651.940	2143	Rippenanzahl: 6		0-N2312	VB [DG]



OPTIMAL®

MERCEDES-BENZ

**CM³**

Art. Nr.



ohne Halter

VITO Bus (W639)

119, 122	09/03-	M 112.951	3199	Rippenanzahl: 6	0-N1431	VB [DG]	
119, 122	09/03-	M 112.951	3199		0-N1645	VB [BT]	S
120 CDI, 122 CDI	07/06-	OM 642.890, OM 642.990	2987		0-N1560	VB [DG]	
120 CDI, 122 CDI	07/06-	OM 642.890, OM 642.990	2987		0-N1902	VB [BT]	S
122 CDI	09/10-	651.940	2987		0-N2086	VB [BT]	S
123	06/04-	M 112.976	3724	Rippenanzahl: 6	0-N1431	VB [DG]	
123	06/04-	M 112.976	3724		0-N1645	VB [BT]	S
126	09/07-	M 272.978	3498	Rippenanzahl: 6	0-N1637	VB [DG]	
126	09/07-	M 272.978	3498		0-N1670	VB [BT]	S
126	09/07-	M 272.978	3498		0-N2138	VB [DG]	
126	09/07-	M 272.978	3498		0-N2143	VB [VD]	

VITO / MIXTO Kasten (W639)

109 CDI, 111 CDI, 111 CDI 4x4, 115 CDI, 115 CDI 4x4	09/03-	OM 646.980, OM 646.981, OM 646.980, OM 646.982, OM 646.982, OM 646.983	2148	Rippenanzahl: 6	0-N1431	VB [DG]	
109 CDI, 111 CDI, 111 CDI 4x4, 115 CDI, 115 CDI 4x4	09/03-	OM 646.980, OM 646.981, OM 646.980, OM 646.982, OM 646.982, OM 646.983	2148		0-N1641	VB [BT]	S
110 CDI	09/10-	OM 651.940	2143		0-N1641	VB [BT]	S
110 CDI, 113 CDI, 113 CDI 4x4, 116 CDI, 116 CDI 4x4	09/10-	OM 651.940	2143		0-N2086	VB [BT]	S
110 CDI, 113 CDI, 113 CDI 4x4, 116 CDI, 116 CDI 4x4	09/10-	OM 651.940	2143		0-N2296	VB [DG]	
110 CDI, 113 CDI, 113 CDI 4x4, 116 CDI, 116 CDI 4x4	09/10-	OM 651.940	2143	Rippenanzahl: 6	0-N2312	VB [DG]	
110 CDI, 113 CDI, 116 CDI	09/10-	OM 651.940	2143		0-N2238	VB [DG]	
119, 122	09/03-	M 112.951	3199	Rippenanzahl: 6	0-N1431	VB [DG]	
119, 122	09/03-	M 112.951	3199		0-N1645	VB [BT]	S
120 CDI, 122 CDI	07/06-	OM 642.890, OM 642.990	2987		0-N1560	VB [DG]	
120 CDI, 122 CDI	07/06-	OM 642.890, OM 642.990	2987		0-N1902	VB [BT]	S
123	06/04-07/08	M 112.976	3724	Rippenanzahl: 6	0-N1431	VB [DG]	
123	06/04-07/08	M 112.976	3724		0-N1645	VB [BT]	S
126	09/07-	M 272.978	3498	Rippenanzahl: 6	0-N1637	VB [DG]	
126	09/07-	M 272.978	3498		0-N1670	VB [BT]	S
126	09/07-	M 272.978	3498		0-N2138	VB [DG]	
126	09/07-	M 272.978	3498		0-N2143	VB [VD]	

S-KLASSE (W222, V222, X222)

S 300 BlueTEC Hybrid	02/14-	OM 651.921	2143		0-N2307	VB [BT]	S
S 320, S 500 Hybrid	05/14-	M 276.824	2996		0-N2368	VB [DG]	
S 320, S 500 Hybrid	05/14-	M 276.824	2996		0-N2403	VB [BT]	S
S 350 BlueTEC, S 350 BlueTEC 4-matic	05/13-	OM 642.861, OM 642.867	2987		0-N1560	VB [DG]	
S 400 Hybrid	05/13-	M 276.960	3498		0-N2368	VB [DG]	
S 400 Hybrid	05/13-	M 276.960	3498		0-N2403	VB [BT]	S
S 500, S 500 4-matic, S 500 Maybach, S 500 Maybach 4-matic	05/13-	M 278.929	4663		0-N2284	VB [DG]	
S 63 AMG, S 63 AMG 4-matic	05/13-	M 157.985	5461		0-N2284	VB [DG]	



CM³



Art. Nr.



ohne Halter

C-KLASSE (W204)							
C 230	05/08-10/09	M 272.921	2496			0-N2143	VB [VD]
C 280	03/08-01/09	M 272.947	2996			0-N2143	VB [VD]
E-KLASSE (W211)							
2.5 E 230	11/05-	M 272.922	2496			0-N2143	VB [VD]
3.0 E 280	11/05-	M 272.943	2998			0-N2143	VB [VD]
3.5 E 350	11/05-	M 272.964	3495			0-N2143	VB [VD]



OPTIMAL®

MERCURY

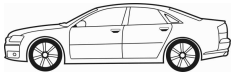

CM³



Art. Nr.



ohne Halter

GRAND MARQUIS

4.6	01/91-12/97	4601	01/1992 →	0-N1685	VB [DG]
-----	-------------	------	-----------	----------------	---------



CM³



Art. Nr.



EXPRESS Kasten

1.4	03/03-05/05	14 K4F	1396	23x143; mit Zubehör; Spannrollenbetätigung: manuell	SK-1067	BTK	
1.4	03/03-05/05	14 K4F	1396	26x145	SK-1504	BTK	
1.8	03/03-05/05	18 K4F	1796	23x143; :→66148133, 67665462; mit Zubehör; Spannrollenbetätigung: manuell	SK-1067	BTK	
1.8	03/03-05/05	18 K4F	1796	26x145; :66148134, 67665463→	SK-1504	BTK	
160	03/03-05/05	18 K4K	1796	26x143	SK-1507	BTK	
160	03/03-05/05	18 K4K	1796	26x143	SK-1706	BTK	
2.0 TD	03/03-05/05	20 T2N	1994	30x112; 24x78; :→1011;	SK-1501	BTK	
2.0 TD	03/03-05/05	20 T2N	1994	30x112; 24x78; :→5048;	SK-1501	BTK	
2.0 TD	03/03-05/05	20 T2N	1994	30x112; 24x78; :→8367;	SK-1501	BTK	
2.0 TD	03/03-05/05	20 T2N	1994	30x112; 24x78; :→9369;	SK-1501	BTK	
2.0 TD	03/03-05/05	20 T2N	1994	30x112; 24x78; :1012→;	SK-1552	BTK	
2.0 TD	03/03-05/05	20 T2N	1994	30x112; 24x78; :5049→;	SK-1552	BTK	
2.0 TD	03/03-05/05	20 T2N	1994	30x112; 24x78; :8368→;	SK-1552	BTK	
2.0 TD	03/03-05/05	20 T2N	1994	30x112; 24x78; :9370→;	SK-1552	BTK	
1.4	03/03-05/05	14 K4F	1396	manuell	0-N894	TB [TE]	
1.8	03/03-05/05	18 K4F	1796	manuell	0-N894	TB [TE]	

MAESTRO

2.0 EFi, 2.0 Turbo	10/84-09/90		1994	17x104	SK-1176	BTK	
--------------------	-------------	--	------	--------	---------	-----	--

MG TF

115	03/02-12/09	16 K4F	1588	26x145	SK-1504	BTK	
120	03/02-12/09	18 K4F	1796	23x143; mit Zubehör; Spannrollenbetätigung: manuell	SK-1067	BTK	
120, 135	03/02-12/09	18 K4F	1796	26x145	SK-1504	BTK	
135	03/02-12/09	18 K4F	1796	23x143; → 10/2005; mit Zubehör; Spannrollenbetätigung: manuell	SK-1067	BTK	
160	03/02-12/09	18 K4K	1796	26x143	SK-1507	BTK	
160	03/02-12/09	18 K4K	1796	26x143	SK-1507AQ1	BTKW	
160	03/02-12/09	18 K4K	1796	26x143; → 10/2005	SK-1706	BTK	
160	03/02-12/09	18 K4K	1796	26x143	SK-1706AQ1	BTKW	
115	03/02-12/09	16 K4F	1588		0-N1272	TB [TE]	
115	03/02-12/09	16 K4F	1588		0-N894	TB [TE]	
120, 135	03/02-12/09	18 K4F	1796		0-N1272	TB [TE]	
120, 135, 160	03/02-12/09	18 K4F, 18 K4K	1796		0-N894	TB [TE]	
115	03/02-12/09	16 K4F	1588		0-N1584	VB [TE]	
120, 135, 160	03/02-12/09	18 K4F, 18 K4K	1796		0-N1584	VB [TE]	

MG ZR

105	06/01-04/05	14 K4F	1396	23x143; mit Zubehör; Spannrollenbetätigung: manuell	SK-1067	BTK	
105	06/01-04/05	14 K4F	1396	26x145	SK-1504	BTK	
120	06/01-04/05	18 K4F	1796	23x143; :→66148133, 67665462; mit Zubehör; Spannrollenbetätigung: manuell	SK-1067	BTK	
120	06/01-04/05	18 K4F	1796	26x145; :66148134, 67665463→	SK-1504	BTK	
160	06/01-04/05	18 K4K	1796	26x143	SK-1507	BTK	
160	06/01-04/05	18 K4K	1796	26x143; → 10/2005	SK-1706	BTK	
2.0 TD	06/01-04/05	20 T2N	1994	30x112; 24x78; :→5048;	SK-1501	BTK	
2.0 TD	06/01-04/05	20 T2N	1994	30x112; 24x78; :→8367;	SK-1501	BTK	
2.0 TD	06/01-04/05	20 T2N	1994	30x112; 24x78; :5049→;	SK-1552	BTK	
2.0 TD	06/01-04/05	20 T2N	1994	30x112; 24x78; :8368→;	SK-1552	BTK	
105	06/01-04/05	14 K4F	1396		0-N1272	TB [TE]	
105	06/01-04/05	14 K4F	1396		0-N894	TB [TE]	
120	06/01-04/05	18 K4F	1796		0-N1272	TB [TE]	
120, 160	06/01-04/05	18 K4F, 18 K4K	1796		0-N894	TB [TE]	
2.0 TD	06/01-04/05	20 T2N	1994	ch.471565→	0-N1120	TB [TE]	
2.0 TD	06/01-04/05	20 T2N	1994	ch.471565→; :→5048;	0-N1121	TB [TE]	
2.0 TD	06/01-04/05	20 T2N	1994	ch.471565→; :→8367;	0-N1121	TB [TE]	
2.0 TD	06/01-04/05	20 T2N	1994	ch.471565→	0-N1122	TB [DG]	
2.0 TD	06/01-04/05	20 T2N	1994	ch.→471564	0-N1273	TB [TE]	
2.0 TD	06/01-04/05	20 T2N	1994	:5049→	0-N1273	TB [TE]	
2.0 TD	06/01-04/05	20 T2N	1994	:8368→	0-N1273	TB [TE]	
2.0 TD	06/01-04/05	20 T2N	1994	ch.→471564	0-N236	TB [TE]	
2.0 TD	06/01-04/05	20 T2N	1994	ch.→471564	0-N237	TB [DG]	
105	06/01-04/05	14 K4F	1396	manuell	0-N1412	VB [TE]	
105	06/01-04/05	14 K4F	1396		0-N1584	VB [TE]	
105	06/01-04/05	14 K4F	1396		0-N1643	VB [BT]	S



CM³



Art. Nr.



ohne Halter

MG ZR

120, 160	06/01-04/05	18 K4F, 18 K4K	1796	manuell	0-N1412	VB [TE]	
120, 160	06/01-04/05	18 K4F, 18 K4K	1796		0-N1584	VB [TE]	
120, 160	06/01-04/05	18 K4F, 18 K4K	1796		0-N1643	VB [BT]	S
2.0 TD	06/01-04/05	20 T2N	1994		0-N1535	VB [BT]	S

MG ZS

1.6	07/03-04/05	16 K4F	1588	23x143; :→654922, 655076; mit Zubehör; Spannrollenbetätigung: manuell	SK-1067	BTK	
1.6	07/03-04/05	16 K4F	1588	26x145; :654923, 655077→	SK-1504	BTK	
120	07/01-04/05	18 K4F	1796	23x143; mit Zubehör; Spannrollenbetätigung: mechanisch	SK-1067	BTK	
120	07/01-04/05	18 K4F	1796	26x145; 05/2002 →	SK-1504	BTK	
180	07/01-04/05	25 K4F	2497	22x58; 28x176; 04/2002 →; ohne Spanndämpfer, Spannrolle	SK-1502	BTK	
2.0 TD	01/04-04/05	20 T2N	1994	30x112; 24x78; :→1011;	SK-1501	BTK	
2.0 TD	01/04-04/05	20 T2N	1994	30x112; 24x78; :→9369;	SK-1501	BTK	
2.0 TD	01/04-04/05	20 T2N	1994	30x112; 24x78; :1012→;	SK-1552	BTK	
2.0 TD	01/04-04/05	20 T2N	1994	30x112; 24x78; :9370→;	SK-1552	BTK	
1.6	07/03-04/05	16 K4F	1588		0-N894	TB [TE]	
120	07/01-04/05	18 K4F	1796		0-N1272	TB [TE]	
180	07/01-04/05	25 K4F	2497		0-N1248	TB [DG]	
180	07/01-04/05	25 K4F	2497		0-N1261	TB [TE]	
2.0 TD	01/04-04/05	20 T2N	1994	ch.471064→	0-N1120	TB [TE]	
2.0 TD	01/04-04/05	20 T2N	1994	ch.471064→; :→1011;	0-N1121	TB [TE]	
2.0 TD	01/04-04/05	20 T2N	1994	ch.471064→; :→9369;	0-N1121	TB [TE]	
2.0 TD	01/04-04/05	20 T2N	1994	ch.471064→	0-N1122	TB [DG]	
2.0 TD	01/04-04/05	20 T2N	1994	ch.→471063	0-N1273	TB [TE]	
2.0 TD	01/04-04/05	20 T2N	1994	:1012→	0-N1273	TB [TE]	
2.0 TD	01/04-04/05	20 T2N	1994	:9370→	0-N1273	TB [TE]	
2.0 TD	01/04-04/05	20 T2N	1994	ch.→471063	0-N236	TB [TE]	
2.0 TD	01/04-04/05	20 T2N	1994	ch.→471063	0-N237	TB [DG]	
1.6	07/03-04/05	16 K4F	1588		0-N1643	VB [BT]	S
1.6	07/03-04/05	16 K4F	1588	ch.YD471064→;	0-N1659	VB [BT]	S
120	07/01-04/05	18 K4F	1796	manuell	0-N1412	VB [TE]	
120	07/01-04/05	18 K4F	1796	ch.→YD471063	0-N1584	VB [TE]	
120	07/01-04/05	18 K4F	1796		0-N1643	VB [BT]	S
120	07/01-04/05	18 K4F	1796	ch.YD471064→;	0-N1659	VB [BT]	S
180	07/01-04/05	25 K4F	2497		0-N1735	VB [DG]	
180	07/01-04/05	25 K4F	2497	ch.YD471064→	0-N1742	VB [BT]	S
2.0 TD	01/04-04/05	20 T2N	1994		0-N1535	VB [BT]	S

MG ZS Hatchback

120	07/01-10/05	18 K4F	1796	23x143; mit Zubehör; Spannrollenbetätigung: mechanisch	SK-1067	BTK	
120	07/01-10/05	18 K4F	1796	26x145	SK-1504	BTK	
180	07/01-10/05	25 K4F	2497	22x58; 28x176; 08/2001 →; ohne Spanndämpfer, Spannrolle	SK-1502	BTK	
2.0 TD	01/04-10/05	20 T2N	1994	30x112; 24x78; :→1011;	SK-1501	BTK	
2.0 TD	01/04-10/05	20 T2N	1994	30x112; 24x78; :→9369;	SK-1501	BTK	
2.0 TD	01/04-10/05	20 T2N	1994	30x112; 24x78; :1012→;	SK-1552	BTK	
2.0 TD	01/04-10/05	20 T2N	1994	30x112; 24x78; :9370→;	SK-1552	BTK	
1.6	11/01-10/05	16 K4F	1590		0-N894	TB [TE]	
120	07/01-10/05	18 K4F	1796		0-N1272	TB [TE]	
120	07/01-10/05	18 K4F	1796	mechanisch	0-N894	TB [TE]	
180	07/01-10/05	25 K4F	2497		0-N1248	TB [DG]	
180	07/01-10/05	25 K4F	2497		0-N1261	TB [TE]	
2.0 TD	01/04-10/05	20 T2N	1994	ch.471064→	0-N1120	TB [TE]	
2.0 TD	01/04-10/05	20 T2N	1994	ch.471064→; :→1011;	0-N1121	TB [TE]	
2.0 TD	01/04-10/05	20 T2N	1994	ch.471064→; :→9369;	0-N1121	TB [TE]	
2.0 TD	01/04-10/05	20 T2N	1994	ch.471064→	0-N1122	TB [DG]	
2.0 TD	01/04-10/05	20 T2N	1994	ch.→471063	0-N1273	TB [TE]	
2.0 TD	01/04-10/05	20 T2N	1994	:1012→	0-N1273	TB [TE]	
2.0 TD	01/04-10/05	20 T2N	1994	:9370→	0-N1273	TB [TE]	
2.0 TD	01/04-10/05	20 T2N	1994	ch.→471063	0-N236	TB [TE]	
2.0 TD	01/04-10/05	20 T2N	1994	ch.→471063	0-N237	TB [DG]	
1.6	11/01-10/05	16 K4F	1590		0-N1643	VB [BT]	S
1.6	11/01-10/05	16 K4F	1590	ch.YD471064→;	0-N1659	VB [BT]	S
120	07/01-10/05	18 K4F	1796	manuell	0-N1412	VB [TE]	



CM³



Art. Nr.



MG ZS Hatchback							
120	07/01-10/05	18 K4F	1796	ch.→YD471063	0-N1584	VB [TE]	
120	07/01-10/05	18 K4F	1796		0-N1643	VB [BT]	S
120	07/01-10/05	18 K4F	1796	ch.YD471064→; ⚡	0-N1659	VB [BT]	S
180	07/01-10/05	25 K4F	2497		0-N1735	VB [DG]	
180	07/01-10/05	25 K4F	2497	ch.YD471064→	0-N1742	VB [BT]	S
2.0 TD	01/04-10/05	20 T2N	1994		0-N1535	VB [BT]	S
MG ZT							
1.8 16V, 1.8 T 16V	01/03-07/05	18 K4F, 18 K4G	1795	26x145	SK-1504	BTK	
160	06/01-07/05	25 K4F	2497	22x58; 28x176; 10/2003 →; ohne Spanndämpfer, Spannrolle	SK-1502	BTK	
180	01/03-07/05	25 K4F	2497	22x58; 28x176; ohne Spanndämpfer, Spannrolle	SK-1502	BTK	
190	06/01-07/05	25 K4F	2497	22x58; 28x176; 08/2001 →; ohne Spanndämpfer, Spannrolle	SK-1502	BTK	
1.8 16V, 1.8 T 16V	01/03-07/05	18 K4F, 18 K4G	1795		0-N1272	TB [TE]	
160, 180, 190	06/01-07/05	25 K4F	2497		0-N1248	TB [DG]	
160, 180, 190	06/01-07/05	25 K4F	2497		0-N1261	TB [TE]	
1.8 16V, 1.8 T 16V	01/03-07/05	18 K4F, 18 K4G	1795		0-N1643	VB [BT]	S
1.8 16V, 1.8 T 16V	01/03-07/05	18 K4F, 18 K4G	1795	⚡	0-N1659	VB [BT]	S
160, 180, 190	06/01-07/05	25 K4F	2497	⚡	0-N1735	VB [DG]	
160, 180, 190	06/01-07/05	25 K4F	2497		0-N1742	VB [BT]	S
2.0 CDTi	06/02-07/05	204D2	1951	⚡	0-N1514	VB [BT]	S
MG ZT- T							
1.8 16V, 1.8 T 16V	01/03-07/05	18 K4F, 18 K4G	1795	26x145	SK-1504	BTK	
160	10/01-07/05	25 K4F	2497	22x58; 28x176; 10/2003 →; ohne Spanndämpfer, Spannrolle	SK-1502	BTK	
180	01/03-07/05	25 K4F	2497	22x58; 28x176; ohne Spanndämpfer, Spannrolle	SK-1502	BTK	
190	10/01-07/05	25 K4F	2497	22x58; 28x176; 12/2001 →; ohne Spanndämpfer, Spannrolle	SK-1502	BTK	
1.8 16V	01/03-07/05	18 K4F	1795		0-N1272	TB [TE]	
1.8 16V	01/03-07/05	18 K4F	1795	mechanisch	0-N894	TB [TE]	
1.8 T 16V	01/03-07/05	18 K4G	1795		0-N894	TB [TE]	
160, 180, 190	10/01-07/05	25 K4F	2497		0-N1248	TB [DG]	
160, 180, 190	10/01-07/05	25 K4F	2497		0-N1261	TB [TE]	
1.8 T 16V	01/03-07/05	18 K4G	1795		0-N1584	VB [TE]	
160, 180, 190	10/01-07/05	25 K4F	2497	⚡	0-N1735	VB [DG]	
160, 180, 190	10/01-07/05	25 K4F	2497		0-N1742	VB [BT]	S
2.0 CDTi	06/02-07/05	204D2	1951	⚡	0-N1514	VB [BT]	S
MGF (RD)							
1.8 i VVC	10/01-03/02	18 K4K	1796	26x143	SK-1706	BTK	
1.8 i VVC, 1.8 i VVC	03/95-03/02	18 K4K	1796	26x143	SK-1507	BTK	
1.8 i VVC, 1.8 i VVC	03/95-03/02	18 K4K	1796	26x143	SK-1507AQ1	BTKW	
1.8 i VVC, 1.8 i VVC	03/95-03/02	18 K4K	1796	26x143	SK-1706AQ1	BTKW	
1.6	02/00-03/02	16 K4F	1588	23x143; mit Zubehör	SK-1067	BTK	
1.6	02/00-03/02	16 K4F	1588	26x145; 09/2000 →	SK-1504	BTK	
1.8 i 16V	03/95-03/02	18 K4F	1796	23x143; → 08/1998; mit Zubehör; Spannrollenbetätigung: manuell	SK-1067	BTK	
1.8 i 16V	03/95-03/02	18 K4F	1796	26x145; 09/1998 →	SK-1504	BTK	
1.8 i VVC	03/95-03/02	18 K4K	1796	26x143; 04/1995 → 09/2000	SK-1706	BTK	
1.8 i VVC, 1.8 i 16V, 1.8 i VVC	03/95-03/02	18 K4F, 18 K4K	1796		0-N894	TB [TE]	
1.6	02/00-03/02	16 K4F	1588		0-N1272	TB [TE]	
1.6	02/00-03/02	16 K4F	1588		0-N894	TB [TE]	
1.8 i 16V	03/95-03/02	18 K4F	1796		0-N1272	TB [TE]	
1.8 i VVC, 1.8 i 16V, 1.8 i VVC	03/95-03/02	18 K4F, 18 K4K	1796		0-N1584	VB [TE]	
1.6	02/00-03/02	16 K4F	1588		0-N1584	VB [TE]	
MONTEGO							
2.0 EFI	04/84-09/90		1994	17x104	SK-1176	BTK	
2.0 Turbo	10/84-09/90	20 HT	1994	17x104; 01/1987 →	SK-1176	BTK	



CM³



Art. Nr.



MINI (R50, R53)								
1.4	04/03-09/06	W10 B14 A	1398				0-N1492	VB [BT] S
Cooper S	03/02-09/06	W11 B16 A	1598	für OE: 11 28 7 570 810			0-N2427	VB [TE] S
Cooper S, John Cooper Works, S Works, Works	03/02-09/06	W11 B16 A	1598				0-N1786	VB [DG]
Cooper S, John Cooper Works, S Works, Works	03/02-09/06	W11 B16 A	1598				0-N2124	VB [BT] S
Cooper, One	06/01-09/06	W10 B16 A	1598				0-N1492	VB [BT] S
John Cooper Works	03/06-09/06	W11 B16 A	1598				0-N2055	VB [BT] S
John Cooper Works	03/06-09/06	W11 B16 A	1598	für OE: 11 28 7 598 832, 11 28 7 598 833			0-N2237	VB [DG]
MINI Cabriolet (R52)								
Cooper S	07/04-11/07	W11 B16 A	1598	für OE: 11 28 7 570 810			0-N2427	VB [TE] S
Cooper S, John Cooper Works	07/04-11/07	W11 B16 A	1598				0-N1786	VB [DG]
Cooper S, John Cooper Works	07/04-11/07	W11 B16 A	1598				0-N2124	VB [BT] S
Cooper, One	07/04-11/07	W10 B16 A	1598				0-N1492	VB [BT] S
MINI (R56)								
Cooper D, One D	11/06-09/10	9HZ (DV6TED4), 9HZ (DV6TED4), W16 D16	1560	25x137			SK-1424	BTK
Cooper D, One D	11/06-09/10	9HZ (DV6TED4), 9HZ (DV6TED4), W16 D16	1560	25x137			SK-1424AQ1	BTKW
Cooper D, One D	11/06-09/10	9HZ (DV6TED4), 9HZ (DV6TED4), W16 D16	1560				0-N1062	TB [TE]
Cooper D, One D	11/06-09/10	9HZ (DV6TED4), 9HZ (DV6TED4), W16 D16	1560				0-N1066	TB [DG]
Cooper D, Cooper SD	02/11-11/13	N47 C20 A	1995				0-N2369	VB [DG]
Cooper D, Cooper SD	02/11-11/13	N47 C20 A	1995				0-N2387	VB [BT] S
Cooper D, One D	11/06-09/10	9HZ (DV6TED4), 9HZ (DV6TED4), W16 D16	1560				0-N1339	VB [BT] S
Cooper D, One D	06/10-11/13	N47 C16 A	1598				0-N2369	VB [DG]
Cooper D, One D	06/10-11/13	N47 C16 A	1598				0-N2387	VB [BT] S
Cooper S	10/06-01/11	N14 B16 A	1598				0-N2263	VB [BT]
Cooper, Cooper S, John Cooper Works, John Cooper Works GP, One	10/06-11/13	N12 B16 A, N12 B16 A, N16 B16 A, N14 B16 A, N14 B16 C, N16 B16 A, N18 B16 A, N18 B16 C	1598	für OE: 11 28 7 598 832, 11 28 7 598 833			0-N2237	VB [DG]
Cooper, Cooper S, John Cooper Works, One	10/06-11/13	N12 B16 A, N14 B16 A, N14 B16 C, N16 B16 A, N18 B16 A	1598				0-N2055	VB [BT] S
Cooper, Cooper S, One	10/06-11/13	N12 B16 A, N14 B16 A, N16 B16 A, N18 B16 A	1598	mit Elektronik			0-N2264	VB [BT]
One	11/06-03/10	N12 B14 A	1397				0-N2055	VB [BT] S
One	11/06-03/10	N12 B14 A	1397	für OE: 11 28 7 598 832, 11 28 7 598 833			0-N2237	VB [DG]
One	11/06-03/10	N12 B14 A	1397	mit Elektronik			0-N2264	VB [BT]
One	03/09-03/10	N12 B14 A	1397	☼			0-N2055	VB [BT] S
MINI Cabriolet (R57)								
Cooper D	06/10-	N47 C16 A	1598				0-N2369	VB [DG]
Cooper D	06/10-	N47 C16 A	1598				0-N2387	VB [BT] S
Cooper D, Cooper SD	02/11-	N47 C20 A	1995				0-N2369	VB [DG]
Cooper D, Cooper SD	02/11-	N47 C20 A	1995				0-N2387	VB [BT] S
Cooper, Cooper S, John Cooper Works, One	03/08-	N12 B16 A, N14 B16 A, N14 B16 C, N16 B16 A, N18 B16 A	1598				0-N2055	VB [BT] S
Cooper, Cooper S, John Cooper Works, One	03/08-	N12 B16 A, N14 B16 A, N14 B16 C, N16 B16 A, N18 B16 A	1598	für OE: 11 28 7 598 832, 11 28 7 598 833			0-N2237	VB [DG]
Cooper, Cooper S, One	03/09-	N12 B16 A, N14 B16 A, N16 B16 A, N18 B16 A	1598	mit Elektronik			0-N2264	VB [BT]
MINI CLUBMAN (R55)								
Cooper D	10/07-02/10	9HZ (DV6TED4)	1560	25x137			SK-1424	BTK
Cooper D	10/07-02/10	9HZ (DV6TED4)	1560	25x137			SK-1424AQ1	BTKW
Cooper D	10/07-02/10	9HZ (DV6TED4)	1560				0-N1062	TB [TE]
Cooper D	10/07-02/10	9HZ (DV6TED4)	1560				0-N1066	TB [DG]
Cooper D	10/07-02/10	9HZ (DV6TED4)	1560				0-N1339	VB [BT] S
Cooper D, Cooper SD	02/11-06/15	N47 C20 A	1995				0-N2369	VB [DG]
Cooper D, Cooper SD	02/11-06/15	N47 C20 A	1995				0-N2387	VB [BT] S
Cooper D, One D	03/10-06/15	N47 C16 A	1598				0-N2369	VB [DG]
Cooper D, One D	03/10-06/15	N47 C16 A	1598				0-N2387	VB [BT] S
Cooper S	10/07-02/10	N14 B16 A	1598				0-N2263	VB [BT]
Cooper, Cooper S, John Cooper Works, One	10/07-06/15	N12 B16 A, N16 B16 A, N14 B16 A, N14 B16 C, N16 B16 A, N18 B16 A	1598				0-N2055	VB [BT] S
Cooper, Cooper S, John Cooper Works, One	10/07-06/15	N12 B16 A, N16 B16 A, N14 B16 A, N14 B16 C, N16 B16 A, N18 B16 A	1598	für OE: 11 28 7 598 832, 11 28 7 598 833			0-N2237	VB [DG]
Cooper, Cooper S, One	10/07-06/15	N12 B16 A, N16 B16 A, N14 B16 A, N16 B16 A, N18 B16 A	1598	mit Elektronik			0-N2264	VB [BT]
One	03/09-02/10	N12 B14 A	1397				0-N2055	VB [BT] S
One	03/09-02/10	N12 B14 A	1397	für OE: 11 28 7 598 832, 11 28 7 598 833			0-N2237	VB [DG]

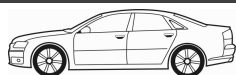

CM³



Art. Nr.



ohne Halter

MINI CLUBVAN (R55)							
Cooper D	12/12-	N47 C16 A	1598			0-N2369	VB [DG]
Cooper D	12/12-	N47 C16 A	1598			0-N2387	VB [BT] S
Cooper, One	12/12-	N16 B16 A	1598	für OE: 11 28 7 598 832, 11 28 7 598 833		0-N2237	VB [DG]
MINI COUNTRYMAN (R60)							
Cooper D, Cooper D ALL4, Cooper SD, Cooper SD ALL4	02/11-	N47 C20 A	1995			0-N2369	VB [DG]
Cooper D, Cooper D ALL4, Cooper SD, Cooper SD ALL4	02/11-	N47 C20 A	1995			0-N2387	VB [BT] S
Cooper D, Cooper D ALL4, One D	06/10-	N47 C16 A	1598			0-N2369	VB [DG]
Cooper D, Cooper D ALL4, One D	06/10-	N47 C16 A	1598			0-N2387	VB [BT] S
Cooper, Cooper S, Cooper S ALL4, Cooper S JCW, One	06/10-	N16 B16 A, N18 B16 A	1598	für OE: 11 28 7 598 832, 11 28 7 598 833		0-N2237	VB [DG]
Cooper, Cooper S, Cooper S ALL4, One	06/10-	N16 B16 A, N18 B16 A	1598			0-N2055	VB [BT] S
Cooper, Cooper S, Cooper S ALL4, One	06/10-	N16 B16 A, N18 B16 A	1598	mit Elektronik		0-N2264	VB [BT]
MINI Coupe (R58)							
Cooper SD	09/11-	N47 C20 A	1995			0-N2369	VB [DG]
Cooper SD	09/11-	N47 C20 A	1995			0-N2387	VB [BT] S
Cooper, Cooper S	09/11-	N16 B16 A, N18 B16 A	1598	für OE: 11 28 7 598 832, 11 28 7 598 833		0-N2237	VB [DG]
Cooper, Cooper S, John Cooper Works	09/11-	N14 B16 C, N16 B16 A, N18 B16 A	1598			0-N2055	VB [BT] S
MINI PACEMAN (R61)							
Cooper D AWD, Cooper SD, Cooper SD ALL4	09/12-	N47 C20 A	1995			0-N2369	VB [DG]
Cooper D AWD, Cooper SD, Cooper SD ALL4	09/12-	N47 C20 A	1995			0-N2387	VB [BT] S
Cooper D, Cooper D ALL4	09/12-	N47 C16 A	1598			0-N2369	VB [DG]
Cooper D, Cooper D ALL4	09/12-	N47 C16 A	1598			0-N2387	VB [BT] S
Cooper S, Cooper S ALL4, John Cooper Works	04/12-	N18 B16 A, N18 B16 C	1598	für OE: 11 28 7 598 832, 11 28 7 598 833		0-N2237	VB [DG]
MINI Roadster (R59)							
Cooper SD	02/12-	N47 C20 A	1995			0-N2369	VB [DG]
Cooper SD	02/12-	N47 C20 A	1995			0-N2387	VB [BT] S
Cooper, Cooper S, John Cooper Works	02/12-	N14 B16 C, N18 B16 C, N16 B16 A, N18 B16 A	1598	für OE: 11 28 7 598 832, 11 28 7 598 833		0-N2237	VB [DG]



OPTIMAL[®]

MITSUBISHI



CM³



Art. Nr.



380 (DB)								
3.8 i	04/05-04/08	6G75	3828			0-N185	TB [TE]	
3000 GT Coupe (Z16A)								
3.0 i 24V 4x4	06/92-08/99	6G72 (DOHC 24V)	2972			0-N185	TB [TE]	
3.0 i 24V 4x4	06/92-08/99	6G72 (DOHC 24V)	2972			0-N189	TB [DG]	
3.0 i 24V 4x4	06/92-08/99	6G72 (DOHC 24V)	2972			0-N2163	TB [BT]	
ASX (GA_W_)								
1.8, 1.8 4WD	02/10-	4B10	1798			0-N2048	VB [DG]	
1.8, 1.8 4WD	02/10-	4B10	1798			0-N2112	VB [BT]	S
1.8, 1.8 4WD	02/10-	4B10	1798			0-N2294	VB [DG]	
1.8, 1.8 4WD	02/10-	4B10	1798			0-N2354	VB [DG]	
2.0 i, 2.0 i 4WD	06/10-	4B11	1998			0-N2048	VB [DG]	
2.0 i, 2.0 i 4WD	06/10-	4B11	1998			0-N2112	VB [BT]	S
2.0 i, 2.0 i 4WD	06/10-	4B11	1998			0-N2294	VB [DG]	
2.0 i, 2.0 i 4WD	06/10-	4B11	1998			0-N2354	VB [DG]	
CANTER Pritsche/Fahrgestell (FB4_, FE4_)								
2.5 D	09/92-09/96	4D56 (8V)	2477			0-N061	TB [TE]	
2.5 D	09/92-09/96	4D56 (8V)	2477			0-N184	TB [TE]	
CARISMA (DA_)								
1.6	07/95-06/06	4G92 (SOHC 16V)	1597	29x111		SK-1316	BTK	
1.6	07/95-06/06	4G92 (SOHC 16V)	1597	29x111		SK-1316AQ1	BTKW	
1.8	07/95-07/97	4G93 (SOHC 16V)	1834	29x154; Nockenwelle: DOHC		SK-1325	BTK	
1.8	07/95-07/97	4G93 (SOHC 16V)	1834	29x154; Nockenwelle: DOHC; → 02/1999		SK-1325AQ1	BTKW	
1.8	07/95-07/97	4G93 (SOHC 16V)	1834	29x116; Nockenwelle: SOHC/OHC		SK-1458	BTK	
1.8	07/95-07/97	4G93 (SOHC 16V)	1834	29x116; Nockenwelle: SOHC/OHC		SK-1458AQ1	BTKW	
1.8 16V , 1.8 16V GDI	07/95-06/06	4G93 (DOHC 16V), 4G93 (DOHC 16V), 4G93 (GDI)	1834	29x154; → 02/1999		SK-1325AQ1	BTKW	
1.8 16V , 1.8 16V GDI , 1.8 GDI	07/95-06/06	4G93 (DOHC 16V), 4G93 (DOHC 16V), 4G93 (GDI)	1834	29x154		SK-1325	BTK	
1.8 16V GDI	09/97-06/06	4G93 (GDI)	1834	29x154; 02/1999 →		SK-1325AQ2	BTKW	
1.8 GDI	10/00-06/06	4G93 (GDI)	1834	29x154		SK-1325AQ2	BTKW	
1.9 DI-D	09/00-06/06	F9Q1, F9Q2	1870	26x132		SK-1493	BTK	
1.9 DI-D	09/00-06/06	F9Q1, F9Q2	1870	26x132		SK-1493AQ1	BTKW	
1.9 DI-D	09/00-06/06	F9Q1, F9Q2	1870	26x132		SK-1493AQ2	BTKW	
1.9 TD	10/96-09/00	F8QT	1870	25.4x153; → 08/2000; :C003535→; mit Zahnrad		SK-1707	BTK	
1.6	07/95-06/06	4G92 (SOHC 16V)	1597			0-N182	TB [TE]	
1.8 , 1.8 16V , 1.8 16V GDI , 1.8 GDI	07/95-06/06	4G93 (DOHC 16V), 4G93 (DOHC 16V), 4G93 (GDI), 4G93 (SOHC 16V)	1834			0-N056	TB [TE]	
1.8 16V , 1.8 16V GDI , 1.8 GDI	07/95-06/06	4G93 (DOHC 16V), 4G93 (DOHC 16V), 4G93 (GDI)	1834			0-N055	TB [DG]	
1.9 DI-D	09/00-06/06	F9Q1, F9Q2	1870	mit Grundträger		0-N1173	TB [BT]	
1.9 TD	10/96-09/00	F8QT	1870			0-N147	TB [DG]	
1.9 TD	10/96-09/00	F8QT	1870			0-N173	TB [TE]	
1.9 TD	10/96-09/00	F8QT	1870			0-N854	TB [DG]	
1.6	07/95-06/06	4G92 (SOHC 16V)	1597	10/1996 → 12/2003; für Fahrzeuge mit Servolenkung,		0-N2036	VB [TE]	
1.6	05/97-06/06	4G92 (SOHC 16V)	1597	→ 12/2003; für Fahrzeuge mit Servolenkung,		0-N2036	VB [TE]	
1.8 , 1.8 16V	07/95-07/97	4G93 (DOHC 16V), 4G93 (DOHC 16V), 4G93 (SOHC 16V)	1834	Nockenwelle: DOHC; 05/1997 → 12/2002; für Fahrzeuge mit Servolenkung,		0-N2036	VB [TE]	
1.8 , 1.8 16V	07/95-07/97	4G93 (DOHC 16V), 4G93 (DOHC 16V), 4G93 (SOHC 16V)	1834	Nockenwelle: SOHC/OHC; 10/1996 → 02/1999; für Fahrzeuge mit Servolenkung,		0-N2036	VB [TE]	
1.8 16V , 1.8 16V GDI	07/95-06/06	4G93 (DOHC 16V), 4G93 (DOHC 16V), 4G93 (GDI)	1834	→ 02/1999		0-N1521	VB [DG]	
1.8 16V GDI	09/97-06/06	4G93 (GDI)	1834	Nockenwelle: SOHC/OHC; → 02/1999; für Fahrzeuge mit Servolenkung,		0-N2036	VB [TE]	
1.8 16V GDI , 1.8 GDI	09/97-06/06	4G93 (GDI)	1834	Nockenwelle: DOHC; → 12/2002; für Fahrzeuge mit Servolenkung,		0-N2036	VB [TE]	
1.9 DI-D	09/00-06/06	F9Q1, F9Q2	1870			0-N1307	VB [DG]	
1.9 DI-D	09/00-06/06	F9Q1, F9Q2	1870			0-N1611	VB [BT]	S
1.9 DI-D	09/00-06/06	F9Q1, F9Q2	1870			0-N1802	VB [BT]	S
1.9 TD	10/96-09/00	F8QT	1870			0-N1470	VB [BT]	S
1.9 TD	10/96-09/00	F8QT	1870			0-N1729	VB [DG]	
CARISMA Stufenheck (DA_)								
1.3	09/00-10/04	4G13 (12V)	1298	25x109		SK-1470	BTK	
1.6	09/96-06/06	4G92 (SOHC 16V)	1597	29x111		SK-1316	BTK	



CM³



Art. Nr.



CARISMA Stufenheck (DA_)

1.6	09/96-06/06	4G92 (SOHC 16V)	1597	29x111	SK-1316AQ1	BTKW	
1.8	09/96-09/97	4G93 (SOHC 16V)	1834	29x154; Nockenwelle: DOHC	SK-1325	BTK	
1.8	09/96-09/97	4G93 (SOHC 16V)	1834	29x154; Nockenwelle: DOHC; → 02/1999	SK-1325AQ1	BTKW	
1.8	09/96-09/97	4G93 (SOHC 16V)	1834	29x116; Nockenwelle: SOHC/OHC	SK-1458	BTK	
1.8	09/96-09/97	4G93 (SOHC 16V)	1834	29x116; Nockenwelle: SOHC/OHC	SK-1458AQ1	BTKW	
1.8 16V GDI	09/97-06/06	4G93 (GDI)	1834	29x154; → 02/1999	SK-1325AQ1	BTKW	
1.8 16V GDI	09/97-06/06	4G93 (GDI)	1834	29x154; 02/1999 →	SK-1325AQ2	BTKW	
1.8 16V GDI, 1.8 GDI	09/97-06/06	4G93 (GDI)	1834	29x154	SK-1325	BTK	
1.8 GDI	10/00-06/06	4G93 (GDI)	1834	29x154	SK-1325AQ2	BTKW	
1.9 DI-D	09/00-06/06	F9Q1, F9Q2	1870	26x132	SK-1493	BTK	
1.9 DI-D	09/00-06/06	F9Q1, F9Q2	1870	26x132	SK-1493AQ1	BTKW	
1.9 DI-D	09/00-06/06	F9Q1, F9Q2	1870	26x132	SK-1493AQ2	BTKW	
1.9 TD	10/96-09/00	F8QT	1870	25.4x153; → 08/2000; :C003535→; mit Zahnrad	SK-1707	BTK	
1.3	09/00-10/04	4G13 (12V)	1298		0-N1129	TB [TE]	
1.6	09/96-06/06	4G92 (SOHC 16V)	1597		0-N182	TB [TE]	
1.8, 1.8 16V GDI, 1.8 GDI	09/96-06/06	4G93 (GDI), 4G93 (SOHC 16V)	1834		0-N056	TB [TE]	
1.8 16V GDI, 1.8 GDI	09/97-06/06	4G93 (GDI)	1834		0-N055	TB [DG]	
1.9 DI-D	09/00-06/06	F9Q1, F9Q2	1870	mit Grundträger	0-N1173	TB [BT]	
1.9 TD	10/96-09/00	F8QT	1870		0-N147	TB [DG]	
1.9 TD	10/96-09/00	F8QT	1870		0-N173	TB [TE]	
1.9 TD	10/96-09/00	F8QT	1870		0-N854	TB [DG]	
2.0 16V GT EVO VI/VII	11/99-06/06	4G63 Turbo	1997		0-N055	TB [DG]	
2.0 16V GT EVO VI/VII	11/99-06/06	4G63 Turbo	1997		0-N060	TB [TE]	
1.6	09/96-06/06	4G92 (SOHC 16V)	1597	10/1996 → 12/2003; für Fahrzeuge mit Servolenkung,	0-N2036	VB [TE]	
1.6	05/97-06/06	4G92 (SOHC 16V)	1597	→ 12/2003; für Fahrzeuge mit Servolenkung,	0-N2036	VB [TE]	
1.8, 1.8 16V GDI	09/96-06/06	4G93 (GDI), 4G93 (SOHC 16V)	1834	Nockenwelle: SOHC/OHC; → 02/1999; für Fahrzeuge mit Servolenkung,	0-N2036	VB [TE]	
1.8, 1.8 16V GDI, 1.8 GDI	09/96-06/06	4G93 (GDI), 4G93 (SOHC 16V)	1834	Nockenwelle: DOHC; → 12/2002; für Fahrzeuge mit Servolenkung,	0-N2036	VB [TE]	
1.8 16V GDI	09/97-06/06	4G93 (GDI)	1834	→ 02/1999	0-N1521	VB [DG]	
1.9 DI-D	09/00-06/06	F9Q1, F9Q2	1870		0-N1307	VB [DG]	
1.9 DI-D	09/00-06/06	F9Q1, F9Q2	1870		0-N1611	VB [BT]	S
1.9 DI-D	09/00-06/06	F9Q1, F9Q2	1870		0-N1802	VB [BT]	S
1.9 TD	10/96-09/00	F8QT	1870		0-N1470	VB [BT]	S
1.9 TD	10/96-09/00	F8QT	1870		0-N1729	VB [DG]	
2.0 16V GT EVO VI/VII	11/99-06/06	4G63 Turbo	1997		0-N1521	VB [DG]	
2.0 16V GT EVO VI/VII	11/99-06/06	4G63 Turbo	1997		0-N2259	VB [BT]	

CELESTE (A7_)

1.6 ST	01/77-06/81	4G32	1597		0-N051	TB [TE]	
1.6 ST	01/77-06/81	4G32	1597		0-N183	TB [TE]	

COLT I (A15_A)

1.2 GL	12/78-01/84	4G11	1244		0-N986	TB [TE]	
1.4 GLX,GT, 1.4 Turbo	05/79-01/84	4G12, 4G12 T	1410		0-N986	TB [TE]	

COLT II (C1_A)

1.2 EL, GL	02/84-09/86	4G16	1198	19.05x92; 05/1984 →	SK-1317	BTK	
1.2 EL, GL	09/86-04/88	4G16	1198	19x92; 06/1987 →	SK-1242	BTK	
1.2 EL, GL	09/86-04/88	4G16	1198	19.05x92; → 05/1987	SK-1317	BTK	
1.3 EL, GL	06/86-04/88	G13B	1299	19x92	SK-1242	BTK	
1.5 GLX	09/84-04/88	4G15, G15B	1468	19x92; 06/1987 →	SK-1242	BTK	
1.5 GLX	09/84-04/88	4G15, G15B	1468	19.05x92; → 05/1987	SK-1317	BTK	
1.6 Turbo ECi	02/84-04/88	4G32 T/C	1597	19.05x120; 05/1984 →	SK-1321	BTK	
1.6 Turbo ECi	07/86-04/88	G32BT	1597	19.05x120	SK-1321	BTK	
1.2 EL, GL	02/84-04/88	4G16	1198		0-N986	TB [TE]	
1.5 GLX	09/84-04/88	4G15, G15B	1468		0-N986	TB [TE]	
1.6 Turbo ECi	02/84-04/88	4G32 T/C, G32BT	1597	→ 06/1987	0-N051	TB [TE]	
1.6 Turbo ECi	02/84-04/88	4G32 T/C, G32BT	1597	07/1987 →	0-N053	TB [TE]	
1.6 Turbo ECi	02/84-04/88	4G32 T/C, G32BT	1597		0-N188	TB [TE]	
1.8 GL Diesel	02/84-04/88	4D65	1796		0-N058	TB [DG]	
1.8 GL Diesel	02/84-04/88	4D65	1796		0-N183	TB [TE]	

COLT III (C5_A)

1.3, 1.3 12V, 1.3 GL	04/88-05/92	4G13 (12V), 4G13 (8V)	1299	19x92; → 05/1990	SK-1242	BTK	
1.3 12V	04/88-05/92	4G13 (12V)	1299	22x92	SK-1234	BTK	

CM³

Art. Nr.



ohne Halter

COLT III (C5_A)

1.3 GL	04/88-12/90	4G13 (8V)	1299	22x92; 06/1990 →	SK-1234	BTK	
1.5, 1.5 GLXi	04/88-05/92	4G15, 4G15 (12V)	1468	22x92	SK-1234	BTK	
1.5 GLXi	04/88-05/92	4G15	1468	19x92; → 05/1990	SK-1242	BTK	
1.8 GTi 16V	06/90-05/92	4G67	1836	29x153; 12.7x65	SK-1555	BTK	
1.8 GTi 16V	06/90-05/92	4G67	1836	12.7x65	SK-1649	BTK	
1.3, 1.3 12V	04/88-05/92	4G13 (12V), 4G13 (8V)	1299	→ 05/1990	0-N986	TB [TE]	
1.3, 1.3 12V	04/88-05/92	4G13 (12V), 4G13 (8V)	1299	06/1990 →	0-N987	TB [TE]	
1.3 GL	04/88-12/90	4G13 (8V)	1299		0-N986	TB [TE]	
1.5	07/90-05/92	4G15 (12V)	1468		0-N987	TB [TE]	
1.5 GLXi	04/88-05/92	4G15	1468	→ 05/1990	0-N986	TB [TE]	
1.5 GLXi	04/88-05/92	4G15	1468	06/1990 →	0-N987	TB [TE]	
1.6 GTi 16V	04/88-05/90	4G61	1596		0-N054	TB [TE]	
1.6 GTi 16V	04/88-05/90	4G61	1596		0-N055	TB [DG]	
1.6 GTi 16V	04/88-05/90	4G61	1596		0-N1971	TB [BT]	
1.8 Diesel GLX	04/88-05/92	4D65	1796		0-N058	TB [DG]	
1.8 Diesel GLX	04/88-05/92	4D65	1796		0-N183	TB [TE]	
1.8 GTi 16V	06/90-05/92	4G67	1836		0-N054	TB [TE]	
1.8 GTi 16V	06/90-05/92	4G67	1836		0-N055	TB [DG]	
1.8 GTi 16V	06/90-05/92	4G67	1836		0-N179	TB [TE]	
1.8 GTi 16V	06/90-05/92	4G67	1836		0-N1971	TB [BT]	

COLT IV (CA_A)

1.3 GLi 12V	04/92-04/96	4G13 (12V)	1299	22x92	SK-1234	BTK	
1.6, 1.6 4x4, 1.6 GLXi 16V	04/92-04/96	4G92 (SOHC 16V)	1597	29x117	SK-1314	BTK	
1.3 GLi 12V	04/92-04/96	4G13 (12V)	1299		0-N987	TB [TE]	
1.6, 1.6 4x4, 1.6 GLXi 16V	04/92-04/96	4G92 (SOHC 16V)	1597		0-N052	TB [TE]	
1.8 GTi 16V	04/92-04/96	4G93 (DOHC 16V), 4G93 (SOHC 16V)	1834		0-N055	TB [DG]	
1.8 GTi 16V	04/92-04/96	4G93 (DOHC 16V), 4G93 (SOHC 16V)	1834		0-N056	TB [TE]	

COLT V (CJ_, CP_)

1300	06/00-09/03	4G13 (16V)	1299	25x109	SK-1470	BTK	
1300	06/00-09/03	4G13 (16V)	1299	25.4x107; Baumuster: Mirage	SK-1753	BTK	
1300 GL, GLX	05/96-06/00	4G13 (12V)	1299	25.4x107; → 11/1998	SK-1460	BTK	
1300 GL, GLX	05/96-06/00	4G13 (12V)	1299	25x109; 06/2000 →	SK-1470	BTK	
1300 GL, GLX	05/96-06/00	4G13 (12V)	1299	25.4x107; 12/1998 → 05/2000	SK-1753	BTK	
1300 GL, GLX	05/96-06/00	4G13 (12V)	1299	25.4x107; 12/1998 →; Baumuster: Mirage	SK-1753	BTK	
1500	10/99-09/03	4G15 (16V)	1468	25.4x107; 12/1998 →	SK-1753	BTK	
1600, 1600 GLX	05/96-09/03	4G92 (SOHC 16V)	1597	29x111	SK-1316	BTK	
1600, 1600 GLX	05/96-09/03	4G92 (SOHC 16V)	1597	29x111	SK-1316AQ2	BTKW	
1.3	08/02-09/03	4G19	1343		0-N1129	TB [TE]	
1.3	08/02-09/03	4G19	1343	06/2003 →	0-N1762	TB [BT]	
1.3	08/02-09/03	4G19	1343	06/2003 →	0-N1763	TB [DG]	
1.5, 1500	09/95-09/03	4G15 (16V)	1468		0-N1129	TB [TE]	
1.5, 1500	09/95-09/03	4G15 (16V)	1468	06/2003 →	0-N1762	TB [BT]	
1.5, 1500	09/95-09/03	4G15 (16V)	1468	06/2003 →	0-N1763	TB [DG]	
1.8	11/97-07/01	4G93 (SOHC 16V)	1834		0-N055	TB [DG]	
1.8	11/97-07/01	4G93 (SOHC 16V)	1834		0-N056	TB [TE]	
1300	06/00-09/03	4G13 (16V)	1299	06/2003 →	0-N1762	TB [BT]	
1300	06/00-09/03	4G13 (16V)	1299	06/2003 →	0-N1763	TB [DG]	
1300 GL, GLX	05/96-06/00	4G13 (12V)	1299	→ 11/1998	0-N181	TB [TE]	
1300, 1300 GL, GLX	05/96-09/03	4G13 (12V), 4G13 (16V)	1299		0-N1129	TB [TE]	
1600, 1600 GLX	05/96-09/03	4G92 (SOHC 16V)	1597		0-N182	TB [TE]	
1600, 1600 GLX	05/96-09/03	4G92 (SOHC 16V)	1597	✳	0-N1521	VB [DG]	

COLT VI (Z3_A, Z2_A)

1.3	06/04-06/12	4A90	1332		0-N1762	TB [BT]	
1.3	06/04-06/12	4A90	1332		0-N1763	TB [DG]	
1.5	06/04-06/12	4A91	1499		0-N1762	TB [BT]	
1.5	06/04-06/12	4A91	1499		0-N1763	TB [DG]	
1.5 CZT	03/05-06/12	4G15T	1468		0-N1762	TB [BT]	
1.5 CZT	03/05-06/12	4G15T	1468		0-N1763	TB [DG]	
1.5 DI-D	08/04-06/12	OM 639.939	1493		0-N2402	VB [BT]	S
1.5 DI-D	08/04-06/12	OM 639.939	1493		0-N2419	VB [DG]	

COLT LANCER (A7_)

1.6	01/78-09/79	4G32 GS	1597		0-N051	TB [TE]	
1.6	01/78-09/79	4G32 GS	1597		0-N188	TB [TE]	



CM³



Art. Nr.



CORDIA (A21_A, AB)							
1.6 GSL , 1.6 Turbo	10/82-12/86	4G32, 4G32 T	1597	19.05x120; → 06/1983	SK-1321	BTK	
1.8 Turbo ECi	10/84-12/86	4G62 T	1795	19x122	SK-1240S	BTK	
1.6 GSL , 1.6 Turbo	10/82-12/86	4G32, 4G32 T	1597		0-N051	TB [TE]	
1.6 GSL , 1.6 Turbo	10/82-12/86	4G32, 4G32 T	1597		0-N188	TB [TE]	
1.8 GSL	10/86-12/86	4G37	1755		0-N051	TB [TE]	
1.8 GSL	10/86-12/86	4G37	1755		0-N188	TB [TE]	
1.8 Turbo ECi	10/84-12/86	4G62 T	1795		0-N059	TB [TE]	
1.8 Turbo ECi	10/84-12/86	4G62 T	1795		0-N183	TB [TE]	
DEBONAIR (S1_A)							
3.0	09/89-08/92	6G72 (DOHC 24V)	2972		0-N189	TB [DG]	
3.0	07/86-08/92	6G72 (DOHC 24V), 6G72 (SOHC 12V)	2972		0-N1521	VB [DG]	
DEBONAIR (S2_A)							
3.0	09/92-10/97	6G72 (SOHC 12V)	2972		0-N1521	VB [DG]	
DELICA D5 (CV_W)							
2.0	06/07-	4B11, 4J11	1998		0-N2048	VB [DG]	
2.0	06/07-	4B11, 4J11	1998		0-N2112	VB [BT]	S
2.4 4WD	06/07-	4B12	2359		0-N2048	VB [DG]	
2.4 4WD	06/07-	4B12	2359		0-N2112	VB [BT]	S
DIAMANTE Stufenheck (F2_A, F1_A)							
3.0	10/92-07/96	6G72 (DOHC 24V)	2972		0-N185	TB [TE]	
3.0	10/92-07/96	6G72 (DOHC 24V)	2972		0-N189	TB [DG]	
3.5	10/95-07/96	6G74 (SOHC 24V)	3497		0-N185	TB [TE]	
3.0	10/92-07/96	6G72 (DOHC 24V)	2972		0-N1521	VB [DG]	
DIAMANTE Station Wagon (F_W)							
3.0	06/92-03/98	6G72 (SOHC 24V)	2972		0-N185	TB [TE]	
3.0	06/92-03/98	6G72 (SOHC 24V)	2972		0-N189	TB [DG]	
3.5, 3.5 4x4	06/92-03/98	6G74 (SOHC 24V)	3497		0-N185	TB [TE]	
3.0	06/92-03/98	6G72 (SOHC 24V)	2972		0-N1521	VB [DG]	
DIAMANTE Stufenheck (F4_A, F3_A)							
2.5	09/03-11/05	6A13	2498		0-N191	TB [TE]	
2.5	09/03-11/05	6A13	2498		0-N192	TB [DG]	
2.5	09/03-11/05	6A13	2498		0-N2162	TB [BT]	
3.0, 3.0 4x4	06/99-08/04	6G72 (DOHC 24V)	2972		0-N185	TB [TE]	
3.0, 3.0 4x4	06/99-08/04	6G72 (DOHC 24V)	2972		0-N189	TB [DG]	
3.5, 3.5 4x4	06/99-11/05	6G74 (SOHC 24V)	3497		0-N185	TB [TE]	
3.0, 3.0 4x4	06/99-08/04	6G72 (DOHC 24V)	2972		0-N1521	VB [DG]	
DION Großraumlimousine (CR_W)							
2.0 16V, 2.0 16V 4WD	12/99-10/05	4G94 (GDI)	1999		0-N2105	VB [BT]	S
ECLIPSE Cabriolet							
1.8	04/94-04/99	4G93 (SOHC 16V)	1834		0-N056	TB [TE]	
ECLIPSE Cabriolet (D5_A)							
1.8	05/99-03/05	4G93 (SOHC 16V)	1834		0-N056	TB [TE]	
3.0	05/99-03/05	6G72 (DOHC 24V)	2972		0-N185	TB [TE]	
3.0	05/99-03/05	6G72 (DOHC 24V)	2972		0-N189	TB [DG]	
3.0	05/99-03/05	6G72 (DOHC 24V)	2972		0-N1521	VB [DG]	
ECLIPSE I (D2_A)							
1.8	12/89-03/94	4G37	1755	19x122	SK-1309S	BTK	
2.0 i 16V , 2.0 i 16V 4x4	04/91-11/95	4G63 (DOHC 16V)	1997	12.7x65; → 08/1994	SK-1649	BTK	
2.0 i 16V , 2.0 Turbo	12/89-11/95	4G63 (DOHC 16V), 4G63 T (DOHC 16V)	1997	29x153; 12.7x65	SK-1555	BTK	
2.0 i 16V 4x4	04/91-11/95	4G63 (DOHC 16V)	1997	29x153; 12.7x65; → 08/1994	SK-1555	BTK	
2.0 Turbo	12/89-03/94	4G63 T (DOHC 16V)	1997	12.7x65	SK-1649	BTK	
2.0 i 16V , 2.0 i 16V 4x4	04/91-11/95	4G63 (DOHC 16V)	1997		0-N054	TB [TE]	
2.0 i 16V , 2.0 i 16V 4x4	04/91-11/95	4G63 (DOHC 16V)	1997		0-N055	TB [DG]	
2.0 i 16V , 2.0 i 16V 4x4	04/91-11/95	4G63 (DOHC 16V)	1997		0-N179	TB [TE]	
2.0 i 16V , 2.0 i 16V 4x4 , 2.0 Turbo 4WD	12/89-11/95	4G63 (DOHC 16V), 4G63 T (DOHC 16V)	1997		0-N2415	TB [VD]	
ECLIPSE II (D3_A)							
2000 GS 16V , 2000 GT 16V	12/95-04/99	4G63 (DOHC 16V), 4G63 T (DOHC 16V)	1997		0-N055	TB [DG]	
2000 GS 16V , 2000 GT 16V	12/95-04/99	4G63 (DOHC 16V), 4G63 T (DOHC 16V)	1997		0-N060	TB [TE]	
ECLIPSE III (D5_A)							
3.0	05/99-03/05	6G72 (DOHC 24V)	2972		0-N185	TB [TE]	
3.0	05/99-03/05	6G72 (DOHC 24V)	2972		0-N189	TB [DG]	



OPTIMAL®

MITSUBISHI



CM³



Art. Nr.



ECLIPSE III (D5_A)										
3.0	05/99-03/05	6G72 (DOHC 24V)	2972					0-N1521	VB [DG]	
ECLIPSE IV (DK_A)										
2.4 GS	04/05-12/11	4G69	2378					0-N1771	TB [BT]	
2.4 GS	04/05-12/11	4G69	2378					0-N2010	TB [VD]	
2.4 GS	04/05-12/11	4G69	2378					0-N2255	TB [DG]	
3.8 GT	04/05-12/11	6G75	3828					0-N185	TB [TE]	
2.4 GS	04/05-12/11	4G69	2378					0-N1984	VB [DG]	
2.4 GS	04/05-12/11	4G69	2378					0-N2105	VB [BT]	S
ENDEAVOR (D8_W, D7_W)										
3.8 GDi 4x4	01/03-08/11	6G75	3828	32x201				SK-1735	BTK	
3.8 GDi 4x4	01/03-08/11	6G75	3828					0-N185	TB [TE]	
ENDEAVOR [USA] Sport Utility										
3.8, 3.8 4WD	01/04-12/04		3797					0-N185	TB [TE]	
FTO Coupe (DE_A)										
1.8	09/94-07/01	4G93 (SOHC 16V)	1834	29x154; Nockenwelle: DOHC				SK-1325	BTK	
1.8	09/94-07/01	4G93 (SOHC 16V)	1834	29x154; Nockenwelle: DOHC				SK-1325AQ1	BTKW	
1.8	09/94-07/01	4G93 (SOHC 16V)	1834	29x116; Nockenwelle: SOHC/OHC				SK-1458	BTK	
1.8	09/94-07/01	4G93 (SOHC 16V)	1834	29x116; Nockenwelle: SOHC/OHC				SK-1458AQ1	BTKW	
1.8	09/94-07/01	4G93 (SOHC 16V)	1834					0-N056	TB [TE]	
2.0	09/94-07/01	6A12 (DOHC), 6A12 (MIVEC)	1999					0-N191	TB [TE]	
2.0	09/94-07/01	6A12 (DOHC), 6A12 (MIVEC)	1999					0-N192	TB [DG]	
2.0	09/94-07/01	6A12 (DOHC), 6A12 (MIVEC)	1999					0-N2162	TB [BT]	
GALANT I (A12_)										
1.6	01/77-08/80	4G32	1597					0-N051	TB [TE]	
GALANT I Station Wagon (A12_V)										
1.6 GL	01/79-08/80	4G32	1597					0-N051	TB [TE]	
GALANT II (A16_)										
2.0 GLS	09/80-05/84	4G63 (SOHC 8V)	1997	19x122; 08/1981 → 09/1983				SK-1309S	BTK	
2.0 Turbo ECI	05/82-05/84	4G63 T (ECI)	1997	19x122				SK-1240S	BTK	
2.0 Turbo ECI	05/82-05/84	4G63 T (ECI)	1997	19x122; → 09/1983				SK-1309S	BTK	
1.6 GLX	09/80-05/84	4G32	1597					0-N051	TB [TE]	
1.6 GLX	09/80-05/84	4G32	1597					0-N188	TB [TE]	
2.0 GLS	09/80-05/84	4G63 (SOHC 8V)	1997					0-N062	TB [TE]	
2.0 GLS , 2.0 Turbo ECI	09/80-05/84	4G63 (SOHC 8V), 4G63 T (ECI)	1997					0-N183	TB [TE]	
2.0 Turbo ECI	05/82-05/84	4G63 T (ECI)	1997					0-N059	TB [TE]	
2.3 Turbo-D	09/80-05/84	4D55 T	2347					0-N061	TB [TE]	
2.3 Turbo-D	09/80-05/84	4D55 T	2347					0-N184	TB [TE]	
GALANT II Station Wagon (A16_V)										
2.0 GLX	09/80-06/83	4G63 (SOHC 8V)	1997	19x122; 08/1981 →				SK-1309S	BTK	
1.6 GLX	09/80-05/84	4G32	1597					0-N051	TB [TE]	
1.6 GLX	09/80-05/84	4G32	1597					0-N188	TB [TE]	
2.0 GLX	09/80-06/83	4G63 (SOHC 8V)	1997					0-N062	TB [TE]	
2.0 GLX	09/80-06/83	4G63 (SOHC 8V)	1997					0-N183	TB [TE]	
2.3 Turbo-D	07/83-05/84	4D55 T	2347					0-N061	TB [TE]	
2.3 Turbo-D	07/83-05/84	4D55 T	2347					0-N184	TB [TE]	
GALANT III (E1_A)										
1.6 GLX	06/84-04/90	4G32	1597	19x122; → 12/1987				SK-1309S	BTK	
2.0 GLS	06/84-04/90	4G63 (SOHC 8V), G63B	1997	12x55; 19x122; 05/1987 →				SK-1240	BTK	
2.0 GLS , 2.0 Turbo ECI	06/84-04/90	4G63 (SOHC 8V), 4G63 T (SOHC 8V), G63B	1997	19x122				SK-1240S	BTK	
2.4 GLS	06/85-04/90	4G64 (8V), G64B	2351	12x55; 19x123; 05/1987 →				SK-1237	BTK	
2.4 GLS	07/85-04/90	G64B	2351	19x123				SK-1237S	BTK	
1.6 GLX	06/84-04/90	4G32	1597	→ 12/1986				0-N051	TB [TE]	
1.6 GLX	06/84-04/90	4G32	1597	01/1987 →				0-N053	TB [TE]	
1.6 GLX	06/84-04/90	4G32	1597					0-N188	TB [TE]	
1.8 Turbo-D	06/84-04/90	4D65 T	1795					0-N058	TB [DG]	
1.8 Turbo-D	06/84-04/90	4D65 T	1795					0-N183	TB [TE]	
2.0 GLS , 2.0 Turbo ECI	06/84-04/90	4G63 (SOHC 8V), 4G63 T (SOHC 8V), G63B	1997					0-N059	TB [TE]	
2.0 GLS , 2.0 Turbo ECI	06/84-04/90	4G63 (SOHC 8V), 4G63 T (SOHC 8V), G63B	1997					0-N183	TB [TE]	
2.4 GLS	06/85-04/90	4G64 (8V), G64B	2351					0-N183	TB [TE]	
2.4 GLS	07/85-04/90	G64B	2351					0-N059	TB [TE]	

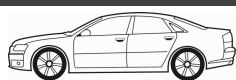

CM³



Art. Nr.



GALANT IV (E3_A)							
1.8	11/88-10/92	4G37	1755	19x122		SK-1309S	BTK
2.0 GTi 16V , 2.0 GTi 16V 4x4	11/88-12/92	4G63 (DOHC 16V)	1997	12.7x65		SK-1649	BTK
1.8	11/88-10/92	4G37	1755			0-N053	TB [TE]
1.8	11/88-10/92	4G37	1755			0-N188	TB [TE]
1.8 Turbo-D	11/88-10/92	4D65 T	1796			0-N058	TB [DG]
1.8 Turbo-D	11/88-10/92	4D65 T	1796			0-N183	TB [TE]
2.0 , 2.0 4x4	04/89-10/92	4G63 (SOHC 8V)	1997			0-N063	TB [TE]
2.0 , 2.0 4x4	04/89-10/92	4G63 (SOHC 8V)	1997	05/1992 →		0-N179	TB [TE]
2.0 , 2.0 4x4	04/89-12/92	4G63 (SOHC 8V)	1997	→ 04/1992		0-N183	TB [TE]
2.0 GTi 16V , 2.0 GTi 16V 4x4	11/88-12/92	4G63 (DOHC 16V)	1997			0-N054	TB [TE]
2.0 GTi 16V , 2.0 GTi 16V 4x4	11/88-12/92	4G63 (DOHC 16V)	1997			0-N055	TB [DG]
2.0 GTi 16V , 2.0 GTi 16V 4x4	11/88-12/92	4G63 (DOHC 16V)	1997			0-N179	TB [TE]
2.0 GTi 16V , 2.0 GTi 16V 4x4	11/88-12/92	4G63 (DOHC 16V)	1997	→ 04/1992		0-N1971	TB [BT]
2.0 GTi 16V , 2.0 GTi 16V 4x4	11/88-12/92	4G63 (DOHC 16V)	1997	05/1992 →		0-N2415	TB [VD]

GALANT IV Stufenheck (E3_A)							
1.6	01/88-10/92	4G32	1597	19.05x120		SK-1321	BTK
1.8	11/87-10/92	4G37	1755	19x122		SK-1309S	BTK
2.0 GTi 16V , 2.0 GTi 16V 4x4	11/87-10/92	4G63 (DOHC 16V)	1997	12.7x65		SK-1649	BTK
1.8	11/87-10/92	4G37	1755			0-N053	TB [TE]
1.8	11/87-10/92	4G37	1755			0-N188	TB [TE]
1.8 Turbo-D	12/87-10/92	4D65 T	1796			0-N058	TB [DG]
1.8 Turbo-D	12/87-10/92	4D65 T	1796			0-N183	TB [TE]
2.0	11/87-10/92	4G63 (SOHC 8V)	1997			0-N1127	TB [TE]
2.0 , 2.0 4x4	11/87-10/92	4G63 (SOHC 8V)	1997			0-N063	TB [TE]
2.0 , 2.0 4x4	11/87-10/92	4G63 (SOHC 8V)	1997			0-N183	TB [TE]
2.0 GTi 16V , 2.0 GTi 16V 4x4	11/87-10/92	4G63 (DOHC 16V)	1997			0-N054	TB [TE]
2.0 GTi 16V , 2.0 GTi 16V 4x4	11/87-10/92	4G63 (DOHC 16V)	1997			0-N055	TB [DG]
2.0 GTi 16V , 2.0 GTi 16V 4x4	11/87-10/92	4G63 (DOHC 16V)	1997			0-N179	TB [TE]
2.0 GTi 16V , 2.0 GTi 16V 4x4	11/87-10/92	4G63 (DOHC 16V)	1997			0-N2415	TB [VD]

GALANT V (E5_A, E7_A, E8_A)							
1.8 , 1.8 GLSi	11/92-08/96	4G93 (GDI), 4G93 (SOHC 16V), 4G93 (SOHC 16V)	1834	29x121		SK-1322	BTK
2.0 GLSi , 2.0 GLSi 4x4	11/92-08/96	4G63 (SOHC 16V)	1997	12.7x65; 29x123		SK-1323	BTK
2.0 GLSi , 2.0 GLSi 4x4	11/92-08/96	4G63 (SOHC 16V)	1997	12.7x65; → 07/1995		SK-1649	BTK
2.0 GLSTD	11/92-08/96	4D68 T	1998	12.7x65; 32x158		SK-1463	BTK
2.0 GLSTD	11/92-08/96	4D68 T	1998	12.7x65		SK-1649	BTK
1.8 , 1.8 GLSi	11/92-08/96	4G93 (GDI), 4G93 (SOHC 16V), 4G93 (SOHC 16V)	1834			0-N052	TB [TE]
2.0 , 2.0 GLSi , 2.0 GLSi 4x4	11/92-08/96	4G63 (SOHC 16V)	1997			0-N1127	TB [TE]
2.0 GLSi , 2.0 GLSi 4x4	11/92-08/96	4G63 (SOHC 16V)	1997			0-N055	TB [DG]
2.0 GLSi , 2.0 GLSi 4x4	11/92-08/96	4G63 (SOHC 16V)	1997			0-N060	TB [TE]
2.0 GLSi , 2.0 GLSi 4x4	11/92-08/96	4G63 (SOHC 16V)	1997			0-N179	TB [TE]
2.0 GLSTD	11/92-08/96	4D68 T	1998			0-N058	TB [DG]
2.0 GLSTD	11/92-08/96	4D68 T	1998			0-N065	TB [TE]
2.0 GLSTD	11/92-08/96	4D68 T	1998			0-N179	TB [TE]
2.0 V6-24	11/92-08/96	6A12	1999			0-N191	TB [TE]
2.0 V6-24	11/92-08/96	6A12	1999			0-N192	TB [DG]
2.0 V6-24	11/92-08/96	6A12	1999			0-N2162	TB [BT]
2.5 , 2.5 V6-24 4x4	11/92-09/96	6G73	2497			0-N185	TB [TE]
2.5 , 2.5 V6-24 4x4	11/92-09/96	6G73	2497			0-N189	TB [DG]
2.5 , 2.5 V6-24 4x4	11/92-09/96	6G73	2497			0-N2163	TB [BT]

GALANT V Stufenheck (E5_A, E7_A, E8_A)							
1.8 , 1.8 GLSi	11/92-08/96	4G93 (SOHC 16V), 4G93 (SOHC 16V), 4G93 (SOHC 16V)	1834	29x121		SK-1322	BTK
2.0 GLSi	11/92-08/96	4G63 (SOHC 16V)	1997	12.7x65; → 08/1995		SK-1649	BTK
2.0 GLSi , 2.0 GLSi 4x4	11/92-08/96	4G63 (SOHC 16V)	1997	12.7x65; 29x123		SK-1323	BTK
2.0 GLSi 4x4	11/92-08/96	4G63 (SOHC 16V)	1997	12.7x65; → 07/1995		SK-1649	BTK
2.0 GLSTD	11/92-08/96	4D68 T	1998	12.7x65; 32x158		SK-1463	BTK
2.0 GLSTD	11/92-08/96	4D68 T	1998	12.7x65		SK-1649	BTK
1.8 , 1.8 GLSi	11/92-08/96	4G93 (SOHC 16V), 4G93 (SOHC 16V), 4G93 (SOHC 16V)	1834			0-N052	TB [TE]
2.0 GLSi , 2.0 GLSi 4x4	11/92-08/96	4G63 (SOHC 16V)	1997			0-N055	TB [DG]
2.0 GLSi , 2.0 GLSi 4x4	11/92-08/96	4G63 (SOHC 16V)	1997			0-N060	TB [TE]
2.0 GLSi , 2.0 GLSi 4x4	11/92-08/96	4G63 (SOHC 16V)	1997			0-N1127	TB [TE]
2.0 GLSi , 2.0 GLSi 4x4	11/92-08/96	4G63 (SOHC 16V)	1997			0-N179	TB [TE]



OPTIMAL®

MITSUBISHI



CM³



Art. Nr.



ohne Halter

GALANT V Stufenheck (E5_A, E7_A, E8_A)

2.0 GLSTD	11/92-08/96	4D68 T	1998		0-N058	TB [DG]
2.0 GLSTD	11/92-08/96	4D68 T	1998		0-N065	TB [TE]
2.0 GLSTD	11/92-08/96	4D68 T	1998		0-N179	TB [TE]
2.0 V6-24	11/92-08/96	6A12	1999		0-N191	TB [TE]
2.0 V6-24	11/92-08/96	6A12	1999		0-N192	TB [DG]
2.0 V6-24	11/92-08/96	6A12	1999		0-N2162	TB [BT]
2.5 V6-24 4x4	11/92-08/96	6G73	2497		0-N185	TB [TE]
2.5 V6-24 4x4	11/92-08/96	6G73	2497		0-N189	TB [DG]
2.5 V6-24 4x4	11/92-08/96	6G73	2497		0-N2163	TB [BT]

GALANT VI (EA_)

2.0	09/96-09/00	4G63 (SOHC 16V)	1997	12.7x65; 29x122	SK-1469	BTK
2.0	09/00-10/04	4G63 (SOHC 16V)	1997	12.7x65; 29x122; 08/2001 →	SK-1469	BTK
2.5 Type S, 2.5 V6 24V	09/96-10/04	6A13	2498	30x177	SK-1670	BTK
2.5 V6 24V	09/00-10/04	6A13	2498	30x177; 08/2001 →	SK-1670	BTK
1.8 GDi	11/97-10/01	4G93 (GDI)	1834		0-N056	TB [TE]
2.0	09/96-10/04	4G63 (SOHC 16V)	1997		0-N055	TB [DG]
2.0	09/96-10/04	4G63 (SOHC 16V)	1997		0-N060	TB [TE]
2.0	09/96-10/04	4G63 (SOHC 16V)	1997		0-N1127	TB [TE]
2.0	09/00-10/04	4G63 (SOHC 16V)	1997		0-N1130	TB [DG]
2.0 TDI	09/96-10/04	4D68 (SOHC), 4D68 T	1998		0-N058	TB [DG]
2.0 TDI	09/96-10/04	4D68 (SOHC), 4D68 T	1998		0-N1127	TB [TE]
2.0 TDI	09/96-10/04	4D68 (SOHC), 4D68 T	1998		0-N1827	TB [BT]
2.4	10/03-10/04	4G69	2378		0-N1771	TB [BT]
2.4	10/03-10/04	4G69	2378		0-N2010	TB [VD]
2.4	10/03-10/04	4G69	2378		0-N2255	TB [DG]
2.4 GDI	02/99-10/04	4G64 (GDI)	2351		0-N055	TB [DG]
2.4 GDI	02/99-10/04	4G64 (GDI)	2351		0-N060	TB [TE]
2.4 GDI	02/99-10/04	4G64 (GDI)	2351		0-N1127	TB [TE]
2.5 Type S, 2.5 V6 24V	09/96-10/04	6A13, 6A13TT	2498		0-N191	TB [TE]
2.5 Type S, 2.5 V6 24V	09/96-10/04	6A13, 6A13TT	2498		0-N192	TB [DG]
2.5 Type S, 2.5 V6 24V	09/96-10/04	6A13, 6A13TT	2498		0-N2162	TB [BT]
1.8 GDi	11/97-10/01	4G93 (GDI)	1834		0-N1521	VB [DG]
2.0 GDI	10/99-10/04	4G94 (GDI)	1999		0-N2105	VB [BT] S
2.0 TDI	09/96-10/04	4D68 (SOHC), 4D68 T	1998		0-N1521	VB [DG]
2.4	10/03-10/04	4G69	2378		0-N2105	VB [BT] S
2.5 V6 24V	09/96-10/04	6A13	2498		0-N2305	VB [TE]
2.5 V6 24V	09/96-10/04	6A13	2498	✳	0-N2426	VB [TE]

GALANT VI Station Wagon (EA_)

2.0	09/96-09/00	4G63 (SOHC 16V)	1997	12.7x65; 29x122	SK-1469	BTK
2.0	09/00-10/03	4G63 (SOHC 16V)	1997	12.7x65; 29x122; 08/2001 →	SK-1469	BTK
2.5 V6 24V	09/96-09/00	6A13	2498	30x177	SK-1670	BTK
2.5 V6 24V	09/00-10/03	6A13	2498	30x177; 08/2001 →	SK-1670	BTK
2.0	09/96-10/03	4G63 (SOHC 16V)	1997		0-N055	TB [DG]
2.0	09/96-10/03	4G63 (SOHC 16V)	1997		0-N060	TB [TE]
2.0	09/96-10/03	4G63 (SOHC 16V)	1997		0-N1127	TB [TE]
2.0 TDI	09/96-10/03	4D68 (SOHC)	1998		0-N058	TB [DG]
2.0 TDI	09/96-10/03	4D68 (SOHC)	1998		0-N065	TB [TE]
2.0 TDI	09/96-10/03	4D68 (SOHC)	1998		0-N1127	TB [TE]
2.0 TDI	09/96-10/03	4D68 (SOHC)	1998		0-N179	TB [TE]
2.0 TDI	09/96-10/03	4D68 (SOHC)	1998		0-N1827	TB [BT]
2.4 GDI	02/99-10/03	4G64 (GDI)	2351		0-N055	TB [DG]
2.4 GDI	02/99-10/03	4G64 (GDI)	2351		0-N060	TB [TE]
2.4 GDI	02/99-10/03	4G64 (GDI)	2351		0-N1127	TB [TE]
2.5 V6 24V	09/96-10/03	6A13, 6A13TT	2498		0-N191	TB [TE]
2.5 V6 24V	09/96-10/03	6A13, 6A13TT	2498		0-N192	TB [DG]
2.5 V6 24V	09/96-10/03	6A13, 6A13TT	2498		0-N2162	TB [BT]
2.5 V6 24V	09/96-10/03	6A13	2498		0-N2305	VB [TE]
2.5 V6 24V	09/96-10/03	6A13	2498	✳	0-N2426	VB [TE]

GALANT Stufenheck (DJ_, ED_, EF_)

2.4	10/03-	4G69	2378	12.7x65; 20x122	SK-1744	BTK
2.4	10/03-	4G69	2378	12.7x65; 20x122; mit Spanndämpfer, Spannrolle	SK-1745	BTK
3.8 GDi 4x4	10/03-	6G75	3828	32x201	SK-1735	BTK
2.4, 2.4 GDi Sport, 2.4 GDi Sport 4x4	10/03-	4G69	2378		0-N1771	TB [BT]



CM³



Art. Nr.



ohne Halter

GALANT Stufenheck (DJ_, ED_, EF_)								
2.4, 2.4 GDi Sport , 2.4 GDi Sport 4x4	10/03-	4G69	2378			0-N2010	TB [VD]	
2.4, 2.4 GDi Sport , 2.4 GDi Sport 4x4	10/03-	4G69	2378			0-N2255	TB [DG]	
3.8 GDi, 3.8 GDi 4x4	10/03-12/09	6G75	3828			0-N185	TB [TE]	
2.0 GDi G, 2.0 GDi V 4x4	10/03-	4G94 (GDI)	1999			0-N2105	VB [BT]	S
2.4	10/03-	4G69	2378	07/2006 →		0-N1984	VB [DG]	
2.4 GDi Sport , 2.4 GDi Sport 4x4	10/03-	4G69	2378			0-N2105	VB [BT]	S
2.4, 2.4 GDi Sport , 2.4 GDi Sport 4x4	10/03-	4G69	2378			0-N1984	VB [DG]	
GALLOPER (JK-01)								
2.5 TD	09/98-12/03	D4BF	2476	25.4x163; 19x99; 09/1999 → 08/2002		SK-1306	BTK	
2.5 TD intercooler	09/98-12/03	D4BH	2476	25.4x163; 19x99; → 08/2002		SK-1306	BTK	
2.5 TD, 2.5 TD intercooler	09/98-12/03	D4BF, D4BH	2476			0-N061	TB [TE]	
2.5 TD, 2.5 TD intercooler	09/98-12/03	D4BF, D4BH	2476			0-N184	TB [TE]	
3.0 V6	09/98-12/03	G6AT	2972			0-N064	TB [TE]	
3.0 V6	09/98-12/03	G6AT	2972			0-N1521	VB [DG]	
SPACE WAGON (N9_, N8_)								
3.0 GDi GLX 4WD	05/00-05/03	6G72 (DOHC 24V)	2972			0-N185	TB [TE]	
3.0 GDi GLX 4WD	05/00-05/03	6G72 (DOHC 24V)	2972			0-N189	TB [DG]	
3.0 GDi GLX 4WD	05/00-05/03	6G72 (DOHC 24V)	2972			0-N1521	VB [DG]	
GRANDIS (NA_W)								
2.0 DI-D	09/05-	BSY, BWC	1968	30x141; → 03/2010; mit Zubehör		SK-1595	BTK	
2.0 DI-D	09/05-	BSY, BWC	1968	30x141; mit Zubehör		SK-1595AQ1	BTKW	
2.4	04/04-	4G69	2378	12.7x65; 20x122		SK-1744	BTK	
2.4	04/04-	4G69	2378	12.7x65; 20x122; mit Spanndämpfer, Spannrolle		SK-1745	BTK	
2.0 DI-D	09/05-	BSY, BWC	1968			0-N1046	TB [DG]	
2.0 DI-D	09/05-	BSY, BWC	1968			0-N1335	TB [TE]	
2.0 DI-D	09/05-	BSY, BWC	1968			0-N1336	TB [DG]	
2.4	04/04-	4G69	2378			0-N1127	TB [TE]	
2.4	04/04-	4G69	2378	→ 02/2010		0-N1771	TB [BT]	
2.4	04/04-	4G69	2378			0-N2010	TB [VD]	
2.4	04/04-	4G69	2378			0-N2255	TB [DG]	
2.0 DI-D	09/05-	BSY, BWC	1968			0-N2364	VB [DG]	
2.0 DI-D	09/05-	BSY, BWC	1968			0-N2397	VB [BT]	S
2.4	04/04-	4G69	2378			0-N1984	VB [DG]	
2.4	04/04-	4G69	2378			0-N2105	VB [BT]	S
GTO Coupe (Z1_A)								
3.0	06/89-09/00	6G72 (DOHC 24V), 6G72T, 6G72T	2972			0-N185	TB [TE]	
3.0	06/89-09/00	6G72 (DOHC 24V), 6G72T, 6G72T	2972			0-N189	TB [DG]	
3.0	06/89-09/00	6G72 (DOHC 24V), 6G72T, 6G72T	2972			0-N1521	VB [DG]	
L 200								
2.3 D 4WD	01/83-10/86	4D55	2346			0-N061	TB [TE]	
2.3 D 4WD	01/83-10/86	4D55	2346			0-N184	TB [TE]	
L 200 (K3_T, K2_T, K1_T, K0_T)								
1.6	04/87-10/96	4G32	1597	19.05x120		SK-1321	BTK	
2.0	11/86-08/96	4G63 (SOHC 8V)	1997	12x55; 19x122; → 04/1992		SK-1240	BTK	
2.0 , 2.0 4x4	11/86-08/96	4G63 (SOHC 8V)	1997	12.7x65; 19x122; 05/1992 →		SK-1311	BTK	
2.0 , 2.0 4x4	11/86-08/96	4G63 (SOHC 8V)	1997	12.7x65; 05/1992 →		SK-1649	BTK	
2.0 4x4	11/86-08/96	4G63 (SOHC 8V)	1997	12x55; 19x122; 05/1987 → 04/1992		SK-1240	BTK	
2.5 D	11/86-10/96	4D56 (8V)	2476	25x163; 19x83; → 05/1993		SK-1236	BTK	
2.5 D	11/86-10/96	4D56 (8V)	2476	25.4x163; 19x99; 06/1993 →		SK-1306	BTK	
2.5 D 4WD	12/87-05/93	4D56 (8V)	2476	25x163; 19x83		SK-1236	BTK	
2.5 TD 4WD	11/92-08/96	4D56 T	2477	25x163; 19x83; → 05/1993		SK-1236	BTK	
2.5 TD 4WD	11/92-08/96	4D56 T	2477	25.4x163; 19x99; 06/1993 →		SK-1306	BTK	
3.0, 3.0 4x4	11/86-08/96	6G72 (SOHC 12V)	2972	25.4x149		SK-1308	BTK	
2.0 , 2.0 4x4	11/86-08/96	4G63 (SOHC 8V)	1997			0-N186	TB [TE]	
2.4 4x4	11/86-05/92	4G64 (8V)	2351			0-N186	TB [TE]	
2.5 D , 2.5 D 4WD	11/86-10/96	4D56 (8V)	2476			0-N061	TB [TE]	
2.5 D , 2.5 D 4WD	11/86-10/96	4D56 (8V)	2476			0-N184	TB [TE]	
2.5 TD 4WD	11/92-08/96	4D56 T	2477			0-N061	TB [TE]	
2.5 TD 4WD	11/92-08/96	4D56 T	2477			0-N184	TB [TE]	
3.0, 3.0 4x4	11/86-08/96	6G72 (SOHC 12V)	2972			0-N1521	VB [DG]	



OPTIMAL®

MITSUBISHI



CM³



Art. Nr.



ohne Halter

L 200 (K7_T, K6_T)

2.0	06/96-12/07	4G63 (SOHC 16V)	1997	12.7x65; 29x123	SK-1323	BTK	
2.0	06/96-12/07	4G63 (SOHC 16V)	1997	12.7x65; 09/1996 →	SK-1649	BTK	
2.4 4x4	06/96-12/07	4G64 (SOHC 16V)	2351	29x124	SK-1313S	BTK	
2.4 4x4	06/96-12/07	4G64 (SOHC 16V)	2351	12.7x65; 09/1996 →	SK-1649	BTK	
2.5 D	06/96-12/07	4D56 (8V)	2477	25.4x163; 19x99; → 03/2005	SK-1306	BTK	
2.5 TD , 2.5 TD 4x4	06/96-12/07	4D56 T, 4D56 TD	2477	25.4x163; 19x99; → 07/2003	SK-1306	BTK	
2.5 TD 4WD	08/01-12/07	4D56 T	2477	25.4x163; 19x99; 08/2003 → 11/2005	SK-1306	BTK	
2.5 TD 4WD	09/01-12/07	4D56 T	2477	25.4x163; 19x99; → 11/2005	SK-1306	BTK	
2.0	06/96-12/07	4G63 (SOHC 16V)	1997		0-N055	TB [DG]	
2.0	06/96-12/07	4G63 (SOHC 16V)	1997		0-N060	TB [TE]	
2.0	06/96-12/07	4G63 (SOHC 16V)	1997		0-N179	TB [TE]	
2.4 4x4	06/96-12/07	4G64 (SOHC 16V)	2351		0-N055	TB [DG]	
2.4 4x4	06/96-12/07	4G64 (SOHC 16V)	2351		0-N060	TB [TE]	
2.4 4x4	06/96-12/07	4G64 (SOHC 16V)	2351		0-N1127	TB [TE]	
2.4 4x4	06/96-12/07	4G64 (SOHC 16V)	2351	→ 06/2001	0-N179	TB [TE]	
2.5 D , 2.5 TD , 2.5 TD 4WD , 2.5 TD 4x4	06/96-12/07	4D56 (8V), 4D56 T, 4D56 TD	2477		0-N061	TB [TE]	
2.5 D , 2.5 TD , 2.5 TD 4WD , 2.5 TD 4x4	06/96-12/07	4D56 (8V), 4D56 T, 4D56 TD	2477		0-N184	TB [TE]	
3.0 4x4	10/96-10/06	6G72 (DOHC 24V), 6G72 (SOHC 24V)	2972		0-N185	TB [TE]	
3.0 4x4	10/96-10/06	6G72 (DOHC 24V), 6G72 (SOHC 24V)	2972		0-N189	TB [DG]	
3.0 4x4	10/96-10/06	6G72 (DOHC 24V), 6G72 (SOHC 24V)	2972		0-N1521	VB [DG]	

L 200 Pritsche/Fahrgestell (K6_T, K7_T)

3.0, 3.0 4WD	10/96-12/06	6G72 (SOHC 24V)	2972		0-N185	TB [TE]	
--------------	-------------	-----------------	------	--	--------	---------	--

L 200 (KB_T, KA_T)

2.5 DiD [RWD] , 2.5 Di-D [RWD] , 2.5 Di-D 4x4	11/05-	4D56 HP	2477	25.4x154; 19x99; ohne Spanndämpfer, Spannrolle	SK-1736	BTK	
2.5 DiD [RWD] , 2.5 Di-D [RWD] , 2.5 Di-D 4x4	11/05-	4D56 HP	2477	25.4x154; 19x99; mit Spanndämpfer, Spannrolle	SK-1737	BTK	
2.5 Di-D 4x4	11/05-	4D56 HP	2477	25.4x154; 19x99; ohne Spanndämpfer, Spannrolle; Baumuster: L200	SK-1736	BTK	
2.5 Di-D 4x4	11/05-	4D56 HP	2477	25.4x154; 19x99; ohne Spanndämpfer, Spannrolle; Baumuster: Triton	SK-1736	BTK	
2.5 Di-D 4x4	11/05-	4D56 HP	2477	25.4x154; 19x99; mit Spanndämpfer, Spannrolle; Baumuster: L200	SK-1737	BTK	
2.5 Di-D 4x4	11/05-	4D56 HP	2477	25.4x154; 19x99; mit Spanndämpfer, Spannrolle; Baumuster: Triton	SK-1737	BTK	
2.5 Di-D [RWD]	04/10-	4D56 HP	2477		0-N2012	TB [VD]	
2.5 Di-D, 2.5 DiD [RWD] , 2.5 Di-D [RWD] , 2.5 Di-D 4x4	11/05-	4D56 HP	2477		0-N1772	TB [BT]	
2.5 Di-D, 2.5 DiD [RWD] , 2.5 Di-D [RWD] , 2.5 Di-D 4x4	11/05-	4D56 HP	2477		0-N184	TB [TE]	
2.5 Di-D, 2.5 DiD [RWD] , 2.5 Di-D [RWD] , 2.5 Di-D 4x4	11/05-	4D56 HP	2477		0-N2161	TB [TE]	S
2.5 Di-D, 2.5 DiD [RWD] , 2.5 Di-D [RWD] , 2.5 Di-D 4x4	11/05-	4D56 HP	2477		0-N2012	TB [VD]	
3.5 4x4	05/07-	6G74 (SOHC 24V)	3497		0-N185	TB [TE]	
3.5 4x4	05/07-	6G74 (SOHC 24V)	3497		0-N189	TB [DG]	
2.5 Di-D, 2.5 DiD [RWD] , 2.5 Di-D [RWD] , 2.5 Di-D 4x4	11/05-	4D56 HP	2477		0-N2270	VB [BT]	S
3.5 4x4	05/07-	6G74 (SOHC 24V)	3497		0-N1521	VB [DG]	

L 200 Pritsche/Fahrgestell (KA_T, KB_T)

2.5 Di-D 4x4	04/10-	4D56 HP	2477		0-N2012	TB [VD]	
2.5 Di-D 4x4	04/10-	4D56 HP	2477		0-N2270	VB [BT]	S

L 300 Bus (LO3_P/G, L0_2P)

1.8 4x4	08/84-02/87	4G62	1795	19x122	SK-1240S	BTK	
2.0 4x4	11/86-02/87	4G63 (SOHC 8V)	1997	19x122	SK-1240S	BTK	
1.6	09/81-10/86	4G32	1597		0-N051	TB [TE]	
1.6	11/84-02/87	4G32	1597	→ 10/1986	0-N051	TB [TE]	
1.6	11/84-02/87	4G32	1597	11/1986 →	0-N053	TB [TE]	
1.8, 1.8 4x4	03/83-02/87	4G62	1795		0-N059	TB [TE]	
1.8, 1.8 4x4	03/83-02/87	4G62	1795		0-N183	TB [TE]	
2.0 4x4	11/86-02/87	4G63 (SOHC 8V)	1997		0-N059	TB [TE]	
2.0 4x4 , 2.0 DL	06/82-02/87	4G63 (SOHC 8V), 4G63 (SOHC 8V), G63B	1997		0-N183	TB [TE]	
2.3 D	04/83-10/86	4D55	2347		0-N061	TB [TE]	
2.3 D	04/83-10/86	4D55	2347		0-N184	TB [TE]	

L 300 Kasten (L03_P)

1.6	05/80-10/86	4G32	1597		0-N051	TB [TE]	
-----	-------------	------	------	--	--------	---------	--



CM³



Art. Nr.



ohne Halter

L 300 Kasten (L03_P)

1.8	03/83-10/86	4G62	1795		0-N059	TB [TE]
1.8	03/83-10/86	4G62	1795		0-N183	TB [TE]
2.0 DL	06/82-08/85	4G63 (SOHC 8V), G63B	1997		0-N183	TB [TE]
2.3 D	09/83-10/86	4D55	2347		0-N061	TB [TE]
2.3 D	09/83-10/86	4D55	2347		0-N184	TB [TE]

L 300 Bus (P0_W, P1_W, P2_W)

1.6	11/86-	4G32	1598	19.05x120	SK-1321	BTK
2.0	11/86-	4G63 (SOHC 8V)	1997	12x55; 19x122; 05/1987 → 07/1988	SK-1240	BTK
2.0	11/86-	G63B	1997	12x55; 19x122; 08/1988 → 04/1992	SK-1240	BTK
2.0, 2.0 4WD	11/86-	4G63 (SOHC 8V), G63B	1997	19x122; → 04/1992	SK-1240S	BTK
2.0, 2.0 4WD	11/86-	4G63 (SOHC 8V), G63B	1997	12.7x65; 19x122; 05/1992 → 05/1994	SK-1311	BTK
2.0, 2.0 4WD	11/86-	4G63 (SOHC 8V), G63B	1997	12.7x65; 05/1992 →	SK-1649	BTK
2.0 4WD	11/86-	4G63 (SOHC 8V)	1997	12x55; 19x122; 05/1987 → 04/1992	SK-1240	BTK
2.0 GLS, 2.0 i	06/94-10/98	4G63 (DOHC 16V), 4G63 (SOHC 16V)	1997	12.7x65; 19x122	SK-1311	BTK
2.0 GLS, 2.0 i	06/94-10/98	4G63 (DOHC 16V), 4G63 (SOHC 16V)	1997	12.7x65	SK-1649	BTK
2.4, 2.4 4WD	11/90-	4G64 (8V)	2351	19x123; → 04/1992	SK-1237S	BTK
2.4, 2.4 4WD, 2.4 GLX 4x4	11/86-08/97	4G64 (8V)	2351	12x55; 19x123; → 04/1992	SK-1237	BTK
2.4, 2.4 4WD, 2.4 GLX 4x4	11/86-08/97	4G64 (8V)	2351	12.7x65; 05/1992 →	SK-1649	BTK
2.4 4WD	11/86-12/90	G64B	2351	12x55; 19x123	SK-1237	BTK
2.4 4WD	11/86-12/90	G64B	2351	19x123	SK-1237S	BTK
2.5 D, 2.5 TD	11/86-05/03	4D56 (8V), 4D56 T	2477	25.4x163; 19x99; 06/1993 →	SK-1306	BTK
2.5 D, 2.5 TD, 2.5 TD 4WD	11/86-05/03	4D56 (8V), 4D56 T	2477	25x163; 19x83; → 05/1993	SK-1236	BTK
2.5 TD 4WD	11/88-	4D56 T	2477	25.4x163; 19x99; 06/1993 → 08/1997	SK-1306	BTK
1.6	11/86-	4G32	1598		0-N053	TB [TE]
2.0	11/86-07/88	G63B	1997	05/1987 →	0-N186	TB [TE]
2.0, 2.0 4WD	11/86-	4G63 (SOHC 8V), G63B	1997		0-N059	TB [TE]
2.0, 2.0 4WD	11/86-	4G63 (SOHC 8V), G63B	1997	05/1992 →	0-N179	TB [TE]
2.0, 2.0 4WD	11/86-07/88	4G63 (SOHC 8V), G63B	1997	→ 04/1987	0-N183	TB [TE]
2.0, 2.0 4WD	11/86-	4G63 (SOHC 8V), G63B	1997	05/1987 → 04/1992	0-N186	TB [TE]
2.0 i	06/94-10/98	4G63 (DOHC 16V), 4G63 (SOHC 16V)	1997		0-N055	TB [DG]
2.0 i	06/94-10/98	4G63 (DOHC 16V), 4G63 (SOHC 16V)	1997		0-N060	TB [TE]
2.0 i	06/94-10/98	4G63 (DOHC 16V), 4G63 (SOHC 16V)	1997		0-N179	TB [TE]
2.4, 2.4 4WD	11/86-12/90	4G64 (8V), G64B	2351		0-N059	TB [TE]
2.4, 2.4 4WD	08/88-08/97	4G64 (8V)	2351	→ 04/1992	0-N186	TB [TE]
2.4, 2.4 4WD	11/90-	4G64 (8V)	2351	05/1992 →	0-N179	TB [TE]
2.4 4WD	11/86-12/90	G64B	2351	05/1987 →	0-N186	TB [TE]
2.4 4WD, 2.4 GLX 4x4	11/86-08/97	4G64 (8V), G64B	2351	→ 04/1987	0-N183	TB [TE]
2.4 GLX 4x4	11/86-08/97	4G64 (8V)	2351	05/1987 → 04/1992	0-N186	TB [TE]
2.5 D, 2.5 TD, 2.5 TD 4WD	11/86-09/03	4D56 (8V), 4D56 T	2477		0-N061	TB [TE]
2.5 D, 2.5 TD, 2.5 TD 4WD	11/86-09/03	4D56 (8V), 4D56 T	2477		0-N184	TB [TE]
3.0, 3.0 4x4	06/94-05/03	6G72 (DOHC 24V)	2972		0-N185	TB [TE]
3.0, 3.0 4x4	06/94-05/03	6G72 (DOHC 24V)	2972		0-N189	TB [DG]
3.0, 3.0 4x4	06/94-05/03	6G72 (DOHC 24V)	2972		0-N1521	VB [DG]

L 300 Kasten (P0_W, P1_W, P0_V, P1_V, P_2V, P2_W)

1.6	11/86-05/94	4G32	1598	19.05x120	SK-1321	BTK
2.0	11/86-09/13	G63B	1997	12x55; 19x122; 05/1987 → 04/1992	SK-1240	BTK
2.0	11/86-09/13	G63B	1997	19x122; → 04/1992	SK-1240S	BTK
2.0	11/86-09/13	G63B	1997	12.7x65; 19x122; 05/1992 → 05/1994	SK-1311	BTK
2.0	06/94-05/02	4G63 (SOHC 16V)	1997	12.7x65; 19x122	SK-1311	BTK
2.0	06/94-11/03	4G63 (DOHC 16V), 4G63 (SOHC 8V), 4G63 (SOHC 16V)	1997	12.7x65	SK-1649	BTK
2.0, 2.0 4x4	11/86-09/13	4G63 (SOHC 8V), G63B	1997	12.7x65; 05/1992 →	SK-1649	BTK
2.0 4x4	08/88-05/94	4G63 (SOHC 8V)	1997	12x55; 19x122; → 04/1992	SK-1240	BTK
2.0 4x4	08/88-05/94	4G63 (SOHC 8V)	1997	12.7x65; 19x122; 05/1992 →	SK-1311	BTK
2.5 D, 2.5 TD 4x4	11/86-02/06	4D56 (8V), 4D56 T	2477	25x163; 19x83; → 05/1993	SK-1236	BTK
2.5 D, 2.5 TD 4x4	11/86-02/06	4D56 (8V), 4D56 T	2477	25.4x163; 19x99; 06/1993 →	SK-1306	BTK
1.6	11/86-05/94	4G32	1598		0-N053	TB [TE]
2.0	11/86-09/13	G63B	1997	→ 04/1987	0-N183	TB [TE]
2.0	11/86-07/88	G63B	1997	05/1987 →	0-N186	TB [TE]
2.0	11/86-09/13	G63B	1997	05/1987 → 04/1992	0-N186	TB [TE]
2.0, 2.0 4x4	11/86-09/13	4G63 (SOHC 8V), G63B	1997		0-N059	TB [TE]
2.0, 2.0 4x4	11/86-09/13	4G63 (SOHC 8V), G63B	1997	05/1992 →	0-N179	TB [TE]
2.0 4x4	08/88-05/94	4G63 (SOHC 8V)	1997	→ 04/1992	0-N186	TB [TE]
2.4, 2.4 4x4	11/86-08/97	4G64 (8V), G64B	2351	→ 04/1987	0-N183	TB [TE]
2.4, 2.4 4x4	11/86-08/97	4G64 (8V), G64B	2351	05/1987 → 04/1992	0-N186	TB [TE]



OPTIMAL®

MITSUBISHI



CM³



Art. Nr.



L 300 Kasten (P0_W, P1_W, P0_V, P1_V, P_2V, P2_W)

2.5 D , 2.5 TD, 2.5 TD 4x4	11/86-02/06	4D56 (8V), 4D56 T	2477		0-N061	TB [TE]
2.5 D , 2.5 TD, 2.5 TD 4x4	11/86-02/06	4D56 (8V), 4D56 T	2477		0-N184	TB [TE]
3.0, 3.0 4x4	06/94-05/03	6G72 (DOHC 24V)	2972		0-N185	TB [TE]
3.0, 3.0 4x4	06/94-05/03	6G72 (DOHC 24V)	2972		0-N189	TB [DG]
3.0, 3.0 4x4	06/94-05/03	6G72 (DOHC 24V)	2972		0-N1521	VB [DG]

L 300 Pritsche/Fahrgestell (L03_P)

2.5 D	11/86-04/94	4D56 (8V)	2477	25x163; 19x83; → 05/1993	SK-1236	BTK
2.5 D	11/86-04/94	4D56 (8V)	2477	25.4x163; 19x99; 06/1993 →	SK-1306	BTK
1.6	04/83-04/94	4G32	1597	→ 10/1986	0-N051	TB [TE]
1.6	04/83-04/94	4G32	1597	11/1986 →	0-N053	TB [TE]
2.0	06/82-08/85	G63B	1997		0-N183	TB [TE]
2.5 D	11/86-04/94	4D56 (8V)	2477		0-N061	TB [TE]
2.5 D	11/86-04/94	4D56 (8V)	2477		0-N184	TB [TE]

L 300 Pritsche/Fahrgestell (P1_T)

2.0	07/94-04/00	4G63 (SOHC 16V), 4G63 (SOHC 16V)	1997	12.7x65; 29x123	SK-1323	BTK
2.0	07/94-04/00	4G63 (SOHC 16V), 4G63 (SOHC 16V)	1997	12.7x65	SK-1649	BTK
2.5 TD	11/94-04/00	4D56 T	2477	25.4x163; 19x99	SK-1306	BTK
2.0	07/94-04/00	4G63 (SOHC 16V), 4G63 (SOHC 16V)	1997		0-N055	TB [DG]
2.0	07/94-04/00	4G63 (SOHC 16V), 4G63 (SOHC 16V)	1997		0-N060	TB [TE]
2.0	07/94-04/00	4G63 (SOHC 16V), 4G63 (SOHC 16V)	1997		0-N179	TB [TE]
2.5 TD	11/94-04/00	4D56 T	2477		0-N061	TB [TE]
2.5 TD	11/94-04/00	4D56 T	2477		0-N184	TB [TE]

L 400 / SPACE GEAR Bus (PD_W, PC_W, PA_V, PB_V, PA_W)

2.0, 2.0 16V	05/95-10/02	4G63 (DOHC 16V), 4G63 (SOHC 16V), 4G63 (SOHC 16V), 4G63 (SOHC 16V)	1997	12.7x65; 29x123	SK-1323	BTK
2.0, 2.0 16V	05/95-10/02	4G63 (DOHC 16V), 4G63 (SOHC 16V), 4G63 (SOHC 16V), 4G63 (SOHC 16V)	1997	12.7x65	SK-1649	BTK
2.4	05/95-10/02	4G64 (SOHC 16V)	2351	12.7x65; → 03/2001	SK-1649	BTK
2.4 i 4x4	05/95-05/00	4G64 (SOHC 16V)	2351	29x124	SK-1313S	BTK
2.4 i 4x4	05/95-05/00	4G64 (SOHC 16V)	2351	12.7x65	SK-1649	BTK
2.5 TD , 2.5 TD 4x4	05/95-05/00	4D56 TD	2477	25.4x163; 19x99	SK-1306	BTK
2500 TD	05/95-06/05	4D56 T	2477	25.4x163; 19x99; → 03/2001	SK-1306	BTK
2.0 16V	05/95-05/00	4G63 (DOHC 16V), 4G63 (SOHC 16V)	1997		0-N055	TB [DG]
2.0, 2.0 16V	05/95-10/02	4G63 (DOHC 16V), 4G63 (SOHC 16V), 4G63 (SOHC 16V), 4G63 (SOHC 16V)	1997		0-N060	TB [TE]
2.0, 2.0 16V	05/95-10/02	4G63 (DOHC 16V), 4G63 (SOHC 16V), 4G63 (SOHC 16V), 4G63 (SOHC 16V)	1997		0-N179	TB [TE]
2.4 i 4x4	05/95-05/00	4G64 (SOHC 16V)	2351		0-N055	TB [DG]
2.4 i 4x4	05/95-05/00	4G64 (SOHC 16V)	2351		0-N179	TB [TE]
2.4, 2.4 4WD, 2.4 i 4x4	05/95-06/05	4G64 (SOHC 16V)	2351		0-N060	TB [TE]
2.5 TD , 2.5 TD 4x4 , 2500 TD	05/95-06/05	4D56 T, 4D56 TD	2477		0-N061	TB [TE]
2.5 TD , 2.5 TD 4x4 , 2500 TD	05/95-06/05	4D56 T, 4D56 TD	2477		0-N184	TB [TE]

L 400 Kasten (PD_W, PC_W, PB_V, PA_W, PA_V)

2.0	06/96-03/01	4G63 (SOHC 16V)	1997	12.7x65; 29x123	SK-1323	BTK
2.0	06/96-03/01	4G63 (SOHC 16V)	1997	12.7x65	SK-1649	BTK
2500 TD	09/96-06/05	4D56 T	2477	25.4x163; 19x99; → 03/2003	SK-1306	BTK
2500 TD 4x4	09/96-06/05	4D56 T	2477	25.4x163; 19x99; → 03/2001	SK-1306	BTK
2500 TD , 2500 TD 4x4	09/96-06/05	4D56 T	2477		0-N061	TB [TE]
2500 TD , 2500 TD 4x4	09/96-06/05	4D56 T	2477		0-N184	TB [TE]

LANCER I (A17_)

2.0 Turbo ECi	03/81-02/83	4G63 T (SOHC 8V)	1997	19x122	SK-1240S	BTK
1.2	01/80-12/81	4G11	1244		0-N986	TB [TE]
1.4 GLX	09/79-02/83	4G12	1410		0-N986	TB [TE]
1.6	09/79-02/83	4G32 GS	1597		0-N051	TB [TE]
1.6	09/79-02/83	4G32 GS	1597		0-N188	TB [TE]
2.0 Turbo ECi	03/81-02/83	4G63 T (SOHC 8V)	1997		0-N059	TB [TE]
2.0 Turbo ECi	03/81-02/83	4G63 T (SOHC 8V)	1997		0-N183	TB [TE]

LANCER F II (A17_)

1.2 GLX	03/83-01/84	4G11	1244		0-N986	TB [TE]
1.4 GLX , 1.4 Turbo	03/83-01/84	4G12, 4G12 T	1410		0-N986	TB [TE]

LANCER III (C1_A, C6_A)

1.2	08/86-04/88	4G16	1198	19x92; 06/1987 →	SK-1242	BTK
1.2	08/86-04/88	4G16	1198	19.05x92; → 05/1987	SK-1317	BTK
1.2 GL	01/84-10/86	4G16	1198	19.05x92; 05/1984 →	SK-1317	BTK



CM³



Art. Nr.



LANCER III (C1_A, C6_A)

1.5 GLX	11/83-04/88	4G15, G15B	1468	19x92; 06/1987 →	SK-1242	BTK
1.5 GLX	11/83-04/88	4G15	1468	19.05x92; 02/1984 → 05/1987	SK-1317	BTK
1.5 GLX	06/85-04/88	G15B	1468	19.05x92; → 05/1987	SK-1317	BTK
1.2, 1.2 GL	01/84-04/88	4G16	1198		0-N986	TB [TE]
1.5 GLX	11/83-04/88	4G15, G15B	1468		0-N986	TB [TE]
1.8 Diesel	01/84-04/88	4D65	1796		0-N058	TB [DG]
1.8 Diesel	01/84-04/88	4D65	1796		0-N183	TB [TE]

LANCER III Station Wagon (C1_V, C3_V)

1.5	09/85-08/89	4G15, G15B	1468	19x92; 06/1987 →	SK-1242	BTK
1.5	09/85-08/89	G15B	1468	19.05x92; → 06/1987; für OE: MD113563	SK-1317	BTK
1.5	09/85-12/87	4G15	1468	19.05x92; → 06/1987	SK-1317	BTK
1.5	09/88-12/90	4G15	1468	22x92; 06/1990 →	SK-1234	BTK
1.5	09/88-12/90	4G15	1468	19x92; → 05/1990	SK-1242	BTK
1.5 12V	09/90-12/91	4G15 (12V)	1468	22x92	SK-1234	BTK
1.8 4x4	01/87-06/92	4G37, G37B	1755	19.05x120	SK-1321	BTK
1.3 GL	07/90-08/92	4G13 (12V)	1298		0-N987	TB [TE]
1.5	09/85-08/89	4G15, G15B	1468		0-N986	TB [TE]
1.5	09/88-12/90	4G15	1468	→ 05/1990	0-N986	TB [TE]
1.5, 1.5 GLS	09/88-08/92	4G15, 4G15 (12V)	1468	06/1990 →	0-N987	TB [TE]
1.5 12V	09/90-12/91	4G15 (12V)	1468		0-N987	TB [TE]
1.8 4x4	01/87-06/92	4G37, G37B	1755		0-N053	TB [TE]
1.8 D	09/85-06/92	4D65	1796		0-N058	TB [DG]
1.8 D	09/85-06/92	4D65	1796		0-N183	TB [TE]
1.8 D 4x4	10/86-10/88	4D65	1795		0-N183	TB [TE]

LANCER IV (C6_A, C7_A)

1.3 12V	06/92-05/94	4G13 (12V)	1299	22x92	SK-1234	BTK
1.5	09/88-08/90	4G15 (12V)	1468	22x92; 06/1990 →	SK-1234	BTK
1.5, 1.5 12V	06/88-05/92	4G15, 4G15 (12V)	1468	19x92; → 05/1990	SK-1242	BTK
1.5 12V	05/89-05/92	4G15 (12V)	1468	22x92; 07/1990 →	SK-1234	BTK
1.6 16V	06/92-05/94	4G92 (SOHC 16V)	1597	29x117	SK-1314	BTK
1.8 4x4	09/89-06/92	4G37	1755	19.05x120	SK-1321	BTK
1.8 GTi 16V	11/89-05/92	4G67	1836	29x117; 06/1990 →	SK-1314	BTK
1.8 GTi 16V	11/89-05/92	4G67	1836	29x153; 12.7x65	SK-1555	BTK
1.8 GTi 16V	11/89-05/92	4G67	1836	12.7x65	SK-1649	BTK
1.8 GTi 16V	06/92-12/93	4G93 (DOHC 16V), 4G93 (SOHC 16V)	1834	29x117	SK-1314	BTK
1.3 12V	07/90-07/93	4G13 (12V)	1298		0-N987	TB [TE]
1.3 12V	06/92-05/94	4G13 (12V)	1299		0-N987	TB [TE]
1.5, 1.5 12V	06/88-05/92	4G15, 4G15 (12V)	1468	→ 05/1990	0-N986	TB [TE]
1.5, 1.5 12V	06/88-05/92	4G15, 4G15 (12V)	1468	06/1990 →	0-N987	TB [TE]
1.6 16V	06/92-05/94	4G92 (SOHC 16V)	1597		0-N052	TB [TE]
1.6 GTi, 1.6 i	05/88-09/92	4G61	1596		0-N054	TB [TE]
1.6 GTi, 1.6 i	05/88-09/92	4G61	1596		0-N055	TB [DG]
1.6 GTi, 1.6 i	05/88-09/92	4G61	1596		0-N1971	TB [BT]
1.8 4x4	09/89-06/92	4G37	1755		0-N053	TB [TE]
1.8 D	04/88-05/92	4D65	1796		0-N058	TB [DG]
1.8 D	04/88-05/92	4D65	1796		0-N183	TB [TE]
1.8 GTi 16V	11/89-05/92	4G67	1836		0-N054	TB [TE]
1.8 GTi 16V	11/89-05/92	4G67	1836		0-N055	TB [DG]
1.8 GTi 16V	11/89-05/92	4G67	1836		0-N179	TB [TE]
1.8 GTi 16V	11/89-05/92	4G67	1836		0-N1971	TB [BT]
1.8 GTi 16V	06/92-12/93	4G93 (DOHC 16V), 4G93 (SOHC 16V)	1834		0-N055	TB [DG]
1.8 GTi 16V	06/92-12/93	4G93 (DOHC 16V), 4G93 (SOHC 16V)	1834		0-N056	TB [TE]

LANCER IV Stufenheck (C6_A)

1.3	04/88-05/92	4G13 (8V), 4G13 (8V), G13B, G13B, G13B	1299	22x92; 06/1990 →	SK-1234	BTK
1.3	04/88-05/92	4G13 (8V), 4G13 (8V), G13B, G13B, G13B	1299	19x92; → 05/1990	SK-1242	BTK
1.3 12V	07/90-06/92	4G13 (12V)	1299	22x92	SK-1234	BTK
1.5, 1.5 12V	04/88-05/92	4G15 (12V), 4G15 (12V), 4G15 (12V)	1468	19x92; → 05/1990	SK-1242	BTK
1.5 12V	05/89-05/92	4G15 (12V)	1468	22x92; 07/1990 →	SK-1234	BTK
1.3	04/88-05/92	4G13 (8V), 4G13 (8V), G13B, G13B, G13B	1299	→ 05/1990	0-N986	TB [TE]
1.3	04/88-05/92	4G13 (8V), 4G13 (8V), G13B, G13B, G13B	1299	06/1990 →	0-N987	TB [TE]
1.3 12V	07/90-06/92	4G13 (12V)	1299		0-N987	TB [TE]
1.5	09/90-09/92	4G15 (12V)	1468		0-N987	TB [TE]
1.5, 1.5 12V	04/88-05/92	4G15 (12V), 4G15 (12V), 4G15 (12V)	1468	→ 05/1990	0-N986	TB [TE]
1.5, 1.5 12V, 1.5 GLS	04/88-08/92	4G15 (12V), 4G15 (12V), 4G15 (12V)	1468	06/1990 →	0-N987	TB [TE]



OPTIMAL®

MITSUBISHI

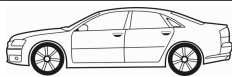

CM³



Art. Nr.



ohne Halter

LANCER IV Stufenheck (C6_A)

1.6 GLX	08/89-08/92	4G61	1597		0-N054	TB [TE]
1.6 GLX	08/89-08/92	4G61	1597		0-N055	TB [DG]
1.6 GLX	08/89-08/92	4G61	1597		0-N1971	TB [BT]
1.6 GTi	05/88-05/90	4G61	1596		0-N054	TB [TE]
1.6 GTi	05/88-05/90	4G61	1596		0-N055	TB [DG]
1.6 GTi	05/88-05/90	4G61	1596		0-N1971	TB [BT]
1.8 GLX Diesel	04/88-05/92	4D65	1796		0-N058	TB [DG]
1.8 GLX Diesel	04/88-05/92	4D65	1796		0-N183	TB [TE]

LANCER Coupe (CC)

1.8	09/92-07/96	4G93 (DOHC 16V), 4G93 (DOHC 16V)	1834		0-N055	TB [DG]
1.8	09/92-07/96	4G93 (DOHC 16V), 4G93 (DOHC 16V)	1834		0-N056	TB [TE]

LANCER V (CB/D_A)

1.3	06/92-02/95	4G13 (12V)	1298	22x92	SK-1234	BTK
1.3	06/92-12/96	4G13 (12V)	1299	22x92; → 02/1995	SK-1234	BTK
1.6	02/94-12/96	4G92 (SOHC 16V)	1597	29x117; → 02/1996	SK-1314	BTK
1.6 16V	06/92-12/96	4G92 (SOHC 16V)	1597	29x117; 08/1993 → 02/1996	SK-1314	BTK
1.6 16V 4WD	06/92-12/96	4G92 (SOHC 16V)	1597	29x117; 08/1993 → 08/1995	SK-1314	BTK
2.0 Diesel	06/92-12/96	4D68	1998	12.7x65; 32x158; 08/1993 →	SK-1463	BTK
2.0 Diesel	06/92-12/96	4D68	1998	12.7x65; 08/1993 →	SK-1649	BTK
1.3	06/92-02/95	4G13 (12V)	1298		0-N987	TB [TE]
1.3	06/92-12/96	4G13 (12V)	1299		0-N987	TB [TE]
1.5	09/92-07/96	4G15 (12V)	1468		0-N987	TB [TE]
1.6, 1.6 16V, 1.6 16V 4WD	06/92-12/96	4G92 (SOHC 16V)	1597		0-N052	TB [TE]
1.8 16V	06/92-12/93	4G93 (DOHC 16V), 4G93 (DOHC 16V)	1834		0-N055	TB [DG]
1.8 16V, 1.8 i Turbo AWD	06/92-07/96	4G93 (DOHC 16V), 4G93 (DOHC 16V), 4G93T	1834		0-N056	TB [TE]
2.0 Diesel	06/92-12/96	4D68	1998		0-N058	TB [DG]
2.0 Diesel	06/92-12/96	4D68	1998		0-N065	TB [TE]
2.0 Diesel	06/92-12/96	4D68	1998		0-N179	TB [TE]
2.0 EVO II, 2.0 EVO III	01/94-07/96	4G63 Turbo	1997		0-N060	TB [TE]

LANCER V Station Wagon (CB_W, CD_W)

1.6 16V, 1.6 16V 4WD	12/92-10/03	4G92 (SOHC 16V)	1597	29x117	SK-1314	BTK
2.0 D	12/92-10/03	4D68	1998	12.7x65; 32x158	SK-1463	BTK
2.0 D	12/92-10/03	4D68	1998	12.7x65	SK-1649	BTK
2.0 D	03/95-10/03	4D68 T	1998	12.7x65; 32x158; 06/1995 →	SK-1463	BTK
2.0 D	03/95-10/03	4D68 T	1998	12.7x65; 06/1995 →	SK-1649	BTK
1.3, 1.3 16V	09/97-08/03	4G13 (12V)	1298		0-N987	TB [TE]
1.5	03/95-10/03	4G15 (12V)	1468		0-N1129	TB [TE]
1.5	03/95-10/03	4G15 (12V)	1468	→ 11/1998	0-N181	TB [TE]
1.6 16V, 1.6 16V 4WD	12/92-10/03	4G92 (SOHC 16V)	1597		0-N052	TB [TE]
1.8 4x4	03/95-10/03	4G93T	1834		0-N056	TB [TE]
1.8 4x4, 1.8 i	03/95-10/03	4G93 (SOHC 16V), 4G93T	1834		0-N055	TB [DG]
1.8 4x4, 1.8 i	03/95-10/03	4G93 (SOHC 16V)	1834		0-N056	TB [TE]
2.0 D	12/92-10/03	4D68	1998		0-N058	TB [DG]
2.0 D	12/92-10/03	4D68	1998		0-N065	TB [TE]
2.0 D	12/92-10/03	4D68	1998		0-N179	TB [TE]

LANCER SPORTBACK (CX_A)

2.0 DI-D	06/08-	BKD, BWC	1968	30x141; mit Zubehör	SK-1595	BTK
2.0 DI-D	06/08-	BKD, BWC	1968	30x141; mit Zubehör	SK-1595AQ1	BTKW
2.0 DI-D	06/08-	BKD, BWC	1968		0-N1046	TB [DG]
2.0 DI-D	06/08-	BKD, BWC	1968		0-N1335	TB [TE]
2.0 DI-D	06/08-	BKD, BWC	1968		0-N1336	TB [DG]
1.8, 1.8 Bifuel, 1.8 Flex	06/08-	4B10	1798		0-N2112	VB [BT] S
1.8, 1.8 Bifuel, 1.8 Flex	06/08-	4B10	1798		0-N2294	VB [DG]
1.8, 1.8 Bifuel, 1.8 Flex	06/08-	4B10	1798		0-N2354	VB [DG]
1.8, 1.8 Flex	06/08-	4B10	1798		0-N2048	VB [DG]
1.8 Bifuel	02/10-	4B10	1798	→ 01/2012	0-N2048	VB [DG]
2.0 DI-D	06/08-	BKD, BWC	1968		0-N2364	VB [DG]
2.0 DI-D	06/08-	BKD, BWC	1968		0-N2397	VB [BT] S
2.0 Ralliart	10/08-	4B11 T/C	1998		0-N2048	VB [DG]

LANCER Stufenheck (CY/Z_A)

2.0 DI-D	01/08-	BKD, BWC	1968	30x141; mit Zubehör	SK-1595	BTK
2.0 DI-D	01/08-	BKD, BWC	1968	30x141; mit Zubehör	SK-1595AQ1	BTKW
2.0 DI-D	01/08-	BKD, BWC	1968		0-N1046	TB [DG]



CM³



Art. Nr.



LANCER Stufenheck (CY/Z_A)							
2.0 DI-D	01/08-	BKD, BWC	1968			0-N1335	TB [TE]
2.0 DI-D	01/08-	BKD, BWC	1968			0-N1336	TB [DG]
1.6 Alcohol, 2.0, 2.0 EVO, 2.0 i, 2.0 i Ralliart AWD	04/08-	4B11, 4B11 T/C	1998			0-N2048	VB [DG]
1.8	05/10-	4B10	1798			0-N2112	VB [BT] S
1.8, 1.8 Bifuel, 1.8 Flex	02/08-	4B10	1798			0-N2048	VB [DG]
1.8, 1.8 Bifuel, 1.8 Flex	02/08-	4B10	1798			0-N2354	VB [DG]
1.8, 1.8 Flex	02/08-	4B10	1798	03/2010 →		0-N2112	VB [BT] S
1.8, 1.8 Flex	03/09-	4B10	1798			0-N2294	VB [DG]
2.0 DI-D	01/08-	BKD, BWC	1968			0-N2364	VB [DG]
2.0 DI-D	01/08-	BKD, BWC	1968			0-N2397	VB [BT] S
LANCER VI (CJ-CP_)							
1.3 12V	12/95-08/03	4G13 (12V)	1299	25.4x107; → 11/1998		SK-1460	BTK
1.3 12V	12/95-08/03	4G13 (12V)	1299	25.4x107; 12/1998 →		SK-1753	BTK
1.6 16V	12/95-08/03	4G92 (SOHC 16V)	1597	29x111		SK-1316	BTK
1.6 16V	12/95-08/03	4G92 (SOHC 16V)	1597	29x111		SK-1316AQ2	BTKW
1.3 12V	12/95-08/03	4G13 (12V)	1299			0-N1129	TB [TE]
1.3 12V	12/95-08/03	4G13 (12V)	1299	→ 12/1998		0-N181	TB [TE]
1.5	09/95-08/99	4G15 (12V)	1468	→ 11/1998		0-N181	TB [TE]
1.5, 1.5 16V	09/95-08/03	4G15 (12V), 4G15 (16V)	1468			0-N1129	TB [TE]
1.6 16V	12/95-08/03	4G92 (SOHC 16V)	1597			0-N182	TB [TE]
1.8, 1.8 16V, 1.8 GDI, 1.8 GDI 4WD	09/95-08/03	4G93 (GDI), 4G93 (SOHC 16V), 4G93T, 4G93T (GDI)	1834			0-N055	TB [DG]
1.8, 1.8 16V, 1.8 GDI, 1.8 GDI 4WD	09/95-08/03	4G93 (GDI), 4G93 (SOHC 16V), 4G93T, 4G93T (GDI)	1834			0-N056	TB [TE]
2.0 16V EVO	08/98-08/01	4G63 Turbo	1997			0-N055	TB [DG]
2.0 16V EVO	08/98-08/01	4G63 Turbo	1997			0-N060	TB [TE]
1.6 16V	12/95-08/03	4G92 (SOHC 16V)	1597			0-N1521	VB [DG]
2.0	09/95-08/03	4G94 (GDI)	1999			0-N2105	VB [BT] S
2.0 16V EVO	08/98-08/01	4G63 Turbo	1997			0-N1521	VB [DG]
2.0 16V EVO	08/98-08/01	4G63 Turbo	1997			0-N2259	VB [BT]
LANCER Kombi (CS_W)							
1.6	09/03-10/08	4G18	1584	25x109		SK-1470	BTK
1.6	09/03-10/08	4G18	1584			0-N1129	TB [TE]
2.0	09/03-12/07	4G63 (DOHC 16V)	1997			0-N055	TB [DG]
2.0	09/03-12/07	4G63 (DOHC 16V)	1997			0-N060	TB [TE]
2.0	09/03-12/07	4G63 (DOHC 16V)	1997			0-N1127	TB [TE]
2.0	09/03-12/07	4G63 (DOHC 16V)	1997			0-N2010	TB [VD]
2.0	08/05-10/08	4G94	1999			0-N2010	TB [VD]
2.0	09/03-12/07	4G63 (DOHC 16V)	1997			0-N1984	VB [DG]
2.0	09/03-12/07	4G63 (DOHC 16V)	1997			0-N2105	VB [BT] S
2.0	08/05-10/08	4G94	1999			0-N1984	VB [DG]
2.0	08/05-10/08	4G94	1999			0-N2105	VB [BT] S
LANCER Stufenheck (CS_A, CT0)							
1.3	09/03-	4G13 (16V)	1299	25x109		SK-1470	BTK
1.6	09/03-	4G18	1584	25x109		SK-1470	BTK
1.3	09/03-	4G13 (16V)	1299			0-N1129	TB [TE]
1.6	09/03-	4G18	1584			0-N1129	TB [TE]
2.0	12/03-	4G63 (DOHC 16V)	1997			0-N055	TB [DG]
2.0	12/03-	4G63 (DOHC 16V)	1997			0-N1127	TB [TE]
2.0, 2.0 16V EVO IX, 2.0 16V EVO VIII	12/03-	4G63 (DOHC 16V), 4G63 Turbo	1997			0-N060	TB [TE]
2.0, 2.0 16V EVO IX, 2.0 16V EVO VIII, 2.0 4x4	09/03-	4G63 (DOHC 16V), 4G63 Turbo	1997			0-N2010	TB [VD]
2.0, 2.0 GDi	08/03-04/06	4G94, 4G94 (GDI)	1999			0-N2010	TB [VD]
2.4 iVRX	08/05-	4G69	2378			0-N1771	TB [BT]
2.4 iVRX	08/05-	4G69	2378			0-N2010	TB [VD]
2.4 iVRX	08/05-	4G69	2378			0-N2255	TB [DG]
2.0	09/03-	4G63 (DOHC 16V)	1997	01/2004 →		0-N1984	VB [DG]
2.0, 2.0 16V EVO IX, 2.0 16V EVO VIII, 2.0 4x4	09/03-	4G63 (DOHC 16V), 4G63 Turbo	1997			0-N2105	VB [BT] S
2.0, 2.0 16V EVO IX, 2.0 16V EVO VIII, 2.0 4x4	12/03-	4G63 (DOHC 16V), 4G63 Turbo	1997			0-N1984	VB [DG]
2.0 16V EVO VIII	03/04-	4G63 Turbo	1997			0-N2259	VB [BT]
2.0, 2.0 GDi	08/03-04/06	4G94, 4G94 (GDI)	1999			0-N1984	VB [DG]
2.0, 2.0 GDi	08/03-04/06	4G94, 4G94 (GDI)	1999			0-N2105	VB [BT] S
2.4 iVRX	08/05-	4G69	2378			0-N1984	VB [DG]



OPTIMAL[®]

MITSUBISHI



CM³



Art. Nr.



LANCER Stufenheck (CS_A, CT0)									
2.4 iVRX	08/05-	4G69	2378			0-N2105	VB [BT]	S	
LANCER Station Wagon (CV_1)									
1.5	09/08-	HR15DE	1498			0-N2240	VB [DG]		
1.6 4WD	09/08-	HR16DE	1598			0-N2240	VB [DG]		
MAGNA Stufenheck (TS)									
3.0 i	02/94-04/96	6G72 (DOHC 24V), 6G72 (SOHC 24V)	2972			0-N185	TB [TE]		
3.0 i	02/94-04/96	6G72 (DOHC 24V), 6G72 (SOHC 24V)	2972			0-N189	TB [DG]		
3.0 i	02/94-04/96	6G72 (DOHC 24V), 6G72 (SOHC 24V)	2972			0-N1521	VB [DG]		
MAGNA Station Wagon (TE)									
3.0 i	04/96-06/97	6G72 (SOHC 24V)	2972			0-N185	TB [TE]		
3.0 i	04/96-06/97	6G72 (SOHC 24V)	2972			0-N189	TB [DG]		
3.0 i	04/96-06/97	6G72 (SOHC 24V)	2972			0-N1521	VB [DG]		
MAGNA Stufenheck (TE)									
3.0 i	04/96-06/97	6G72 (SOHC 24V)	2972			0-N185	TB [TE]		
3.0 i	04/96-06/97	6G72 (SOHC 24V)	2972			0-N189	TB [DG]		
3.5	04/96-06/97	6G74 (DOHC 24V)	3497			0-N185	TB [TE]		
3.0 i	04/96-06/97	6G72 (SOHC 24V)	2972			0-N1521	VB [DG]		
MAGNA Station Wagon (TF)									
3.0 GDi	06/98-03/99	6G72 (DOHC 24V)	2972			0-N185	TB [TE]		
3.0 GDi	06/98-03/99	6G72 (DOHC 24V)	2972			0-N189	TB [DG]		
3.0 GDi	06/98-03/99	6G72 (DOHC 24V)	2972			0-N1521	VB [DG]		
MAGNA Station Wagon (TH)									
3.0 GDi	06/99-08/00	6G72 (DOHC 24V)	2972			0-N185	TB [TE]		
3.0 GDi	06/99-08/00	6G72 (DOHC 24V)	2972			0-N189	TB [DG]		
3.5, 3.5 4x4	03/99-08/00	6G74 (SOHC 24V)	3497			0-N185	TB [TE]		
3.0 GDi	06/99-08/00	6G72 (DOHC 24V)	2972			0-N1521	VB [DG]		
MAGNA Stufenheck (TH)									
3.5 i	03/99-08/00	6G74 (SOHC 24V)	3497			0-N185	TB [TE]		
MAGNA Station Wagon (TJ)									
3.5 i, 3.5 i 4x4, 3.5 i Sport	08/00-05/03	6G74 (SOHC 24V)	3497			0-N185	TB [TE]		
MAGNA Stufenheck (TJ)									
3.0	08/00-05/03	6G72 (SOHC 24V)	2972			0-N185	TB [TE]		
3.0	08/00-05/03	6G72 (SOHC 24V)	2972			0-N189	TB [DG]		
3.5 i, 3.5 i Allrad, 3.5 i Series II Raliant, 3.5 Series II Sports VR-X	08/00-05/03	6G74 (SOHC 24V)	3497			0-N185	TB [TE]		
3.0	08/00-05/03	6G72 (SOHC 24V)	2972			0-N1521	VB [DG]		
MAGNA Station Wagon									
3.5, 3.5 i	06/03-07/05	6G74 (SOHC 24V)	3497			0-N185	TB [TE]		
MAGNA Stufenheck (TW)									
3.5, 3.5 i Allrad	06/03-07/05	6G74 (SOHC 24V)	3497			0-N185	TB [TE]		
MIRAGE II Schrägheck (C10)									
1.2	10/83-01/88	4G16	1198	19.05x92; → 05/1986		SK-1317	BTK		
1.6 Turbo	10/83-01/88	G32BT	1597	19.05x120; 01/1987 →		SK-1321	BTK		
MIRAGE Station Wagon									
1.8 GS 4WD	02/86-01/88	G37B	1755	19.05x120; 01/1987 →		SK-1321	BTK		
MIRAGE III Schrägheck (C5_ - C8_)									
1.3	05/88-11/91	4G13 (12V), 4G13 (8V)	1298	22x92; 06/1990 →		SK-1234	BTK		
1.3 GS	07/90-11/91	4G13 (12V), 4G13 (8V)	1298	22x92		SK-1234	BTK		
1.3 GS	07/90-11/91	4G13 (12V), 4G13 (8V)	1298			0-N987	TB [TE]		
MIRAGE III Stufenheck (C5_ - C8_)									
1.3 12V	07/90-11/91	4G13 (12V)	1298			0-N987	TB [TE]		
MIRAGE Coupe									
1.3	12/91-08/95	4G13 (12V)	1298	22x92		SK-1234	BTK		
1.3	12/91-08/95	4G13 (12V)	1298			0-N987	TB [TE]		
MIRAGE Schrägheck (CJ_A, CL_A)									
1.3	12/91-07/03	4G13 (12V)	1298	22x92		SK-1234	BTK		
1.6, 1.6 Allrad	12/91-07/03	4G92 (SOHC 16V)	1597	29x117		SK-1314	BTK		
1.3	12/91-08/95	4G13 (12V)	1298			0-N987	TB [TE]		



CM³



Art. Nr.



MIRAGE Stufenheck							
1.3	12/91-08/95	4G13 (12V)	1298	22x92		SK-1234	BTK
1.3	12/91-08/95	4G13 (12V)	1298			0-N987	TB [TE]
MIRAGE V Coupe (CJ - CM)							
1.5	09/95-08/99	4G15 (16V), 4G15 (16V)	1468			0-N1129	TB [TE]
MONTERO [USA] Sport Utility							
3.8 4WD	01/06-12/06		3828			0-N185	TB [TE]
MIRAGE Stufenheck (CK_A)							
1.5	09/95-08/99	4G15 (12V), 4G15 (12V), 4G15 (16V)	1468			0-N1129	TB [TE]
1.8 Allrad	09/95-08/99	4G93T	1834			0-N056	TB [TE]
MIRAGE Schrägheck (CJ_A)							
1.3	09/95-07/03	4G13 (12V)	1298	22x92		SK-1234	BTK
1.3	09/95-07/03	4G13 (12V)	1298			0-N1129	TB [TE]
1.5	09/95-08/99	4G15 (12V), 4G15 (16V)	1468			0-N1129	TB [TE]
OUTLANDER [USA] Sport Utility							
2.4	01/05-12/06		2378			0-N1771	TB [BT]
2.4	01/05-12/06		2378			0-N2010	TB [VD]
2.4	01/05-12/06		2378			0-N2255	TB [DG]
2.4	01/05-12/06		2378			0-N1984	VB [DG]
OUTLANDER I (CU_W)							
2.4 4WD	05/03-10/06	4G69	2378	12.7x65; 20x122; Baumuster: Airtrek		SK-1744	BTK
2.4 4WD	05/03-10/06	4G69	2378	12.7x65; 20x122; mit Spanndämpfer, Spannrolle; Baumuster: Airtrek		SK-1745	BTK
2.4 4WD, 2.4 HDD Mivec	03/01-12/06	4G69	2378	12.7x65; 20x122		SK-1744	BTK
2.4 4WD, 2.4 HDD Mivec	03/01-12/06	4G69	2378	12.7x65; 20x122; mit Spanndämpfer, Spannrolle		SK-1745	BTK
2.0, 2.0 4WD, 2.0 Turbo 4WD	01/02-10/06	4G63 (DOHC 16V), 4G63 T (DOHC 16V), 4G63 Turbo	1997			0-N060	TB [TE]
2.0, 2.0 4WD, 2.0 Turbo 4WD	05/03-10/06	4G63 (DOHC 16V), 4G63 T (DOHC 16V)	1997			0-N1127	TB [TE]
2.0, 2.0 4WD, 2.0 Turbo 4WD	01/02-10/06	4G63 (DOHC 16V), 4G63 T (DOHC 16V), 4G63 Turbo	1997			0-N055	TB [DG]
2.0, 2.0 4WD, 2.0 Turbo 4WD	01/02-10/06	4G63 (DOHC 16V), 4G63 T (DOHC 16V), 4G63 Turbo	1997			0-N2010	TB [VD]
2.4 4WD	05/03-10/06	4G64 (SOHC 16V)	2351			0-N060	TB [TE]
2.4 4WD	05/03-10/06	4G69	2378			0-N1127	TB [TE]
2.4 4WD	05/03-10/06	4G64 (SOHC 16V)	2351	09/2003 → 12/2008		0-N1771	TB [BT]
2.4 4WD	05/03-10/06	4G69	2378	09/2003 → 12/2008		0-N1771	TB [BT]
2.4 4WD	11/03-10/06	4G69	2378	→ 12/2008		0-N1771	TB [BT]
2.4 4WD, 2.4 HDD Mivec	03/01-12/06	4G69	2378			0-N2010	TB [VD]
2.4 4WD, 2.4 HDD Mivec	03/01-12/06	4G69	2378			0-N2255	TB [DG]
2.4 HDD Mivec	03/01-12/06	4G69	2378			0-N1771	TB [BT]
2.0, 2.0 4WD, 2.0 Turbo 4WD	01/02-10/06	4G63 (DOHC 16V), 4G63 T (DOHC 16V), 4G63 Turbo	1997			0-N1984	VB [DG]
2.0, 2.0 4WD, 2.0 Turbo 4WD	01/02-10/06	4G63 (DOHC 16V), 4G63 T (DOHC 16V), 4G63 Turbo	1997			0-N2105	VB [BT] S
2.4 4WD	05/03-10/06	4G64 (SOHC 16V)	2351			0-N1984	VB [DG]
2.4 4WD, 2.4 HDD Mivec	03/01-12/06	4G69	2378			0-N1984	VB [DG]
2.4 4WD, 2.4 HDD Mivec	03/01-12/06	4G69	2378			0-N2105	VB [BT] S
OUTLANDER II (CW_W)							
2.0 DI-D	02/07-11/12	BSY	1968	30x141; → 06/2010; mit Zubehör		SK-1595	BTK
2.0 DI-D	02/07-11/12	BSY	1968	30x141; mit Zubehör		SK-1595AQ1	BTKW
2.2 DI-D 4WD	08/07-11/12	4HK, 4HN	2179	25.4x118		SK-1692	BTK
2.2 DI-D 4WD	08/07-11/12	4HK, 4HN	2179	25.4x118		SK-1692AQ1	BTKW
2.0 DI-D	02/07-11/12	BSY	1968			0-N1046	TB [DG]
2.0 DI-D	02/07-11/12	BSY	1968			0-N1335	TB [TE]
2.0 DI-D	02/07-11/12	BSY	1968			0-N1336	TB [DG]
2.2 DI-D 4WD	08/07-11/12	4HK, 4HN	2179			0-N1334	TB [DG]
2.2 DI-D 4WD	08/07-11/12	4HK, 4HN	2179			0-N2018	TB [BT]
3.0 4x4, 3.0 AWD, 3.0 FWD	11/06-11/12	6B31	2998			0-N2384	TB [DG]
2.0 DI-D	02/07-11/12	BSY	1968			0-N2364	VB [DG]
2.0 DI-D	02/07-11/12	BSY	1968			0-N2397	VB [BT] S
2.0, 2.0 4WD	11/06-11/12	4B11	1998			0-N2048	VB [DG]
2.0, 2.0 4WD	11/06-11/12	4B11	1998			0-N2112	VB [BT] S
2.2 DI-D, 2.2 DI-D 4WD	11/06-11/12	4N14	2268			0-N2019	VB [DG]
2.4	11/06-11/12	4B12	2359			0-N2048	VB [DG]
2.4	11/06-11/12	4B12	2359			0-N2112	VB [BT] S



OPTIMAL®

MITSUBISHI



CM³



Art. Nr.



ohne Halter

OUTLANDER II (CW_W)

2.4 Flex 4WD, 2.4 Mivec 4WD	09/07-11/12	4B12	2360		0-N2048	VB [DG]	
2.4 Flex 4WD, 2.4 Mivec 4WD	09/07-11/12	4B12	2360		0-N2112	VB [BT]	S
3.0 4x4	11/06-11/12	6B31	2998		0-N2081	VB [BT]	S
3.0 4x4, 3.0 AWD, 3.0 FWD	11/06-11/12	6B31	2998		0-N2365	VB [DG]	

OUTLANDER II Van (CW_W)

2.0 DI-D	12/06-11/12	BSY	1968	30x141; mit Zubehör	SK-1595AQ1	BTKW	
2.0 DI-D	12/06-11/12	BSY	1968		0-N1046	TB [DG]	
2.0 DI-D	12/06-11/12	BSY	1968		0-N1335	TB [TE]	
2.0 DI-D	12/06-11/12	BSY	1968		0-N1336	TB [DG]	
2.0 DI-D	12/06-11/12	BSY	1968		0-N2364	VB [DG]	
2.0 DI-D	12/06-11/12	BSY	1968		0-N2397	VB [BT]	S

OUTLANDER III (GG_W, GF_W, ZJ)

2.0, 2.0 4WD	08/12-	4J11	1998		0-N2294	VB [DG]	
2.0, 2.0 4WD	08/12-	4J11	1998		0-N2354	VB [DG]	
2.4 4WD	10/12-	4J12	2359		0-N2294	VB [DG]	
2.4 4WD	10/12-	4J12	2359		0-N2354	VB [DG]	

PAJERO CLASSIC (V2_W)

2.5 TD	07/02-	4D56 T	2477	25.4x163; 19x99; → 01/2007	SK-1306	BTK	
2.5 TD	07/02-	4D56 T	2477		0-N061	TB [TE]	
2.5 TD	07/02-	4D56 T	2477		0-N184	TB [TE]	
3.0, 3.0 ZR	08/03-	6G72 (DOHC 24V), 6G72 (SOHC 24V)	2972		0-N185	TB [TE]	
3.0, 3.0 ZR	08/03-	6G72 (DOHC 24V), 6G72 (SOHC 24V)	2972		0-N189	TB [DG]	
3.8, 3.8 GDi, 3.8 GDi 2WD	06/02-08/06	6G75	3828		0-N185	TB [TE]	
3.8, 3.8 GDi, 3.8 GDi 2WD	06/02-08/06	6G75	3828		0-N189	TB [DG]	
3.0, 3.0 ZR	08/03-	6G72 (DOHC 24V), 6G72 (SOHC 24V)	2972		0-N1521	VB [DG]	
3.8, 3.8 GDi, 3.8 GDi 2WD	06/02-08/06	6G75	3828		0-N1521	VB [DG]	

PAJERO I (L04_G, L14_G)

2.0 4x4	01/83-02/91	G63B	1997	25.4x149; 10/1984 →	SK-1308	BTK	
2.3 D	10/84-09/86	4D55	2346	25x163; 19x83	SK-1236	BTK	
2.5 TD	11/89-12/91	4D56 T	2477	25x163; 19x83	SK-1236	BTK	
3.0 V6	11/88-11/90	6G72 (SOHC 12V)	2972	25.4x149	SK-1308	BTK	
2.3 D	10/84-09/86	4D55	2346		0-N061	TB [TE]	
2.3 D	10/84-09/86	4D55	2346		0-N184	TB [TE]	
2.5 TD, 2.5 TD 4x4	10/86-12/91	4D56 T	2477		0-N061	TB [TE]	
2.5 TD, 2.5 TD 4x4	10/86-12/91	4D56 T	2477		0-N184	TB [TE]	
3.0 V6	11/88-11/90	6G72 (SOHC 12V)	2972		0-N064	TB [TE]	
3.0 i 4x4, 3.0 V6	05/88-05/91	6G72 (SOHC 12V)	2972		0-N1521	VB [DG]	

PAJERO I Canvas Top (L04_G)

2.3 TD	12/82-04/86	4D55 T	2347	25x163; 19x83	SK-1236	BTK	
2.5 TD	05/86-11/90	4D56 T	2477	25x163; 19x83	SK-1236	BTK	
2.3 TD	12/82-04/86	4D55 T	2347		0-N061	TB [TE]	
2.3 TD	12/82-04/86	4D55 T	2347		0-N184	TB [TE]	
2.5 TD	05/86-11/90	4D56 T	2477		0-N061	TB [TE]	
2.5 TD	05/86-11/90	4D56 T	2477		0-N184	TB [TE]	

PAJERO II (V3_W, V2_W, V4_W)

2.4	04/91-10/99	4G64 (12V)	2351	12x55; 19x123; → 04/1992	SK-1237	BTK	
2.4	04/91-10/99	4G64 (12V)	2351	19x123; → 04/1992	SK-1237S	BTK	
2.4	04/91-10/99	4G64 (12V)	2351	12.7x65; 05/1992 →	SK-1649	BTK	
2.5 TD 4x4	12/90-10/99	4D56 TD	2477	25x163; 19x83; → 10/1993	SK-1236	BTK	
2.5 TD 4x4	12/90-10/99	4D56 TD	2477	25.4x163; 19x99; 11/1993 →	SK-1306	BTK	
3.0 V6 4x4	12/90-12/95	6G72 (SOHC 12V)	2972	25.4x149	SK-1308	BTK	
2.4	04/91-10/99	4G64 (12V)	2351		0-N059	TB [TE]	
2.4	04/91-10/99	4G64 (12V)	2351	05/1992 →	0-N179	TB [TE]	
2.4	04/91-10/99	4G64 (12V)	2351	→ 04/1992	0-N186	TB [TE]	
2.5 TD 4x4, 2.5 TDiC 2WD	12/90-10/99	4D56 T, 4D56 TD	2477		0-N061	TB [TE]	
2.5 TD 4x4, 2.5 TDiC 2WD	12/90-10/99	4D56 T, 4D56 TD	2477		0-N184	TB [TE]	
3.0 V6 24V	06/94-10/99	6G72 (SOHC 24V)	2972		0-N185	TB [TE]	
3.0 V6 24V	06/94-10/99	6G72 (SOHC 24V)	2972		0-N189	TB [DG]	
3.0 V6 4x4	12/90-12/95	6G72 (SOHC 12V)	2972		0-N064	TB [TE]	
3.5 V6 24V	06/94-10/99	6G74 (DOHC 24V), 6G74 (SOHC 24V)	3497		0-N185	TB [TE]	
3.5 V6 24V	06/94-10/99	6G74 (DOHC 24V), 6G74 (SOHC 24V)	3497		0-N189	TB [DG]	
3.5 V6 24V	06/94-10/99	6G74 (DOHC 24V), 6G74 (SOHC 24V)	3497		0-N2163	TB [BT]	
3.0 V6 24V, 3.0 V6 4x4	12/90-10/99	6G72 (SOHC 12V), 6G72 (SOHC 24V)	2972		0-N1521	VB [DG]	



CM³



Art. Nr.



PAJERO II (V3_W, V2_W, V4_W)							
3.5 V6 24V	06/94-10/99	6G74 (DOHC 24V), 6G74 (SOHC 24V)	3497			0-N1521	VB [DG]
PAJERO II Canvas Top (V2_W, V4_W)							
2.4	04/91-04/00	4G64 (12V)	2351	12x55; 19x123; → 04/1992		SK-1237	BTK
2.4	04/91-04/00	4G64 (12V)	2351	19x123; → 04/1992		SK-1237S	BTK
2.4	04/91-04/00	4G64 (12V)	2351	12.7x65; 05/1992 →		SK-1649	BTK
2.5 TD	12/90-04/00	4D56 TD	2477	25x163; 19x83; → 10/1993		SK-1236	BTK
2.5 TD	12/90-04/00	4D56 TD	2477	25.4x163; 19x99; 11/1993 →		SK-1306	BTK
3.0 V6	12/90-12/95	6G72 (SOHC 12V)	2972	25.4x149		SK-1308	BTK
1.8 GDI	06/98-04/00	4G93 (GDI)	1834			0-N055	TB [DG]
1.8 GDI	06/98-04/00	4G93 (GDI)	1834			0-N056	TB [TE]
1.8 GDI	06/98-04/00	4G93 (GDI)	1834			0-N182	TB [TE]
2.4	04/91-04/00	4G64 (12V)	2351			0-N059	TB [TE]
2.4	04/91-04/00	4G64 (12V)	2351	05/1992 →		0-N179	TB [TE]
2.4	04/91-04/00	4G64 (12V)	2351	→ 04/1992		0-N186	TB [TE]
2.5 TD , 2.5 TDiC 2WD	12/90-04/00	4D56 T, 4D56 TD	2477			0-N061	TB [TE]
2.5 TD , 2.5 TDiC 2WD	12/90-04/00	4D56 T, 4D56 TD	2477			0-N184	TB [TE]
3.0 V6	12/90-12/95	6G72 (SOHC 12V)	2972			0-N064	TB [TE]
3.0 V6 24V	06/94-04/00	6G72 (SOHC 24V)	2972			0-N185	TB [TE]
3.0 V6 24V	06/94-04/00	6G72 (SOHC 24V)	2972			0-N189	TB [DG]
1.8 GDI	06/98-04/00	4G93 (GDI)	1834	✳		0-N1521	VB [DG]
3.0 V6 , 3.0 V6 24V	12/90-04/00	6G72 (SOHC 12V), 6G72 (SOHC 24V)	2972			0-N1521	VB [DG]
PAJERO III (V7_W, V6_W)							
2.5 TDi	04/00-12/06	4D56 T	2477	25.4x163; 19x99		SK-1306	BTK
3.5 4x4	04/00-01/07	6G74 (DOHC 24V)	3497			0-N185	TB [TE]
3.5 4x4	04/00-01/07	6G74 (DOHC 24V)	3497			0-N189	TB [DG]
3.5 4x4	04/00-01/07	6G74 (DOHC 24V)	3497			0-N2163	TB [BT]
3.5 4x4	04/00-01/07	6G74 (DOHC 24V)	3497			0-N1521	VB [DG]
PAJERO III Geländewagen offen (V6_W, V7_W)							
2.5 TDi	04/00-12/06	4D56 T	2477	25.4x163; 19x99; → 08/2001		SK-1306	BTK
2.5 TDi	09/01-12/06	4D56 T	2477	25.4x163; 19x99; → 01/2007		SK-1306	BTK
2.5 TDi	04/00-12/06	4D56 T	2477			0-N061	TB [TE]
2.5 TDi	04/00-12/06	4D56 T	2477			0-N184	TB [TE]
3.0	10/01-12/06	6G72 (SOHC 24V)	2972			0-N185	TB [TE]
3.0	10/01-12/06	6G72 (SOHC 24V)	2972			0-N189	TB [DG]
3.5 i, 3.5 V6 GDI	04/00-12/06	6G74 (DOHC 24V), 6G74 (SOHC 24V), 6G74 (GDI), 6G74 (SOHC 24V)	3497			0-N185	TB [TE]
3.5 i, 3.5 V6 GDI	04/00-12/06	6G74 (DOHC 24V), 6G74 (SOHC 24V), 6G74 (GDI), 6G74 (SOHC 24V)	3497			0-N189	TB [DG]
3.0	10/01-12/06	6G72 (SOHC 24V)	2972			0-N1521	VB [DG]
3.5 i, 3.5 V6 GDI	04/00-12/06	6G74 (DOHC 24V), 6G74 (SOHC 24V), 6G74 (GDI), 6G74 (SOHC 24V)	3497			0-N1521	VB [DG]
3.5 V6 GDI	04/00-12/06	6G74 (GDI), 6G74 (SOHC 24V)	3497	→ 08/2006; Baumuster: V65W, V75W		0-N1866	VB [BT]
PAJERO IV (V8_W, V9_W)							
3.8 V6	02/07-	6G75	3828	32x201; Baumuster: Montero		SK-1735	BTK
3.8 V6	02/07-	6G75	3828	32x201; Baumuster: Pajero		SK-1735	BTK
3.8 V6	02/07-	6G75	3828	32x201; Baumuster: Shogun		SK-1735	BTK
3.8 V6	02/10-	6G75	3828	32x201		SK-1735	BTK
3.0 4x4	02/07-	6G72 (SOHC 24V)	2972			0-N185	TB [TE]
3.0 4x4	02/07-	6G72 (SOHC 24V)	2972			0-N189	TB [DG]
3.8 V6	02/07-	6G75	3828			0-N185	TB [TE]
3.8 V6	02/07-	6G75	3828			0-N189	TB [DG]
3.0 4x4	02/07-	6G72 (SOHC 24V)	2972			0-N1521	VB [DG]
3.8 V6	02/07-	6G75	3828			0-N1521	VB [DG]
3.8 V6	02/07-	6G75	3828	→ 10/2009; Baumuster: V87W, V97W		0-N1866	VB [BT]
3.8 V6	02/10-	6G75	3828	Baumuster: V87W, V97W		0-N1866	VB [BT]
PAJERO PININ (H6_W, H7_W)							
1.8	11/01-06/07	4G93 (SOHC 16V)	1834	29x116; Baumuster: Montero I.O		SK-1458	BTK
1.8	11/01-06/07	4G93 (SOHC 16V)	1834	29x116; Baumuster: Pajero Pinin		SK-1458	BTK
1.8	11/01-06/07	4G93 (SOHC 16V)	1834	29x116; Nockenwelle: SOHC/OHC; Baumuster: Pajero Pinin		SK-1458	BTK
1.8	11/01-06/07	4G93 (SOHC 16V)	1834	29x116; Nockenwelle: SOHC/OHC; Baumuster: Shogun Pinin		SK-1458	BTK
1.8	11/01-06/07	4G93 (SOHC 16V)	1834	29x116; Baumuster: Shogun Pinin		SK-1458AQ1	BTKW
1.8	11/01-06/07	4G93 (SOHC 16V)	1834	29x116; Nockenwelle: SOHC/OHC; Baumuster: Pajero Pinin		SK-1458AQ1	BTKW



OPTIMAL[®]

MITSUBISHI



CM³



Art. Nr.



PAJERO PININ (H6_W, H7_W)

1.8, 1.8 GDI	10/99-06/07	4G93 (GDI), 4G93 (SOHC 16V)	1834	29x154; Baumuster: Shogun Pinin	SK-1325AQ2	BTKW	
1.8, 1.8 GDI	10/99-06/07	4G93 (GDI), 4G93 (SOHC 16V)	1834	29x116; Baumuster: Pajero I.O	SK-1458	BTK	
1.8 GDI	10/99-10/01	4G93 (GDI)	1834	29x154; Baumuster: I.O	SK-1325	BTK	
1.8 GDI	10/99-10/01	4G93 (GDI)	1834	29x154; Baumuster: Montero I.O	SK-1325	BTK	
1.8 GDI	10/99-10/01	4G93 (GDI)	1834	29x154; Baumuster: Pajero Pinin	SK-1325	BTK	
1.8 GDI	10/99-10/01	4G93 (GDI)	1834	29x154; Baumuster: Shogun Pinin	SK-1325	BTK	
1.8 GDI	10/99-10/01	4G93 (GDI)	1834	29x154; Baumuster: I.O	SK-1325AQ2	BTKW	
1.8 GDI	10/99-10/01	4G93 (GDI)	1834	29x154; Baumuster: Montero I.O	SK-1325AQ2	BTKW	
1.8 GDI	10/99-10/01	4G93 (GDI)	1834	29x154; Baumuster: Pajero Pinin	SK-1325AQ2	BTKW	
1.8, 1.8 GDI	10/99-06/07	4G93 (GDI), 4G93 (SOHC 16V)	1834		0-N055	TB [DG]	
1.8, 1.8 GDI	10/99-06/07	4G93 (GDI), 4G93 (SOHC 16V)	1834		0-N056	TB [TE]	
1.8, 1.8 GDI	10/99-06/07	4G93 (GDI), 4G93 (SOHC 16V)	1834		0-N182	TB [TE]	
2.0 GDI	10/00-06/07	4G94 (GDI)	1999		0-N056	TB [TE]	
2.0 GDI	10/00-06/07	4G94 (GDI)	1999	→ 01/2004; Baumuster: H67W	0-N1130	TB [DG]	
1.8	11/01-06/07	4G93 (SOHC 16V)	1834	→ 02/2005; Länderausführung Europa, USA; Baumuster: H66W; für Fahrzeuge mit Servolenkung,	0-N2036	VB [TE]	
1.8, 1.8 GDI	10/99-06/07	4G93 (GDI), 4G93 (SOHC 16V)	1834		0-N1521	VB [DG]	
1.8 GDI	10/99-10/01	4G93 (GDI)	1834	09/2001 → 02/2005; Länderausführung Europa, USA; für Fahrzeuge mit Servolenkung,	0-N2036	VB [TE]	
2.0 GDI	10/00-06/07	4G94 (GDI)	1999		0-N1521	VB [DG]	

PAJERO SPORT (K90)

2.5 TD	11/98-	4D56 T	2477	25.4x163; 19x99; → 02/2009	SK-1306	BTK	
1.8 Allrad, 1.8 GDI Allrad	05/99-02/05	4G93 (GDI), 4G93 (SOHC 16V)	1834		0-N055	TB [DG]	
1.8 Allrad, 1.8 GDI Allrad	05/99-02/05	4G93 (GDI), 4G93 (SOHC 16V)	1834		0-N056	TB [TE]	
1.8 Allrad, 1.8 GDI Allrad	05/99-02/05	4G93 (GDI), 4G93 (SOHC 16V)	1834		0-N182	TB [TE]	
2.4	09/99-09/01	4G64 (12V)	2351		0-N061	TB [TE]	
2.4	09/99-09/01	4G64 (12V)	2351		0-N184	TB [TE]	
2.5 TD, 2.5 TD Allrad	11/97-10/98	4D56 T	2477		0-N061	TB [TE]	
2.5 TD, 2.5 TD Allrad	11/97-10/98	4D56 T	2477		0-N184	TB [TE]	
3.0 V6	11/98-	6G72 (DOHC 24V), 6G72 (SOHC 24V)	2972		0-N185	TB [TE]	
3.0 V6	11/98-	6G72 (DOHC 24V), 6G72 (SOHC 24V)	2972		0-N189	TB [DG]	
1.8 Allrad, 1.8 GDI Allrad	05/99-02/05	4G93 (GDI), 4G93 (SOHC 16V)	1834		0-N1521	VB [DG]	
2.0 GDI Allrad	10/01-02/05	4G94 (GDI)	1999		0-N2105	VB [BT]	S
3.0 V6	11/98-	6G72 (DOHC 24V), 6G72 (SOHC 24V)	2972		0-N1521	VB [DG]	
3.0 V6	11/98-	6G72 (SOHC 24V)	2972		0-N2305	VB [TE]	

PAJERO SPORT VAN (K90)

2.5 TD	12/99-01/08	4D56 T	2477	25.4x163; 19x99	SK-1306	BTK	
2.5 TD	12/99-01/08	4D56 T	2477		0-N061	TB [TE]	
2.5 TD	12/99-01/08	4D56 T	2477		0-N184	TB [TE]	
3.0 V6	12/99-01/08	6G72 (DOHC 24V)	2972		0-N185	TB [TE]	
3.0 V6	12/99-01/08	6G72 (DOHC 24V)	2972		0-N189	TB [DG]	
3.0 V6	12/99-01/08	6G72 (DOHC 24V)	2972		0-N1521	VB [DG]	

PAJERO SPORT II (KH_, KG_)

2.5 DI-D 4x4	07/08-	4D56 HP	2477	25.4x154; 19x99; ohne Spanndämpfer, Spannrolle	SK-1736	BTK	
2.5 DI-D 4x4	07/08-	4D56 HP	2477	25.4x154; 19x99; mit Spanndämpfer, Spannrolle	SK-1737	BTK	
2.5 DI-D, 2.5 DI-D 4x4	07/08-	4D56 HP	2477		0-N1772	TB [BT]	
2.5 DI-D, 2.5 DI-D 4x4	07/08-	4D56 HP	2477		0-N184	TB [TE]	
2.5 DI-D, 2.5 DI-D 4x4	07/08-	4D56 HP	2477		0-N2161	TB [TE]	S
2.5 DI-D, 2.5 DI-D 4x4, 2.5 TD	07/08-	4D56 HP, 4D56 T	2477		0-N2012	TB [VD]	
3.0 4WD	09/08-	6B31	2998		0-N2384	TB [DG]	
3.5, 3.5 V6 24V	09/08-	6G74 (SOHC 24V), 6G74 (SOHC 24V), 6G74 (SOHC 24V)	3497		0-N185	TB [TE]	
2.5 DI-D, 2.5 DI-D 4x4, 2.5 TD	07/08-	4D56 HP, 4D56 T	2477		0-N2270	VB [BT]	S

PROUDIA/DIGNITY (S4_A, S3_A)

3.5 24V	10/99-05/01	6G74 (DOHC 24V)	3497		0-N185	TB [TE]	
---------	-------------	-----------------	------	--	--------	---------	--

SANTAMO

2.0 16V, 2.0 16V 4x4	05/99-12/04	4G63 (DOHC 16V)	1997		0-N054	TB [TE]	
2.0 16V, 2.0 16V 4x4	05/99-12/04	4G63 (DOHC 16V)	1997		0-N055	TB [DG]	
2.0 16V, 2.0 16V 4x4	05/99-12/04	4G63 (DOHC 16V)	1997		0-N179	TB [TE]	
2.0 16V, 2.0 16V 4x4	05/99-12/04	4G63 (DOHC 16V)	1997		0-N1971	TB [BT]	



CM³



Art. Nr.



SAPPORO I (A12_)							
1.6 SL, GL	04/78-07/80	4G32	1597			0-N051	TB [TE]
1.6 SL, GL	04/78-07/80	4G32	1597			0-N188	TB [TE]
SAPPORO II (A16_A)							
2.0 GSL	08/80-08/83	4G63 (SOHC 8V)	1997	19x122; 09/1981 →		SK-1240S	BTK
2.0 GSL	08/80-08/83	4G63 (SOHC 8V)	1997	19x122; 08/1981 →		SK-1309S	BTK
2.0 GSR	08/80-09/84	4G63 (SOHC 8V)	1995	19x122; 08/1981 →		SK-1240S	BTK
2.0 GSR	08/80-09/84	4G63 (SOHC 8V)	1995	19x122; 08/1981 → 09/1983		SK-1309S	BTK
2.0 Turbo ECi	08/82-08/83	4G63 T (ECI)	1997	19x122		SK-1240S	BTK
2.0 Turbo ECi	08/82-08/83	4G63 T (ECI)	1997	19x122		SK-1309S	BTK
1.6 GLX	08/80-09/84	4G32	1597			0-N051	TB [TE]
1.6 GLX	08/80-09/84	4G32	1597			0-N188	TB [TE]
2.0 GSL	08/80-08/83	4G63 (SOHC 8V)	1997	09/1981 →		0-N059	TB [TE]
2.0 GSL	08/80-08/83	4G63 (SOHC 8V)	1997	→ 08/1981		0-N062	TB [TE]
2.0 GSL, 2.0 Turbo ECi	08/80-08/83	4G63 (SOHC 8V), 4G63 T (ECI)	1997			0-N183	TB [TE]
2.0 GSR	08/80-09/84	4G63 (SOHC 8V)	1995	09/1981 →		0-N059	TB [TE]
2.0 GSR	08/80-09/84	4G63 (SOHC 8V)	1995	→ 08/1981		0-N062	TB [TE]
2.0 GSR	08/80-09/84	4G63 (SOHC 8V)	1995			0-N183	TB [TE]
2.0 Turbo ECi	08/82-08/83	4G63 T (ECI)	1997			0-N059	TB [TE]
SAPPORO III (E16A)							
2.4	06/87-08/90	4G64 (8V)	2351	12x55; 19x123		SK-1237	BTK
2.4	06/87-08/90	4G64 (8V)	2351	19x123		SK-1237S	BTK
2.4	06/87-08/90	4G64 (8V)	2351			0-N059	TB [TE]
2.4	06/87-08/90	4G64 (8V)	2351			0-N186	TB [TE]
SAVRIN							
2.0	01/01-12/04	4G63 (DOHC 16V)	1997			0-N2010	TB [VD]
2.4	06/04-	4G69	2378			0-N1771	TB [BT]
2.4	06/04-	4G69	2378			0-N2010	TB [VD]
2.4	06/04-	4G69	2378			0-N2255	TB [DG]
2.0	01/01-12/04	4G63 (DOHC 16V)	1997			0-N1984	VB [DG]
2.4	06/04-	4G69	2378			0-N1984	VB [DG]
SIGMA (F2_A, F1_A)							
3.0 V6	12/90-07/96	6G72 (SOHC 12V)	2972	25.4x149		SK-1308	BTK
3.0 V6	12/90-07/96	6G72 (SOHC 12V)	2972			0-N064	TB [TE]
3.0 V6	12/90-07/96	6G72 (DOHC 24V)	2972			0-N185	TB [TE]
3.0 V6	12/90-07/96	6G72 (DOHC 24V)	2972			0-N189	TB [DG]
3.0 V6	12/90-07/96	6G72 (DOHC 24V), 6G72 (SOHC 12V)	2972			0-N1521	VB [DG]
SPACE RUNNER (N1_W, N2_W)							
1.8, 1.8 4x4	10/91-08/99	4G93 (SOHC 16V)	1834	29x121		SK-1322	BTK
2.0 16V	06/97-08/99	4G63 (DOHC 16V)	1997	12.7x65; 29x123		SK-1323	BTK
2.0 TD	10/92-08/99	4D68 T	1998	12.7x65; 32x158; → 05/1996		SK-1463	BTK
2.0 TD	10/92-08/99	4D68 T	1998	12.7x65; → 05/1996		SK-1649	BTK
1.8, 1.8 4x4	10/91-08/99	4G93 (SOHC 16V)	1834			0-N052	TB [TE]
2.0 16V	06/97-08/99	4G63 (DOHC 16V)	1997			0-N055	TB [DG]
2.0 16V	06/97-08/99	4G63 (DOHC 16V)	1997			0-N060	TB [TE]
2.0 16V	06/97-08/99	4G63 (DOHC 16V)	1997			0-N179	TB [TE]
2.0 TD	10/92-08/99	4D68 T	1998			0-N058	TB [DG]
2.0 TD	10/92-08/99	4D68 T	1998			0-N065	TB [TE]
2.0 TD	10/92-08/99	4D68 T	1998			0-N1127	TB [TE]
2.0 TD	10/92-08/99	4D68 T	1998			0-N179	TB [TE]
SPACE RUNNER (N6_W)							
2.0	08/99-08/02	4G63 (DOHC 16V), 4G63 (SOHC 16V)	1997	12.7x65; 29x122		SK-1469	BTK
2.0	08/99-08/02	4G63 (DOHC 16V), 4G63 (SOHC 16V)	1997			0-N055	TB [DG]
2.0	08/99-08/02	4G63 (DOHC 16V), 4G63 (SOHC 16V), 4G63 (SOHC 16V)	1997			0-N060	TB [TE]
2.0	08/99-08/02	4G63 (DOHC 16V), 4G63 (SOHC 16V)	1997			0-N1127	TB [TE]
2.4 GDI	08/99-08/02	4G64 (GDI)	2351			0-N055	TB [DG]
2.4 GDI	08/99-08/02	4G64 (GDI)	2351			0-N060	TB [TE]
2.4 GDI	08/99-08/02	4G64 (GDI)	2351			0-N1127	TB [TE]
SIGMA Station Wagon (F0_W)							
3.0	06/92-10/96	6G72 (SOHC 12V)	2972	25.4x149		SK-1308	BTK
3.0	06/92-10/96	6G72 (SOHC 12V)	2972			0-N064	TB [TE]
3.0	06/92-10/96	6G72 (SOHC 12V)	2972			0-N1521	VB [DG]

CM³

Art. Nr.



SPACE STAR (DG_A)

1.3 16V	06/98-12/04	4G13 (16V)	1299	25x109	SK-1470	BTK	
1.6 16V	01/01-12/04	4G18	1584	25x109	SK-1470	BTK	
1.8 GDI , 1.8 MPI	06/98-12/04	4G93 (DOHC 16V), 4G93 (DOHC 16V), 4G93 (GDI)	1834	29x154	SK-1325	BTK	
1.8 GDI , 1.8 MPI	06/98-12/04	4G93 (DOHC 16V), 4G93 (DOHC 16V), 4G93 (GDI)	1834	29x154	SK-1325AQ2	BTKW	
1.9 DI-D	02/01-12/04	F9Q1, F9Q2	1870	26x132	SK-1493	BTK	
1.9 DI-D	02/01-12/04	F9Q1, F9Q2	1870	26x132	SK-1493AQ1	BTKW	
1.9 DI-D	02/01-12/04	F9Q1, F9Q2	1870	26x132	SK-1493AQ2	BTKW	
1.3 16V	06/98-12/04	4G13 (16V)	1299		0-N1129	TB [TE]	
1.3 16V	06/98-12/04	4G13 (16V)	1299	→ 11/1998	0-N181	TB [TE]	
1.6 16V	01/01-12/04	4G18	1584		0-N1129	TB [TE]	
1.8 GDI , 1.8 MPI	06/98-12/04	4G93 (DOHC 16V), 4G93 (DOHC 16V), 4G93 (GDI)	1834		0-N055	TB [DG]	
1.8 GDI , 1.8 MPI	06/98-12/04	4G93 (DOHC 16V), 4G93 (DOHC 16V), 4G93 (GDI)	1834		0-N056	TB [TE]	
1.8 MPI	10/02-12/04	4G93 (DOHC 16V), 4G93 (DOHC 16V)	1834		0-N182	TB [TE]	
1.9 DI-D	02/01-12/04	F9Q1, F9Q2	1870	mit Grundträger	0-N1173	TB [BT]	
1.8 GDI	06/98-12/04	4G93 (GDI)	1834	10/1998 → 12/2002; Länderausführung Europa, USA; für Fahrzeuge mit Servolenkung,	0-N2036	VB [TE]	
1.8 GDI , 1.8 MPI	06/98-12/04	4G93 (DOHC 16V), 4G93 (DOHC 16V), 4G93 (GDI)	1834		0-N1521	VB [DG]	
1.8 GDI , 1.8 MPI	06/98-12/04	4G93 (DOHC 16V), 4G93 (DOHC 16V), 4G93 (GDI)	1834	01/2003 →; Länderausführung Europa, USA; für Fahrzeuge mit Servolenkung,	0-N2036	VB [TE]	
1.8 MPI	10/02-12/04	4G93 (DOHC 16V), 4G93 (DOHC 16V)	1834	→ 12/2002; Länderausführung Europa, USA; für Fahrzeuge mit Servolenkung,	0-N2036	VB [TE]	
1.9 DI-D	02/01-12/04	F9Q1, F9Q2	1870		0-N1307	VB [DG]	
1.9 DI-D	02/01-12/04	F9Q1, F9Q2	1870		0-N1611	VB [BT]	S
1.9 DI-D	02/01-12/04	F9Q1, F9Q2	1870		0-N1802	VB [BT]	S

SPACE WAGON (D0_VW)

1.8 4x4 , 1.8 GLX	10/87-04/91	4G37, G37B	1755	19x122	SK-1309S	BTK	
1.8 GLX	01/84-12/88	4G37	1755	19x122; 01/1987 →	SK-1309S	BTK	
2.0 4x4 , 2.0 GLX , 2.0 GLX 4x4	03/85-04/91	4G63 (SOHC 8V), G63B	1997	12x55; 19x122; 05/1987 →	SK-1240	BTK	
2.0 4x4 , 2.0 GLX , 2.0 GLX 4x4 , 2.0 GLXi , 2.0 GLXi 4x4	03/85-04/91	4G63 (SOHC 8V), G63B	1997	19x122	SK-1240S	BTK	
2.0 GLXi , 2.0 GLXi 4x4	06/88-04/91	4G63 (SOHC 8V)	1997	12x55; 19x122	SK-1240	BTK	
1.8 4x4	10/87-08/88	4G37	1755		0-N053	TB [TE]	
1.8 4x4 , 1.8 GLX	01/84-12/88	4G37	1755		0-N188	TB [TE]	
1.8 GLX	01/84-12/88	4G37	1755	→ 12/1986	0-N051	TB [TE]	
1.8 GLX	01/84-12/88	4G37	1755	01/1987 →	0-N053	TB [TE]	
1.8 TD	06/86-04/91	4D65 T	1796		0-N058	TB [DG]	
1.8 TD	06/86-04/91	4D65 T	1796		0-N183	TB [TE]	
2.0 4x4 , 2.0 GLX , 2.0 GLX 4x4	03/85-04/91	4G63 (SOHC 8V), G63B	1997	→ 04/1987	0-N183	TB [TE]	
2.0 4x4 , 2.0 GLX , 2.0 GLX 4x4	03/85-04/91	4G63 (SOHC 8V), G63B	1997	05/1987 →	0-N186	TB [TE]	
2.0 4x4 , 2.0 GLX , 2.0 GLX 4x4 , 2.0 GLXi , 2.0 GLXi 4x4	03/85-04/91	4G63 (SOHC 8V), G63B	1997		0-N059	TB [TE]	
2.0 GLXi , 2.0 GLXi 4x4	06/88-04/91	4G63 (SOHC 8V)	1997		0-N186	TB [TE]	

SPACE WAGON (N3_W, N4_W)

1.8 , 1.8 4x4	10/91-10/98	4G93 (SOHC 16V)	1834	29x121	SK-1322	BTK	
2.0 , 2.0 4x4	10/92-10/98	4G63 (DOHC 16V), 4G63 (SOHC 16V), 4G63 (SOHC 16V), 4G63 (SOHC 16V)	1997	12.7x65; 29x123	SK-1323	BTK	
2.0 , 2.0 4x4	10/92-10/98	4G63 (DOHC 16V), 4G63 (SOHC 16V), 4G63 (SOHC 16V), 4G63 (SOHC 16V)	1997	12.7x65; → 08/1995	SK-1649	BTK	
2.0 TD	10/92-10/98	4D68 T	1998	12.7x65; 32x158	SK-1463	BTK	
2.0 TD	10/92-10/98	4D68 T	1998	12.7x65	SK-1649	BTK	
2.4 i	10/92-10/98	4G64 (SOHC 16V)	2351	12.7x65	SK-1649	BTK	
2.4 , 2.4 4x4	10/91-10/97	4G64 (SOHC 16V)	2351	12.7x65; 06/1992 → 08/1995	SK-1649	BTK	
1.8 , 1.8 4x4	10/91-10/98	4G93 (SOHC 16V)	1834		0-N052	TB [TE]	
1.8 TD	10/91-10/98	4D65 T	1796		0-N058	TB [DG]	
1.8 TD	10/91-10/98	4D65 T	1796		0-N183	TB [TE]	
2.0 , 2.0 4x4	10/92-10/98	4G63 (DOHC 16V), 4G63 (SOHC 16V), 4G63 (SOHC 16V), 4G63 (SOHC 16V)	1997		0-N055	TB [DG]	
2.0 , 2.0 4x4	10/92-10/98	4G63 (DOHC 16V), 4G63 (SOHC 16V), 4G63 (SOHC 16V), 4G63 (SOHC 16V)	1997		0-N060	TB [TE]	
2.0 , 2.0 4x4	10/92-10/98	4G63 (DOHC 16V), 4G63 (SOHC 16V), 4G63 (SOHC 16V), 4G63 (SOHC 16V)	1997		0-N1127	TB [TE]	
2.0 , 2.0 4x4	10/92-10/98	4G63 (DOHC 16V), 4G63 (SOHC 16V), 4G63 (SOHC 16V), 4G63 (SOHC 16V)	1997		0-N179	TB [TE]	



CM³



Art. Nr.



ohne Halter

SPACE WAGON (N3_W, N4_W)							
2.0 TD	10/92-10/98	4D68 T	1998			0-N058	TB [DG]
2.0 TD	10/92-10/98	4D68 T	1998			0-N065	TB [TE]
2.0 TD	10/92-10/98	4D68 T	1998			0-N179	TB [TE]
2.4 i	10/92-10/98	4G64 (SOHC 16V)	2351			0-N1127	TB [TE]
SPACE WAGON (N9_W, N8_W)							
2.0 GDI	10/98-12/04	4G63 (SOHC 16V)	1997	12.7x65; 29x122		SK-1469	BTK
2.0 GDI	10/98-12/04	4G63 (SOHC 16V)	1997			0-N1127	TB [TE]
2.4 GDI, 2.4 GDI 4x4	10/98-12/04	4G64 (GDI)	2351			0-N055	TB [DG]
2.4 GDI, 2.4 GDI 4x4	10/98-12/04	4G64 (GDI)	2351			0-N060	TB [TE]
2.4 GDI, 2.4 GDI 4x4	10/98-12/04	4G64 (GDI)	2351			0-N1127	TB [TE]
3.0 GDI 4x4	05/00-05/03	6G72 (DOHC 24V)	2972			0-N185	TB [TE]
3.0 GDI 4x4	05/00-05/03	6G72 (DOHC 24V)	2972			0-N189	TB [DG]
3.0 GDI 4x4	05/00-05/03	6G72 (DOHC 24V)	2972			0-N1521	VB [DG]
STARION (A18_A)							
2.0 Turbo ECi	06/82-08/87	4G63 T (ECi), 4G63 T/C	1997	19x122		SK-1240S	BTK
2.0 Turbo ECi	05/85-08/87	4G63 T/C	1997	12x55; 19x122; 05/1987 →		SK-1240	BTK
2.0 Turbo ECi	06/82-08/87	4G63 T (ECi), 4G63 T/C	1997			0-N059	TB [TE]
2.0 Turbo ECi	06/82-12/85	4G63 T (ECi)	1997			0-N183	TB [TE]
2.0 Turbo ECi	05/85-08/87	4G63 T/C	1997	→ 04/1987		0-N183	TB [TE]
2.0 Turbo ECi	05/85-08/87	4G63 T/C	1997	05/1987 →		0-N186	TB [TE]
TREDIA (A21_)							
1.4 GLX	10/82-08/85	4G12	1410	19.05x92		SK-1317	BTK
1.6 Turbo, GLS 1.6	09/82-10/87	4G32, 4G32 T	1597	19.05x120; → 06/1983		SK-1321	BTK
1.4 GLX	10/82-08/85	4G12	1410			0-N986	TB [TE]
1.6 Turbo	09/82-05/85	4G32 T	1597			0-N051	TB [TE]
1.6 Turbo, GLS 1.6	09/82-10/87	4G32, 4G32 T	1597			0-N188	TB [TE]
1.8 GLS	08/84-07/86	4G37	1755			0-N051	TB [TE]
1.8 GLS	08/84-07/86	4G37	1755			0-N188	TB [TE]
GLS 1.6	09/82-10/87	4G32	1597	→ 12/1986		0-N051	TB [TE]
GLS 1.6	09/82-10/87	4G32	1597	01/1987 →		0-N053	TB [TE]
VERADA Stufenheck (KR)							
3.0 24V	10/92-02/94	6G72 (DOHC 24V)	2972			0-N185	TB [TE]
3.0 24V	10/92-02/94	6G72 (DOHC 24V)	2972			0-N189	TB [DG]
3.0 24V	10/92-02/94	6G72 (DOHC 24V)	2972			0-N1521	VB [DG]
VERADA Stufenheck (KE)							
3.5 24V	10/96-06/97	6G74 (SOHC 24V)	3497			0-N185	TB [TE]
VERADA Station Wagon (KS)							
3.0	03/94-03/97	6G72 (DOHC 24V), 6G72 (SOHC 12V), 6G72 (SOHC 24V)	2972			0-N185	TB [TE]
3.0	10/95-09/96	6G72 (DOHC 24V)	2972			0-N189	TB [DG]
3.0	03/94-03/97	6G72 (DOHC 24V), 6G72 (SOHC 12V), 6G72 (SOHC 24V)	2972			0-N1521	VB [DG]
VERADA Stufenheck (KS)							
3.0	03/94-03/97	6G72 (SOHC 24V)	2972			0-N185	TB [TE]
3.0	03/94-03/97	6G72 (SOHC 24V)	2972			0-N1521	VB [DG]
VERADA Stufenheck (KW)							
3.5, 3.5 24V	10/04-07/05	6G74 (DOHC 24V), 6G74 (SOHC 24V)	3497			0-N185	TB [TE]
VERADA Stufenheck (KL)							
3.5, 3.5 Allrad	06/03-10/04	6G74 (SOHC 24V)	3497			0-N185	TB [TE]
VERADA Stufenheck (KJ)							
3.0 Ei 24V	08/00-05/03	6G72 (DOHC 24V)	2972			0-N185	TB [TE]
3.5 i	08/00-05/03	6G74 (SOHC 24V)	3497			0-N185	TB [TE]
VERADA Stufenheck (KH)							
3.0 Ei	06/99-08/00	6G72 (SOHC 12V)	2972			0-N185	TB [TE]
VERADA Stufenheck (KF)							
3.5 24V, 3.5 Ei	06/97-05/99	6G74 (DOHC 24V), 6G74 (SOHC 24V)	3497			0-N185	TB [TE]



OPTIMAL®

MITSUBISHI (BJC)

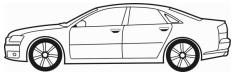

CM³



Art. Nr.



ohne Halter

PAJERO SPORT

3.0 AWD	01/03-02/06	6 G 72	2972		0-N185	TB [TE]	
---------	-------------	--------	------	--	--------	---------	--



CM³



Art. Nr.



ohne Halter

PAJERO SPORT (KH_W)

3.0, 3.0 4WD	08/13-	6B31	2998	0-N2384	TB [DG]
--------------	--------	------	------	---------	---------



OPTIMAL®

MORGAN

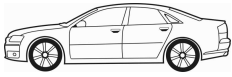

CM³



Art. Nr.



ohne Halter

FOUR FOUR

1.6 i Kat	08/91-	LJA	1597	21x97; 04/1992 →	SK-1053	BTK	
-----------	--------	-----	------	------------------	---------	-----	--

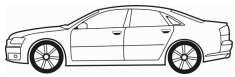

CM³



Art. Nr.



200 SX (S13)							
1.8 Turbo	07/88-11/93	CA18DET	1809			0-N022	TB [TE]
300 ZX (Z31)							
3.0, 3.0 Turbo	01/84-10/90	VG30E, VG30ET, VG30T	2960			0-N024	TB [TE]
300 ZX (Z32)							
3.0 Twin Turbo	05/90-09/95	VG30DETT	2960			0-N1218	TB [DG]
3.0 Twin Turbo	05/90-09/95	VG30DETT	2960			0-N1219	TB [DG]
3.0 Twin Turbo	05/90-09/95	VG30DETT	2960			0-N1220	TB [TE]
3.0 Twin Turbo	05/90-09/95	VG30DETT	2960			0-N2260	TB [DG]
3.0 Twin Turbo	05/90-09/95	VG30DETT	2960			0-N2203	VB [BT] S
ALMERA I (N15)							
2.0 D	11/95-07/00	CD20	1974	19.05x76; 25x111; → 04/1996		SK-1068	BTK
2.0 D	11/95-07/00	CD20	1974	25x111; → 04/1996		SK-1068S	BTK
2.0 D	11/95-07/00	CD20	1974	25x111; 19.04x79; 05/1996 →		SK-1097	BTK
2.0 D	11/95-07/00	CD20	1974			0-N027	TB [TE]
2.0 D	11/95-07/00	CD20	1974			0-N028	TB [TE]
2.0 D	11/95-07/00	CD20	1974			0-N029	TB [DG]
1.4, 1.4 GX,LX	09/95-07/00	GA14DE	1392	→ 01/1999; Rippenanzahl: 4		0-N2164	VB [TE]
1.6, 1.6 SLX	07/95-07/00	GA16DE	1597	→ 06/1999; Rippenanzahl: 4		0-N2164	VB [TE]
1.6, 1.6 SLX	07/95-07/00	GA16DE	1597	06/1999 →; Rippenanzahl: 4		0-N2165	VB [TE]
ALMERA I Hatchback (N15)							
2.0 D	11/95-03/00	CD20	1974	19.05x76; 25x111; → 04/1996		SK-1068	BTK
2.0 D	11/95-03/00	CD20	1974	25x111; → 04/1996		SK-1068S	BTK
2.0 D	11/95-03/00	CD20	1974	25x111; 19.04x79; 05/1996 →		SK-1097	BTK
2.0 D	11/95-03/00	CD20	1974			0-N027	TB [TE]
2.0 D	11/95-03/00	CD20	1974			0-N028	TB [TE]
2.0 D	11/95-03/00	CD20	1974			0-N029	TB [DG]
1.4, 1.4 S,GX,LX	09/95-03/00	GA14DE	1392	→ 01/1999; Rippenanzahl: 4		0-N2164	VB [TE]
1.6, 1.6 SR,SLX	07/95-03/00	GA16DE	1597	→ 06/1999; Rippenanzahl: 4		0-N2164	VB [TE]
1.6, 1.6 SR,SLX	07/95-03/00	GA16DE	1597	06/1999 →; Rippenanzahl: 4		0-N2165	VB [TE]
ALMERA II (N16)							
1.5 dCi	01/03-	K9K 722	1461	27x123; 06/2003 → 10/2003; mit Zubehör		SK-1487	BTK
1.5 dCi	01/03-	K9K 722	1461	27x123; mit Zubehör		SK-1487AQ1	BTKW
1.5 dCi	01/03-	K9K 722	1461			0-N1111	TB [TE]
1.5 dCi	01/03-	K9K 722	1461	☼		0-N1474	VB [BT]
1.5 dCi	01/03-	K9K 722	1461	☼		0-N1476	VB [BT] S
1.5 dCi	01/03-	K9K 722	1461	Rippenanzahl: 6; ☼		0-N1898	VB [BT] S
2.2 Di	07/00-	YD22DDT	2184			0-N2099	FB [DG]
ALMERA II Hatchback (N16)							
1.5 dCi	01/03-	K9K 722	1461	27x123; 06/2003 → 10/2003; mit Zubehör		SK-1487	BTK
1.5 dCi	01/03-	K9K 722	1461	27x123; mit Zubehör		SK-1487AQ1	BTKW
1.5 dCi	01/03-	K9K 722	1461			0-N1111	TB [TE]
1.5 dCi	01/03-	K9K 722	1461	☼		0-N1474	VB [BT]
1.5 dCi	01/03-	K9K 722	1461	☼		0-N1476	VB [BT] S
1.5 dCi	01/03-	K9K 722	1461	Rippenanzahl: 6; ☼		0-N1898	VB [BT] S
2.2 Di	03/00-	YD22DDT	2184			0-N2099	FB [DG]
ALMERA (N17)							
1.5 i	08/12-	HR15DE	1498			0-N2240	VB [DG]
ALMERA TINO (V10)							
2.2 dCi, 2.2 Di	08/00-	YD22DDT, YD22DDTi	2184			0-N2099	FB [DG]
ALTIMA [USA]							
1.6 Flex	01/93-12/93		2389			0-N1331	TB [TE]
AVENIR							
2.0 TD	11/92-10/97	CD20T	1974	19.05x76; 25x111		SK-1068	BTK
2.0 TD	11/92-10/97	CD20T	1974	25x111		SK-1068S	BTK
BASSARA							
2.5 DCi	11/99-08/03	YD25DDTi	2488			0-N2089	VB [BT] S
BLUEBIRD (U11)							
1.8, 1.8 Turbo	11/83-05/90	CA18S, CA18T	1809	19.05x95		SK-1202	BTK
2.0 i	04/84-01/88	CA20E	1974	19x98		SK-1203	BTK
1.8, 1.8 Turbo	11/83-05/90	CA18S, CA18T	1809			0-N021	TB [TE]
2.0 D	04/84-01/88	LD20	1952			0-N030	TB [TE]

CM³

Art. Nr.

**BLUEBIRD (U11)**

2.0 D	04/84-01/88	LD20	1952		0-N031	TB [DG]	
2.0 i	04/84-01/88	CA20E	1974		0-N021	TB [TE]	

BLUEBIRD Station Wagon (WU11)

1.6	12/85-02/90	CA16S	1598	19.05x95	SK-1202	BTK	
1.8	11/83-04/90	CA18N, CA18S	1809	19.05x95	SK-1202	BTK	
2.0, 2.0 i, 2.0 LX	04/84-12/90	CA20E, CA20S	1974	19x98	SK-1203	BTK	
2.0 D	04/84-12/90	LD20	1952		0-N030	TB [TE]	
2.0 D	04/84-12/90	LD20	1952		0-N031	TB [DG]	
2.0, 2.0 i, 2.0 LX	04/84-12/90	CA20E, CA20S	1974		0-N021	TB [TE]	

BLUEBIRD (T72 , T12)

1.6	12/85-06/90	CA16S	1598	19.05x95	SK-1202	BTK	
1.8 Turbo	12/85-05/90	CA18T	1809	19.05x95; Nockenwelle: SOHC/OHC	SK-1202	BTK	
2.0 , 2.0 i, 2.0 LX	12/85-12/90	CA20E, CA20S	1974	19x98	SK-1203	BTK	
1.6	03/86-06/90	CA16S	1598		0-N021	TB [TE]	
1.8 i 16V	02/89-12/90	CA18D	1809		0-N022	TB [TE]	
1.8 Turbo	12/85-05/90	CA18T	1809		0-N021	TB [TE]	
2.0 , 2.0 i, 2.0 LX	12/85-12/90	CA20E, CA20S	1974		0-N021	TB [TE]	
2.0 D	03/86-12/90	LD20	1952		0-N030	TB [TE]	
2.0 D	03/86-12/90	LD20	1952		0-N031	TB [DG]	

BLUEBIRD Hatchback (T72, T12)

1.6	03/86-06/91	CA16S	1598	19.05x95	SK-1202	BTK	
1.8 Turbo	12/85-11/92	CA18T	1809	19.05x95; Nockenwelle: SOHC/OHC	SK-1202	BTK	
2.0 , 2.0 i	12/85-12/90	CA20E, CA20S	1974	19x98	SK-1203	BTK	
1.6	03/86-06/91	CA16S	1598		0-N021	TB [TE]	
1.8 i 16V	02/89-12/90	CA18D	1809		0-N022	TB [TE]	
1.8 Turbo	12/85-11/92	CA18T	1809		0-N021	TB [TE]	
2.0 , 2.0 i	12/85-12/90	CA20E, CA20S	1974		0-N021	TB [TE]	
2.0 D	03/86-12/90	LD20	1952		0-N030	TB [TE]	
2.0 D	03/86-12/90	LD20	1952		0-N031	TB [DG]	

BLUEBIRD SYLPHY II (G11)

1.5, 1.5 4x4	09/05-08/12	HR15DE	1498		0-N2240	VB [DG]	
2.0	09/05-08/12	MR20DE	1997		0-N1869	VB [BT]	S

CHERRY II Coupe (N10)

1.3	08/81-09/82	E13	1269		0-N032	TB [TE]	
-----	-------------	-----	------	--	--------	---------	--

CHERRY II Hatchback (N10)

1.3	08/81-09/82	E13	1269		0-N032	TB [TE]	
-----	-------------	-----	------	--	--------	---------	--

CHERRY II Traveller (VN10)

1.3	09/81-12/83	E13	1269		0-N032	TB [TE]	
-----	-------------	-----	------	--	--------	---------	--

CHERRY III (N12)

1.7 D	10/82-12/86	CD17	1681	19x76	SK-1662	BTK	
1.0	05/82-05/86	E10	988		0-N032	TB [TE]	
1.3	05/82-10/86	E13	1269		0-N032	TB [TE]	
1.5, 1.5 ET Turbo	01/83-10/86	E15ET, E15S	1488		0-N032	TB [TE]	
1.7 D	10/82-12/86	CD17	1681		0-N025	TB [TE]	
1.7 D	10/82-12/86	CD17	1681		0-N033	TB [DG]	

CUBE (Z11)

1.5, 1.5 4x4	01/03-09/05	HR15DE	1498		0-N2240	VB [DG]	
--------------	-------------	--------	------	--	---------	---------	--

CUBE (Z12)

1.5 dCi	03/10-	K9K, K9K 270	1461	27x123; mit Zubehör	SK-1487	BTK	
1.5 dCi	03/10-	K9K, K9K 270	1461	27x123; mit Zubehör	SK-1487AQ3	BTKW	
1.5 dCi	03/10-	K9K, K9K 270	1461		0-N1111	TB [TE]	
1.5 dCi	03/10-	K9K, K9K 270	1461		0-N1664	VB [BT]	S
1.5 dCi	03/10-	K9K, K9K 270	1461		0-N2253	VB [DG]	
1.6 16V	03/10-	HR16DE	1598		0-N2240	VB [DG]	

INTERSTAR Bus (X70)

dCi 100, dCi 120	07/02-	G9U 720	2463	25x89; mit Zubehör	SK-1489	BTK	
dCi 100, dCi 120, dCi 150	04/06-	G9U 632, G9U 650	2464	25x89; mit Zubehör	SK-1489	BTK	
dCi 80	07/02-	F9Q 772	1870	26x132	SK-1493	BTK	
dCi 80	07/02-	F9Q 772	1870	26x132	SK-1493AQ1	BTKW	
dCi 80	07/02-	F9Q 772	1870	26x132	SK-1493AQ2	BTKW	
dCi 90	07/02-	G9T 722	2188	25x89; mit Zubehör	SK-1489	BTK	



CM³



Art. Nr.



INTERSTAR Bus (X70)							
dCi 100, dCi 120	07/02-	G9U 720	2463			0-N1269	TB [TE]
dCi 100, dCi 120	07/02-	G9U 720	2463			0-N1270	TB [DG]
dCi 100, dCi 120, dCi 150	04/06-	G9U 632, G9U 650	2464			0-N1269	TB [TE]
dCi 100, dCi 120, dCi 150	04/06-	G9U 632, G9U 650	2464			0-N1270	TB [DG]
dCi 80	07/02-	F9Q 772	1870	mit Grundträger		0-N1173	TB [BT]
dCi 90	07/02-	G9T 722	2188			0-N1269	TB [TE]
dCi 90	07/02-	G9T 722	2188			0-N1270	TB [DG]
dCi 100	04/06-	G9U 650	2464	☼		0-N1731	VB [BT] S
dCi 100, dCi 120	07/02-	G9U 720	2463			0-N1731	VB [BT] S
dCi 100, dCi 120	07/02-	G9U 720	2463	☼, für Fahrzeuge ohne Nebenantrieb		0-N1875	VB [BT] S
dCi 100, dCi 120, dCi 150	04/06-	G9U 632, G9U 650	2464	☼, für Fahrzeuge ohne Nebenantrieb		0-N1875	VB [BT] S
dCi 120, dCi 150	09/06-	G9U 632, G9U 650	2464			0-N1731	VB [BT] S
dCi 80	07/02-	F9Q 772	1870			0-N1307	VB [DG]
dCi 80	07/02-	F9Q 772	1870			0-N1611	VB [BT] S
dCi 80	07/02-	F9Q 772	1870	☼		0-N1802	VB [BT] S
dCi 90	07/02-	G9T 722	2188			0-N1307	VB [DG]
dCi 90	07/02-	G9T 722	2188	Rippenanzahl: 6		0-N1648	VB [DG]
dCi 90	07/02-	G9T 722	2188			0-N1731	VB [BT] S
dCi 90	07/02-	G9T 722	2188	☼		0-N1875	VB [BT] S

INTERSTAR Kasten (X70)							
dCi 100, dCi 120	07/02-	G9U 720	2463	25x89; mit Zubehör		SK-1489	BTK
dCi 100, dCi 120, dCi 150	04/06-	G9U 632, G9U 650, G9U 720	2464	25x89; mit Zubehör		SK-1489	BTK
dCi 80	07/02-	F9Q 772	1870	26x132		SK-1493	BTK
dCi 80	07/02-	F9Q 772	1870	26x132		SK-1493AQ1	BTKW
dCi 80	07/02-	F9Q 772	1870	26x132		SK-1493AQ2	BTKW
dCi 90	07/02-	G9T 722	2188	25x89; mit Zubehör		SK-1489	BTK
dCi 100, dCi 120	07/02-	G9U 720	2463			0-N1269	TB [TE]
dCi 100, dCi 120	07/02-	G9U 720	2463			0-N1270	TB [DG]
dCi 100, dCi 120, dCi 150	04/06-	G9U 632, G9U 650, G9U 720	2464			0-N1269	TB [TE]
dCi 100, dCi 120, dCi 150	04/06-	G9U 632, G9U 650, G9U 720	2464			0-N1270	TB [DG]
dCi 80	07/02-	F9Q 772	1870	mit Grundträger		0-N1173	TB [BT]
dCi 90	07/02-	G9T 722	2188			0-N1269	TB [TE]
dCi 90	07/02-	G9T 722	2188			0-N1270	TB [DG]
dCi 100	11/03-	G9U 720	2463	☼		0-N1731	VB [BT] S
dCi 100	04/06-	G9U 720	2464	☼		0-N1731	VB [BT] S
dCi 100, dCi 120	07/02-	G9U 720	2463	☼, für Fahrzeuge ohne Nebenantrieb		0-N1875	VB [BT] S
dCi 100, dCi 120, dCi 150	04/06-	G9U 632, G9U 650, G9U 720	2464	☼, für Fahrzeuge ohne Nebenantrieb		0-N1875	VB [BT] S
dCi 120	07/02-	G9U 720	2463			0-N1731	VB [BT] S
dCi 120, dCi 150	09/06-	G9U 632, G9U 650	2464			0-N1731	VB [BT] S
dCi 80	07/02-	F9Q 772	1870			0-N1307	VB [DG]
dCi 80	07/02-	F9Q 772	1870			0-N1611	VB [BT] S
dCi 80	07/02-	F9Q 772	1870	☼		0-N1802	VB [BT] S
dCi 90	07/02-	G9T 722	2188			0-N1307	VB [DG]
dCi 90	07/02-	G9T 722	2188	Rippenanzahl: 6		0-N1648	VB [DG]
dCi 90	07/02-	G9T 722	2188			0-N1731	VB [BT] S
dCi 90	07/02-	G9T 722	2188	☼		0-N1875	VB [BT] S

INTERSTAR Pritsche/Fahrgestell							
dCi 100, dCi 120	08/03-	G9U 720	2463	25x89; mit Zubehör		SK-1489	BTK
dCi 120, dCi 150	08/06-	G9U 632, G9U 650	2464	25x89; mit Zubehör		SK-1489	BTK
dCi 100, dCi 120	08/03-	G9U 720	2463			0-N1269	TB [TE]
dCi 100, dCi 120	08/03-	G9U 720	2463			0-N1270	TB [DG]
dCi 120, dCi 150	08/06-	G9U 632, G9U 650	2464			0-N1269	TB [TE]
dCi 120, dCi 150	08/06-	G9U 632, G9U 650	2464			0-N1270	TB [DG]
dCi 100	02/04-	G9U 720	2463			0-N1731	VB [BT] S
dCi 100, dCi 120	08/03-	G9U 720	2463	☼, für Fahrzeuge ohne Nebenantrieb		0-N1875	VB [BT] S
dCi 120	08/03-	G9U 720	2463	☼		0-N1731	VB [BT] S
dCi 120, dCi 150	08/06-	G9U 632, G9U 650	2464	☼		0-N1731	VB [BT] S
dCi 120, dCi 150	08/06-	G9U 632, G9U 650	2464	☼, für Fahrzeuge ohne Nebenantrieb		0-N1875	VB [BT] S

JUKE (F15)							
1.5 dCi	06/10-	K9K 636, K9K 896, K9K 896	1461	27x123; mit Zubehör		SK-1487	BTK
1.5 dCi	06/10-	K9K 636, K9K 896, K9K 896	1461	27x123; mit Zubehör		SK-1487AQ3	BTKW
1.5 dCi	06/10-	K9K 636, K9K 896, K9K 896	1461			0-N1111	TB [TE]
1.5 dCi	06/10-	K9K 636, K9K 896, K9K 896	1461			0-N1664	VB [BT] S
1.5 dCi	06/10-	K9K 636, K9K 896, K9K 896	1461	Rippenanzahl: 6; ☼		0-N1898	VB [BT] S

CM³

Art. Nr.



JUKE (F15)								
1.6	06/10-	HR16DE	1598			0-N2240	VB [DG]	
KUBISTAR (X76)								
1.2	08/03-10/09	D7F 764	1149	17x87; → 08/2005		SK-1081	BTK	
1.2	08/03-10/09	D7F 764	1149	17x87		SK-1081AQ2	BTKW	
1.2 16V	04/06-10/09	D4F 712	1149	23.4x95		SK-1486	BTK	
1.2 16V	04/06-10/09	D4F 712	1149	23.4x95; → 10/2009		SK-1486AQ1	BTKW	
1.5 dCi	08/03-10/09	K9K 704, K9K 710, K9K 714, K9K 722	1461	27x123; → 04/2004; mit Zubehör		SK-1487AQ1	BTKW	
1.5 dCi, 1.5 dCi 70, 1.5 dCi 85	08/03-10/09	K9K 276, K9K 700, K9K 716, K9K 704, K9K 710, K9K 714, K9K 722	1461	27x123; mit Zubehör		SK-1487	BTK	
1.6 16V	08/03-10/09	K4M 752	1598	27x132; mit Zubehör		SK-1088	BTK	
1.6 16V	08/03-10/09	K4M 752	1598	27x132; mit Zubehör		SK-1088AQ1	BTKW	
1.2	08/03-10/09	D7F 764	1149			0-N863	TB [TE]	
1.2 16V	04/06-10/09	D4F 712	1149			0-N1112	TB [TE]	
1.5 dCi, 1.5 dCi 70, 1.5 dCi 85	08/03-10/09	K9K 276, K9K 700, K9K 716, K9K 704, K9K 710, K9K 714, K9K 722	1461			0-N1111	TB [TE]	
1.6 16V	08/03-10/09	K4M 752	1598			0-N198	TB [TE]	
1.6 16V	08/03-10/09	K4M 752	1598			0-N262	TB [DG]	
1.2, 1.2 16V	08/03-10/09	D4F 712, D7F 764	1149	☼, für Fahrzeuge mit Servolenkung		0-N1592	VB [DG]	
1.2, 1.2 16V	08/03-10/09	D4F 712, D7F 764	1149	☼, für Fahrzeuge ohne Servolenkung		0-N2222	VB [TE]	
1.5 dCi	08/03-10/09	K9K 704, K9K 710, K9K 714, K9K 722	1461	→ 09/2005; ☼		0-N1474	VB [BT]	
1.5 dCi	08/03-10/09	K9K 710, K9K 714	1461	01/2005 →		0-N1664	VB [BT]	S
1.5 dCi	08/03-10/09	K9K 704, K9K 722	1461	09/2005 →; ☼		0-N1664	VB [BT]	S
1.5 dCi	08/03-10/09	K9K 704, K9K 722	1461	Rippenanzahl: 6; ☼		0-N1898	VB [BT]	S
1.5 dCi, 1.5 dCi 70, 1.5 dCi 85	08/03-10/09	K9K 276, K9K 700, K9K 716, K9K 704, K9K 722	1461	☼		0-N1476	VB [BT]	S
1.6 16V	08/03-10/09	K4M 752	1598			0-N1307	VB [DG]	
1.6 16V	08/03-10/09	K4M 752	1598	☼		0-N1314	VB [TE]	
1.6 16V	08/03-10/09	K4M 752	1598	☼		0-N1663	VB [BT]	S
KUBISTAR Kasten (X80)								
1.2	08/03-	D7F 764	1149	17x87; → 08/2005		SK-1081	BTK	
1.2	08/03-	D7F 764	1149	17x87		SK-1081AQ2	BTKW	
1.2 16V	04/06-	D4F 712	1149	23.4x95		SK-1486	BTK	
1.2 16V	04/06-	D4F 712	1149	23.4x95; → 10/2009		SK-1486AQ1	BTKW	
1.5 dCi	08/03-	K9K 704, K9K 710, K9K 714, K9K 722	1461	27x123; mit Zubehör		SK-1487	BTK	
1.5 dCi	08/03-	K9K 704, K9K 722	1461	27x123; → 04/2004; mit Zubehör		SK-1487AQ1	BTKW	
1.6 16V	08/03-	K4M 752	1598	27x132; mit Zubehör		SK-1088	BTK	
1.6 16V	08/03-	K4M 752	1598	27x132; mit Zubehör		SK-1088AQ1	BTKW	
1.2	08/03-	D7F 764	1149			0-N863	TB [TE]	
1.2 16V	04/06-	D4F 712	1149			0-N1112	TB [TE]	
1.5 dCi	08/03-	K9K 704, K9K 710, K9K 714, K9K 722	1461			0-N1111	TB [TE]	
1.6 16V	08/03-	K4M 752	1598			0-N198	TB [TE]	
1.6 16V	08/03-	K4M 752	1598	→ 01/2011		0-N262	TB [DG]	
1.2, 1.2 16V	08/03-	D4F 712, D7F 764	1149	☼, für Fahrzeuge mit Servolenkung		0-N1592	VB [DG]	
1.2, 1.2 16V	08/03-	D4F 712, D7F 764	1149	☼, für Fahrzeuge ohne Servolenkung		0-N2222	VB [TE]	
1.5 dCi	08/03-	K9K 704, K9K 722	1461	→ 09/2005; ☼		0-N1474	VB [BT]	
1.5 dCi	08/03-	K9K 704, K9K 722	1461	☼		0-N1476	VB [BT]	S
1.5 dCi	08/03-	K9K 704, K9K 722	1461	09/2005 →; ☼		0-N1664	VB [BT]	S
1.5 dCi	08/03-	K9K 704, K9K 722	1461	Rippenanzahl: 6; ☼		0-N1898	VB [BT]	S
1.6 16V	08/03-	K4M 752	1598			0-N1307	VB [DG]	
1.6 16V	08/03-	K4M 752	1598	☼		0-N1314	VB [TE]	
1.6 16V	08/03-	K4M 752	1598	☼		0-N1663	VB [BT]	S
LATI0 Stufenheck								
1.5, 1.5 4x4	11/04-	HR15DE	1498			0-N2240	VB [DG]	
1.8	11/04-	HR18DE	1769			0-N2240	VB [DG]	
LATI0 Stufenheck								
1.6	03/07-	HR16DE	1598			0-N2240	VB [DG]	
1.8	03/07-	HR18DE	1769			0-N2240	VB [DG]	
LAUREL (JC32)								
2.8 D	01/85-12/89	RD28	2826	30x149; 02/1987 →		SK-1210	BTK	
2.0 GL	11/84-12/85	CA20S	1974			0-N021	TB [TE]	
2.8 D	01/85-12/89	RD28	2826			0-N034	TB [TE]	
2.8 D	01/85-12/89	RD28	2826			0-N035	TB [DG]	
LIVINA / GRAND LIVINA (L10, L11)								
1.5	03/09-	HR15DE	1498			0-N2240	VB [DG]	



CM³



Art. Nr.



LIVINA / GRAND LIVINA (L10, L11)							
1.6	02/07-	HR16DE	1598			0-N2240	VB [DG]
MAXIMA II (J30)							
3.0 i	10/88-06/94	VG30E	2960	25.4x133		SK-1285	BTK
3.0 i	10/88-06/94	VG30E	2960			0-N024	TB [TE]
MICRA I (K10)							
1.0	12/82-05/91	MA10S	988	19.05x107		SK-1207	BTK
1.2	07/86-07/92	MA12S	1235	19.05x110		SK-1286	BTK
1.0	12/82-12/89	MA10S	988	für Fahrzeuge ohne Katalysator; → 12/1988		0-N094	TB [TE]
1.2	07/86-07/92	MA12S	1235	für Fahrzeuge ohne Katalysator; → 12/1988		0-N094	TB [TE]
MICRA II (K11)							
1.5 D	02/98-02/03	TD15	1527	25.4x136		SK-1040	BTK
1.5 D	02/98-02/03	TD15	1527	25.4x136		SK-1040AQ1	BTKW
1.5 D	02/98-02/03	TD15	1527			0-N861	TB [TE]
1.5 D	02/98-02/03	TD15	1527			0-N862	TB [DG]
MICRA III (K12)							
1.5 dCi	01/03-06/10	K9K 704, K9K 722	1461	27x123; → 11/2003; mit Zubehör		SK-1487	BTK
1.5 dCi	01/03-06/10	K9K 704	1461	27x123; → 05/2005; mit Zubehör		SK-1487AQ1	BTKW
1.5 dCi	09/03-06/10	K9K 722	1461	27x123; mit Zubehör		SK-1487AQ1	BTKW
1.5 dCi	09/03-06/10	K9K 722	1461	27x123; 04/2004 →; mit Zubehör		SK-1487AQ2	BTKW
1.5 dCi	06/05-06/10	K9K 276, K9K 708	1461	27x123; mit Zubehör		SK-1487	BTK
1.5 dCi	01/03-06/10	K9K 276, K9K 704, K9K 708, K9K 722	1461			0-N1111	TB [TE]
1.0 16V	01/03-06/10	CG10DE	998			0-N2043	VB [TE]
1.0 16V	01/03-06/10	CG10DE	998	→ 05/2006		0-N2282	VB [TE]
1.0 16V	01/03-06/10	CG10DE	998			0-N2357	VB [DG]
1.2 16V	01/03-06/10	CG12DE, CR12DE	1240			0-N2043	VB [TE]
1.2 16V	01/03-06/10	CG12DE, CR12DE	1240			0-N2282	VB [TE]
1.2 16V	01/03-06/10	CG12DE, CR12DE	1240			0-N2357	VB [DG]
1.4 16V	01/03-06/10	CR14DE	1386	06/2003 →		0-N2043	VB [TE]
1.4 16V	01/03-06/10	CR14DE	1386			0-N2282	VB [TE]
1.4 16V	01/03-06/10	CR14DE	1386			0-N2357	VB [DG]
1.5 dCi	01/03-06/10	K9K 276, K9K 704, K9K 708, K9K 722	1461	☼		0-N1474	VB [BT]
1.5 dCi	01/03-06/10	K9K 276, K9K 704, K9K 722	1461	☼		0-N1476	VB [BT] S
1.5 dCi	01/03-06/10	K9K 276, K9K 704, K9K 708, K9K 722	1461			0-N1664	VB [BT] S
1.5 dCi	01/03-06/10	K9K 704, K9K 722	1461	Rippenanzahl: 6; ☼		0-N1898	VB [BT] S
1.5 dCi	06/05-06/10	K9K 276	1461	→ 09/2007; Rippenanzahl: 6; ☼		0-N1898	VB [BT] S
160 SR	05/05-06/10	HR16DE	1598			0-N2240	VB [DG]
MICRA C+C (K12)							
1.4 16V	08/05-	CR14DE	1386			0-N2043	VB [TE]
1.4 16V	08/05-	CR14DE	1386			0-N2357	VB [DG]
1.6 160 SR	08/05-	HR16DE	1598			0-N2240	VB [DG]
MICRA IV (K13)							
1.2	05/10-	HR12DE	1198			0-N2240	VB [DG]
1.5	11/10-	HR15DE	1498			0-N2240	VB [DG]
NAVARA (D40)							
2.5 dCi 4WD	10/08-	YD25DDTi	2488	☼		0-N2285	VB [DG]
2.5 dCi 4WD	12/09-	YD25DDTi	2488	02/2010 →; ☼		0-N2089	VB [BT] S
2.5 dCi, 2.5 dCi 4WD	07/05-	YD25DDTi	2488			0-N1986	VB [TE]
2.5 dCi, 2.5 dCi 4WD	07/05-	YD25DDTi	2488			0-N2089	VB [BT] S
2.5 dCi, 2.5 dCi 4WD	07/05-	YD25DDTi	2488	02/2010 →; ☼		0-N2285	VB [DG]
2.5 dCi, 2.5 dCi 4WD	07/05-	YD25DDTi	2488			0-N2425	VB [BT]
3.0 dCi 4WD	02/10-	V9X	2993			0-N2085	VB [BT] S
NAVARA Pritsche/Fahrgestell (D40)							
2.5 dCi	03/10-	YD25DDTi	2488	☼		0-N2089	VB [BT] S
2.5 dCi 4WD	08/08-	YD25DDTi	2488	02/2010 →; ☼		0-N2089	VB [BT] S
2.5 dCi, 2.5 dCi 4WD	08/08-	YD25DDTi	2488	☼		0-N2285	VB [DG]
2.5 dCi, 2.5 dCi 4WD	08/08-	YD25DDTi	2488			0-N2425	VB [BT]
3.0 dCi	03/10-	V9X	2993			0-N2085	VB [BT] S
NOTE (E11)							
1.5 dCi	03/06-	K9K 276, K9K 292, K9K 700	1461	27x123; mit Zubehör		SK-1487	BTK
1.5 dCi	03/06-	K9K 276, K9K 292, K9K 700	1461	27x123; Abgasnorm: Euro 5; mit Zubehör		SK-1487AQ3	BTKW
1.5 dCi	09/10-	K9K 276	1461	27x123; 01/2011 →; mit Zubehör		SK-1487	BTK
1.5 dCi	03/06-	K9K 276, K9K 292, K9K 700	1461			0-N1111	TB [TE]



CM³



Art. Nr.



ohne Halter

NOTE (E11)							
1.4	03/06-	CR14DE	1386			0-N2043	VB [TE]
1.4	03/06-	CR14DE	1386			0-N2282	VB [TE]
1.4	03/06-	CR14DE	1386			0-N2357	VB [DG]
1.5 dCi	03/06-	K9K 276, K9K 292, K9K 700	1461	✘		0-N1474	VB [BT]
1.5 dCi	03/06-	K9K 276, K9K 292, K9K 700	1461	✘		0-N1664	VB [BT] S
1.5 dCi	03/06-	K9K 276, K9K 292, K9K 700	1461	Rippenanzahl: 6; ✘		0-N1898	VB [BT] S
1.5 dCi	09/10-	K9K 276	1461	✘		0-N2253	VB [DG]
1.6	03/06-	HR16DE	1598			0-N2240	VB [DG]
PICKUP / NP300 PICKUP III (D22)							
2.5 dCi, 2.5 dCi 4x4	04/08-	YD25DDTi	2488			0-N2089	VB [BT] S
NV200 / EVALIA Bus							
1.5 dci	07/10-	K9K 400, K9K 608, K9K 628, K9K 636, K9K 646, K9K 892	1461	27x123; mit Zubehör		SK-1487	BTK
1.5 dci	07/10-	K9K 400, K9K 608, K9K 628, K9K 892	1461	27x123; 01/2013 → 10/2013; mit Zubehör		SK-1487AQ3	BTKW
1.5 dci	07/10-	M20M	1461	27x123; mit Zubehör		SK-1487AQ3	BTKW
1.5 dci	04/11-	K9K 636, K9K 646	1461	27x123; → 10/2013; mit Zubehör		SK-1487AQ3	BTKW
1.5 dci	07/10-	K9K 400, K9K 608, K9K 628, K9K 636, K9K 646, K9K 892	1461			0-N1111	TB [TE]
1.5 dci	07/10-	K9K 400, K9K 608, K9K 628, K9K 636, K9K 646	1461			0-N1664	VB [BT] S
1.5 dci	07/10-	K9K 400, K9K 608, K9K 628, K9K 636, K9K 646, K9K 892	1461	✘		0-N2253	VB [DG]
1.6 16V	07/10-	HR16DE	1598			0-N2240	VB [DG]
NV200 Kasten							
1.5 dci	02/10-	K9K 400, K9K 608, K9K 628, K9K 636, K9K 646, K9K 892	1461	27x123; mit Zubehör		SK-1487	BTK
1.5 dci	02/10-	K9K 400, K9K 608, K9K 628, K9K 892	1461	27x123; 01/2013 → 10/2013; mit Zubehör		SK-1487AQ3	BTKW
1.5 dci	04/11-	K9K 636, K9K 646	1461	27x123; → 10/2013; mit Zubehör		SK-1487AQ3	BTKW
1.5 dci	02/10-	K9K 400, K9K 608, K9K 628, K9K 636, K9K 646, K9K 892	1461			0-N1111	TB [TE]
1.5 dci	02/10-	K9K 400, K9K 608, K9K 628, K9K 636, K9K 646	1461			0-N1664	VB [BT] S
1.5 dci	02/10-	K9K 400, K9K 608, K9K 628, K9K 636, K9K 646, K9K 892	1461	✘		0-N2253	VB [DG]
1.6 16V	02/10-	HR16DE	1598			0-N2240	VB [DG]
NV400 Bus							
2.3 dCi	11/11-	M9T 670, M9T 672, M9T 676, M9T 678, M9T 680	2299			0-N1739	VB [DG]
2.3 dCi	11/11-	M9T 670, M9T 672, M9T 676, M9T 678, M9T 680	2299			0-N2039	VB [BT] S
NV400 Kasten							
2.3 dCi, 2.3 dCi [RWD]	11/11-	M9T 670, M9T 672, M9T 676, M9T 678, M9T 680, M9T 686, M9T 690, M9T 692, M9T 696, M9T 698, M9T 870, M9T 896, M9T 694, M9T 696, M9T 698	2299			0-N1739	VB [DG]
2.3 dCi, 2.3 dCi [RWD]	11/11-	M9T 670, M9T 672, M9T 676, M9T 678, M9T 680, M9T 686, M9T 690, M9T 692, M9T 696, M9T 698, M9T 870, M9T 896, M9T 694, M9T 696, M9T 698	2299			0-N2039	VB [BT] S
NV400 Pritsche/Fahrgestell							
2.3 dCi, 2.3 dCi [RWD]	11/11-	M9T 670, M9T 672, M9T 676, M9T 678, M9T 680, M9T 686, M9T 690, M9T 692, M9T 696, M9T 698, M9T 870, M9T 896, M9T 694, M9T 696, M9T 698	2299			0-N1739	VB [DG]
2.3 dCi, 2.3 dCi [RWD]	11/11-	M9T 670, M9T 672, M9T 676, M9T 678, M9T 680, M9T 686, M9T 690, M9T 692, M9T 696, M9T 698, M9T 870, M9T 896, M9T 694, M9T 696, M9T 698	2299			0-N2039	VB [BT] S
PATHFINDER II (R50)							
3.3 V6 4WD	09/97-12/04	VG33E	3275	25.4x133		SK-1285	BTK
3.3 V6 4WD	09/97-12/04	VG33E	3275			0-N024	TB [TE]
3.3 V6 4WD	09/97-12/04	VG33E	3275			0-N2260	TB [DG]
3.3 V6 4WD	09/97-12/04	VG33E	3275			0-N2203	VB [BT] S
PATHFINDER III (R51)							
2.5 dCi 4WD	03/05-	YD25DDTi	2488			0-N1986	VB [TE]
2.5 dCi 4WD	08/10-	YD25DDTi	2488	✘		0-N2285	VB [DG]
2.5 dCi, 2.5 dCi 4WD	01/05-	YD25DDTi	2488			0-N2089	VB [BT] S
2.5 dCi, 2.5 dCi 4WD	01/05-	YD25DDTi	2488	02/2010 →; ✘		0-N2285	VB [DG]



CM³



Art. Nr.



PATHFINDER III (R51)

2.5 dCi, 2.5 dCi 4WD	01/05-	YD25DDTi	2488		0-N2425	VB [BT]	
3.0 dCi	08/10-	V9X	2993		0-N2085	VB [BT]	S

PATROL III/2 Hardtop (K260)

2.8 D	03/89-03/96	RD28	2826	30x149; → 08/1994	SK-1210	BTK	
2.8 D	03/89-03/96	RD28	2826	30x149; 08/1994 →	SK-1476	BTK	
2.8 TD	05/86-06/90	RD28T	2826	30x149	SK-1210	BTK	
2.8 D	03/89-03/96	RD28T	2826		0-N034	TB [TE]	
2.8 D	03/89-03/96	RD28T	2826		0-N035	TB [DG]	
2.8 TD	05/86-06/90	RD28T	2826		0-N034	TB [TE]	
2.8 TD	05/86-06/90	RD28T	2826		0-N035	TB [DG]	

PATROL III/2 Station Wagon (W260)

2.8 D 4x4, 2.8 TD 4x4	01/90-06/93	RD28, RD28T	2826	30x149	SK-1210	BTK	
2.8 TD	06/89-11/95	RD28T	2826	30x149; → 08/1995	SK-1210	BTK	
2.8 TD	06/89-11/95	RD28T	2826	30x149; 08/1994 →	SK-1476	BTK	
2.8 D 4x4	01/90-01/91	RD28T	2826		0-N034	TB [TE]	
2.8 D 4x4	01/90-01/91	RD28T	2826		0-N035	TB [DG]	
2.8 TD, 2.8 TD 4x4	06/89-11/95	RD28T	2826		0-N034	TB [TE]	
2.8 TD, 2.8 TD 4x4	06/89-11/95	RD28T	2826		0-N035	TB [DG]	

PATROL GR IV (Y60, GR)

2.8 TD	09/88-06/97	RD28T	2826	30x149; → 08/1995	SK-1210	BTK	
2.8 TD	09/88-06/97	RD28T	2826	30x149; 09/1994 →	SK-1476	BTK	
2.8 TD	10/95-02/98	RD28T	2826	30x149	SK-1476	BTK	
4.2 D	11/88-06/97	TD42	4169	30x149; → 08/1995	SK-1210	BTK	
2.8 TD	09/88-02/98	RD28T	2826		0-N034	TB [TE]	
2.8 TD	09/88-02/98	RD28T	2826		0-N035	TB [DG]	
4.2 D	11/88-06/97	TD42	4169	→ 08/1995	0-N034	TB [TE]	
4.2 D	11/88-06/97	TD42	4169		0-N035	TB [DG]	

PATROL GR V Wagon (Y61)

2.8 TD, 2.8 TDiC	06/97-05/00	RD28Ti	2826	30x149	SK-1476	BTK	
2.8 TD, 2.8 TDiC	06/97-05/00	RD28Ti	2826		0-N034	TB [TE]	
2.8 TD, 2.8 TDiC	06/97-05/00	RD28Ti	2826		0-N035	TB [DG]	
3.0 DTi	05/00-	ZD30DDTi	2953		0-N1732	VB [BT]	S

PICK UP III (D22)

2.5 Di, 2.5 Di 4WD	03/02-	YD25DDTi	2488		0-N2089	VB [BT]	S
2.5 D	02/98-	TD25	2494	11/2001 →	0-N2099	FB [DG]	
2.5 Di, 2.5 Di 4WD	03/02-	YD25DDTi	2488		0-N2099	FB [DG]	

PRAIRIE (M10, NM10)

2.0 4x4	06/86-09/88	CA20S	1974	19x98	SK-1203	BTK	
1.5 S	01/84-12/87	E15S	1488		0-N032	TB [TE]	
1.8 SGL	07/83-10/87	CA18S	1809		0-N021	TB [TE]	
2.0 4x4	06/86-09/88	CA20S	1974		0-N021	TB [TE]	

PRAIRIE PRO (M11)

2.0, 2.0 i, 2.0 i 4x4	10/88-12/92	CA20E	1974	19x98	SK-1203	BTK	
2.0 i, 2.0 i 4x4	10/88-12/92	CA20E	1974		0-N021	TB [TE]	

PRIMASTAR Bus (X83)

dCi 100, dCi 80	03/01-	F9Q 760, F9Q 762	1870	26x132	SK-1493	BTK	
dCi 100, dCi 80	03/01-	F9Q 760, F9Q 762	1870	26x132	SK-1493AQ1	BTKW	
dCi 100, dCi 80	03/01-	F9Q 760, F9Q 762	1870	26x132	SK-1493AQ2	BTKW	
dCi 140	07/03-	G9U 730	2463	25x89; mit Zubehör	SK-1489	BTK	
dCi 150	09/06-	G9U 632	2464	25x89; mit Zubehör	SK-1489	BTK	
2.0	03/01-	F4R 720, F4R 722	1998		0-N1365	TB [DG]	
2.0	03/01-	F4R 720, F4R 722	1998		0-N2380	TB [DG]	
dCi 100, dCi 80	03/01-	F9Q 760, F9Q 762	1870	mit Grundträger	0-N1173	TB [BT]	
dCi 115, dCi 150	09/06-	G9U 632, G9U 720	2464		0-N1269	TB [TE]	
dCi 115, dCi 150	09/06-	G9U 632, G9U 720	2464		0-N1270	TB [DG]	
dCi 140	07/03-	G9U 730	2463		0-N1269	TB [TE]	
dCi 140	07/03-	G9U 730	2463		0-N1270	TB [DG]	
2.0	03/01-	F4R 720, F4R 722	1998	→ 03/2002	0-N1307	VB [DG]	
2.0	03/01-	F4R 720, F4R 722	1998	03/2002 →	0-N1409	VB [DG]	
2.0	03/01-	F4R 720, F4R 722	1998		0-N1611	VB [BT]	S
2.0	03/01-	F4R 720, F4R 722	1998		0-N1802	VB [BT]	S
dCi 100, dCi 80	03/01-	F9Q 760, F9Q 762	1870	→ 02/2002	0-N1307	VB [DG]	

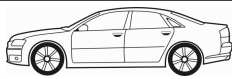
CM³

Art. Nr.

**PRIMASTAR Bus (X83)**

dCi 100, dCi 80	03/01-	F9Q 760, F9Q 762	1870	02/2002 →	0-N1409	VB [DG]	
dCi 100, dCi 80	03/01-	F9Q 760, F9Q 762	1870		0-N1611	VB [BT]	S
dCi 100, dCi 80	03/01-	F9Q 760, F9Q 762	1870	☞	0-N1802	VB [BT]	S
dCi 115	09/08-	G9U 720	2464	für Fahrzeuge mit Nebenantrieb, ☞	0-N1731	VB [BT]	S
dCi 115	09/08-	G9U 720	2464	☞	0-N1731	VB [BT]	S
dCi 115, dCi 150	09/06-	G9U 632, G9U 720	2464	☞, für Fahrzeuge ohne Nebenantrieb	0-N1875	VB [BT]	S
dCi 120, dCi 90	09/06-	M9R 780, M9R 782	1995		0-N1739	VB [DG]	
dCi 120, dCi 90	09/06-	M9R 780, M9R 782	1995		0-N2039	VB [BT]	S
dCi 140	07/03-	G9U 730	2463		0-N1731	VB [BT]	S
dCi 140	07/03-	G9U 730	2463	☞, für Fahrzeuge ohne Nebenantrieb	0-N1875	VB [BT]	S
dCi 150	09/06-	G9U 632	2464		0-N1731	VB [BT]	S

PRIMASTAR Kasten (X83)

dCi 100, dCi 80	09/02-	F9Q 760, F9Q 762	1870	26x132	SK-1493	BTK	
dCi 100, dCi 80	09/02-	F9Q 760, F9Q 762	1870	26x132	SK-1493AQ1	BTKW	
dCi 100, dCi 80	09/02-	F9Q 760, F9Q 762	1870	26x132	SK-1493AQ2	BTKW	
dCi 140	07/03-	G9U 730	2463	25x89; mit Zubehör	SK-1489	BTK	
dCi 150	09/06-	G9U 632	2464	25x89; mit Zubehör	SK-1489	BTK	
2.0	02/03-	F4R 720	1998		0-N1365	TB [DG]	
2.0	02/03-	F4R 720	1998		0-N2380	TB [DG]	
dCi 100, dCi 80	09/02-	F9Q 760, F9Q 762	1870	mit Grundträger	0-N1173	TB [BT]	
dCi 115, dCi 150	09/06-	G9U 632, G9U 720	2464		0-N1269	TB [TE]	
dCi 115, dCi 150	09/06-	G9U 632, G9U 720	2464		0-N1270	TB [DG]	
dCi 140	07/03-	G9U 730	2463		0-N1269	TB [TE]	
dCi 140	07/03-	G9U 730	2463		0-N1270	TB [DG]	
2.0	02/03-	F4R 720	1998		0-N1409	VB [DG]	
2.0	02/03-	F4R 720	1998		0-N1611	VB [BT]	S
2.0	02/03-	F4R 720	1998	☞	0-N1802	VB [BT]	S
dCi 100, dCi 80	09/02-	F9Q 760, F9Q 762	1870		0-N1409	VB [DG]	
dCi 100, dCi 80	09/02-	F9Q 760, F9Q 762	1870		0-N1611	VB [BT]	S
dCi 100, dCi 80	09/02-	F9Q 760, F9Q 762	1870	☞	0-N1802	VB [BT]	S
dCi 115	09/08-	G9U 720	2464	für Fahrzeuge mit Nebenantrieb, ☞	0-N1731	VB [BT]	S
dCi 115	09/08-	G9U 720	2464	☞	0-N1731	VB [BT]	S
dCi 115, dCi 150	09/06-	G9U 632, G9U 720	2464	☞, für Fahrzeuge ohne Nebenantrieb	0-N1875	VB [BT]	S
dCi 120, dCi 90	09/06-	M9R 780, M9R 782	1995		0-N1739	VB [DG]	
dCi 120, dCi 90	09/06-	M9R 780, M9R 782	1995		0-N2039	VB [BT]	S
dCi 140	07/03-	G9U 730	2463		0-N1731	VB [BT]	S
dCi 140	07/03-	G9U 730	2463	☞, für Fahrzeuge ohne Nebenantrieb	0-N1875	VB [BT]	S
dCi 150	09/06-	G9U 632	2464		0-N1731	VB [BT]	S

PRIMERA (P10)

2.0 D	01/91-01/96	CD20	1974	19.05x76; 25x111	SK-1068	BTK	
2.0 D	01/91-01/96	CD20	1974	25x111	SK-1068S	BTK	
2.0 D	01/91-01/96	CD20	1974	19x76	SK-1662	BTK	
2.0 D	01/91-01/96	CD20	1974		0-N027	TB [TE]	
2.0 D	01/91-01/96	CD20	1974		0-N028	TB [TE]	
2.0 D	01/91-01/96	CD20	1974		0-N029	TB [DG]	
1.6	06/93-01/96	GA16DE	1597	Rippenanzahl: 4	0-N2164	VB [TE]	

PRIMERA Hatchback (P10)

2.0 D	01/91-01/96	CD20	1974	19.05x76; 25x111	SK-1068	BTK	
2.0 D	01/91-01/96	CD20	1974	25x111	SK-1068S	BTK	
2.0 D	01/91-01/96	CD20	1974	19x76	SK-1662	BTK	
2.0 D	01/91-01/96	CD20	1974		0-N027	TB [TE]	
2.0 D	01/91-01/96	CD20	1974		0-N028	TB [TE]	
2.0 D	01/91-01/96	CD20	1974		0-N029	TB [DG]	
1.6	06/93-01/96	GA16DE	1597	Rippenanzahl: 4	0-N2164	VB [TE]	

PRIMERA Traveller (W10)

2.0 D	07/90-12/95	CD20	1974	19.05x76; 25x111	SK-1068	BTK	
2.0 D	07/90-12/95	CD20	1974	25x111	SK-1068S	BTK	
2.0 D	07/90-12/95	CD20	1974	19x76	SK-1662	BTK	
2.0 D	07/90-12/95	CD20	1974		0-N027	TB [TE]	
2.0 D	07/90-12/95	CD20	1974		0-N028	TB [TE]	
2.0 D	07/90-12/95	CD20	1974		0-N029	TB [DG]	
1.6 i	02/91-03/98	GA16DE	1597	Rippenanzahl: 4	0-N2164	VB [TE]	



CM³



Art. Nr.



ohne Halter

PRIMERA (P11)							
2.0 TD	09/96-12/01	CD20T	1974	25x111; 19.04x79	SK-1097	BTK	
2.0 TD	09/96-12/01	CD20T	1974	→ 09/1997	0-N027	TB [TE]	
2.0 TD	09/96-12/01	CD20T	1974		0-N028	TB [TE]	
2.0 TD	09/96-12/01	CD20T	1974	10/1997 →	0-N1755	TB [BT]	
1.6 16V	09/96-12/01	GA16DE	1597	→ 06/1999; Rippenanzahl: 4	0-N2164	VB [TE]	
1.6 16V	09/96-12/01	GA16DE	1597	06/1999 →; Rippenanzahl: 4	0-N2165	VB [TE]	
PRIMERA Hatchback (P11)							
2.0 TD	09/96-07/02	CD20T	1974	25x111; 19.04x79	SK-1097	BTK	
2.0 TD	09/96-07/02	CD20T	1974	→ 09/1997	0-N027	TB [TE]	
2.0 TD	09/96-07/02	CD20T	1974		0-N028	TB [TE]	
2.0 TD	09/96-07/02	CD20T	1974	10/1997 →	0-N1755	TB [BT]	
1.6 16V	09/96-07/02	GA16DE	1597	→ 06/1999; Rippenanzahl: 4	0-N2164	VB [TE]	
1.6 16V	09/96-07/02	GA16DE	1597	06/1999 →; Rippenanzahl: 4	0-N2165	VB [TE]	
PRIMERA Traveller (WP11)							
2.0 TD	04/98-12/01	CD20T	1974	25x111; 19.04x79	SK-1097	BTK	
2.0 TD	04/98-12/01	CD20T	1974		0-N028	TB [TE]	
2.0 TD	04/98-12/01	CD20T	1974		0-N1755	TB [BT]	
1.6 16V	04/98-12/01	GA16DE	1597	→ 06/1999; Rippenanzahl: 4	0-N2164	VB [TE]	
1.6 16V	04/98-12/01	GA16DE	1597	06/1999 →; Rippenanzahl: 4	0-N2165	VB [TE]	
PRIMERA (P12)							
1.9 dCi	08/02-	F9Q	1870	26x133	SK-1580	BTK	
1.9 dCi	08/02-	F9Q	1870	26x133	SK-1580AQ1	BTKW	
1.9 dCi	08/02-	F9Q	1870	mit Anbaumaterial	0-N1323	TB [TE]	
1.9 dCi	04/03-	F9Q	1870		0-N1409	VB [DG]	
1.9 dCi	04/03-	F9Q	1870		0-N1611	VB [BT]	S
2.0	03/02-	QR20DE	1998		0-N2211	VB [BT]	S
PRIMERA Hatchback (P12)							
1.9 dCi	08/02-	F9Q	1870	26x133	SK-1580	BTK	
1.9 dCi	08/02-	F9Q	1870	26x133	SK-1580AQ1	BTKW	
1.9 dCi	08/02-	F9Q	1870	mit Anbaumaterial	0-N1323	TB [TE]	
1.9 dCi	04/03-	F9Q	1870		0-N1409	VB [DG]	
1.9 dCi	04/03-	F9Q	1870		0-N1611	VB [BT]	S
2.0	07/02-	QR20DE	1998		0-N2211	VB [BT]	S
PRIMERA Traveller (WP12)							
1.9 dCi	08/02-	F9Q	1870	26x133	SK-1580	BTK	
1.9 dCi	08/02-	F9Q	1870	26x133	SK-1580AQ1	BTKW	
1.9 dCi	08/02-	F9Q	1870	mit Anbaumaterial	0-N1323	TB [TE]	
1.9 dCi	04/03-	F9Q	1870		0-N1409	VB [DG]	
1.9 dCi	04/03-	F9Q	1870		0-N1611	VB [BT]	S
2.0	03/02-	QR20DE	1998		0-N2211	VB [BT]	S
QASHQAI / QASHQAI +2 (J10, JJ10)							
1.5 dCi	02/07-	K9K 410, K9K 430, K9K 732, K9K 764	1461	27x123; mit Zubehör	SK-1487	BTK	
1.5 dCi	02/07-	K9K 410, K9K 430, K9K 732, K9K 764	1461	27x123; Abgasnorm: Euro 5; mit Zubehör	SK-1487AQ3	BTKW	
1.5 dCi	02/07-	K9K 410, K9K 430, K9K 732, K9K 764	1461		0-N1111	TB [TE]	
1.5 dCi	02/07-	K9K 732, K9K 764	1461	08/2008 →	0-N1664	VB [BT]	S
1.5 dCi	02/07-	K9K 410, K9K 430, K9K 732, K9K 764	1461	Rippenanzahl: 6;	0-N1898	VB [BT]	S
1.5 dCi	11/10-	K9K 430	1461		0-N1664	VB [BT]	S
1.6	02/07-	HR16DE	1598	Baumuster: J10E	0-N2240	VB [DG]	
2.0 dCi, 2.0 dCi Allrad	02/07-	M1D, M9R	1995		0-N1739	VB [DG]	
2.0 dCi, 2.0 dCi Allrad	02/07-	M1D, M9R	1995		0-N2039	VB [BT]	S
2.0, 2.0 Allrad	02/07-	MR20DE	1997		0-N1869	VB [BT]	S
QASHQAI (J11, J11_)							
1.5 dCi	11/13-	K9K 636	1461		0-N2423	TB [TE]	
SERENA (C23M)							
2.0 D	11/92-09/01	LD20	1952	30x141	SK-1205	BTK	
2.3 D	01/95-09/01	LD23	2283	30x145; → 08/2000	SK-1475	BTK	
2.0 D	11/92-09/01	LD20	1952		0-N030	TB [TE]	
2.0 D	11/92-09/01	LD20	1952		0-N031	TB [DG]	
2.3 D	01/95-09/01	LD23	2283		0-N030	TB [TE]	
2.3 D	01/95-09/01	LD23	2283		0-N031	TB [DG]	
1.6, 1.6 16V	02/93-09/01	GA16DE	1597	→ 06/1999; Rippenanzahl: 4	0-N2164	VB [TE]	
1.6, 1.6 16V	02/93-09/01	GA16DE	1597	06/1999 →; Rippenanzahl: 4	0-N2165	VB [TE]	



CM³



Art. Nr.



SERENA (C24)								
2.5 DCi SGX, 2.5 DCi SGX 4x4	06/99-09/05	YD25DDTi	2488			0-N2089	VB [BT]	S
SERENA (C25)								
2.0, 2.0 4x4	04/05-11/10	MR20DE	1997			0-N1869	VB [BT]	S
SILVIA (S12)								
1.8	06/84-12/88	CA18ET	1809	19.05x95		SK-1202	BTK	
1.8	06/84-12/88	CA18ET	1809			0-N021	TB [TE]	
STANZA (T11)								
1.6	08/81-12/85	CA16S	1598	19.05x95		SK-1202	BTK	
1.8 SGL	03/83-12/85	CA18S	1809	19.05x95		SK-1202	BTK	
1.6	08/81-12/85	CA16S	1598			0-N021	TB [TE]	
1.8 SGL	03/83-12/85	CA18S	1809			0-N021	TB [TE]	
STANZA Hatchback (T11)								
1.6	08/81-12/85	CA16S	1598	19.05x95		SK-1202	BTK	
1.8	08/81-12/85	CA18, CA18S, CA18S	1809	19.05x95		SK-1202	BTK	
1.6	08/81-12/85	CA16S	1598			0-N021	TB [TE]	
1.8	08/81-12/85	CA18, CA18S, CA18S	1809			0-N021	TB [TE]	
SUNNY I (B11)								
1.7 D	03/82-10/86	CD17	1681	19x76		SK-1662	BTK	
1.3	03/82-09/87	E13	1269			0-N032	TB [TE]	
1.5	03/82-10/86	E15S	1488			0-N032	TB [TE]	
1.7 D	03/82-10/86	CD17	1681			0-N025	TB [TE]	
1.7 D	03/82-10/86	CD17	1681			0-N033	TB [DG]	
SUNNY I Coupe (B11)								
1.5	03/82-10/86	E15S	1488			0-N032	TB [TE]	
SUNNY I Traveller (B11)								
1.7 D	03/82-10/86	CD17	1681	19x76		SK-1662	BTK	
1.3	08/82-08/90	E13	1269			0-N032	TB [TE]	
1.5	03/82-10/86	E15S	1488			0-N032	TB [TE]	
1.7 D	03/82-10/86	CD17	1681			0-N025	TB [TE]	
1.7 D	03/82-10/86	CD17	1681			0-N033	TB [DG]	
SUNNY II (N13)								
1.7 D	06/86-05/89	CD17	1681	19x76		SK-1662	BTK	
1.3	07/86-10/91	E13S	1269			0-N032	TB [TE]	
1.5	06/86-10/88	E15S	1487			0-N032	TB [TE]	
1.6 GTI 16V	02/87-10/88	CA16D	1598			0-N022	TB [TE]	
1.6, 1.6 i, 1.6 i 4x4	06/86-10/90	E16i, E16S	1597			0-N032	TB [TE]	
1.7 D	06/86-05/89	CD17	1681			0-N025	TB [TE]	
1.7 D	06/86-05/89	CD17	1681			0-N027	TB [TE]	
1.7 D	06/86-05/89	CD17	1681			0-N029	TB [DG]	
SUNNY II Coupe (B12)								
1.5	06/86-10/88	E15S	1487			0-N032	TB [TE]	
1.6 GTI 16V	05/87-05/89	CA16D	1598			0-N022	TB [TE]	
1.6, 1.6 i	06/86-05/89	E16i, E16S	1597			0-N032	TB [TE]	
1.8 GTI 16V	01/89-06/91	CA18D	1809			0-N022	TB [TE]	
SUNNY II Hatchback (N13)								
1.7 D	06/86-01/91	CD17	1681	19x76		SK-1662	BTK	
1.3	06/86-10/88	E13S	1269			0-N032	TB [TE]	
1.5	06/86-10/88	E15S	1487			0-N032	TB [TE]	
1.6 GTI 16V	06/87-05/89	CA16D	1598			0-N022	TB [TE]	
1.6, 1.6 i	06/86-10/90	E16i, E16S	1597			0-N032	TB [TE]	
1.7 D	06/86-01/91	CD17	1681			0-N025	TB [TE]	
1.7 D	06/86-01/91	CD17	1681			0-N027	TB [TE]	
1.7 D	06/86-01/91	CD17	1681			0-N029	TB [DG]	
1.8 GTI 16V	01/89-06/91	CA18D	1809			0-N022	TB [TE]	
SUNNY II Traveller (B12)								
1.7 D	01/86-06/91	CD17	1681	19x76; 06/1986 →		SK-1662	BTK	
1.5	06/86-10/88	E15S	1487			0-N032	TB [TE]	
1.6	06/86-10/88	E16S	1597			0-N032	TB [TE]	
1.6 i, 1.6 i 4x4	06/86-05/89	E16i	1598			0-N032	TB [TE]	
1.7 D	01/86-06/91	CD17	1681			0-N025	TB [TE]	
1.7 D	01/86-06/91	CD17	1681			0-N027	TB [TE]	



CM³



Art. Nr.



ohne Halter

SUNNY II Traveller (B12)							
1.7 D	01/86-06/91	CD17	1681		0-N029	TB [DG]	
SUNNY III (N14)							
2.0 D	10/90-05/95	CD20	1974	19.05x76; 25x111	SK-1068	BTK	
2.0 D	10/90-05/95	CD20	1974	25x111	SK-1068S	BTK	
2.0 D	10/90-05/95	CD20	1974	19x76	SK-1662	BTK	
2.0 D	10/90-05/95	CD20	1974		0-N027	TB [TE]	
2.0 D	10/90-05/95	CD20	1974		0-N028	TB [TE]	
2.0 D	10/90-05/95	CD20	1974		0-N029	TB [DG]	
SUNNY III Hatchback (N14)							
2.0 D	10/90-05/95	CD20	1974	19.05x76; 25x111	SK-1068	BTK	
2.0 D	10/90-05/95	CD20	1974	25x111	SK-1068S	BTK	
2.0 D	10/90-05/95	CD20	1974	19x76	SK-1662	BTK	
2.0 D	10/90-05/95	CD20	1974		0-N027	TB [TE]	
2.0 D	10/90-05/95	CD20	1974		0-N028	TB [TE]	
2.0 D	10/90-05/95	CD20	1974		0-N029	TB [DG]	
SUNNY III Liftback (N14)							
2.0 D	10/90-05/95	CD20	1974	19.05x76; 25x111	SK-1068	BTK	
2.0 D	10/90-05/95	CD20	1974	25x111	SK-1068S	BTK	
2.0 D	10/90-05/95	CD20	1974	19x76	SK-1662	BTK	
2.0 D	10/90-05/95	CD20	1974		0-N027	TB [TE]	
2.0 D	10/90-05/95	CD20	1974		0-N028	TB [TE]	
2.0 D	10/90-05/95	CD20	1974		0-N029	TB [DG]	
SUNNY III Traveller (Y10)							
2.0 D	06/91-03/00	CD20	1974	19.05x76; 25x111; → 11/1995	SK-1068	BTK	
2.0 D	06/91-03/00	CD20	1974	25x111; → 11/1995	SK-1068S	BTK	
2.0 D	06/91-03/00	CD20	1974	25x111; 19.04x79; 05/1996 →	SK-1097	BTK	
2.0 D	06/91-03/00	CD20	1974	19x76	SK-1662	BTK	
2.0 D	06/91-03/00	CD20	1974		0-N027	TB [TE]	
2.0 D	06/91-03/00	CD20	1974		0-N028	TB [TE]	
2.0 D	06/91-03/00	CD20	1974		0-N029	TB [DG]	
1.6 i	06/91-03/00	GA16DE	1597	→ 07/1995; Rippenanzahl: 4; ☼	0-N2164	VB [TE]	
1.6 i 16V 4x4	10/92-03/00	GA16DE	1597	→ 07/1995; Rippenanzahl: 4; ☼	0-N2164	VB [TE]	
SUNNY III Kasten (Y10)							
1.7 D	11/90-03/00	CD17	1681	19x76; 11/1991 →	SK-1662	BTK	
1.7 D	11/90-03/00	CD17	1681		0-N025	TB [TE]	
1.7 D	11/90-03/00	CD17	1681		0-N027	TB [TE]	
1.7 D	11/90-03/00	CD17	1681		0-N029	TB [DG]	
1.6 i 16V, 1.6 L	10/92-03/00	GA16DE	1597	→ 07/1995; Rippenanzahl: 4; ☼	0-N2164	VB [TE]	
TEANA I (J31)							
2.0	10/03-06/08	QR20DE	1998	04/2006 →	0-N2211	VB [BT]	S
TERRANO I (WD21)							
3.0 i 4WD	01/90-12/95	VG30E	2960	25.4x133; 08/1993 → 05/1994	SK-1285	BTK	
3.0 i 4WD	01/90-12/95	VG30E	2960		0-N024	TB [TE]	
TERRANO II (R20)							
3.0 Di 4WD	05/02-09/07	ZD30	2953		0-N1732	VB [BT]	S
TIIDA Schrägheck							
1.5, 1.5 4x4	05/04-02/07	HR15DE	1498		0-N2240	VB [DG]	
1.6, 1.6 4x4	05/04-02/07	HR16DE	1598		0-N2240	VB [DG]	
1.8	05/04-02/07	MR18DE	1798		0-N1869	VB [BT]	S
1.8, 1.8 4x4	05/04-02/07	HR18DE	1769		0-N2240	VB [DG]	
TIIDA Schrägheck (C11X)							
1.5 dCi	09/07-	K9K 728	1461	27x123; mit Zubehör	SK-1487	BTK	
1.5 dCi	09/07-	K9K 728	1461		0-N1111	TB [TE]	
1.5 dCi	09/07-	K9K 728	1461		0-N1664	VB [BT]	S
1.6	09/07-	HR16DE	1598		0-N2240	VB [DG]	
1.8	09/07-	MR18DE	1798		0-N1869	VB [BT]	S
TIIDA Schrägheck (C12)							
1.6	08/12-	HR16DE	1598		0-N2240	VB [DG]	
TIIDA Stufenheck (C12)							
1.6	08/11-	HR16DE	1598		0-N2240	VB [DG]	

CM³

Art. Nr.



ohne Halter

TIIDA Stufenheck (SC11X)

1.5 dCi	01/07-	K9K, K9K 772	1461	27x123; mit Zubehör	SK-1487	BTK	
1.5 dCi	09/07-	K9K	1461		0-N1111	TB [TE]	
1.5 dCi	09/07-	K9K	1461		0-N1664	VB [BT]	S
1.6	09/07-	HR16DE	1598		0-N2240	VB [DG]	
1.8	09/07-	MR18DE	1798		0-N1869	VB [BT]	S

TRADE Kasten

2.0 D	11/86-03/93	LD20	1952	30x141	SK-1205	BTK	
-------	-------------	------	------	--------	---------	-----	--

TRADE Pritsche/Fahrgestell

2.0 D	11/86-03/93	LD20	1952	30x141	SK-1205	BTK	
-------	-------------	------	------	--------	---------	-----	--

TRADE Kasten

2.0 D	04/93-10/98	LD20	1952	30x141	SK-1205	BTK	
2.0 D	04/93-10/98	LD20	1952		0-N030	TB [TE]	
2.0 D	04/93-10/98	LD20	1952		0-N031	TB [DG]	

TRADE Pritsche/Fahrgestell

2.0 D	04/93-10/98	LD20	1952	30x141	SK-1205	BTK	
2.0 D	04/93-10/98	LD20	1952		0-N030	TB [TE]	
2.0 D	04/93-10/98	LD20	1952		0-N031	TB [DG]	

TRADE Kasten/Kombi

75	05/97-12/00	LD23	2283	30x145	SK-1475	BTK	
----	-------------	------	------	--------	---------	-----	--

TRADE Pritsche/Fahrgestell

2.3 D	06/96-10/01	LD23	2283	30x145; → 05/2001	SK-1475	BTK	
2.3 D	06/96-10/01	LD23	2283		0-N030	TB [TE]	
2.3 D	06/96-10/01	LD23	2283		0-N031	TB [DG]	

TRADE Pritsche/Fahrgestell

2.3 D	11/98-04/01	LD23	2283	30x145	SK-1475	BTK	
2.3 D	11/98-04/01	LD23	2283		0-N030	TB [TE]	
2.3 D	11/98-04/01	LD23	2283		0-N031	TB [DG]	

VANETTE Bus (C22)

2.0 D	10/86-12/95	LD20	1952	30x141	SK-1205	BTK	
2.0 D	10/86-12/95	LD20	1952		0-N030	TB [TE]	
2.0 D	10/86-12/95	LD20	1952		0-N031	TB [DG]	

VANETTE Kasten (C22)

2.0 D	07/91-01/95	LD20II	1952	30x141	SK-1205	BTK	
2.0 D	07/91-01/95	LD20II	1952		0-N030	TB [TE]	
2.0 D	07/91-01/95	LD20II	1952		0-N031	TB [DG]	

VANETTE CARGO Bus (HC 23)

2.0 D	01/96-	LD20	1952	30x141	SK-1205	BTK	
2.3 D	01/96-	LD23	2283	30x145; → 05/2001	SK-1475	BTK	
2.0 D	01/96-	LD20	1952		0-N030	TB [TE]	
2.0 D	01/96-	LD20	1952		0-N031	TB [DG]	
2.3 D	01/96-	LD23	2283		0-N030	TB [TE]	
2.3 D	01/96-	LD23	2283		0-N031	TB [DG]	

VANETTE CARGO Kasten (HC 23)

2.0 D	01/95-	LD20	1952	30x141	SK-1205	BTK	
2.3 D	01/95-	LD23	2283	30x145; → 05/2002	SK-1475	BTK	
2.0 D	01/95-	LD20	1952		0-N030	TB [TE]	
2.0 D	01/95-	LD20	1952		0-N031	TB [DG]	
2.3 D	01/95-	LD23	2283		0-N030	TB [TE]	
2.3 D	01/95-	LD23	2283		0-N031	TB [DG]	

X-TRAIL (T30)

2.0, 2.0 4x4	07/01-01/13	QR20DE	1998		0-N2211	VB [BT]	S
2.5 4x4	09/02-01/13	QR25DE	2488		0-N2211	VB [BT]	S
2.2 dCi, 2.2 dCi 4x4, 2.2 DCi FWD, 2.2 Di 4x4	06/01-01/13	YD22DDTi, YD22ETi	2184		0-N2099	FB [DG]	

X-TRAIL (T31)

2.0 dCi, 2.0 dCi FWD	06/07-11/13	M9R, M9R 760	1995		0-N1739	VB [DG]	
2.0 dCi, 2.0 dCi FWD	06/07-11/13	M9R, M9R 760	1995		0-N2039	VB [BT]	S
2.0, 2.0 FWD	03/07-11/13	MR20DE	1997		0-N1869	VB [BT]	S
2.0, 2.0 FWD	06/08-11/13	MR20DE	1998		0-N1869	VB [BT]	S
2.5	06/07-11/13	QR25DE	2488		0-N2211	VB [BT]	S



CM³



Art. Nr.



ohne Halter

NOTE (E12)

1.5 dCi	06/13-	K9K 892, K9K 892	1461		0-N2423	TB [TE]	
1.2	06/13-	HR12DE	1198		0-N2240	VB [DG]	
1.5 dCi	06/13-	K9K 892, K9K 892	1461		0-N2290	VB [BT]	S

SYLPHY III Stufenheck (B17)

1.6	08/12-	HR16DE	1598		0-N2240	VB [DG]	
-----	--------	--------	------	--	----------------	---------	--

PULSAR Schrägheck (C13)

1.5 dCi	10/14-	K9K	1461	27x123; Abgasnorm: Euro 5; mit Zubehör	SK-1487AQ3	BTKW	
1.5 dCi	10/14-	K9K	1461		0-N2423	TB [TE]	



OPTIMAL®

NISSAN (DONGFENG)

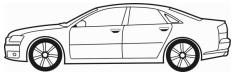

CM³



Art. Nr.



ohne Halter

QASHQAI

2.0, 2.0 4x4	03/08-12/10	MR20DE	1997		0-N1869	VB [BT]	S
--------------	-------------	--------	------	--	----------------	---------	----------

TEANA (J31)

2.0	04/06-06/08	MR20DE, QR 20 DE	1998	✳	0-N2211	VB [BT]	S
-----	-------------	------------------	------	---	----------------	---------	----------



CM³



Art. Nr.



ohne Halter

PALADIN

3.3 AWD	02/03-	VG33E	3274	0-N024	TB [TE]
---------	--------	-------	------	--------	---------



OPTIMAL®

OLDSMOBILE



CM³



Art. Nr.



ohne Halter

CUTLASS SUPREME Coupe

3.1 V6	09/88-	LH0	3135		0-N1848	VB [BT]	S
3.4 V6	09/90-	6V <X MPI>, LQ1	3350		0-N1848	VB [BT]	S

INTRIGUE Stufenheck

3.8	09/97-12/99	L36	3791	Baumuster: I-> 1998	0-N1685	VB [DG]	
-----	-------------	-----	------	------------------------	----------------	---------	--



CM³



Art. Nr.



ohne Halter

ADAM								
1.2	10/12-	A 12 XEL, B 12 XEL	1229			0-N2170	VB [BT]	S
1.2	07/13-		1242			0-N2170	VB [BT]	S
1.4, 1.4 LPG	10/12-	A 14 XEL, B 14 XEL, A 14 XER, B 14 XER	1398			0-N2170	VB [BT]	S
AGILA (A) (H00)								
1.0	08/03-12/07	Z 10 XEP	998			0-N2170	VB [BT]	S
1.0 12V	09/00-12/07	Z 10 XE	973			0-N2170	VB [BT]	S
1.2 16V	09/00-12/07	Z 12 XE	1199			0-N2170	VB [BT]	S
1.2 16V Twinport	07/04-12/07	Z 12 XEP	1229			0-N2170	VB [BT]	S
1.3 CDTI	08/03-12/07	Z 13 DT	1248			0-N1526	VB [BT]	S
AGILA (B) (H08)								
1.3 CDTI	04/08-	D13A, Z 13 DTJ	1248			0-N1526	VB [BT]	S
ANTARA								
2.0 CDTI	05/06-	Z 20 DMH, Z 20 S	1991	22x151; 08/2006 →		SK-1723	BTK	
2.0 CDTI	05/06-	Z 20 DM, Z 20 DMH, Z 20 S, Z 20 S	1991	22x151		SK-1723AQ1	BTKW	
2.0 CDTI	03/07-	Z 20 DM, Z 20 S	1991	22x151		SK-1723	BTK	
2.4, 2.4 4x4, 2.4 LPG, 2.4 LPG 4x4	05/06-	Z 24 XE, Z 24 XED	2405	24x171		SK-1644	BTK	
2.4, 2.4 4x4, 2.4 LPG, 2.4 LPG 4x4	05/06-	Z 24 XE, Z 24 XED	2405	24x171		SK-1644AQ1	BTKW	
2.0 CDTI	05/06-	Z 20 DM, Z 20 DMH, Z 20 S, Z 20 S	1991			0-N1952	TB [TE]	
2.0 CDTI	05/06-	Z 20 DM, Z 20 DMH, Z 20 S, Z 20 S	1991			0-N1960	TB [TE]	
2.4	05/06-	Z 24 XE, Z 24 XED	2405			0-N1383	TB [TE]	
2.4	05/06-	Z 24 XE, Z 24 XED	2405			0-N906	TB [DG]	
2.0 CDTI	05/06-	Z 20 DM, Z 20 DMH, Z 20 S, Z 20 S	1991			0-N2171	VB [DG]	
2.0 CDTI	05/06-	Z 20 DM, Z 20 DMH, Z 20 S, Z 20 S	1991			0-N2197	VB [BT]	S
2.2 CDTi, 2.2 CDTi 4x4	12/10-	A 22 DM, A 22 DMH	2231			0-N2420	VB [DG]	
2.2 CDTi, 2.2 CDTi 4x4	12/10-	A 22 DM, A 22 DMH	2231			0-N2421	VB [DG]	
2.4, 2.4 4x4	12/10-	A 24 XE	2384			0-N2283	VB [DG]	
2.4, 2.4 4x4	12/10-	A 24 XE	2384			0-N2299	VB [BT]	S
2.4, 2.4 4x4, 2.4 LPG, 2.4 LPG 4x4	05/06-	Z 24 XE, Z 24 XED	2405			0-N1422	VB [BT]	S
3.0	11/10-	A 30 XH	2997			0-N2194	VB [BT]	S
3.0	11/10-	A 30 XH	2997			0-N2340	VB [DG]	
3.2 V6	03/07-	10 HM, Z 32 SEE	3195			0-N2194	VB [BT]	S
3.2 V6	03/07-	10 HM, Z 32 SEE	3195			0-N2340	VB [DG]	
ARENA Bus								
1.9 D	01/97-12/01	19 DJ, 19 DL	1870	25.4x153; 03/1998 →		SK-1107	BTK	
2.5 D	01/97-12/01	25 DG, 25 DM	2499	30x152; 03/1998 →		SK-1035	BTK	
2.5 D	01/97-12/01	25 DG, 25 DM	2499	30x152; 03/1998 →; mit Spanndämpfer, Spannrolle		SK-1680	BTK	
ARENA Combi (THB)								
1.9 D	03/98-08/01	F8Q 600, F8Q 606	1870	25.4x153		SK-1107	BTK	
2.5 D	03/98-08/01	S8U 758, S8U 780, S8U 782	2499	30x152		SK-1035	BTK	
2.5 D	03/98-08/01	S8U 758, S8U 780, S8U 782	2499	30x152; mit Spanndämpfer, Spannrolle		SK-1680	BTK	
1.9 D	03/98-08/01	F8Q 600, F8Q 606	1870			0-N147	TB [DG]	
1.9 D	03/98-08/01	F8Q 600, F8Q 606	1870			0-N173	TB [TE]	
1.9 D	03/98-08/01	F8Q 600, F8Q 606	1870			0-N854	TB [DG]	
2.5 D	03/98-08/01	S8U 758, S8U 780, S8U 782	2499			0-N1617	TB [BT]	
2.5 D	03/98-08/01	S8U 758, S8U 780, S8U 782	2499			0-N816	TB [DG]	
2.5 D	03/98-08/01	S8U 758, S8U 780, S8U 782	2499			0-N821	TB [DG]	
ARENA Kasten								
1.9 D	01/97-12/01	19 DJ, 19 DL	1870	25.4x153; 03/1998 →		SK-1107	BTK	
2.5 D	01/97-12/01	25 DG, 25 DM	2499	30x152; 03/1998 →		SK-1035	BTK	
2.5 D	01/97-12/01	25 DG, 25 DM	2499	30x152; 03/1998 →; mit Spanndämpfer, Spannrolle		SK-1680	BTK	
ARENA Kasten (TB, TF)								
1.9 D	03/98-08/01	F8Q 600, F8Q 606	1870	25.4x153		SK-1107	BTK	
2.5 D	03/98-08/01	S8U 758, S8U 780, S8U 782	2499	30x152		SK-1035	BTK	
2.5 D	03/98-08/01	S8U 758, S8U 780, S8U 782	2499	30x152; mit Spanndämpfer, Spannrolle		SK-1680	BTK	
1.9 D	03/98-08/01	F8Q 600, F8Q 606	1870			0-N147	TB [DG]	
1.9 D	03/98-08/01	F8Q 600, F8Q 606	1870			0-N173	TB [TE]	
1.9 D	03/98-08/01	F8Q 600, F8Q 606	1870			0-N854	TB [DG]	
2.5 D	03/98-08/01	S8U 758, S8U 780, S8U 782	2499			0-N1617	TB [BT]	
2.5 D	03/98-08/01	S8U 758, S8U 780, S8U 782	2499			0-N816	TB [DG]	
2.5 D	03/98-08/01	S8U 758, S8U 780, S8U 782	2499			0-N821	TB [DG]	

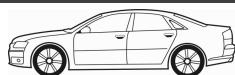

CM³



Art. Nr.



ohne Halter

ASTRA F CC (53_, 54_, 58_, 59_)

1.6 i, 1.6 i 16V, 1.6 Si	09/91-01/98	C 16 NZ, X 16 SZR, C 16 SE, X 16 SZ, X 16 XEL	1598		0-N1422	VB [BT]	S
1.6 i, 1.6 Si	09/91-01/98	C 16 NZ, X 16 SZR, C 16 SE, X 16 SZ	1598		0-N948	TB [TE]	
1.6, 1.6 i, 1.6 i 16V, 1.6 Si	09/91-01/98	16 LZ2, 16 NZR,	1598	Rippenanzahl: 6	0-N1439	VB [DG]	
1.6, 1.6 i, 1.6 i 16V, 1.6 Si	09/91-01/98	16 LZ2, 16 NZR,	1598	für Fahrzeuge ohne Servolenkung	0-N1464	VB [BT]	S
1.8 i	09/91-01/98	C 18 NZ	1796		0-N1422	VB [BT]	S
1.8 i 16V	06/93-01/98	C 18 XE, C 18 XEL, X 18 XE	1799		0-N1422	VB [BT]	S
2.0 GSI 16V, 2.0 i, 2.0 i 16V	09/91-01/98	C 20 NE, C 20 XE, X 20 XEV	1998		0-N1422	VB [BT]	S

ASTRA F CLASSIC Caravan

1.4 i	01/98-01/05	X 14 NZ	1389	17x111; mit Zubehör	SK-1162	BTK	
1.4 i	01/98-01/05	X 14 NZ	1389	17x111; mit Zubehör	SK-1162AQ1	BTKW	
1.6 i	01/98-01/05	X 16 SZR	1598	17x111; mit Zubehör	SK-1162	BTK	
1.6 i	01/98-01/05	X 16 SZR	1598	17x111; mit Zubehör	SK-1162AQ1	BTKW	
1.6 i 16V	01/98-01/05	X 16 XEL	1598	20x169; mit Zubehör	SK-1073	BTK	
1.6 i 16V	01/98-01/05	X 16 XEL	1598	20x169; :→02MV7224, 20U75998; mit Zubehör	SK-1073AQ1	BTKW	
1.6 i 16V	01/98-01/05	X 16 XEL	1598	20x169; :02MV7225, 20U75999→	SK-1073AQ3	BTKW	
1.6 i 16V	01/98-01/05	X 16 XEL	1598		0-N102	TB [TE]	
1.6 i 16V	01/98-01/05	X 16 XEL	1598		0-N952	TB [DG]	
1.6 i 16V	01/98-01/05	X 16 XEL	1598		0-N953	TB [DG]	
1.8	02/03-07/04	Z 18 XEL	1796		0-N102	TB [TE]	
1.8	02/03-07/04	Z 18 XEL	1796	:02HL5118, 20041691→; ; mit Anbaumaterial	0-N300	TB [DG]	
1.8	02/03-07/04	Z 18 XEL	1796	:→02HL5117, 20041690	0-N952	TB [DG]	
1.8	02/03-07/04	Z 18 XEL	1796		0-N953	TB [DG]	
1.4 Comfort	09/03-01/05	Z 14 XEP	1364		0-N2170	VB [BT]	S
1.4 i	01/98-01/05	X 14 NZ	1389		0-N948	TB [TE]	
1.6 i	01/98-01/05	X 16 SZR	1598		0-N948	TB [TE]	
1.8	02/03-07/04	Z 18 XEL	1796		0-N1466	VB [BT]	S

ASTRA F CLASSIC CC

1.4 i	01/98-08/02	X 14 NZ	1389	17x111; mit Zubehör	SK-1162	BTK	
1.4 i	01/98-08/02	X 14 NZ	1389	17x111; mit Zubehör	SK-1162AQ1	BTKW	
1.4 i	03/98-08/00	X 14 XE	1389	20x169; mit Zubehör	SK-1073	BTK	
1.6 i	01/98-08/02	X 16 SZR	1598	17x111; mit Zubehör	SK-1162AQ1	BTKW	
1.6 i 16V	01/98-08/02	X 16 XEL	1598	20x169; mit Zubehör	SK-1073	BTK	
1.6 i 16V	01/98-08/02	X 16 XEL	1598	20x169; :→02MV7224, 20U75998; mit Zubehör	SK-1073AQ1	BTKW	
1.6 i 16V	01/98-08/02	X 16 XEL	1598	20x169; :02MV7225, 20U75999→	SK-1073AQ3	BTKW	
1.6 i, 1.6 i 16V	01/98-08/02	X 16 SZR, X 16 XEL	1598	17x111; mit Zubehör	SK-1162	BTK	
1.4 i	03/98-08/00	X 14 XE	1389		0-N102	TB [TE]	
1.4 i	03/98-08/00	X 14 XE	1389		0-N952	TB [DG]	
1.4 i	03/98-08/00	X 14 XE	1389		0-N953	TB [DG]	
1.6 i 16V	01/98-08/02	X 16 XEL	1598		0-N102	TB [TE]	
1.6 i 16V	01/98-08/02	X 16 XEL	1598		0-N952	TB [DG]	
1.6 i 16V	01/98-08/02	X 16 XEL	1598		0-N953	TB [DG]	
1.7 TD	03/98-08/00	X 17 DTL	1699		0-N100	TB [TE]	
1.7 TD	03/98-08/00	X 17 DTL	1699		0-N909	TB [DG]	
1.8 i	03/98-08/00	X 18 XE1	1796		0-N102	TB [TE]	
1.8 i	03/98-08/00	X 18 XE1	1796	:02HL5118, 20041691→; ; mit Anbaumaterial	0-N300	TB [DG]	
1.8 i	03/98-08/00	X 18 XE1	1796	:→02HL5117, 20041690	0-N952	TB [DG]	
1.8 i	03/98-08/00	X 18 XE1	1796		0-N953	TB [DG]	
2.0 i	03/98-08/00	X 20 XEV	1998		0-N100	TB [TE]	
2.0 i	03/98-08/00	X 20 XER, X 20 XEV	1998		0-N127	TB [DG]	
2.0 i	10/99-08/00	X 20 XER	1998		0-N1369	TB [TE]	
1.2 i	03/98-08/00	X 12 XE	1199		0-N2170	VB [BT]	S
1.4 i	01/98-08/02	X 14 NZ	1389		0-N948	TB [TE]	

CM³

Art. Nr.



ASTRA F CLASSIC CC								
1.4 i	03/98-08/00	X 14 XE	1389			0-N1322	VB [TE]	S
1.4 i	03/98-08/00	X 14 XE	1389			0-N1422	VB [BT]	S
1.4 i	03/98-08/00	X 14 XE	1389	für Fahrzeuge ohne Servolenkung		0-N1464	VB [BT]	S
1.6 i	01/98-08/02	X 16 SZR	1598			0-N948	TB [TE]	
1.8 i	03/98-08/00	X 18 XE1	1796			0-N1422	VB [BT]	S
2.0 Di, 2.0 DTi	03/98-08/00	X 20 DTH, X 20 DTL	1995	Rippenanzahl: 6		0-N1437	VB [DG]	
2.0 Di, 2.0 DTi	03/98-08/00	X 20 DTH, X 20 DTL	1995			0-N1485	VB [BT]	S
2.0 Di, 2.0 DTi	03/98-08/00	X 20 DTH, X 20 DTL	1995			0-N2169	VB [VD]	
2.0 i	03/98-08/00	X 20 XER, X 20 XEV	1998			0-N1422	VB [BT]	S

ASTRA F CLASSIC Stufenheck								
1.4 i	01/98-08/02	X 14 NZ	1389	17x111; mit Zubehör		SK-1162	BTK	
1.4 i	01/98-08/02	X 14 NZ	1389	17x111; mit Zubehör		SK-1162AQ1	BTKW	
1.6 i	01/98-08/02	X 16 SZR	1598	17x111; mit Zubehör		SK-1162AQ1	BTKW	
1.6 i 16V	01/98-08/02	X 16 XEL	1598	20x169; mit Zubehör		SK-1073	BTK	
1.6 i 16V	01/98-08/02	X 16 XEL	1598	20x169; :→02MV7224, 20U75998; mit Zubehör		SK-1073AQ1	BTKW	
1.6 i 16V	01/98-08/02	X 16 XEL	1598	20x169; :02MV7225, 20U75999→		SK-1073AQ3	BTKW	
1.6 i, 1.6 i 16V	01/98-08/02	X 16 SZR, X 16 XEL	1598	17x111; mit Zubehör		SK-1162	BTK	
1.6 i 16V	01/98-08/02	X 16 XEL	1598			0-N102	TB [TE]	
1.6 i 16V	01/98-08/02	X 16 XEL	1598			0-N952	TB [DG]	
1.6 i 16V	01/98-08/02	X 16 XEL	1598			0-N953	TB [DG]	
1.4 i	01/98-08/02	X 14 NZ	1389			0-N948	TB [TE]	
1.6 i	01/98-08/02	X 16 SZR	1598			0-N948	TB [TE]	

ASTRA F Van (55_)								
1.4 i	10/91-01/99	C 14 NZ	1389	17x111; mit Zubehör		SK-1162	BTK	
1.4 i	10/91-01/99	C 14 NZ	1389	17x111; mit Zubehör		SK-1162AQ1	BTKW	
1.6 i	10/91-07/96	C 16 NZ, X 16 SZ	1598	17x111; mit Zubehör		SK-1162	BTK	
1.6 i	10/91-07/96	C 16 NZ, X 16 SZ	1598	17x111; mit Zubehör		SK-1162AQ1	BTKW	
1.6 i 16V	08/94-03/98	X 16 XEL	1598	20x169; mit Zubehör		SK-1073	BTK	
1.6 i 16V	08/94-03/98	X 16 XEL	1598	20x169; mit Zubehör		SK-1073AQ1	BTKW	
1.7 D	12/91-09/92	17 D	1700	24x146		SK-1037	BTK	
1.7 D	12/91-09/92	17 D	1700	24x146; :→14363650		SK-1037AQ1	BTKW	
1.7 D	12/91-09/92	17 D	1700	24x176; :14363651→		SK-1038	BTK	
1.7 D, 1.7 TD	12/91-01/99	17 D, 17 DR, X 17 DTL	1700	24x176; :14363652→		SK-1038AQ1	BTKW	
1.7 D, 1.7 TD	07/92-01/99	17 DR, X 17 DTL	1700	24x176		SK-1038	BTK	
1.7 TD	03/95-02/98	X 17 DT (TC4EE1)	1686	25.4x136; P4999999; mit Zubehör		SK-1164	BTK	
1.7 TD	03/95-02/98	X 17 DT (TC4EE1)	1686	25.4x136; R2599999, R5999999; mit Zubehör		SK-1164	BTK	
1.7 TD	03/95-02/98	X 17 DT (TC4EE1)	1686	25.4x136; R6599999, R8999999; mit Zubehör		SK-1164	BTK	
1.7 D	12/91-09/92	17 D	1700	:14363651→		0-N100	TB [TE]	
1.7 D	12/91-09/92	17 D	1700	:→14363650		0-N875	TB [DG]	
1.7 D	12/91-09/92	17 D	1700	:14363651→		0-N909	TB [DG]	
1.7 D, 1.7 TD	07/92-01/99	17 DR, X 17 DTL	1700			0-N100	TB [TE]	
1.7 D, 1.7 TD	07/92-01/99	17 DR, X 17 DTL	1700			0-N909	TB [DG]	
1.7 TD	03/95-02/98	X 17 DT (TC4EE1)	1686			0-N878	TB [DG]	
1.4 i	10/91-01/99	C 14 NZ	1389			0-N1322	VB [TE]	S
1.4 i	10/91-01/99	C 14 NZ	1389			0-N1422	VB [BT]	S
1.4 i	10/91-01/99	C 14 NZ	1389	Rippenanzahl: 6		0-N1439	VB [DG]	
1.4 i	10/91-01/99	C 14 NZ	1389	für Fahrzeuge ohne Servolenkung		0-N1464	VB [BT]	S
1.4 i	10/91-01/99	C 14 NZ	1389	:19311739→		0-N948	TB [TE]	
1.6 i	10/91-07/96	C 16 NZ, X 16 SZ	1598			0-N1322	VB [TE]	S
1.6 i	10/91-07/96	C 16 NZ, X 16 SZ	1598			0-N1422	VB [BT]	S
1.6 i	10/91-07/96	C 16 NZ, X 16 SZ	1598	Rippenanzahl: 6		0-N1439	VB [DG]	
1.6 i	10/91-07/96	C 16 NZ, X 16 SZ	1598	für Fahrzeuge ohne Servolenkung		0-N1464	VB [BT]	S
1.6 i	10/91-07/96	C 16 NZ, X 16 SZ	1598			0-N948	TB [TE]	

ASTRA G Cabriolet (F67)								
1.6	01/03-10/05	Z 16 XEP	1598	24x146; 10/2003 →		SK-1607	BTK	
1.6 16V	03/01-10/05	Z 16 XE	1598	20x162; :→02HL5117, 20041690; mit Zubehör		SK-1113	BTK	
1.6 16V	03/01-10/05	Z 16 XE	1598	20x162; :→02HL5117, 20041690; mit Zubehör		SK-1113AQ1	BTKW	
1.6 16V	03/01-10/05	Z 16 XE	1598	20x162; :02HL5118, 20041691→; mit Zubehör		SK-1355	BTK	

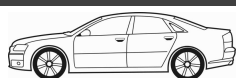

CM³



Art. Nr.



ohne Halter

ASTRA G Cabriolet (F67)							
1.6 16V	03/01-10/05	Z 16 XE	1598	20x162; :02MV7225, 20U75999→; mit Zubehör	SK-1355AQ2	BTKW	
1.6 16V	03/01-10/05	Z 16 XE	1598	20x162; :02HL5118, 20041691→; :→02MV7224	SK-1355AQ3	BTKW	
1.8 16V	03/01-10/05	Z 18 XE	1796	20x162; :→02HL5117, 20041690; mit Zubehör	SK-1113	BTK	
1.8 16V	03/01-10/05	Z 18 XE	1796	20x162; :02HL5118, 20041691→; mit Zubehör	SK-1355	BTK	
1.8 16V	03/01-10/05	Z 18 XE	1796	20x162; :02HL5118, 20041691→; mit Zubehör	SK-1355AQ1	BTKW	
2.0 16V Turbo, 2.0 OPC	03/02-10/05	Z 20 LET	1998	24x168; ch.→32999999, 35999999	SK-1632	BTK	
2.0 16V Turbo, 2.0 OPC	03/02-10/05	Z 20 LET	1998	24x168; ch.→36999999, 38999999	SK-1632	BTK	
2.0 16V Turbo, 2.0 OPC	03/02-10/05	Z 20 LET	1998	24x168; ch.→3B999999, 3H999999	SK-1632	BTK	
2.0 16V Turbo, 2.0 OPC	03/02-10/05	Z 20 LET	1998	24x168; ch.→32999999, 35999999, 36999999, 38999999, 3B999999, 3G999999, 3H999999	SK-1632AQ1	BTKW	
2.0 16V Turbo, 2.0 OPC	03/02-10/05	Z 20 LET	1998	24x168; ch.42000001, 45000001, 48000001, 4B000001, 4G000001, 4H000001→	SK-1667	BTK	
2.0 16V Turbo, 2.0 OPC	03/02-10/05	Z 20 LET	1998	24x168; ch.42000001, 45000001, 48000001, 4B000001, 4G000001, 4H000001→	SK-1667AQ1	BTKW	
1.6	01/03-10/05	Z 16 XEP	1598		0-N1347	TB [TE]	
1.6	01/03-10/05	Z 16 XEP	1598		0-N1348	TB [DG]	
1.6 16V	03/01-10/05	Z 16 XE	1598		0-N102	TB [TE]	
1.6 16V	03/01-10/05	Z 16 XE	1598	:02HL5118, 20041691→; †; mit Anbaumaterial	0-N300	TB [DG]	
1.6 16V	03/01-10/05	Z 16 XE	1598	:→02HL5117, 20041690	0-N952	TB [DG]	
1.6 16V	03/01-10/05	Z 16 XE	1598		0-N953	TB [DG]	
1.8 16V	03/01-10/05	Z 18 XE	1796		0-N102	TB [TE]	
1.8 16V	03/01-10/05	Z 18 XE	1796	:02HL5118, 20041691→; †; mit Anbaumaterial	0-N300	TB [DG]	
1.8 16V	03/01-10/05	Z 18 XE	1796	:→02HL5117, 20041690	0-N952	TB [DG]	
1.8 16V	03/01-10/05	Z 18 XE	1796		0-N953	TB [DG]	
2.0 16V Turbo, 2.0 OPC	03/02-10/05	Z 20 LET	1998	→ 12/2003	0-N127	TB [DG]	
2.0 16V Turbo, 2.0 OPC	03/02-10/05	Z 20 LET	1998	01/2004 →	0-N127	TB [DG]	
2.0 16V Turbo, 2.0 OPC	03/02-10/05	Z 20 LET	1998		0-N1369	TB [TE]	
2.0 16V Turbo, 2.0 OPC	03/02-10/05	Z 20 LET	1998	01/2004 →	0-N1574	TB [DG]	
1.6	01/03-10/05	Z 16 XEP	1598		0-N1799	VB [BT]	S
1.6 16V	03/01-10/05	Z 16 XE	1598		0-N1466	VB [BT]	S
1.8 16V	03/01-10/05	Z 18 XE	1796		0-N1466	VB [BT]	S
2.0 16V Turbo, 2.0 OPC	03/02-10/05	Z 20 LET	1998		0-N1422	VB [BT]	S
2.2 16V	03/01-10/05	Z 22 SE	2198		0-N1588	VB [BT]	S
2.2 DTI	09/02-10/05	Y 22 DTR	2172	Rippenanzahl: 6	0-N1437	VB [DG]	
2.2 DTI	09/02-10/05	Y 22 DTR	2172		0-N1485	VB [BT]	S
2.2 DTI	09/02-10/05	Y 22 DTR	2172		0-N2169	VB [VD]	
ASTRA G Caravan (F35_)							
1.4 16V	06/98-07/04	X 14 XE, Z 14 XE	1389	20x162; :→02HL5117, 20041690; mit Zubehör	SK-1113	BTK	
1.4 16V	06/98-07/04	X 14 XE, Z 14 XE	1389	20x162; :→02HL5117, 20041690; mit Zubehör	SK-1113AQ1	BTKW	
1.4 16V	06/98-07/04	X 14 XE, Z 14 XE	1389	20x162; :02HL5118, 20041691→; mit Zubehör	SK-1355	BTK	
1.4 16V	06/98-07/04	X 14 XE, Z 14 XE	1389	20x162; :02MV7225, 20U75999→; mit Zubehör	SK-1355AQ2	BTKW	
1.4 16V	06/98-07/04	X 14 XE, Z 14 XE	1389	20x162; :02HL5118, 20041691→; :→02MV7224	SK-1355AQ3	BTKW	
1.6	02/98-07/04	X 16 SZR, Z 16 SE	1598	17x111; mit Zubehör	SK-1162	BTK	
1.6	02/98-07/04	X 16 SZR, Z 16 SE	1598	17x111; :→02MZ5253, 20U75998; mit Zubehör	SK-1162AQ1	BTKW	
1.6	02/98-09/00	X 16 SZR	1598	17x111; :02MZ5254→	SK-1162AQ2	BTKW	
1.6	09/00-07/04	Z 16 SE	1598	17x111; :02MZ5254, 20U75999→	SK-1162AQ2	BTKW	
1.6	12/02-07/09	Z 16 XEP	1598	24x146	SK-1607	BTK	
1.6 16V	02/98-07/04	X 16 XEL, Z 16 XE	1598	20x162; :→02HL5117, 20041690; mit Zubehör	SK-1113AQ1	BTKW	
1.6 16V	02/98-07/04	X 16 XEL, Z 16 XE	1598	20x162; :02HL5118, 20041691→; mit Zubehör	SK-1355	BTK	
1.6 16V	02/98-07/04	X 16 XEL, Z 16 XE	1598	20x162; :02MV7225, 20U75999→; mit Zubehör	SK-1355AQ2	BTKW	
1.6 16V	02/98-07/04	X 16 XEL, Z 16 XE	1598	20x162; :02HL5118, 20041691→; :→02MV7224	SK-1355AQ3	BTKW	



CM³



Art. Nr.



ohne Halter

ASTRA G Caravan (F35_)

1.6 16V, 1.6 CNG	02/98-07/04	X 16 XEL, Z 16 XE, Z 16 YNG	1598	20x162; :→02HL5117, 20041690; mit Zubehör	SK-1113	BTK	
1.6 CNG	03/03-07/04	Z 16 YNG	1598	20x162; mit Zubehör	SK-1355	BTK	
1.6 CNG	03/03-07/04	Z 16 YNG	1598	20x162; mit Zubehör	SK-1355AQ2	BTKW	
1.7 CDTI	04/03-07/09	Z 17 DTL	1686	25x129; mit Zubehör	SK-1612	BTK	
1.7 DTI 16V	02/00-07/04	Y 17 DT	1686	25x131; mit Zubehör	SK-1479	BTK	
1.7 DTI 16V	02/00-07/04	Y 17 DT	1686	25x131; :0328705→; mit Zubehör	SK-1481	BTK	
1.7 DTI 16V	02/00-07/04	Y 17 DT	1686	25x131; :→0328704	SK-1689	BTK	
1.7 TD	02/98-08/00	X 17 DTL	1700	24x176	SK-1038	BTK	
1.7 TD	02/98-08/00	X 17 DTL	1700	24x176	SK-1038AQ1	BTKW	
1.8 16V	02/98-07/04	X 18 XE1, Z 18 XE	1796	20x162; :→02HL5117, 20041690; mit Zubehör	SK-1113	BTK	
1.8 16V	02/98-07/04	X 18 XE1, Z 18 XE	1796	20x162; :→02HL5117, 20041690; mit Zubehör	SK-1113AQ2	BTKW	
1.8 16V	02/98-07/04	X 18 XE1, Z 18 XE	1796	20x162; :02HL5118, 20041691→; mit Zubehör	SK-1355	BTK	
1.8 16V	02/98-07/04	X 18 XE1, Z 18 XE	1796	20x162; :02HL5118, 20041691→; mit Zubehör	SK-1355AQ1	BTKW	
2.0 16V	02/98-07/04	X 20 XEV	1998	24x168	SK-1478	BTK	
2.0 16V	02/98-07/04	X 20 XEV	1998	24x168	SK-1478AQ1	BTKW	
2.0 OPC	09/02-07/04	Z 20 LET	1998	24x168; ch.→32999999, 35999999; 03/2003 →	SK-1632	BTK	
2.0 OPC	09/02-07/04	Z 20 LET	1998	24x168; ch.→36999999, 38999999; 03/2003 →	SK-1632	BTK	
2.0 OPC	09/02-07/04	Z 20 LET	1998	24x168; ch.→3B999999, 3H999999; 03/2003 →	SK-1632	BTK	
2.0 OPC	09/02-07/04	Z 20 LET	1998	24x168; ch.→32999999, 35999999, 36999999, 38999999, 3B999999, 3G999999, 3H999999	SK-1632AQ1	BTKW	
2.0 OPC	09/02-07/04	Z 20 LET	1998	24x168; ch.42000001, 45000001, 48000001, 4B000001, 4G000001, 4H000001→	SK-1667	BTK	
2.0 OPC	09/02-07/04	Z 20 LET	1998	24x168; ch.42000001, 45000001, 48000001, 4B000001, 4G000001, 4H000001→	SK-1667AQ1	BTKW	
2.0 OPC	11/02-07/04	Z 20 LET	1998	24x168; ch.→32999999, 35999999	SK-1632	BTK	
2.0 OPC	11/02-07/04	Z 20 LET	1998	24x168; ch.→36999999, 38999999	SK-1632	BTK	
2.0 OPC	11/02-07/04	Z 20 LET	1998	24x168; ch.→3B999999, 3H999999	SK-1632	BTK	
1.4 16V	06/98-07/04	X 14 XE, Z 14 XE	1389		0-N102	TB [TE]	
1.4 16V	06/98-07/04	X 14 XE, Z 14 XE	1389	:02HL5118, 20041691→; ; mit Anbaumaterial	0-N300	TB [DG]	
1.4 16V	06/98-07/04	X 14 XE, Z 14 XE	1389	:→02HL5117, 20041690	0-N952	TB [DG]	
1.4 16V	06/98-07/04	X 14 XE, Z 14 XE	1389		0-N953	TB [DG]	
1.6	12/02-07/09	Z 16 XEP	1598		0-N1347	TB [TE]	
1.6	12/02-07/09	Z 16 XEP	1598		0-N1348	TB [DG]	
1.6 16V	02/98-07/04	X 16 XEL, Z 16 XE	1598	:02HL5118, 20041691→; ; mit Anbaumaterial	0-N300	TB [DG]	
1.6 16V	02/98-07/04	X 16 XEL, Z 16 XE	1598	:→02HL5117, 20041690	0-N952	TB [DG]	
1.6 16V, 1.6 CNG	02/98-07/04	X 16 XEL, Z 16 XE, Z 16 YNG	1598		0-N102	TB [TE]	
1.6 16V, 1.6 CNG	02/98-07/04	X 16 XEL, Z 16 XE, Z 16 YNG	1598		0-N953	TB [DG]	
1.6 CNG	03/03-07/04	Z 16 YNG	1598	; mit Anbaumaterial	0-N300	TB [DG]	
1.7 CDTI	04/03-07/09	Z 17 DTL	1686		0-N1085	TB [TE]	
1.7 CDTI, 1.7 DTI 16V	02/00-07/09	Y 17 DT, Z 17 DTL	1686		0-N878	TB [DG]	
1.7 DTI 16V	02/00-07/04	Y 17 DT	1686	:0328705→	0-N1085	TB [TE]	
1.7 TD	02/98-08/00	X 17 DTL	1700		0-N100	TB [TE]	
1.7 TD	02/98-08/00	X 17 DTL	1700		0-N909	TB [DG]	
1.8 16V	02/98-07/04	X 18 XE1, Z 18 XE	1796		0-N102	TB [TE]	
1.8 16V	02/98-07/04	X 18 XE1, Z 18 XE	1796	:02HL5118, 20041691→; ; mit Anbaumaterial	0-N300	TB [DG]	
1.8 16V	02/98-07/04	X 18 XE1, Z 18 XE	1796	:→02HL5117, 20041690	0-N952	TB [DG]	
1.8 16V	02/98-07/04	X 18 XE1, Z 18 XE	1796		0-N953	TB [DG]	
2.0 16V	02/98-07/04	X 20 XEV	1998		0-N100	TB [TE]	
2.0 16V	02/98-07/04	X 20 XEV	1998		0-N127	TB [DG]	
2.0 OPC	09/02-07/04	Z 20 LET	1998	→ 12/2003	0-N127	TB [DG]	
2.0 OPC	09/02-07/04	Z 20 LET	1998	01/2004 →	0-N127	TB [DG]	
2.0 OPC	09/02-07/04	Z 20 LET	1998		0-N1369	TB [TE]	
2.0 OPC	09/02-07/04	Z 20 LET	1998	01/2004 →	0-N1574	TB [DG]	
1.2 16V	02/98-07/04	X 12 XE, Z 12 XE	1199		0-N2170	VB [BT]	S
1.4	10/04-12/09	Z 14 XEP	1364		0-N2170	VB [BT]	S
1.4 16V	06/98-07/04	X 14 XE, Z 14 XE	1389		0-N1466	VB [BT]	S



CM³



Art. Nr.



ohne Halter

ASTRA G Caravan (F35_)							
1.6	02/98-07/04	X 16 SZR, Z 16 SE	1598			0-N948	TB [TE]
1.6	12/02-07/09	Z 16 XEP	1598			0-N1799	VB [BT] S
1.6, 1.6 16V, 1.6 CNG	02/98-07/04	X 16 SZR, X 16 XEL, Z 16 XE, Z 16 SE, Z 16 YNG	1598			0-N1466	VB [BT] S
1.7 CDTI, 1.7 DTI 16V	02/00-07/09	Y 17 DT, Z 17 DTL	1686	*		0-N1426	VB [DG]
1.7 CDTI, 1.7 DTI 16V	02/00-07/09	Y 17 DT, Z 17 DTL	1686			0-N1495S	VB [TE]
1.8 16V	02/98-07/04	X 18 XE1, Z 18 XE	1796			0-N1466	VB [BT] S
2.0 16V, 2.0 OPC	02/98-07/04	X 20 XEV, Z 20 LET	1998			0-N1422	VB [BT] S
2.0 DI, 2.0 DTI 16V	02/98-07/04	X 20 DTH, Y 20 DTH, X 20 DTL, Y 20 DTL	1995		Rippenanzahl: 6	0-N1437	VB [DG]
2.0 DI, 2.0 DTI 16V	02/98-07/04	X 20 DTH, Y 20 DTH, X 20 DTL, Y 20 DTL	1995			0-N1485	VB [BT] S
2.0 DI, 2.0 DTI 16V	02/98-07/04	X 20 DTH, Y 20 DTH, X 20 DTL, Y 20 DTL	1995			0-N2169	VB [VD]
2.2 16V	03/01-07/04	Z 22 SE	2198			0-N1588	VB [BT] S
2.2 DTI	09/02-07/04	Y 22 DTR	2172		Rippenanzahl: 6	0-N1437	VB [DG]
2.2 DTI	09/02-07/04	Y 22 DTR	2172			0-N1485	VB [BT] S
2.2 DTI	09/02-07/04	Y 22 DTR	2172			0-N2169	VB [VD]
ASTRA G CC (F48_, F08_)							
1.4 16V	02/98-01/05	X 14 XE, Z 14 XE	1389	20x162; :→02HL5117, 20041690; mit Zubehör		SK-1113	BTK
1.4 16V	02/98-01/05	X 14 XE, Z 14 XE	1389	20x162; :→02HL5117, 20041690; mit Zubehör		SK-1113AQ1	BTKW
1.4 16V	02/98-01/05	X 14 XE, Z 14 XE	1389	20x162; :02HL5118, 20041691→; mit Zubehör		SK-1355	BTK
1.4 16V	02/98-01/05	X 14 XE, Z 14 XE	1389	20x162; :02MV7225, 20U75999→; mit Zubehör		SK-1355AQ2	BTKW
1.4 16V	02/98-01/05	X 14 XE, Z 14 XE	1389	20x162; :02HL5118, 20041691→; :→02MV7224		SK-1355AQ3	BTKW
1.6	02/98-01/05	X 16 SZR, Z 16 SE	1598	17x111; mit Zubehör		SK-1162	BTK
1.6	02/98-01/05	X 16 SZR, Z 16 SE	1598	17x111; :→02MZ5253, 20U75998; mit Zubehör		SK-1162AQ1	BTKW
1.6	02/98-09/00	X 16 SZR	1598	17x111; :02MZ5254→		SK-1162AQ2	BTKW
1.6	09/00-01/05	Z 16 SE	1598	17x111; :02MZ5254, 20U75999→		SK-1162AQ2	BTKW
1.6	06/02-03/04	Z 16 YNG	1598	20x162; mit Zubehör		SK-1355	BTK
1.6	06/02-03/04	Z 16 YNG	1598	20x162; mit Zubehör		SK-1355AQ2	BTKW
1.6	12/02-12/09	Z 16 XEP	1598	24x146		SK-1607	BTK
1.6 16V	02/98-01/05	C 16 SEL, X 16 XEL, Z 16 XE	1598	20x162; :02MV7225, 20U75999→; mit Zubehör		SK-1355AQ2	BTKW
1.6 16V	02/98-01/05	C 16 SEL, X 16 XEL, Z 16 XE	1598	20x162; :02HL5118, 20041691→; :→02MV7224		SK-1355AQ3	BTKW
1.6 16V, 1.6 LPG	02/98-01/05	C 16 SEL, X 16 XEL, Z 16 XE, Z 16 XE	1598	20x162; :→02HL5117, 20041690; mit Zubehör		SK-1113	BTK
1.6 16V, 1.6 LPG	02/98-01/05	C 16 SEL, X 16 XEL, Z 16 XE, Z 16 XE	1598	20x162; :→02HL5117, 20041690; mit Zubehör		SK-1113AQ1	BTKW
1.6 16V, 1.6 LPG	02/98-01/05	C 16 SEL, X 16 XEL, Z 16 XE, Z 16 XE	1598	20x162; :02HL5118, 20041691→; mit Zubehör		SK-1355	BTK
1.6 LPG	06/02-01/05	Z 16 XE	1598	20x162; → 03/2004; :02MV7225, 20U75999→; mit Zubehör		SK-1355AQ2	BTKW
1.6 LPG	06/02-01/05	Z 16 XE	1598	20x162; → 03/2004; :02HL5118, 20041691→; :→02MV7224, 20U75998		SK-1355AQ3	BTKW
1.7 CDTI	04/03-12/09	Z 17 DTL	1686	25x129; mit Zubehör		SK-1612	BTK
1.7 DTI 16V	02/00-01/05	Y 17 DT	1686	25x131; mit Zubehör		SK-1479	BTK
1.7 DTI 16V	02/00-01/05	Y 17 DT	1686	25x131; :0328705→; mit Zubehör		SK-1481	BTK
1.7 DTI 16V	02/00-01/05	Y 17 DT	1686	25x131; :→0328704		SK-1689	BTK
1.7 TD	02/98-08/00	X 17 DTL	1700	24x176		SK-1038	BTK
1.7 TD	02/98-08/00	X 17 DTL	1700	24x176		SK-1038AQ1	BTKW
1.8	02/03-01/04	Z 18 XEL	1796	20x162; mit Zubehör		SK-1355	BTK
1.8	02/03-01/04	Z 18 XEL	1796	20x162; mit Zubehör		SK-1355AQ1	BTKW
1.8 16V	02/98-01/05	X 18 XE1, Z 18 XE	1796	20x162; :→02HL5117, 20041690; mit Zubehör		SK-1113AQ2	BTKW
1.8 16V	02/98-01/05	X 18 XE1, Z 18 XE	1796	20x162; :02HL5118, 20041691→; mit Zubehör		SK-1355	BTK
1.8 16V	02/98-01/05	X 18 XE1, Z 18 XE	1796	20x162; :02HL5118, 20041691→; mit Zubehör		SK-1355AQ1	BTKW
1.8, 1.8 16V	02/98-01/05	X 18 XE1, Z 18 XE, Z 18 XEL	1796	20x162; :→02HL5117, 20041690; mit Zubehör		SK-1113	BTK
2.0 16V	02/98-01/05	C 20 SEL, X 20 XEV	1998	24x168		SK-1478	BTK
2.0 16V	02/98-01/05	C 20 SEL, X 20 XEV	1998	24x168		SK-1478AQ1	BTKW
2.0 16V OPC	11/99-09/02	X 20 XER	1998	24x168		SK-1632	BTK
2.0 16V OPC	11/99-09/02	X 20 XER	1998	24x168		SK-1632AQ1	BTKW
2.0 OPC	09/02-01/05	Z 20 LET	1998	24x168; ch.→32999999, 35999999		SK-1632	BTK
2.0 OPC	09/02-01/05	Z 20 LET	1998	24x168; ch.→36999999, 38999999		SK-1632	BTK

CM³

Art. Nr.



ASTRA G CC (F48_, F08_)

2.0 OPC	09/02-01/05	Z 20 LET	1998	24x168; ch.→3B999999, 3H999999	SK-1632	BTK	
2.0 OPC	09/02-01/05	Z 20 LET	1998	24x168; ch.→32999999, 35999999, 36999999, 38999999, 3B999999, 3G999999, 3H999999	SK-1632AQ1	BTKW	
2.0 OPC	09/02-01/05	Z 20 LET	1998	24x168; ch.42000001, 45000001, 48000001, 4B000001, 4G000001, 4H000001→	SK-1667	BTK	
2.0 OPC	09/02-01/05	Z 20 LET	1998	24x168; ch.42000001, 45000001, 48000001, 4B000001, 4G000001, 4H000001→	SK-1667AQ1	BTKW	
1.4 16V	02/98-01/05	X 14 XE, Z 14 XE	1389		0-N102	TB [TE]	
1.4 16V	02/98-01/05	X 14 XE, Z 14 XE	1389	:02HL5118, 20041691→; †; mit Anbaumaterial	0-N300	TB [DG]	
1.4 16V	02/98-01/05	X 14 XE, Z 14 XE	1389	:→02HL5117, 20041690	0-N952	TB [DG]	
1.4 16V	02/98-01/05	X 14 XE, Z 14 XE	1389		0-N953	TB [DG]	
1.6	12/02-12/09	Z 16 XEP	1598		0-N1347	TB [TE]	
1.6	12/02-12/09	Z 16 XEP	1598		0-N1348	TB [DG]	
1.6 16V, 1.6 LPG	02/98-01/05	C 16 SEL, X 16 XEL, Z 16 XE, Z 16 XE	1598		0-N102	TB [TE]	
1.6 16V, 1.6 LPG	02/98-01/05	C 16 SEL, X 16 XEL, Z 16 XE, Z 16 XE	1598	:02HL5118, 20041691→; †; mit Anbaumaterial	0-N300	TB [DG]	
1.6 16V, 1.6 LPG	02/98-01/05	C 16 SEL, X 16 XEL, Z 16 XE, Z 16 XE	1598	:→02HL5117, 20041690	0-N952	TB [DG]	
1.6 16V, 1.6 LPG	02/98-01/05	C 16 SEL, X 16 XEL, Z 16 XE, Z 16 XE	1598		0-N953	TB [DG]	
1.7 CDTI	04/03-12/09	Z 17 DTL	1686		0-N1085	TB [TE]	
1.7 CDTI, 1.7 DTI 16V	02/00-12/09	Y 17 DT, Z 17 DTL	1686		0-N878	TB [DG]	
1.7 DTI 16V	02/00-01/05	Y 17 DT	1686	:0328705→	0-N1085	TB [TE]	
1.7 TD	02/98-08/00	X 17 DTL	1700		0-N100	TB [TE]	
1.7 TD	02/98-08/00	X 17 DTL	1700		0-N909	TB [DG]	
1.8, 1.8 16V	02/98-01/05	X 18 XE1, Z 18 XE, Z 18 XEL	1796		0-N102	TB [TE]	
1.8, 1.8 16V	02/98-01/05	X 18 XE1, Z 18 XE, Z 18 XEL	1796	:02HL5118, 20041691→; †; mit Anbaumaterial	0-N300	TB [DG]	
1.8, 1.8 16V	02/98-01/05	X 18 XE1, Z 18 XE, Z 18 XEL	1796	:→02HL5117, 20041690	0-N952	TB [DG]	
1.8, 1.8 16V	02/98-01/05	X 18 XE1, Z 18 XE, Z 18 XEL	1796		0-N953	TB [DG]	
2.0 16V	02/98-01/05	C 20 SEL, X 20 XEV	1998		0-N100	TB [TE]	
2.0 16V OPC, 2.0 OPC	11/99-01/05	X 20 XER, Z 20 LET	1998		0-N1369	TB [TE]	
2.0 16V, 2.0 16V OPC	02/98-01/05	C 20 SEL, X 20 XEV, X 20 XER	1998		0-N127	TB [DG]	
2.0 OPC	09/02-01/05	Z 20 LET	1998	→ 12/2003	0-N127	TB [DG]	
2.0 OPC	09/02-01/05	Z 20 LET	1998	01/2004 →	0-N127	TB [DG]	
2.0 OPC	09/02-01/05	Z 20 LET	1998	01/2004 →	0-N1574	TB [DG]	
1.0	08/03-05/04	Z 10 XEP	998		0-N2170	VB [BT]	S
1.2 16V	02/98-01/05	X 12 XE, Z 12 XE	1199		0-N2170	VB [BT]	S
1.4	09/07-12/09	Z 14 XEP	1364		0-N2170	VB [BT]	S
1.4 16V	02/98-01/05	X 14 XE, Z 14 XE	1389		0-N1466	VB [BT]	S
1.6	02/98-01/05	X 16 SZR, Z 16 SE	1598		0-N948	TB [TE]	
1.6	12/02-12/09	Z 16 XEP	1598		0-N1799	VB [BT]	S
1.6, 1.6 16V, 1.6 LPG	02/98-01/05	C 16 SEL, X 16 XEL, Z 16 XE, X 16 SZR, Z 16 SE, Z 16 XE	1598		0-N1466	VB [BT]	S
1.7 CDTI, 1.7 DTI 16V	02/00-12/09	Y 17 DT, Z 17 DTL	1686	✳	0-N1426	VB [DG]	
1.7 CDTI, 1.7 DTI 16V	02/00-12/09	Y 17 DT, Z 17 DTL	1686		0-N1495S	VB [TE]	
1.8, 1.8 16V	02/98-01/05	X 18 XE1, Z 18 XE, Z 18 XEL	1796		0-N1466	VB [BT]	S
2.0 16V, 2.0 16V OPC, 2.0 OPC	02/98-01/05	C 20 SEL, X 20 XEV, X 20 XER, Z 20 LET	1998		0-N1422	VB [BT]	S
2.0 DI, 2.0 DTI 16V	02/98-01/05	X 20 DTH, Y 20 DTH, X 20 DTL, Y 20 DTL	1995	Rippenanzahl: 6	0-N1437	VB [DG]	
2.0 DI, 2.0 DTI 16V	02/98-01/05	X 20 DTH, Y 20 DTH, X 20 DTL, Y 20 DTL	1995		0-N1485	VB [BT]	S
2.0 DI, 2.0 DTI 16V	02/98-01/05	X 20 DTH, Y 20 DTH, X 20 DTL, Y 20 DTL	1995		0-N2169	VB [VD]	
2.2 16V	06/00-01/05	Z 22 SE	2198		0-N1588	VB [BT]	S
2.2 DTI	09/02-01/05	Y 22 DTR	2172	Rippenanzahl: 6	0-N1437	VB [DG]	
2.2 DTI	09/02-01/05	Y 22 DTR	2172		0-N1485	VB [BT]	S
2.2 DTI	09/02-01/05	Y 22 DTR	2172		0-N2169	VB [VD]	

ASTRA G Coupe (F07_)

1.6 16V	03/00-05/05	Z 16 XE	1598	20x162; :→02HL5117, 20041690; mit Zubehör	SK-1113	BTK	
1.6 16V	03/00-05/05	Z 16 XE	1598	20x162; :→02HL5117, 20041690; mit Zubehör	SK-1113AQ1	BTKW	
1.6 16V	03/00-05/05	Z 16 XE	1598	20x162; :02HL5118, 20041691→; mit Zubehör	SK-1355	BTK	
1.6 16V	03/00-05/05	Z 16 XE	1598	20x162; :02MV7225, 20U75999→; mit Zubehör	SK-1355AQ2	BTKW	
1.6 16V	03/00-05/05	Z 16 XE	1598	20x162; :02HL5118, 20041691→; :→02MV7224, 20U75998	SK-1355AQ3	BTKW	
1.6 16V	03/00-05/05	Z 16 XEP	1598	24x146; 10/2003 →	SK-1607	BTK	



CM³



Art. Nr.



ohne Halter

ASTRA G Coupe (F07_)							
1.8 16V	03/00-05/05	X 18 XE1, Z 18 XE	1796	20x162; :→02HL5117, 20041690; mit Zubehör	SK-1113	BTK	
1.8 16V	03/00-05/05	X 18 XE1, Z 18 XE	1796	20x162; :→02HL5117, 20041690; mit Zubehör	SK-1113AQ2	BTKW	
1.8 16V	03/00-05/05	X 18 XE1, Z 18 XE	1796	20x162; :02HL5118, 20041691→; mit Zubehör	SK-1355	BTK	
1.8 16V	03/00-05/05	X 18 XE1, Z 18 XE	1796	20x162; :02HL5118, 20041691→; mit Zubehör	SK-1355AQ1	BTKW	
2.0 16V Turbo	09/00-05/05	Z 20 LET	1998	24x168; ch.→32999999, 35999999	SK-1632	BTK	
2.0 16V Turbo	09/00-05/05	Z 20 LET	1998	24x168; ch.→36999999, 38999999	SK-1632	BTK	
2.0 16V Turbo	09/00-05/05	Z 20 LET	1998	24x168; ch.→3B999999, 3H999999	SK-1632	BTK	
2.0 16V Turbo	09/00-05/05	Z 20 LET	1998	24x168; ch.→32999999, 35999999, 36999999, 38999999, 3B999999, 3G999999, 3H999999	SK-1632AQ1	BTKW	
2.0 16V Turbo	09/00-05/05	Z 20 LET	1998	24x168; ch.42000001, 45000001, 48000001, 4B000001, 4G000001, 4H000001→	SK-1667	BTK	
2.0 16V Turbo	09/00-05/05	Z 20 LET	1998	24x168; ch.42000001, 45000001, 48000001, 4B000001, 4G000001, 4H000001→	SK-1667AQ1	BTKW	
1.6 16V	03/00-05/05	Z 16 XE	1598		0-N102	TB [TE]	
1.6 16V	03/00-05/05	Z 16 XEP	1598		0-N1347	TB [TE]	
1.6 16V	03/00-05/05	Z 16 XE, Z 16 XEP	1598		0-N1348	TB [DG]	
1.6 16V	03/00-05/05	Z 16 XE	1598	:02HL5118, 20041691→; ; mit Anbaumaterial	0-N300	TB [DG]	
1.6 16V	03/00-05/05	Z 16 XE	1598	:→02HL5117, 20041690	0-N952	TB [DG]	
1.6 16V	03/00-05/05	Z 16 XE	1598		0-N953	TB [DG]	
1.8 16V	03/00-05/05	X 18 XE1, Z 18 XE	1796		0-N102	TB [TE]	
1.8 16V	03/00-05/05	X 18 XE1, Z 18 XE	1796	:02HL5118, 20041691→; ; mit Anbaumaterial	0-N300	TB [DG]	
1.8 16V	03/00-05/05	X 18 XE1, Z 18 XE	1796	:→02HL5117, 20041690	0-N952	TB [DG]	
1.8 16V	03/00-05/05	X 18 XE1, Z 18 XE	1796		0-N953	TB [DG]	
2.0 16V Turbo	09/00-08/01	Z 20 LET	1998		0-N127	TB [DG]	
2.0 16V Turbo	09/00-05/05	Z 20 LET	1998		0-N1369	TB [TE]	
2.0 16V Turbo	08/01-05/05	Z 20 LET	1998	→ 12/2003	0-N127	TB [DG]	
2.0 16V Turbo	08/01-05/05	Z 20 LET	1998	01/2004 →	0-N127	TB [DG]	
2.0 16V Turbo	08/01-05/05	Z 20 LET	1998	01/2004 →	0-N1574	TB [DG]	
1.6 16V	03/00-05/05	Z 16 XE	1598		0-N1466	VB [BT]	S
1.6 16V	03/00-05/05	Z 16 XEP	1598		0-N1799	VB [BT]	S
1.8 16V	03/00-05/05	X 18 XE1, Z 18 XE	1796		0-N1466	VB [BT]	S
2.0 16V Turbo	09/00-05/05	Z 20 LET	1998		0-N1422	VB [BT]	S
2.2 16V	09/00-05/05	Z 22 SE	2198		0-N1588	VB [BT]	S
2.2 DTI	09/02-05/05	Y 22 DTR	2172	Rippenanzahl: 6	0-N1437	VB [DG]	
2.2 DTI	09/02-05/05	Y 22 DTR	2172		0-N1485	VB [BT]	S
2.2 DTI	09/02-05/05	Y 22 DTR	2172		0-N2169	VB [VD]	
ASTRA G Kasten (F70)							
1.6	01/99-04/05	X 16 SZR, Z 16 SE	1598	17x111; mit Zubehör	SK-1162	BTK	
1.6	01/99-09/00	X 16 SZR	1598	17x111; :→02MZ5253, 20U75998; mit Zubehör	SK-1162AQ1	BTKW	
1.6	01/99-09/00	X 16 SZR	1598	17x111; :02MZ5254 →	SK-1162AQ2	BTKW	
1.6	09/00-04/05	Z 16 SE	1598	17x111; 12/2000 →; :→02MZ5253, 20U75998; mit Zubehör	SK-1162AQ1	BTKW	
1.6	09/00-04/05	Z 16 SE	1598	17x111; :02MZ5254, 20U75999 →	SK-1162AQ2	BTKW	
1.7 TD	01/99-04/05	X 17 DTL	1700	24x176	SK-1038	BTK	
1.7 TD	01/99-04/05	X 17 DTL	1700	24x176	SK-1038AQ1	BTKW	
1.7 DTI 16V	02/00-04/05	Y 17 DT	1686		0-N878	TB [DG]	
1.7 TD	01/99-04/05	X 17 DTL	1700		0-N100	TB [TE]	
1.7 TD	01/99-04/05	X 17 DTL	1700		0-N909	TB [DG]	
1.6	01/99-04/05	X 16 SZR, Z 16 SE	1598		0-N1466	VB [BT]	S
1.6	01/99-04/05	X 16 SZR, Z 16 SE	1598		0-N948	TB [TE]	
2.0 DI	01/99-04/05	X 20 DTL	1995	Rippenanzahl: 6	0-N1437	VB [DG]	
2.0 DI	01/99-04/05	X 20 DTL	1995		0-N1485	VB [BT]	S
2.0 DI	01/99-04/05	X 20 DTL	1995		0-N2169	VB [VD]	
ASTRA G Stufenheck (F69_)							
1.4 16V	09/98-01/05	X 14 XE, Z 14 XE	1389	20x162; :→02HL5117, 20041690; mit Zubehör	SK-1113	BTK	
1.4 16V	09/98-01/05	X 14 XE, Z 14 XE	1389	20x162; :→02HL5117, 20041690; mit Zubehör	SK-1113AQ1	BTKW	



CM³



Art. Nr.



ASTRA G Stufenheck (F69_)

1.4 16V	09/98-01/05	X 14 XE, Z 14 XE	1389	20x162; :02HL5118, 20041691→; mit Zubehör	SK-1355	BTK	
1.4 16V	09/98-01/05	X 14 XE, Z 14 XE	1389	20x162; :02MV7225, 20U75999→; mit Zubehör	SK-1355AQ2	BTKW	
1.4 16V	09/98-01/05	X 14 XE, Z 14 XE	1389	20x162; :02HL5118, 20041691→; :→02MV7224	SK-1355AQ3	BTKW	
1.6	09/98-01/05	X 16 SZR, Z 16 SE	1598	17x111; mit Zubehör	SK-1162	BTK	
1.6	09/98-01/05	X 16 SZR, Z 16 SE	1598	17x111; :→02MZ5253, 20U75998; mit Zubehör	SK-1162AQ1	BTKW	
1.6	09/98-09/00	X 16 SZR	1598	17x111; :02MZ5254→	SK-1162AQ2	BTKW	
1.6	09/00-01/05	Z 16 SE	1598	17x111; :02MZ5254, 20U75999→	SK-1162AQ2	BTKW	
1.6	12/02-12/09	Z 16 XEP	1598	24x146	SK-1607	BTK	
1.6 16V	09/98-01/05	X 16 XEL, Z 16 XE	1598	20x162; 09/2000 →; :→02HL5117, 20041690; mit Zubehör	SK-1113	BTK	
1.6 16V	09/98-01/05	X 16 XEL, Z 16 XE	1598	20x162; :02HL5118, 20041691→; :→02MV7224	SK-1355AQ3	BTKW	
1.6 16V, 1.6 LPG	09/98-01/05	X 16 XEL, Z 16 XE, Z 16 XE	1598	20x162; :→02HL5117, 20041690; mit Zubehör	SK-1113AQ1	BTKW	
1.6 16V, 1.6 LPG	09/98-01/05	X 16 XEL, Z 16 XE, Z 16 XE	1598	20x162; :02HL5118, 20041691→; mit Zubehör	SK-1355	BTK	
1.6 16V, 1.6 LPG	09/98-01/05	X 16 XEL, Z 16 XE, Z 16 XE	1598	20x162; :02MV7225, 20U75999→; mit Zubehör	SK-1355AQ2	BTKW	
1.6 LPG	06/02-01/05	Z 16 XE	1598	20x162; :→02HL5117, 20041690; mit Zubehör	SK-1113	BTK	
1.6 LPG	06/02-01/05	Z 16 XE	1598	20x162; :02HL5118, 20041691→; :→02MV7224, 20U75998	SK-1355AQ3	BTKW	
1.7 CDTI	04/03-12/09	Z 17 DTL	1686	25x129; mit Zubehör	SK-1612	BTK	
1.7 DTI 16V	02/00-01/05	Y 17 DT	1686	25x131; 09/2000 →; mit Zubehör	SK-1479	BTK	
1.7 DTI 16V	02/00-01/05	Y 17 DT	1686	25x131; 09/2000 →; :328705→; mit Zubehör	SK-1481	BTK	
1.7 DTI 16V	02/00-01/05	Y 17 DT	1686	25x131; 09/2000 →; :→328704	SK-1689	BTK	
1.7 TD	09/98-08/00	X 17 DTL	1700	24x176	SK-1038	BTK	
1.7 TD	09/98-08/00	X 17 DTL	1700	24x176	SK-1038AQ1	BTKW	
1.8 16V	09/98-01/05	X 18 XE1, Z 18 XE	1796	20x162; :→02HL5117, 20041690; mit Zubehör	SK-1113	BTK	
1.8 16V	09/98-01/05	X 18 XE1, Z 18 XE	1796	20x162; :→02HL5117, 20041690; mit Zubehör	SK-1113AQ2	BTKW	
1.8 16V	09/98-01/05	X 18 XE1, Z 18 XE	1796	20x162; :02HL5118, 20041691→; mit Zubehör	SK-1355	BTK	
1.8 16V	09/98-01/05	X 18 XE1, Z 18 XE	1796	20x162; :02HL5118, 20041691→; mit Zubehör	SK-1355AQ1	BTKW	
2.0 16V	09/98-01/05	X 20 XEV	1998	24x168	SK-1478	BTK	
2.0 16V	09/98-01/05	X 20 XEV	1998	24x168	SK-1478AQ1	BTKW	
1.4 16V	09/98-01/05	X 14 XE, Z 14 XE	1389		0-N102	TB [TE]	
1.4 16V	09/98-01/05	X 14 XE, Z 14 XE	1389	:02HL5118, 20041691→; ; mit Anbaumaterial	0-N300	TB [DG]	
1.4 16V	09/98-01/05	X 14 XE, Z 14 XE	1389	:→02HL5117, 20041690	0-N952	TB [DG]	
1.4 16V	09/98-01/05	X 14 XE, Z 14 XE	1389		0-N953	TB [DG]	
1.6	12/02-12/09	Z 16 XEP	1598		0-N1347	TB [TE]	
1.6	12/02-12/09	Z 16 XEP	1598		0-N1348	TB [DG]	
1.6 16V, 1.6 LPG	09/98-01/05	X 16 XEL, Z 16 XE, Z 16 XE	1598		0-N102	TB [TE]	
1.6 16V, 1.6 LPG	09/98-01/05	X 16 XEL, Z 16 XE, Z 16 XE	1598	:02HL5118, 20041691→; ; mit Anbaumaterial	0-N300	TB [DG]	
1.6 16V, 1.6 LPG	09/98-01/05	X 16 XEL, Z 16 XE, Z 16 XE	1598	:→02HL5117, 20041690	0-N952	TB [DG]	
1.6 16V, 1.6 LPG	09/98-01/05	X 16 XEL, Z 16 XE, Z 16 XE	1598		0-N953	TB [DG]	
1.7 CDTI	04/03-12/09	Z 17 DTL	1686		0-N1085	TB [TE]	
1.7 CDTI, 1.7 DTI 16V	02/00-12/09	Y 17 DT, Z 17 DTL	1686		0-N878	TB [DG]	
1.7 DTI 16V	02/00-01/05	Y 17 DT	1686	:0328705→	0-N1085	TB [TE]	
1.7 TD	09/98-08/00	X 17 DTL	1700		0-N100	TB [TE]	
1.7 TD	09/98-08/00	X 17 DTL	1700		0-N909	TB [DG]	
1.8 16V	09/98-01/05	X 18 XE1, Z 18 XE	1796		0-N102	TB [TE]	
1.8 16V	09/98-01/05	X 18 XE1, Z 18 XE	1796	:02HL5118, 20041691→; ; mit Anbaumaterial	0-N300	TB [DG]	
1.8 16V	09/98-01/05	X 18 XE1, Z 18 XE	1796	:→02HL5117, 20041690	0-N952	TB [DG]	
1.8 16V	09/98-01/05	X 18 XE1, Z 18 XE	1796		0-N953	TB [DG]	
2.0 16V	09/98-01/05	X 20 XEV	1998		0-N100	TB [TE]	
2.0 16V	09/98-01/05	X 20 XEV	1998		0-N127	TB [DG]	
1.2 16V	09/98-01/05	X 12 XE, Z 12 XE	1199		0-N2170	VB [BT]	S
1.4	09/07-12/09	Z 14 XEP	1364		0-N2170	VB [BT]	S
1.4 16V	09/98-01/05	X 14 XE, Z 14 XE	1389		0-N1466	VB [BT]	S



CM³



Art. Nr.



ASTRA G Stufenheck (F69_)							
1.6	09/98-01/05	X 16 SZR, Z 16 SE	1598			0-N948	TB [TE]
1.6	12/02-12/09	Z 16 XEP	1598			0-N1799	VB [BT] S
1.6, 1.6 16V, 1.6 LPG	09/98-01/05	X 16 SZR, X 16 XEL, Z 16 SE, Z 16 XE	1598			0-N1466	VB [BT] S
1.7 CDTI, 1.7 DTI 16V	02/00-12/09	Y 17 DT, Z 17 DTL	1686	*		0-N1426	VB [DG]
1.7 CDTI, 1.7 DTI 16V	02/00-12/09	Y 17 DT, Z 17 DTL	1686			0-N1495S	VB [TE]
1.8 16V	09/98-01/05	X 18 XE1, Z 18 XE	1796			0-N1466	VB [BT] S
2.0 16V	09/98-01/05	X 20 XEV	1998			0-N1422	VB [BT] S
2.0 DI, 2.0 DTI 16V	09/98-01/05	X 20 DTH, Y 20 DTH, X 20 DTL, Y 20 DTL	1995	Rippenanzahl: 6		0-N1437	VB [DG]
2.0 DI, 2.0 DTI 16V	09/98-01/05	X 20 DTH, Y 20 DTH, X 20 DTL, Y 20 DTL	1995			0-N1485	VB [BT] S
2.0 DI, 2.0 DTI 16V	09/98-01/05	X 20 DTH, Y 20 DTH, X 20 DTL, Y 20 DTL	1995			0-N2169	VB [VD]
2.2 16V	03/01-01/05	Z 22 SE	2198			0-N1588	VB [BT] S
2.2 DTI	09/02-01/05	Y 22 DTR	2172	Rippenanzahl: 6		0-N1437	VB [DG]
2.2 DTI	09/02-01/05	Y 22 DTR	2172			0-N1485	VB [BT] S
2.2 DTI	09/02-01/05	Y 22 DTR	2172			0-N2169	VB [VD]
ASTRA H (L48)							
1.6, 1.6 Turbo	03/04-	A 16 XER, Z 16 XER, Z 16 LET, Z 16 XE1, Z 16 XEP	1598	24x146		SK-1607	BTK
1.7 CDTI	03/04-	Z 17 DTH, Z 17 DTL	1686	25x129; mit Zubehör		SK-1612	BTK
1.7 CDTI	02/07-	A 17 DTJ, Z 17 DTJ, A 17 DTR, Z 17 DTR	1686	25x131; mit Zubehör		SK-1481	BTK
1.8	03/04-	Z 18 XE	1796	20x162; mit Zubehör		SK-1355	BTK
1.8	03/04-	Z 18 XE	1796	20x162; mit Zubehör		SK-1355AQ1	BTKW
1.8	01/06-	A 18 XER, Z 18 XER	1796	24x146		SK-1607	BTK
1.9 CDTI	06/04-	Z 19 DT, Z 19 DTL	1910	24x190		SK-1696	BTK
1.9 CDTI	06/04-	Z 19 DT, Z 19 DTL	1910	24x190		SK-1696AQ1	BTKW
1.9 CDTI, 1.9 CDTI 16V	04/04-	Z 19 DTH, Z 19 DTJ	1910	24x199		SK-1586	BTK
1.9 CDTI, 1.9 CDTI 16V	04/04-	Z 19 DTH, Z 19 DTJ	1910	24x199		SK-1586AQ1	BTKW
2.0 Turbo	03/04-	Z 20 LEH, Z 20 LEL, Z 20 LER	1998	24x168		SK-1667	BTK
2.0 Turbo	03/04-	Z 20 LEH, Z 20 LEL, Z 20 LER	1998	24x168		SK-1667AQ1	BTKW
1.6, 1.6 Turbo	03/04-	A 16 XER, Z 16 XER, Z 16 LET, Z 16 XE1, Z 16 XEP	1598			0-N1347	TB [TE]
1.6, 1.6 Turbo	03/04-	A 16 XER, Z 16 XER, Z 16 LET, Z 16 XE1, Z 16 XEP	1598			0-N1348	TB [DG]
1.7 CDTI	03/04-	A 17 DTJ, Z 17 DTJ, A 17 DTR, Z 17 DTR, Z 17 DTH, Z 17 DTL	1686			0-N1085	TB [TE]
1.7 CDTI	03/04-	A 17 DTJ, Z 17 DTJ, A 17 DTR, Z 17 DTR, Z 17 DTH, Z 17 DTL	1686			0-N878	TB [DG]
1.8	03/04-	Z 18 XE	1796			0-N102	TB [TE]
1.8	03/04-	Z 18 XE	1796	†; mit Anbaumaterial		0-N300	TB [DG]
1.8	03/04-	Z 18 XE	1796			0-N953	TB [DG]
1.8	01/06-	A 18 XER, Z 18 XER	1796			0-N1347	TB [TE]
1.8	01/06-	A 18 XER, Z 18 XER	1796			0-N1348	TB [DG]
1.9 CDTI, 1.9 CDTI 16V	04/04-	Z 19 DT, Z 19 DTH, Z 19 DTJ, Z 19 DTL	1910			0-N115	TB [TE]
1.9 CDTI, 1.9 CDTI 16V	04/04-	Z 19 DT, Z 19 DTH, Z 19 DTJ, Z 19 DTL	1910			0-N2149	TB [DG]
2.0 Turbo	03/04-	Z 20 LEH, Z 20 LEL, Z 20 LER	1998			0-N127	TB [DG]
2.0 Turbo	03/04-	Z 20 LEH, Z 20 LEL, Z 20 LER	1998			0-N1369	TB [TE]
2.0 Turbo	03/04-	Z 20 LEH, Z 20 LEL, Z 20 LER	1998			0-N1574	TB [DG]
1.2	08/05-	Z 12 XEP	1229			0-N2170	VB [BT] S
1.2	10/06-	X 12 XE	1199			0-N2170	VB [BT] S
1.3 CDTI	08/05-	Z 13 DTH	1248			0-N1526	VB [BT] S
1.4, 1.4 LPG	03/04-10/04	Z 14 XEL, Z 14 XEP	1364			0-N2170	VB [BT] S
1.6, 1.6 Turbo	03/04-	A 16 XER, Z 16 XER, Z 16 LET, Z 16 XE1, Z 16 XEP	1598			0-N1799	VB [BT] S
1.7 CDTI	03/04-	A 17 DTJ, Z 17 DTJ, A 17 DTR, Z 17 DTR, Z 17 DTH, Z 17 DTL	1686	*		0-N1426	VB [DG]
1.7 CDTI	03/04-	Z 17 DTL	1686			0-N1495S	VB [TE]
1.7 CDTI	03/04-	A 17 DTJ, Z 17 DTJ, A 17 DTR, Z 17 DTR, Z 17 DTH	1686			0-N1798	VB [BT] S
1.8	03/04-	Z 18 XE	1796			0-N1466	VB [BT] S
1.8	01/06-	A 18 XER, Z 18 XER	1796			0-N1799	VB [BT] S
1.9 CDTI, 1.9 CDTI 16V	04/04-	Z 19 DT, Z 19 DTH, Z 19 DTJ, Z 19 DTL	1910	→71111927		0-N1503	VB [BT] S
1.9 CDTI, 1.9 CDTI 16V	04/04-	Z 19 DT, Z 19 DTH, Z 19 DTJ, Z 19 DTL	1910	→71111927; *		0-N1522	VB [DG]
1.9 CDTI, 1.9 CDTI 16V	04/04-	Z 19 DT, Z 19 DTH, Z 19 DTJ, Z 19 DTL	1910	Rippenanzahl: 6		0-N1667	VB [DG]
1.9 CDTI, 1.9 CDTI 16V	04/04-	Z 19 DT, Z 19 DTH, Z 19 DTJ, Z 19 DTL	1910	→71111928→		0-N2030	VB [BT] S
2.0 Turbo	03/04-	Z 20 LEH, Z 20 LEL, Z 20 LER	1998			0-N1422	VB [BT] S

CM³

Art. Nr.



ohne Halter

ASTRA H Caravan (L35)

1.6, 1.6 LPG, 1.6 Turbo	08/04-	A 16 XER, Z 16 XER, Z 16 LET, Z 16 XE1, Z 16 XEP, Z 16 XER	1598	24x146	SK-1607	BTK	
1.7 CDTi	08/04-	Z 17 DTH, Z 17 DTL	1686	25x129; mit Zubehör	SK-1612	BTK	
1.7 CDTi	02/07-	A 17 DTJ, Z 17 DTJ, A 17 DTR, Z 17 DTR	1686	25x131; mit Zubehör	SK-1481	BTK	
1.8	08/04-	Z 18 XE	1796	20x162; mit Zubehör	SK-1355	BTK	
1.8	08/04-	Z 18 XE	1796	20x162; mit Zubehör	SK-1355AQ1	BTKW	
1.8	08/05-	A 18 XER, Z 18 XER	1796	24x146	SK-1607	BTK	
1.9 CDTi	09/05-	Z 19 DT	1910	24x190; → 06/2010	SK-1696	BTK	
1.9 CDTi	09/05-	Z 19 DT, Z 19 DTL	1910	24x190	SK-1696AQ1	BTKW	
1.9 CDTi, 1.9 CDTi 16V	08/04-	Z 19 DTH, Z 19 DTJ	1910	24x199	SK-1586	BTK	
1.9 CDTi, 1.9 CDTi 16V	08/04-	Z 19 DTH, Z 19 DTJ	1910	24x199	SK-1586AQ1	BTKW	
1.9 CDTi, 1.9 CDTi 16V	08/04-	Z 19 DTJ, Z 19 DTL	1910	24x190	SK-1696	BTK	
2.0 Turbo	08/04-	Z 20 LEL, Z 20 LER	1998	24x168	SK-1667	BTK	
2.0 Turbo	08/04-	Z 20 LEL, Z 20 LER	1998	24x168	SK-1667AQ1	BTKW	
1.6, 1.6 LPG, 1.6 Turbo	08/04-	A 16 XER, Z 16 XER, Z 16 LET, Z 16 XE1, Z 16 XEP, Z 16 XER	1598		0-N1347	TB [TE]	
1.6, 1.6 LPG, 1.6 Turbo	08/04-	A 16 XER, Z 16 XER, Z 16 LET, Z 16 XE1, Z 16 XEP, Z 16 XER	1598		0-N1348	TB [DG]	
1.7 CDTi	08/04-	Z 17 DTH, Z 17 DTL	1686		0-N1085	TB [TE]	
1.7 CDTi	08/04-	A 17 DTJ, Z 17 DTJ, A 17 DTR, Z 17 DTR, Z 17 DTH, Z 17 DTL	1686		0-N878	TB [DG]	
1.7 CDTi	02/07-	A 17 DTJ, Z 17 DTJ	1686		0-N1085	TB [TE]	
1.7 CDTi	02/07-	A 17 DTR, Z 17 DTR	1686		0-N1085	TB [TE]	
1.8	08/04-	Z 18 XE	1796		0-N102	TB [TE]	
1.8	08/04-	Z 18 XE	1796	†; mit Anbaumaterial	0-N300	TB [DG]	
1.8	08/04-	Z 18 XE	1796		0-N953	TB [DG]	
1.8	08/05-	A 18 XER, Z 18 XER	1796		0-N1347	TB [TE]	
1.8	08/05-	A 18 XER, Z 18 XER	1796		0-N1348	TB [DG]	
1.9 CDTi, 1.9 CDTi 16V	08/04-	Z 19 DT, Z 19 DTH, Z 19 DTJ, Z 19 DTL	1910		0-N115	TB [TE]	
1.9 CDTi, 1.9 CDTi 16V	08/04-	Z 19 DT, Z 19 DTH, Z 19 DTJ, Z 19 DTL	1910		0-N2149	TB [DG]	
2.0 Turbo	08/04-	Z 20 LEL, Z 20 LER	1998		0-N127	TB [DG]	
2.0 Turbo	08/04-	Z 20 LEL, Z 20 LER	1998		0-N1369	TB [TE]	
2.0 Turbo	08/04-	Z 20 LEL, Z 20 LER	1998		0-N1574	TB [DG]	
1.3 CDTi	08/05-	Z 13 DTH	1248		0-N1526	VB [BT]	S
1.4, 1.4 LPG	08/04-	Z 14 XEP	1364		0-N2170	VB [BT]	S
1.6, 1.6 LPG, 1.6 Turbo	08/04-	A 16 XER, Z 16 XER, Z 16 LET, Z 16 XE1, Z 16 XEP, Z 16 XER	1598		0-N1799	VB [BT]	S
1.7 CDTi	08/04-	A 17 DTJ, Z 17 DTJ, A 17 DTR, Z 17 DTR, Z 17 DTH, Z 17 DTL	1686	✳	0-N1426	VB [DG]	
1.7 CDTi	08/04-	Z 17 DTL	1686		0-N1495S	VB [TE]	
1.7 CDTi	08/04-	A 17 DTJ, Z 17 DTJ, A 17 DTR, Z 17 DTR, Z 17 DTH	1686		0-N1798	VB [BT]	S
1.8	08/04-	Z 18 XE	1796		0-N1466	VB [BT]	S
1.8	08/05-	A 18 XER, Z 18 XER	1796		0-N1799	VB [BT]	S
1.9 CDTi	12/04-		1910		0-N1503	VB [BT]	S
1.9 CDTi, 1.9 CDTi 16V	08/04-	Z 19 DT, Z 19 DTH, Z 19 DTJ, Z 19 DTL	1910	☞:→71111927	0-N1503	VB [BT]	S
1.9 CDTi, 1.9 CDTi 16V	08/04-	Z 19 DT, Z 19 DTH, Z 19 DTJ, Z 19 DTL	1910	☞:→71111927; ✳	0-N1522	VB [DG]	
1.9 CDTi, 1.9 CDTi 16V	08/04-	Z 19 DT, Z 19 DTH, Z 19 DTJ, Z 19 DTL	1910	Rippenanzahl: 6	0-N1667	VB [DG]	
1.9 CDTi, 1.9 CDTi 16V	08/04-	Z 19 DT, Z 19 DTH, Z 19 DTJ, Z 19 DTL	1910	☞:71111928→	0-N2030	VB [BT]	S
2.0 Turbo	08/04-	Z 20 LEL, Z 20 LER	1998		0-N1422	VB [BT]	S

ASTRA H GTC (L08)

1.6, 1.6 Turbo	03/05-	Z 16 LET, Z 16 XE1, Z 16 XEP, Z 16 XER	1598	24x146	SK-1607	BTK	
1.7 CDTi	03/05-	Z 17 DTH, Z 17 DTL	1686	25x129; mit Zubehör	SK-1612	BTK	
1.7 CDTi	02/07-	A 17 DTJ, A 17 DTR	1686	25x131; mit Zubehör	SK-1481	BTK	
1.8	03/05-	Z 18 XE	1796	20x162; mit Zubehör	SK-1355	BTK	
1.8	03/05-	Z 18 XE	1796	20x162; mit Zubehör	SK-1355AQ1	BTKW	
1.8	01/06-	Z 18 XER	1796	24x146	SK-1607	BTK	
1.9 CDTi	09/05-	Z 19 DT, Z 19 DTL	1910	24x190; → 09/2011	SK-1696	BTK	
1.9 CDTi	09/05-	Z 19 DT, Z 19 DTL	1910	24x190	SK-1696AQ1	BTKW	
1.9 CDTi, 1.9 CDTi 16V	03/05-	Z 19 DTH, Z 19 DTJ	1910	24x199	SK-1586	BTK	
1.9 CDTi, 1.9 CDTi 16V	03/05-	Z 19 DTH, Z 19 DTJ	1910	24x199	SK-1586AQ1	BTKW	
2.0 Turbo	03/05-	Z 20 LEH, Z 20 LEL, Z 20 LER	1998	24x168	SK-1667	BTK	
2.0 Turbo	03/05-	Z 20 LEH, Z 20 LEL, Z 20 LER	1998	24x168	SK-1667AQ1	BTKW	
1.6, 1.6 Turbo	03/05-	Z 16 LET, Z 16 XE1, Z 16 XEP, Z 16 XER	1598		0-N1347	TB [TE]	
1.6, 1.6 Turbo	03/05-	Z 16 LET, Z 16 XE1, Z 16 XEP, Z 16 XER	1598		0-N1348	TB [DG]	
1.7 CDTi	03/05-	A 17 DTR, Z 17 DTH, Z 17 DTL	1686		0-N1085	TB [TE]	
1.7 CDTi	03/05-	A 17 DTJ, A 17 DTR, Z 17 DTH, Z 17 DTL	1686		0-N878	TB [DG]	

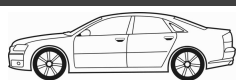

CM³



Art. Nr.



ASTRA H GTC (L08)							
1.7 CDTi	02/07-	A 17 DTJ	1686			0-N1085	TB [TE]
1.8	03/05-	Z 18 XE	1796			0-N102	TB [TE]
1.8	03/05-	Z 18 XE	1796	†; mit Anbaumaterial		0-N300	TB [DG]
1.8	03/05-	Z 18 XE	1796			0-N953	TB [DG]
1.8	01/06-	Z 18 XER	1796			0-N1347	TB [TE]
1.8	01/06-	Z 18 XER	1796			0-N1348	TB [DG]
1.9 CDTi, 1.9 CDTi 16V	03/05-	Z 19 DT, Z 19 DTH, Z 19 DTJ, Z 19 DTL	1910			0-N115	TB [TE]
1.9 CDTi, 1.9 CDTi 16V	03/05-	Z 19 DT, Z 19 DTH, Z 19 DTJ, Z 19 DTL	1910			0-N2149	TB [DG]
2.0 Turbo	03/05-	Z 20 LEH, Z 20 LEL, Z 20 LER	1998			0-N127	TB [DG]
2.0 Turbo	03/05-	Z 20 LEH, Z 20 LEL, Z 20 LER	1998			0-N1369	TB [TE]
2.0 Turbo	03/05-	Z 20 LEH, Z 20 LEL, Z 20 LER	1998			0-N1574	TB [DG]
1.2	08/05-	Z 12 XEP	1229			0-N2170	VB [BT] S
1.2	10/06-	X 12 XE	1199			0-N2170	VB [BT] S
1.3 CDTi	04/05-	Z 13 DTH	1248			0-N1526	VB [BT] S
1.4	03/05-	Z 14 XEL, Z 14 XEP	1364			0-N2170	VB [BT] S
1.6, 1.6 Turbo	03/05-	Z 16 LET, Z 16 XE1, Z 16 XEP, Z 16 XER	1598			0-N1799	VB [BT] S
1.7 CDTi	03/05-	A 17 DTJ, A 17 DTR, Z 17 DTH, Z 17 DTL	1686	✳		0-N1426	VB [DG]
1.7 CDTi	03/05-	Z 17 DTL	1686			0-N1495S	VB [TE]
1.7 CDTi	03/05-	A 17 DTJ, A 17 DTR, Z 17 DTH	1686			0-N1798	VB [BT] S
1.8	03/05-	Z 18 XE	1796			0-N1466	VB [BT] S
1.8	01/06-	Z 18 XER	1796			0-N1799	VB [BT] S
1.9 CDTi, 1.9 CDTi 16V	03/05-	Z 19 DT, Z 19 DTH, Z 19 DTJ, Z 19 DTL	1910	:→71111927		0-N1503	VB [BT] S
1.9 CDTi, 1.9 CDTi 16V	03/05-	Z 19 DT, Z 19 DTH, Z 19 DTJ, Z 19 DTL	1910	:→71111927; ✳		0-N1522	VB [DG]
1.9 CDTi, 1.9 CDTi 16V	03/05-	Z 19 DT, Z 19 DTH, Z 19 DTJ, Z 19 DTL	1910	Rippenanzahl: 6		0-N1667	VB [DG]
1.9 CDTi, 1.9 CDTi 16V	03/05-	Z 19 DT, Z 19 DTH, Z 19 DTJ, Z 19 DTL	1910	:71111928→		0-N2030	VB [BT] S
2.0 Turbo	03/05-	Z 20 LEH, Z 20 LEL, Z 20 LER	1998			0-N1422	VB [BT] S

ASTRA H Stufenheck (L69)							
1.6	02/07-	Z 16 XER	1598	24x146		SK-1607	BTK
1.7 CDTi	02/07-	Z 17 DTJ	1686	25x131; mit Zubehör		SK-1481	BTK
1.7 CDTi	02/07-	Z 17 DTH	1686	25x129; mit Zubehör		SK-1612	BTK
1.8	02/07-	A 18 XER, Z 18 XER	1796	24x146		SK-1607	BTK
1.6	02/07-	Z 16 XER	1598			0-N1347	TB [TE]
1.6	02/07-	Z 16 XER	1598			0-N1348	TB [DG]
1.7 CDTi	02/07-	Z 17 DTH, Z 17 DTJ	1686			0-N1085	TB [TE]
1.7 CDTi	02/07-	A 17 DTR, Z 17 DTR, Z 17 DTH, Z 17 DTJ	1686			0-N878	TB [DG]
1.8	02/07-	A 18 XER, Z 18 XER	1796			0-N1347	TB [TE]
1.8	02/07-	A 18 XER, Z 18 XER	1796			0-N1348	TB [DG]
1.3 CDTi	02/07-	Z 13 DTH	1248			0-N1526	VB [BT] S
1.6	02/07-	Z 16 XER	1598			0-N1799	VB [BT] S
1.7 CDTi	02/07-	Z 17 DTH, Z 17 DTJ	1686	✳		0-N1426	VB [DG]
1.7 CDTi	02/07-	A 17 DTR, Z 17 DTR, Z 17 DTH, Z 17 DTJ	1686			0-N1798	VB [BT] S
1.8	02/07-	A 18 XER, Z 18 XER	1796			0-N1799	VB [BT] S

ASTRA H TwinTop (L67)							
1.6, 1.6 Turbo	09/05-	Z 16 LET, Z 16 XE1, Z 16 XEP, Z 16 XER	1598	24x146		SK-1607	BTK
1.8	09/05-	Z 18 XE	1796	20x162; mit Zubehör		SK-1355	BTK
1.8	09/05-	Z 18 XE	1796	20x162; mit Zubehör		SK-1355AQ1	BTKW
1.8	09/05-	A 18 XER, Z 18 XER	1796	24x146; 04/2006 →		SK-1607	BTK
1.9 CDTi	09/05-	Z 19 DTH	1910	24x199		SK-1586	BTK
1.9 CDTi	09/05-	Z 19 DTH	1910	24x199		SK-1586AQ1	BTKW
2.0 Turbo	09/05-	Z 20 LEL, Z 20 LER	1998	24x168		SK-1667	BTK
2.0 Turbo	09/05-	Z 20 LEL, Z 20 LER	1998	24x168		SK-1667AQ1	BTKW
1.6, 1.6 Turbo	09/05-	Z 16 LET, Z 16 XE1, Z 16 XEP, Z 16 XER	1598			0-N1347	TB [TE]
1.6, 1.6 Turbo	09/05-	Z 16 LET, Z 16 XE1, Z 16 XEP, Z 16 XER	1598			0-N1348	TB [DG]
1.8	09/05-	Z 18 XE	1796			0-N102	TB [TE]
1.8	09/05-	A 18 XER, Z 18 XER	1796			0-N1347	TB [TE]
1.8	09/05-	A 18 XER, Z 18 XER	1796			0-N1348	TB [DG]
1.8	09/05-	Z 18 XE	1796	†; mit Anbaumaterial		0-N300	TB [DG]
1.8	09/05-	Z 18 XE	1796			0-N953	TB [DG]
1.9 CDTi	09/05-	Z 19 DTH	1910			0-N115	TB [TE]
1.9 CDTi	09/05-	Z 19 DTH	1910			0-N2149	TB [DG]
2.0 Turbo	09/05-	Z 20 LEL, Z 20 LER	1998			0-N127	TB [DG]
2.0 Turbo	09/05-	Z 20 LEL, Z 20 LER	1998			0-N1369	TB [TE]
2.0 Turbo	09/05-	Z 20 LEL, Z 20 LER	1998			0-N1574	TB [DG]
1.6, 1.6 Turbo	09/05-	Z 16 LET, Z 16 XE1, Z 16 XEP, Z 16 XER	1598			0-N1799	VB [BT] S



OPTIMAL®

OPEL



CM³



Art. Nr.



ASTRA H TwinTop (L67)

1.8	09/05-	Z 18 XE	1796		0-N1466	VB [BT]	S
1.8	09/05-	A 18 XER, Z 18 XER	1796		0-N1799	VB [BT]	S
1.9 CDTi	09/05-	Z 19 DTH	1910	:→71111927	0-N1503	VB [BT]	S
1.9 CDTi	09/05-	Z 19 DTH	1910	:→71111927;	0-N1522	VB [DG]	
1.9 CDTi	09/05-	Z 19 DTH	1910	Rippenanzahl: 6	0-N1667	VB [DG]	
1.9 CDTi	09/05-	Z 19 DTH	1910	:71111928→	0-N2030	VB [BT]	S
2.0 Turbo	09/05-	Z 20 LEL, Z 20 LER	1998		0-N1422	VB [BT]	S

ASTRA H Kasten (L70)

1.6	02/04-11/04	Z 16 XEP	1598	24x146	SK-1607	BTK	
1.7 CDTi	03/04-	Z 17 DTH	1686	25x129; 12/2004 →; mit Zubehör	SK-1612	BTK	
1.7 CDTi	02/07-	A 17 DTR, Z 17 DTR	1686	25x131; 01/2010 →; mit Zubehör	SK-1481	BTK	
1.7 CDTi	02/07-	A 17 DTJ, Z 17 DTJ	1686	25x131; mit Zubehör	SK-1481	BTK	
1.9 CDTi	09/04-	Z 19 DT, Z 19 DTH	1910	24x199	SK-1586	BTK	
1.9 CDTi	09/05-	Z 19 DT	1910	24x190	SK-1696	BTK	
1.9 CDTi	09/05-	Z 19 DT	1910	24x190	SK-1696AQ1	BTKW	
1.9 CDTi 16V	08/04-	Z 19 DTJ	1910	24x199; 12/2004 →	SK-1586	BTK	
1.9 CDTi, 1.9 CDTi 16V	08/04-	Z 19 DTH, Z 19 DTJ	1910	24x199	SK-1586AQ1	BTKW	
1.6	02/04-11/04	Z 16 XEP	1598		0-N1347	TB [TE]	
1.7 CDTi	03/04-	Z 17 DTH	1686		0-N1085	TB [TE]	
1.7 CDTi	03/04-	A 17 DTJ, Z 17 DTJ, A 17 DTR, Z 17 DTR, Z 17 DTH	1686		0-N878	TB [DG]	
1.7 CDTi	02/07-	A 17 DTJ, Z 17 DTJ	1686		0-N1085	TB [TE]	
1.7 CDTi	02/07-	A 17 DTR, Z 17 DTR	1686		0-N1085	TB [TE]	
1.9 CDTi, 1.9 CDTi 16V	08/04-	Z 19 DT, Z 19 DTH, Z 19 DTJ	1910		0-N115	TB [TE]	
1.9 CDTi, 1.9 CDTi 16V	08/04-	Z 19 DT, Z 19 DTH, Z 19 DTJ	1910		0-N2149	TB [DG]	
1.3 CDTi	08/05-	Z 13 DTH	1248		0-N1526	VB [BT]	S
1.6	02/04-11/04	Z 16 XEP	1598		0-N1799	VB [BT]	S
1.7 CDTi	03/04-	A 17 DTJ, Z 17 DTJ, A 17 DTR, Z 17 DTR, Z 17 DTH	1686		0-N1426	VB [DG]	
1.7 CDTi	03/04-	A 17 DTJ, Z 17 DTJ, A 17 DTR, Z 17 DTR, Z 17 DTH	1686		0-N1798	VB [BT]	S
1.9 CDTi, 1.9 CDTi 16V	08/04-	Z 19 DT, Z 19 DTH, Z 19 DTJ	1910	:→71111927;	0-N1522	VB [DG]	
1.9 CDTi, 1.9 CDTi 16V	08/04-	Z 19 DT, Z 19 DTH, Z 19 DTJ	1910	Rippenanzahl: 6	0-N1667	VB [DG]	

ASTRA J

1.6, 1.6 Turbo	12/09-	A 16 LET, A 16 XER, B 16 XER	1598	24x146	SK-1607	BTK	
1.7 CDTi	12/09-	A 17 DTF, A 17 DTS	1686	25x131; 07/2011 →; mit Zubehör	SK-1481	BTK	
1.7 CDTi	12/09-	A 17 DTC, A 17 DTE, A 17 DTJ, A 17 DTR	1686	25x131; mit Zubehör	SK-1481	BTK	
2.0 CDTi	12/09-	A 20 DTH	1956	24x199	SK-1586	BTK	
2.0 CDTi	12/09-	A 20 DTH	1956	24x199	SK-1586AQ1	BTKW	
1.6, 1.6 Turbo	12/09-	A 16 LET, A 16 XER, B 16 XER	1598		0-N1347	TB [TE]	
1.6, 1.6 Turbo	12/09-	A 16 LET, A 16 XER, B 16 XER	1598		0-N1348	TB [DG]	
1.7 CDTi	12/09-	A 17 DTC, A 17 DTE, A 17 DTJ, A 17 DTF, A 17 DTS, A 17 DTL, A 17 DTR	1686		0-N1085	TB [TE]	
1.7 CDTi	12/09-	A 17 DTC, A 17 DTE, A 17 DTJ, A 17 DTF, A 17 DTS, A 17 DTL, A 17 DTR	1686		0-N878	TB [DG]	
2.0 BiTurbo CDTi	12/12-	A 20 DTR	1956		0-N2236	TB [DG]	
2.0 BiTurbo CDTi, 2.0 CDTi	12/09-	A 20 DTH, A 20 DTR	1956		0-N2149	TB [DG]	
2.0 CDTi	12/09-	A 20 DTH	1956		0-N115	TB [TE]	
1.3 CDTi	12/09-	A 13 DTE	1248		0-N1526	VB [BT]	S
1.4	12/09-	A 14 XEL, A 14 XER	1398		0-N2170	VB [BT]	S
1.4 LPG, 1.4 Turbo	12/09-	A 14 NEL, B 14 NEL, A 14 NET	1364		0-N2170	VB [BT]	S
1.6 CDTi	01/14-	B 16 DTH, B 16 DTL	1598		0-N1649	VB [DG]	
1.6, 1.6 Turbo	12/09-	A 16 LET, A 16 XER, B 16 XER	1598		0-N1799	VB [BT]	S
1.7 CDTi	12/09-	A 17 DTC, A 17 DTE, A 17 DTJ, A 17 DTF, A 17 DTS, A 17 DTL, A 17 DTR	1686		0-N2341	VB [DG]	
1.7 CDTi	12/09-	A 17 DTC, A 17 DTE, A 17 DTJ, A 17 DTF, A 17 DTS, A 17 DTL, A 17 DTR	1686		0-N2389	VB [BT]	S
2.0 BiTurbo CDTi, 2.0 CDTi	12/09-	A 20 DTH, A 20 DTR	1956		0-N1649	VB [DG]	
2.0 BiTurbo CDTi, 2.0 CDTi	12/09-	A 20 DTH, A 20 DTR	1956		0-N2221	VB [DG]	
2.0 BiTurbo CDTi, 2.0 CDTi	12/09-	A 20 DTH, A 20 DTR	1956	für Fahrzeuge mit elektrischer Servolenkung	0-N2254	VB [DG]	
2.0 CDTi	12/09-	A 20 DTH	1956		0-N2087	VB [BT]	S
2.0 CDTi	06/11-	A 20 DTH	1956	07/2011 →	0-N2087	VB [BT]	S

ASTRA GTC J

1.6	10/11-	A 16 LET	1598	24x146	SK-1607	BTK	
1.7 CDTi	10/11-	A 17 DTC, A 17 DTE, A 17 DTJ, A 17 DTF, A 17 DTS	1686	25x131; mit Zubehör	SK-1481	BTK	



CM³



Art. Nr.



ASTRA GTC J							
1.8	10/11-	A 18 XER	1796	24x146		SK-1607	BTK
2.0 CDTI	10/11-	A 20 DTH	1956	24x199		SK-1586	BTK
2.0 CDTI	10/11-	A 20 DTH	1956	24x199		SK-1586AQ1	BTKW
1.6	10/11-	A 16 LET	1598			0-N1347	TB [TE]
1.6	10/11-	A 16 LET	1598			0-N1348	TB [DG]
1.7 CDTI	10/11-	A 17 DTC, A 17 DTE, A 17 DTJ, A 17 DTF, A 17 DTS	1686			0-N1085	TB [TE]
1.7 CDTI	10/11-	A 17 DTC, A 17 DTE, A 17 DTJ, A 17 DTF, A 17 DTS	1686			0-N878	TB [DG]
1.8	10/11-	A 18 XER	1796			0-N1347	TB [TE]
1.8	10/11-	A 18 XER	1796			0-N1348	TB [DG]
2.0 BiTurbo CDTI	10/12-	A 20 DTR	1956			0-N2236	TB [DG]
2.0 BiTurbo CDTI, 2.0 CDTI	10/11-	A 20 DTH, A 20 DTR	1956			0-N2149	TB [DG]
1.4	10/11-	A 14 NEL, B 14 NEL, A 14 NET, B 14 NET	1364			0-N2170	VB [BT] S
1.4	10/11-	A 14 XER	1398			0-N2170	VB [BT] S
1.6	10/11-	A 16 LET	1598			0-N1799	VB [BT] S
1.6 CDTI	07/14-	B 16 DTH, B 16 DTL	1598	☼		0-N1649	VB [DG]
1.7 CDTI	10/11-	A 17 DTC, A 17 DTE, A 17 DTJ, A 17 DTF, A 17 DTS	1686	☼		0-N2341	VB [DG]
1.7 CDTI	10/11-	A 17 DTC, A 17 DTE, A 17 DTJ, A 17 DTF, A 17 DTS	1686			0-N2389	VB [BT] S
1.8	10/11-	A 18 XER	1796			0-N1799	VB [BT] S
2.0	04/12-	A 20 NFT, B 20 NFT	1998			0-N2283	VB [DG]
2.0	04/12-	A 20 NFT, B 20 NFT	1998			0-N2299	VB [BT] S
2.0 BiTurbo CDTI, 2.0 CDTI	10/11-	A 20 DTH, A 20 DTR	1956	☼		0-N1649	VB [DG]
2.0 BiTurbo CDTI, 2.0 CDTI	10/11-	A 20 DTH, A 20 DTR	1956			0-N2221	VB [DG]
2.0 BiTurbo CDTI, 2.0 CDTI	10/11-	A 20 DTH, A 20 DTR	1956		für Fahrzeuge mit elektrischer Servolenkung	0-N2254	VB [DG]
2.0 CDTI	10/11-	A 20 DTH	1956			0-N2087	VB [BT] S
ASTRA J Stufenheck							
1.6, 1.6 Turbo	06/12-	A 16 LET, A 16 XER, B 16 XER	1598	24x146		SK-1607	BTK
1.7 CDTI	06/12-	A 17 DTC, A 17 DTE, A 17 DTJ, A 17 DTF, A 17 DTS	1686	25x131; mit Zubehör		SK-1481	BTK
1.6, 1.6 Turbo	06/12-	A 16 LET, A 16 XER, B 16 XER	1598			0-N1347	TB [TE]
1.6, 1.6 Turbo	06/12-	A 16 LET, A 16 XER, B 16 XER	1598			0-N1348	TB [DG]
1.7 CDTI	06/12-	A 17 DTC, A 17 DTE, A 17 DTJ, A 17 DTF, A 17 DTS	1686			0-N1085	TB [TE]
1.7 CDTI	06/12-	A 17 DTC, A 17 DTE, A 17 DTJ, A 17 DTF, A 17 DTS	1686			0-N878	TB [DG]
1.4 Turbo	06/12-	A 14 NEL, B 14 NEL, A 14 NET, B 14 NET	1364			0-N2170	VB [BT] S
1.6 CDTi	01/14-	B 16 DTH, B 16 DTL	1598	☼		0-N1649	VB [DG]
1.6, 1.6 Turbo	06/12-	A 16 LET, A 16 XER, B 16 XER	1598			0-N1799	VB [BT] S
1.7 CDTI	06/12-	A 17 DTC, A 17 DTE, A 17 DTJ, A 17 DTF, A 17 DTS	1686	☼		0-N2341	VB [DG]
1.7 CDTI	06/12-	A 17 DTC, A 17 DTE, A 17 DTJ, A 17 DTF, A 17 DTS	1686			0-N2389	VB [BT] S
ASTRA J Sports Tourer							
1.6, 1.6 Turbo	10/10-	A 16 LET, A 16 XER, B 16 XER	1598	24x146		SK-1607	BTK
1.7 CDTI	10/10-	A 17 DTC, A 17 DTE, A 17 DTJ, A 17 DTF, A 17 DTS, A 17 DTL, A 17 DTN, A 17 DTR	1686	25x131; mit Zubehör		SK-1481	BTK
2.0 CDTI	10/10-	A 20 DTH	1956	24x199		SK-1586	BTK
2.0 CDTI	10/10-	A 20 DTH	1956	24x199		SK-1586AQ1	BTKW
1.6, 1.6 LPG, 1.6 Turbo	10/10-	A 16 LET, A 16 XER, A 16 XER, B 16 XER	1598			0-N1347	TB [TE]
1.6, 1.6 LPG, 1.6 Turbo	10/10-	A 16 LET, A 16 XER, A 16 XER, B 16 XER	1598			0-N1348	TB [DG]
1.7 CDTI	10/10-	A 17 DTC, A 17 DTE, A 17 DTJ, A 17 DTF, A 17 DTS, A 17 DTL, A 17 DTN, A 17 DTR	1686			0-N1085	TB [TE]
1.7 CDTI	10/10-	A 17 DTF, A 17 DTS, A 17 DTL, A 17 DTN, A 17 DTR	1686			0-N878	TB [DG]
1.7 CDTI	10/10-	A17DTJ	1686			0-N878	TB [DG]
2.0 BiTurbo CDTI	12/12-	A 20 DTR	1956			0-N2236	TB [DG]
2.0 BiTurbo CDTI, 2.0 CDTI	10/10-	A 20 DTH, A 20 DTR	1956			0-N2149	TB [DG]
2.0 CDTI	10/10-	A 20 DTH	1956			0-N115	TB [TE]
1.3 CDTI	10/10-	A 13 DTE	1248			0-N1526	VB [BT] S
1.4	10/10-	A 14 XER	1398			0-N2170	VB [BT] S
1.4 LPG, 1.4 Turbo	10/10-	A 14 NEL, B 14 NEL, A 14 NET, A 14 NET, B 14 NET	1364			0-N2170	VB [BT] S
1.6 CDTi	01/14-	B 16 DTH, B 16 DTL	1598	☼		0-N1649	VB [DG]
1.6, 1.6 Turbo	10/10-	A 16 LET, A 16 XER, B 16 XER	1598			0-N1799	VB [BT] S

CM³

Art. Nr.

**ASTRA J Sports Tourer**

1.7 CDTI	10/10-	A 17 DTC, A 17 DTE, A 17 DTJ, A 17 DTF, A 17 DTS, A 17 DTL, A 17 DTN, A 17 DTR	1686	⊛	0-N2341	VB [DG]	
1.7 CDTI	10/10-	A 17 DTC, A 17 DTE, A 17 DTJ, A 17 DTF, A 17 DTS, A 17 DTL, A 17 DTN, A 17 DTR	1686		0-N2389	VB [BT]	S
2.0 BiTurbo CDTI, 2.0 CDTI	10/10-	A 20 DTH, A 20 DTR	1956	⊛	0-N1649	VB [DG]	
2.0 BiTurbo CDTI, 2.0 CDTI	10/10-	A 20 DTH, A 20 DTR	1956		0-N2221	VB [DG]	
2.0 BiTurbo CDTI, 2.0 CDTI	10/10-	A 20 DTH, A 20 DTR	1956		für Fahrzeuge mit elektrischer Servolenkung	0-N2254	VB [DG]
2.0 CDTI	10/10-	A 20 DTH	1956		0-N2087	VB [BT]	S
2.0 CDTI	08/11-	A 20 DTH	1956		0-N1649	VB [DG]	

CALIBRA A (85_)

2.0 i 16V, 2.0 i 16V 4x4	06/90-02/94	C 20 XE	1998	24x176; :14142839→	SK-1165	BTK	
2.0 i 16V, 2.0 i 16V 4x4	02/94-07/97	X 20 XEV	1998	24x169; 09/1994 →	SK-1100	BTK	
2.0 i 16V, 2.0 i 16V 4x4	02/94-07/97	X 20 XEV	1998	24x169; 09/1994 →	SK-1100AQ1	BTKW	
2.0 i 16V, 2.0 i 16V 4x4, 2.0 i Turbo 4x4	06/90-07/97	C 20 LET, C 20 XE	1998	24x141	SK-1163	BTK	
2.0 i Turbo 4x4	03/92-07/97	C 20 LET	1998	24x176; :14002935→	SK-1165	BTK	
2.0 i, 2.0 i 4x4	06/90-07/97	C 20 NE	1998	20x111; :→14608701	R-1072AQ1	BTKW	
2.0 i, 2.0 i 4x4	06/90-07/97	C 20 NE	1998	20x146; :14608701→	SK-1169	BTK	
2.0 i, 2.0 i 4x4	06/90-07/97	C 20 NE	1998	20x146; :14608702→	SK-1169AQ1	BTKW	
2.5 i V6	04/93-07/97	C 25 XE, X 25 XE	2498	30x225; 09/1993 →; mit Zubehör	SK-1508	BTK	
2.0 i 16V, 2.0 i 16V 4x4	06/90-02/94	C 20 XE	1998	:14142839→	0-N100	TB [TE]	
2.0 i 16V, 2.0 i 16V 4x4	06/90-02/94	C 20 XE	1998	:→14142838	0-N876	TB [DG]	
2.0 i 16V, 2.0 i 16V 4x4	06/90-02/94	C 20 XE	1998	:→14142838	0-N877	TB [TE]	
2.0 i 16V, 2.0 i 16V 4x4	06/90-02/94	C 20 XE	1998	:14142839→	0-N906	TB [DG]	
2.0 i 16V, 2.0 i 16V 4x4	06/90-02/94	C 20 XE	1998	:14142839→	0-N907	TB [DG]	
2.0 i 16V, 2.0 i 16V 4x4	02/94-07/97	X 20 XEV	1998		0-N100	TB [TE]	
2.0 i 16V, 2.0 i 16V 4x4	02/94-07/97	X 20 XEV	1998		0-N906	TB [DG]	
2.0 i Turbo 4x4	03/92-07/97	C 20 LET	1998	:14002935→	0-N100	TB [TE]	
2.0 i Turbo 4x4	03/92-07/97	C 20 LET	1998	:→14002934	0-N876	TB [DG]	
2.0 i Turbo 4x4	03/92-07/97	C 20 LET	1998	:→14002934	0-N877	TB [TE]	
2.0 i Turbo 4x4	03/92-07/97	C 20 LET	1998	:14002935→	0-N906	TB [DG]	
2.0 i Turbo 4x4	03/92-07/97	C 20 LET	1998	:14002935→	0-N907	TB [DG]	
2.0 i, 2.0 i 4x4	06/90-07/97	C 20 NE	1998	:14608701→	0-N101	TB [TE]	
2.5 i V6	04/93-07/97	C 25 XE, X 25 XE	2498		0-N957	TB [DG]	
2.0 i, 2.0 i 16V, 2.0 i 16V 4x4, 2.0 i 4x4, 2.0 i Turbo 4x4	06/90-07/97	C 20 LET, C 20 NE, C 20 XE, X 20 XEV	1998		0-N1422	VB [BT]	S
2.5 i V6	04/93-07/97	C 25 XE, X 25 XE	2498	Rippenanzahl: 6	0-N1438	VB [BT]	S
2.5 i V6	04/93-07/97	C 25 XE, X 25 XE	2498	⊛	0-N1603	VB [DG]	

CAMPO (TF_)

2.5 D, 2.5 D 4x4, 2.5 TD, 2.5 TD 4x4	08/91-06/94	4 JA1, 4 JA1T	2499	32x119	SK-1260	BTK	
3.1 TD, 3.1 TD 4x4	12/92-	4 JG2T	3059	32x119	SK-1260	BTK	
2.2 D, 2.2 D 4x4	08/91-09/96	C223	2238		0-N048	TB [TE]	
2.3, 2.3 4x4	08/91-08/94	4 ZD1	2255		0-N042	TB [TE]	
2.3, 2.3 4x4	08/94-09/96	23 P, 4 ZD1, 4 ZD1	2254		0-N042	TB [TE]	
2.5 D, 2.5 D 4x4, 2.5 DTI, 2.5 DTI 4x4, 2.5 TD, 2.5 TD 4x4	08/91-06/94	4 JA1, 4 JA1T	2499		0-N049	TB [TE]	
2.5 D, 2.5 D 4x4, 2.5 DTI, 2.5 DTI 4x4, 2.5 TD, 2.5 TD 4x4	08/91-06/94	4 JA1, 4 JA1T	2499		0-N050	TB [DG]	
3.1 TD, 3.1 TD 4x4	12/92-	4 JG2T	3059		0-N049	TB [TE]	
3.1 TD, 3.1 TD 4x4	12/92-	4 JG2T	3059		0-N050	TB [DG]	

CASCADA (W13)

2.0 CDTI	03/13-	A 20 DTH	1956	24x199	SK-1586	BTK	
2.0 CDTI	03/13-	A 20 DTH	1956	24x199	SK-1586AQ1	BTKW	
2.0 CDTI	03/13-	A 20 DTH, A 20 DTR	1956		0-N2149	TB [DG]	
2.0 CDTI	03/13-	A 20 DTR	1956		0-N2236	TB [DG]	
1.4, 1.4 Turbo	03/13-	A 14 NEL, A 14 NET	1362		0-N2170	VB [BT]	S
2.0 CDTI	03/13-	A 20 DTH, A 20 DTR	1956	für Fahrzeuge mit elektrischer Servolenkung	0-N2254	VB [DG]	

COMBO (71_)

1.2	07/94-10/01	C 12 NZ, X 12 SZ	1195	17x111; mit Zubehör	SK-1162	BTK	
1.2	07/94-10/01	C 12 NZ, X 12 SZ	1195	17x111; ch.→Y4999999, Y6999999; mit Zubehör	SK-1162AQ1	BTKW	
1.4	07/94-10/01	C 14 NZ, X 14 SZ, C 14 SE	1389	17x111; mit Zubehör	SK-1162	BTK	
1.4	07/94-10/01	C 14 NZ, X 14 SZ, C 14 SE	1389	17x111; ch.→Y4999999, Y6999999; mit Zubehör	SK-1162AQ1	BTKW	
1.4 16V	08/99-10/01	X 14 XE	1389	20x169; mit Zubehör	SK-1073	BTK	
1.4 16V	08/99-10/01	X 14 XE	1389	20x169; mit Zubehör	SK-1073AQ1	BTKW	



CM³



Art. Nr.



COMBO (71_)							
1.7 D	07/94-10/01	17 D (4EE1), X 17 D (4EE1)	1686	25.4x136; R3999999, R4999999, R6999999; mit Zubehör	SK-1164	BTK	
1.7 D	07/94-10/01	17 D (4EE1), X 17 D (4EE1)	1686	25x136; ch.S3000001, S4000001, S6000001→; :→029082; mit Zubehör	SK-1168	BTK	
1.4 16V	08/99-10/01	X 14 XE	1389		0-N102	TB [TE]	
1.4 16V	08/99-10/01	X 14 XE	1389		0-N952	TB [DG]	
1.4 16V	08/99-10/01	X 14 XE	1389		0-N953	TB [DG]	
1.7 D	07/94-10/01	17 D (4EE1), X 17 D (4EE1)	1686	:855806→	0-N126	TB [TE]	
1.7 D	07/94-10/01	17 D (4EE1), X 17 D (4EE1)	1686		0-N878	TB [DG]	
1.7 D	07/94-10/01	17 D (4EE1), X 17 D (4EE1)	1686	:→855805	0-N910	TB [TE]	
1.2	07/94-10/01	C 12 NZ, X 12 SZ	1195		0-N1322	VB [TE]	S
1.2	07/94-10/01	C 12 NZ, X 12 SZ	1195		0-N948	TB [TE]	
1.4	07/94-10/01	C 14 NZ, X 14 SZ, C 14 SE	1389		0-N1322	VB [TE]	S
1.4	07/94-10/01	C 14 NZ, X 14 SZ, C 14 SE	1389		0-N1422	VB [BT]	S
1.4	07/94-10/01	C 14 NZ, X 14 SZ, C 14 SE	1389		0-N948	TB [TE]	
1.4, 1.4 16V	07/94-10/01	C 14 NZ, X 14 SZ, X 14 XE	1389	Rippenanzahl: 6	0-N1439	VB [DG]	
1.4, 1.4 16V	07/94-10/01	C 14 NZ, X 14 SZ, X 14 XE	1389	für Fahrzeuge ohne Servolenkung	0-N1464	VB [BT]	S
1.7 D	07/94-10/01	17 D (4EE1), X 17 D (4EE1)	1686	Rippenanzahl: 6;	0-N1439	VB [DG]	
COMBO Kasten/Kombi							
1.6	10/01-	Z 16 SE	1598	17x111; mit Zubehör	SK-1162	BTK	
1.6	10/01-	Z 16 SE	1598	17x111	SK-1162AQ2	BTKW	
1.6 CNG 16V	04/05-	Z 16 YNG	1598	20x162; mit Zubehör	SK-1355	BTK	
1.6 CNG 16V	04/05-	Z 16 YNG	1598	20x162; mit Zubehör	SK-1355AQ2	BTKW	
1.7 CDTI 16V	12/04-	Z 17 DTH	1686	25x131; mit Zubehör	SK-1481	BTK	
1.7 DI 16V, 1.7 DTI 16V	10/01-	Y 17 DT, Y 17 DTL	1686	25x131; 11/2001 →; mit Zubehör	SK-1479	BTK	
1.7 DI 16V, 1.7 DTI 16V	10/01-	Y 17 DT, Y 17 DTL	1686	25x131; :328704→; mit Zubehör	SK-1481	BTK	
1.7 DI 16V, 1.7 DTI 16V	10/01-	Y 17 DT, Y 17 DTL	1686	25x131; 11/2001 →; :→328703	SK-1689	BTK	
1.6 CNG 16V	04/05-	Z 16 YNG	1598		0-N102	TB [TE]	
1.6 CNG 16V	04/05-	Z 16 YNG	1598	†; mit Anbaumaterial	0-N300	TB [DG]	
1.6 CNG 16V	04/05-	Z 16 YNG	1598		0-N953	TB [DG]	
1.7 CDTI 16V	12/04-	Z 17 DTH	1686		0-N1085	TB [TE]	
1.7 CDTI 16V, 1.7 DI 16V, 1.7 DTI 16V	10/01-	Y 17 DT, Y 17 DTL, Z 17 DTH	1686		0-N878	TB [DG]	
1.7 DI 16V, 1.7 DTI 16V	10/01-	Y 17 DT, Y 17 DTL	1686	:0328705→	0-N1085	TB [TE]	
1.3 CDTI 16V	08/05-	Z 13 DT, Z 13 DTJ	1248		0-N1526	VB [BT]	S
1.4 16V	08/05-	Z 14 XEP	1364		0-N2170	VB [BT]	S
1.6	10/01-	Z 16 SE	1598		0-N948	TB [TE]	
1.6, 1.6 CNG 16V	10/01-	Z 16 SE, Z 16 YNG	1598		0-N1466	VB [BT]	S
1.7 CDTI 16V	12/04-	Z 17 DTH	1686		0-N1798	VB [BT]	S
1.7 CDTI 16V, 1.7 DI 16V, 1.7 DTI 16V	10/01-	Y 17 DT, Y 17 DTL, Z 17 DTH	1686		0-N1426	VB [DG]	
1.7 DI 16V, 1.7 DTI 16V	10/01-	Y 17 DT, Y 17 DTL	1686		0-N1495S	VB [TE]	
COMBO Tour							
1.6	10/01-	Z 16 SE	1598	17x111; mit Zubehör	SK-1162	BTK	
1.6	10/01-	Z 16 SE	1598	17x111	SK-1162AQ2	BTKW	
1.6 CNG	04/05-	Z 16 YNG	1598	20x162; mit Zubehör	SK-1355	BTK	
1.6 CNG	04/05-	Z 16 YNG	1598	20x162; mit Zubehör	SK-1355AQ2	BTKW	
1.6 CNG	06/06-	Z 16 YNG	1598	20x162; mit Zubehör	SK-1355AQ1	BTKW	
1.7 CDTI 16V	12/04-	Z 17 DTH	1686	25x131; mit Zubehör	SK-1481	BTK	
1.7 DI 16V, 1.7 DTI 16V	10/01-	Y 17 DT, Y 17 DTL	1686	25x131; mit Zubehör	SK-1479	BTK	
1.7 DI 16V, 1.7 DTI 16V	10/01-	Y 17 DT, Y 17 DTL	1686	25x131; :328704→; mit Zubehör	SK-1481	BTK	
1.7 DI 16V, 1.7 DTI 16V	10/01-	Y 17 DT, Y 17 DTL	1686	25x131; :→328703	SK-1689	BTK	
1.6 CNG	04/05-	Z 16 YNG	1598		0-N102	TB [TE]	
1.6 CNG	04/05-	Z 16 YNG	1598	†; mit Anbaumaterial	0-N300	TB [DG]	
1.6 CNG	04/05-	Z 16 YNG	1598		0-N953	TB [DG]	
1.7 CDTI 16V	12/04-	Z 17 DTH	1686		0-N1085	TB [TE]	
1.7 CDTI 16V, 1.7 DI 16V, 1.7 DTI 16V	10/01-	Y 17 DT, Y 17 DTL, Z 17 DTH	1686		0-N878	TB [DG]	
1.7 DI 16V, 1.7 DTI 16V	10/01-	Y 17 DT, Y 17 DTL	1686	:0328705→	0-N1085	TB [TE]	
1.3 CDTI 16V	10/04-	Y 13 DT, Z 13 DT, Z 13 DTJ	1248		0-N1526	VB [BT]	S
1.4	10/04-	Z 14 XEP	1364		0-N2170	VB [BT]	S
1.6	10/01-	Z 16 SE	1598		0-N948	TB [TE]	
1.6, 1.6 CNG	10/01-	Z 16 SE, Z 16 YNG	1598		0-N1466	VB [BT]	S
1.7 CDTI 16V	12/04-	Z 17 DTH	1686		0-N1798	VB [BT]	S
1.7 CDTI 16V, 1.7 DI 16V, 1.7 DTI 16V	10/01-	Y 17 DT, Y 17 DTL, Z 17 DTH	1686		0-N1426	VB [DG]	
1.7 DI 16V, 1.7 DTI 16V	10/01-	Y 17 DT, Y 17 DTL	1686		0-N1495S	VB [TE]	
COMBO Kasten/Kombi (X12)							
1.6 CDTI	02/12-	A 16 FDH, A 16 FDL	1598	24x194	SK-1693	BTK	



OPTIMAL®

OPEL



CM³



Art. Nr.



ohne Halter

COMBO Kasten/Kombi (X12)

1.6 CDTI	02/12-	A 16 FDH, A 16 FDL	1598	24x194	SK-1693AQ1	BTKW	
2.0 CDTI	02/12-	A 20 FD	1956	24x199	SK-1586	BTK	
2.0 CDTI	02/12-	A 20 FD	1956	24x199	SK-1586AQ1	BTKW	
1.4, 1.4 CNG	02/12-	A 14 FC, A 14 FP	1368		0-N195	TB [TE]	
1.6 CDTI	02/12-	A 16 FDH, A 16 FDL	1598		0-N2149	TB [DG]	
2.0 CDTI	02/12-	A 20 FD	1956		0-N2149	TB [DG]	
1.3 CDTI	02/12-	A 13 FD	1248		0-N2390	VB [BT]	S

COMBO Tour (X12)

1.6 CDTI	02/12-	A 16 FDH, A 16 FDL	1598	24x194	SK-1693	BTK	
1.6 CDTI	02/12-	A 16 FDH, A 16 FDL	1598	24x194	SK-1693AQ1	BTKW	
2.0 CDTI	02/12-	A 20 FD	1956	24x199	SK-1586	BTK	
2.0 CDTI	02/12-	A 20 FD	1956	24x199	SK-1586AQ1	BTKW	
1.4, 1.4 CNG	02/12-	A 14 FC, A 14 FP	1368		0-N195	TB [TE]	
1.6 CDTI	02/12-	A 16 FDH, A 16 FDL	1598		0-N2149	TB [DG]	
2.0 CDTI	02/12-	A 20 FD	1956		0-N2149	TB [DG]	
1.3 CDTI	02/12-	A 13 FD	1248		0-N2390	VB [BT]	S

CORSA A CC (93_, 94_, 98_, 99_)

1.2 i	09/89-03/93	C 12 NZ	1195	17x111; mit Zubehör	SK-1162	BTK	
1.2 i	09/89-03/93	C 12 NZ	1195	17x111; 09/1990 →; (EUSA) → 02J22350; nicht für Länderausführung Schweden, Schweiz; mit Zubehör	SK-1162AQ1	BTKW	
1.4 i	01/85-03/93	C 14 NZ	1389	17x111; (EUSA):02J22350, 19311738 →; mit Zubehör	SK-1162	BTK	
1.4 i	01/85-03/93	C 14 NZ	1389	17x111; (EUSA):02J22350, 19311738 →; nicht für Länderausführung Schweden, Schweiz; mit Zubehör	SK-1162AQ1	BTKW	
1.4 i	01/90-03/93	C 14 NZ	1389	17x111; (EUSA):19311738 →; mit Zubehör	SK-1162	BTK	
1.4 S	01/90-03/93	14 NV	1389	17x111; (EUSA):19307806 →; mit Zubehör	SK-1162	BTK	
1.4 S	01/90-03/93	14 NV	1389	17x111; (EUSA):02J22350, 19307806 →; nicht für Länderausführung Schweden, Schweiz; mit Zubehör	SK-1162AQ1	BTKW	
1.4 Si	09/91-03/93	C 14 SE	1389	17x111; (EUSA):02J22350 →; mit Zubehör	SK-1162	BTK	
1.4 Si	09/91-03/93	C 14 SE	1389	17x111; (EUSA):02J22350 →; nicht für Länderausführung Schweden, Schweiz; mit Zubehör	SK-1162AQ1	BTKW	
1.5 D, 1.5 TD	09/87-03/93	15 D (4EC1), 15 DT (T4EC1)	1488	25x136; mit Zubehör	SK-1054	BTK	
1.6 GSI	08/88-09/92	C 16 NZ	1598	17x111; (EUSA):02122350 →; mit Zubehör	SK-1162	BTK	
1.6 GSI, 1.6 GSI KAT	05/88-03/93	C 16 SE, C 16 SEI, E 16 SE	1598	17x111; (EUSA):02J22350 →; mit Zubehör	SK-1162	BTK	
1.6 GSI, 1.6 GSI KAT	05/88-03/93	C 16 NZ, C 16 SE, C 16 SEI, E 16 SE	1598	17x111; (EUSA):02J22350 →; nicht für Länderausführung Schweden, Schweiz; mit Zubehör	SK-1162AQ1	BTKW	
1.5 D, 1.5 TD	09/87-03/93	15 D (4EC1), 15 DT (T4EC1)	1488		0-N878	TB [DG]	
1.5 D, 1.5 TD	09/87-03/93	15 D (4EC1), 15 DT (T4EC1)	1488		0-N879	TB [TE]	
1.2 i	09/89-03/93	C 12 NZ	1195		0-N948	TB [TE]	
1.4 i	01/85-03/93	C 14 NZ	1389	(EUSA):02J22350, 19311739 →	0-N948	TB [TE]	
1.4 i	01/90-03/93	C 14 NZ	1389	(EUSA):02J22350, 19311759 →	0-N948	TB [TE]	
1.4 S	01/90-03/93	14 NV	1389	(EUSA):02J22350, 19307806 →	0-N948	TB [TE]	
1.4 Si	09/91-03/93	C 14 SE	1389		0-N948	TB [TE]	
1.6 GSI, 1.6 GSI KAT	05/88-03/93	C 16 NZ, C 16 SE, C 16 SEI, E 16 SE	1598	(EUSA):02J22350 →	0-N948	TB [TE]	

CORSA A Kasten

1.5 D	06/87-04/89	15 D (4EC1)	1488	25x136; mit Zubehör	SK-1054	BTK	
1.5 D	06/87-04/89	15 D (4EC1)	1488		0-N878	TB [DG]	
1.5 D	06/87-04/89	15 D (4EC1)	1488		0-N879	TB [TE]	

CORSA A TR (91_, 92_, 96_, 97_)

1.2 i	09/89-03/93	C 12 NZ	1195	17x111; mit Zubehör	SK-1162	BTK	
1.2 i	09/89-03/93	C 12 NZ	1195	17x111; 09/1990 →; (EUSA) → 02J22350; nicht für Länderausführung Schweden, Schweiz; mit Zubehör	SK-1162AQ1	BTKW	
1.4 i	10/89-03/93	C 14 NZ	1389	17x111; (EUSA):19311739 →; mit Zubehör	SK-1162	BTK	
1.4 i	10/89-03/93	C 14 NZ	1389	17x111; (EUSA):02J22350, 19311738 →; nicht für Länderausführung Schweden, Schweiz; mit Zubehör	SK-1162AQ1	BTKW	
1.4 S	09/89-03/93	14 NV	1389	17x111; (EUSA):19307806 →; mit Zubehör	SK-1162	BTK	
1.4 S	09/89-03/93	14 NV	1389	17x111; (EUSA):02J22350, 19307806 →; nicht für Länderausführung Schweden, Schweiz; mit Zubehör	SK-1162AQ1	BTKW	
1.5 D, 1.5 TD	10/87-03/93	15 D (4EC1), 15 DT (T4EC1)	1488	25x136; mit Zubehör	SK-1054	BTK	
1.5 D, 1.5 TD	10/87-03/93	15 D (4EC1), 15 DT (T4EC1)	1488		0-N878	TB [DG]	



CM³



Art. Nr.



CORSA A TR (91_, 92_, 96_, 97_)

1.5 D, 1.5 TD	10/87-03/93	15 D (4EC1), 15 DT (T4EC1)	1488		0-N879	TB [TE]
1.2 i	09/89-03/93	C 12 NZ	1195		0-N948	TB [TE]
1.4 i	10/89-03/93	C 14 NZ	1389	:02J22350, 19311759→	0-N948	TB [TE]
1.4 S	09/89-03/93	14 NV	1389	:02J22350, 19307806→	0-N948	TB [TE]

CORSA B (73_, 78_, 79_)

1.2 i	03/93-09/00	12 NZ, C 12 NZ, X 12 SZ	1195	17x111; mit Zubehör	SK-1162	BTK
1.2 i	03/93-09/00	12 NZ, C 12 NZ, X 12 SZ	1195	17x111; ch.→Y4999999, Y6999999; mit Zubehör	SK-1162AQ1	BTKW
1.4 i 16V	09/94-09/00	X 14 XE	1389	20x169; mit Zubehör; Baumuster: Vita	SK-1073AQ1	BTKW
1.4 i 16V	08/97-09/00	C 14 SEL	1389	20x169; mit Zubehör	SK-1073AQ1	BTKW
1.4, 1.4 i 16V	04/93-09/00	C 14 SE, C 14 SEL, X 14 XE	1389	20x169; mit Zubehör	SK-1073	BTK
1.4, 1.4 i, 1.4 Si	03/93-09/00	C 14 NZ, X 14 SZ, C 14 SE	1389	17x111; mit Zubehör	SK-1162	BTK
1.4, 1.4 i, 1.4 Si	03/93-09/00	C 14 NZ, X 14 SZ, C 14 SE	1389	17x111; ch.→Y4999999, Y6999999; mit Zubehör	SK-1162AQ1	BTKW
1.5 D, 1.5 TD	03/93-09/00	15 D (4EC1), 15 DT (T4EC1), X 15 DT (T4EC1)	1488	25x136; mit Zubehör	SK-1054	BTK
1.6 GSI 16V, 1.6 i 16V	03/93-09/00	C 16 SEL, C 16 XE, X 16 XE	1598	20x169; mit Zubehör	SK-1073	BTK
1.6 GSI 16V, 1.6 i 16V	03/93-09/00	C 16 SEL, C 16 XE, X 16 XE	1598	20x169; mit Zubehör	SK-1073AQ1	BTKW
1.7 D	02/96-09/00	17 D (4EE1), X 17 D (4EE1)	1686	25.4x136; R3999999, R4999999, R6999999; mit Zubehör	SK-1164	BTK
1.7 D	02/96-09/00	17 D (4EE1), X 17 D (4EE1)	1686	25x136; ch.S3000001, S4000001, S6000001→; :→029082; mit Zubehör	SK-1168	BTK
1.4 i 16V	09/94-09/00	C 14 SEL, X 14 XE	1389		0-N102	TB [TE]
1.4 i 16V	09/94-09/00	C 14 SEL, X 14 XE	1389		0-N952	TB [DG]
1.4 i 16V	09/94-09/00	C 14 SEL, X 14 XE	1389		0-N953	TB [DG]
1.5 D, 1.5 TD	03/93-09/00	15 D (4EC1), 15 DT (T4EC1), X 15 DT (T4EC1)	1488		0-N878	TB [DG]
1.5 D, 1.5 TD	03/93-09/00	15 D (4EC1), 15 DT (T4EC1), X 15 DT (T4EC1)	1488		0-N879	TB [TE]
1.6 GSI 16V, 1.6 i 16V	03/93-09/00	C 16 SEL, C 16 XE, X 16 XE	1598		0-N102	TB [TE]
1.6 GSI 16V, 1.6 i 16V	03/93-09/00	C 16 SEL, C 16 XE, X 16 XE	1598		0-N952	TB [DG]
1.6 GSI 16V, 1.6 i 16V	03/93-09/00	C 16 SEL, C 16 XE, X 16 XE	1598		0-N953	TB [DG]
1.7 D	02/96-09/00	17 D (4EE1), X 17 D (4EE1)	1686	:855806→	0-N126	TB [TE]
1.7 D	02/96-09/00	17 D (4EE1), X 17 D (4EE1)	1686		0-N878	TB [DG]
1.7 D	02/96-09/00	17 D (4EE1), X 17 D (4EE1)	1686	:→855805	0-N910	TB [TE]
1.0 i 12V	11/96-09/00	X 10 XE	973		0-N2170	VB [BT] S
1.2 i	03/93-09/00	C 12 NZ, X 12 SZ	1195		0-N1322	VB [TE] S
1.2 i	03/93-09/00	12 NZ, C 12 NZ, X 12 SZ	1195		0-N948	TB [TE]
1.2 i 16V	03/98-09/00	X 12 XE	1199		0-N2170	VB [BT] S
1.4 i	03/93-09/00	C 14 NZ, X 14 SZ	1389	:19311739→	0-N948	TB [TE]
1.4 i, 1.4 i 16V, 1.4 Si	03/93-09/00	C 14 NZ, X 14 SZ, C 14 SE, X 14 XE	1389		0-N1422	VB [BT] S
1.4 i, 1.4 Si	03/93-09/00	C 14 NZ, X 14 SZ, C 14 SE	1389		0-N1322	VB [TE] S
1.4, 1.4 i, 1.4 i 16V, 1.4 Si	03/93-09/00	C 14 NZ, X 14 SZ, C 14 SE, C 14 SEL, X 14 XE	1389	Rippenanzahl: 6	0-N1439	VB [DG]
1.4, 1.4 i, 1.4 i 16V, 1.4 Si	03/93-09/00	C 14 NZ, X 14 SZ, C 14 SE, C 14 SEL, X 14 XE	1389	für Fahrzeuge ohne Servolenkung	0-N1464	VB [BT] S
1.4, 1.4 i, 1.4 Si	03/93-09/00	C 14 NZ, X 14 SZ, C 14 SE	1389		0-N948	TB [TE]
1.5 D, 1.5 TD	03/93-09/00	15 D (4EC1), 15 DT (T4EC1), X 15 DT (T4EC1)	1488	Rippenanzahl: 6;	0-N1439	VB [DG]
1.6 GSI 16V, 1.6 i 16V	03/93-09/00	C 16 XE, X 16 XE	1598		0-N1422	VB [BT] S
1.6 GSI 16V, 1.6 i 16V	03/93-09/00	C 16 SEL, C 16 XE, X 16 XE	1598	Rippenanzahl: 6	0-N1439	VB [DG]
1.6 GSI 16V, 1.6 i 16V	03/93-09/00	C 16 SEL, C 16 XE, X 16 XE	1598	für Fahrzeuge ohne Servolenkung	0-N1464	VB [BT] S
1.7 D	02/96-09/00	17 D (4EE1), X 17 D (4EE1)	1686	Rippenanzahl: 6;	0-N1439	VB [DG]

CORSA B Kasten (73_)

1.4 i	08/99-09/00	C 14 NZ, X 14 SZ	1389	17x111; mit Zubehör	SK-1162	BTK
1.4 i	08/99-09/00	C 14 NZ, X 14 SZ	1389	17x111; ch.→Y4999999, Y6999999; mit Zubehör	SK-1162AQ1	BTKW
1.7 D	08/99-09/00	17 D (4EE1), X 17 D (4EE1)	1686	25.4x136; R3999999, R4999999, R6999999; mit Zubehör	SK-1164	BTK
1.7 D	08/99-09/00	17 D (4EE1), X 17 D (4EE1)	1686	25x136; ch.S3000001, S4000001, S6000001→; :→029082; mit Zubehör	SK-1168	BTK
1.7 D	08/99-09/00	17 D (4EE1), X 17 D (4EE1)	1686	:855806→	0-N126	TB [TE]
1.7 D	08/99-09/00	17 D (4EE1), X 17 D (4EE1)	1686		0-N878	TB [DG]
1.7 D	08/99-09/00	17 D (4EE1), X 17 D (4EE1)	1686	:→855805	0-N910	TB [TE]
1.4 i	08/99-09/00	C 14 NZ, X 14 SZ	1389		0-N1322	VB [TE] S
1.4 i	08/99-09/00	C 14 NZ, X 14 SZ	1389		0-N1422	VB [BT] S
1.4 i	08/99-09/00	C 14 NZ, X 14 SZ	1389	Rippenanzahl: 6	0-N1439	VB [DG]
1.4 i	08/99-09/00	C 14 NZ, X 14 SZ	1389	für Fahrzeuge ohne Servolenkung	0-N1464	VB [BT] S



OPTIMAL®

OPEL



CM³



Art. Nr.



CORSA B Kasten (73_)

1.4 i	08/99-09/00	C 14 NZ, X 14 SZ	1389		0-N948	TB [TE]	
1.7 D	08/99-09/00	17 D (4EE1), X 17 D (4EE1)	1686	Rippenanzahl: 6; ☼	0-N1439	VB [DG]	

CORSA B Kombi (F35)

1.4 i 16V	01/99-	X 14 XE	1389	20x169; mit Zubehör	SK-1073	BTK	
1.4 i 16V	01/99-	X 14 XE	1389	20x169; mit Zubehör	SK-1073AQ1	BTKW	
1.7 D	01/99-	X 17 D (4EE1)	1686	25.4x136; R3999999, R4999999; → 12/2003; mit Zubehör	SK-1164	BTK	
1.7 D	01/99-	X 17 D (4EE1)	1686	25.4x136; R6999999; → 12/2003; mit Zubehör	SK-1164	BTK	
1.7 D	01/99-	X 17 D (4EE1)	1686	25x136; ch.S3000001, S4000001→; :→029082; mit Zubehör	SK-1168	BTK	
1.7 D	01/99-	X 17 D (4EE1)	1686	25x136; ch.S6000001→; :→029082; mit Zubehör	SK-1168	BTK	
1.4 i 16V	01/99-	X 14 XE	1389		0-N102	TB [TE]	
1.4 i 16V	01/99-	X 14 XE	1389		0-N952	TB [DG]	
1.4 i 16V	01/99-	X 14 XE	1389		0-N953	TB [DG]	
1.7 D	01/99-	X 17 D (4EE1)	1686	:855806→	0-N126	TB [TE]	
1.7 D	01/99-	X 17 D (4EE1)	1686		0-N878	TB [DG]	
1.7 D	01/99-	X 17 D (4EE1)	1686	:→855805	0-N910	TB [TE]	
1.4 i 16V	01/99-	X 14 XE	1389		0-N1422	VB [BT]	S
1.4 i 16V	01/99-	X 14 XE	1389	Rippenanzahl: 6	0-N1439	VB [DG]	
1.4 i 16V	01/99-	X 14 XE	1389	für Fahrzeuge ohne Servolenkung	0-N1464	VB [BT]	S
1.7 D	01/99-	X 17 D (4EE1)	1686	Rippenanzahl: 6; ☼	0-N1439	VB [DG]	

CORSA C (F08, F68)

1.4	09/00-12/09	Z 14 XE	1389	20x162; :→02NF0884, 20V82069; mit Zubehör	SK-1113	BTK	
1.4	09/00-12/09	Z 14 XE	1389	20x162; mit Zubehör	SK-1355	BTK	
1.4	09/00-12/09	Z 14 XE	1389	20x162; :02MZ5254, 20U75999→; mit Zubehör	SK-1355AQ2	BTKW	
1.4	09/00-12/09	Z 14 XE	1389	20x162; :→02MZ5253, 20U75998	SK-1355AQ3	BTKW	
1.6 CNG	05/03-12/09	Y 16 YNG	1598	20x162; mit Zubehör	SK-1355	BTK	
1.6 CNG	05/03-12/09	Y 16 YNG	1598	20x162; → 07/2006; mit Zubehör	SK-1355AQ2	BTKW	
1.7 CDTI	06/03-12/09	Z 17 DTH	1686	25x131; mit Zubehör	SK-1481	BTK	
1.7 DI, 1.7 DTI	09/00-12/09	Y 17 DT, Y 17 DTL	1686	25x131; mit Zubehör	SK-1479	BTK	
1.7 DI, 1.7 DTI	09/00-12/09	Y 17 DT, Y 17 DTL	1686	25x131; :328704→; mit Zubehör	SK-1481	BTK	
1.7 DI, 1.7 DTI	09/00-12/09	Y 17 DT, Y 17 DTL	1686	25x131; :→328703	SK-1689	BTK	
1.8	09/00-12/09	Z 18 XE	1796	20x162; 04/2001 →; :→02NF0884, 20V82069; mit Zubehör	SK-1113	BTK	
1.8	09/00-12/09	Z 18 XE	1796	20x162; mit Zubehör	SK-1355	BTK	
1.8	09/00-12/09	Z 18 XE	1796	20x162; mit Zubehör	SK-1355AQ1	BTKW	
1.4	09/00-12/09	Z 14 XE	1389		0-N102	TB [TE]	
1.4	09/00-12/09	Z 14 XE	1389	†; mit Anbaumaterial	0-N300	TB [DG]	
1.4	09/00-12/09	Z 14 XE	1389		0-N953	TB [DG]	
1.6 CNG	05/03-12/09	Y 16 YNG	1598		0-N102	TB [TE]	
1.6 CNG	05/03-12/09	Y 16 YNG	1598	†; mit Anbaumaterial	0-N300	TB [DG]	
1.6 CNG	05/03-12/09	Y 16 YNG	1598		0-N953	TB [DG]	
1.7 CDTI	06/03-12/09	Z 17 DTH	1686		0-N1085	TB [TE]	
1.7 CDTI, 1.7 DI, 1.7 DTI	09/00-12/09	Y 17 DT, Y 17 DTL, Z 17 DTH	1686		0-N878	TB [DG]	
1.7 DI, 1.7 DTI	09/00-12/09	Y 17 DT, Y 17 DTL	1686	:0328705→	0-N1085	TB [TE]	
1.8	09/00-12/09	Z 18 XE	1796		0-N102	TB [TE]	
1.8	09/00-12/09	Z 18 XE	1796	†; mit Anbaumaterial	0-N300	TB [DG]	
1.8	09/00-12/09	Z 18 XE	1796		0-N953	TB [DG]	
1.0	09/00-06/03	Z 10 XE	973		0-N2170	VB [BT]	S
1.0	06/03-12/09	Z 10 XEP	998		0-N2170	VB [BT]	S
1.2	09/00-12/09	Z 12 XE	1199		0-N2170	VB [BT]	S
1.2 Twinport	07/04-12/09	Z 12 XEP	1229		0-N2170	VB [BT]	S
1.3 CDTI	06/03-12/09	Z 13 DT	1248		0-N1526	VB [BT]	S
1.4	09/00-12/09	Z 14 XE	1389		0-N1466	VB [BT]	S
1.4 Twinport	06/03-12/09	Z 14 XEP	1364		0-N2170	VB [BT]	S
1.6 CNG	05/03-12/09	Y 16 YNG	1598		0-N1466	VB [BT]	S
1.7 CDTI	06/03-12/09	Z 17 DTH	1686		0-N1798	VB [BT]	S
1.7 CDTI, 1.7 DI, 1.7 DTI	09/00-12/09	Y 17 DT, Y 17 DTL, Z 17 DTH	1686	☼	0-N1426	VB [DG]	
1.7 DI, 1.7 DTI	09/00-12/09	Y 17 DT, Y 17 DTL	1686		0-N1495S	VB [TE]	
1.8	09/00-12/09	Z 18 XE	1796		0-N1466	VB [BT]	S

CORSA C Kasten (F08, W5L)

1.7 CDTI	08/03-	Z 17 DTH	1686	25x131; mit Zubehör	SK-1481	BTK	
----------	--------	----------	------	---------------------	---------	-----	--



CM³



Art. Nr.



ohne Halter

CORSA C Kasten (F08, W5L)

1.7 DI 16V, 1.7 DTI 16V	09/00-	Y 17 DT, Y 17 DTL	1686	25x131; mit Zubehör	SK-1479	BTK	
1.7 DI 16V, 1.7 DTI 16V	09/00-	Y 17 DT, Y 17 DTL	1686	25x131; :328704→; mit Zubehör	SK-1481	BTK	
1.7 DI 16V, 1.7 DTI 16V	09/00-	Y 17 DT, Y 17 DTL	1686	25x131; :→328703	SK-1689	BTK	
1.7 CDTi	08/03-	Z 17 DTH	1686		0-N1085	TB [TE]	
1.7 CDTi, 1.7 DI 16V, 1.7 DTI 16V	09/00-	Y 17 DT, Y 17 DTL, Z 17 DTH	1686		0-N878	TB [DG]	
1.7 DI 16V, 1.7 DTI 16V	09/00-	Y 17 DT, Y 17 DTL	1686	:0328705→	0-N1085	TB [TE]	
1.2	07/05-	Z 12 XEP	1229		0-N2170	VB [BT]	S
1.2 16V	09/00-	Z 12 XE	1199		0-N2170	VB [BT]	S
1.3 CDTI 16V	08/05-	Z 13 DT	1248		0-N1526	VB [BT]	S
1.4	08/03-	Z 14 XEP	1364		0-N2170	VB [BT]	S
1.7 CDTi	08/03-	Z 17 DTH	1686		0-N1798	VB [BT]	S
1.7 CDTi, 1.7 DI 16V, 1.7 DTI 16V	09/00-	Y 17 DT, Y 17 DTL, Z 17 DTH	1686	⚙	0-N1426	VB [DG]	
1.7 DI 16V, 1.7 DTI 16V	09/00-	Y 17 DT, Y 17 DTL	1686		0-N1495S	VB [TE]	

CORSA D

1.6 Turbo	02/07-	A 16 LEL, Z 16 LEL, A 16 LER, B 16 LER, Z 16 LER, A 16 LES, B 16 LES, Z 16 LER	1598	24x146	SK-1607	BTK	
1.7 CDTI	07/06-	A 17 DTS, Z 17 DTR	1686	25x131; mit Zubehör	SK-1481	BTK	
1.6 Turbo	02/07-	A 16 LEL, Z 16 LEL, A 16 LER, B 16 LER, Z 16 LER, A 16 LES, B 16 LES, Z 16 LER	1598		0-N1347	TB [TE]	
1.6 Turbo	02/07-	A 16 LEL, Z 16 LEL, A 16 LER, B 16 LER, Z 16 LER, A 16 LES, B 16 LES, Z 16 LER	1598		0-N1348	TB [DG]	
1.7 CDTI	07/06-	A 17 DTS, Z 17 DTR	1686		0-N1085	TB [TE]	
1.7 CDTI	07/06-	A 17 DTS, Z 17 DTR	1686		0-N878	TB [DG]	
1.0	07/06-	A 10 XEP, Z 10 XEP	998		0-N2170	VB [BT]	S
1.2, 1.2 LPG	07/06-	A 12 XEL, A 12 XER, Z 12 XEP	1229		0-N2170	VB [BT]	S
1.3 CDTI	07/06-	A 13 DTC, Z 13 DTJ, A 13 DTE, A 13 DTR, Z 13 DTE, Z 13 DTH	1248		0-N1526	VB [BT]	S
1.4, 1.4 LPG	07/06-	A 14 NEL, Z 14 XEP	1364		0-N2170	VB [BT]	S
1.4, 1.4 LPG	09/09-	A 14 XEL, A 14 XER	1398		0-N2170	VB [BT]	S
1.6 Turbo	02/07-	A 16 LEL, Z 16 LEL, A 16 LER, B 16 LER, Z 16 LER, A 16 LES, B 16 LES, Z 16 LER	1598		0-N1799	VB [BT]	S
1.7 CDTI	07/06-	Z 17 DTR	1686	⚙	0-N1426	VB [DG]	
1.7 CDTI	07/06-	Z 17 DTR	1686		0-N1798	VB [BT]	S
1.7 CDTI	06/10-	A 17 DTS	1686	⚙	0-N2341	VB [DG]	
1.7 CDTI	06/10-	A 17 DTS	1686		0-N2389	VB [BT]	S

CORSA D Van

1.0	07/06-	A 10 XEP	998		0-N2170	VB [BT]	S
1.2	07/09-	A 12 XEL, A 12 XER, Z 12 XEP	1229		0-N2170	VB [BT]	S
1.3 CDTI	07/06-	A 13 DTC, Z 13 DTJ, A 13 DTE, A 13 DTR, Z 13 DTE, Z 13 DTH	1248		0-N1526	VB [BT]	S

FRONTERA A (5_MWL4)

2.2 i	03/95-10/98	X 22 XE	2198	24x171; ch.→TV899999; → 08/1996	SK-1166	BTK	
2.2 i	03/95-10/98	X 22 XE	2198	24x171; ch.VV600001→; 08/1996 →	SK-1644	BTK	
2.2 i	03/95-10/98	X 22 XE	2198	24x171; ch.VV600001→; 08/1996 →	SK-1644AQ1	BTKW	
2.8 TD	03/95-10/98	28 TDI (4JB1T)	2771	32x119	SK-1260	BTK	
2.2 i	03/95-10/98	X 22 XE	2198	für Fahrzeuge ohne Katalysator	0-N100	TB [TE]	
2.2 i	03/95-10/98	X 22 XE	2198	für Fahrzeuge mit Katalysator	0-N1383	TB [TE]	
2.2 i	03/95-10/98	X 22 XE	2198		0-N906	TB [DG]	
2.8 TD	03/95-10/98	28 TDI (4JB1T)	2771		0-N049	TB [TE]	
2.8 TD	03/95-10/98	28 TDI (4JB1T)	2771		0-N050	TB [DG]	
2.2 i	03/95-10/98	X 22 XE	2198		0-N1422	VB [BT]	S

FRONTERA A Sport (5_SUD2)

2.0 i	03/92-10/98	C 20 NE	1998	20x111; :→14608700	R-1072AQ1	BTKW	
2.0 i	03/92-10/98	X 20 SE	1998	20x146	SK-1169	BTK	
2.0 i	03/92-10/98	C 20 NE	1998	20x146; :14608701→	SK-1169	BTK	
2.0 i	03/92-10/98	X 20 SE	1998	20x146	SK-1169AQ1	BTKW	
2.0 i	03/92-10/98	C 20 NE	1998	20x146; :14608701→	SK-1169AQ1	BTKW	
2.8 TD	03/95-08/96	28 TDI (4JB1T)	2771	32x119	SK-1260	BTK	
2.0 i	03/92-10/98	X 20 SE	1998		0-N101	TB [TE]	
2.0 i	03/92-10/98	C 20 NE	1998	:14608701→	0-N101	TB [TE]	
2.8 TD	03/95-08/96	28 TDI (4JB1T)	2771		0-N049	TB [TE]	
2.8 TD	03/95-08/96	28 TDI (4JB1T)	2771		0-N050	TB [DG]	
2.0 i	03/92-10/98	C 20 NE, X 20 SE	1998		0-N1422	VB [BT]	S

FRONTERA B (6B_)

2.2 i	10/98-	X 22 SE, Y 22 SE	2198	24x171; Baumuster: 6B_	SK-1644	BTK	
-------	--------	------------------	------	------------------------	---------	-----	--

CM³

Art. Nr.

**FRONTERA B (6B_)**

2.2 i	10/98-	X 22 SE, Y 22 SE	2198	24x171	SK-1644AQ1	BTKW	
2.2 i	10/98-	X 22 SE, Y 22 SE	2198		0-N1383	TB [TE]	
2.2 i	10/98-	X 22 SE, Y 22 SE	2198		0-N906	TB [DG]	
3.2 i	10/98-	6 VD1	3165		0-N1765	TB [BT]	S
2.2 DTI	10/98-09/02	X 22 DTH, Y 22 DTH, Y 22 DTH	2171		0-N1485	VB [BT]	S
2.2 DTI	10/98-09/02	X 22 DTH, Y 22 DTH, Y 22 DTH	2171		0-N2169	VB [VD]	
2.2 i	10/98-	X 22 SE, Y 22 SE	2198		0-N1422	VB [BT]	S

GT Cabriolet

2.0	06/07-	LNF, Z 20 NHH	1998		0-N1588	VB [BT]	S
-----	--------	---------------	------	--	---------	---------	---

INSIGNIA

1.6, 1.6 Turbo	07/08-	A 16 LET, A 16 XER	1598	24x146	SK-1607	BTK	
1.8	07/08-	A 18 XER	1796	24x146	SK-1607	BTK	
2.0 CDTI, 2.0 CDTI 4x4	07/08-	A 20 DT, A 20 DTJ, A 20 DTC, A 20 DTL, A 20 DTE, A 20 DTH	1956	24x199	SK-1586	BTK	
2.0 CDTI, 2.0 CDTI 4x4	07/08-	A 20 DT, A 20 DTJ, A 20 DTC, A 20 DTL, A 20 DTE, A 20 DTH	1956	24x199	SK-1586AQ1	BTKW	
1.6, 1.6 Turbo	07/08-	A 16 LET, A 16 XER	1598		0-N1347	TB [TE]	
1.6, 1.6 Turbo	07/08-	A 16 LET, A 16 XER	1598		0-N1348	TB [DG]	
1.8	07/08-	A 18 XER	1796		0-N1347	TB [TE]	
1.8	07/08-	A 18 XER	1796		0-N1348	TB [DG]	
2.0 Biturbo CDTI 4x4	05/09-	A 20 DTR	1956		0-N115	TB [TE]	
2.0 Biturbo CDTI, 2.0 Biturbo CDTI 4x4	07/08-	A 20 DTR	1956		0-N2236	TB [DG]	
2.0 Biturbo CDTI, 2.0 Biturbo CDTI 4x4, 2.0 CDTI, 2.0 CDTI 4x4	07/08-	A 20 DT, A 20 DTJ, A 20 DTC, A 20 DTL, A 20 DTE, A 20 DTH, A 20 DTR	1956		0-N2149	TB [DG]	
2.0 CDTI	07/08-	A 20 DTC	1956		0-N115	TB [TE]	
2.0 CDTI	07/08-	A 20 DTJ	1956		0-N115	TB [TE]	
2.0 CDTI, 2.0 CDTI 4x4	07/08-	A 20 DTH	1956		0-N115	TB [TE]	
1.4, 1.4 LPG	04/11-	A 14 NET, A 14 NET, B 14 NET	1364		0-N2170	VB [BT]	S
1.6, 1.6 Turbo	07/08-	A 16 LET, A 16 XER	1598		0-N1799	VB [BT]	S
1.8	07/08-	A 18 XER	1796		0-N1799	VB [BT]	S
2.0 Biturbo CDTI, 2.0 Biturbo CDTI 4x4, 2.0 CDTI, 2.0 CDTI 4x4	07/08-	A 20 DT, A 20 DTJ, A 20 DTC, A 20 DTL, A 20 DTH, A 20 DTR	1956		0-N1649	VB [DG]	
2.0 Biturbo CDTI, 2.0 Biturbo CDTI 4x4, 2.0 CDTI, 2.0 CDTI 4x4	07/08-	A 20 DT, A 20 DTJ, A 20 DTC, A 20 DTL, A 20 DTH, A 20 DTR	1956		0-N2087	VB [BT]	S
2.0 Biturbo CDTI, 2.0 Biturbo CDTI 4x4, 2.0 CDTI, 2.0 CDTI 4x4	07/08-	A 20 DT, A 20 DTJ, A 20 DTC, A 20 DTL, A 20 DTH, A 20 DTR	1956		0-N2221	VB [DG]	
2.0 Biturbo CDTI, 2.0 Biturbo CDTI 4x4, 2.0 CDTI, 2.0 CDTI 4x4	07/08-	A 20 DT, A 20 DTJ, A 20 DTC, A 20 DTL, A 20 DTE, A 20 DTH, A 20 DTR	1956	für Fahrzeuge mit elektrischer Servolenkung	0-N2254	VB [DG]	
2.0 CDTI, 2.0 CDTI 4x4	07/08-	A 20 DTE, A 20 DTH	1956	✗	0-N1649	VB [DG]	
2.0 E85 Turbo, 2.0 Turbo, 2.0 Turbo 4x4	07/08-	A 20 NFT, A 20 NHT	1998		0-N2283	VB [DG]	
2.0 E85 Turbo, 2.0 Turbo, 2.0 Turbo 4x4	07/08-	A 20 NFT, A 20 NHT	1998		0-N2299	VB [BT]	S
2.8 V6 Turbo 4x4, 2.8 V6 Turbo OPC 4x4	07/08-	A 28 NER, A 28 NET	2792		0-N2194	VB [BT]	S
2.8 V6 Turbo 4x4, 2.8 V6 Turbo OPC 4x4	07/08-	A 28 NER, A 28 NET	2792		0-N2340	VB [DG]	

INSIGNIA Caravan

1.6, 1.6 Turbo	07/08-	A 16 LET, A 16 XER	1598	24x146	SK-1607	BTK	
1.8	07/08-	A 18 XER	1796	24x146	SK-1607	BTK	
2.0 CDTI, 2.0 CDTI 4x4	07/08-	A 20 DT, A 20 DTJ, A 20 DTC, A 20 DTL, A 20 DTE, A 20 DTH	1956	24x199	SK-1586	BTK	
2.0 CDTI, 2.0 CDTI 4x4	07/08-	A 20 DT, A 20 DTJ, A 20 DTC, A 20 DTL, A 20 DTE, A 20 DTH	1956	24x199	SK-1586AQ1	BTKW	
1.6, 1.6 Turbo	07/08-	A 16 LET, A 16 XER	1598		0-N1347	TB [TE]	
1.6, 1.6 Turbo	07/08-	A 16 LET, A 16 XER	1598		0-N1348	TB [DG]	
1.8	07/08-	A 18 XER	1796		0-N1347	TB [TE]	
1.8	07/08-	A 18 XER	1796		0-N1348	TB [DG]	
2.0 Biturbo CDTI 4x4	07/08-	A 20 DTR	1956		0-N115	TB [TE]	
2.0 Biturbo CDTI, 2.0 Biturbo CDTI 4x4	07/08-	A 20 DTR	1956		0-N2236	TB [DG]	
2.0 Biturbo CDTI, 2.0 Biturbo CDTI 4x4, 2.0 CDTI, 2.0 CDTI 4x4	07/08-	A 20 DT, A 20 DTJ, A 20 DTC, A 20 DTL, A 20 DTE, A 20 DTH, A 20 DTR	1956		0-N2149	TB [DG]	
2.0 CDTI	07/08-	A 20 DTC	1956		0-N115	TB [TE]	
2.0 CDTI	07/08-	A 20 DTJ	1956		0-N115	TB [TE]	
2.0 CDTI, 2.0 CDTI 4x4	07/08-	A 20 DTH	1956		0-N115	TB [TE]	
1.4, 1.4 LPG	09/11-	A 14 NET	1364		0-N2170	VB [BT]	S
1.6, 1.6 Turbo	07/08-	A 16 LET, A 16 XER	1598		0-N1799	VB [BT]	S
1.8	07/08-	A 18 XER	1796		0-N1799	VB [BT]	S
2.0 Biturbo CDTI, 2.0 Biturbo CDTI 4x4, 2.0 CDTI, 2.0 CDTI 4x4	07/08-	A 20 DT, A 20 DTJ, A 20 DTC, A 20 DTL, A 20 DTH, A 20 DTR	1956		0-N1649	VB [DG]	



CM³



Art. Nr.



ohne Halter

INSIGNIA Caravan								
2.0 Biturbo CDTI, 2.0 Biturbo CDTI 4x4, 2.0 CDTI, 2.0 CDTI 4x4	07/08-	A 20 DT, A 20 DTJ, A 20 DTC, A 20 DTL, A 20 DTH, A 20 DTR	1956			0-N2087	VB [BT]	S
2.0 Biturbo CDTI, 2.0 Biturbo CDTI 4x4, 2.0 CDTI, 2.0 CDTI 4x4	07/08-	A 20 DT, A 20 DTJ, A 20 DTC, A 20 DTL, A 20 DTH, A 20 DTR	1956			0-N2221	VB [DG]	
2.0 Biturbo CDTI, 2.0 Biturbo CDTI 4x4, 2.0 CDTI, 2.0 CDTI 4x4	07/08-	A 20 DT, A 20 DTJ, A 20 DTC, A 20 DTL, A 20 DTE, A 20 DTH, A 20 DTR	1956	für Fahrzeuge mit elektrischer Servolenkung		0-N2254	VB [DG]	
2.0 CDTI, 2.0 CDTI 4x4	03/12-	A 20 DTE, A 20 DTH	1956			0-N1649	VB [DG]	
2.0 E85 Turbo, 2.0 Turbo, 2.0 Turbo 4x4	07/08-	A 20 NFT, A 20 NFT, A 20 NHT, A 20 NHT	1998			0-N2283	VB [DG]	
2.0 E85 Turbo, 2.0 Turbo, 2.0 Turbo 4x4	07/08-	A 20 NFT, A 20 NFT, A 20 NHT, A 20 NHT	1998			0-N2299	VB [BT]	S
2.8 V6 Turbo 4x4, 2.8 V6 Turbo OPC 4x4	10/08-	A 28 NER, A 28 NET	2792			0-N2194	VB [BT]	S
2.8 V6 Turbo 4x4, 2.8 V6 Turbo OPC 4x4	10/08-	A 28 NER, A 28 NET	2792			0-N2340	VB [DG]	

INSIGNIA Stufenheck								
1.6, 1.6 Turbo	07/08-	A 16 LET, A 16 XER	1598	24x146		SK-1607	BTK	
1.8	07/08-	A 18 XER	1796	24x146		SK-1607	BTK	
2.0 CDTI, 2.0 CDTI 4x4	07/08-	A 20 DT, A 20 DTJ, A 20 DTC, A 20 DTL, A 20 DTE, A 20 DTH	1956	24x199		SK-1586	BTK	
2.0 CDTI, 2.0 CDTI 4x4	07/08-	A 20 DT, A 20 DTJ, A 20 DTC, A 20 DTL, A 20 DTE, A 20 DTH	1956	24x199		SK-1586AQ1	BTKW	
1.6, 1.6 Turbo	07/08-	A 16 LET, A 16 XER	1598			0-N1347	TB [TE]	
1.6, 1.6 Turbo	07/08-	A 16 LET, A 16 XER	1598			0-N1348	TB [DG]	
1.8	07/08-	A 18 XER	1796			0-N1347	TB [TE]	
1.8	07/08-	A 18 XER	1796			0-N1348	TB [DG]	
2.0 Biturbo CDTI 4x4	07/08-	A 20 DTR	1956			0-N115	TB [TE]	
2.0 Biturbo CDTI, 2.0 Biturbo CDTI 4x4	07/08-	A 20 DTR	1956			0-N2236	TB [DG]	
2.0 Biturbo CDTI, 2.0 Biturbo CDTI 4x4, 2.0 CDTI, 2.0 CDTI 4x4	07/08-	A 20 DT, A 20 DTJ, A 20 DTC, A 20 DTL, A 20 DTE, A 20 DTH, A 20 DTR	1956			0-N2149	TB [DG]	
2.0 CDTI	07/08-	A 20 DTC	1956			0-N115	TB [TE]	
2.0 CDTI	07/08-	A 20 DTJ	1956			0-N115	TB [TE]	
2.0 CDTI, 2.0 CDTI 4x4	07/08-	A 20 DTH	1956			0-N115	TB [TE]	
1.4, 1.4 LPG	04/11-	A 14 NET, A 14 NET, B 14 NET	1364			0-N2170	VB [BT]	S
1.6, 1.6 Turbo	07/08-	A 16 LET, A 16 XER	1598			0-N1799	VB [BT]	S
1.8	07/08-	A 18 XER	1796			0-N1799	VB [BT]	S
2.0 Biturbo CDTI, 2.0 Biturbo CDTI 4x4, 2.0 CDTI, 2.0 CDTI 4x4	07/08-	A 20 DT, A 20 DTJ, A 20 DTC, A 20 DTL, A 20 DTH, A 20 DTR	1956			0-N1649	VB [DG]	
2.0 Biturbo CDTI, 2.0 Biturbo CDTI 4x4, 2.0 CDTI, 2.0 CDTI 4x4	07/08-	A 20 DT, A 20 DTJ, A 20 DTC, A 20 DTL, A 20 DTH, A 20 DTR	1956			0-N2087	VB [BT]	S
2.0 Biturbo CDTI, 2.0 Biturbo CDTI 4x4, 2.0 CDTI, 2.0 CDTI 4x4	07/08-	A 20 DT, A 20 DTJ, A 20 DTC, A 20 DTL, A 20 DTH, A 20 DTR	1956			0-N2221	VB [DG]	
2.0 Biturbo CDTI, 2.0 Biturbo CDTI 4x4, 2.0 CDTI, 2.0 CDTI 4x4	07/08-	A 20 DT, A 20 DTJ, A 20 DTC, A 20 DTL, A 20 DTE, A 20 DTH, A 20 DTR	1956	für Fahrzeuge mit elektrischer Servolenkung		0-N2254	VB [DG]	
2.0 CDTI, 2.0 CDTI 4x4	03/12-	A 20 DTE, A 20 DTH	1956			0-N1649	VB [DG]	
2.0 Turbo, 2.0 Turbo 4x4, 2.0 Turbo E85	07/08-	A 20 NFT, A 20 NFT, A 20 NHT, A 20 NHT	1998			0-N2283	VB [DG]	
2.0 Turbo, 2.0 Turbo 4x4, 2.0 Turbo E85	07/08-	A 20 NFT, A 20 NFT, A 20 NHT, A 20 NHT	1998			0-N2299	VB [BT]	S
2.8 V6 Turbo 4x4, 2.8 V6 Turbo OPC 4x4	07/08-	A 28 NER, A 28 NET	2792			0-N2194	VB [BT]	S
2.8 V6 Turbo 4x4, 2.8 V6 Turbo OPC 4x4	07/08-	A 28 NER, A 28 NET	2792			0-N2340	VB [DG]	

KADETT D (31_ -34_ , 41_ -44_)								
1.6 D	03/82-08/84	16 D	1598	24x147		SK-1056	BTK	

KADETT D (32_ ,37_ ,39_ , 42)								
1.6 D	03/82-08/84	16 D	1598	24x147		SK-1056	BTK	

KADETT D Caravan (35_ , 36_ , 45_ , 46_)								
1.6 D	03/82-08/84	16 D	1598	24x147		SK-1056	BTK	

KADETT E (39_ , 49_)								
1.4 i	01/90-08/91	C 14 NZ	1389	17x111; :19311738→; mit Zubehör		SK-1162	BTK	
1.4 i	01/90-08/91	C 14 NZ	1389	17x111; :19311738→; mit Zubehör		SK-1162AQ1	BTKW	
1.4 S	01/90-08/91	14 NV	1389	17x111; :02J22350, 19307806→; mit Zubehör		SK-1162	BTK	
1.4 S	01/90-08/91	14 NV	1389	17x111; :02J22350, 19307806→; mit Zubehör		SK-1162AQ1	BTKW	
1.5 TD	07/88-08/91	15 DT (T4EC1)	1488	25x136; mit Zubehör		SK-1054	BTK	
1.6 D	09/84-01/89	16 D, 16 DA	1598	24x146; :14498631→;		SK-1037	BTK	
1.6 D	09/84-01/89	16DA	1598	24x146; :14498631→;		SK-1037AQ1	BTKW	
1.6 D	09/84-01/89	16DA	1598	24x146; :14503757→;		SK-1037AQ1	BTKW	
1.6 D	09/84-01/89	16 D, 16 DA	1598	24x147		SK-1056	BTK	
1.6, 1.6 i, 1.6 i KAT, 1.6 S	09/86-08/91	16 SV, C 16 LZ, C 16 NZ, E 16 NZ, E 16 SE	1598	17x111; :02J22350→; mit Zubehör		SK-1162	BTK	
1.6, 1.6 i, 1.6 i KAT, 1.6 S	09/86-08/91	16 SV, C 16 LZ, C 16 NZ, E 16 NZ, E 16 SE	1598	17x111; :02J22350→; mit Zubehör		SK-1162AQ1	BTKW	
1.7 D	02/89-08/91	17 D	1700	24x146		SK-1037	BTK	
1.7 D	02/89-08/91	17 D	1700	24x146; :→14333430		SK-1037AQ1	BTKW	



CM³



Art. Nr.



ohne Halter

KADETT E (39_, 49_)

1.7 D	02/89-08/91	17 D	1700	24x176; 09/1989 →; :14363651→	SK-1038	BTK
1.7 D	02/89-08/91	17 D	1700	24x176; :14363652→	SK-1038AQ1	BTKW
1.8 i	10/85-08/86	C 18 NE	1796	20x111; →14254438	R-1072AQ1	BTKW
1.8 i	09/90-08/91	C 18 NZ	1796	20x111; →14254438	R-1072AQ1	BTKW
1.8 S	09/87-08/91	E 18 NV	1798	20x111; →14254438	R-1072AQ1	BTKW
1.8, 1.8 i	09/84-08/90	18 E, 18 E, 18 SE	1796	20x111; :14056061→; →14270600	R-1072AQ1	BTKW
2.0 i, 2.0 i KAT	03/87-08/91	20 NE, 20 SE, C 20 NE	1998	20x111; 09/1987 →; →14608700	R-1072AQ1	BTKW
1.5 TD	07/88-08/91	15 DT (T4EC1)	1488		0-N878	TB [DG]
1.5 TD	07/88-08/91	15 DT (T4EC1)	1488		0-N879	TB [TE]
1.6 D	09/84-01/89	16 D, 16 DA	1598	:14478631, 14503757→	0-N875	TB [DG]
1.7 D	02/89-08/91	17 D	1700		0-N875	TB [DG]
1.8 i	09/90-08/91	C 18 NZ	1796	:14254439→	0-N101	TB [TE]
1.8 S	09/87-08/91	E 18 NV	1798	:14254439→	0-N101	TB [TE]
1.8, 1.8 i	09/84-08/90	18 E, 18 E, 18 SE	1796	:14270601→	0-N101	TB [TE]
2.0 i, 2.0 i KAT	03/87-08/91	20 NE, 20 SE, C 20 NE	1998	:14608701→	0-N101	TB [TE]
1.4 i	01/90-08/91	C 14 NZ	1389	:02J22350, 19311739→	0-N948	TB [TE]
1.4 S	01/90-08/91	14 NV	1389	:02J22350, 19307806→	0-N948	TB [TE]
1.6 i, 1.6 i KAT, 1.6 S	09/86-08/91	16 SV, C 16 LZ, C 16 NZ, E 16 NZ	1598	:02J22350→	0-N948	TB [TE]

KADETT E Cabriolet (43B_)

1.4 i	01/90-08/91	C 14 NZ	1389	17x111; :19311738→; mit Zubehör	SK-1162	BTK
1.4 i	01/90-08/91	C 14 NZ	1389	17x111; :19311738→; mit Zubehör	SK-1162AQ1	BTKW
1.4 S	08/90-02/93	14 NV	1389	17x111; :02J22350, 19307806→; mit Zubehör	SK-1162	BTK
1.4 S	08/90-02/93	14 NV	1389	17x111; :02J22350, 19307806→; mit Zubehör	SK-1162AQ1	BTKW
1.6 i	07/89-02/93	16 SV	1598	17x111; :02J22350→; mit Zubehör	SK-1162AQ1	BTKW
1.6 i, 1.6 i KAT	10/86-02/93	16 SV, C 16 LZ, C 16 NZ, E 16 NZ	1598	17x111; :02J22350→; mit Zubehör	SK-1162	BTK
1.6 i, 1.6 i KAT	10/86-02/93	C 16 LZ, C 16 NZ, E 16 NZ	1598	17x111; 09/1988 →; :02J22350→; mit Zubehör	SK-1162AQ1	BTKW
2.0	09/90-05/92	C 20 XE	1998	24x141; →14142838	SK-1163	BTK
2.0	09/90-05/92	C 20 XE	1998	24x176; :14142839→	SK-1165	BTK
2.0 GSi, 2.0 i, 2.0 i KAT	10/86-02/93	20 NE, 20 SER, C 20 NE	1998	20x111; →14608700	R-1072AQ1	BTKW
2.0	09/90-05/92	C 20 XE	1998	:14142839→	0-N100	TB [TE]
2.0	09/90-05/92	C 20 XE	1998	→14142838	0-N876	TB [DG]
2.0	09/90-05/92	C 20 XE	1998	→14142838	0-N877	TB [TE]
2.0	09/90-05/92	C 20 XE	1998	:14142839→	0-N906	TB [DG]
2.0	09/90-05/92	C 20 XE	1998	:14142839→	0-N907	TB [DG]
2.0 GSi, 2.0 i, 2.0 i KAT	10/86-02/93	20 NE, 20 SER, C 20 NE	1998	:14608701→	0-N101	TB [TE]
1.4 i	01/90-08/91	C 14 NZ	1389	:02J22350, 19311759→	0-N948	TB [TE]
1.4 S	08/90-02/93	14 NV	1389	:02J22350, 19307806→	0-N948	TB [TE]
1.6 i, 1.6 i KAT	10/86-02/93	16 SV, C 16 LZ, C 16 NZ, E 16 NZ	1598	:02J22350→	0-N948	TB [TE]

KADETT E Caravan (35_, 36_, 45_, 46_)

1.4 i	01/90-08/91	C 14 NZ	1389	17x111; :19311738→; mit Zubehör	SK-1162	BTK
1.4 i	01/90-08/91	C 14 NZ	1389	17x111; :19311738→; mit Zubehör	SK-1162AQ1	BTKW
1.4 S	01/90-08/91	14 NV	1389	17x111; :02J22350, 19307806→; mit Zubehör	SK-1162	BTK
1.4 S	01/90-08/91	14 NV	1389	17x111; :02J22350, 19307806→; mit Zubehör	SK-1162AQ1	BTKW
1.5 TD	07/88-08/91	15 DT (T4EC1)	1488	25x136; mit Zubehör	SK-1054	BTK
1.6 D	09/84-01/89	16 D, 16 DA	1598	24x146; :14498631→;	SK-1037	BTK
1.6 D	09/84-01/89	16DA	1598	24x146; :14498631→;	SK-1037AQ1	BTKW
1.6 D	09/84-01/89	16DA	1598	24x146; :14503757→;	SK-1037AQ1	BTKW
1.6 D	09/84-01/89	16 D, 16 DA	1598	24x147	SK-1056	BTK
1.6, 1.6 i, 1.6 i KAT	09/86-08/91	16 SV, C 16 LZ, C 16 NZ, E 16 NZ	1598	17x111; :02J22350→; mit Zubehör	SK-1162	BTK
1.6, 1.6 i, 1.6 i KAT	09/86-08/91	16 SV, C 16 LZ, C 16 NZ, E 16 NZ	1598	17x111; :02J22350→; mit Zubehör	SK-1162AQ1	BTKW
1.7 D	02/89-08/91	17 D	1700	24x146	SK-1037	BTK
1.7 D	02/89-08/91	17 D	1700	24x146; →14363650	SK-1037AQ1	BTKW
1.7 D	02/89-08/91	17 D	1700	24x176; 09/1989 →; :14363651→	SK-1038	BTK
1.7 D	02/89-08/91	17 D	1700	24x176; :14363652→	SK-1038AQ1	BTKW
1.8 E, 1.8 S	10/85-08/91	C 18 NE, E 18 NV	1796	20x111; →14254438	R-1072AQ1	BTKW
1.8 i	09/84-08/86	18 E	1796	20x111; :14056061→; →14270600	R-1072AQ1	BTKW
1.8 i	06/85-08/91	C 18 NZ	1796	20x111; →14254438	R-1072AQ1	BTKW
2.0 i, 2.0 i KAT	09/87-08/91	20 NE, C 20 NE	1998	20x111; →14608700	R-1072AQ1	BTKW
1.5 TD	07/88-08/91	15 DT (T4EC1)	1488		0-N878	TB [DG]
1.5 TD	07/88-08/91	15 DT (T4EC1)	1488		0-N879	TB [TE]
1.6 D	09/84-01/89	16 D, 16 DA	1598	:14478631, 14503757→	0-N875	TB [DG]



CM³



Art. Nr.



ohne Halter

KADETT E Caravan (35_, 36_, 45_, 46_)							
1.7 D	02/89-08/91	17 D	1700			0-N875	TB [DG]
1.8 i	09/84-08/86	18 E	1796	:14270601→		0-N101	TB [TE]
1.8 i	06/85-08/91	C 18 NZ	1796	:14142839→		0-N101	TB [TE]
1.8 S	09/87-08/91	E 18 NV	1796	:14254439→		0-N101	TB [TE]
2.0 i, 2.0 i KAT	09/87-08/91	20 NE, C 20 NE	1998	:14608701→		0-N101	TB [TE]
1.4 i	01/90-08/91	C 14 NZ	1389	:02J22350, 19311759→		0-N948	TB [TE]
1.4 S	01/90-08/91	14 NV	1389	:02J22350, 19307806→		0-N948	TB [TE]
1.6, 1.6 i, 1.6 i KAT	09/86-08/91	16 SV, C 16 LZ, C 16 NZ, E 16 NZ	1598	:02J22350→		0-N948	TB [TE]

KADETT E CC (33_, 34_, 43_, 44_)							
1.4 i, 1.4 S	09/89-08/91	C 14 NZ, C 14 SE	1389	17x111; :19311738→; mit Zubehör		SK-1162	BTK
1.4 i, 1.4 S	09/89-08/91	C 14 NZ, C 14 SE	1389	17x111; :19311738→; mit Zubehör		SK-1162AQ1	BTKW
1.4 S	01/90-08/91	14 NV	1389	17x111; :02J22350, 19307806→; mit Zubehör		SK-1162	BTK
1.4 S	01/90-08/91	14 NV	1389	17x111; :02J22350, 19307806→; mit Zubehör		SK-1162AQ1	BTKW
1.5 TD	07/88-08/91	15 DT (T4EC1)	1488	25x136; mit Zubehör		SK-1054	BTK
1.6 D	09/84-01/89	16 D, 16 DA	1598	24x146; :14498631→;		SK-1037	BTK
1.6 D	09/84-01/89	16DA	1598	24x146; :14498631→;		SK-1037AQ1	BTKW
1.6 D	09/84-01/89	16DA	1598	24x146; :14503757→;		SK-1037AQ1	BTKW
1.6 D	09/84-01/89	16 D, 16 DA	1598	24x147		SK-1056	BTK
1.6 i, 1.6 i KAT, 1.6 S	09/86-08/91	16 SV, C 16 LZ, C 16 NZ, E 16 NZ	1598	17x111; :02J22350→; mit Zubehör		SK-1162	BTK
1.6 i, 1.6 i KAT, 1.6 S	09/86-08/91	16 SV, C 16 LZ, C 16 NZ, E 16 NZ	1598	17x111; :02J22350→; mit Zubehör		SK-1162AQ1	BTKW
1.7 D	02/89-08/91	17 D	1700	24x146		SK-1037	BTK
1.7 D	02/89-08/91	17 D	1700	24x146; →14333430		SK-1037AQ1	BTKW
1.7 D	02/89-08/91	17 D	1700	24x176; 09/1989 →; :14363651→		SK-1038	BTK
1.7 D	02/89-08/91	17 D	1700	24x176; :14363652→		SK-1038AQ1	BTKW
1.8 E, 1.8 S	10/85-08/91	C 18 NE, E 18 NV, S 18 NV	1796	20x111; →14254438		R-1072AQ1	BTKW
1.8 GSI	09/84-08/86	18 E	1796	20x111; :14056061→; →14270600		R-1072AQ1	BTKW
1.8 i	06/85-08/91	C 18 NZ	1796	20x111; →14254438		R-1072AQ1	BTKW
2.0 GSI 16V, 2.0 GSI 16V KAT	12/87-08/91	20 XE, 20 XEJ, C 20 XE	1998	24x141		SK-1163	BTK
2.0 GSI 16V, 2.0 GSI 16V KAT	12/87-08/91	20 XE, 20 XEJ, C 20 XE	1998	24x176; :14142839→		SK-1165	BTK
2.0 GSI, 2.0 GSI KAT	09/86-08/91	20 NE, 20 SEH, C 20 NE	1998	20x111; →14608700		R-1072AQ1	BTKW
1.5 TD	07/88-08/91	15 DT (T4EC1)	1488			0-N878	TB [DG]
1.5 TD	07/88-08/91	15 DT (T4EC1)	1488			0-N879	TB [TE]
1.6 D	09/84-01/89	16 D, 16 DA	1598	:14478631, 14503757→		0-N875	TB [DG]
1.7 D	02/89-08/91	17 D	1700			0-N875	TB [DG]
1.8 GSI	09/84-08/86	18 E	1796	:14270601→		0-N101	TB [TE]
1.8 i	06/85-08/91	C 18 NZ, S 18 NV	1796	:14142839→		0-N101	TB [TE]
1.8 S	09/87-08/91	E 18 NV, S 18 NV	1796	:14254439→		0-N101	TB [TE]
2.0 GSI 16V, 2.0 GSI 16V KAT	12/87-08/91	20 XE, 20 XEJ, C 20 XE	1998	:14142839→		0-N100	TB [TE]
2.0 GSI 16V, 2.0 GSI 16V KAT	12/87-08/91	20 XE, 20 XEJ, C 20 XE	1998	→14142838		0-N876	TB [DG]
2.0 GSI 16V, 2.0 GSI 16V KAT	12/87-08/91	20 XE, 20 XEJ, C 20 XE	1998	→14142838		0-N877	TB [TE]
2.0 GSI 16V, 2.0 GSI 16V KAT	12/87-08/91	20 XE, 20 XEJ, C 20 XE	1998	:14142839→		0-N906	TB [DG]
2.0 GSI 16V, 2.0 GSI 16V KAT	12/87-08/91	20 XE, 20 XEJ, C 20 XE	1998	:14142839→		0-N907	TB [DG]
2.0 GSI, 2.0 GSI KAT	09/86-08/91	20 NE, 20 SEH, C 20 NE	1998	:14608701→		0-N101	TB [TE]
1.4 i	01/90-08/91	C 14 NZ	1389	:19311739→		0-N948	TB [TE]
1.4 S	09/89-08/91	C 14 SE	1389			0-N948	TB [TE]
1.4 S	01/90-08/91	14 NV	1389	:02J22350, 19307806→		0-N948	TB [TE]
1.6 i, 1.6 i KAT, 1.6 S	09/86-08/91	16 SV, C 16 LZ, C 16 NZ, E 16 NZ	1598	:02J22350→		0-N948	TB [TE]

KADETT E Combo (38_, 48_)							
1.4 i	08/91-07/94	C 14 NZ	1389	17x111; :19307806→; mit Zubehör		SK-1162	BTK
1.4 i	08/91-07/94	C 14 NZ	1389	17x111; :19311738→; mit Zubehör		SK-1162AQ1	BTKW
1.4 S	07/89-08/91	14 NV	1389	17x111; :02J22350, 19307806→; mit Zubehör		SK-1162	BTK
1.4 S	07/89-08/91	14 NV	1389	17x111; :02J22350, 19307806→; mit Zubehör		SK-1162AQ1	BTKW
1.6 D	01/86-12/89	16 DA	1598	24x146; :14498631→;		SK-1037	BTK
1.6 D	01/86-12/89	16 DA	1598	24x146; :14503757→;		SK-1037	BTK
1.6 D	01/86-12/89	16 DA	1598	24x146; :14498631→;		SK-1037AQ1	BTKW
1.6 D	01/86-12/89	16 DA	1598	24x146; :14503757→;		SK-1037AQ1	BTKW
1.6 D	01/86-12/89	16 DA	1598	24x147		SK-1056	BTK
1.6, 1.6 i	09/86-07/94	16 SV, C 16 NZ	1598	17x111; :02J22350→; mit Zubehör		SK-1162	BTK
1.6, 1.6 i	09/86-07/94	16 SV, C 16 NZ	1598	17x111; :02J22350→; mit Zubehör		SK-1162AQ1	BTKW
1.7 D	01/89-07/94	17 D, 17 DR	1700	24x146		SK-1037	BTK
1.7 D	01/89-07/94	17 D, 17 DR	1700	24x146; →14363650		SK-1037AQ1	BTKW



CM³



Art. Nr.



KADETT E Combo (38_, 48_)

1.7 D	01/89-07/94	17 D, 17 DR	1700	24x176; :14363651→	SK-1038	BTK	
1.7 D	01/89-07/94	17 D, 17 DR	1700	24x176; :14363652→	SK-1038AQ1	BTKW	
1.6 D	01/86-12/89	16 DA	1598	:14478631, 14503757→	0-N875	TB [DG]	
1.7 D	01/89-07/94	17 D	1700		0-N875	TB [DG]	
1.7 D	07/92-07/94	17 DR	1700		0-N100	TB [TE]	
1.7 D	07/92-07/94	17 DR	1700		0-N909	TB [DG]	
1.4 i	08/91-07/94	C 14 NZ	1389	:02J22350, 19311759→	0-N948	TB [TE]	
1.4 S	07/89-08/91	14 NV	1389	:02J22350, 19307806→	0-N948	TB [TE]	
1.6, 1.6 i	09/86-07/94	16 SV, C 16 NZ	1598	:02J22350→	0-N948	TB [TE]	

KADETT E Kasten (37_, 47_)

1.4 i	01/90-08/91	C 14 NZ	1389	17x111; :19311739→; mit Zubehör	SK-1162	BTK	
1.4 i	01/90-08/91	C 14 NZ	1389	17x111; :02J22350, 19311738→; mit Zubehör	SK-1162AQ1	BTKW	
1.6 D	08/84-08/88	16 D, 16 DA	1598	24x146; :14498631→;	SK-1037	BTK	
1.6 D	08/84-08/88	16 D, 16 DA	1598	24x146; :14503757→;	SK-1037	BTK	
1.6 D	08/84-08/88	16DA	1598	24x146; :14498631→;	SK-1037AQ1	BTKW	
1.6 D	08/84-08/88	16DA	1598	24x146; :14503757→;	SK-1037AQ1	BTKW	
1.6 D	08/84-08/88	16 D, 16 DA	1598	24x147	SK-1056	BTK	
1.6 i	08/89-09/93	C 16 NZ	1598	17x111; :02J22350→; mit Zubehör	SK-1162	BTK	
1.6 i	08/89-09/93	C 16 NZ	1598	17x111; :02J22350→; mit Zubehör	SK-1162AQ1	BTKW	
1.7 D	08/88-09/92	17 D	1700	24x146	SK-1037	BTK	
1.7 D	08/88-09/92	17 D	1700	24x146; :→14363650	SK-1037AQ1	BTKW	
1.7 D	08/88-09/92	17 D	1700	24x176; 08/1989 →; :14363651→	SK-1038	BTK	
1.7 D	08/88-09/92	17 D	1700	24x176; :14363652→	SK-1038AQ1	BTKW	
1.8 i	08/84-09/92	C 18 NT	1796	20x111; 08/1988 →; :14056061→; :→14270600	R-1072AQ1	BTKW	
1.6 D	08/84-08/88	16 D, 16 DA	1598	:14478631, 14503757→	0-N875	TB [DG]	
1.7 D	08/88-09/92	17 D	1700		0-N875	TB [DG]	
1.4 i	01/90-08/91	C 14 NZ	1389	:02J22350, 19311759→	0-N948	TB [TE]	
1.6 i	08/89-09/93	C 16 NZ	1598	:02J22350→	0-N948	TB [TE]	

MERIVA

1.6	05/03-05/10	Z 16 SE	1598	17x111; mit Zubehör	SK-1162	BTK	
1.6	05/03-05/10	Z 16 SE	1598	17x111	SK-1162AQ2	BTKW	
1.6 16V	05/03-01/06	Z 16 XE	1598	20x162; mit Zubehör	SK-1355	BTK	
1.6 16V	05/03-01/06	Z 16 XE	1598	20x162; mit Zubehör	SK-1355AQ2	BTKW	
1.6, 1.6 Turbo	09/05-05/10	Z 16 LET, Z 16 XEP	1598	24x146	SK-1607	BTK	
1.7 CDTI	09/03-05/10	Z 17 DTH	1686	25x131; :328704→; mit Zubehör	SK-1481	BTK	
1.7 CDTI, 1.7 DTI	09/03-05/10	Y 17 DT, Y 17 DTL, Z 17 DT, Z 17 DTH	1686	25x131; mit Zubehör	SK-1479	BTK	
1.7 CDTI, 1.7 DTI	09/03-05/10	A 17 DTR, Z 17 DTR, Y 17 DTL	1686	25x131; mit Zubehör	SK-1481	BTK	
1.7 DTI	09/03-05/10	Y 17 DT	1686	25x131; :328704→; mit Zubehör	SK-1481	BTK	
1.7 DTI	09/03-05/10	Y 17 DT, Y 17 DTL	1686	25x131; :→328703	SK-1689	BTK	
1.8	05/03-05/10	Z 18 XE	1796	20x162; mit Zubehör	SK-1355	BTK	
1.8	05/03-05/10	Z 18 XE	1796	20x162; mit Zubehör	SK-1355AQ1	BTKW	
1.6 16V	05/03-01/06	Z 16 XE	1598		0-N102	TB [TE]	
1.6 16V	05/03-01/06	Z 16 XE	1598	†; mit Anbaumaterial	0-N300	TB [DG]	
1.6 16V	05/03-01/06	Z 16 XE	1598		0-N953	TB [DG]	
1.6, 1.6 Turbo	09/05-05/10	Z 16 LET, Z 16 XEP	1598		0-N1347	TB [TE]	
1.6, 1.6 Turbo	09/05-05/10	Z 16 LET, Z 16 XEP	1598		0-N1348	TB [DG]	
1.7 CDTI	09/06-05/10	Z 17 DTR	1686		0-N1085	TB [TE]	
1.7 CDTI, 1.7 DTI	09/03-05/10	Y 17 DT, Y 17 DTL, Z 17 DT, Z 17 DTH	1686		0-N1085	TB [TE]	
1.7 CDTI, 1.7 DTI	09/03-05/10	A 17 DTR, Z 17 DTR, Y 17 DT, Y 17 DTL, Z 17 DT, Z 17 DTH	1686		0-N878	TB [DG]	
1.8	05/03-05/10	Z 18 XE	1796		0-N102	TB [TE]	
1.8	05/03-05/10	Z 18 XE	1796	†; mit Anbaumaterial	0-N300	TB [DG]	
1.8	05/03-05/10	Z 18 XE	1796		0-N953	TB [DG]	
1.3 CDTI	09/03-05/10	Y 13 DT, Z 13 DT, Z 13 DTJ	1248		0-N1526	VB [BT]	S
1.4 16V Twinport, 1.4 16V Twinport LPG	07/04-05/10	Z 14 XEP	1364		0-N2170	VB [BT]	S
1.6	05/03-05/10	Z 16 SE	1598		0-N948	TB [TE]	
1.6, 1.6 16V	05/03-05/10	Z 16 SE, Z 16 XE	1598		0-N1466	VB [BT]	S
1.6, 1.6 Turbo	09/05-05/10	Z 16 LET, Z 16 XEP	1598		0-N1799	VB [BT]	S
1.7 CDTI	09/03-05/10	A 17 DTR, Z 17 DTR, Z 17 DT, Z 17 DTH	1686		0-N1798	VB [BT]	S
1.7 CDTI, 1.7 DTI	09/03-05/10	A 17 DTR, Z 17 DTR, Y 17 DT, Y 17 DTL, Z 17 DT, Z 17 DTH	1686	✳	0-N1426	VB [DG]	
1.7 DTI	09/03-05/10	Y 17 DT, Y 17 DTL	1686		0-N1495S	VB [TE]	
1.8	05/03-05/10	Z 18 XE	1796		0-N1466	VB [BT]	S



CM³



Art. Nr.



ohne Halter

MERIVA B								
1.7 CDTI	06/10-	A 17 DT, A 17 DTC, A 17 DTI, A 17 DTS	1686	25x131; mit Zubehör	SK-1481	BTK		
1.7 CDTI	06/10-	A 17 DT, A 17 DTC, A 17 DTI, A 17 DTS	1686		0-N1085	TB [TE]		
1.7 CDTI	06/10-	A 17 DT, A 17 DTC, A 17 DTI, A 17 DTS	1686		0-N878	TB [DG]		
1.3 CDTI	06/10-	A 13 DTC, A 13 DTE	1248		0-N1526	VB [BT]	S	
1.4	06/10-	A 14 XER, B 14 XER	1398		0-N2170	VB [BT]	S	
1.4, 1.4 LPG	06/10-	A 14 NEL, B 14 NEL, A 14 NET, B 14 NET	1364		0-N2170	VB [BT]	S	
1.6 CDTI	08/13-	B 16 DTC, B 16 DTE, B 16 DTL, B 16 DTN, B 16 DTH	1598	✳	0-N1649	VB [DG]		
1.7 CDTI	06/10-	A 17 DT, A 17 DTC, A 17 DTI, A 17 DTS	1686	✳	0-N2341	VB [DG]		
1.7 CDTI	06/10-	A 17 DT, A 17 DTC, A 17 DTI, A 17 DTS	1686		0-N2389	VB [BT]	S	
MOKKA								
1.6	06/12-	A 16 XER, B 16 XER	1598	24x146	SK-1607	BTK		
1.6	06/12-	A 16 XER, B 16 XER	1598		0-N1347	TB [TE]		
1.6	06/12-	A 16 XER, B 16 XER	1598		0-N1348	TB [DG]		
1.7 CDTI, 1.7 CDTI 4x4	06/12-	A 17 DTS	1686		0-N1085	TB [TE]		
1.7 CDTI, 1.7 CDTI 4x4	06/12-	A 17 DTS	1686		0-N878	TB [DG]		
1.8, 1.8 4x4	01/13-	A 18 XER	1796		0-N1347	TB [TE]		
1.4, 1.4 4x4	06/12-	A 14 NET, B 14 NET	1364		0-N2170	VB [BT]	S	
1.6	06/12-	A 16 XER, B 16 XER	1598		0-N1799	VB [BT]	S	
1.6 CDTI, 1.6 CDTI 4x4	01/15-	B 16 DTH	1598	✳	0-N1649	VB [DG]		
1.7 CDTI, 1.7 CDTI 4x4	06/12-	A 17 DTS	1686	✳	0-N2341	VB [DG]		
1.7 CDTI, 1.7 CDTI 4x4	06/12-	A 17 DTS	1686		0-N2389	VB [BT]	S	
MONTEREY A (UBS_)								
3.1 TD	09/91-07/98	4 JG2TC	3059	32x119	SK-1260	BTK		
3.1 TD	09/91-07/98	4 JG2TC	3059		0-N049	TB [TE]		
3.1 TD	09/91-07/98	4 JG2TC	3059		0-N050	TB [DG]		
3.2	06/92-07/98	6 VD1	3165		0-N1768	TB [BT]		
3.2	06/92-07/98	6 VD1	3165		0-N2167	TB [DG]		
MONTEREY B								
3.0 DTI	07/98-08/99	4 JX1	2999		0-N2168	TB [TE]		
3.5 V6 24V	07/98-08/99	6 VE1	3494		0-N1765	TB [BT]	S	
MOVANO Combi (J9)								
1.9 DTI	09/00-10/01	F9Q 770	1870	26x153; beinhaltete Rollen: 4; mit Zahnrad; mit Zubehör	SK-1490	BTK		
1.9 DTI	09/00-10/01	F9Q 770	1870	26x132	SK-1493	BTK		
1.9 DTI	09/00-10/01	F9Q 770, F9Q 772, F9Q 774	1870	26x132	SK-1493AQ1	BTKW		
1.9 DTI	09/00-10/01	F9Q 770, F9Q 772, F9Q 774	1870	26x132	SK-1493AQ2	BTKW		
1.9 DTI	09/00-10/01	F9Q 770	1870	26x153; beinhaltete Rollen: 2	SK-1620	BTK		
1.9 DTI	10/01-	F9Q 774	1870	26x132	SK-1493	BTK		
2.2 DTI	09/00-	G9T 720, G9T 722, G9T 750	2188	25x89; mit Zubehör	SK-1489	BTK		
2.5 CDTI	08/06-	G9U 632, G9U 650, G9U 650	2464	25x89; mit Zubehör	SK-1489	BTK		
2.5 D	07/98-09/00	S8U 770, S8U 772	2499	30x152	SK-1035	BTK		
2.5 D	07/98-09/00	S8U 770, S8U 772	2499	30x152; mit Spanndämpfer, Spannrolle	SK-1680	BTK		
2.5 DTI	10/01-	G9U 720, G9U 724, G9U 750, G9U 754	2463	25x89; 10/2003 →; mit Zubehör	SK-1489	BTK		
2.8 DTI	07/98-10/01	S9W 700, S9W 702	2799	30x154; 11/1998 →	SK-1153	BTK		
2.8 DTI	07/98-10/01	S9W 700, S9W 702	2799	mit Spanndämpfer, Spannrolle	SK-1681	BTK		
1.9 DTI	09/00-10/01	F9Q 770	1870		0-N1106	TB [DG]		
1.9 DTI	09/00-10/01	F9Q 770	1870		0-N147	TB [DG]		
1.9 DTI	09/00-10/01	F9Q 770	1870		0-N199	TB [TE]		
1.9 DTI	10/01-	F9Q 772, F9Q 774	1870	mit Grundträger	0-N1173	TB [BT]		
2.2 DTI	09/00-	G9T 720, G9T 722, G9T 750	2188		0-N1269	TB [TE]		
2.2 DTI	09/00-	G9T 720, G9T 722, G9T 750	2188		0-N1270	TB [DG]		
2.5 CDTI	08/06-	G9U 632, G9U 650, G9U 650	2464		0-N1269	TB [TE]		
2.5 CDTI	08/06-	G9U 632, G9U 650, G9U 650	2464		0-N1270	TB [DG]		
2.5 D	07/98-09/00	S8U 770, S8U 772	2499		0-N1617	TB [BT]		
2.5 D	07/98-09/00	S8U 770, S8U 772	2499		0-N816	TB [DG]		
2.5 D	07/98-09/00	S8U 770, S8U 772	2499		0-N821	TB [DG]		
2.5 DTI	10/01-	G9U 720, G9U 724, G9U 750, G9U 754	2463		0-N1269	TB [TE]		
2.5 DTI	10/01-	G9U 720, G9U 724, G9U 750, G9U 754	2463		0-N1270	TB [DG]		
2.8 DTI	07/98-10/01	S9W 700, S9W 702	2799		0-N1617	TB [BT]		
2.8 DTI	07/98-10/01	S9W 700, S9W 702	2799		0-N816	TB [DG]		
1.9 DTI	10/01-	F9Q 772, F9Q 774	1870	✳: →C029793	0-N1307	VB [DG]		
1.9 DTI	10/01-	F9Q 772, F9Q 774	1870	✳: →C029794 →; ✳	0-N1409	VB [DG]		
1.9 DTI	10/01-	F9Q 772, F9Q 774	1870	✳	0-N1611	VB [BT]	S	

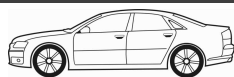

CM³



Art. Nr.



MOVANO Combi (J9)						
1.9 DTI	10/01-	F9Q 772, F9Q 774	1870	☼		0-N1802 VB [BT] S
2.2 DTI	09/00-	G9T 720, G9T 722, G9T 750	2188			0-N1409 VB [DG]
2.2 DTI	09/00-	G9T 720, G9T 722, G9T 750	2188	Rippenanzahl: 6; ☼		0-N1648 VB [DG]
2.2 DTI	09/00-	G9T 720, G9T 722, G9T 750	2188	☼		0-N1731 VB [BT] S
2.2 DTI	09/00-	G9T 720, G9T 722, G9T 750	2188	☼		0-N1875 VB [BT] S
2.5 CDTI	08/06-	G9U 632, G9U 650, G9U 650	2464			0-N1409 VB [DG]
2.5 CDTI	08/06-	G9U 632, G9U 650, G9U 650	2464	☼		0-N1731 VB [BT] S
2.5 CDTI	08/06-	G9U 632, G9U 650, G9U 650	2464	☼		0-N1875 VB [BT] S
2.5 D	07/98-09/00	S8U 770, S8U 772	2499	☼		0-N1591 VB [DG]
2.5 D	07/98-09/00	S8U 770, S8U 772	2499	Rippenanzahl: 5		0-N1650 VB [DG]
2.5 DTI	10/01-	G9U 720, G9U 724, G9U 750, G9U 754	2463			0-N1409 VB [DG]
2.5 DTI	10/01-	G9U 720, G9U 724, G9U 750, G9U 754	2463	Rippenanzahl: 6; ☼		0-N1648 VB [DG]
2.5 DTI	10/01-	G9U 720, G9U 724, G9U 750, G9U 754	2463	☼		0-N1731 VB [BT] S
2.5 DTI	10/01-	G9U 720, G9U 724, G9U 750, G9U 754	2463	☼		0-N1875 VB [BT] S
2.8 DTI	07/98-10/01	S9W 700, S9W 702	2799	☼		0-N1591 VB [DG]
2.8 DTI	07/98-10/01	S9W 700, S9W 702	2799	Rippenanzahl: 5		0-N1650 VB [DG]

MOVANO Kasten (F9)						
1.9 DTI	09/00-10/01	F9Q 770	1870	26x153; beinhaltetete Rollen: 4; mit Zahnrad; mit Zubehör	SK-1490	BTK
1.9 DTI	09/00-10/01	F9Q 770	1870	26x153; beinhaltetete Rollen: 2	SK-1620	BTK
1.9 DTI	10/01-	F9Q 774	1870	26x132	SK-1493	BTK
1.9 DTI	10/01-	F9Q 772, F9Q 774	1870	26x132	SK-1493AQ1	BTKW
1.9 DTI	10/01-	F9Q 772, F9Q 774	1870	26x132	SK-1493AQ2	BTKW
2.2 DTI	09/00-	G9T 720, G9T 722, G9T 750	2188	25x89; mit Zubehör	SK-1489	BTK
2.5 CDTI	10/03-	G9U 632, G9U 650, G9U 650	2464	25x89; mit Zubehör	SK-1489	BTK
2.5 D	01/99-09/00	S8U 770, S8U 772	2499	30x152	SK-1035	BTK
2.5 D	01/99-09/00	S8U 770, S8U 772	2499	30x152; mit Spanndämpfer, Spannrolle	SK-1680	BTK
2.5 DTI	10/01-	G9U 720	2463	25x89; mit Zubehör	SK-1489	BTK
2.5 DTI	10/03-	G9U 754	2463	25x89; mit Zubehör	SK-1489	BTK
2.8 DTI	01/99-10/01	S9W 700, S9W 702	2799	30x154	SK-1153	BTK
2.8 DTI	01/99-10/01	S9W 700, S9W 702	2799	mit Spanndämpfer, Spannrolle	SK-1681	BTK
1.9 DTI	09/00-10/01	F9Q 770	1870		0-N1106	TB [DG]
1.9 DTI	09/00-10/01	F9Q 770	1870		0-N147	TB [DG]
1.9 DTI	09/00-10/01	F9Q 770	1870		0-N199	TB [TE]
1.9 DTI	10/01-	F9Q 772, F9Q 774	1870	mit Grundträger	0-N1173	TB [BT]
2.2 DTI	09/00-	G9T 720, G9T 722, G9T 750	2188		0-N1269	TB [TE]
2.2 DTI	09/00-	G9T 720, G9T 722, G9T 750	2188		0-N1270	TB [DG]
2.5 CDTI	10/03-	G9U 632, G9U 650, G9U 650	2464		0-N1269	TB [TE]
2.5 CDTI	10/03-	G9U 632, G9U 650, G9U 650	2464		0-N1270	TB [DG]
2.5 D	01/99-09/00	S8U 770, S8U 772	2499		0-N1617	TB [BT]
2.5 D	01/99-09/00	S8U 770, S8U 772	2499		0-N816	TB [DG]
2.5 D	01/99-09/00	S8U 770, S8U 772	2499		0-N821	TB [DG]
2.5 DTI	10/01-	G9U 720, G9U 724, G9U 754, G9U 754	2463		0-N1269	TB [TE]
2.5 DTI	10/01-	G9U 720, G9U 724, G9U 754, G9U 754	2463		0-N1270	TB [DG]
2.8 DTI	01/99-10/01	S9W 700, S9W 702	2799		0-N1617	TB [BT]
2.8 DTI	01/99-10/01	S9W 700, S9W 702	2799		0-N816	TB [DG]
1.9 DTI	10/01-	F9Q 772, F9Q 774	1870	☼☼☼☼:→C029793	0-N1307	VB [DG]
1.9 DTI	10/01-	F9Q 772, F9Q 774	1870	☼☼☼☼:C029794→; ☼	0-N1409	VB [DG]
1.9 DTI	10/01-	F9Q 772, F9Q 774	1870	☼	0-N1611	VB [BT] S
1.9 DTI	10/01-	F9Q 772, F9Q 774	1870	☼	0-N1802	VB [BT] S
2.2 DTI	09/00-	G9T 720, G9T 722, G9T 750	2188		0-N1409	VB [DG]
2.2 DTI	09/00-	G9T 720, G9T 722, G9T 750	2188	Rippenanzahl: 6; ☼	0-N1648	VB [DG]
2.2 DTI	09/00-	G9T 720, G9T 722, G9T 750	2188	☼	0-N1731	VB [BT] S
2.2 DTI	09/00-	G9T 720, G9T 722, G9T 750	2188	☼	0-N1875	VB [BT] S
2.5 CDTI	10/03-	G9U 632, G9U 650, G9U 650	2464		0-N1409	VB [DG]
2.5 CDTI	10/03-	G9U 632, G9U 650, G9U 650	2464	☼	0-N1731	VB [BT] S
2.5 CDTI	10/03-	G9U 632, G9U 650, G9U 650	2464	☼	0-N1875	VB [BT] S
2.5 D	01/99-09/00	S8U 770, S8U 772	2499	☼	0-N1591	VB [DG]
2.5 D	01/99-09/00	S8U 770, S8U 772	2499	Rippenanzahl: 5	0-N1650	VB [DG]
2.5 DTI	10/01-	G9U 720, G9U 724, G9U 754, G9U 754	2463		0-N1409	VB [DG]
2.5 DTI	10/01-	G9U 720, G9U 724, G9U 754, G9U 754	2463	Rippenanzahl: 6; ☼	0-N1648	VB [DG]
2.5 DTI	10/01-	G9U 720, G9U 724, G9U 754, G9U 754	2463	☼	0-N1731	VB [BT] S
2.5 DTI	10/01-	G9U 720, G9U 724, G9U 754, G9U 754	2463	☼	0-N1875	VB [BT] S
2.8 DTI	01/99-10/01	S9W 700, S9W 702	2799	☼	0-N1591	VB [DG]
2.8 DTI	01/99-10/01	S9W 700, S9W 702	2799	Rippenanzahl: 5	0-N1650	VB [DG]



CM³



Art. Nr.



MOVANO Kipper (H9)

2.2 DTI	09/00-	G9T 720, G9T 722, G9T 750	2188	25x89; mit Zubehör	SK-1489	BTK	
2.5 CDTI	08/06-	G9U 632, G9U 650, G9U 650	2464	25x89; mit Zubehör	SK-1489	BTK	
2.5 D	01/99-09/00	S8U 770, S8U 772	2499	30x152	SK-1035	BTK	
2.5 D	01/99-09/00	S8U 770, S8U 772	2499	30x152; mit Spanndämpfer, Spannrolle	SK-1680	BTK	
2.5 DTI	10/01-	G9U 720, G9U 724, G9U 750, G9U 754, G9U 754	2463	25x89; mit Zubehör	SK-1489	BTK	
2.8 DTI	01/99-10/01	S9W 700, S9W 702	2799	30x154; 12/1999 →	SK-1153	BTK	
2.8 DTI	01/99-10/01	S9W 700, S9W 702	2799	mit Spanndämpfer, Spannrolle	SK-1681	BTK	
2.2 DTI	09/00-	G9T 720, G9T 722, G9T 750	2188		0-N1269	TB [TE]	
2.2 DTI	09/00-	G9T 720, G9T 722, G9T 750	2188		0-N1270	TB [DG]	
2.5 CDTI	08/06-	G9U 632, G9U 650, G9U 650	2464		0-N1269	TB [TE]	
2.5 CDTI	08/06-	G9U 632, G9U 650, G9U 650	2464		0-N1270	TB [DG]	
2.5 D	01/99-09/00	S8U 770, S8U 772	2499		0-N1617	TB [BT]	
2.5 D	01/99-09/00	S8U 770, S8U 772	2499		0-N816	TB [DG]	
2.5 D	01/99-09/00	S8U 770, S8U 772	2499		0-N821	TB [DG]	
2.5 DTI	10/01-	G9U 720, G9U 724, G9U 750, G9U 754, G9U 754	2463		0-N1269	TB [TE]	
2.5 DTI	10/01-	G9U 720, G9U 724, G9U 750, G9U 754, G9U 754	2463		0-N1270	TB [DG]	
2.8 DTI	01/99-10/01	S9W 700, S9W 702	2799		0-N1617	TB [BT]	
2.8 DTI	01/99-10/01	S9W 700, S9W 702	2799		0-N816	TB [DG]	
2.2 DTI	09/00-	G9T 720, G9T 722, G9T 750	2188		0-N1409	VB [DG]	
2.2 DTI	09/00-	G9T 720, G9T 722, G9T 750	2188	Rippenanzahl: 6; ☼	0-N1648	VB [DG]	
2.2 DTI	09/00-	G9T 720, G9T 722, G9T 750	2188	☼	0-N1731	VB [BT]	S
2.2 DTI	09/00-	G9T 720, G9T 722, G9T 750	2188	☼	0-N1875	VB [BT]	S
2.5 CDTI	08/06-	G9U 632, G9U 650, G9U 650	2464		0-N1409	VB [DG]	
2.5 CDTI	08/06-	G9U 632, G9U 650, G9U 650	2464	☼	0-N1731	VB [BT]	S
2.5 CDTI	08/06-	G9U 632, G9U 650, G9U 650	2464	☼	0-N1875	VB [BT]	S
2.5 D	01/99-09/00	S8U 770, S8U 772	2499	☼	0-N1591	VB [DG]	
2.5 D	01/99-09/00	S8U 770, S8U 772	2499	Rippenanzahl: 5	0-N1650	VB [DG]	
2.5 DTI	10/01-	G9U 720, G9U 724, G9U 750, G9U 754, G9U 754	2463		0-N1409	VB [DG]	
2.5 DTI	10/01-	G9U 720, G9U 724, G9U 750, G9U 754, G9U 754	2463	Rippenanzahl: 6; ☼	0-N1648	VB [DG]	
2.5 DTI	10/01-	G9U 720, G9U 724, G9U 750, G9U 754, G9U 754	2463	☼	0-N1731	VB [BT]	S
2.5 DTI	10/01-	G9U 720, G9U 724, G9U 750, G9U 754, G9U 754	2463	☼	0-N1875	VB [BT]	S
2.8 DTI	01/99-10/01	S9W 700, S9W 702	2799	☼	0-N1591	VB [DG]	
2.8 DTI	01/99-10/01	S9W 700, S9W 702	2799	Rippenanzahl: 5	0-N1650	VB [DG]	

MOVANO Pritsche/Fahrgestell (U9, E9)

2.2 DTI	09/00-	G9T 720, G9T 722, G9T 750	2188	25x89; mit Zubehör	SK-1489	BTK	
2.5 CDTI	08/06-	G9U 632, G9U 650, G9U 650	2464	25x89; mit Zubehör	SK-1489	BTK	
2.5 D	07/98-09/00	S8U 770, S8U 772	2499	30x152	SK-1035	BTK	
2.5 D	07/98-09/00	S8U 770, S8U 772	2499	30x152; mit Spanndämpfer, Spannrolle	SK-1680	BTK	
2.5 DTI	10/01-	G9U 720, G9U 750	2463	25x89; mit Zubehör	SK-1489	BTK	
2.5 DTI	10/03-	G9U 754	2463	25x89; mit Zubehör	SK-1489	BTK	
2.8 DTI	07/98-10/01	S9W 700, S9W 702	2799	30x154; 12/1999 →	SK-1153	BTK	
2.8 DTI	07/98-10/01	S9W 700, S9W 702	2799	mit Spanndämpfer, Spannrolle	SK-1681	BTK	
2.2 DTI	09/00-	G9T 720, G9T 722, G9T 750	2188		0-N1269	TB [TE]	
2.2 DTI	09/00-	G9T 720, G9T 722, G9T 750	2188		0-N1270	TB [DG]	
2.5 CDTI	08/06-	G9U 632, G9U 650, G9U 650	2464		0-N1269	TB [TE]	
2.5 CDTI	08/06-	G9U 632, G9U 650, G9U 650	2464		0-N1270	TB [DG]	
2.5 D	07/98-09/00	S8U 770, S8U 772	2499		0-N1617	TB [BT]	
2.5 D	07/98-09/00	S8U 770, S8U 772	2499		0-N816	TB [DG]	
2.5 D	07/98-09/00	S8U 770, S8U 772	2499		0-N821	TB [DG]	
2.5 DTI	10/01-	G9U 720, G9U 724, G9U 750, G9U 754, G9U 754	2463		0-N1269	TB [TE]	
2.5 DTI	10/01-	G9U 720, G9U 724, G9U 750, G9U 754, G9U 754	2463		0-N1270	TB [DG]	
2.8 DTI	07/98-10/01	S9W 700, S9W 702	2799		0-N1617	TB [BT]	
2.8 DTI	07/98-10/01	S9W 700, S9W 702	2799		0-N816	TB [DG]	
2.2 DTI	09/00-	G9T 720, G9T 722, G9T 750	2188		0-N1409	VB [DG]	
2.2 DTI	09/00-	G9T 720, G9T 722, G9T 750	2188	Rippenanzahl: 6; ☼	0-N1648	VB [DG]	
2.2 DTI	09/00-	G9T 720, G9T 722, G9T 750	2188	☼	0-N1731	VB [BT]	S
2.2 DTI	09/00-	G9T 720, G9T 722, G9T 750	2188	☼	0-N1875	VB [BT]	S
2.5 CDTI	08/06-	G9U 632, G9U 650, G9U 650	2464		0-N1409	VB [DG]	



OPTIMAL®

OPEL



CM³



Art. Nr.



ohne Halter

MOVANO Pritsche/Fahrgestell (U9, E9)

2.5 CDTI	08/06-	G9U 632, G9U 650, G9U 650	2464	⊗	0-N1731	VB [BT]	S
2.5 CDTI	08/06-	G9U 632, G9U 650, G9U 650	2464	⊗	0-N1875	VB [BT]	S
2.5 D	07/98-09/00	S8U 770, S8U 772	2499	⊗	0-N1591	VB [DG]	
2.5 D	07/98-09/00	S8U 770, S8U 772	2499	Rippenanzahl: 5	0-N1650	VB [DG]	
2.5 DTI	10/01-	G9U 720, G9U 724, G9U 750, G9U 754, G9U 754	2463		0-N1409	VB [DG]	
2.5 DTI	10/01-	G9U 720, G9U 724, G9U 750, G9U 754	2463	Rippenanzahl: 6; ⊗	0-N1648	VB [DG]	
2.5 DTI	10/01-	G9U 720, G9U 724, G9U 750, G9U 754, G9U 754	2463	⊗	0-N1731	VB [BT]	S
2.5 DTI	10/01-	G9U 720, G9U 724, G9U 750, G9U 754, G9U 754	2463	⊗	0-N1875	VB [BT]	S
2.5 DTi	10/03-	G9U 754	2463	Rippenanzahl: 6	0-N1648	VB [DG]	
2.8 DTI	07/98-10/01	S9W 700, S9W 702	2799	⊗	0-N1591	VB [DG]	
2.8 DTI	07/98-10/01	S9W 700, S9W 702	2799	Rippenanzahl: 5	0-N1650	VB [DG]	

MOVANO B Bus

2.3 CDTI	12/10-	M9T 670, M9T 672, M9T 676, M9T 670, M9T 672, M9T 676, M9T 680, M9T 876, M9T 678, M9T 680	2298		0-N1739	VB [DG]	
2.3 CDTI	12/10-	M9T 670, M9T 672, M9T 676, M9T 670, M9T 672, M9T 676, M9T 680, M9T 876, M9T 678, M9T 680	2298		0-N2039	VB [BT]	S

MOVANO B Kasten

2.3 CDTI [RWD], 2.3 CDTI FWD	05/10-	M9T 670, M9T 672, M9T 676, M9T 670, M9T 672, M9T 676, M9T 876, M9T 678, M9T 680, M9T 686, M9T 690, M9T 696, M9T 876, M9T 690, M9T 692, M9T 694, M9T 696, M9T 698	2298		0-N1739	VB [DG]	
2.3 CDTI [RWD], 2.3 CDTI FWD	05/10-	M9T 670, M9T 672, M9T 676, M9T 670, M9T 672, M9T 676, M9T 876, M9T 678, M9T 680, M9T 686, M9T 690, M9T 696, M9T 876, M9T 690, M9T 692, M9T 694, M9T 696, M9T 698	2298		0-N2039	VB [BT]	S

MOVANO B Pritsche/Fahrgestell

2.3 CDTI [RWD], 2.3 CDTI FWD	05/10-	M9T 670, M9T 672, M9T 676, M9T 670, M9T 672, M9T 676, M9T 680, M9T 876, M9T 678, M9T 680, M9T 690, M9T 692, M9T 692, M9T 696, M9T 698, M9T 876, M9T 694, M9T 696, M9T 698	2298		0-N1739	VB [DG]	
2.3 CDTI [RWD], 2.3 CDTI FWD	05/10-	M9T 670, M9T 672, M9T 676, M9T 670, M9T 672, M9T 676, M9T 680, M9T 876, M9T 678, M9T 680, M9T 690, M9T 692, M9T 692, M9T 696, M9T 698, M9T 876, M9T 694, M9T 696, M9T 698	2298		0-N2039	VB [BT]	S

OMEGA A (16_, 17_, 19_)

1.8	09/86-03/94	18 SEH	1796	20x146; :14608701→	SK-1169	BTK	
1.8	09/86-03/94	18 SEH	1796	20x146; :14608701→	SK-1169AQ1	BTKW	
1.8, 1.8 N, 1.8 S	09/86-03/94	18 NV, 18 SEH, 18 SV, E 18 NVR	1796	20x111; :→14270600	R-1072AQ1	BTKW	
2.0	09/86-03/94	20 SE	1998	20x111; → 08/1989; :→14608700	R-1072AQ1	BTKW	
2.0, 2.0 i	09/86-03/94	C 20 NE, C 20 NEF, C 20 NEJ	1998	20x111; :→14608700	R-1072AQ1	BTKW	
2.0, 2.0 i	09/86-04/94	20 SE, C 20 NE, C 20 NE, C 20 NE, C 20 NEF, C 20 NEJ	1998	20x146; :14608701→	SK-1169	BTK	
2.0, 2.0 i	09/86-04/94	20 SE, C 20 NE, C 20 NE, C 20 NE, C 20 NEF, C 20 NEJ	1998	20x146; :14608701→	SK-1169AQ1	BTKW	
2.0, 2.0 i	09/86-03/94	20 SE, C 20 NE	1998	:14608701→	0-N101	TB [TE]	
2.6 i	09/90-03/94	C 26 NE	2594	:01032427→; Rippenanzahl: 6	0-N1439	VB [DG]	
2.6 i	09/90-03/94	C 26 NE	2594		0-N1603	VB [DG]	
3.0	03/87-03/94	30 NE, C 30 NE	2969	:01039675→; Rippenanzahl: 6	0-N1439	VB [DG]	
3.0, 3.0 24V	03/87-03/94	30 NE, C 30 NE, C 30 SE	2969		0-N1603	VB [DG]	
3.0 24V	09/89-03/94	C 30 SE	2969	:01024730→; Rippenanzahl: 6	0-N1439	VB [DG]	

OMEGA A Caravan (66_, 67_)

1.8	09/86-03/94	18 SEH	1796	20x146; :14608701→	SK-1169	BTK	
1.8	09/86-03/94	18 SEH	1796	20x146; :14608701→	SK-1169AQ1	BTKW	
1.8, 1.8 N, 1.8 S	09/86-03/94	18 NV, 18 SEH, 18 SV, E 18 NVR	1796	20x111; :→14270600	R-1072AQ1	BTKW	
2.0	09/86-03/94	20 SE	1998	20x111; → 08/1987; :→14608700	R-1072AQ1	BTKW	
2.0, 2.0 i	09/86-04/94	C 20 NE, C 20 NEF, C 20 NEJ	1998	20x111; :→14608700	R-1072AQ1	BTKW	
2.0, 2.0 i	09/86-04/94	20 SE, C 20 NE, C 20 NEF, C 20 NEJ	1998	20x146; :14608701→	SK-1169	BTK	
2.0, 2.0 i	09/86-04/94	20 SE, C 20 NE, C 20 NEF, C 20 NEJ	1998	20x146; :14608701→	SK-1169AQ1	BTKW	
2.0, 2.0 i	09/86-04/94	20 SE, C 20 NE	1998	:14608701→	0-N101	TB [TE]	
2.6 i	09/90-03/94	C 26 NE	2594	:01032427→; Rippenanzahl: 6	0-N1439	VB [DG]	
2.6 i	09/90-03/94	C 26 NE	2594		0-N1603	VB [DG]	



CM³



Art. Nr.



ohne Halter

OMEGA A Caravan (66_, 67_)							
3.0, 3.0 KAT	03/87-03/94	30 NE, C 30 NE	2969	01039675→; Rippenanzahl: 6	0-N1439	VB [DG]	
3.0, 3.0 KAT	03/87-03/94	30 NE, C 30 NE	2969		0-N1603	VB [DG]	
OMEGA B (25_, 26_, 27_)							
2.0	03/94-12/00	20 SE, X 20 SE	1998	20x146	SK-1169	BTK	
2.0	03/94-12/00	20 SE, X 20 SE	1998	20x146	SK-1169AQ1	BTKW	
2.0 16V	03/94-09/99	X 20 XEV	1998	24x169	SK-1100	BTK	
2.0 16V	03/94-09/99	X 20 XEV	1998	24x169	SK-1100AQ1	BTKW	
2.2 16V	09/99-07/03	Z 22 XE	2198	24x171; 08/2000 →	SK-1644	BTK	
2.2 16V	09/99-07/03	Y 22 XE, Z 22 XE	2198	24x171	SK-1644AQ1	BTKW	
2.5 V6	03/94-09/00	X 25 XE	2498	30x225; →08300418; mit Zubehör	SK-1508	BTK	
2.6 V6	09/00-07/03	Y 26 SE	2597	30x225; →08300418; mit Zubehör	SK-1508	BTK	
3.0 V6	04/94-02/01	X 30 XE	2962	30x225; →08300418; mit Zubehör	SK-1508	BTK	
2.0	03/94-12/00	20 SE, X 20 SE	1998		0-N101	TB [TE]	
2.0 16V	03/94-09/99	X 20 XEV	1998		0-N100	TB [TE]	
2.0 16V	03/94-09/99	X 20 XEV	1998		0-N906	TB [DG]	
2.2 16V	09/99-07/03	Y 22 XE, Z 22 XE	2198		0-N1383	TB [TE]	
2.2 16V	09/99-07/03	Y 22 XE, Z 22 XE	2198		0-N906	TB [DG]	
2.5 V6	03/94-09/00	X 25 XE	2498	08292479→; →08300418; für OE: 90530599	0-N956	TB [TE]	
2.5 V6	03/94-09/00	X 25 XE	2498	→08300418	0-N957	TB [DG]	
3.0 V6	04/94-02/01	X 30 XE	2962	08292479→; →08300418; für OE: 90530599	0-N956	TB [TE]	
3.0 V6	04/94-02/01	X 30 XE	2962	→08300418	0-N957	TB [DG]	
2.0 DTI 16V	09/97-09/00	X 20 DTH	1995	Rippenanzahl: 6	0-N1437	VB [DG]	
2.0 DTI 16V	09/97-09/00	X 20 DTH	1995		0-N1485	VB [BT]	S
2.0 DTI 16V	09/97-09/00	X 20 DTH	1995		0-N2169	VB [VD]	
2.0, 2.0 16V	03/94-09/99	X 20 SE, X 20 XEV	1998		0-N1422	VB [BT]	S
2.2 16V	09/99-07/03	Y 22 XE, Z 22 XE	2198		0-N1422	VB [BT]	S
2.2 DTI 16V	09/00-07/03	Y 22 DTH	2171		0-N1485	VB [BT]	S
2.2 DTI 16V	09/00-07/03	Y 22 DTH	2171		0-N2169	VB [VD]	
2.5 DTI	09/01-07/03	Y 25 DT	2497		0-N1396	VB [DG]	
2.5 DTI	09/01-07/03	Y 25 DT	2497		0-N1834	VB [BT]	S
2.5 DTI	09/01-07/03	Y 25 DT	2497		0-N1912	VB [BT]	S
2.5 DTI	09/01-07/03	Y 25 DT	2497		0-N1923	VB [BT]	
2.5 DTI	09/01-07/03	Y 25 DT	2497		0-N1940	VB [BT]	S
2.5 DTI	09/01-07/03	Y 25 DT	2497		0-N2072	VB [BT]	
2.5 TD	04/94-07/03	25 DT, X 25 DT, X 25 TD	2497		0-N1303	VB [VD]	
2.5 TD	04/94-07/03	25 DT, X 25 DT, X 25 TD	2497		0-N1304	VB [TE]	
2.5 TD	04/94-07/03	25 DT, X 25 DT, X 25 TD	2497		0-N1305	VB [DG]	
2.5 TD	04/94-07/03	25 DT, X 25 DT, X 25 TD	2497	30018761→	0-N1306	VB [TE]	
2.5 V6	03/94-09/00	X 25 XE	2498	Rippenanzahl: 6	0-N1438	VB [BT]	S
2.5 V6	03/94-09/00	X 25 XE	2498	☼	0-N1603	VB [DG]	
2.6 V6	09/00-07/03	Y 26 SE	2597	Rippenanzahl: 6	0-N1438	VB [BT]	S
3.0 V6	04/94-02/01	X 30 XE	2962	Rippenanzahl: 6	0-N1438	VB [BT]	S
3.2 V6	02/01-07/03	Y 32 SE	3175	Rippenanzahl: 6	0-N1438	VB [BT]	S
OMEGA B Caravan (21_, 22_, 23_)							
2.0	03/94-09/99	X 20 SE	1998	20x146	SK-1169	BTK	
2.0	03/94-09/99	X 20 SE	1998	20x146	SK-1169AQ1	BTKW	
2.0 16V	03/94-09/99	X 20 XEV	1998	24x169	SK-1100	BTK	
2.0 16V	03/94-09/99	X 20 XEV	1998	24x169	SK-1100AQ1	BTKW	
2.2 16V	09/99-07/03	Z 22 XE	2198	24x171; 08/2000 →	SK-1644	BTK	
2.2 16V	09/99-07/03	Y 22 XE, Z 22 XE	2198	24x171	SK-1644AQ1	BTKW	
2.5 V6	03/94-09/00	X 25 XE	2498	30x225; →08300418; mit Zubehör	SK-1508	BTK	
2.6 V6	09/00-07/03	Y 26 SE	2597	30x225; →08300418; mit Zubehör	SK-1508	BTK	
3.0 V6	04/94-02/01	X 30 XE	2962	30x225; →08300418; mit Zubehör	SK-1508	BTK	
2.0	03/94-09/99	X 20 SE	1998		0-N101	TB [TE]	
2.0 16V	03/94-09/99	X 20 XEV	1998		0-N100	TB [TE]	
2.0 16V	03/94-09/99	X 20 XEV	1998		0-N906	TB [DG]	
2.2 16V	09/99-07/03	Y 22 XE, Z 22 XE	2198		0-N1383	TB [TE]	
2.2 16V	09/99-07/03	Y 22 XE, Z 22 XE	2198		0-N906	TB [DG]	
2.5 V6	03/94-09/00	X 25 XE	2498	08292479→; →08300418; für OE: 90530599	0-N956	TB [TE]	
2.5 V6	03/94-09/00	X 25 XE	2498	→08300418	0-N957	TB [DG]	
3.0 V6	04/94-02/01	X 30 XE	2962	08292479→; →08300418; für OE: 90530599	0-N956	TB [TE]	



OPTIMAL®

OPEL



CM³



Art. Nr.



ohne Halter

OMEGA B Caravan (21_, 22_, 23_)

3.0 V6	04/94-02/01	X 30 XE	2962	:→08300418	0-N957	TB [DG]	
2.0 DTI 16V	09/97-09/00	X 20 DTH	1995	Rippenanzahl: 6	0-N1437	VB [DG]	
2.0 DTI 16V	09/97-09/00	X 20 DTH	1995		0-N1485	VB [BT]	S
2.0 DTI 16V	09/97-09/00	X 20 DTH	1995		0-N2169	VB [VD]	
2.0, 2.0 16V	03/94-09/99	X 20 SE, X 20 XEV	1998		0-N1422	VB [BT]	S
2.2 16V	09/99-07/03	Y 22 XE, Z 22 XE	2198		0-N1422	VB [BT]	S
2.2 DTI 16V	09/00-07/03	Y 22 DTH	2171		0-N1485	VB [BT]	S
2.2 DTI 16V	09/00-07/03	Y 22 DTH	2171		0-N2169	VB [VD]	
2.5 DTI	09/01-07/03	Y 25 DT	2497		0-N1396	VB [DG]	
2.5 DTI	09/01-07/03	Y 25 DT	2497		0-N1834	VB [BT]	S
2.5 DTI	09/01-07/03	Y 25 DT	2497		0-N1912	VB [BT]	S
2.5 DTI	09/01-07/03	Y 25 DT	2497		0-N1923	VB [BT]	
2.5 DTI	09/01-07/03	Y 25 DT	2497		0-N1940	VB [BT]	S
2.5 DTI	09/01-07/03	Y 25 DT	2497		0-N2072	VB [BT]	
2.5 TD	04/94-07/01	25 DT, X 25 DT, X 25 TD	2497		0-N1303	VB [VD]	
2.5 TD	04/94-07/01	25 DT, X 25 DT, X 25 TD	2497		0-N1304	VB [TE]	
2.5 TD	04/94-07/01	25 DT, X 25 DT, X 25 TD	2497		0-N1305	VB [DG]	
2.5 TD	04/94-07/01	25 DT, X 25 DT, X 25 TD	2497	:30018761→	0-N1306	VB [TE]	
2.5 V6	03/94-09/00	X 25 XE	2498	Rippenanzahl: 6	0-N1438	VB [BT]	S
2.5 V6	03/94-09/00	X 25 XE	2498	⚡	0-N1603	VB [DG]	
2.6 V6	09/00-07/03	Y 26 SE	2597	Rippenanzahl: 6	0-N1438	VB [BT]	S
3.0 V6	04/94-02/01	X 30 XE	2962	Rippenanzahl: 6	0-N1438	VB [BT]	S
3.2 V6	02/01-07/03	Y 32 SE	3175	Rippenanzahl: 6	0-N1438	VB [BT]	S

SENATOR B (29_)

2.6 i	09/90-09/93	C 26 NE	2594	:01032427→; Rippenanzahl: 6	0-N1439	VB [DG]	
2.6 i	09/90-09/93	C 26 NE	2594		0-N1603	VB [DG]	
3.0 24V	09/89-09/93	C 30 SE	2969	:01024730→; Rippenanzahl: 6	0-N1439	VB [DG]	
3.0 24V	09/89-09/93	C 30 SE	2969		0-N1603	VB [DG]	
3.0, 3.0 i KAT	01/88-09/93	30 NE, C 30 NE	2969	:01039675→; Rippenanzahl: 6	0-N1439	VB [DG]	
3.0, 3.0 i KAT	01/88-09/93	30 NE, C 30 NE	2969	:01000001→	0-N1603	VB [DG]	

SIGNUM

1.8	05/03-	Z 18 XE	1796	20x162; mit Zubehör	SK-1355	BTK	
1.8	05/03-	Z 18 XE	1796	20x162; mit Zubehör	SK-1355AQ1	BTKW	
1.8	09/05-	Z 18 XER	1796	24x146	SK-1607	BTK	
1.9 CDTI	04/04-	Z 19 DTH	1910	24x199	SK-1586	BTK	
1.9 CDTI	04/04-	Z 19 DTH	1910	24x199	SK-1586AQ1	BTKW	
1.9 CDTI	04/04-	Z 19 DT	1910	24x190; → 02/2008	SK-1696	BTK	
1.9 CDTI	04/04-	Z 19 DT	1910	24x190	SK-1696AQ1	BTKW	
3.0 V6 CDTI	05/03-	Y 30 DT	2958	25x116	SK-1611	BTK	
3.0 V6 CDTI	09/05-	Z 30 DT	2959	25x116; → 12/2008	SK-1611	BTK	
1.8	05/03-	Z 18 XE	1796		0-N102	TB [TE]	
1.8	05/03-	Z 18 XE	1796	⚡; mit Anbaumaterial	0-N300	TB [DG]	
1.8	05/03-	Z 18 XE	1796		0-N953	TB [DG]	
1.8	09/05-	Z 18 XER	1796		0-N1347	TB [TE]	
1.8	09/05-	Z 18 XER	1796		0-N1348	TB [DG]	
1.9 CDTI	04/04-	Z 19 DT, Z 19 DTH	1910		0-N115	TB [TE]	
1.9 CDTI	04/04-	Z 19 DT, Z 19 DTH	1910		0-N2149	TB [DG]	
3.0 V6 CDTI	05/03-	Y 30 DT	2958		0-N1353	TB [TE]	
3.0 V6 CDTI	05/03-	Y 30 DT	2958		0-N1354	TB [DG]	
3.0 V6 CDTI	05/03-	Y 30 DT	2958		0-N1355	TB [DG]	
3.0 V6 CDTI	09/05-	Z 30 DT	2959		0-N1353	TB [TE]	
3.0 V6 CDTI	09/05-	Z 30 DT	2959		0-N1354	TB [DG]	
3.0 V6 CDTI	09/05-	Z 30 DT	2959		0-N1355	TB [DG]	
1.8	05/03-	Z 18 XE	1796		0-N1466	VB [BT]	S
1.8	09/05-	Z 18 XER	1796		0-N1799	VB [BT]	S
1.9 CDTI	04/04-	Z 19 DT, Z 19 DTH	1910	:→71111927	0-N1503	VB [BT]	S
1.9 CDTI	04/04-	Z 19 DT, Z 19 DTH	1910	:→71111927; ⚡	0-N1522	VB [DG]	
1.9 CDTI	04/04-	Z 19 DT, Z 19 DTH	1910	Rippenanzahl: 6	0-N1667	VB [DG]	
1.9 CDTI	04/04-	Z 19 DT, Z 19 DTH	1910	:71111928→	0-N2030	VB [BT]	S
2.0 DTI	05/03-	Y 20 DTH	1994	Rippenanzahl: 6	0-N1437	VB [DG]	
2.0 DTI	05/03-	Y 20 DTH	1994		0-N1485	VB [BT]	S
2.0 DTI	05/03-	Y 20 DTH	1994		0-N2169	VB [VD]	
2.0 Turbo	05/03-	Z 20 NET	1998		0-N1588	VB [BT]	S
2.2 direct	05/03-	Z 22 YH	2198		0-N1588	VB [BT]	S



CM³



Art. Nr.



ohne Halter

SIGNUM							
2.2 DTI	05/03-	Y 22 DTR	2171	Rippenanzahl: 6	0-N1437	VB [DG]	
2.2 DTI	05/03-	Y 22 DTR	2171		0-N1485	VB [BT]	S
2.2 DTI	05/03-	Y 22 DTR	2171		0-N2169	VB [VD]	
2.8 V6 Turbo	09/05-	Z 28 NEL, Z 28 NET	2792		0-N2194	VB [BT]	S
3.0 V6 CDTI	05/03-	Y 30 DT	2958	Rippenanzahl: 6	0-N1461	VB [DG]	
3.0 V6 CDTI	05/03-	Y 30 DT	2958		0-N1633	VB [DG]	
3.0 V6 CDTI	05/03-	Y 30 DT	2958		0-N1649	VB [DG]	
3.0 V6 CDTI	05/03-	Y 30 DT	2958		0-N1717	VB [BT]	S
3.0 V6 CDTI	09/05-	Z 30 DT	2959	Rippenanzahl: 6	0-N1461	VB [DG]	
3.0 V6 CDTI	09/05-	Z 30 DT	2959		0-N1633	VB [DG]	
3.0 V6 CDTI	09/05-	Z 30 DT	2959		0-N1649	VB [DG]	
3.0 V6 CDTI	09/05-	Z 30 DT	2959		0-N1717	VB [BT]	S
3.2 V6	05/03-	Z 32 SE	3175	Rippenanzahl: 6	0-N1437	VB [DG]	
3.2 V6	05/03-	Z 32 SE	3175	Rippenanzahl: 6	0-N1438	VB [BT]	S
SINTRA							
2.2 i 16V	11/96-04/99	X 22 XE	2198	24x171	SK-1644	BTK	
2.2 i 16V	11/96-04/99	X 22 XE	2198	24x171	SK-1644AQ1	BTKW	
3.0 i 24V	11/96-04/99	X 30 XE	2962	30x225; :→08299999; mit Zubehör	SK-1508	BTK	
2.2 i 16V	11/96-04/99	X 22 XE	2198		0-N1383	TB [TE]	
2.2 i 16V	11/96-04/99	X 22 XE	2198		0-N906	TB [DG]	
3.0 i 24V	11/96-04/99	X 30 XE	2962	:→08300000	0-N957	TB [DG]	
2.2 DTI	07/97-04/99	X 22 DTH	2171		0-N1485	VB [BT]	S
2.2 DTI	07/97-04/99	X 22 DTH	2171		0-N2169	VB [VD]	
2.2 i 16V	11/96-04/99	X 22 XE	2198		0-N1422	VB [BT]	S
3.0 i 24V	11/96-04/99	X 30 XE	2962	Rippenanzahl: 6	0-N1438	VB [BT]	S
SPEEDSTER							
2.0 Turbo	04/03-	Z 20 LET	1998	24x168; ch.→3N999999	SK-1632AQ1	BTKW	
2.0 Turbo	04/03-	Z 20 LET	1998	24x168; ch.4N000001→	SK-1667	BTK	
2.0 Turbo	04/03-	Z 20 LET	1998	24x168; ch.4N000001→	SK-1667AQ1	BTKW	
2.0, 2.0 Turbo	04/03-08/06	Z 20 LET	1998	24x168; ch.→3N999999	SK-1632	BTK	
2.0, 2.0 Turbo	04/03-08/06	Z 20 LET	1998	→ 12/2003	0-N127	TB [DG]	
2.0, 2.0 Turbo	04/03-08/06	Z 20 LET	1998	01/2004 →	0-N127	TB [DG]	
2.0, 2.0 Turbo	04/03-08/06	Z 20 LET	1998		0-N1369	TB [TE]	
2.0, 2.0 Turbo	04/03-08/06	Z 20 LET	1998	01/2004 →	0-N1574	TB [DG]	
2.0, 2.0 Turbo	04/03-08/06	Z 20 LET	1998		0-N1422	VB [BT]	S
2.2	09/00-	Z 22 SE	2198		0-N1588	VB [BT]	S
TIGRA (95_)							
1.4 16V	07/94-12/00	X 14 XE	1389	20x169; mit Zubehör	SK-1073	BTK	
1.4 16V	07/94-12/00	X 14 XE	1389	20x169; mit Zubehör	SK-1073AQ1	BTKW	
1.6 16V	07/94-08/98	C 16 SEL, X 16 XE	1598	20x169; mit Zubehör	SK-1073	BTK	
1.6 16V	07/94-08/98	C 16 SEL, X 16 XE	1598	20x169; mit Zubehör	SK-1073AQ1	BTKW	
1.4 16V	07/94-12/00	X 14 XE	1389		0-N102	TB [TE]	
1.4 16V	07/94-12/00	X 14 XE	1389		0-N952	TB [DG]	
1.4 16V	07/94-12/00	X 14 XE	1389		0-N953	TB [DG]	
1.6 16V	07/94-08/98	C 16 SEL, X 16 XE	1598		0-N102	TB [TE]	
1.6 16V	07/94-08/98	C 16 SEL, X 16 XE	1598		0-N952	TB [DG]	
1.6 16V	07/94-08/98	C 16 SEL, X 16 XE	1598		0-N953	TB [DG]	
1.4 16V	07/94-12/00	X 14 XE	1389		0-N1422	VB [BT]	S
1.4 16V	07/94-12/00	X 14 XE	1389	Rippenanzahl: 6	0-N1439	VB [DG]	
1.4 16V	07/94-12/00	X 14 XE	1389	für Fahrzeuge ohne Servolenkung	0-N1464	VB [BT]	S
1.6 16V	07/94-08/98	X 16 XE	1598		0-N1422	VB [BT]	S
1.6 16V	07/94-08/98	C 16 SEL, X 16 XE	1598	Rippenanzahl: 6	0-N1439	VB [DG]	
1.6 16V	07/94-08/98	C 16 SEL, X 16 XE	1598	für Fahrzeuge ohne Servolenkung	0-N1464	VB [BT]	S
TIGRA TwinTop							
1.8	06/04-	Z 18 XE	1796	20x162; mit Zubehör	SK-1355	BTK	
1.8	06/04-	Z 18 XE	1796	20x162; mit Zubehör	SK-1355AQ1	BTKW	
1.8	06/04-	Z 18 XE	1796		0-N102	TB [TE]	
1.8	06/04-	Z 18 XE	1796	†; mit Anbaumaterial	0-N300	TB [DG]	
1.8	06/04-	Z 18 XE	1796		0-N953	TB [DG]	
1.3 CDTI	06/04-	Z 13 DT	1248		0-N1526	VB [BT]	S
1.4	06/04-	Z 14 XEP	1364		0-N2170	VB [BT]	S
1.8	06/04-	Z 18 XE	1796		0-N1466	VB [BT]	S



CM³



Art. Nr.



VECTRA A (86_, 87_)

1.4 S	09/88-06/92	14 NV	1389	17x111; :19307806→; mit Zubehör	SK-1162	BTK
1.4 S	09/88-06/92	14 NV	1389	17x111; :02J22350, 19307806→; mit Zubehör	SK-1162AQ1	BTKW
1.6	08/92-06/94	E 16 NZ	1598	17x111; :02J22350, 19307806→; mit Zubehör; Baumuster: 87	SK-1162	BTK
1.6	08/92-07/93	C 16 LZ2	1598	20x146	SK-1169	BTK
1.6	08/92-07/93	C 16 LZ2	1598	20x146	SK-1169AQ1	BTKW
1.6 i	09/88-11/95	C16NZ	1598	17x111; :02J22350, 19307806→; mit Zubehör	SK-1162AQ1	BTKW
1.6 i	09/88-11/95	C16NZ2	1598	20x146	SK-1169	BTK
1.6 i	09/88-11/95	C16NZ2	1598	20x146	SK-1169AQ1	BTKW
1.6 i	09/93-11/95	X 16 SZ	1598	17x111; :02J22350→; mit Zubehör	SK-1162	BTK
1.6, 1.6 i	09/88-11/95	16 LZ2, C 16 LZ2, 16 SV, C 16 NZ, C 16 NZ2, E 16 NZ	1598	17x111; :02J22350, 19307806→; mit Zubehör	SK-1162	BTK
1.6, 1.6 i	09/88-11/95	16 LZ2, C 16 LZ2, 16 SV, E 16 NZ, X 16 SZ	1598	17x111; :02J22350, 19307806→; mit Zubehör	SK-1162AQ1	BTKW
1.7 D	10/88-09/92	17 D	1700	24x146	SK-1037	BTK
1.7 D	10/88-09/92	17 D	1700	24x146; →14333430	SK-1037AQ1	BTKW
1.7 D	10/88-11/95	17 D, 17 DR	1700	24x176; :14363651→	SK-1038	BTK
1.7 D	10/88-11/95	17 D, 17 DR	1700	24x176; :14363651→	SK-1038AQ1	BTKW
1.7 D	07/92-11/95	17 DR	1700	24x146; →14363650	SK-1037	BTK
1.7 D	07/92-11/95	17 DR	1700	24x146; →14363650	SK-1037AQ1	BTKW
1.7 TD	03/90-11/95	17 DT (TC4EE1), X 17 DT (TC4EE1)	1686	25 4x136; 08/1992 →; :551390; mit Zubehör	SK-1164	BTK
1.7 TD	03/90-11/95	17 DT (TC4EE1), X 17 DT (TC4EE1)	1686	25x136; 08/1992 →; :551391→; mit Zubehör	SK-1168	BTK
1.8 i KAT, 1.8 S	09/89-11/95	C 18 NZ	1796	20x146; :14254439→	SK-1169AQ1	BTKW
1.8 i KAT, 1.8 S, 1.8 S 4x4	09/88-11/95	18 SV, C 18 NZ, E 18 NVR	1796	20x111; →14142838	R-1072AQ1	BTKW
1.8 i KAT, 1.8 S, 1.8 S 4x4	09/88-11/95	18 SV, C 18 NZ, E 18 NVR	1796	20x146; :14142839→	SK-1169	BTK
1.8 i KAT, 1.8 S, 1.8 S 4x4	09/88-11/95	18 SV, C 18 NZ, E 18 NVR	1796	20x146; :14270601→	SK-1169AQ1	BTKW
2.0 i 16V, 2.0 i 16V 4x4	06/94-11/95	X 20 XEV	1998	24x169	SK-1100	BTK
2.0 i 16V, 2.0 i 16V 4x4	06/94-11/95	X 20 XEV	1998	24x169	SK-1100AQ1	BTKW
2.0 i 4x4	01/89-09/92	20 SEH	1998	20x111; 08/1989 →; :14142838	R-1072AQ1	BTKW
2.0 i Turbo 4x4	06/94-11/95	C 20 LET	1998	24x141; →14002934	SK-1163	BTK
2.0 i Turbo 4x4	06/94-11/95	C 20 LET	1998	24x176; :14002935→	SK-1165	BTK
2.0, 2.0 i, 2.0 i 4x4, 2.0 i 4x4 KAT, 2.0 i KAT	09/88-11/95	20 NE, 20 SEH, C 20 NE, C 20 NEF	1998	20x111; →14142838	R-1072AQ1	BTKW
2.0, 2.0 i, 2.0 i 4x4, 2.0 i 4x4 KAT, 2.0 i KAT	09/88-11/95	20 NE, 20 SEH, C 20 NE, C 20 NEF	1998	20x146; :14142839→	SK-1169	BTK
2.0, 2.0 i, 2.0 i 4x4, 2.0 i 4x4 KAT, 2.0 i KAT	09/88-11/95	20 NE, 20 SEH, C 20 NE, C 20 NEF	1998	20x146; :14142839→	SK-1169AQ1	BTKW
2.5 V6	02/93-11/95	C 25 XE	2498	30x225; mit Zubehör	SK-1508	BTK
2000 16V 4x4	01/89-10/90	20 XEJ	1998	24x141; 08/1989 →; :14142838	SK-1163	BTK
2000 16V 4x4, 2000/GT 16V, 2000/GT 16V 4x4 KAT, 2000/GT 16V KAT	01/89-11/95	20 XEJ, C 20 XE	1998	24x176; :14142839→	SK-1165	BTK
2000/GT 16V	01/89-06/94	20 XEJ	1998	24x141; →14142838	SK-1163	BTK
2000/GT 16V 4x4 KAT, 2000/GT 16V KAT	02/90-11/95	C 20 XE	1998	24x141	SK-1163	BTK
1.6, 1.6 i	08/92-11/95	16 LZ2, C 16 LZ2, C 16 LZ2	1598		0-N101	TB [TE]
1.7 D	10/88-09/92	17 D	1700		0-N875	TB [DG]
1.7 D	07/92-11/95	17 DR	1700		0-N100	TB [TE]
1.7 D	07/92-11/95	17 DR	1700		0-N909	TB [DG]
1.7 TD	03/90-11/95	17 DT (TC4EE1), X 17 DT (TC4EE1)	1686	:855806→	0-N126	TB [TE]
1.7 TD	03/90-11/95	17 DT (TC4EE1), X 17 DT (TC4EE1)	1686		0-N878	TB [DG]
1.7 TD	03/90-11/95	17 DT (TC4EE1), X 17 DT (TC4EE1)	1686	:855805	0-N910	TB [TE]
1.8 i KAT, 1.8 S	09/89-11/95	18 SV, C 18 NZ	1796	:14142839→	0-N101	TB [TE]
1.8 S, 1.8 S 4x4	09/88-07/89	E 18 NVR	1796		0-N101	TB [TE]
2.0 i 16V, 2.0 i 16V 4x4, 2.0 i Turbo 4x4	06/94-11/95	C 20 LET, X 20 XEV	1998		0-N100	TB [TE]
2.0 i 16V, 2.0 i 16V 4x4, 2.0 i Turbo 4x4	06/94-11/95	C 20 LET, X 20 XEV	1998		0-N906	TB [DG]
2.0 i Turbo 4x4	06/94-11/95	C 20 LET	1998		0-N907	TB [DG]
2.0 i, 2.0 i 4x4, 2.0 i 4x4 KAT, 2.0 i KAT	09/88-11/95	20 NE, C 20 NE	1998	:14608701→	0-N101	TB [TE]
2.5 CD 4x4, 2.5 V6	08/92-11/95	C 25 XE	2498		0-N957	TB [DG]
2000 16V 4x4, 2000/GT 16V, 2000/GT 16V 4x4 KAT, 2000/GT 16V KAT	01/89-11/95	20 XEJ, C 20 XE	1998	:14142839→	0-N100	TB [TE]
2000 16V 4x4, 2000/GT 16V, 2000/GT 16V 4x4 KAT, 2000/GT 16V KAT	01/89-11/95	20 XEJ, C 20 XE	1998	:14142838	0-N876	TB [DG]
2000 16V 4x4, 2000/GT 16V, 2000/GT 16V 4x4 KAT, 2000/GT 16V KAT	01/89-11/95	20 XEJ, C 20 XE	1998	:14142838	0-N877	TB [TE]
2000 16V 4x4, 2000/GT 16V, 2000/GT 16V 4x4 KAT, 2000/GT 16V KAT	01/89-11/95	20 XEJ, C 20 XE	1998	:14142839→	0-N906	TB [DG]

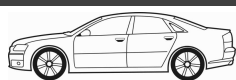

CM³



Art. Nr.



ohne Halter

VECTRA A (86_, 87_)							
2000 16V 4x4, 2000/GT 16V, 2000/GT 16V 4x4 KAT, 2000/GT 16V KAT	01/89-11/95	20 XEJ, C 20 XE	1998	:14142839→	0-N907	TB [DG]	
1.4 S	09/88-06/92	14 NV	1389	:19307806→	0-N948	TB [TE]	
1.6	08/92-07/93	C 16 LZ2	1598		0-N1422	VB [BT]	S
1.6 i	09/88-11/95	C 16 NZ, C 16 NZ2, E 16 NZ	1598		0-N1322	VB [TE]	S
1.6 i	09/93-11/95	X 16 SZ	1598	ch.P1000001, P5000001, P7000001→	0-N1322	VB [TE]	S
1.6, 1.6 i	09/88-11/95	16 SV, C 16 NZ, C 16 NZ2, E 16 NZ, X 16 SZ	1598	:02J22350→	0-N948	TB [TE]	
1.8 i KAT, 1.8 S, 1.8 S 4x4	09/88-11/95	18 SV, C 18 NZ, E 18 NVR	1796		0-N1422	VB [BT]	S
2.0 i, 2.0 i 16V, 2.0 i 16V 4x4, 2.0 i 4x4, 2.0 i 4x4 KAT, 2.0 i KAT, 2.0 i Turbo 4x4, 2000 16V 4x4, 2000/GT 16V, 2000/GT 16V 4x4 KAT, 2000/GT 16V KAT	09/88-11/95	20 NE, 20 SEH, 20 XEJ, C 20 LET, C 20 NE, C 20 XE, X 20 XEV	1998		0-N1422	VB [BT]	S
2.5 CD 4x4	08/92-08/95	C 25 XE	2498	Rippenanzahl: 6;	0-N1438	VB [BT]	S
2.5 V6	02/93-11/95	C 25 XE	2498	Rippenanzahl: 6	0-N1438	VB [BT]	S
2.5 V6	02/93-11/95	C 25 XE	2498		0-N1603	VB [DG]	
VECTRA A CC (88_, 89_)							
1.4 S	04/88-06/92	14 NV	1389	17x111; :19307806→; mit Zubehör	SK-1162	BTK	
1.4 S	04/88-06/92	14 NV	1389	17x111; 08/1988 →; :02J22350, 19307806→; mit Zubehör	SK-1162AQ1	BTKW	
1.6 i KAT	09/88-11/95	C16NZ	1598	17x111; :02J22350→; mit Zubehör	SK-1162	BTK	
1.6 i KAT	09/88-11/95	C16NZ	1598	17x111; :02J22350, 19307806→; mit Zubehör	SK-1162AQ1	BTKW	
1.6 i, 1.6 i KAT	09/88-11/95	C16NZ2	1598	20x146	SK-1169	BTK	
1.6 i, 1.6 i KAT	09/88-11/95	C16NZ2	1598	20x146	SK-1169AQ1	BTKW	
1.6 i, 1.6 S	09/88-11/95	16 LZ2, 16 SV, X 16 SZ	1598	17x111; :02J22350, 19307806→; mit Zubehör	SK-1162	BTK	
1.6 i, 1.6 S	09/88-11/95	16 LZ2, 16 SV, X 16 SZ	1598	17x111; :02J22350, 19307806→; mit Zubehör	SK-1162AQ1	BTKW	
1.7 D	09/88-09/92	17 D	1700	24x146	SK-1037	BTK	
1.7 D	09/88-09/92	17 D	1700	24x146; →14333430	SK-1037AQ1	BTKW	
1.7 D	09/88-11/95	17 D, 17 DR	1700	24x176; :14363651→	SK-1038	BTK	
1.7 D	09/88-11/95	17 D, 17 DR	1700	24x176; :14363651→	SK-1038AQ1	BTKW	
1.7 D	07/92-11/95	17 DR	1700	24x146; →14363650	SK-1037	BTK	
1.7 D	07/92-11/95	17 DR	1700	24x146; →14363650	SK-1037AQ1	BTKW	
1.7 TD	03/90-11/95	17 DT (TC4EE1), X 17 DT (TC4EE1)	1686	25.4x136; 08/1992 →; :→551390; mit Zubehör	SK-1164	BTK	
1.7 TD	03/90-11/95	17 DT (TC4EE1), X 17 DT (TC4EE1)	1686	25x136; 08/1992 →; :551391→; mit Zubehör	SK-1168	BTK	
1.8 i, 1.8 i KAT	09/88-11/95	C 18 NZ	1796	20x146; :14254439→	SK-1169AQ1	BTKW	
1.8 i, 1.8 i KAT, 1.8 S	09/88-11/95	18 SV, C 18 NZ, E 18 NVR	1796	20x111; →14142838	R-1072AQ1	BTKW	
1.8 i, 1.8 i KAT, 1.8 S	09/88-11/95	18 SV, C 18 NZ, E 18 NVR	1796	20x146; :14142839→	SK-1169	BTK	
1.8 i, 1.8 i KAT, 1.8 S	09/88-11/95	18 SV, C 18 NZ, E 18 NVR	1796	20x146; :14270601→	SK-1169AQ1	BTKW	
2.0	04/88-09/89	C 20 NEF	1998	20x111; 08/1988 →; :→14142838	R-1072AQ1	BTKW	
2.0 i 16V	02/89-10/90	20 XEJ	1998	24x141; →14142838	SK-1163	BTK	
2.0 i 16V	06/94-11/95	X 20 XEV	1998	24x169	SK-1100	BTK	
2.0 i 16V	06/94-11/95	X 20 XEV	1998	24x169	SK-1100AQ1	BTKW	
2.0 i 16V KAT	02/90-11/95	C 20 XE	1998	24x141	SK-1163	BTK	
2.0 i 16V, 2.0 i 16V KAT	02/89-11/95	20 XEJ, C 20 XE	1998	24x176; :14142839→	SK-1165	BTK	
2.0 i, 2.0 i GT, 2.0 i KAT	09/88-11/95	20 NE, 20 SEH, C 20 NE	1998	20x111; →14142838	R-1072AQ1	BTKW	
2.0, 2.0 i, 2.0 i GT, 2.0 i KAT	04/88-11/95	20 NE, 20 SEH, C 20 NE, C 20 NEF	1998	20x146; :14142839→	SK-1169	BTK	
2.0, 2.0 i, 2.0 i GT, 2.0 i KAT	04/88-11/95	20 NE, 20 SEH, C 20 NE, C 20 NEF	1998	20x146; :14142839→	SK-1169AQ1	BTKW	
2.5 V6	02/93-11/95	C 25 XE	2498	30x225; mit Zubehör	SK-1508	BTK	
1.6 i KAT	09/88-11/95	C16NZ2	1598		0-N101	TB [TE]	
1.6, 1.6 i	08/92-11/95	16 LZ2, C 16 LZ2	1598		0-N101	TB [TE]	
1.7 D	09/88-09/92	17 D	1700		0-N875	TB [DG]	
1.7 D	07/92-11/95	17 DR	1700		0-N100	TB [TE]	
1.7 D	07/92-11/95	17 DR	1700		0-N909	TB [DG]	
1.7 TD	03/90-11/95	17 DT (TC4EE1), X 17 DT (TC4EE1)	1686	:855806→	0-N126	TB [TE]	
1.7 TD	03/90-11/95	17 DT (TC4EE1), X 17 DT (TC4EE1)	1686		0-N878	TB [DG]	
1.7 TD	03/90-11/95	17 DT (TC4EE1), X 17 DT (TC4EE1)	1686	:→855805	0-N910	TB [TE]	
1.8 i, 1.8 i KAT	09/88-11/95	18 SV, C 18 NZ	1796	:14142839→	0-N101	TB [TE]	
1.8 S	09/88-07/89	E 18 NVR	1796		0-N101	TB [TE]	
2.0 i 16V	06/94-11/95	X 20 XEV	1998		0-N100	TB [TE]	
2.0 i 16V	06/94-11/95	X 20 XEV	1998		0-N906	TB [DG]	
2.0 i 16V, 2.0 i 16V KAT	02/89-11/95	20 XEJ, C 20 XE	1998	:14142839→	0-N100	TB [TE]	
2.0 i 16V, 2.0 i 16V KAT	02/89-11/95	20 XEJ, C 20 XE	1998	:→14142838	0-N876	TB [DG]	
2.0 i 16V, 2.0 i 16V KAT	02/89-11/95	20 XEJ, C 20 XE	1998	:→14142838	0-N877	TB [TE]	



CM³



Art. Nr.



ohne Halter

VECTRA C Caravan

1.6	01/06-	Z 16 XEP	1598	24x146; 10/2006 →	SK-1607	BTK	
1.6 16V	06/04-	Z 16 XE	1598	20x162; mit Zubehör	SK-1355	BTK	
1.6 16V	06/04-	Z 16 XE	1598	20x162; mit Zubehör	SK-1355AQ2	BTKW	
1.8	10/03-	Z 18 XE	1796	20x162; mit Zubehör	SK-1355	BTK	
1.8	10/03-	Z 18 XE	1796	20x162; mit Zubehör	SK-1355AQ1	BTKW	
1.8	01/06-	Z 18 XER	1796	24x146	SK-1607	BTK	
1.9 CDTI	04/04-	Z 19 DTH	1910	24x199	SK-1586	BTK	
1.9 CDTI	04/04-	Z 19 DTH	1910	24x199	SK-1586AQ1	BTKW	
1.9 CDTI	04/04-	Z 19 DT, Z 19 DTL	1910	24x190; → 08/2008	SK-1696	BTK	
1.9 CDTI	04/04-	Z 19 DT, Z 19 DTL	1910	24x190	SK-1696AQ1	BTKW	
3.0 V6 CDTI	10/03-	Y 30 DT	2958	25x116	SK-1611	BTK	
3.0 V6 CDTI	08/05-	Z 30 DT	2958	25x116; → 08/2008	SK-1611	BTK	
1.6	01/06-	Z 16 XEP	1598		0-N1347	TB [TE]	
1.6	01/06-	Z 16 XEP	1598		0-N1348	TB [DG]	
1.6 16V	06/04-	Z 16 XE	1598		0-N102	TB [TE]	
1.6 16V	06/04-	Z 16 XE	1598	†; mit Anbaumaterial	0-N300	TB [DG]	
1.6 16V	06/04-	Z 16 XE	1598		0-N953	TB [DG]	
1.8	10/03-	Z 18 XE	1796		0-N102	TB [TE]	
1.8	10/03-	Z 18 XE	1796	†; mit Anbaumaterial	0-N300	TB [DG]	
1.8	10/03-	Z 18 XE	1796		0-N953	TB [DG]	
1.8	01/06-	Z 18 XER	1796		0-N1347	TB [TE]	
1.8	01/06-	Z 18 XER	1796		0-N1348	TB [DG]	
1.9 CDTI	04/04-	Z 19 DT, Z 19 DTH, Z 19 DTL	1910		0-N115	TB [TE]	
1.9 CDTI	04/04-	Z 19 DT, Z 19 DTH, Z 19 DTL	1910		0-N2149	TB [DG]	
3.0 V6 CDTI	10/03-	Y 30 DT, Z 30 DT	2958		0-N1353	TB [TE]	
3.0 V6 CDTI	10/03-	Y 30 DT, Z 30 DT	2958		0-N1354	TB [DG]	
3.0 V6 CDTI	10/03-	Y 30 DT, Z 30 DT	2958		0-N1355	TB [DG]	
1.6	01/06-	Z 16 XEP	1598		0-N1799	VB [BT]	S
1.6 16V	06/04-	Z 16 XE	1598		0-N1466	VB [BT]	S
1.8	10/03-	Z 18 XE	1796		0-N1466	VB [BT]	S
1.8	01/06-	Z 18 XER	1796		0-N1799	VB [BT]	S
1.9 CDTI	04/04-	Z 19 DT, Z 19 DTH, Z 19 DTL	1910	☞: →71111927	0-N1503	VB [BT]	S
1.9 CDTI	04/04-	Z 19 DT, Z 19 DTH, Z 19 DTL	1910	☞: →71111927; ☞	0-N1522	VB [DG]	
1.9 CDTI	04/04-	Z 19 DT, Z 19 DTH, Z 19 DTL	1910	Rippenanzahl: 6	0-N1667	VB [DG]	
1.9 CDTI	04/04-	Z 19 DT, Z 19 DTH, Z 19 DTL	1910	☞:71111928→	0-N2030	VB [BT]	S
2.0 DTI	10/03-	Y 20 DTH	1995	Rippenanzahl: 6	0-N1437	VB [DG]	
2.0 DTI	10/03-	Y 20 DTH	1995		0-N1485	VB [BT]	S
2.0 DTI	10/03-	Y 20 DTH	1995		0-N2169	VB [VD]	
2.0 Turbo	10/03-	Z 20 NET	1998		0-N1588	VB [BT]	S
2.2 direct	10/03-	Z 22 YH	2198		0-N1588	VB [BT]	S
2.2 DTI	10/03-	Y 22 DTR	2172	Rippenanzahl: 6	0-N1437	VB [DG]	
2.2 DTI	10/03-	Y 22 DTR	2172		0-N1485	VB [BT]	S
2.2 DTI	10/03-	Y 22 DTR	2172		0-N2169	VB [VD]	
2.8 V6 Turbo	08/05-	Z 28 NEL, Z 28 NET	2792		0-N2194	VB [BT]	S
3.0 V6 CDTI	10/03-	Y 30 DT, Z 30 DT	2958	Rippenanzahl: 6	0-N1461	VB [DG]	
3.0 V6 CDTI	10/03-	Y 30 DT, Z 30 DT	2958		0-N1633	VB [DG]	
3.0 V6 CDTI	10/03-	Y 30 DT, Z 30 DT	2958	☞	0-N1649	VB [DG]	
3.0 V6 CDTI	10/03-	Y 30 DT, Z 30 DT	2958		0-N1717	VB [BT]	S
3.2 V6	10/03-	Z 32 SE	3175	Rippenanzahl: 6	0-N1437	VB [DG]	
3.2 V6	10/03-	Z 32 SE	3175	Rippenanzahl: 6	0-N1438	VB [BT]	S

VECTRA C GTS

1.6	08/05-	Z 16 XE	1598	20x162; mit Zubehör	SK-1355	BTK	
1.6	08/05-	Z 16 XE	1598	20x162; mit Zubehör	SK-1355AQ2	BTKW	
1.6	01/06-	Z 16 XEP	1598	24x146	SK-1607	BTK	
1.8	01/06-	Z 18 XER	1796	24x146	SK-1607	BTK	
1.8 16V	08/02-12/06	Z 18 XE, Z 18 XEL	1796	20x162; mit Zubehör	SK-1355	BTK	
1.8 16V	08/02-	Z 18 XE	1796	20x162; mit Zubehör	SK-1355AQ1	BTKW	
1.8 16V	08/02-12/06	Z 18 XEL	1796	20x162; → 07/2004; mit Zubehör	SK-1355AQ1	BTKW	
1.9 CDTI	04/04-	Z 19 DTH	1910	24x199	SK-1586	BTK	
1.9 CDTI	04/04-	Z 19 DTH	1910	24x199	SK-1586AQ1	BTKW	
1.9 CDTI	04/04-	Z 19 DT, Z 19 DTL	1910	24x190; → 08/2008	SK-1696	BTK	
1.9 CDTI	04/04-	Z 19 DT, Z 19 DTL	1910	24x190	SK-1696AQ1	BTKW	
3.0 CDTI	06/03-	Y 30 DT	2958	25x116	SK-1611	BTK	
3.0 CDTI	08/05-	Z 30 DT	2958	25x116; → 08/2008	SK-1611	BTK	
1.6	08/05-	Z 16 XE	1598		0-N102	TB [TE]	



CM³



Art. Nr.



VECTRA C GTS

1.6	08/05-	Z 16 XE	1598	†; mit Anbaumaterial	0-N300	TB [DG]	
1.6	08/05-	Z 16 XE	1598		0-N953	TB [DG]	
1.6	01/06-	Z 16 XEP	1598		0-N1347	TB [TE]	
1.6	01/06-	Z 16 XEP	1598		0-N1348	TB [DG]	
1.8	01/06-	Z 18 XER	1796		0-N1347	TB [TE]	
1.8	01/06-	Z 18 XER	1796		0-N1348	TB [DG]	
1.8 16V	08/02-12/06	Z 18 XE, Z 18 XEL	1796		0-N102	TB [TE]	
1.8 16V	08/02-12/06	Z 18 XE, Z 18 XEL	1796	†; mit Anbaumaterial	0-N300	TB [DG]	
1.8 16V	08/02-12/06	Z 18 XE, Z 18 XEL	1796		0-N953	TB [DG]	
1.9 CDTI	04/04-	Z 19 DT, Z 19 DTH, Z 19 DTL	1910		0-N115	TB [TE]	
1.9 CDTI	04/04-	Z 19 DT, Z 19 DTH, Z 19 DTL	1910		0-N2149	TB [DG]	
3.0 CDTI	06/03-	Y 30 DT, Z 30 DT	2958		0-N1353	TB [TE]	
3.0 CDTI	06/03-	Y 30 DT, Z 30 DT	2958		0-N1354	TB [DG]	
3.0 CDTI	06/03-	Y 30 DT, Z 30 DT	2958		0-N1355	TB [DG]	
1.6	08/05-	Z 16 XE	1598		0-N1466	VB [BT]	S
1.6	01/06-	Z 16 XEP	1598		0-N1799	VB [BT]	S
1.8	01/06-	Z 18 XER	1796		0-N1799	VB [BT]	S
1.8 16V	08/02-12/06	Z 18 XE, Z 18 XEL	1796		0-N1466	VB [BT]	S
1.9 CDTI	04/04-	Z 19 DT, Z 19 DTH, Z 19 DTL	1910	→ 71111927	0-N1503	VB [BT]	S
1.9 CDTI	04/04-	Z 19 DT, Z 19 DTH, Z 19 DTL	1910	→ 71111927; ⚡	0-N1522	VB [DG]	
1.9 CDTI	04/04-	Z 19 DT, Z 19 DTH, Z 19 DTL	1910	Rippenanzahl: 6	0-N1667	VB [DG]	
1.9 CDTI	04/04-	Z 19 DT, Z 19 DTH, Z 19 DTL	1910	→ 71111928	0-N2030	VB [BT]	S
2.0 16V Turbo	03/03-	Z 20 NET	1998		0-N1588	VB [BT]	S
2.0 DTI 16V	08/02-	Y 20 DTH	1995	Rippenanzahl: 6	0-N1437	VB [DG]	
2.0 DTI 16V	08/02-	Y 20 DTH	1995		0-N1485	VB [BT]	S
2.0 DTI 16V	08/02-	Y 20 DTH	1995		0-N2169	VB [VD]	
2.2 16V, 2.2 direct	08/02-	Z 22 SE, Z 22 YH	2198		0-N1588	VB [BT]	S
2.2 DTI 16V	08/02-	Y 22 DTR	2172	Rippenanzahl: 6	0-N1437	VB [DG]	
2.2 DTI 16V	08/02-	Y 22 DTR	2172		0-N1485	VB [BT]	S
2.2 DTI 16V	08/02-	Y 22 DTR	2172		0-N2169	VB [VD]	
2.8 V6 Turbo	08/05-	Z 28 NEL, Z 28 NET	2792		0-N2194	VB [BT]	S
3.0 CDTi	06/03-	Y 30 DT, Z 30 DT	2958	Rippenanzahl: 6	0-N1461	VB [DG]	
3.0 CDTi	06/03-	Y 30 DT, Z 30 DT	2958		0-N1633	VB [DG]	
3.0 CDTI	06/03-	Y 30 DT, Z 30 DT	2958	⚡	0-N1649	VB [DG]	
3.0 CDTI	06/03-	Y 30 DT, Z 30 DT	2958		0-N1717	VB [BT]	S
3.2 V6	08/02-	Z 32 SE	3175	Rippenanzahl: 6	0-N1437	VB [DG]	
3.2 V6	08/02-	Z 32 SE	3175	Rippenanzahl: 6	0-N1438	VB [BT]	S

VIVARO Combi (J7)

1.9 DI	08/01-	F9Q 762	1870	26x132	SK-1493	BTK	
1.9 DI, 1.9 DTI	08/01-	F9Q 760, F9Q 762, F9Q 774	1870	26x132	SK-1493AQ1	BTKW	
1.9 DI, 1.9 DTI	08/01-	F9Q 760, F9Q 762, F9Q 774	1870	26x132	SK-1493AQ2	BTKW	
1.9 DTI	08/01-	F9Q 760	1870	26x132	SK-1493	BTK	
2.0 16V, 2.0 ECOTEC	08/01-	F4R 720, F4R 820	1998	27x126	SK-1624	BTK	
2.5 CDTI	08/06-	G9U 630	2464	25x89; mit Zubehör	SK-1489	BTK	
2.5 CDTI, 2.5 DTI	05/03-	G9U 630, G9U 730	2463	25x89; mit Zubehör	SK-1489	BTK	
1.9 DI, 1.9 DTI	08/01-	F9Q 760, F9Q 762, F9Q 774	1870	mit Grundträger	0-N1173	TB [BT]	
2.0 16V, 2.0 ECOTEC	08/01-	F4R 720, F4R 820	1998		0-N1365	TB [DG]	
2.5 CDTI	08/06-	G9U 630	2464		0-N1269	TB [TE]	
2.5 CDTI	08/06-	G9U 630	2464		0-N1270	TB [DG]	
2.5 CDTI, 2.5 DTI	05/03-	G9U 630, G9U 730	2463		0-N1269	TB [TE]	
2.5 CDTI, 2.5 DTI	05/03-	G9U 630, G9U 730	2463		0-N1270	TB [DG]	
1.9 DI, 1.9 DTI	08/01-	F9Q 760, F9Q 762, F9Q 774	1870	→ 02/2002	0-N1307	VB [DG]	
1.9 DI, 1.9 DTI	08/01-	F9Q 760, F9Q 762, F9Q 774	1870	02/2002 →	0-N1409	VB [DG]	
1.9 DI, 1.9 DTI	08/01-	F9Q 760, F9Q 762, F9Q 774	1870	⚡	0-N1611	VB [BT]	S
1.9 DI, 1.9 DTI	08/01-	F9Q 760, F9Q 762, F9Q 774	1870	Rippenanzahl: 6; ⚡	0-N1648	VB [DG]	
1.9 DI, 1.9 DTI	08/01-	F9Q 760, F9Q 762, F9Q 774	1870	⚡	0-N1802	VB [BT]	S
2.0 16V	08/01-	F4R 720	1998	→ 02/2002	0-N1307	VB [DG]	
2.0 16V	08/01-	F4R 720	1998	02/2002 →	0-N1409	VB [DG]	
2.0 16V, 2.0 ECOTEC	08/01-	F4R 720, F4R 820	1998	⚡	0-N1611	VB [BT]	S
2.0 16V, 2.0 ECOTEC	08/01-	F4R 720, F4R 820	1998	⚡	0-N1802	VB [BT]	S
2.0 CDTI	08/06-	M9R 630, M9R 692, M9R 780, M9R 784, M9R 786, M9R 788, M9R 780, M9R 782, M9R 786	1995		0-N1739	VB [DG]	
2.0 CDTI	08/06-	M9R 630, M9R 692, M9R 780, M9R 784, M9R 786, M9R 788, M9R 780, M9R 782, M9R 786	1995		0-N2039	VB [BT]	S



CM³



Art. Nr.



VIVARO Combi (J7)							
2.0 ECOTEC	08/06-	F4R 820	1998	✳		0-N1409	VB [DG]
2.5 CDTI	08/06-	G9U 630	2464	✳		0-N1409	VB [DG]
2.5 CDTI	08/06-	G9U 630	2464	✳		0-N1731	VB [BT] S
2.5 CDTI	08/06-	G9U 630	2464	✳		0-N1875	VB [BT] S
2.5 CDTI, 2.5 DTI	05/03-	G9U 630, G9U 730	2463	✳		0-N1409	VB [DG]
2.5 CDTI, 2.5 DTI	05/03-	G9U 630, G9U 730	2463	✳		0-N1731	VB [BT] S
2.5 CDTI, 2.5 DTI	05/03-	G9U 630, G9U 730	2463	✳		0-N1875	VB [BT] S
2.5 DTI	05/03-	G9U 730	2463		Rippenanzahl: 6; ✳	0-N1648	VB [DG]

VIVARO Kasten (F7)							
1.9 Di, 1.9 DTI	08/01-	F9Q 760, F9Q 762	1870		26x132	SK-1493	BTK
1.9 Di, 1.9 DTI	08/01-	F9Q 760, F9Q 762	1870		26x132	SK-1493AQ1	BTKW
1.9 Di, 1.9 DTI	08/01-	F9Q 760, F9Q 762	1870		26x132	SK-1493AQ2	BTKW
2.0 16V, 2.0 ECOTEC	08/01-	F4R 720, F4R 820	1998		27x126	SK-1624	BTK
2.5 CDTI	08/06-	G9U 630	2464		25x89; mit Zubehör	SK-1489	BTK
2.5 CDTI, 2.5 DTI	05/03-	G9MB6, G9U 630, G9U 730	2463		25x89; mit Zubehör	SK-1489	BTK
1.9 Di, 1.9 DTI	08/01-	F9Q 760, F9Q 762	1870		mit Grundträger	0-N1173	TB [BT]
2.0 16V, 2.0 ECOTEC	08/01-	F4R 720, F4R 820	1998			0-N1365	TB [DG]
2.5 CDTI	08/06-	G9U 630	2464			0-N1269	TB [TE]
2.5 CDTI	08/06-	G9U 630	2464			0-N1270	TB [DG]
2.5 CDTI, 2.5 DTI	05/03-	G9MB6, G9U 630, G9U 730	2463			0-N1269	TB [TE]
2.5 CDTI, 2.5 DTI	05/03-	G9MB6, G9U 630, G9U 730	2463			0-N1270	TB [DG]
1.9 Di, 1.9 DTI	08/01-	F9Q 760, F9Q 762	1870		→ 02/2002	0-N1307	VB [DG]
1.9 Di, 1.9 DTI	08/01-	F9Q 760, F9Q 762	1870		02/2002 →	0-N1409	VB [DG]
1.9 Di, 1.9 DTI	08/01-	F9Q 760, F9Q 762	1870	✳		0-N1611	VB [BT] S
1.9 Di, 1.9 DTI	08/01-	F9Q 760, F9Q 762	1870		Rippenanzahl: 6; ✳	0-N1648	VB [DG]
1.9 Di, 1.9 DTI	08/01-	F9Q 760, F9Q 762	1870	✳		0-N1802	VB [BT] S
2.0 16V	08/01-	F4R 720	1998		→ 02/2002	0-N1307	VB [DG]
2.0 16V	08/01-	F4R 720	1998		02/2002 →	0-N1409	VB [DG]
2.0 16V, 2.0 ECOTEC	08/01-	F4R 720, F4R 820	1998	✳		0-N1611	VB [BT] S
2.0 16V, 2.0 ECOTEC	08/01-	F4R 720, F4R 820	1998	✳		0-N1802	VB [BT] S
2.0 CDTI	08/06-	M9R 630, M9R 780, M9R 782, M9R 786, M9R 692, M9R 780, M9R 784, M9R 786, M9R 788	1995			0-N1739	VB [DG]
2.0 CDTI	08/06-	M9R 630, M9R 780, M9R 782, M9R 786, M9R 692, M9R 780, M9R 784, M9R 786, M9R 788	1995			0-N2039	VB [BT] S
2.0 ECOTEC	08/06-	F4R 820	1998	✳		0-N1409	VB [DG]
2.5 CDTI	08/06-	G9U 630	2464			0-N1409	VB [DG]
2.5 CDTI	08/06-	G9U 630	2464	✳		0-N1731	VB [BT] S
2.5 CDTI	08/06-	G9U 630	2464	✳		0-N1875	VB [BT] S
2.5 CDTI, 2.5 DTI	05/03-	G9MB6, G9U 630, G9U 730	2463			0-N1409	VB [DG]
2.5 CDTI, 2.5 DTI	05/03-	G9MB6, G9U 630, G9U 730	2463	✳		0-N1731	VB [BT] S
2.5 CDTI, 2.5 DTI	05/03-	G9MB6, G9U 630, G9U 730	2463	✳		0-N1875	VB [BT] S
2.5 DTI	05/03-	G9U 730	2463		Rippenanzahl: 6; ✳	0-N1648	VB [DG]

VIVARO Pritsche/Fahrgestell (E7)							
1.9 Di, 1.9 DTI	08/06-	F9Q 760, F9Q 762	1870		26x132	SK-1493	BTK
1.9 Di, 1.9 DTI	08/06-	F9Q 760, F9Q 762	1870		26x132	SK-1493AQ1	BTKW
1.9 DTI	08/06-	F9Q 760	1870		26x132	SK-1493AQ2	BTKW
2.0 16V, 2.0 ECOTEC	08/06-	F4R 720, F4R 820	1998		27x126	SK-1624	BTK
2.5 CDTI	08/06-	G9U 630	2464		25x89; mit Zubehör	SK-1489	BTK
2.5 CDTI, 2.5 DTI	08/06-	G9U 630, G9U 730	2463		25x89; mit Zubehör	SK-1489	BTK
1.9 Di, 1.9 DTI	08/06-	F9Q 760, F9Q 762	1870		mit Grundträger	0-N1173	TB [BT]
2.0 16V, 2.0 ECOTEC	08/06-	F4R 720, F4R 820	1998			0-N1365	TB [DG]
2.5 CDTI	08/06-	G9U 630	2464			0-N1269	TB [TE]
2.5 CDTI	08/06-	G9U 630	2464			0-N1270	TB [DG]
2.5 CDTI, 2.5 DTI	08/06-	G9U 630, G9U 730	2463			0-N1269	TB [TE]
2.5 CDTI, 2.5 DTI	08/06-	G9U 630, G9U 730	2463			0-N1270	TB [DG]
1.9 Di, 1.9 DTI	08/06-	F9Q 760, F9Q 762	1870	✳		0-N1409	VB [DG]
1.9 Di, 1.9 DTI	08/06-	F9Q 760, F9Q 762	1870	✳		0-N1611	VB [BT] S
1.9 Di, 1.9 DTI	08/06-	F9Q 760, F9Q 762	1870		Rippenanzahl: 6	0-N1648	VB [DG]
1.9 Di, 1.9 DTI	08/06-	F9Q 760, F9Q 762	1870	✳		0-N1802	VB [BT] S
2.0 16V	08/06-	F4R 720	1998			0-N1409	VB [DG]
2.0 16V, 2.0 ECOTEC	08/06-	F4R 720, F4R 820	1998	✳		0-N1611	VB [BT] S
2.0 16V, 2.0 ECOTEC	08/06-	F4R 720, F4R 820	1998	✳		0-N1802	VB [BT] S
2.0 CDTI	01/06-	M9R 630, M9R 780, M9R 630, M9R 780, M9R 782, M9R 786	1995			0-N1739	VB [DG]



CM³



Art. Nr.



VIVARO Pritsche/Fahrgestell (E7)

2.0 CDTI	01/06-	M9R 630, M9R 780, M9R 630, M9R 780, M9R 782, M9R 786	1995		0-N2039	VB [BT]	S
2.0 ECOTEC	08/06-	F4R 820	1998	☼	0-N1409	VB [DG]	
2.5 CDTI	08/06-	G9U 630	2464		0-N1409	VB [DG]	
2.5 CDTI	08/06-	G9U 630	2464	☼	0-N1731	VB [BT]	S
2.5 CDTI	08/06-	G9U 630	2464	☼	0-N1875	VB [BT]	S
2.5 CDTI, 2.5 DTi	08/06-	G9U 630, G9U 730	2463		0-N1409	VB [DG]	
2.5 CDTI, 2.5 DTi	08/06-	G9U 630, G9U 730	2463	☼	0-N1731	VB [BT]	S
2.5 CDTI, 2.5 DTi	08/06-	G9U 630, G9U 730	2463	☼	0-N1875	VB [BT]	S
2.5 DTi	08/06-	G9U 730	2463		Rippenanzahl: 6	0-N1648	VB [DG]

ZAFIRA A (F75_)

1.6 16V	04/99-06/05	Z 16 LER	1598	20x162; 09/2002 →; mit Zubehör	SK-1113	BTK	
1.6 16V	04/99-06/05	X 16 XEL, Z 16 XE	1598	20x162; :→02HL5117, 20041690; mit Zubehör	SK-1113	BTK	
1.6 16V	04/99-06/05	X 16 XEL, Z 16 XE	1598	20x162; :→02HL5117, 20041690; mit Zubehör	SK-1113AQ1	BTKW	
1.6 16V	04/99-06/05	X 16 XEL, Z 16 XE	1598	20x162; :02HL5118, 20041691→; mit Zubehör	SK-1355	BTK	
1.6 16V	04/99-06/05	X 16 XEL, Z 16 XE	1598	20x162; :02MV7225, 20U75999→; mit Zubehör	SK-1355AQ2	BTKW	
1.6 16V	04/99-06/05	X 16 XEL, Z 16 XE	1598	20x162; :02HL5118, 20041691→; :→02MV7224	SK-1355AQ3	BTKW	
1.6 CNG	09/01-06/05	Z 16 YNG	1598	20x162; mit Zubehör	SK-1355	BTK	
1.6 CNG	09/01-06/05	Z 16 YNG	1598	20x162; mit Zubehör	SK-1355AQ2	BTKW	
1.8 16V	04/99-06/05	X 18 XE1, Z 18 XE	1796	20x162; :→02HL5117, 20041690; mit Zubehör	SK-1113AQ2	BTKW	
1.8 16V	09/00-06/05	Z 18 XE	1796	20x162; 09/2002 →; :→02HL5117, 20041690; mit Zubehör	SK-1113	BTK	
1.8, 1.8 16V	04/99-06/05	X 18 XE1, Z 18 XEL	1796	20x162; :→02HL5117, 20041690; mit Zubehör	SK-1113	BTK	
1.8, 1.8 16V	04/99-06/05	X 18 XE1, Z 18 XE, Z 18 XEL	1796	20x162; :02HL5118, 20041691→; mit Zubehör	SK-1355	BTK	
1.8, 1.8 16V	04/99-06/05	X 18 XE1, Z 18 XE, Z 18 XEL	1796	20x162; :02HL5118, 20041691→; mit Zubehör	SK-1355AQ1	BTKW	
2.0 OPC	09/01-06/05	Z 20 LET	1998	24x168; ch.→32999999, 35999999; 06/2002 →	SK-1632	BTK	
2.0 OPC	09/01-06/05	Z 20 LET	1998	24x168; ch.→36999999, 38999999; 06/2002 →	SK-1632	BTK	
2.0 OPC	09/01-06/05	Z 20 LET	1998	24x168; ch.→3B999999, 3H999999; 06/2002 →	SK-1632	BTK	
2.0 OPC	09/01-06/05	Z 20 LER, Z 20 LET, Z 20 LET	1998	24x168; ch.→32999999, 35999999	SK-1632AQ1	BTKW	
2.0 OPC	09/01-06/05	Z 20 LER, Z 20 LET, Z 20 LET	1998	24x168; ch.→36999999, 38999999	SK-1632AQ1	BTKW	
2.0 OPC	09/01-06/05	Z 20 LER, Z 20 LET, Z 20 LET	1998	24x168; ch.→3B999999, 3H999999	SK-1632AQ1	BTKW	
2.0 OPC	09/01-06/05	Z 20 LER, Z 20 LET, Z 20 LET	1998	24x168; ch.→3G999999	SK-1632AQ1	BTKW	
2.0 OPC	09/01-06/05	Z 20 LER, Z 20 LET, Z 20 LET	1998	24x168; ch.42000001, 45000001→	SK-1667	BTK	
2.0 OPC	09/01-06/05	Z 20 LER, Z 20 LET, Z 20 LET	1998	24x168; ch.48000001, 4B000001→	SK-1667	BTK	
2.0 OPC	09/01-06/05	Z 20 LER, Z 20 LET, Z 20 LET	1998	24x168; ch.4G000001, 4H000001→	SK-1667	BTK	
2.0 OPC	09/01-06/05	Z 20 LER, Z 20 LET, Z 20 LET	1998	24x168; ch.42000001, 45000001→	SK-1667AQ1	BTKW	
2.0 OPC	09/01-06/05	Z 20 LER, Z 20 LET, Z 20 LET	1998	24x168; ch.48000001, 4B000001→	SK-1667AQ1	BTKW	
2.0 OPC	09/01-06/05	Z 20 LER, Z 20 LET, Z 20 LET	1998	24x168; ch.4G000001, 4H000001→	SK-1667AQ1	BTKW	
2.0 OPC	11/02-06/05	Z 20 LER, Z 20 LET	1998	24x168; ch.→32999999, 35999999	SK-1632	BTK	
2.0 OPC	11/02-06/05	Z 20 LER, Z 20 LET	1998	24x168; ch.→36999999, 38999999	SK-1632	BTK	
2.0 OPC	11/02-06/05	Z 20 LER, Z 20 LET	1998	24x168; ch.→3B999999, 3H999999	SK-1632	BTK	
1.6 16V	04/99-06/05	X 16 XEL, Z 16 XE	1598	:02HL5118, 20041691→; ; mit Anbaumaterial	0-N300	TB [DG]	
1.6 16V	04/99-06/05	X 16 XEL, Z 16 XE	1598	:→02HL5117, 20041690	0-N952	TB [DG]	
1.6, 1.6 16V, 1.6 CNG	04/99-06/05	X 16 XEL, Z 16 XE, Z 16 YNG	1598		0-N102	TB [TE]	
1.6, 1.6 16V, 1.6 CNG	04/99-06/05	X 16 XEL, Z 16 XE, Z 16 YNG	1598		0-N953	TB [DG]	
1.6, 1.6 CNG	09/01-06/05	Z 16 YNG	1598	; mit Anbaumaterial	0-N300	TB [DG]	
1.8, 1.8 16V	04/99-06/05	X 18 XE1, Z 18 XE, Z 18 XEL	1796		0-N102	TB [TE]	
1.8, 1.8 16V	04/99-06/05	X 18 XE1, Z 18 XE, Z 18 XEL	1796	:02HL5118, 20041691→; ; mit Anbaumaterial	0-N300	TB [DG]	
1.8, 1.8 16V	04/99-06/05	X 18 XE1, Z 18 XE, Z 18 XEL	1796	:→02HL5117, 20041690	0-N952	TB [DG]	
1.8, 1.8 16V	04/99-06/05	X 18 XE1, Z 18 XE, Z 18 XEL	1796		0-N953	TB [DG]	
2.0 OPC	09/01-06/05	Z 20 LER, Z 20 LET, Z 20 LET	1998	→ 12/2003	0-N127	TB [DG]	
2.0 OPC	09/01-06/05	Z 20 LER, Z 20 LET, Z 20 LET	1998	01/2004 →	0-N127	TB [DG]	
2.0 OPC	09/01-06/05	Z 20 LER, Z 20 LET, Z 20 LET	1998		0-N1369	TB [TE]	
2.0 OPC	09/01-06/05	Z 20 LER, Z 20 LET, Z 20 LET	1998	01/2004 →	0-N1574	TB [DG]	
1.6, 1.6 16V, 1.6 CNG	04/99-06/05	X 16 XEL, Z 16 XE, Z 16 YNG	1598		0-N1466	VB [BT]	S



CM³



Art. Nr.



ohne Halter

ZAFIRA A (F75_)

1.8, 1.8 16V	04/99-06/05	X 18 XE1, Z 18 XE, Z 18 XEL	1796		0-N1466	VB [BT]	S
2.0 DI 16V, 2.0 DTI 16V	07/99-06/05	X 20 DTL, Y 20 DTH	1995	Rippenanzahl: 6	0-N1437	VB [DG]	
2.0 DI 16V, 2.0 DTI 16V	07/99-06/05	X 20 DTL, Y 20 DTH	1995		0-N2169	VB [VD]	
2.0 DI 16V, 2.0 DTI, 2.0 DTI 16V	07/99-06/05	X 20 DTL, X 20 DTL, X 20 DTL, Y 20 DTH	1995		0-N1485	VB [BT]	S
2.0 OPC	09/01-06/05	Z 20 LER, Z 20 LET, Z 20 LET	1998		0-N1422	VB [BT]	S
2.2 16V	09/00-06/05	Z 22 SE	2198		0-N1588	VB [BT]	S
2.2 DTI 16V	01/02-06/05	Y 22 DTR	2172	Rippenanzahl: 6	0-N1437	VB [DG]	
2.2 DTI 16V	01/02-06/05	Y 22 DTR	2172		0-N1485	VB [BT]	S
2.2 DTI 16V	01/02-06/05	Y 22 DTR	2172		0-N2169	VB [VD]	

ZAFIRA B (A05)

1.6	07/05-	Z 16 XE1, Z 16 XEP	1598	24x146	SK-1607	BTK	
1.6	01/08-	A 16 XER, Z 16 XER	1598	24x146	SK-1607	BTK	
1.6 CNG	01/06-	Z 16 YNG	1598	20x162; mit Zubehör	SK-1355	BTK	
1.6 CNG	01/06-	Z 16 YNG	1598	20x162; mit Zubehör	SK-1355AQ2	BTKW	
1.6 CNG Turbo	02/09-	A 16 XNT, Z 16 XNT	1598	24x146	SK-1607	BTK	
1.7 CDTI	01/08-	A 17 DTJ, Z 17 DTJ, A 17 DTR	1686	25x131; mit Zubehör	SK-1481	BTK	
1.8	07/05-	A 18 XER, Z 18 XER	1796	24x146	SK-1607	BTK	
1.9 CDTI	07/05-	Z 19 DTH	1910	24x199	SK-1586	BTK	
1.9 CDTI	07/05-	Z 19 DTH	1910	24x199; Baumuster: Van	SK-1586AQ1	BTKW	
1.9 CDTI	07/05-	Z 19 DT, Z 19 DTL	1910	24x190	SK-1696	BTK	
1.9 CDTI	07/05-	Z 19 DTL	1910	24x190	SK-1696AQ1	BTKW	
1.9 CDTI	07/05-	Z 19 DT	1910	24x190; Baumuster: Van	SK-1696AQ1	BTKW	
2.0	07/05-	Z 20 LER	1998	24x168; Baumuster: Van	SK-1667	BTK	
2.0	07/05-	Z 20 LER	1998	24x168; Baumuster: Van	SK-1667AQ1	BTKW	
2.0	01/06-	Z 20 LEH	1998	24x168	SK-1667	BTK	
2.0	01/06-	Z 20 LEH	1998	24x168	SK-1667AQ1	BTKW	
1.6 CNG	01/06-	Z 16 YNG	1598		0-N102	TB [TE]	
1.6 CNG	01/06-	Z 16 YNG	1598	†; mit Anbaumaterial	0-N300	TB [DG]	
1.6 CNG	01/06-	Z 16 YNG	1598		0-N953	TB [DG]	
1.6, 1.6 CNG Turbo	07/05-	A 16 XER, Z 16 XER, A 16 XNT, Z 16 XNT, Z 16 XE1, Z 16 XEP	1598		0-N1347	TB [TE]	
1.6, 1.6 CNG Turbo	07/05-	A 16 XER, Z 16 XER, A 16 XNT, Z 16 XNT, Z 16 XE1, Z 16 XEP	1598		0-N1348	TB [DG]	
1.7 CDTI	01/08-	A 17 DTJ, Z 17 DTJ	1686		0-N1085	TB [TE]	
1.7 CDTI	01/08-	A 17 DTR	1686		0-N1085	TB [TE]	
1.7 CDTI	01/08-	A 17 DTJ, Z 17 DTJ, A 17 DTR	1686		0-N878	TB [DG]	
1.8	07/05-	A 18 XEL, A 18 XER, Z 18 XER	1796		0-N1347	TB [TE]	
1.8	07/05-	A 18 XER, Z 18 XER	1796		0-N1348	TB [DG]	
1.9 CDTI	07/05-	Z 19 DT, Z 19 DTH, Z 19 DTL	1910		0-N115	TB [TE]	
1.9 CDTI	07/05-	Z 19 DT, Z 19 DTH, Z 19 DTL	1910		0-N2149	TB [DG]	
2.0	07/05-	Z 20 LEH, Z 20 LEL, Z 20 LER	1998		0-N127	TB [DG]	
2.0	07/05-	Z 20 LEH, Z 20 LEL, Z 20 LER	1998		0-N1369	TB [TE]	
2.0	07/05-	Z 20 LEH, Z 20 LEL, Z 20 LER	1998		0-N1574	TB [DG]	
1.6 CNG	01/06-	Z 16 YNG	1598		0-N1466	VB [BT]	S
1.6, 1.6 CNG Turbo	07/05-	A 16 XER, Z 16 XER, A 16 XNT, Z 16 XNT, Z 16 XE1, Z 16 XEP	1598		0-N1799	VB [BT]	S
1.7 CDTI	01/08-	A 17 DTJ, Z 17 DTJ, A 17 DTR	1686	✳	0-N1426	VB [DG]	
1.7 CDTI	01/08-	A 17 DTJ, Z 17 DTJ, A 17 DTR	1686		0-N1798	VB [BT]	S
1.8	07/05-	A 18 XER, Z 18 XER	1796		0-N1799	VB [BT]	S
1.9 CDTI	07/05-	Z 19 DT, Z 19 DTH, Z 19 DTL	1910	→71111927	0-N1503	VB [BT]	S
1.9 CDTI	07/05-	Z 19 DT, Z 19 DTH, Z 19 DTL	1910	→71111927; ✳	0-N1522	VB [DG]	
1.9 CDTI	07/05-	Z 19 DT, Z 19 DTH, Z 19 DTL	1910	Rippenanzahl: 6	0-N1667	VB [DG]	
1.9 CDTI	07/05-	Z 19 DT, Z 19 DTH, Z 19 DTL	1910	→71111928→	0-N2030	VB [BT]	S
2.0	07/05-	Z 20 LEH, Z 20 LEL, Z 20 LER	1998		0-N1422	VB [BT]	S
2.2	07/05-	Z 22 YH	2198		0-N1588	VB [BT]	S

ZAFIRA B Van

1.6 CNG Turbo	02/09-	A 16 XNT, Z 16 XNT	1598	24x146	SK-1607	BTK	
1.7 CDTI	01/08-	A 17 DTJ, Z 17 DTJ, A 17 DTR	1686	25x131; mit Zubehör	SK-1481	BTK	
1.8	07/05-	A 18 XER, Z 18 XER	1796	24x146	SK-1607	BTK	
1.6 CNG Turbo	02/09-	A 16 XNT, Z 16 XNT	1598		0-N1347	TB [TE]	
1.6 CNG Turbo	02/09-	A 16 XNT, Z 16 XNT	1598		0-N1348	TB [DG]	
1.7 CDTI	01/08-	A 17 DTJ, Z 17 DTJ	1686		0-N1085	TB [TE]	
1.7 CDTI	01/08-	A 17 DTR	1686		0-N1085	TB [TE]	
1.7 CDTI	01/08-	A 17 DTJ, Z 17 DTJ, A 17 DTR	1686		0-N878	TB [DG]	
1.8	07/05-	A 18 XER, Z 18 XER	1796		0-N1347	TB [TE]	



CM³



Art. Nr.



ohne Halter

ZAFIRA B Van

1.8	07/05-	A 18 XER, Z 18 XER	1796		0-N1348	TB [DG]	
1.6 CNG Turbo	02/09-	A 16 XNT, Z 16 XNT	1598		0-N1799	VB [BT]	S
1.7 CDTi	01/08-	A 17 DTJ, Z 17 DTJ, A 17 DTR	1686	✳	0-N1426	VB [DG]	
1.7 CDTi	01/08-	A 17 DTJ, Z 17 DTJ, A 17 DTR	1686		0-N1798	VB [BT]	S
1.8	07/05-	A 18 XER, Z 18 XER	1796		0-N1799	VB [BT]	S

ZAFIRA TOURER C (P12)

1.6 CNG	10/11-	A 16 XNT, B 16 XNT	1598	24x146	SK-1607	BTK	
1.8, 1.8 LPG	10/11-	A 18 XEL, A 18 XER	1796	24x146	SK-1607	BTK	
2.0 CDTi	10/11-	A 20 DT, Y 20 DTJ, Z 20 DTJ, A 20 DTH, A 20 DTL	1956	24x199	SK-1586	BTK	
2.0 CDTi	10/11-	A 20 DT, Y 20 DTJ, Z 20 DTJ, A 20 DTH, A 20 DTL	1956	24x199	SK-1586AQ1	BTKW	
1.6 CNG	10/11-	A 16 XNT, B 16 XNT	1598		0-N1347	TB [TE]	
1.6 CNG	10/11-	A 16 XNT, B 16 XNT	1598		0-N1348	TB [DG]	
1.8, 1.8 LPG	10/11-	A 18 XEL, A 18 XER	1796		0-N1347	TB [TE]	
1.8, 1.8 LPG	10/11-	A 18 XEL, A 18 XER	1796		0-N1348	TB [DG]	
2.0 CDTi	10/11-	A 20 DT	1956		0-N115	TB [TE]	
2.0 CDTi	10/11-	A 20 DTH	1956		0-N115	TB [TE]	
2.0 CDTi	10/11-	Y 20 DTJ	1956		0-N115	TB [TE]	
2.0 CDTi	10/11-	Z 20 DTJ	1956		0-N115	TB [TE]	
2.0 CDTi, BiTurbo CDTi	10/11-	A 20 DT, Y 20 DTJ, Z 20 DTJ, A 20 DTH, A 20 DTL, A 20 DTR	1956		0-N2149	TB [DG]	
BiTurbo CDTi	01/13-	A 20 DTR	1956		0-N2236	TB [DG]	
1.4, 1.4 LPG	10/11-	A 14 NEL, B 14 NEL, A 14 NET, B 14 NET	1364		0-N2170	VB [BT]	S
1.6 CDTi	02/13-	B 16 DTH, B 16 DTH, B 16 DTJ	1598	✳	0-N1649	VB [DG]	
1.6 CNG	10/11-	A 16 XNT, B 16 XNT	1598		0-N1799	VB [BT]	S
1.8, 1.8 LPG	10/11-	A 18 XEL, A 18 XER	1796		0-N1799	VB [BT]	S
2.0 CDTi	10/11-	A 20 DT, Y 20 DTJ, Z 20 DTJ, A 20 DTH, A 20 DTL	1956		0-N1649	VB [DG]	
2.0 CDTi	10/11-	A 20 DT, Y 20 DTJ, Z 20 DTJ, A 20 DTH, A 20 DTL	1956		0-N2087	VB [BT]	S
2.0 CDTi, BiTurbo CDTi	10/11-	A 20 DT, Y 20 DTJ, Z 20 DTJ, A 20 DTH, A 20 DTL, A 20 DTR	1956		0-N2221	VB [DG]	
2.0 CDTi, BiTurbo CDTi	10/11-	A 20 DT, Y 20 DTJ, Z 20 DTJ, A 20 DTH, A 20 DTL, A 20 DTR	1956	für Fahrzeuge mit elektrischer Servolenkung	0-N2254	VB [DG]	
BiTurbo CDTi	01/13-	A 20 DTR	1956	✳	0-N1649	VB [DG]	

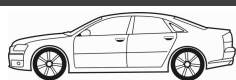

CM³



Art. Nr.



106 I (1A, 1C)

1.0	09/91-04/96	CDY (TU9M), TU9, CDZ (TU9M)	954	17x104	SK-1003	BTK	
1.0	09/91-04/96	CDZ (TU9M)	954	17x104	SK-1003AQ1	BTKW	
1.0	09/91-04/96	CDY (TU9M), TU9	954	17x104; 01/1992 →	SK-1003AQ1	BTKW	
1.1	09/91-04/96	HDZ (TU1M)	1124	17x104	SK-1003	BTK	
1.1	09/91-04/96	HDZ (TU1M)	1124	17x104; :→3762434	SK-1003AQ1	BTKW	
1.1	09/91-04/96	HDZ (TU1M)	1124	17x100; :3762434→	SK-1353	BTK	
1.3	10/93-04/96	TU2J2	1294	17x108	SK-1004	BTK	
1.3	10/93-04/96	TU2J2	1294	17x108	SK-1004AQ1	BTKW	
1.4	08/91-03/96	K5A (TU3)	1360	17x108	SK-1004	BTK	
1.4	08/91-03/96	K5A (TU3)	1360	17x108	SK-1004AQ1	BTKW	
1.4	08/91-03/96		1360	17x101	SK-1020	BTK	
1.4	08/91-03/96		1360	17x101	SK-1020AQ1	BTKW	
1.4	09/91-04/96	KDX (TU3MC), KDY (TU3M)	1361	17x108; ch.→50355042	SK-1004	BTK	
1.4	09/91-04/96	KFZ (TU3J2/Z)	1361	17x108; :→50355042	SK-1004	BTK	
1.4	09/91-04/96	KDX (TU3MC), KDY (TU3M)	1361	17x108; :→50355042	SK-1004AQ1	BTKW	
1.4	09/91-04/96	KFZ (TU3J2/Z)	1361	17x101	SK-1020	BTK	
1.4	09/91-04/96	KDX (TU3MC), KDY (TU3M)	1361	17x101; ch.50355043→	SK-1020	BTK	
1.4	09/91-04/96	KFZ (TU3J2/Z)	1361	17x101	SK-1020AQ1	BTKW	
1.4	09/91-04/96	TU3MC	1361	17x101; ch.50355043→	SK-1020AQ1	BTKW	
1.4 D	09/92-04/96	K9Y (TUD3Y)	1361	25x143	SK-1005	BTK	
1.5 D	06/94-04/96	VJY (TUD5)	1527	25.4x136	SK-1040	BTK	
1.5 D	06/94-04/96	VJY (TUD5)	1527	25.4x136	SK-1040AQ1	BTKW	
1.6	06/93-04/96	NFZ (TU5JP)	1587	17x101; 04/1994 →	SK-1020	BTK	
1.6	06/93-04/96	NFY (TU5J2), NFZ (TU5JP)	1587	17x101	SK-1020AQ1	BTKW	
1.6	01/94-04/96	NFY (TU5J2)	1587	17x101	SK-1020	BTK	
1.0	09/91-04/96	CDY (TU9M), TU9, CDZ (TU9M)	954		0-N811	TB [TE]	
1.1	09/91-04/96	HDZ (TU1M)	1124		0-N811	TB [TE]	
1.3	10/93-04/96	TU2J2	1294		0-N811	TB [TE]	
1.4	08/91-03/96	K5A (TU3)	1360		0-N811	TB [TE]	
1.4	09/91-04/96	KDX (TU3MC), KDY (TU3M), KFZ (TU3J2/Z)	1361		0-N811	TB [TE]	
1.4 D	09/92-04/96	K9Y (TUD3Y)	1361		0-N861	TB [TE]	
1.4 D	09/92-04/96	K9Y (TUD3Y)	1361		0-N862	TB [DG]	
1.5 D	06/94-04/96	VJY (TUD5)	1527		0-N861	TB [TE]	
1.5 D	06/94-04/96	VJY (TUD5)	1527		0-N862	TB [DG]	
1.6	06/93-04/96	NFY (TU5J2), NFZ (TU5JP)	1587		0-N811	TB [TE]	
1.4	08/91-03/96	K5A (TU3)	1360	mit Grundträger	0-N2337	VB [TE]	
1.4	09/91-04/96	KDX (TU3MC), KDY (TU3M), KFZ (TU3J2/Z)	1361	mit Grundträger	0-N2337	VB [TE]	
1.5 D	06/94-04/96	VJY (TUD5)	1527	für Fahrzeuge ohne Servolenkung	0-N133	VB [TE]	
1.5 D	06/94-04/96	VJY (TUD5)	1527		0-N2015	VB [BT]	
1.5 D	06/94-04/96	VJY (TUD5)	1527		0-N2174	VB [TE]	
1.6	06/93-04/96	NFY (TU5J2), NFZ (TU5JP)	1587		0-N125	VB [TE]	S

106 Van (1_)

1.0	09/91-03/01	CDY (TU9M), TU9	954	17x104	SK-1003	BTK	
1.0	09/91-03/01	CDY (TU9M), TU9	954	17x104	SK-1003AQ1	BTKW	
1.5 D	05/96-03/01	VJX (TUD5), VJY (TUD5)	1527	25.4x136	SK-1040	BTK	
1.5 D	05/96-03/01	VJX (TUD5), VJY (TUD5)	1527	25.4x136	SK-1040AQ1	BTKW	
1.5 D	10/00-03/01	VJX (TUD5)	1527	25x136	SK-1642	BTK	
1.5 D	10/00-03/01	VJX (TUD5)	1527	25x136	SK-1642AQ1	BTKW	
1.0	09/91-03/01	CDY (TU9M), TU9	954		0-N811	TB [TE]	
1.5 D	05/96-03/01	VJX (TUD5), VJY (TUD5)	1527		0-N861	TB [TE]	
1.5 D	05/96-03/01	VJY (TUD5)	1527		0-N862	TB [DG]	
1.5 D	10/00-03/01	VJX (TUD5)	1527		0-N1381	TB [DG]	
1.5 D	05/96-03/01	VJX (TUD5), VJY (TUD5)	1527		0-N2174	VB [TE]	

106 II (1)

1.0 i	05/96-	CDY (TU9M), CDZ (TU9M)	954	17x104	SK-1003	BTK	
1.0 i	05/96-	CDY (TU9M), CDZ (TU9M)	954	17x104	SK-1003AQ1	BTKW	
1.0 i	05/96-	CDY (TU9M), CDZ (TU9M)	954	17x100; :3762434 →	SK-1353	BTK	
1.1 i	05/96-	TU1M	1124	17x104	SK-1003	BTK	
1.1 i	05/96-	TU1JP	1124	17x104; :→3762433	SK-1003	BTK	
1.1 i	05/96-	TU1M	1124	17x104	SK-1003AQ1	BTKW	
1.1 i	05/96-	TU1JP	1124	17x104; :→3762434	SK-1003AQ1	BTKW	
1.1 i	05/96-	TU1JP	1124	17x100; :3762434 →	SK-1353	BTK	
1.1 i	05/96-	TU1JP	1124	17x100; :3762434 →	SK-1353AQ1	BTKW	
1.1 i	01/97-	HDY (TU1M)	1124	17x104	SK-1003	BTK	

CM³

Art. Nr.

**106 II (1)**

1.1 i	01/97-	HDY (TU1M)	1124	17x104; :→3762434	SK-1003AQ1	BTKW	
1.1 i	01/97-	HDY (TU1M)	1124	17x100; :3762434 →	SK-1353	BTK	
1.4 i	05/96-	KFW (TU3JP), KFX (TU3JP)	1360	17x108; :→3666765	SK-1004	BTK	
1.4 i	05/96-	KFW (TU3JP), KFX (TU3JP)	1360	17x108; :→3666766	SK-1004AQ1	BTKW	
1.4 i	05/96-	KFW (TU3JP), KFX (TU3JP)	1360	17x104; :3666766 →	SK-1354	BTK	
1.4 i	05/96-	KFW (TU3JP), KFX (TU3JP)	1360	17x104; :3666766 →	SK-1354AQ1	BTKW	
1.5 D	05/96-	VJX (TUD5), VJY (TUD5)	1527	25.4x136	SK-1040	BTK	
1.5 D	05/96-	VJX (TUD5), VJY (TUD5)	1527	25.4x136	SK-1040AQ1	BTKW	
1.5 D	04/98-	VJX (TUD5)	1527	25x136	SK-1642	BTK	
1.5 D	04/98-	VJX (TUD5)	1527	25x136	SK-1642AQ1	BTKW	
1.6 i	05/96-	NFW (TU5J2), NFY (TU5J2), NFZ (TU5JP)	1587	17x101	SK-1020	BTK	
1.6 i	05/96-	NFW (TU5J2), NFY (TU5J2), NFZ (TU5JP)	1587	17x101	SK-1020AQ1	BTKW	
1.0 i	05/96-	CDY (TU9M), CDZ (TU9M)	954		0-N811	TB [TE]	
1.1 i	05/96-	TU1JP	1124	:3762434 →	0-N1277	TB [TE]	
1.1 i	05/96-	TU1M	1124		0-N811	TB [TE]	
1.1 i	05/96-	TU1JP	1124	:→3762433	0-N811	TB [TE]	
1.1 i	01/97-	HDY (TU1M)	1124		0-N811	TB [TE]	
1.4 i	05/96-	KFW (TU3JP), KFX (TU3JP)	1360	:3666766 →	0-N1277	TB [TE]	
1.4 i	05/96-	KFW (TU3JP), KFX (TU3JP)	1360	:→3666765	0-N811	TB [TE]	
1.5 D	05/96-	VJX (TUD5), VJY (TUD5)	1527		0-N861	TB [TE]	
1.5 D	05/96-	VJY (TUD5)	1527		0-N862	TB [DG]	
1.5 D	04/98-	VJX (TUD5)	1527		0-N1381	TB [DG]	
1.6 i	05/96-	NFW (TU5J2), NFY (TU5J2), NFZ (TU5JP)	1587		0-N811	TB [TE]	
1.6 S16	05/96-	NFX (TU5J4)	1587		0-N121	TB [TE]	
1.6 S16	05/96-	NFX (TU5J4)	1587		0-N122	TB [DG]	
1.1 i	05/96-	HDY (TU1M), HDZ (TU1M), HFX (TU1JP)	1124		0-N125	VB [TE]	S
1.4 i	05/96-	KFW (TU3JP), KFX (TU3JP)	1360		0-N125	VB [TE]	S
1.4 i	05/96-	KFW (TU3JP), KFX (TU3JP)	1360	mit Grundträger	0-N2337	VB [TE]	
1.5 D	05/96-	VJX (TUD5), VJY (TUD5)	1527	für Fahrzeuge ohne Servolenkung	0-N133	VB [TE]	
1.5 D	05/96-	VJX (TUD5), VJY (TUD5)	1527		0-N2015	VB [BT]	
1.5 D	05/96-	VJX (TUD5), VJY (TUD5)	1527	✱	0-N2174	VB [TE]	
1.6 i, 1.6 S16	05/96-	NFW (TU5J2), NFY (TU5J2), NFX (TU5J4), NFZ (TU5JP)	1587		0-N125	VB [TE]	S

107

1.4 HDi	06/05-	8HT (DV4TD)	1398	25.4x144	SK-1391	BTK	
1.4 HDi	06/05-	8HT (DV4TD)	1398	25.4x144	SK-1391AQ1	BTKW	
1.4 HDi	06/05-	8HT (DV4TD)	1398		0-N1062	TB [TE]	
1.4 HDi	06/05-	8HT (DV4TD)	1398		0-N1066	TB [DG]	
1.4 HDi	06/05-	8HT (DV4TD)	1398		0-N1339	VB [BT]	S
1.4 HDi	06/05-	8HT (DV4TD)	1398		0-N1418	VB [DG]	

108

1.2	05/14-	HMT (EB2D)	1199		0-N2424	TB [DG]	
-----	--------	------------	------	--	---------	---------	--

205 I (741A/C)

1.6, 1.6 GTI	02/83-10/87	180A (XU5J), B1A (XU51C), B1E (XU51C), B6D (XU5JA), BAZ (XU5CP)	1580	17x113	SK-1006	BTK	
1.7 Diesel	08/83-10/87	161A (XUD7)	1769	25.39x136	SK-1007	BTK	
1.7 Diesel	08/83-10/87	161A (XUD7)	1769	25.4x136; 10/1986 →	SK-1007AQ1	BTKW	
1.7 Diesel	08/83-10/87	161A (XUD7)	1769	25.4x136	SK-1022	BTK	
1.9 GTI	10/86-10/87	D6B (XU9JA), DFZ (XU9J1)	1905	17x113	SK-1006	BTK	
1.6, 1.6 GTI	02/83-10/87	180A (XU5J), B1A (XU51C), B1E (XU51C), B6D (XU5JA)	1580		0-N812	TB [TE]	
1.7 Diesel	08/83-10/87	161A (XUD7)	1769		0-N813	TB [TE]	
1.7 Diesel	08/83-10/87	161A (XUD7)	1769		0-N814	TB [DG]	
1.9 GTI	10/86-10/87	D6B (XU9JA), DFZ (XU9J1)	1905		0-N812	TB [TE]	
1.4	02/83-10/87	150D (XY7), 150G (XY7)	1360	mit Grundträger	0-N2337	VB [TE]	
1.6, 1.6 GTI	02/83-10/87	180A (XU5J), B1A (XU51C), B1E (XU51C), B6D (XU5JA)	1580		0-N849	VB [TE]	
1.7 Diesel	08/83-10/87	161A (XUD7)	1769		0-N2349	VB [DG]	
1.7 Diesel	08/83-10/87	161A (XUD7)	1769		0-N849	VB [TE]	
1.9 GTI	10/86-10/87	D6B (XU9JA), DFZ (XU9J1)	1905		0-N849	VB [TE]	

205 I Cabriolet (741B, 20D)

1.1	08/87-12/94	H1B (TU1)	1124	17x104	SK-1003	BTK	
1.1 CJ	10/89-12/94	HDZ (TU1M)	1124	17x104; 08/1990 →	SK-1003	BTK	
1.1, 1.1 CJ	08/87-12/94	H1B (TU1), HDZ (TU1M)	1124	17x104	SK-1003AQ1	BTKW	
1.4 CJ	05/91-12/94	KDY (TU3M), KDZ (TU3M)	1361	17x108; :→50355042	SK-1004AQ1	BTKW	

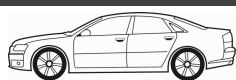

CM³



Art. Nr.



ohne Halter

205 I Cabriolet (741B, 20D)

1.4 CJ	05/91-12/94	KDY (TU3M), KDZ (TU3M)	1361	17x101	SK-1020	BTK	
1.4 CJ	05/91-12/94	KDY (TU3M), KDZ (TU3M)	1361	17x101	SK-1020AQ1	BTKW	
1.4 CJ KAT	01/89-09/93	KAY (TU3CP)	1361	17x108	SK-1004AQ1	BTKW	
1.4 CJ, 1.4 CJ KAT	01/89-12/94	KAY (TU3CP), KDY (TU3M), KDZ (TU3M)	1361	17x108	SK-1004	BTK	
1.4, 1.4 CJ	08/87-12/94	150D (XY7), 150G (XY7), K1D (TU3A)	1360	17x108	SK-1004	BTK	
1.4, 1.4 CJ	08/87-12/94	150D (XY7), 150G (XY7), K1D (TU3A)	1360	17x108	SK-1004AQ1	BTKW	
1.6	08/87-07/92	B6D (XU5JA)	1580	17x113; → 01/1992	SK-1006	BTK	
1.6	08/87-07/92	B6D (XU5JA)	1580	17x114; 01/1992 →	SK-1019	BTK	
1.6 CJ	08/92-12/94	BDY (XU5M3Z)	1580	17x114	SK-1019	BTK	
1.6 CTI	04/86-10/90	180A (XU5J), 180Z (XU5J)	1580	17x113	SK-1006	BTK	
1.9 CTi	08/87-07/90	DFZ (XU9J1)	1905	17x113	SK-1006	BTK	
1.9 CTi	10/87-12/94	DFZ (XU9J1)	1905	17x113; → 01/1992	SK-1006	BTK	
1.9 CTi	10/87-12/94	DFZ (XU9J1)	1905	17x114; 01/1992 →	SK-1019	BTK	
1.1, 1.1 CJ	08/87-12/94	H1B (TU1), HDZ (TU1M)	1124		0-N811	TB [TE]	
1.4 CJ, 1.4 CJ KAT	01/89-12/94	KAY (TU3CP), KDY (TU3M), KDZ (TU3M)	1361		0-N811	TB [TE]	
1.4, 1.4 CJ	08/87-12/94	K1D (TU3A), K2B (TU3S)	1360		0-N811	TB [TE]	
1.6 CJ	08/92-12/94	BDY (XU5M3Z)	1580		0-N811	TB [TE]	
1.6 CTI	04/86-10/90	180A (XU5J), 180Z (XU5J)	1580		0-N812	TB [TE]	
1.9 CTi	08/87-07/90	DFZ (XU9J1)	1905		0-N812	TB [TE]	
1.9 CTi	10/87-12/94	DFZ (XU9J1)	1905	02/1992 →	0-N811	TB [TE]	
1.9 CTi	10/87-12/94	DFZ (XU9J1)	1905	→ 01/1992	0-N812	TB [TE]	
1.1 CJ	10/89-12/94	HDZ (TU1M)	1124		0-N125	VB [TE]	S
1.4 CJ	03/88-05/89	150D (XY7), 150G (XY7)	1360	mit Grundträger	0-N2337	VB [TE]	
1.4 CJ	03/89-12/94	K1D (TU3A)	1360		0-N125	VB [TE]	S
1.4 CJ, 1.4 CJ KAT	01/89-12/94	KAY (TU3CP), KDY (TU3M), KDZ (TU3M)	1361		0-N125	VB [TE]	S
1.6 CJ, 1.6 CTI	04/86-12/94	180A (XU5J), 180Z (XU5J), BDY (XU5M3Z)	1580		0-N849	VB [TE]	
1.9 CTi	08/87-12/94	DFZ (XU9J1)	1905		0-N849	VB [TE]	

205 Kasten

1.1	08/87-07/90	H1B (TU1)	1124	17x104	SK-1003	BTK	
1.1	08/87-07/90	H1B (TU1)	1124	17x104	SK-1003AQ1	BTKW	
1.8 D	02/83-07/90	A9A (XUD7)	1769	25.39x136	SK-1007	BTK	
1.8 D	02/83-07/90	A9A (XUD7)	1769	25.4x136; 10/1986 →	SK-1007AQ1	BTKW	
1.1	08/87-07/90	H1B (TU1)	1124		0-N811	TB [TE]	
1.8 D	02/83-07/90	A9A (XUD7)	1769		0-N813	TB [TE]	
1.8 D	02/83-07/90	A9A (XUD7)	1769		0-N814	TB [DG]	
1.1	08/87-07/90	H1B (TU1)	1124		0-N125	VB [TE]	S
1.7 Diesel, 1.8 D	02/83-07/90	161A (XUD7), A9A (XUD7)	1769		0-N2349	VB [DG]	

205 II (20A/C)

1.0	10/87-09/98	CDZ (TU9M), TU9	954	17x104	SK-1003	BTK	
1.0	10/87-09/98	TU9	954	17x104; 01/1988 →	SK-1003AQ1	BTKW	
1.0	08/92-05/97	CDZ (TU9M)	954	17x104	SK-1003AQ1	BTKW	
1.1	10/87-09/98	109N (XW7), H1B (TU1), HDZ (TU1M)	1124	17x104	SK-1003	BTK	
1.1	10/87-09/98	H1B (TU1), HDZ (TU1M)	1124	17x104	SK-1003AQ1	BTKW	
1.3 Rallye	10/87-10/90	TU24	1294	17x104	SK-1003	BTK	
1.3 Rallye	10/87-10/90	TU24	1294	17x104	SK-1003AQ1	BTKW	
1.4	06/87-10/90	150D (XY7), 150G (XY7), K1D (TU3A), K2B (TU3S)	1360	17x108; 01/1988 →	SK-1004AQ1	BTKW	
1.4	07/88-09/98	KDY (TU3M), KDZ (TU3M), KFX (TU3JP)	1361	17x108	SK-1004	BTK	
1.4	07/88-09/98	TU3JP	1361	17x108	SK-1004AQ1	BTKW	
1.4	07/88-09/98	TUM3	1361	17x108	SK-1004AQ1	BTKW	
1.4	07/88-07/98	150B (XY8), 150H (XY8), KDX (TU3MC), KDY (TU3M), KDZ (TU3M), TU32	1360	17x101	SK-1020	BTK	
1.4	07/88-09/98	KDY (TU3M), KDZ (TU3M), KFX (TU3JP)	1361	17x101	SK-1020	BTK	
1.4	07/88-07/98	150B (XY8), 150H (XY8), KDX (TU3MC), KDY (TU3M), KDZ (TU3M), TU32	1360	17x101	SK-1020AQ1	BTKW	
1.4	07/88-09/98	KDY (TU3M), KDZ (TU3M), KFX (TU3JP)	1361	17x101	SK-1020AQ1	BTKW	
1.4, 1.4 KAT	06/87-07/98	150B (XY8), 150H (XY8), 150D (XY7), 150G (XY7), K1D (TU3A), K2B (TU3S), KAY (TU3CP), KDX (TU3MC), KDY (TU3M), KDZ (TU3M), TU32	1360	17x108	SK-1004	BTK	
1.4, 1.4 KAT	08/87-07/98	150B (XY8), 150H (XY8), KAY (TU3CP), KDX (TU3MC), KDY (TU3M), KDZ (TU3M), TU32	1360	17x108	SK-1004AQ1	BTKW	
1.6 GTI	10/87-12/89	180A (XU5J), 180Z (XU5J)	1580	17x113	SK-1006	BTK	
1.6, 1.6 Aut.	10/87-09/98	171 (XU5S), B1A (XU51C), BAZ (XU5CP), B1E (XU51C), BDY (XU5M2Z), BDY (XU5M3Z)	1580	17x113; → 01/1992	SK-1006	BTK	

CM³

Art. Nr.



ohne Halter

205 II (20A/C)

1.6, 1.6 Aut.	10/87-09/98	171 (XU5S), B1A (XU51C), BAZ (XU5CP), B1E (XU51C), BDY (XU5M2Z), BDY (XU5M3Z)	1580	17x114; 01/1992 →	SK-1019	BTK	
1.7 Diesel	07/87-09/98	161A (XUD7)	1769	25.39x136; → 12/1993; Baumuster: 161A	SK-1007	BTK	
1.7 Diesel	07/87-09/98	161A (XUD7)	1769	25.4x136; → 12/1993	SK-1007AQ1	BTKW	
1.7 Diesel	07/87-09/98	161A (XUD7)	1769	25.4x136; 01/1994 →; Baumuster: 161A	SK-1022	BTK	
1.7 Diesel	07/87-09/98	161A (XUD7)	1769	25.4x136; Orga.07390→	SK-1022AQ1	BTKW	
1.7 Diesel	07/87-09/98	161A (XUD7)	1769	25.4x136; 01/1994 → 01/1997	SK-1022AQ2	BTKW	
1.7 TD	01/90-09/98	A8B (XUD7TE)	1769	25.4x136; → 01/1994	SK-1007AQ1	BTKW	
1.7 TD	01/90-09/98	A8B (XUD7TE)	1769	25.4x136; 01/1994 →; Baumuster: A8B	SK-1022	BTK	
1.7 TD	01/90-09/98	A8B (XUD7TE)	1769	25.4x136; 02/1994 →07389	SK-1022AQ2	BTKW	
1.7 TD, 1.8 XDT	01/90-09/98	A8B (XUD7TE), XUD7T	1769	25.39x136; → 12/1993	SK-1007	BTK	
1.8 XDT	08/90-05/97	XUD7T	1769	25.4x136; 01/1994 →	SK-1022	BTK	
1.9 Diesel	08/87-06/94	XUD9	1905	25.39x136; → 12/1993	SK-1007	BTK	
1.9 Diesel	08/87-06/94	XUD9	1905	25.4x136; → 12/1993	SK-1007AQ1	BTKW	
1.9 Diesel	08/87-09/98	DJZ (XUD9Y), XUD9	1905	25.4x136; 01/1994 →	SK-1022	BTK	
1.9 Diesel	10/87-09/98	DJZ (XUD9Y)	1905	25.39x136; 08/1990 → 12/1993	SK-1007	BTK	
1.9 Diesel	10/87-09/98	DJZ (XUD9Y)	1905	25.4x136	SK-1007AQ1	BTKW	
1.9 Diesel	10/87-09/98	DJZ (XUD9Y)	1905	25.4x136; 01/1994 →	SK-1022AQ2	BTKW	
1.9 GTI	10/87-05/89	D2A (XU92C)	1905	17x113	SK-1006	BTK	
1.9 GTI, 1.9 GTI KAT	10/87-09/98	D6B (XU9JA), DFZ (XU9J1), DKZ (XU9JAZ)	1905	17x113; → 01/1992	SK-1006	BTK	
1.9 GTI, 1.9 GTI KAT	10/87-09/98	D6B (XU9JA), DFZ (XU9J1), DKZ (XU9JAZ)	1905	17x114; 01/1992 →	SK-1019	BTK	
1.0	10/87-09/98	CDZ (TU9M), TU9	954		0-N811	TB [TE]	
1.1	10/87-09/98	H1B (TU1), HDZ (TU1M)	1124		0-N811	TB [TE]	
1.3 Rallye	10/87-10/90	TU24	1294		0-N811	TB [TE]	
1.4	07/88-09/98	KDY (TU3M), KDZ (TU3M), KFX (TU3JP)	1361		0-N811	TB [TE]	
1.4, 1.4 KAT	06/87-07/98	K1D (TU3A), K2B (TU3S), KAY (TU3CP), KDX (TU3MC), KDY (TU3M), KDZ (TU3M), TU32	1360		0-N811	TB [TE]	
1.6 GTI	10/87-12/89	180A (XU5J), 180Z (XU5J)	1580		0-N812	TB [TE]	
1.6 GTX	01/87-10/91		1592		0-N812	TB [TE]	
1.6, 1.6 Aut.	10/87-09/98	171 (XU5S), B1A (XU51C), BAZ (XU5CP), B1E (XU51C), BDY (XU5M2Z), BDY (XU5M3Z)	1580	02/1992 →	0-N811	TB [TE]	
1.6, 1.6 Aut.	10/87-09/98	171 (XU5S), B1A (XU51C), BAZ (XU5CP), B1E (XU51C), BDY (XU5M2Z), BDY (XU5M3Z)	1580	→ 01/1992	0-N812	TB [TE]	
1.7 Diesel	07/87-09/98	161A (XUD7)	1769	Orga.→06170	0-N813	TB [TE]	
1.7 Diesel	07/87-09/98	161A (XUD7)	1769	Orga.→06170	0-N814	TB [DG]	
1.7 Diesel	07/87-09/98	161A (XUD7)	1769	Orga.06171→	0-N900	TB [DG]	
1.7 Diesel	07/87-09/98	161A (XUD7)	1769	Orga.06171→	0-N901	TB [TE]	
1.7 TD, 1.8 XDT	01/90-09/98	A8B (XUD7TE), XUD7T	1769	→ 01/1994	0-N813	TB [TE]	
1.7 TD, 1.8 XDT	01/90-09/98	A8B (XUD7TE), XUD7T	1769	→ 01/1994	0-N814	TB [DG]	
1.7 TD, 1.8 XDT	01/90-09/98	A8B (XUD7TE), XUD7T	1769	01/1994 →	0-N900	TB [DG]	
1.7 TD, 1.8 XDT	01/90-09/98	A8B (XUD7TE), XUD7T	1769	01/1994 →	0-N901	TB [TE]	
1.9	08/92-05/97	DFZ (XU9J1)	1905		0-N811	TB [TE]	
1.9 Diesel	08/87-09/98	DJZ (XUD9Y), XUD9	1905	→ 01/1994	0-N813	TB [TE]	
1.9 Diesel	08/87-09/98	DJZ (XUD9Y), XUD9	1905	→ 01/1994	0-N814	TB [DG]	
1.9 Diesel	08/87-09/98	DJZ (XUD9Y), XUD9	1905	01/1994 →	0-N900	TB [DG]	
1.9 Diesel	08/87-09/98	DJZ (XUD9Y), XUD9	1905	01/1994 →	0-N901	TB [TE]	
1.9 GTI	10/87-05/89	D2A (XU92C)	1905		0-N812	TB [TE]	
1.9 GTI, 1.9 GTI KAT	10/87-09/98	D6B (XU9JA), DFZ (XU9J1), DKZ (XU9JAZ)	1905	→ 01/1992	0-N812	TB [TE]	
1.9, 1.9 GTI, 1.9 GTI KAT	10/87-09/98	D6B (XU9JA), DFZ (XU9J1), DKZ (XU9JAZ)	1905	02/1992 →	0-N811	TB [TE]	
1.0	10/87-09/98	TU9	954		0-N125	VB [TE]	S
1.1	10/87-09/98	H1B (TU1), HDZ (TU1M)	1124		0-N125	VB [TE]	S
1.4	10/87-05/89	150D (XY7), 150G (XY7)	1360	mit Grundträger	0-N2337	VB [TE]	
1.4	07/88-09/98	KDY (TU3M), KDZ (TU3M), KFX (TU3JP)	1361		0-N125	VB [TE]	S
1.4, 1.4 KAT	06/87-07/98	K1D (TU3A), K2B (TU3S), KAY (TU3CP), KDX (TU3MC), KDY (TU3M), KDZ (TU3M), TU32	1360		0-N125	VB [TE]	S
1.6 GTX	01/87-10/91		1592		0-N849	VB [TE]	
1.6, 1.6 Aut., 1.6 GTI	10/87-09/98	171 (XU5S), 180A (XU5J), 180Z (XU5J), B1A (XU51C), BAZ (XU5CP), B1E (XU51C), BDY (XU5M2Z), BDY (XU5M3Z)	1580		0-N849	VB [TE]	
1.7 Diesel	07/87-09/98	161A (XUD7)	1769		0-N849	VB [TE]	
1.7 Diesel, 1.7 TD, 1.8 XDT	07/87-09/98	161A (XUD7), A8B (XUD7TE), XUD7T	1769		0-N2349	VB [DG]	
1.7 TD	01/90-09/98	A8B (XUD7TE)	1769	☞	0-N1712	VB [BT]	
1.9 Diesel	08/87-09/98	DJZ (XUD9Y), XUD9	1905		0-N2349	VB [DG]	



CM³



Art. Nr.



ohne Halter

205 II (20A/C)							
1.9 GTI, 1.9 GTI KAT	10/87-09/98	D2A (XU92C), D6B (XU9JA), DFZ (XU9J1), DKZ (XU9JAZ)	1905			0-N849	VB [TE]
205 Kasten							
1.7 Diesel	03/94-	161A (XUD7)	1769	25.4x136; Baumuster: 161A		SK-1022	BTK
1.7 Diesel	03/94-	161A (XUD7)	1769			0-N900	TB [DG]
1.7 Diesel	03/94-	161A (XUD7)	1769			0-N901	TB [TE]
1.7 Diesel	03/94-	161A (XUD7)	1769			0-N849	VB [TE]
1.7 Diesel, 1.8 D	03/94-	161A (XUD7), A9A (XUD7)	1769			0-N2349	VB [DG]
206 CC (2D)							
1.6 16V	09/00-	NFU (TU5JP4)	1587	25.4x134; :→1806404; mit Zubehör		SK-1392	BTK
1.6 16V	09/00-	NFU (TU5JP4)	1587	25.4x134; → 02/2007; :→1806404; mit Zubehör		SK-1392AQ1	BTKW
1.6 16V	09/00-	NFU (TU5JP4)	1587	25.4x134; :1806405→		SK-1615	BTK
1.6 16V	09/00-	NFU (TU5JP4)	1587	25.4x134; :1806405→		SK-1615AQ1	BTKW
1.6 HDi 110	04/05-	9HZ (DV6TED4)	1560	25x137		SK-1424	BTK
1.6 HDi 110	04/05-	9HZ (DV6TED4)	1560	25x137		SK-1424AQ1	BTKW
2.0 S16	09/00-	RFN (EW10J4)	1997	25.4x153		SK-1482	BTK
2.0 S16	09/00-	RFN (EW10J4)	1997	25.4x153		SK-1482AQ1	BTKW
1.6 16V	09/00-	NFU (TU5JP4)	1587	:→1806404		0-N1061	TB [TE]
1.6 16V	09/00-	NFU (TU5JP4)	1587	:→1806404		0-N122	TB [DG]
1.6 16V	09/00-	NFU (TU5JP4)	1587	:1806405→		0-N1359	TB [TE]
1.6 16V	09/00-	NFU (TU5JP4)	1587	:1806405→		0-N1360	TB [DG]
1.6 HDi 110	04/05-	9HZ (DV6TED4)	1560			0-N1062	TB [TE]
1.6 HDi 110	04/05-	9HZ (DV6TED4)	1560			0-N1066	TB [DG]
2.0 S16	09/00-	RFN (EW10J4)	1997			0-N1057	TB [TE]
2.0 S16	09/00-	RFN (EW10J4)	1997			0-N1065	TB [DG]
1.6 16V	09/00-	NFU (TU5JP4)	1587	Orga.09156→11179;		0-N1419	VB [DG]
1.6 16V	09/00-	NFU (TU5JP4)	1587	Orga.→09155;		0-N1446	VB [DG]
1.6 16V	09/00-	NFU (TU5JP4)	1587	Orga.→09155;		0-N1486	VB [BT] S
1.6 16V	09/00-	NFU (TU5JP4)	1587	Orga.09156→;		0-N1620	VB [BT] S
1.6 16V	09/00-	NFU (TU5JP4)	1587	Orga.11179→;		0-N1874	VB [BT] S
1.6 16V	09/00-	NFU (TU5JP4)	1587	Orga.→09155;		0-N1916	VB [BT]
1.6 16V	09/00-	NFU (TU5JP4)	1587			0-N1949	VB [TE]
1.6 16V	09/00-	NFU (TU5JP4)	1587	Orga.11179→;		0-N2191	VB [DG]
1.6 HDi 110	04/05-	9HZ (DV6TED4)	1560	→ 10/2005; Orga.→10555		0-N1339	VB [BT] S
1.6 HDi 110	04/05-	9HZ (DV6TED4)	1560			0-N1418	VB [DG]
1.6 HDi 110	04/05-	9HZ (DV6TED4)	1560			0-N2055	VB [BT] S
2.0 S16	09/00-	RFN (EW10J4)	1997			0-N1391	VB [BT] S
2.0 S16	09/00-	RFN (EW10J4)	1997	Orga.→10264		0-N1416	VB [DG]
2.0 S16	09/00-	RFN (EW10J4)	1997	Orga.10265→		0-N2276	VB [DG]
206 Schrägheck (2A/C)							
1.1	08/98-07/00	HFY (TU1JP)	1124	17x104; :3762434→		SK-1003AQ1	BTKW
1.1	08/98-07/00	HFY (TU1JP)	1124	17x100; :3762434→		SK-1353AQ1	BTKW
1.1 i	09/98-	HFZ	1124	17x104; :→3762434		SK-1003AQ1	BTKW
1.1 i	09/98-	HFX (TU1JP), HFZ (TU1JP)	1124	17x100; → 02/2007; :3762434→		SK-1353AQ1	BTKW
1.1, 1.1 i	08/98-07/00	HFX (TU1JP), HFZ (TU1JP), HFY (TU1JP)	1124	17x104; :→3762433		SK-1003	BTK
1.1, 1.1 i	08/98-07/00	HFX (TU1JP), HFZ (TU1JP), HFY (TU1JP)	1124	17x100; :3762434→		SK-1353	BTK
1.4 16V	10/03-	KFU (ET3J4)	1360	25x135		SK-1598	BTK
1.4 16V	10/03-	KFU (ET3J4)	1360	25x135		SK-1598AQ1	BTKW
1.4 HDi, 1.4 HDi eco 70	09/01-02/07	8HX (DV4TD), 8HX (DV4TD), 8HZ (DV4TD)	1398	25.4x144		SK-1391	BTK
1.4 HDi, 1.4 HDi eco 70	09/01-02/07	8HX (DV4TD), 8HX (DV4TD), 8HZ (DV4TD)	1398	25.4x144		SK-1391AQ1	BTKW
1.4 i	09/98-	KFW (TU3JP), KFX (TU3JP)	1360	17x108; :→3666765		SK-1004	BTK
1.4 i	09/98-	KFW (TU3JP), KFX (TU3JP)	1360	17x108; :→3666765		SK-1004AQ1	BTKW
1.4 i	09/98-	KFW (TU3JP), KFX (TU3JP)	1360	17x104; → 04/2009; :3666766→		SK-1354	BTK
1.4 i	09/98-	KFW (TU3JP), KFX (TU3JP)	1360	17x104; :3666767→		SK-1354AQ1	BTKW
1.4 LPG	05/06-09/07	KFV (TU3JP)	1360	17x104		SK-1354	BTK
1.4 LPG	05/06-09/07	KFV (TU3JP)	1360	17x104		SK-1354AQ1	BTKW
1.6 16V	12/00-	NFU (TU5JP4)	1587	25.4x134; :→1806404; mit Zubehör		SK-1392	BTK
1.6 16V	12/00-	NFU (TU5JP4)	1587	25.4x134; :→1806404; mit Zubehör		SK-1392AQ1	BTKW
1.6 16V	12/00-	NFU (TU5JP4)	1587	25.4x134; :1806405→		SK-1615	BTK
1.6 16V	12/00-	NFU (TU5JP4)	1587	25.4x134; :1806405→		SK-1615AQ1	BTKW
1.6 HDi 110	05/04-	9HY (DV6TED4), 9HZ (DV6TED4)	1560	25x137		SK-1424	BTK
1.6 HDi 110	05/04-	9HY (DV6TED4), 9HZ (DV6TED4)	1560	25x137		SK-1424AQ1	BTKW
1.6 i	09/98-12/00	NFZ (TU5JP)	1587	17x101		SK-1020	BTK
1.6 i	09/98-12/00	NFZ (TU5JP)	1587	17x101		SK-1020AQ1	BTKW



OPTIMAL®

PEUGEOT



CM³



Art. Nr.



206 Schrägheck (2A/C)

1.9 D	09/98-11/01	WJY (DW8B), WJZ (DW8)	1868	25.4x140	SK-1086	BTK
1.9 D	09/98-11/01	DW8	1868	25.4x140	SK-1086AQ1	BTKW
2.0 HDi 90	12/99-	RHY (DW10TD)	1997	25x141; → 10/2000; Orga.→8735; mit Zubehör	SK-1085	BTK
2.0 HDi 90	12/99-	RHY (DW10TD)	1997	25.4x141; mit Zubehör	SK-1085AQ1	BTKW
2.0 RC	07/03-	RFK (EW10J4S)	1997	25x153	SK-1596	BTK
2.0 RC	07/03-	RFK (EW10J4S)	1997	25x153	SK-1596AQ1	BTKW
2.0 S16	04/99-10/00	RFN (EW10J4), RFR (DEW10J4)	1997	25.4x153	SK-1482	BTK
2.0 S16	04/99-10/00	RFN (EW10J4), RFR (DEW10J4)	1997	25.4x153	SK-1482AQ1	BTKW
1.1, 1.1 i	08/98-07/00	HFX (TU1JP), HFZ (TU1JP), HFY (TU1JP)	1124	ENGINE: →3762434→	0-N1277	TB [TE]
1.1, 1.1 i	08/98-07/00	HFX (TU1JP), HFZ (TU1JP), HFY (TU1JP)	1124	ENGINE: →3762433	0-N811	TB [TE]
1.4 16V	10/03-	KFU (ET3J4)	1360		0-N1338	TB [TE]
1.4 16V	10/03-	KFU (ET3J4)	1360		0-N1456	TB [DG]
1.4 HDi, 1.4 HDi eco 70	09/01-02/07	8HX (DV4TD), 8HX (DV4TD), 8HZ (DV4TD)	1398		0-N1062	TB [TE]
1.4 HDi, 1.4 HDi eco 70	09/01-02/07	8HX (DV4TD), 8HX (DV4TD), 8HZ (DV4TD)	1398		0-N1066	TB [DG]
1.4 i	09/98-	KFW (TU3JP), KFX (TU3JP)	1360	ENGINE: →3666766→	0-N1277	TB [TE]
1.4 i	09/98-	KFW (TU3JP), KFX (TU3JP)	1360	ENGINE: →3666765	0-N811	TB [TE]
1.4 LPG	05/06-09/07	KFV (TU3JP)	1360		0-N1277	TB [TE]
1.6 16V	12/00-	NFU (TU5JP4)	1587	ENGINE: →1806404	0-N1061	TB [TE]
1.6 16V	12/00-	NFU (TU5JP4)	1587	ENGINE: →1806404	0-N122	TB [DG]
1.6 16V	12/00-	NFU (TU5JP4)	1587	ENGINE: →1806405→	0-N1359	TB [TE]
1.6 16V	12/00-	NFU (TU5JP4)	1587	ENGINE: →1806405→	0-N1360	TB [DG]
1.6 HDi 110	05/04-	9HY (DV6TED4), 9HZ (DV6TED4)	1560		0-N1062	TB [TE]
1.6 HDi 110	05/04-	9HY (DV6TED4), 9HZ (DV6TED4)	1560		0-N1066	TB [DG]
1.6 i	09/98-12/00	NFZ (TU5JP)	1587		0-N811	TB [TE]
1.9 D	09/98-11/01	WJY (DW8B), WJZ (DW8)	1868		0-N118P	TB [TE]
1.9 D	09/98-11/01	WJY (DW8B), WJZ (DW8)	1868		0-N1381	TB [DG]
2.0 HDi 90	12/99-	RHY (DW10TD)	1997	Orga.→08735	0-N118P	TB [TE]
2.0 HDi 90	12/99-	RHY (DW10TD)	1997	Orga.→08735	0-N119P	TB [DG]
2.0 HDi 90	12/99-	RHY (DW10TD)	1997	Orga.08736→	0-N1381	TB [DG]
2.0 RC, 2.0 S16	04/99-10/00	RFK (EW10J4S), RFN (EW10J4), RFR (DEW10J4)	1997		0-N1057	TB [TE]
2.0 RC, 2.0 S16	04/99-10/00	RFK (EW10J4S), RFN (EW10J4), RFR (DEW10J4)	1997		0-N1065	TB [DG]
1.1	08/98-07/00	TU1JP	1124	☼	0-N1446	VB [DG]
1.1	08/98-07/00	HFY (TU1JP)	1124	☼	0-N1916	VB [BT]
1.1 i	09/98-	HFX (TU1JP), HFZ (TU1JP)	1124	Orga.09156→; ☼	0-N1419	VB [DG]
1.1 i	09/98-	HFX (TU1JP), HFZ (TU1JP)	1124	Orga.→09155; ☼	0-N1446	VB [DG]
1.1 i	09/98-	HFX (TU1JP), HFZ (TU1JP)	1124	Orga.09156→; ☼	0-N1620	VB [BT] S
1.1 i	09/98-	HFX (TU1JP), HFZ (TU1JP)	1124	Orga.→09155; ☼	0-N1916	VB [BT]
1.1 i	09/98-	HFX (TU1JP), HFZ (TU1JP)	1124		0-N1949	VB [TE]
1.1, 1.1 i	08/98-07/00	HFX (TU1JP), HFZ (TU1JP), HFY (TU1JP)	1124	☼	0-N1486	VB [BT] S
1.4 16V	10/03-	KFU (ET3J4)	1360		0-N1419	VB [DG]
1.4 16V	10/03-	KFU (ET3J4)	1360		0-N1620	VB [BT] S
1.4 16V, 1.4 i	09/98-	KFU (ET3J4), KFW (TU3JP), KFX (TU3JP)	1360	mit Grundträger	0-N2337	VB [TE]
1.4 HDi	09/02-02/07	8HX (DV4TD)	1398	→ 09/2005; ☼	0-N1418	VB [DG]
1.4 HDi	09/02-02/07	8HX (DV4TD)	1398	09/2005 →; ☼	0-N1807	VB [DG]
1.4 HDi	09/02-02/07	8HX (DV4TD)	1398	09/2005 →; ☼	0-N1807	VB [DG]
1.4 HDi eco 70	09/01-	8HX (DV4TD), 8HZ (DV4TD)	1398	→ 09/2005	0-N1418	VB [DG]
1.4 HDi eco 70	09/01-	8HX (DV4TD), 8HZ (DV4TD)	1398	09/2005 →	0-N1807	VB [DG]
1.4 HDi, 1.4 HDi eco 70	09/01-02/07	8HX (DV4TD), 8HX (DV4TD), 8HZ (DV4TD)	1398	→ 09/2005; ☼	0-N1420	VB [DG]
1.4 HDi, 1.4 HDi eco 70	09/01-02/07	8HX (DV4TD), 8HX (DV4TD), 8HZ (DV4TD)	1398		0-N1636	VB [BT] S
1.4 i	09/98-	KFW (TU3JP), KFX (TU3JP)	1360	Orga.09156→; ☼	0-N1419	VB [DG]
1.4 i	09/98-	KFW (TU3JP), KFX (TU3JP)	1360	Orga.→09155; ☼	0-N1446	VB [DG]
1.4 i	09/98-	KFW (TU3JP), KFX (TU3JP)	1360	☼	0-N1486	VB [BT] S
1.4 i	09/98-	KFW (TU3JP), KFX (TU3JP)	1360	Orga.09156→; ☼	0-N1620	VB [BT] S
1.4 i	09/98-	KFW (TU3JP), KFX (TU3JP)	1360	Orga.→09155; ☼	0-N1916	VB [BT]
1.4 i	09/98-	KFW (TU3JP), KFX (TU3JP)	1360		0-N1949	VB [TE]
1.4 LPG	05/06-09/07	KFV (TU3JP)	1360	☼	0-N1419	VB [DG]
1.4 LPG	05/06-09/07	KFV (TU3JP)	1360	☼	0-N1620	VB [BT] S
1.6 16V	12/00-	NFU (TU5JP4)	1587	Orga.09156→11179; ☼	0-N1419	VB [DG]
1.6 16V	12/00-	NFU (TU5JP4)	1587	Orga.→09155; ☼	0-N1446	VB [DG]
1.6 16V	12/00-	NFU (TU5JP4)	1587	Orga.→09155; ☼	0-N1486	VB [BT] S
1.6 16V	12/00-	NFU (TU5JP4)	1587	Orga.09156→; ☼	0-N1620	VB [BT] S
1.6 16V	12/00-	NFU (TU5JP4)	1587	Orga.11179→; ☼	0-N1874	VB [BT] S
1.6 16V	12/00-	NFU (TU5JP4)	1587	Orga.11179→; ☼	0-N2191	VB [DG]

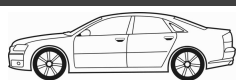

CM³



Art. Nr.



ohne Halter

206 Schrägheck (2A/C)

1.6 16V, 1.6 i	09/98-12/00	NFU (TU5JP4), NFZ (TU5JP)	1587	Orga.→09155; ⚠	0-N1916	VB [BT]	
1.6 16V, 1.6 i	09/98-12/00	NFU (TU5JP4), NFZ (TU5JP)	1587		0-N1949	VB [TE]	
1.6 HDi 110	05/04-	9HY (DV6TED4), 9HZ (DV6TED4)	1560		0-N1339	VB [BT]	S
1.6 HDi 110	05/04-	9HY (DV6TED4), 9HZ (DV6TED4)	1560		0-N1418	VB [DG]	
1.6 HDi 110	05/04-	9HY (DV6TED4), 9HZ (DV6TED4)	1560		0-N2055	VB [BT]	S
1.6 i	09/98-12/00	NFZ (TU5JP)	1587	⚠	0-N1446	VB [DG]	
1.6 i	09/98-12/00	NFZ (TU5JP)	1587	⚠	0-N1486	VB [BT]	S
1.9 D	09/98-11/01	WJY (DW8B), WJZ (DW8)	1868	Orga.08337→; für Fahrzeuge mit Servolenkung	0-N1309	VB [DG]	
1.9 D	09/98-11/01	WJY (DW8B), WJZ (DW8)	1868		0-N1320	VB [TE]	
1.9 D	09/98-11/01	WJY (DW8B), WJZ (DW8)	1868	Orga.→08336	0-N1455	VB [TE]	
1.9 D	09/98-11/01	WJY (DW8B), WJZ (DW8)	1868	Orga.08337→; für Fahrzeuge mit Servolenkung, ⚠	0-N1471	VB [BT]	S
1.9 D	09/98-11/01	WJY (DW8B), WJZ (DW8)	1868	Orga.→09520; ⚠, für Fahrzeuge mit Servolenkung	0-N1472	VB [BT]	S
1.9 D	09/98-11/01	WJY (DW8B), WJZ (DW8)	1868		0-N1545	VB [DG]	
1.9 D	09/98-11/01	WJY (DW8B), WJZ (DW8)	1868	⚠, ⚠, für Fahrzeuge ohne Servolenkung	0-N1681	VB [BT]	
1.9 D	09/98-11/01	WJY (DW8B), WJZ (DW8)	1868	Orga.→09520; ⚠, für Fahrzeuge mit Servolenkung	0-N1747	VB [VD]	
1.9 D	09/98-11/01	WJY (DW8B), WJZ (DW8)	1868	Orga.09521→; ⚠, für Fahrzeuge mit Servolenkung	0-N1945	VB [BT]	S
2.0 HDi 90	12/99-	RHY (DW10TD)	1997	Orga.→10767	0-N1320	VB [TE]	
2.0 HDi 90	12/99-	RHY (DW10TD)	1997		0-N1493	VB [BT]	S
2.0 HDi 90	12/99-	RHY (DW10TD)	1997		0-N151	VB [DG]	
2.0 HDi 90	12/99-	RHY (DW10TD)	1997	⚠	0-N1748	VB [BT]	
2.0 HDi 90	12/99-	RHY (DW10TD)	1997	Orga.10768→	0-N2019	VB [DG]	
2.0 RC	07/03-	RFK (EW10J4S)	1997		0-N1556S	VB [TE]	
2.0 RC, 2.0 S16	04/99-10/00	RFK (EW10J4S), RFN (EW10J4), RFR (DEW10J4)	1997	Orga.→10264	0-N1416	VB [DG]	
2.0 RC, 2.0 S16	06/99-	RFK (EW10J4S), RFN (EW10J4)	1997	Orga.10265→	0-N2276	VB [DG]	
2.0 S16	04/99-10/00	RFN (EW10J4), RFR (DEW10J4)	1997		0-N1391	VB [BT]	S

206 SW (2E/K)

1.1	07/02-	HFX (TU1JP)	1124	17x104; :→3762433	SK-1003	BTK	
1.1	07/02-	HFX (TU1JP)	1124	17x104; :→3762434	SK-1003AQ1	BTKW	
1.1	07/02-	HFX (TU1JP)	1124	17x100; :3762434→	SK-1353	BTK	
1.1	07/02-	HFX (TU1JP)	1124	17x100; → 02/2007; :3762434→	SK-1353AQ1	BTKW	
1.4	07/02-	KFV (TU3A), KFW (TU3JP)	1360	17x108; :→3666765	SK-1004	BTK	
1.4	07/02-	KFV (TU3A), KFW (TU3JP)	1360	17x108; :→3666765	SK-1004AQ1	BTKW	
1.4	07/02-	KFV (TU3A), KFW (TU3JP)	1360	17x104; :3666766→	SK-1354	BTK	
1.4	07/02-	KFV (TU3A), KFW (TU3JP)	1360	17x104; :3666767→	SK-1354AQ1	BTKW	
1.4 16V	10/03-	KFU (ET3J4)	1360	25x135	SK-1598	BTK	
1.4 16V	10/03-	KFU (ET3J4)	1360	25x135	SK-1598AQ1	BTKW	
1.4 HDi	07/02-	8HX (DV4TD)	1398	25.4x144	SK-1391	BTK	
1.4 HDi	07/02-	8HX (DV4TD)	1398	25.4x144	SK-1391AQ1	BTKW	
1.6 16V	07/02-	NFU (TU5JP4)	1587	25.4x134; :→1806404; mit Zubehör	SK-1392	BTK	
1.6 16V	07/02-	NFU (TU5JP4)	1587	25.4x134; :→1806404; mit Zubehör	SK-1392AQ1	BTKW	
1.6 16V	07/02-	NFU (TU5JP4)	1587	25.4x134; :1806405→	SK-1615	BTK	
1.6 16V	07/02-	NFU (TU5JP4)	1587	25.4x134; :1806405→	SK-1615AQ1	BTKW	
1.6 HDi 110	05/04-	9HZ (DV6TED4)	1560	25x137	SK-1424	BTK	
1.6 HDi 110	05/04-	9HZ (DV6TED4)	1560	25x137	SK-1424AQ1	BTKW	
2.0 16V	07/02-	RFN (EW10J4)	1997	25.4x153	SK-1482	BTK	
2.0 16V	07/02-	RFN (EW10J4)	1997	25.4x153	SK-1482AQ1	BTKW	
2.0 HDi	07/02-	RHY (DW10TD)	1997	25x141; Orga.→10460; mit Zubehör	SK-1085	BTK	
2.0 HDi	07/02-	RHY (DW10TD)	1997	25.4x141; mit Zubehör	SK-1085AQ1	BTKW	
1.1	07/02-	HFX (TU1JP)	1124	:3762434→	0-N1277	TB [TE]	
1.1	07/02-	HFX (TU1JP)	1124	:→3762433	0-N811	TB [TE]	
1.4	07/02-	KFV (TU3A), KFW (TU3JP)	1360	:3666766→	0-N1277	TB [TE]	
1.4	07/02-	KFV (TU3A), KFW (TU3JP)	1360	:→3666765	0-N811	TB [TE]	
1.4 16V	10/03-	KFU (ET3J4)	1360		0-N1338	TB [TE]	
1.4 16V	10/03-	KFU (ET3J4)	1360		0-N1456	TB [DG]	
1.4 HDi	07/02-	8HX (DV4TD)	1398		0-N1062	TB [TE]	
1.4 HDi	07/02-	8HX (DV4TD)	1398		0-N1066	TB [DG]	
1.6 16V	07/02-	NFU (TU5JP4)	1587	:→1806404	0-N1061	TB [TE]	
1.6 16V	07/02-	NFU (TU5JP4)	1587	:→1806404	0-N122	TB [DG]	
1.6 16V	07/02-	NFU (TU5JP4)	1587	:1806405→	0-N1359	TB [TE]	
1.6 16V	07/02-	NFU (TU5JP4)	1587	:1806405→	0-N1360	TB [DG]	



CM³



Art. Nr.



206 SW (2E/K)

1.6 HDi 110	05/04-	9HZ (DV6TED4)	1560		0-N1062	TB [TE]	
1.6 HDi 110	05/04-	9HZ (DV6TED4)	1560		0-N1066	TB [DG]	
2.0 16V	07/02-	RFN (EW10J4)	1997		0-N1057	TB [TE]	
2.0 16V	07/02-	RFN (EW10J4)	1997		0-N1065	TB [DG]	
2.0 HDi	07/02-	RHY (DW10TD)	1997	Orga.→08735	0-N118P	TB [TE]	
2.0 HDi	07/02-	RHY (DW10TD)	1997	Orga.→08735	0-N119P	TB [DG]	
2.0 HDi	07/02-	RHY (DW10TD)	1997	Orga.08736→	0-N1381	TB [DG]	
1.1	07/02-	HFX (TU1JP)	1124	☼	0-N1419	VB [DG]	
1.1	07/02-	HFX (TU1JP)	1124	☼	0-N1486	VB [BT]	S
1.1	07/02-	HFX (TU1JP)	1124	☼	0-N1620	VB [BT]	S
1.1	07/02-	HFX (TU1JP)	1124	Orga.→09155; ☼	0-N1916	VB [BT]	
1.1	07/02-	HFX (TU1JP)	1124		0-N1949	VB [TE]	
1.4	07/02-	KFV (TU3A), KFW (TU3JP)	1360	☼	0-N1419	VB [DG]	
1.4	07/02-	KFV (TU3A), KFW (TU3JP)	1360	☼	0-N1486	VB [BT]	S
1.4	07/02-	KFV (TU3A), KFW (TU3JP)	1360	☼	0-N1620	VB [BT]	S
1.4	07/02-	KFV (TU3A), KFW (TU3JP)	1360	Orga.→09155; ☼	0-N1916	VB [BT]	
1.4	07/02-	KFV (TU3A), KFW (TU3JP)	1360		0-N1949	VB [TE]	
1.4 16V	10/03-	KFU (ET3J4)	1360		0-N1419	VB [DG]	
1.4 16V	10/03-	KFU (ET3J4)	1360		0-N1620	VB [BT]	S
1.4 HDi	07/02-	8HX (DV4TD)	1398	→ 09/2005	0-N1418	VB [DG]	
1.4 HDi	07/02-	8HX (DV4TD)	1398	→ 09/2005; ☼	0-N1420	VB [DG]	
1.4 HDi	07/02-	8HX (DV4TD)	1398		0-N1636	VB [BT]	S
1.4 HDi	07/02-	8HX (DV4TD)	1398	09/2005 →	0-N1807	VB [DG]	
1.4, 1.4 16V	07/02-	KFU (ET3J4), KFV (TU3A), KFW (TU3JP)	1360	mit Grundträger	0-N2337	VB [TE]	
1.6 16V	07/02-	NFU (TU5JP4)	1587	Orga.→11179; ☼	0-N1419	VB [DG]	
1.6 16V	07/02-	NFU (TU5JP4)	1587	Orga.→09155; ☼	0-N1486	VB [BT]	S
1.6 16V	07/02-	NFU (TU5JP4)	1587	Orga.09156→; ☼	0-N1620	VB [BT]	S
1.6 16V	07/02-	NFU (TU5JP4)	1587	Orga.11179→; ☼	0-N1874	VB [BT]	S
1.6 16V	07/02-	NFU (TU5JP4)	1587	Orga.→09155; ☼	0-N1916	VB [BT]	
1.6 16V	07/02-	NFU (TU5JP4)	1587		0-N1949	VB [TE]	
1.6 16V	07/02-	NFU (TU5JP4)	1587	Orga.11179→; ☼	0-N2191	VB [DG]	
1.6 HDi 110	05/04-	9HZ (DV6TED4)	1560		0-N1339	VB [BT]	S
1.6 HDi 110	05/04-	9HZ (DV6TED4)	1560		0-N1418	VB [DG]	
1.6 HDi 110	05/04-	9HZ (DV6TED4)	1560		0-N2055	VB [BT]	S
2.0 16V	07/02-	RFN (EW10J4)	1997		0-N1391	VB [BT]	S
2.0 16V	07/02-	RFN (EW10J4)	1997	Orga.→10264	0-N1416	VB [DG]	
2.0 16V	07/02-	RFN (EW10J4)	1997	Orga.10265→	0-N2276	VB [DG]	
2.0 HDi	07/02-	RHY (DW10TD)	1997	Orga.→10767	0-N1320	VB [TE]	
2.0 HDi	07/02-	RHY (DW10TD)	1997		0-N1493	VB [BT]	S
2.0 HDi	07/02-	RHY (DW10TD)	1997	☼	0-N151	VB [DG]	
2.0 HDi	07/02-	RHY (DW10TD)	1997	☼, für Fahrzeuge mit Servolenkung	0-N1747	VB [VD]	
2.0 HDi	07/02-	RHY (DW10TD)	1997	☼	0-N1748	VB [BT]	
2.0 HDi	07/02-	RHY (DW10TD)	1997	Orga.10768→	0-N2019	VB [DG]	

206 Van

1.4 HDi	09/01-03/09	8HX (DV4TD), 8HZ (DV4TD)	1398	25.4x144	SK-1391	BTK	
1.4 HDi	09/01-03/09	8HX (DV4TD), 8HZ (DV4TD)	1398	25.4x144	SK-1391AQ1	BTKW	
1.9 D	04/99-05/07	WJZ (DW8)	1868	25.4x140	SK-1086	BTK	
1.9 D	04/99-05/07	WJZ (DW8)	1868	25.4x140	SK-1086AQ1	BTKW	
1.4 HDi	09/01-03/09	8HX (DV4TD), 8HZ (DV4TD)	1398		0-N1062	TB [TE]	
1.4 HDi	09/01-03/09	8HX (DV4TD), 8HZ (DV4TD)	1398		0-N1066	TB [DG]	
1.9 D	04/99-05/07	WJZ (DW8)	1868		0-N118P	TB [TE]	
1.9 D	04/99-05/07	WJZ (DW8)	1868		0-N1381	TB [DG]	
1.4 HDi	09/01-03/09	8HX (DV4TD), 8HZ (DV4TD)	1398	→ 09/2005; ☼	0-N1418	VB [DG]	
1.4 HDi	09/01-03/09	8HX (DV4TD), 8HZ (DV4TD)	1398	→ 09/2005; ☼	0-N1420	VB [DG]	
1.4 HDi	09/01-03/09	8HX (DV4TD), 8HZ (DV4TD)	1398	09/2005 →; ☼	0-N1807	VB [DG]	
1.4 HDi	09/01-03/09	8HX (DV4TD), 8HZ (DV4TD)	1398	09/2005 →; ☼	0-N1807	VB [DG]	
1.9 D	04/99-05/07	WJZ (DW8)	1868	☼, für Fahrzeuge mit Servolenkung	0-N1320	VB [TE]	
1.9 D	04/99-05/07	WJZ (DW8)	1868	☼, für Fahrzeuge ohne Servolenkung	0-N1681	VB [BT]	

206 Stufenheck

1.4	03/07-	TU3A	1360	17x104	SK-1354	BTK	
1.4	03/07-	TU3JP	1360	17x104	SK-1354AQ1	BTKW	
1.4 HDi eco 70	09/08-	8HZ (DV4TD)	1398	25.4x144	SK-1391	BTK	
1.4 HDi eco 70	09/08-	8HZ (DV4TD)	1398	25.4x144	SK-1391AQ1	BTKW	
1.6 16V	03/07-	NFU (TU5JP4)	1587	25.4x134; ☼:→1806404; mit Zubehör	SK-1392	BTK	

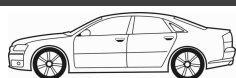

CM³



Art. Nr.



206 Stufenheck

1.6 16V	03/07-	NFU (TU5JP4)	1587	25.4x134; →1806404; mit Zubehör	SK-1392AQ1	BTKW	
1.6 16V	03/07-	NFU (TU5JP4)	1587	25.4x134; :1806405 →	SK-1615	BTK	
1.6 16V	03/07-	NFU (TU5JP4)	1587	25.4x134	SK-1615AQ1	BTKW	
1.4	03/07-	KFV (TU3A), KFW (TU3JP)	1360		0-N1277	TB [TE]	
1.4 HDi eco 70	09/08-	8HZ (DV4TD)	1398		0-N1062	TB [TE]	
1.4 HDi eco 70	09/08-	8HZ (DV4TD)	1398		0-N1066	TB [DG]	
1.6 16V	03/07-	NFU (TU5JP4)	1587		0-N1359	TB [TE]	
1.6 16V	03/07-	NFU (TU5JP4)	1587		0-N1360	TB [DG]	
1.4	03/07-	KFV (TU3A), KFW (TU3JP)	1360	✳	0-N1419	VB [DG]	
1.4	03/07-	TU3JP	1360	✳	0-N1486	VB [BT]	S
1.4	03/07-	KFV (TU3A), KFW (TU3JP)	1360	✳	0-N1620	VB [BT]	S
1.4	03/07-	TU3JP	1360	✳	0-N1916	VB [BT]	
1.4	03/07-	KFV (TU3A), KFW (TU3JP)	1360		0-N1949	VB [TE]	
1.4 HDi eco 70	09/08-	8HZ (DV4TD)	1398		0-N1807	VB [DG]	
1.4 HDi eco 70	09/08-	8HZ (DV4TD)	1398		0-N1808	VB [BT]	S
1.6 16V	03/07-	NFU (TU5JP4)	1587	✳	0-N1874	VB [BT]	S
1.6 16V	03/07-	NFU (TU5JP4)	1587	✳	0-N2191	VB [DG]	

206+ (T3E)

1.1	01/09-	HFX (TU1A), HFX (TU1JP), TU1AE5	1124	17x100	SK-1353	BTK	
1.1	01/09-	HFX (TU1A), HFX (TU1JP), TU1AE5	1124	17x100	SK-1353AQ1	BTKW	
1.4 HDi eco 70	01/09-	DV4TD	1398	25.4x144	SK-1391	BTK	
1.4 HDi eco 70	01/09-	DV4TD	1398	25.4x144	SK-1391AQ1	BTKW	
1.4 HDi eco 70	01/09-	DV4C	1398	25.4x139; Orga. 12630 →	SK-1732	BTK	
1.4 HDi eco 70	01/09-	DV4C	1398	25.4x139; 06/2011 →	SK-1732AQ1	BTKW	
1.4 i	01/09-	KFT (TU3A), KFV (TU3A), KFW (TU3A)	1360	17x104	SK-1354	BTK	
1.4 i	01/09-	KFV (TU3A), KFW (TU3A)	1360	17x104; 04/2009 →	SK-1354AQ1	BTKW	
1.1	01/09-	HFX (TU1A), HFX (TU1JP), TU1AE5	1124		0-N1277	TB [TE]	
1.4 HDi eco 70	01/09-	8HX (DV4TD), 8HZ (DV4TD)	1398		0-N1062	TB [TE]	
1.4 HDi eco 70	01/09-	8HX (DV4TD), 8HZ (DV4TD)	1398		0-N1066	TB [DG]	
1.4 i	01/09-	KFT (TU3A), KFV (TU3A), KFW (TU3A)	1360		0-N1277	TB [TE]	
1.1	01/09-	HFX (TU1A), HFX (TU1JP), TU1AE5	1124		0-N1419	VB [DG]	
1.1	01/09-	TU1A	1124	✳	0-N1620	VB [BT]	S
1.1	01/09-	HFX (TU1A), HFX (TU1JP), TU1AE5	1124		0-N1949	VB [TE]	
1.4 HDi eco 70	01/09-	DV4C	1398		0-N1502	VB [BT]	S
1.4 HDi eco 70	01/09-	8HX (DV4TD), 8HZ (DV4TD)	1398		0-N1807	VB [DG]	
1.4 HDi eco 70	01/09-	8HX (DV4TD), 8HZ (DV4TD)	1398		0-N1808	VB [BT]	S
1.4 i	01/09-	KFT (TU3A), KFV (TU3A), KFW (TU3A)	1360		0-N1419	VB [DG]	
1.4 i	01/09-	KFT (TU3A), KFV (TU3A), KFW (TU3A)	1360	✳	0-N1620	VB [BT]	S
1.4 i	01/09-	KFT (TU3A), KFV (TU3A), KFW (TU3A)	1360		0-N1949	VB [TE]	

207 (WA_, WC_)

1.4 16V	02/06-	KFU (ET3J4)	1360	25x135	SK-1598	BTK	
1.4 16V	02/06-	KFU (ET3J4)	1360	25x135	SK-1598AQ1	BTKW	
1.4 HDi	02/06-	DV4TD	1398	25.4x144; 04/2006 →	SK-1391	BTK	
1.4 HDi	02/06-	DV4TD	1398	25.4x144; 04/2006 →	SK-1391AQ1	BTKW	
1.4 HDi	02/06-	DV4C	1398	25.4x139	SK-1732	BTK	
1.4 HDi	02/06-	DV4C	1398	25.4x139	SK-1732AQ1	BTKW	
1.4, 1.4 Bioflex	02/06-	KFV (TU3A), KFV (TU3A), KFW (TU3A), KFW (TU3JP)	1360	17x104	SK-1354	BTK	
1.4, 1.4 Bioflex	02/06-	KFV (TU3A), KFV (TU3A), KFW (TU3A), KFW (TU3JP)	1360	17x104	SK-1354AQ1	BTKW	
1.6 16V, 1.6 Flex	02/06-	N6A (TU5JP4), NFU (TU5JP4)	1587	25.4x134	SK-1615	BTK	
1.6 16V, 1.6 Flex	02/06-	N6A (TU5JP4), NFU (TU5JP4)	1587	25.4x134	SK-1615AQ1	BTKW	
1.6 HDi	02/06-	9HV (DV6ATED4), 9HV (DV6TED4), 9HX (DV6ATED4), 9HY (DV6TED4), 9HZ (DV6TED4)	1560	25x137	SK-1424	BTK	
1.6 HDi	02/06-	9HV (DV6ATED4), 9HV (DV6TED4), 9HX (DV6ATED4), 9HY (DV6TED4), 9HZ (DV6TED4)	1560	25x137	SK-1424AQ1	BTKW	
1.6 HDi, 1.6 HDi 110	08/09-	9HP (DV6DTE), 9HR (DV6C)	1560	25x141	SK-1728	BTK	
1.6 HDi, 1.6 HDi 110	08/09-	9HP (DV6DTE), 9HR (DV6C)	1560	25x141	SK-1728AQ1	BTKW	
1.4	02/06-	KFV (TU3A), KFV (TU3A), KFW (TU3A)	1360		0-N1277	TB [TE]	
1.4 16V	02/06-	KFU (ET3J4)	1360		0-N1338	TB [TE]	
1.4 16V	02/06-	KFU (ET3J4)	1360		0-N1456	TB [DG]	
1.4 HDi	02/06-	DV4TD	1398		0-N1062	TB [TE]	
1.4 HDi	02/06-	8HZ	1398		0-N1066	TB [DG]	
1.4 HDi	02/06-	8HR	1398		0-N2224	TB [TE]	



OPTIMAL®

PEUGEOT



CM³



Art. Nr.



ohne Halter

207 (WA_, WC_)

1.4 HDi	02/06-	DV4C	1398		0-N2382	TB [DG]	
1.6 16V	02/06-	NFU (TU5JP4)	1587		0-N1359	TB [TE]	
1.6 16V	02/06-	NFU (TU5JP4)	1587		0-N1360	TB [DG]	
1.6 HDi	02/06-	9HV (DV6ATED4), 9HV (DV6TED4), 9HX (DV6ATED4), 9HY (DV6ATED4), 9HZ (DV6ATED4)	1560		0-N1066	TB [DG]	
1.6 HDi	11/09-	9HP (DV6DTEd)	1560		0-N2224	TB [TE]	
1.6 HDi 110	08/09-	DV6C	1560		0-N2224	TB [TE]	
1.6 HDi, 1.6 HDi 110	02/06-	9HR (DV6C), 9HV (DV6ATED4), 9HV (DV6ATED4), 9HX (DV6ATED4), 9HY (DV6ATED4), 9HZ (DV6ATED4)	1560		0-N1062	TB [TE]	
1.6 HDi, 1.6 HDi 110	08/09-	9HP (DV6DTEd), 9HR (DV6C)	1560		0-N2382	TB [DG]	
1.4	02/06-	KFV (TU3A), KFV (TU3A), KFV (TU3A)	1360		0-N1673	VB [BT]	S
1.4 16V	02/06-	KFU (ET3J4)	1360	☼	0-N1673	VB [BT]	S
1.4 16V	06/07-	8FS (EP3), EP3, EP3C	1397	☼	0-N2055	VB [BT]	S
1.4 16V	06/07-	8FS (EP3), EP3, EP3C	1397	für OE: 11 28 7 598 832, 11 28 7 598 833	0-N2237	VB [DG]	
1.4 HDi	02/06-	DV4C	1398		0-N1502	VB [BT]	S
1.4 HDi	02/06-	DV4TD	1398	03/2007 →; Orga.11074→	0-N1502	VB [BT]	S
1.4 HDi	02/06-	8HZ	1398	Orga.→11073	0-N1807	VB [DG]	
1.4 HDi	02/06-	8HZ	1398	Orga.→11073; ☼	0-N1924	VB [DG]	
1.6 16V	02/06-	NFU (TU5JP4)	1587		0-N1673	VB [BT]	S
1.6 16V RC, 1.6 16V Turbo, 1.6 16V VTi	02/06-	5FR (EP6DT), 5FS (EP6C), 5FW (EP6), EP6, 5FX (EP6DT), 5FY (EP6DTS)	1598	☼	0-N2055	VB [BT]	S
1.6 16V RC, 1.6 16V Turbo, 1.6 16V VTi	02/06-	5FR (EP6DT), 5FS (EP6C), 5FW (EP6), EP6, 5FX (EP6DT), 5FY (EP6DTS)	1598	für OE: 11 28 7 598 832, 11 28 7 598 833	0-N2237	VB [DG]	
1.6 HDi	02/06-	9HV (DV6ATED4), 9HV (DV6ATED4), 9HX (DV6ATED4), 9HY (DV6ATED4), 9HZ (DV6ATED4)	1560	03/2007 →; Orga.11074→	0-N1502	VB [BT]	S
1.6 HDi	02/06-	9HV (DV6ATED4), 9HV (DV6ATED4), 9HX (DV6ATED4), 9HY (DV6ATED4), 9HZ (DV6ATED4)	1560	Orga.→11073	0-N1807	VB [DG]	
1.6 HDi	02/06-	9HV (DV6ATED4), 9HV (DV6ATED4), 9HX (DV6ATED4), 9HY (DV6ATED4), 9HZ (DV6ATED4)	1560	Orga.→11073; ☼	0-N1924	VB [DG]	
1.6 HDi, 1.6 HDi 110	08/09-	9HP (DV6DTEd), 9HR (DV6C)	1560		0-N1502	VB [BT]	S

207 CC (WD_)

1.6 HDi	02/07-	9HZ (DV6TED4)	1560	25x137	SK-1424	BTK	
1.6 HDi	02/07-	9HZ (DV6TED4)	1560	25x137	SK-1424AQ1	BTKW	
1.6 HDi	08/09-	9HR (DV6C)	1560	25x141	SK-1728	BTK	
1.6 HDi	08/09-	9HR (DV6C)	1560	25x141	SK-1728AQ1	BTKW	
1.6 HDi	02/07-	9HZ (DV6TED4)	1560		0-N1062	TB [TE]	
1.6 HDi	02/07-	9HZ (DV6TED4)	1560		0-N1066	TB [DG]	
1.6 HDi	08/09-	9HR (DV6C)	1560		0-N2224	TB [TE]	
1.6 HDi	08/09-	9HR (DV6C)	1560		0-N2382	TB [DG]	
1.6 16V, 1.6 16V Turbo	02/07-	5FR (EP6DT), EP6CDT, 5FS (EP6C), 5FW (EP6), EP6, 5FX (EP6DT)	1598	☼	0-N2055	VB [BT]	S
1.6 16V, 1.6 16V Turbo	02/07-	5FR (EP6DT), EP6CDT, 5FS (EP6C), 5FW (EP6), EP6, 5FX (EP6DT)	1598	für OE: 11 28 7 598 832, 11 28 7 598 833	0-N2237	VB [DG]	
1.6 HDi	02/07-	9HZ (DV6TED4)	1560	03/2007 →; Orga.11074→	0-N1502	VB [BT]	S
1.6 HDi	02/07-	9HZ (DV6TED4)	1560	Orga.→11073	0-N1807	VB [DG]	
1.6 HDi	02/07-	9HZ (DV6TED4)	1560	Orga.→11073; ☼	0-N1924	VB [DG]	
1.6 HDi	08/09-	9HR (DV6C)	1560		0-N1502	VB [BT]	S

207 Stufenheck

1.4	12/07-	KFT (TU3A), KFV (TU3A)	1360	17x104	SK-1354	BTK	
1.4	12/07-	KFT (TU3A), KFV (TU3A)	1360	17x104	SK-1354AQ1	BTKW	
1.6 Bioflex	01/08-	N6A (TU5JP4)	1587	25.4x134	SK-1615	BTK	
1.6 Bioflex	01/08-	N6A (TU5JP4)	1587	25.4x134	SK-1615AQ1	BTKW	
1.6 Bioflex	01/08-	N6A (TU5JP4)	1587		0-N1359	TB [TE]	
1.6 Bioflex	01/08-	N6A (TU5JP4)	1587		0-N1360	TB [DG]	
1.4	12/07-	KFT (TU3A), KFV (TU3A)	1360		0-N1673	VB [BT]	S
1.6 Bioflex	01/08-	N6A (TU5JP4)	1587	☼	0-N1673	VB [BT]	S

207 SW (WK_)

1.4	06/07-	KFV (TU3A)	1360	17x104	SK-1354	BTK	
1.4	06/07-	KFV (TU3A)	1360	17x104	SK-1354AQ1	BTKW	
1.6 HDi	06/07-	9HX (DV6ATED4), 9HZ (DV6ATED4)	1560	25x137	SK-1424	BTK	
1.6 HDi	06/07-	9HX (DV6ATED4), 9HZ (DV6ATED4)	1560	25x137	SK-1424AQ1	BTKW	
1.6 HDi	08/09-	9HP (DV6DTEd), 9HR (DV6C)	1560	25x141	SK-1728	BTK	
1.6 HDi	08/09-	9HP (DV6DTEd), 9HR (DV6C)	1560	25x141	SK-1728AQ1	BTKW	

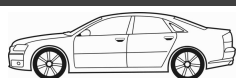

CM³



Art. Nr.



207 SW (WK_)							
1.4	06/07-	KFV (TU3A)	1360			0-N1277	TB [TE]
1.6 HDi	06/07-	9HX (DV6ATED4), 9HZ (DV6TED4)	1560			0-N1062	TB [TE]
1.6 HDi	06/07-	9HX (DV6ATED4), 9HZ (DV6TED4)	1560			0-N1066	TB [DG]
1.6 HDi	08/09-	9HP (DV6DTED), 9HR (DV6C)	1560			0-N2224	TB [TE]
1.6 HDi	08/09-	9HP (DV6DTED), 9HR (DV6C)	1560			0-N2382	TB [DG]
1.4	06/07-	KFV (TU3A)	1360			0-N1673	VB [BT] S
1.4 16V	06/07-	8FS (EP3), EP3, EP3C	1397	☼		0-N2055	VB [BT] S
1.4 16V	06/07-	8FR (EP3), 8FS (EP3), EP3, EP3C	1397	für OE: 11 28 7 598 832, 11 28 7 598 833		0-N2237	VB [DG]
1.6 16V, 1.6 16V RC	02/07-	5FS (EP6C), 5FW (EP6), EP6, 5FY (EP6DTS)	1598	☼		0-N2055	VB [BT] S
1.6 16V, 1.6 16V RC	02/07-	5FS (EP6C), 5FW (EP6), EP6, 5FY (EP6DTS)	1598	für OE: 11 28 7 598 832, 11 28 7 598 833		0-N2237	VB [DG]
1.6 HDi	06/07-	9HP (DV6DTED), 9HR (DV6C), 9HX (DV6ATED4), 9HZ (DV6TED4)	1560			0-N1502	VB [BT] S
1.6 HDi	06/07-	9HX (DV6ATED4), 9HZ (DV6TED4)	1560	Orga.→11073		0-N1807	VB [DG]
1.6 HDi	06/07-	9HX (DV6ATED4), 9HZ (DV6TED4)	1560	Orga.→11073; ☼		0-N1924	VB [DG]
207 Van							
1.4 HDi	04/07-	8HZ (DV4TD)	1398	25.4x144		SK-1391	BTK
1.4 HDi	04/07-	8HZ (DV4TD)	1398	25.4x144		SK-1391AQ1	BTKW
1.4 HDi	04/07-	DV4C	1398	25.4x139		SK-1732	BTK
1.4 HDi	04/07-	DV4C	1398	25.4x139		SK-1732AQ1	BTKW
1.6 HDi	04/07-	9HX (DV6ATED4)	1560	25x137		SK-1424	BTK
1.6 HDi	04/07-	9HX (DV6ATED4)	1560	25x137		SK-1424AQ1	BTKW
1.4 HDi	04/07-	8HZ (DV4TD)	1398			0-N1062	TB [TE]
1.4 HDi	04/07-	8HZ (DV4TD)	1398			0-N1066	TB [DG]
1.6 HDi	04/07-	9HX (DV6ATED4)	1560			0-N1062	TB [TE]
1.6 HDi	04/07-	9HX (DV6ATED4)	1560			0-N1066	TB [DG]
1.4 HDi	04/07-	8HZ (DV4TD)	1398	Orga.11074→		0-N1502	VB [BT] S
1.4 HDi	04/07-	8HZ (DV4TD)	1398	☼		0-N1807	VB [DG]
1.4 HDi	04/07-	8HZ (DV4TD)	1398	☼		0-N1807	VB [DG]
1.4 HDi	04/07-	8HZ (DV4TD)	1398			0-N1808	VB [BT] S
1.6 HDi	04/07-	9HX (DV6ATED4)	1560	Orga.11074→		0-N1502	VB [BT] S
1.6 HDi	04/07-	9HX (DV6ATED4)	1560	Orga.→11073; ☼		0-N1807	VB [DG]
208							
1.4 HDi	03/12-	8HP (DV4C), 8HR (DV4C)	1398	25.4x139		SK-1732	BTK
1.4 HDi	03/12-	8HP (DV4C), 8HR (DV4C)	1398	25.4x139		SK-1732AQ1	BTKW
1.6 HDi	03/12-	9HP (DV6DTED)	1560	25x141		SK-1728	BTK
1.6 HDi	03/12-	DV6C	1560	25x141		SK-1728	BTK
1.6 HDi	03/12-	9HP (DV6DTED)	1560	25x141		SK-1728AQ1	BTKW
1.6 HDi	03/12-	DV6C	1560	25x141		SK-1728AQ1	BTKW
1.0	03/12-	ZMZ (EB0)	999			0-N2424	TB [DG]
1.2, 1.2 THP	03/12-	HMZ (EB2F), HNZ (EB2DT)	1199			0-N2424	TB [DG]
1.4 HDi	03/12-	8HP (DV4C), 8HR (DV4C)	1398			0-N2224	TB [TE]
1.4 HDi	03/12-	8HP (DV4C), 8HR (DV4C)	1398			0-N2382	TB [DG]
1.6 BlueHDi 100, 1.6 BlueHDi 120, 1.6 HDi	03/12-	9HP (DV6DTED), BHY (DV6FD), BHZ (DV6FC)	1560			0-N2382	TB [DG]
1.6 HDi	03/12-	9HD (DV6CTED), 9HP (DV6DTED)	1560			0-N2224	TB [TE]
1.6 HDi	03/12-	DV6C	1560			0-N2382	TB [DG]
1.6 HDi	01/13-	DV6C	1560			0-N2224	TB [TE]
1.0	03/12-	ZMZ (EB0)	999	☼		0-N1419	VB [DG]
1.2	03/12-	HMZ (EB2F)	1199	☼		0-N1419	VB [DG]
1.4	03/12-	8FS (EP3), EP3C	1397			0-N2055	VB [BT] S
1.4	03/12-	8FS (EP3), EP3C	1397	für OE: 11 28 7 598 832, 11 28 7 598 833		0-N2237	VB [DG]
1.4 HDi	03/12-	8HP (DV4C), 8HR (DV4C)	1398	für Fahrzeuge ohne Start-Stopp-Funktion		0-N1502	VB [BT] S
1.4 HDi	03/12-	8HP (DV4C), 8HR (DV4C)	1398	Rippenanzahl: 6; für Fahrzeuge mit Start-Stopp-Funktion, ☼		0-N2355	VB [DG]
1.4 HDi	03/12-	8HP (DV4C), 8HR (DV4C)	1398	für Fahrzeuge mit Start-Stopp-Funktion		0-N2392	VB [BT] S
1.6	03/12-	EP6C	1598	für OE: 11 28 7 598 832, 11 28 7 598 833		0-N2237	VB [DG]
1.6 HDi	03/12-	9HP (DV6DTED)	1560	für Fahrzeuge ohne Start-Stopp-Funktion		0-N1502	VB [BT] S
1.6 HDi	03/12-	9HP (DV6DTED)	1560	Rippenanzahl: 6; für Fahrzeuge mit Start-Stopp-Funktion, ☼		0-N2355	VB [DG]
1.6 HDi	03/12-	9HP (DV6DTED)	1560	für Fahrzeuge mit Start-Stopp-Funktion		0-N2392	VB [BT] S
1.6, 1.6 GTi	03/12-	5FU (EP6CDTX), 5FV (EP6DT), EP6CDT	1598	für OE: 11 28 7 598 832, 11 28 7 598 833		0-N2237	VB [DG]
301							
1.6 HDi 92	11/12-	9HF (DV6DTED)	1560	25x141		SK-1728	BTK
1.6 HDi 92	11/12-	9HF (DV6DTED)	1560	25x141		SK-1728AQ1	BTKW



OPTIMAL®

PEUGEOT



CM³



Art. Nr.



301							
1.6 VTi 115	11/12-	NFP (EC5)	1587	25.4x134	SK-1615	BTK	
1.2 VTi 72	11/12-	HMY (EB2M)	1199		0-N2424	TB [DG]	
1.6 HDI 92	11/12-	9HF (DV6DTE)	1560		0-N2224	TB [TE]	
1.6 HDI 92	11/12-	9HF (DV6DTE)	1560		0-N2382	TB [DG]	
1.6 HDI 92	11/12-	9HF (DV6DTE)	1560		0-N1502	VB [BT]	S
1.6 VTi 115	11/12-	NFP (EC5)	1587	*	0-N1673	VB [BT]	S

305 II (581M)							
1.6	10/82-12/88	171 (XU5S), B1A (XU51C), BAZ (XU5CP)	1580	17x113	SK-1006	BTK	
1.8 D	11/82-12/88	161A (XUD7)	1769	25.39x136; Baumuster: 581_	SK-1007	BTK	
1.8 D	11/82-12/88	161A (XUD7)	1769	25.4x136	SK-1007AQ1	BTKW	
1.9	10/82-12/88	159 (XU9S), DFZ (XU9J1)	1905	17x113	SK-1006	BTK	
1.9 D	10/82-07/88	162 (XUD9), 162 (XUD9), D9A (XUD9)	1905	25.39x136; Baumuster: 581_	SK-1007	BTK	
1.9 D	10/82-07/88	162 (XUD9), 162 (XUD9), D9A (XUD9)	1905	25.4x136; 10/1986 →	SK-1007AQ1	BTKW	
1.6	10/82-12/88	171 (XU5S), B1A (XU51C), BAZ (XU5CP)	1580		0-N812	TB [TE]	
1.9	10/82-12/88	159 (XU9S), DFZ (XU9J1)	1905		0-N812	TB [TE]	
1.9 D	10/82-07/88	162 (XUD9), 162 (XUD9), D9A (XUD9)	1905		0-N813	TB [TE]	
1.9 D	10/82-07/88	162 (XUD9), 162 (XUD9), D9A (XUD9)	1905		0-N814	TB [DG]	
1.9 D	10/82-07/88	162 (XUD9), 162 (XUD9), D9A (XUD9)	1905		0-N2349	VB [DG]	

305 II Break (581E)							
1.6	09/83-12/88	171 (XU5S), B1A (XU51C), BAZ (XU5CP)	1580	17x113	SK-1006	BTK	
1.8 D	11/82-12/88	161A (XUD7)	1769	25.39x136; Baumuster: 581_	SK-1007	BTK	
1.8 D	11/82-12/88	161A (XUD7)	1769	25.4x136	SK-1007AQ1	BTKW	
1.9	09/84-12/88	159 (XU9S), DFZ (XU9J1)	1905	17x113	SK-1006	BTK	
1.9 Diesel	10/82-12/88	162 (XUD9), 162 (XUD9), D9A (XUD9)	1905	25.39x136; Baumuster: 581_	SK-1007	BTK	
1.9 Diesel	10/82-12/88	162 (XUD9), 162 (XUD9), D9A (XUD9)	1905	25.4x136; 10/1986 →	SK-1007AQ1	BTKW	
1.6	09/83-12/88	171 (XU5S), B1A (XU51C), BAZ (XU5CP)	1580		0-N812	TB [TE]	
1.9	09/84-12/88	159 (XU9S), DFZ (XU9J1)	1905		0-N812	TB [TE]	
1.9 Diesel	10/82-12/88	162 (XUD9), 162 (XUD9), D9A (XUD9)	1905		0-N813	TB [TE]	
1.9 Diesel	10/82-12/88	162 (XUD9), 162 (XUD9), D9A (XUD9)	1905		0-N814	TB [DG]	
1.9 Diesel	10/82-12/88	162 (XUD9), 162 (XUD9), D9A (XUD9)	1905		0-N2349	VB [DG]	

306 (7B, N3, N5)							
1.1	06/94-05/01	HDZ (TU1M)	1124	17x104	SK-1003	BTK	
1.1	06/94-05/01	HDZ (TU1M)	1124	17x104; :→3762434	SK-1003AQ1	BTKW	
1.1	06/94-05/01	HDZ (TU1M)	1124	17x100; :3762434 →	SK-1353	BTK	
1.1	06/94-05/01	HDZ (TU1M)	1124	17x100; :3762434 →	SK-1353AQ1	BTKW	
1.4 SL	06/94-05/01	TU3M	1360	17x108	SK-1004	BTK	
1.4 SL	06/94-05/01	TU3JP	1360	17x108; :→3666765	SK-1004	BTK	
1.4 SL	06/94-05/01	KDX (TU3MC), KFW (TU3JP), KFX (TU3JP)	1360	17x108; :→3666766	SK-1004AQ1	BTKW	
1.4 SL	06/94-05/01	TU3JP	1360	17x104; :3666766 →	SK-1354	BTK	
1.4 SL	06/94-05/01	TU3JP	1360	17x104; :3666766 →	SK-1354AQ1	BTKW	
1.6, 1.6 SR	06/94-05/01	NFT (TU5JP), NFZ (TU5JP)	1587	17x101	SK-1020	BTK	
1.6, 1.6 SR	06/94-05/01	NFT (TU5JP), NFZ (TU5JP)	1587	17x101	SK-1020AQ1	BTKW	
1.8	10/95-04/97	LFZ (XU7JP)	1761	17x114	SK-1019	BTK	
1.8 16V	03/97-05/01	LFY (XU7JP4)	1761	25x136; Abgasnorm: Euro 2; mit Zubehör; Spannrollenbetätigung: automatisch	SK-1399	BTK	
1.8 16V	03/97-05/01	LFY (XU7JP4)	1761	25x136; Abgasnorm: Euro 3 (D3); mit Zubehör; Spannrollenbetätigung: automatisch	SK-1399	BTK	
1.8 16V	03/97-05/01	LFY (XU7JP4)	1761	25x136; Abgasnorm: Euro 2; mit Zubehör; Spannrollenbetätigung: automatisch	SK-1399AQ1	BTKW	
1.8 ST	06/94-05/01	LFZ (XU7JP)	1762	17x114	SK-1019	BTK	
1.9 D	09/98-05/01	WJY (DW8B), WJZ (DW8)	1868	25.4x140; 05/1999 →	SK-1086	BTK	
1.9 D	09/98-05/01	DW8	1868	25.4x140	SK-1086AQ1	BTKW	
1.9 D, 1.9 SLD, 1.9 SRDT	06/94-05/01	DHV (XUD9BSD), DHY (XUD9TE), DJZ (XUD9Y)	1905	25.4x136	SK-1022	BTK	
1.9 SLD	06/94-05/01	DJY (XUD9A)	1905	25.4x136; 05/1997 →	SK-1022	BTK	
1.9 SLD	06/94-05/01	DJY (XUD9A)	1905	25.4x136; 01/1996 →	SK-1022AQ2	BTKW	
1.9 SRDT	06/94-05/01	DHY (XUD9TE)	1905	25.4x136	SK-1022AQ2	BTKW	
2.0	03/97-05/01	RFV (XU10J4R)	1998	25x136	SK-1082	BTK	
2.0	03/97-05/01	RFV (XU10J4R)	1998	25x136	SK-1082AQ2	BTKW	
2.0 HDI 90	06/99-05/01	RHY (DW10TD)	1997	25x141; → 04/2000; Orga.→08560; mit Zubehör	SK-1085	BTK	
2.0 HDI 90	06/99-05/01	RHY (DW10TD)	1997	25.4x141; mit Zubehör	SK-1085AQ1	BTKW	
2.0 S16	06/94-05/01	RFT (XU10J4), RFY (XU10J4Z)	1998	25.4x134	SK-1158	BTK	
2.0 ST	07/94-05/01	RFX (XU10J2)	1998	17x114	SK-1019	BTK	
1.1	06/94-05/01	HDZ (TU1M)	1124	:3762434 →	0-N1277	TB [TE]	



CM³



Art. Nr.



306 (7B, N3, N5)

1.1	06/94-05/01	HDZ (TU1M)	1124	ENGINES: →3762433	0-N811	TB [TE]	
1.4 SL	06/94-05/01	KDX (TU3MC), KFW (TU3JP), KFX (TU3JP)	1360	ENGINES: 3666766 →	0-N1277	TB [TE]	
1.4 SL	06/94-05/01	KDX (TU3MC), KFW (TU3JP), KFX (TU3JP)	1360	ENGINES: →3666765	0-N811	TB [TE]	
1.6, 1.6 SR	06/94-05/01	NFT (TU5JP), NFZ (TU5JP)	1587		0-N811	TB [TE]	
1.8	10/95-04/97	LFZ (XU7JP)	1761		0-N811	TB [TE]	
1.8 16V	03/97-05/01	LFY (XU7JP4)	1761		0-N1058	TB [TE]	
1.8 16V	03/97-05/01	LFY (XU7JP4)	1761		0-N862	TB [DG]	
1.8 ST	06/94-05/01	LFZ (XU7JP)	1762		0-N811	TB [TE]	
1.9 D	09/98-05/01	WJY (DW8B), WJZ (DW8)	1868		0-N118P	TB [TE]	
1.9 D	09/98-05/01	WJY (DW8B), WJZ (DW8)	1868		0-N1381	TB [DG]	
1.9 D, 1.9 SLD, 1.9 SRDT, 1.9 STD	02/94-05/01	DHV (XUD9BSD), DHY (XUD9TE), DHY (XUD9TE), XUD9TE, DJY (XUD9A), DJZ (XUD9Y), XUD9	1905		0-N900	TB [DG]	
1.9 D, 1.9 SLD, 1.9 SRDT, 1.9 STD	02/94-05/01	DHV (XUD9BSD), DHY (XUD9TE), DHY (XUD9TE), XUD9TE, DJY (XUD9A), DJZ (XUD9Y), XUD9	1905		0-N901	TB [TE]	
2.0	03/97-05/01	RFV (XU10J4R)	1998		0-N862	TB [DG]	
2.0	03/97-05/01	RFV (XU10J4R)	1998		0-N943	TB [TE]	
2.0 HDI 90	06/99-05/01	RHY (DW10TD)	1997	Orga. →09065	0-N118P	TB [TE]	
2.0 HDI 90	06/99-05/01	RHY (DW10TD)	1997	Orga. →09065	0-N119P	TB [DG]	
2.0 HDI 90	06/99-05/01	RHY (DW10TD)	1997	Orga.09066 →	0-N1381	TB [DG]	
2.0 S16	06/94-05/01	RFT (XU10J4), RFY (XU10J4Z)	1998		0-N869	TB [TE]	
2.0 S16	06/94-05/01	RFT (XU10J4), RFY (XU10J4Z)	1998		0-N911	TB [DG]	
2.0 ST	07/94-05/01	RFX (XU10J2)	1998		0-N811	TB [TE]	
1.1	06/94-05/01	HDZ (TU1M)	1124		0-N125	VB [TE]	S
1.4 SL	06/94-05/01	KDX (TU3MC), KFW (TU3JP), KFX (TU3JP)	1360		0-N125	VB [TE]	S
1.4 SL	06/94-05/01	KDX (TU3MC), KFW (TU3JP), KFX (TU3JP)	1360	mit Grundträger	0-N2337	VB [TE]	
1.6, 1.6 SR	06/94-05/01	NFT (TU5JP), NFZ (TU5JP)	1587		0-N125	VB [TE]	S
1.8 16V	03/97-05/01	LFY (XU7JP4)	1761	Orga. →7904	0-N124	VB [TE]	
1.8 16V	03/97-05/01	LFY (XU7JP4)	1761	Generator-Ladestrom [A]: 90; ⚡	0-N1402	VB [DG]	S
1.8 16V	03/97-05/01	LFY (XU7JP4)	1761	Generator-Ladestrom [A]: 120; ⚡	0-N1465S	VB [DG]	
1.8 16V	03/97-05/01	LFY (XU7JP4)	1761	Orga.7905 →; ⚡	0-N1968	VB [BT]	
1.8 ST	06/94-05/01	LFZ (XU7JP)	1762		0-N124	VB [TE]	
1.8 ST	06/94-05/01	LFZ (XU7JP)	1762	⚡	0-N1405	VB [DG]	
1.8 ST	06/94-05/01	LFZ (XU7JP)	1762	⚡	0-N1484	VB [BT]	S
1.8, 1.8 16V	10/95-05/01	LFY (XU7JP4), LFZ (XU7JP)	1761	⚡	0-N1484	VB [BT]	S
1.9 D	02/94-04/97	DHY (XUD9TE), XUD9TE	1905	10/1995 →; ⚡	0-N1320	VB [TE]	
1.9 D	03/98-05/01	DHV (XUD9BSD)	1905	⚡	0-N1320	VB [TE]	
1.9 D	03/98-05/01	DHV (XUD9BSD)	1905	⚡	0-N1472	VB [BT]	S
1.9 D	03/98-05/01	DHV (XUD9BSD)	1905	⚡	0-N1747	VB [VD]	
1.9 D	09/98-05/01	DW8B	1868	für Fahrzeuge mit Servolenkung	0-N1309	VB [DG]	
1.9 D	09/98-05/01	DW8	1868	Orga.08337 →; für Fahrzeuge mit Servolenkung	0-N1309	VB [DG]	
1.9 D	09/98-05/01	WJY (DW8B), WJZ (DW8)	1868		0-N1320	VB [TE]	
1.9 D	09/98-05/01	DW8	1868	Orga. →08336	0-N1455	VB [TE]	
1.9 D	09/98-05/01	DW8, DW8B	1868	Orga.08337 →; für Fahrzeuge mit Servolenkung, ⚡	0-N1471	VB [BT]	S
1.9 D	09/98-05/01	WJY (DW8B), WJZ (DW8)	1868	⚡, für Fahrzeuge mit Servolenkung	0-N1472	VB [BT]	S
1.9 D	09/98-05/01	WJY (DW8B), WJZ (DW8)	1868		0-N1545	VB [DG]	
1.9 D	09/98-05/01	WJY (DW8B), WJZ (DW8)	1868	⚡, ⚡, für Fahrzeuge ohne Servolenkung	0-N1681	VB [BT]	
1.9 D	09/98-05/01	WJY (DW8B), WJZ (DW8)	1868	⚡, für Fahrzeuge mit Servolenkung	0-N1747	VB [VD]	
1.9 D, 1.9 SLD, 1.9 SRDT	02/94-05/01	DHY (XUD9TE), DHY (XUD9TE), XUD9TE, DJY (XUD9A), DJZ (XUD9Y)	1905	10/1995 →; ⚡	0-N1472	VB [BT]	S
1.9 D, 1.9 SLD, 1.9 SRDT	02/94-05/01	DHY (XUD9TE), DHY (XUD9TE), XUD9TE, DJY (XUD9A), DJZ (XUD9Y)	1905	10/1995 →; ⚡	0-N1747	VB [VD]	
1.9 D, 1.9 SLD, 1.9 SRDT	02/94-05/01	DHY (XUD9TE), DHY (XUD9TE), XUD9TE, DJY (XUD9A), DJZ (XUD9Y)	1905	→ 10/1995; ⚡	0-N1751	VB [DG]	
1.9 D, 1.9 SLD, 1.9 SRDT	02/94-05/01	DHY (XUD9TE), DHY (XUD9TE), XUD9TE, DJY (XUD9A), DJZ (XUD9Y)	1905	→ 10/1995; ⚡	0-N1756	VB [BT]	
1.9 D, 1.9 SLD, 1.9 SRDT	06/94-05/01	DHV (XUD9BSD), DHY (XUD9TE), DJY (XUD9A), DJZ (XUD9Y)	1905		0-N931	VB [TE]	
1.9 SLD, 1.9 SRDT	06/94-05/01	DHY (XUD9TE), DJY (XUD9A), DJZ (XUD9Y)	1905	10/1995 →	0-N1320	VB [TE]	
1.9 STD	02/94-10/95	XUD9A	1905		0-N1320	VB [TE]	
1.9 STD	02/94-10/95	XUD9	1905		0-N1472	VB [BT]	S
1.9 STD	02/94-10/95	XUD9	1905		0-N1747	VB [VD]	
2.0	03/97-05/01	RFV (XU10J4R)	1998	⚡	0-N1463S	VB [DG]	
2.0	03/97-05/01	RFV (XU10J4R)	1998	⚡	0-N1484	VB [BT]	S



OPTIMAL®

PEUGEOT



CM³



Art. Nr.



ohne Halter

306 (7B, N3, N5)

2.0	03/97-05/01	RFV (XU10J4R)	1998	☼		0-N1713	VB [BT]	
2.0	03/97-05/01	RFV (XU10J4R)	1998	☼		0-N1722	VB [DG]	
2.0 HDI 90	06/99-05/01	RHY (DW10TD)	1997			0-N1320	VB [TE]	
2.0 HDI 90	06/99-05/01	RHY (DW10TD)	1997			0-N1493	VB [BT]	S
2.0 HDI 90	06/99-05/01	RHY (DW10TD)	1997	☼		0-N151	VB [DG]	
2.0 HDI 90	06/99-05/01	RHY (DW10TD)	1997	☼		0-N1747	VB [VD]	
2.0 HDI 90	06/99-05/01	RHY (DW10TD)	1997	☼		0-N1748	VB [BT]	
2.0 S16	06/94-05/01	RFT (XU10J4), RFY (XU10J4Z)	1998			0-N124	VB [TE]	
2.0 ST	07/94-05/01	RFY (XU10J2)	1998		Orga.→7174	0-N124	VB [TE]	

306 Break (7E, N3, N5)

1.4	03/97-04/02	KFW (TU3JP), KFX (TU3JP)	1360	17x108; :→3666765		SK-1004	BTK	
1.4	03/97-04/02	KFW (TU3JP), KFX (TU3JP)	1360	17x108; :→3666766		SK-1004AQ1	BTKW	
1.4	03/97-04/02	KFW (TU3JP), KFX (TU3JP)	1360	17x104; :3666766→		SK-1354	BTK	
1.4	03/97-04/02	KFW (TU3JP), KFX (TU3JP)	1360	17x104; :3666766→		SK-1354AQ1	BTKW	
1.6	03/97-04/02	NFT (TU5JP), NFZ (TU5JP)	1587	17x101		SK-1020	BTK	
1.6	03/97-04/02	NFT (TU5JP), NFZ (TU5JP)	1587	17x101		SK-1020AQ1	BTKW	
1.8	03/97-04/02	LFZ (XU7JP)	1762	17x114		SK-1019	BTK	
1.8 16V	03/97-04/02	LFY (XU7JP4)	1761	25x136; Abgasnorm: Euro 2; mit Zubehör; Spannrollenbetätigung: automatisch		SK-1399	BTK	
1.8 16V	03/97-04/02	LFY (XU7JP4)	1761	25x136; Abgasnorm: Euro 3 (D3); mit Zubehör; Spannrollenbetätigung: automatisch		SK-1399	BTK	
1.8 16V	03/97-04/02	LFY (XU7JP4)	1761	25x136; Abgasnorm: Euro 2; mit Zubehör; Spannrollenbetätigung: automatisch		SK-1399AQ1	BTKW	
1.9 D	09/98-04/02	WJY (DW8B), WJZ (DW8)	1868	25.4x140; 05/1999 →		SK-1086	BTK	
1.9 D	09/98-04/02	DW8	1868	25.4x140		SK-1086AQ1	BTKW	
1.9 D, 1.9 TD	02/97-04/02	DHV (XUD9BSD), DHY (XUD9TE), DJY (XUD9A)	1905	25.4x136		SK-1022	BTK	
1.9 D, 1.9 TD	02/97-04/02	DHY (XUD9TE), DJY (XUD9A)	1905	25.4x136		SK-1022AQ2	BTKW	
2.0	03/97-04/02	RFV (XU10J4R)	1998	25x136; 07/2000 →		SK-1082	BTK	
2.0	03/97-04/02	RFV (XU10J4R)	1998	25x136		SK-1082AQ2	BTKW	
2.0 HDI 90	06/99-04/02	RHY (DW10TD)	1997	25x141; → 04/2000; Orga.→08560; mit Zubehör		SK-1085	BTK	
2.0 HDI 90	06/99-04/02	RHY (DW10TD)	1997	25.4x141; mit Zubehör		SK-1085AQ1	BTKW	
1.4	03/97-04/02	KFW (TU3JP), KFX (TU3JP)	1360	:3666766→		0-N1277	TB [TE]	
1.4	03/97-04/02	KFW (TU3JP), KFX (TU3JP)	1360	:→3666765		0-N811	TB [TE]	
1.6	03/97-04/02	NFT (TU5JP), NFZ (TU5JP)	1587			0-N811	TB [TE]	
1.8	03/97-04/02	LFZ (XU7JP)	1762			0-N811	TB [TE]	
1.8 16V	03/97-04/02	LFY (XU7JP4)	1761			0-N1058	TB [TE]	
1.8 16V	03/97-04/02	LFY (XU7JP4)	1761			0-N862	TB [DG]	
1.9 D	09/98-04/02	WJY (DW8B), WJZ (DW8)	1868			0-N118P	TB [TE]	
1.9 D	09/98-04/02	WJY (DW8B), WJZ (DW8)	1868			0-N1381	TB [DG]	
1.9 D, 1.9 TD	02/97-04/02	DHV (XUD9BSD), DHY (XUD9TE), DJY (XUD9A)	1905			0-N900	TB [DG]	
1.9 D, 1.9 TD	02/97-04/02	DHV (XUD9BSD), DHY (XUD9TE), DJY (XUD9A)	1905			0-N901	TB [TE]	
2.0	03/97-04/02	RFV (XU10J4R)	1998			0-N862	TB [DG]	
2.0	03/97-04/02	RFV (XU10J4R)	1998			0-N943	TB [TE]	
2.0 HDI 90	06/99-04/02	RHY (DW10TD)	1997	Orga.→09065		0-N118P	TB [TE]	
2.0 HDI 90	06/99-04/02	RHY (DW10TD)	1997	Orga.→09065		0-N119P	TB [DG]	
2.0 HDI 90	06/99-04/02	RHY (DW10TD)	1997	Orga.09066→		0-N1381	TB [DG]	
1.4	03/97-04/02	KFW (TU3JP), KFX (TU3JP)	1360			0-N125	VB [TE]	S
1.4	03/97-04/02	KFW (TU3JP), KFX (TU3JP)	1360	mit Grundträger		0-N2337	VB [TE]	
1.6	03/97-04/02	NFT (TU5JP), NFZ (TU5JP)	1587			0-N125	VB [TE]	S
1.8	03/97-04/02	LFZ (XU7JP)	1762			0-N124	VB [TE]	
1.8	03/97-04/02	LFZ (XU7JP)	1762	☼		0-N1405	VB [DG]	
1.8	03/97-04/02	LFZ (XU7JP)	1762	☼		0-N1484	VB [BT]	S
1.8 16V	03/97-04/02	LFY (XU7JP4)	1761	Orga.→7904		0-N124	VB [TE]	
1.8 16V	03/97-04/02	LFY (XU7JP4)	1761	Generator-Ladestrom [A]: 90; ☼		0-N1402	VB [DG]	S
1.8 16V	03/97-04/02	LFY (XU7JP4)	1761	Generator-Ladestrom [A]: 120; ☼		0-N1465S	VB [DG]	
1.8 16V	03/97-04/02	LFY (XU7JP4)	1761	☼		0-N1484	VB [BT]	S
1.8 16V	03/97-04/02	LFY (XU7JP4)	1761	Orga.7905→; ☼		0-N1968	VB [BT]	
1.9 D	05/97-05/99	DJY (XUD9A)	1905			0-N1472	VB [BT]	S
1.9 D	05/97-05/99	DJY (XUD9A)	1905			0-N1747	VB [VD]	
1.9 D	09/98-04/02	DW8B	1868	für Fahrzeuge mit Servolenkung		0-N1309	VB [DG]	
1.9 D	09/98-04/02	DW8	1868	Orga.08337→; für Fahrzeuge mit Servolenkung		0-N1309	VB [DG]	

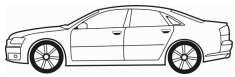

CM³



Art. Nr.



306 Break (7E, N3, N5)

1.9 D	09/98-04/02	WJY (DW8B), WJZ (DW8)	1868		0-N1320	VB [TE]	
1.9 D	09/98-04/02	DW8	1868	Orga.→08336	0-N1455	VB [TE]	
1.9 D	09/98-04/02	DW8, DW8B	1868	Orga.08337→; für Fahrzeuge mit Servolenkung, ⚙	0-N1471	VB [BT]	S
1.9 D	09/98-04/02	WJY (DW8B), WJZ (DW8)	1868	⚙, für Fahrzeuge mit Servolenkung	0-N1472	VB [BT]	S
1.9 D	09/98-04/02	WJY (DW8B), WJZ (DW8)	1868		0-N1545	VB [DG]	
1.9 D	09/98-04/02	WJY (DW8B), WJZ (DW8)	1868	⚙, ⚙, für Fahrzeuge ohne Servolenkung	0-N1681	VB [BT]	
1.9 D	09/98-04/02	WJY (DW8B), WJZ (DW8)	1868	⚙, für Fahrzeuge mit Servolenkung	0-N1747	VB [VD]	
1.9 D, 1.9 TD	02/97-04/02	DHV (XUD9BSD), DHY (XUD9TE), DJY (XUD9A)	1905		0-N1320	VB [TE]	
1.9 D, 1.9 TD	02/97-04/02	DHV (XUD9BSD), DHY (XUD9TE), DJY (XUD9A)	1905	⚙	0-N1472	VB [BT]	S
1.9 D, 1.9 TD	02/97-04/02	DHV (XUD9BSD), DHY (XUD9TE), DJY (XUD9A)	1905	⚙	0-N1747	VB [VD]	
1.9 D, 1.9 TD	02/97-04/02	DHV (XUD9BSD), DHY (XUD9TE), DJY (XUD9A)	1905		0-N931	VB [TE]	
2.0	03/97-04/02	RFV (XU10J4R)	1998	⚙	0-N1463S	VB [DG]	
2.0	03/97-04/02	RFV (XU10J4R)	1998	⚙	0-N1484	VB [BT]	S
2.0	03/97-04/02	RFV (XU10J4R)	1998	⚙	0-N1713	VB [BT]	
2.0	03/97-04/02	RFV (XU10J4R)	1998	⚙	0-N1722	VB [DG]	
2.0 HDI 90	06/99-04/02	RHY (DW10TD)	1997		0-N1320	VB [TE]	
2.0 HDI 90	06/99-04/02	RHY (DW10TD)	1997		0-N1493	VB [BT]	S
2.0 HDI 90	06/99-04/02	RHY (DW10TD)	1997	⚙	0-N151	VB [DG]	
2.0 HDI 90	06/99-04/02	RHY (DW10TD)	1997	⚙	0-N1747	VB [VD]	
2.0 HDI 90	06/99-04/02	RHY (DW10TD)	1997	⚙	0-N1748	VB [BT]	

306 Cabriolet (7D, N3, N5)

1.6	04/96-10/00	NFZ (TU5JP)	1587	17x101; 08/1996 →	SK-1020	BTK	
1.6	04/96-04/02	NFT (TU5JP), NFZ (TU5JP)	1587	17x101	SK-1020AQ1	BTKW	
1.6	10/00-04/02	NFT (TU5JP)	1587	17x101	SK-1020	BTK	
1.8	03/94-04/02	LFZ (XU7JP)	1762	17x114	SK-1019	BTK	
1.8 16V	07/00-04/02	LFY (XU7JP4)	1761	25x136; Abgasnorm: Euro 2; mit Zubehör; Spannrollenbetätigung: automatisch	SK-1399	BTK	
1.8 16V	07/00-04/02	LFY (XU7JP4)	1761	25x136; Abgasnorm: Euro 3 (D3); mit Zubehör; Spannrollenbetätigung: automatisch	SK-1399	BTK	
1.8 16V	07/00-04/02	LFY (XU7JP4)	1761	25x136; Abgasnorm: Euro 2; mit Zubehör; Spannrollenbetätigung: automatisch	SK-1399AQ1	BTKW	
2.0	03/94-04/02	RFX (XU10J2)	1998	17x114	SK-1019	BTK	
2.0 16V	03/97-04/02	RFV (XU10J4R)	1998	25x136	SK-1082	BTK	
2.0 16V	03/97-04/02	RFV (XU10J4R)	1998	25x136	SK-1082AQ2	BTKW	
1.6	04/96-04/02	NFT (TU5JP), NFZ (TU5JP)	1587		0-N811	TB [TE]	
1.8	03/94-04/02	LFZ (XU7JP)	1762		0-N811	TB [TE]	
1.8 16V	07/00-04/02	LFY (XU7JP4)	1761		0-N1058	TB [TE]	
1.8 16V	07/00-04/02	LFY (XU7JP4)	1761		0-N862	TB [DG]	
2.0	03/94-04/02	RFX (XU10J2)	1998		0-N811	TB [TE]	
2.0 16V	03/97-04/02	RFV (XU10J4R)	1998		0-N862	TB [DG]	
2.0 16V	03/97-04/02	RFV (XU10J4R)	1998		0-N943	TB [TE]	
1.6	04/96-04/02	NFT (TU5JP), NFZ (TU5JP)	1587		0-N125	VB [TE]	S
1.8	03/94-04/02	LFZ (XU7JP)	1762		0-N124	VB [TE]	
1.8	03/94-04/02	LFZ (XU7JP)	1762	⚙	0-N1405	VB [DG]	
1.8	03/94-04/02	LFZ (XU7JP)	1762	⚙	0-N1484	VB [BT]	S
1.8 16V	07/00-04/02	LFY (XU7JP4)	1761	Orga.→7904	0-N124	VB [TE]	
1.8 16V	07/00-04/02	LFY (XU7JP4)	1761	Generator-Ladestrom [A]: 90; ⚙	0-N1402	VB [DG]	S
1.8 16V	07/00-04/02	LFY (XU7JP4)	1761	Generator-Ladestrom [A]: 120; ⚙	0-N1465S	VB [DG]	
1.8 16V	07/00-04/02	LFY (XU7JP4)	1761	⚙	0-N1484	VB [BT]	S
1.8 16V	07/00-04/02	LFY (XU7JP4)	1761	Orga.7905→; ⚙	0-N1968	VB [BT]	
2.0	03/94-04/02	RFX (XU10J2)	1998	Orga.→7174	0-N124	VB [TE]	
2.0 16V	03/97-04/02	RFV (XU10J4R)	1998	⚙	0-N1463S	VB [DG]	
2.0 16V	03/97-04/02	RFV (XU10J4R)	1998	⚙	0-N1484	VB [BT]	S
2.0 16V	03/97-04/02	RFV (XU10J4R)	1998	⚙	0-N1713	VB [BT]	
2.0 16V	03/97-04/02	RFV (XU10J4R)	1998	⚙	0-N1722	VB [DG]	

306 Schrägheck (7A, 7C, N3, N5)

1.1	05/93-05/01	HDZ (TU1M)	1124	17x104	SK-1003	BTK	
1.1	05/93-05/01	HDZ (TU1M)	1124	17x104; ⚙:→3762434	SK-1003AQ1	BTKW	
1.1	05/93-05/01	HDZ (TU1M)	1124	17x100; ⚙:3762434→	SK-1353	BTK	
1.1	05/93-05/01	HDZ (TU1M)	1124	17x100; ⚙:3762434→	SK-1353AQ1	BTKW	
1.4	05/93-05/01	TU3M	1360	17x108	SK-1004	BTK	



OPTIMAL®

PEUGEOT



CM³



Art. Nr.



306 Schrägheck (7A, 7C, N3, N5)

1.4	05/93-05/01	TU3JP	1360	17x108; :→3666765	SK-1004	BTK	
1.4	05/93-05/01	KDX (TU3MC), KFW (TU3JP), KFX (TU3JP)	1360	17x108; :→3666766	SK-1004AQ1	BTkW	
1.4	05/93-05/01	TU3JP	1360	17x104; :3666766→	SK-1354	BTK	
1.4	05/93-05/01	TU3JP	1360	17x104; :3666766→	SK-1354AQ1	BTkW	
1.6	05/93-05/01	NFT (TU5JP), NFZ (TU5JP)	1587	17x101	SK-1020	BTK	
1.6	05/93-05/01	NFT (TU5JP), NFZ (TU5JP)	1587	17x101	SK-1020AQ1	BTkW	
1.8	05/93-05/01	LFZ (XU7JP)	1762	17x114	SK-1019	BTK	
1.8	05/97-04/99	LFZ (XU7JP)	1761	17x114	SK-1019	BTK	
1.8 16V	03/97-05/01	LFY (XU7JP4)	1761	25x136; Abgasnorm: Euro 2; mit Zubehör; Spannrollenbetätigung: automatisch	SK-1399	BTK	
1.8 16V	03/97-05/01	LFY (XU7JP4)	1761	25x136; Abgasnorm: Euro 3 (D3); mit Zubehör; Spannrollenbetätigung: automatisch	SK-1399	BTK	
1.8 16V	03/97-05/01	LFY (XU7JP4)	1761	25x136; Abgasnorm: Euro 2; mit Zubehör; Spannrollenbetätigung: automatisch	SK-1399AQ1	BTkW	
1.8 D	05/93-05/01	A9A (XUD7)	1769	25.39x136; → 12/1993; Baumuster: A9A	SK-1007	BTK	
1.8 D	05/93-05/01	A9A (XUD7)	1769	25.4x136; → 12/1993	SK-1007AQ1	BTkW	
1.8 D	05/93-05/01	A9A (XUD7)	1769	25.4x136; 01/1994 →; Baumuster: A9A	SK-1022	BTK	
1.8 D	05/93-05/01	A9A (XUD7)	1769	25.4x136; 02/1996 →	SK-1022AQ2	BTkW	
1.9 D	04/93-05/99	XUD9	1905	25.4x136; → 12/1993	SK-1007AQ1	BTkW	
1.9 D	06/94-05/01	DHV (XUD9BSD), DJY (XUD9A)	1905	25.4x136	SK-1022	BTK	
1.9 D	06/94-05/01	DJY (XUD9A)	1905	25.4x136; 01/1996 →	SK-1022AQ2	BTkW	
1.9 D	09/98-05/01	WJY (DW8B), WJZ (DW8)	1868	25.4x140; 05/1999 →	SK-1086	BTK	
1.9 D	09/98-05/01	DW8	1868	25.4x140	SK-1086AQ1	BTkW	
1.9 D, 1.9 DT	04/93-05/01	DHY (XUD9TE), DJZ (XUD9Y), XUD9	1905	25.39x136; → 12/1993	SK-1007	BTK	
1.9 D, 1.9 DT	05/93-05/01	DHY (XUD9TE), DJZ (XUD9Y)	1905	25.4x136	SK-1007AQ1	BTkW	
1.9 D, 1.9 DT	05/93-05/01	DHY (XUD9TE), DJZ (XUD9Y)	1905	25.4x136; 01/1994 →	SK-1022	BTK	
1.9 DT	05/93-05/01	DHY (XUD9TE)	1905	25.4x136; 01/1994 →	SK-1022AQ2	BTkW	
2.0 16V	03/97-05/01	RFV (XU10J4R)	1998	25x136; 07/2000 →	SK-1082	BTK	
2.0 16V	03/97-06/00	RFV (XU10J4R)	1998	25x136	SK-1082	BTK	
2.0 16V	03/97-05/01	RFV (XU10J4R)	1998	25x136	SK-1082AQ2	BTkW	
2.0 HDI 90	06/99-05/01	RHY (DW10TD)	1997	25x141; → 04/2000; Orga.→08560; mit Zubehör	SK-1085	BTK	
2.0 HDI 90	06/99-05/01	RHY (DW10TD)	1997	25.4x141; mit Zubehör	SK-1085AQ1	BTkW	
2.0 S16	05/93-05/01	RFT (XU10J4), RFY (XU10J4Z)	1998	25.4x134	SK-1158	BTK	
2.0 S16	03/96-05/01	RFS (XU10J4RS)	1998	25x136; 07/1996 → 03/2000; Orga.→08546	SK-1082	BTK	
2.0 S16	03/96-05/01	RFS (XU10J4RS)	1998	25x136; → 03/2000; Orga.→8546	SK-1082AQ2	BTkW	
2.0 S16	03/96-05/01	RFS (XU10J4RS)	1998	25.4x137; mit Zubehör	SK-1613	BTK	
2.0 XSi	05/93-05/01	RFX (XU10J2)	1998	17x114	SK-1019	BTK	
1.1	05/93-05/01	HDZ (TU1M)	1124	:3762434→	0-N1277	TB [TE]	
1.1	05/93-05/01	HDZ (TU1M)	1124	:→3762433	0-N811	TB [TE]	
1.4	05/93-05/01	KDX (TU3MC), KFW (TU3JP), KFX (TU3JP)	1360	:3666766→	0-N1277	TB [TE]	
1.4	05/93-05/01	KDX (TU3MC), KFW (TU3JP), KFX (TU3JP)	1360	:→3666765	0-N811	TB [TE]	
1.6	05/93-05/01	NFT (TU5JP), NFZ (TU5JP)	1587		0-N811	TB [TE]	
1.8	05/93-05/01	LFZ (XU7JP)	1762		0-N811	TB [TE]	
1.8	05/97-04/99	LFZ (XU7JP)	1761		0-N811	TB [TE]	
1.8 16V	03/97-05/01	LFY (XU7JP4)	1761		0-N1058	TB [TE]	
1.8 16V	03/97-05/01	LFY (XU7JP4)	1761		0-N862	TB [DG]	
1.8 D	05/93-05/01	A9A (XUD7)	1769		0-N900	TB [DG]	
1.8 D	05/93-05/01	A9A (XUD7)	1769		0-N901	TB [TE]	
1.9 D	04/93-05/01	DHV (XUD9BSD), DHY (XUD9TE), XUD9TE, DJY (XUD9A), XUD9	1905		0-N900	TB [DG]	
1.9 D	04/93-05/01	DHV (XUD9BSD), DHY (XUD9TE), XUD9TE, DJY (XUD9A), XUD9	1905		0-N901	TB [TE]	
1.9 D	09/98-05/01	WJY (DW8B), WJZ (DW8)	1868		0-N118P	TB [TE]	
1.9 D	09/98-05/01	WJY (DW8B), WJZ (DW8)	1868		0-N1381	TB [DG]	
1.9 D, 1.9 DT	05/93-05/01	DHY (XUD9TE), DJZ (XUD9Y)	1905	→ 01/1994	0-N813	TB [TE]	
1.9 D, 1.9 DT	05/93-05/01	DHY (XUD9TE), DJZ (XUD9Y)	1905	→ 01/1994	0-N814	TB [DG]	
1.9 D, 1.9 DT	05/93-05/01	DHY (XUD9TE), DJZ (XUD9Y)	1905	02/1994 →	0-N900	TB [DG]	
1.9 D, 1.9 DT	05/93-05/01	DHY (XUD9TE), DJZ (XUD9Y)	1905	02/1994 →	0-N901	TB [TE]	
2.0 16V	03/97-05/01	RFV (XU10J4R)	1998		0-N943	TB [TE]	
2.0 16V, 2.0 S16	03/96-05/01	RFS (XU10J4RS), RFV (XU10J4R)	1998		0-N862	TB [DG]	
2.0 HDI 90	06/99-05/01	RHY (DW10TD)	1997	Orga.→09065	0-N118P	TB [TE]	
2.0 HDI 90	06/99-05/01	RHY (DW10TD)	1997	Orga.→09065	0-N119P	TB [DG]	
2.0 HDI 90	06/99-05/01	RHY (DW10TD)	1997	Orga.09066→	0-N1381	TB [DG]	
2.0 S16	05/93-05/01	RFT (XU10J4), RFY (XU10J4Z)	1998		0-N869	TB [TE]	
2.0 S16	05/93-05/01	RFT (XU10J4), RFY (XU10J4Z)	1998		0-N911	TB [DG]	

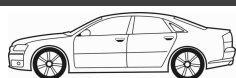

CM³



Art. Nr.



306 Schrägheck (7A, 7C, N3, N5)

2.0 S16	03/96-05/01	RFS (XU10J4RS)	1998	04/2000 →	0-N1356	TB [TE]	
2.0 S16	03/96-05/01	RFS (XU10J4RS)	1998	Orga.→08546	0-N943	TB [TE]	
2.0 XSi	05/93-05/01	RFX (XU10J2)	1998		0-N811	TB [TE]	
1.1	05/93-05/01	HDZ (TU1M)	1124		0-N125	VB [TE]	S
1.4	05/93-05/01	KDX (TU3MC), KFW (TU3JP), KFX (TU3JP)	1360		0-N125	VB [TE]	S
1.4	05/93-05/01	KDX (TU3MC), KFW (TU3JP), KFX (TU3JP)	1360	mit Grundträger	0-N2337	VB [TE]	
1.6	05/93-05/01	NFT (TU5JP), NFZ (TU5JP)	1587		0-N125	VB [TE]	S
1.8	05/93-05/01	LFZ (XU7JP)	1762		0-N124	VB [TE]	
1.8	05/93-05/01	LFZ (XU7JP)	1762	☼	0-N1405	VB [DG]	
1.8	05/93-05/01	LFZ (XU7JP)	1762	☼	0-N1484	VB [BT]	S
1.8 16V	03/97-05/01	LFY (XU7JP4)	1761	Orga.→7904	0-N124	VB [TE]	
1.8 16V	03/97-05/01	LFY (XU7JP4)	1761	Generator-Ladestrom [A]: 90; ☼	0-N1402	VB [DG]	S
1.8 16V	03/97-05/01	LFY (XU7JP4)	1761	Generator-Ladestrom [A]: 120; ☼	0-N1465S	VB [DG]	
1.8 16V	03/97-05/01	LFY (XU7JP4)	1761	Orga.7905→; ☼	0-N1968	VB [BT]	
1.8 D	05/93-05/01	A9A (XUD7)	1769		0-N931	VB [TE]	
1.8, 1.8 16V	03/97-05/01	LFY (XU7JP4), LFZ (XU7JP)	1761	☼	0-N1484	VB [BT]	S
1.9 D	04/93-04/97	DHY (XUD9TE), XUD9TE	1905	10/1995 →; ☼	0-N1320	VB [TE]	
1.9 D	04/93-05/99	XUD9A	1905		0-N1320	VB [TE]	
1.9 D	04/93-05/99	XUD9	1905		0-N1472	VB [BT]	S
1.9 D	04/93-05/99	XUD9	1905		0-N1747	VB [VD]	
1.9 D	03/98-05/01	DHV (XUD9BSD)	1905		0-N1320	VB [TE]	
1.9 D	03/98-05/01	DHV (XUD9BSD)	1905	☼	0-N1472	VB [BT]	S
1.9 D	03/98-05/01	DHV (XUD9BSD)	1905	☼	0-N1747	VB [VD]	
1.9 D	09/98-05/01	DW8B	1868	für Fahrzeuge mit Servolenkung	0-N1309	VB [DG]	
1.9 D	09/98-05/01	DW8	1868	Orga.08337→; für Fahrzeuge mit Servolenkung	0-N1309	VB [DG]	
1.9 D	09/98-05/01	WJY (DW8B), WJZ (DW8)	1868		0-N1320	VB [TE]	
1.9 D	09/98-05/01	DW8	1868	Orga.→08336	0-N1455	VB [TE]	
1.9 D	09/98-05/01	DW8, DW8B	1868	Orga.08337→; für Fahrzeuge mit Servolenkung, ☼	0-N1471	VB [BT]	S
1.9 D	09/98-05/01	WJY (DW8B), WJZ (DW8)	1868	☼, für Fahrzeuge mit Servolenkung	0-N1472	VB [BT]	S
1.9 D	09/98-05/01	WJY (DW8B), WJZ (DW8)	1868		0-N1545	VB [DG]	
1.9 D	09/98-05/01	WJY (DW8B), WJZ (DW8)	1868	☼, ☼, für Fahrzeuge ohne Servolenkung	0-N1681	VB [BT]	
1.9 D	09/98-05/01	WJY (DW8B), WJZ (DW8)	1868	☼, für Fahrzeuge mit Servolenkung	0-N1747	VB [VD]	
1.9 D, 1.9 DT	04/93-05/01	DHY (XUD9TE), DHY (XUD9TE), XUD9TE, DJY (XUD9A), DJZ (XUD9Y)	1905	10/1995 →; ☼	0-N1472	VB [BT]	S
1.9 D, 1.9 DT	04/93-05/01	DHY (XUD9TE), DHY (XUD9TE), XUD9TE, DJY (XUD9A), DJZ (XUD9Y)	1905	10/1995 →; ☼	0-N1747	VB [VD]	
1.9 D, 1.9 DT	04/93-05/01	DHY (XUD9TE), DHY (XUD9TE), XUD9TE, DJY (XUD9A), DJZ (XUD9Y)	1905	→ 10/1995; ☼	0-N1751	VB [DG]	
1.9 D, 1.9 DT	04/93-05/01	DHY (XUD9TE), DHY (XUD9TE), XUD9TE, DJY (XUD9A), DJZ (XUD9Y)	1905	→ 10/1995; ☼	0-N1756	VB [BT]	
1.9 D, 1.9 DT	05/93-05/01	DHY (XUD9TE), DJY (XUD9A), DJZ (XUD9Y)	1905	10/1995 →	0-N1320	VB [TE]	
1.9 D, 1.9 DT	05/93-05/01	DHV (XUD9BSD), DHY (XUD9TE), DJY (XUD9A), DJZ (XUD9Y)	1905		0-N931	VB [TE]	
2.0 16V, 2.0 S16	03/96-05/01	RFS (XU10J4RS), RFV (XU10J4R)	1998	☼	0-N1463S	VB [DG]	
2.0 16V, 2.0 S16	03/96-05/01	RFS (XU10J4RS), RFV (XU10J4R)	1998	☼	0-N1484	VB [BT]	S
2.0 16V, 2.0 S16	03/96-05/01	RFS (XU10J4RS), RFV (XU10J4R)	1998	☼	0-N1713	VB [BT]	
2.0 16V, 2.0 S16	03/96-05/01	RFS (XU10J4RS), RFV (XU10J4R)	1998	☼	0-N1722	VB [DG]	
2.0 HDI 90	06/99-05/01	RHY (DW10TD)	1997		0-N1320	VB [TE]	
2.0 HDI 90	06/99-05/01	RHY (DW10TD)	1997		0-N1493	VB [BT]	S
2.0 HDI 90	06/99-05/01	RHY (DW10TD)	1997	☼	0-N151	VB [DG]	
2.0 HDI 90	06/99-05/01	RHY (DW10TD)	1997	☼	0-N1747	VB [VD]	
2.0 HDI 90	06/99-05/01	RHY (DW10TD)	1997	☼	0-N1748	VB [BT]	
2.0 S16	05/93-05/01	RFT (XU10J4), RFY (XU10J4Z)	1998		0-N124	VB [TE]	
2.0 XSi	05/93-05/01	RFX (XU10J2)	1998	Orga.→7174	0-N124	VB [TE]	

307 (3A/C)

1.4	08/00-	KFW (TU3JP)	1360	17x108; →3666765	SK-1004	BTK	
1.4	08/00-	KFW (TU3JP)	1360	17x108; →3666765	SK-1004AQ1	BTKW	
1.4	08/00-	KFW (TU3JP)	1360	17x104; :3666766→	SK-1354	BTK	
1.4	08/00-	KFW (TU3JP)	1360	17x104; :3666766→	SK-1354AQ1	BTKW	
1.4 16V	11/03-	KFU (ET3J4)	1360	25x135	SK-1598	BTK	
1.4 16V	11/03-	KFU (ET3J4)	1360	25x135	SK-1598AQ1	BTKW	
1.4 HDi	10/01-	8HX (DV4TD), 8HZ (DV4TD)	1398	25.4x144	SK-1391	BTK	
1.4 HDi	10/01-	8HX (DV4TD), 8HZ (DV4TD)	1398	25.4x144	SK-1391AQ1	BTKW	



CM³



Art. Nr.



ohne Halter

307 (3A/C)

1.6 16V	08/00-	NFU (TU5JP4)	1587	25.4x134; 03/2001 →; :→1806404; mit Zubehör	SK-1392	BTK	
1.6 16V	08/00-	NFU (TU5JP4)	1587	25.4x134; 03/2001 →; :→1806404; mit Zubehör	SK-1392AQ1	BTKW	
1.6 16V	08/00-	NFU (TU5JP4)	1587	25.4x134; 03/2001 →; :1806405→	SK-1615	BTK	
1.6 16V	08/00-	NFU (TU5JP4)	1587	25.4x134; :1806405→	SK-1615AQ1	BTKW	
1.6 BioFlex	09/07-	NFU (TU5JP4)	1587	25.4x134; :→1806404; mit Zubehör	SK-1392	BTK	
1.6 BioFlex	09/07-	NFU (TU5JP4)	1587	25.4x134; :→1806404; mit Zubehör	SK-1392AQ1	BTKW	
1.6 BioFlex	09/07-	NFU (TU5JP4)	1587	25.4x134; :1806405→	SK-1615	BTK	
1.6 BioFlex	09/07-	NFU (TU5JP4)	1587	25.4x134	SK-1615AQ1	BTKW	
1.6 HDi, 1.6 HDi 110	02/04-	9HV (DV6ATED4), 9HV (DV6TED4), 9HX (DV6ATED4), 9HY (DV6TED4), 9HZ (DV6TED4)	1560	25x137	SK-1424	BTK	
1.6 HDi, 1.6 HDi 110	02/04-	9HV (DV6ATED4), 9HV (DV6TED4), 9HX (DV6ATED4), 9HY (DV6TED4), 9HZ (DV6TED4)	1560	25x137	SK-1424AQ1	BTKW	
2.0 16V	08/00-	RFN (EW10J4)	1997	25.4x153; 03/2001 →	SK-1482	BTK	
2.0 16V	08/00-	RFN (EW10J4)	1997	25.4x153	SK-1482AQ1	BTKW	
2.0 16V	03/05-	RFJ (EW10A), RFN (EW10J4)	1997	25x153	SK-1600	BTK	
2.0 16V	03/05-	RFJ (EW10A), RFN (EW10J4)	1997	25x153	SK-1600AQ1	BTKW	
2.0 16V	06/05-	RFK (EW10J4S)	1997	25x153	SK-1596	BTK	
2.0 16V	06/05-	RFK (EW10J4S)	1997	25x153	SK-1596AQ1	BTKW	
2.0 HDi 110	08/00-	RHS (DW10ATED)	1997	25x141; 09/2001 →; mit Zubehör	SK-1085	BTK	
2.0 HDi 110, 2.0 HDi 90	08/00-	RHS (DW10ATED), RHY (DW10TD)	1997	25.4x141; mit Zubehör	SK-1085AQ1	BTKW	
2.0 HDi 135	10/03-	RHR (DW10BTED4)	1997	25.4x116	SK-1594	BTK	
2.0 HDi 135	10/03-	RHR (DW10BTED4)	1997	25.4x116	SK-1594AQ1	BTKW	
2.0 HDi 90	08/00-	RHY (DW10TD)	1997	25x141; 03/2001 →; mit Zubehör	SK-1085	BTK	
1.4	08/00-	KFW (TU3JP)	1360	:3666766→	0-N1277	TB [TE]	
1.4	08/00-	KFW (TU3JP)	1360	:→3666765	0-N811	TB [TE]	
1.4 16V	11/03-	KFU (ET3J4)	1360		0-N1338	TB [TE]	
1.4 16V	11/03-	KFU (ET3J4)	1360		0-N1456	TB [DG]	
1.4 HDi	10/01-	8HX (DV4TD), 8HZ (DV4TD)	1398		0-N1062	TB [TE]	
1.4 HDi	10/01-	8HX (DV4TD), 8HZ (DV4TD)	1398		0-N1066	TB [DG]	
1.6 16V	08/00-	NFU (TU5JP4)	1587	:→1806404	0-N1061	TB [TE]	
1.6 16V	08/00-	NFU (TU5JP4)	1587	:→1806404	0-N122	TB [DG]	
1.6 16V	08/00-	NFU (TU5JP4)	1587	:1806405→	0-N1359	TB [TE]	
1.6 16V	08/00-	NFU (TU5JP4)	1587	:1806405→	0-N1360	TB [DG]	
1.6 BioFlex	09/07-	NFU (TU5JP4)	1587		0-N1359	TB [TE]	
1.6 BioFlex	09/07-	NFU (TU5JP4)	1587		0-N1360	TB [DG]	
1.6 HDi, 1.6 HDi 110	02/04-	9HV (DV6ATED4), 9HV (DV6TED4), 9HX (DV6ATED4), 9HY (DV6TED4), 9HZ (DV6TED4)	1560		0-N1062	TB [TE]	
1.6 HDi, 1.6 HDi 110	02/04-	9HV (DV6ATED4), 9HV (DV6TED4), 9HX (DV6ATED4), 9HY (DV6TED4), 9HZ (DV6TED4)	1560		0-N1066	TB [DG]	
2.0 16V	08/00-	RFK (EW10J4S), RFN (EW10J4)	1997		0-N1057	TB [TE]	
2.0 16V	08/00-	RFJ (EW10A), RFN (EW10J4), RFK (EW10J4S), RFN (EW10J4)	1997		0-N1065	TB [DG]	
2.0 16V	03/05-	RFJ (EW10A), RFN (EW10J4)	1997		0-N1343	TB [TE]	
2.0 HDi 110, 2.0 HDi 90	08/00-	RHS (DW10ATED), RHY (DW10TD)	1997		0-N118P	TB [TE]	
2.0 HDi 110, 2.0 HDi 90	08/00-	RHS (DW10ATED), RHY (DW10TD)	1997		0-N1381	TB [DG]	
2.0 HDi 135	10/03-	RHR (DW10BTED4)	1997		0-N1334	TB [DG]	
1.4 HDi	10/01-	8HX (DV4TD), 8HZ (DV4TD)	1398		0-N1339	VB [BT]	S
1.4 HDi	10/01-	8HX (DV4TD), 8HZ (DV4TD)	1398		0-N1418	VB [DG]	
1.4, 1.4 16V	08/00-	KFU (ET3J4), KFW (TU3JP)	1360	Orga.→09887	0-N1455	VB [TE]	
1.4, 1.4 16V	08/00-	KFU (ET3J4), KFW (TU3JP)	1360	Orga.09888→	0-N1673	VB [BT]	S
1.6 16V	08/00-	NFU (TU5JP4)	1587	Orga.→09887	0-N1455	VB [TE]	
1.6 16V	08/00-	NFU (TU5JP4)	1587	Orga.09888→;	0-N1673	VB [BT]	S
1.6 BioFlex	09/07-	NFU (TU5JP4)	1587		0-N1419	VB [DG]	
1.6 BioFlex	09/07-	NFU (TU5JP4)	1587	Orga.011556→;	0-N1673	VB [BT]	S
1.6 BioFlex	09/07-	NFU (TU5JP4)	1587	Orga.→12620; für Fahrzeuge mit Servolenkung	0-N1874	VB [BT]	S
1.6 HDi	04/05-	9HV (DV6ATED4), 9HV (DV6TED4), 9HX (DV6ATED4)	1560	Orga.10549→11073;	0-N1924	VB [DG]	
1.6 HDi 110	02/04-	9HY (DV6TED4), 9HZ (DV6TED4)	1560	Orga.10556→11073;	0-N1924	VB [DG]	
1.6 HDi, 1.6 HDi 110	02/04-	9HV (DV6ATED4), 9HV (DV6TED4), 9HX (DV6ATED4), 9HY (DV6TED4), 9HZ (DV6TED4)	1560	→ 10/2005	0-N1339	VB [BT]	S

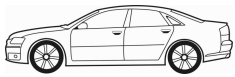

CM³



Art. Nr.



307 (3A/C)

1.6 HDi, 1.6 HDi 110	02/04-	9HV (DV6ATED4), 9HV (DV6TED4), 9HX (DV6ATED4), 9HY (DV6TED4), 9HZ (DV6TED4)	1560	Orga.→10555	0-N1418	VB [DG]	
1.6 HDi, 1.6 HDi 110	02/04-	9HV (DV6ATED4), 9HV (DV6TED4), 9HX (DV6ATED4), 9HY (DV6TED4), 9HZ (DV6TED4)	1560	Orga.10556→11073	0-N1807	VB [DG]	
2.0 16V	08/00-	RFN (EW10J4)	1997		0-N1391	VB [BT]	S
2.0 16V	08/00-	RFN (EW10J4)	1997		0-N1416	VB [DG]	
2.0 16V	08/00-	RFN (EW10J4)	1997	Orga.→09219	0-N1556S	VB [TE]	
2.0 16V	08/00-	RFN (EW10J4)	1997	03/2001 → 11/2004; ✖	0-N1651	VB [DG]	S
2.0 16V	08/00-	RFN (EW10J4)	1997	Orga.10248→	0-N1840	VB [BT]	S
2.0 16V	08/00-	RFN (EW10J4)	1997	Rippenanzahl: 6; Orga.→08914; ✖	0-N2094	VB [DG]	
2.0 16V	03/05-	RFJ (EW10A), RFN (EW10J4)	1997	Orga.→11270	0-N1840	VB [BT]	S
2.0 16V	06/05-	RFK (EW10J4S)	1997	Orga.→10247	0-N1416	VB [DG]	
2.0 16V	06/05-	RFK (EW10J4S)	1997		0-N1556S	VB [TE]	
2.0 16V	06/05-	RFK (EW10J4S)	1997	Rippenanzahl: 6; ✖	0-N2094	VB [DG]	
2.0 16V	06/05-	RFK (EW10J4S)	1997	Orga.10248→	0-N2276	VB [DG]	
2.0 HDi 110, 2.0 HDi 90	08/00-	RHS (DW10ATED), RHY (DW10TD)	1997		0-N1471	VB [BT]	S
2.0 HDi 110, 2.0 HDi 90	08/00-	RHS (DW10ATED), RHY (DW10TD)	1997	✖	0-N151	VB [DG]	
2.0 HDi 135	10/03-	RHR (DW10BTED4)	1997		0-N1327	VB [BT]	
2.0 HDi 135	10/03-	RHR (DW10BTED4)	1997	Orga.→11563	0-N2037	VB [BT]	S
2.0 HDi 135	10/03-	RHR (DW10BTED4)	1997	Orga.11564→	0-N2046	VB [BT]	S

307 Break (3E)

1.4	04/02-09/03	KFW (TU3JP)	1360	17x108; :→3666765	SK-1004	BTK	
1.4	04/02-09/03	KFW (TU3JP)	1360	17x108; :→3666765	SK-1004AQ1	BTKW	
1.4	04/02-09/03	KFW (TU3JP)	1360	17x104; :3666766→	SK-1354	BTK	
1.4	04/02-09/03	KFW (TU3JP)	1360	17x104; :3666766→	SK-1354AQ1	BTKW	
1.4 16V	11/03-	KFU (ET3J4)	1360	25x135	SK-1598	BTK	
1.4 16V	11/03-	KFU (ET3J4)	1360	25x135	SK-1598AQ1	BTKW	
1.4 HDi	03/02-	8HZ (DV4TD)	1398	25.4x144; 04/2002 →	SK-1391	BTK	
1.4 HDi	03/02-	8HZ (DV4TD)	1398	25.4x144; 04/2002 →	SK-1391AQ1	BTKW	
1.6 16V	03/02-	NFU (TU5JP4)	1587	25.4x134; :1806405→	SK-1615AQ1	BTKW	
1.6 16V, 1.6 BioFlex	03/02-	NFU (TU5JP4)	1587	25.4x134; :→1806404; mit Zubehör	SK-1392	BTK	
1.6 16V, 1.6 BioFlex	03/02-	NFU (TU5JP4)	1587	25.4x134; :→1806404; mit Zubehör	SK-1392AQ1	BTKW	
1.6 16V, 1.6 BioFlex	03/02-	NFU (TU5JP4)	1587	25.4x134; :1806405→	SK-1615	BTK	
1.6 BioFlex	09/07-	NFU (TU5JP4)	1587	25.4x134	SK-1615AQ1	BTKW	
1.6 HDi, 1.6 HDi 110	02/04-	9HV (DV6ATED4), 9HY (DV6TED4), 9HZ (DV6TED4)	1560	25x137	SK-1424	BTK	
1.6 HDi, 1.6 HDi 110	02/04-	9HV (DV6ATED4), 9HY (DV6TED4), 9HZ (DV6TED4)	1560	25x137	SK-1424AQ1	BTKW	
2.0	03/02-	RFN (EW10J4)	1997	25.4x153	SK-1482	BTK	
2.0	03/02-	RFN (EW10J4)	1997	25.4x153	SK-1482AQ1	BTKW	
2.0 16V	03/05-	RFJ (EW10A)	1997	25x153	SK-1600	BTK	
2.0 16V	03/05-	RFJ (EW10A)	1997	25x153	SK-1600AQ1	BTKW	
2.0 16V	06/05-	RFK (EW10J4S)	1997	25x153	SK-1596	BTK	
2.0 16V	06/05-	RFK (EW10J4S)	1997	25x153	SK-1596AQ1	BTKW	
2.0 HDi 110, 2.0 HDi 90	03/02-	RHS (DW10ATED), RHY (DW10TD)	1997	25x141; mit Zubehör	SK-1085	BTK	
2.0 HDi 110, 2.0 HDi 90	03/02-	RHS (DW10ATED), RHY (DW10TD)	1997	25.4x141; mit Zubehör	SK-1085AQ1	BTKW	
2.0 HDi 135	02/04-	RHR (DW10BTED4)	1997	25.4x116	SK-1594	BTK	
2.0 HDi 135	02/04-	RHR (DW10BTED4)	1997	25.4x116	SK-1594AQ1	BTKW	
1.4	04/02-09/03	KFW (TU3JP)	1360	:3666766→	0-N1277	TB [TE]	
1.4	04/02-09/03	KFW (TU3JP)	1360	:→3666765	0-N811	TB [TE]	
1.4 16V	11/03-	KFU (ET3J4)	1360		0-N1338	TB [TE]	
1.4 16V	11/03-	KFU (ET3J4)	1360		0-N1456	TB [DG]	
1.4 HDi	03/02-	8HZ (DV4TD)	1398		0-N1062	TB [TE]	
1.4 HDi	03/02-	8HZ (DV4TD)	1398		0-N1066	TB [DG]	
1.6 16V	03/02-	NFU (TU5JP4)	1587	:→1806404	0-N1061	TB [TE]	
1.6 16V	03/02-	NFU (TU5JP4)	1587	:→1806404	0-N122	TB [DG]	
1.6 16V	03/02-	NFU (TU5JP4)	1587	:1806405→	0-N1359	TB [TE]	
1.6 16V	03/02-	NFU (TU5JP4)	1587	:1806405→	0-N1360	TB [DG]	
1.6 BioFlex	09/07-	NFU (TU5JP4)	1587		0-N1359	TB [TE]	
1.6 BioFlex	09/07-	NFU (TU5JP4)	1587		0-N1360	TB [DG]	
1.6 HDi, 1.6 HDi 110	02/04-	9HV (DV6ATED4), 9HY (DV6TED4), 9HZ (DV6TED4)	1560		0-N1062	TB [TE]	
1.6 HDi, 1.6 HDi 110	02/04-	9HV (DV6ATED4), 9HY (DV6TED4), 9HZ (DV6TED4)	1560		0-N1066	TB [DG]	
2.0 16V	03/05-	RFJ (EW10A)	1997		0-N1343	TB [TE]	



CM³



Art. Nr.



307 Break (3E)

2.0 HDI 110, 2.0 HDI 90	03/02-	RHS (DW10ATED), RHY (DW10TD)	1997		0-N118P	TB [TE]	
2.0 HDI 110, 2.0 HDI 90	03/02-	RHS (DW10ATED), RHY (DW10TD)	1997		0-N1381	TB [DG]	
2.0 HDi 135	02/04-	RHR (DW10BTED4)	1997		0-N1334	TB [DG]	
2.0, 2.0 16V	03/02-	RFK (EW10J4S), RFN (EW10J4)	1997		0-N1057	TB [TE]	
2.0, 2.0 16V	03/02-	RFJ (EW10A), RFK (EW10J4S), RFN (EW10J4)	1997		0-N1065	TB [DG]	
1.4 16V	11/03-	KFU (ET3J4)	1360	Orga.→09887	0-N1455	VB [TE]	
1.4 HDi	03/02-	8HZ (DV4TD)	1398		0-N1339	VB [BT]	S
1.4 HDi	03/02-	8HZ (DV4TD)	1398		0-N1418	VB [DG]	
1.4, 1.4 16V	04/02-09/03	KFU (ET3J4), KFW (TU3JP)	1360	Orga.09888→	0-N1673	VB [BT]	S
1.6 16V	03/02-	NFU (TU5JP4)	1587	Orga.→09887	0-N1455	VB [TE]	
1.6 16V	03/02-	NFU (TU5JP4)	1587	Orga.09888→; ⚡	0-N1673	VB [BT]	S
1.6 BioFlex	09/07-	NFU (TU5JP4)	1587	⚡	0-N1419	VB [DG]	
1.6 BioFlex	09/07-	NFU (TU5JP4)	1587	Orga.011556→; ⚡	0-N1673	VB [BT]	S
1.6 BioFlex	09/07-	NFU (TU5JP4)	1587	Orga.→12620; ⚡, für Fahrzeuge mit Servolenkung	0-N1874	VB [BT]	S
1.6 HDi	04/05-	9HV (DV6ATED4)	1560	03/2007 →	0-N1502	VB [BT]	S
1.6 HDi	04/05-	9HV (DV6ATED4)	1560	Orga.10549→11073; ⚡	0-N1924	VB [DG]	
1.6 HDi 110	02/04-	9HY (DV6TED4), 9HZ (DV6TED4)	1560	Orga.10556→11073; ⚡	0-N1924	VB [DG]	
1.6 HDi, 1.6 HDi 110	02/04-	9HV (DV6ATED4), 9HY (DV6TED4), 9HZ (DV6TED4)	1560	→ 10/2005	0-N1339	VB [BT]	S
1.6 HDi, 1.6 HDi 110	02/04-	9HV (DV6ATED4), 9HY (DV6TED4), 9HZ (DV6TED4)	1560	Orga.→10555	0-N1418	VB [DG]	
1.6 HDi, 1.6 HDi 110	02/04-	9HV (DV6ATED4), 9HY (DV6TED4), 9HZ (DV6TED4)	1560	Orga.10556→11073	0-N1807	VB [DG]	
2.0	03/02-	RFN (EW10J4)	1997		0-N1391	VB [BT]	S
2.0	03/02-	RFN (EW10J4)	1997		0-N1416	VB [DG]	
2.0	03/02-	RFN (EW10J4)	1997	→ 11/2004; ⚡	0-N1651	VB [DG]	S
2.0	03/02-	RFN (EW10J4)	1997	Orga.10248→	0-N1840	VB [BT]	S
2.0	03/02-	RFN (EW10J4)	1997	Rippenanzahl: 6; Orga.→08914; ⚡	0-N2094	VB [DG]	
2.0 16V	03/05-	RFJ (EW10A)	1997	Orga.→11270	0-N1840	VB [BT]	S
2.0 16V	06/05-	RFK (EW10J4S)	1997	Orga.→10247	0-N1416	VB [DG]	
2.0 16V	06/05-	RFK (EW10J4S)	1997	Rippenanzahl: 6; ⚡	0-N2094	VB [DG]	
2.0 16V	06/05-	RFK (EW10J4S)	1997	Orga.10248→	0-N2276	VB [DG]	
2.0 HDI 110, 2.0 HDI 90	03/02-	RHS (DW10ATED), RHY (DW10TD)	1997		0-N1471	VB [BT]	S
2.0 HDI 110, 2.0 HDI 90	03/02-	RHS (DW10ATED), RHY (DW10TD)	1997	⚡	0-N151	VB [DG]	
2.0 HDi 135	02/04-	RHR (DW10BTED4)	1997		0-N1327	VB [BT]	
2.0 HDi 135	02/04-	RHR (DW10BTED4)	1997	Orga.→11563	0-N2037	VB [BT]	S
2.0 HDi 135	02/04-	RHR (DW10BTED4)	1997	Orga.11564→	0-N2046	VB [BT]	S
2.0, 2.0 16V	03/02-	RFK (EW10J4S), RFN (EW10J4)	1997		0-N1556S	VB [TE]	

307 CC (3B)

1.6 16V	02/05-	NFU (TU5JP4)	1587	25.4x134; ⚡:→1806404; mit Zubehör	SK-1392	BTK	
1.6 16V	02/05-	NFU (TU5JP4)	1587	25.4x134; ⚡:→1806404; mit Zubehör	SK-1392AQ1	BTKW	
1.6 16V	02/05-	NFU (TU5JP4)	1587	25.4x134; ⚡:1806405→	SK-1615	BTK	
1.6 16V	02/05-	NFU (TU5JP4)	1587	25.4x134	SK-1615AQ1	BTKW	
2.0 16V	10/03-	RFN (EW10J4)	1997	25.4x153	SK-1482	BTK	
2.0 16V	10/03-	RFN (EW10J4)	1997	25.4x153	SK-1482AQ1	BTKW	
2.0 16V	10/03-	RFK (EW10J4S)	1997	25x153	SK-1596	BTK	
2.0 16V	10/03-	RFK (EW10J4S)	1997	25x153	SK-1596AQ1	BTKW	
2.0 16V	03/05-	RFJ (EW10A)	1997	25x153	SK-1600	BTK	
2.0 16V	03/05-	RFJ (EW10A)	1997	25x153	SK-1600AQ1	BTKW	
2.0 HDi 135	06/05-	RHR (DW10BTED4)	1997	25.4x116	SK-1594	BTK	
2.0 HDi 135	06/05-	RHR (DW10BTED4)	1997	25.4x116	SK-1594AQ1	BTKW	
1.6 16V	02/05-	NFU (TU5JP4)	1587		0-N1359	TB [TE]	
1.6 16V	02/05-	NFU (TU5JP4)	1587		0-N1360	TB [DG]	
2.0 16V	10/03-	RFK (EW10J4S), RFN (EW10J4)	1997		0-N1057	TB [TE]	
2.0 16V	10/03-	RFJ (EW10A), RFK (EW10J4S), RFN (EW10J4)	1997		0-N1065	TB [DG]	
2.0 16V	03/05-	RFJ (EW10A)	1997		0-N1343	TB [TE]	
2.0 HDi 135	06/05-	RHR (DW10BTED4)	1997		0-N1334	TB [DG]	
1.6 16V	02/05-	NFU (TU5JP4)	1587	⚡	0-N1419	VB [DG]	
1.6 16V	02/05-	NFU (TU5JP4)	1587	⚡	0-N1673	VB [BT]	S
1.6 16V	02/05-	NFU (TU5JP4)	1587	Orga.→12620; ⚡, für Fahrzeuge mit Servolenkung	0-N1874	VB [BT]	S
2.0 16V	10/03-	RFN (EW10J4)	1997		0-N1391	VB [BT]	S
2.0 16V	10/03-	RFN (EW10J4)	1997		0-N1416	VB [DG]	
2.0 16V	10/03-	RFK (EW10J4S)	1997	Orga.→10247	0-N1416	VB [DG]	



CM³



Art. Nr.



307 CC (3B)

2.0 16V	10/03-	RFK (EW10J4S), RFN (EW10J4)	1997		0-N1556S	VB [TE]	
2.0 16V	10/03-	RFN (EW10J4)	1997	→ 11/2004; ☼	0-N1651	VB [DG]	S
2.0 16V	10/03-	RFN (EW10J4)	1997	Orga.10248→	0-N1840	VB [BT]	S
2.0 16V	10/03-	RFN (EW10J4)	1997	Rippenanzahl: 6; Orga.→08914; ☼	0-N2094	VB [DG]	
2.0 16V	10/03-	RFK (EW10J4S)	1997	Rippenanzahl: 6; ☼	0-N2094	VB [DG]	
2.0 16V	10/03-	RFK (EW10J4S)	1997	Orga.10248→	0-N2276	VB [DG]	
2.0 16V	03/05-	RFJ (EW10A)	1997	Orga.→11270	0-N1840	VB [BT]	S
2.0 HDi 135	06/05-	RHR (DW10BTED4)	1997		0-N1327	VB [BT]	
2.0 HDi 135	06/05-	RHR (DW10BTED4)	1997	Orga.→11563	0-N2037	VB [BT]	S
2.0 HDi 135	06/05-	RHR (DW10BTED4)	1997	Orga.11564→	0-N2046	VB [BT]	S

307 SW (3H)

1.4	04/02-09/03	KFW (TU3JP)	1360	17x108; :→3666765	SK-1004	BTK	
1.4	04/02-09/03	KFW (TU3JP)	1360	17x108; :→3666765	SK-1004AQ1	BTKW	
1.4	04/02-09/03	KFW (TU3JP)	1360	17x104; :3666766→	SK-1354	BTK	
1.4	04/02-09/03	KFW (TU3JP)	1360	17x104; :3666766→	SK-1354AQ1	BTKW	
1.4 16V	11/03-	KFU (ET3J4)	1360	25x135	SK-1598	BTK	
1.4 16V	11/03-	KFU (ET3J4)	1360	25x135	SK-1598AQ1	BTKW	
1.6 16V	03/02-	NFU (TU5JP4)	1587	25.4x134; :1806405→	SK-1615AQ1	BTKW	
1.6 16V, 1.6 BioFlex	03/02-	NFU (TU5JP4)	1587	25.4x134; :→1806404; mit Zubehör	SK-1392	BTK	
1.6 16V, 1.6 BioFlex	03/02-	NFU (TU5JP4)	1587	25.4x134; :→1806404; mit Zubehör	SK-1392AQ1	BTKW	
1.6 16V, 1.6 BioFlex	03/02-	NFU (TU5JP4)	1587	25.4x134; :1806405→	SK-1615	BTK	
1.6 BioFlex	09/07-	NFU (TU5JP4)	1587	25.4x134	SK-1615AQ1	BTKW	
1.6 HDi 110, 1.6 HDi 90	02/04-	9HV (DV6ATED4), 9HX (DV6ATED4), 9HY (DV6TED4), 9HZ (DV6TED4)	1560	25x137	SK-1424	BTK	
1.6 HDi 110, 1.6 HDi 90	02/04-	9HV (DV6ATED4), 9HX (DV6ATED4), 9HY (DV6TED4), 9HZ (DV6TED4)	1560	25x137	SK-1424AQ1	BTKW	
2.0 16V	03/02-	RFN (EW10J4)	1997	25.4x153	SK-1482	BTK	
2.0 16V	03/02-	RFN (EW10J4)	1997	25.4x153	SK-1482AQ1	BTKW	
2.0 16V	03/05-	RFJ (EW10A), RFN (EW10J4)	1997	25x153	SK-1600	BTK	
2.0 16V	03/05-	RFJ (EW10A), RFN (EW10J4)	1997	25x153	SK-1600AQ1	BTKW	
2.0 HDi 110, 2.0 HDi 90	03/02-	RHS (DW10ATED), RHY (DW10TD)	1997	25x141; mit Zubehör	SK-1085	BTK	
2.0 HDi 110, 2.0 HDi 90	03/02-	RHS (DW10ATED), RHY (DW10TD)	1997	25.4x141; mit Zubehör	SK-1085AQ1	BTKW	
2.0 HDi 135	02/04-	RHR (DW10BTED4)	1997	25.4x116	SK-1594	BTK	
2.0 HDi 135	02/04-	RHR (DW10BTED4)	1997	25.4x116	SK-1594AQ1	BTKW	
1.4	04/02-09/03	KFW (TU3JP)	1360	:3666766→	0-N1277	TB [TE]	
1.4	04/02-09/03	KFW (TU3JP)	1360	:→3666765	0-N811	TB [TE]	
1.4 16V	11/03-	KFU (ET3J4)	1360		0-N1338	TB [TE]	
1.4 16V	11/03-	KFU (ET3J4)	1360		0-N1456	TB [DG]	
1.6 16V	03/02-	NFU (TU5JP4)	1587	:→1806404	0-N1061	TB [TE]	
1.6 16V	03/02-	NFU (TU5JP4)	1587	:→1806404	0-N122	TB [DG]	
1.6 16V	03/02-	NFU (TU5JP4)	1587	:1806405→	0-N1359	TB [TE]	
1.6 16V	03/02-	NFU (TU5JP4)	1587	:1806405→	0-N1360	TB [DG]	
1.6 BioFlex	09/07-	NFU (TU5JP4)	1587		0-N1359	TB [TE]	
1.6 BioFlex	09/07-	NFU (TU5JP4)	1587		0-N1360	TB [DG]	
1.6 HDi 110, 1.6 HDi 90	02/04-	9HV (DV6ATED4), 9HX (DV6ATED4), 9HY (DV6TED4), 9HZ (DV6TED4)	1560		0-N1062	TB [TE]	
1.6 HDi 110, 1.6 HDi 90	02/04-	9HV (DV6ATED4), 9HX (DV6ATED4), 9HY (DV6TED4), 9HZ (DV6TED4)	1560		0-N1066	TB [DG]	
2.0 16V	03/02-	RFN (EW10J4)	1997		0-N1057	TB [TE]	
2.0 16V	03/02-	RFJ (EW10A), RFN (EW10J4), RFN (EW10J4)	1997		0-N1065	TB [DG]	
2.0 16V	03/05-	RFJ (EW10A), RFN (EW10J4)	1997		0-N1343	TB [TE]	
2.0 HDi 110, 2.0 HDi 90	03/02-	RHS (DW10ATED), RHY (DW10TD)	1997		0-N118P	TB [TE]	
2.0 HDi 110, 2.0 HDi 90	03/02-	RHS (DW10ATED), RHY (DW10TD)	1997		0-N1381	TB [DG]	
2.0 HDi 135	02/04-	RHR (DW10BTED4)	1997		0-N1334	TB [DG]	
1.4 16V	11/03-	KFU (ET3J4)	1360	Orga.→09887	0-N1455	VB [TE]	
1.4 HDi 70	03/02-01/05	8HZ (DV4TD)	1398	Orga.→10426; ☼	0-N1418	VB [DG]	
1.4 HDi 70	03/02-01/05	8HZ (DV4TD)	1398	Orga.10427→11073; ☼	0-N1807	VB [DG]	
1.4, 1.4 16V	04/02-09/03	KFU (ET3J4), KFW (TU3JP)	1360	Orga.09888→	0-N1673	VB [BT]	S
1.6 16V	03/02-	NFU (TU5JP4)	1587	Orga.→09887	0-N1455	VB [TE]	
1.6 16V	03/02-	NFU (TU5JP4)	1587	Orga.09888→; ☼	0-N1673	VB [BT]	S
1.6 BioFlex	09/07-	NFU (TU5JP4)	1587	☼	0-N1419	VB [DG]	
1.6 BioFlex	09/07-	NFU (TU5JP4)	1587	Orga.011556→; ☼	0-N1673	VB [BT]	S
1.6 BioFlex	09/07-	NFU (TU5JP4)	1587	Orga.→12620; ☼, für Fahrzeuge mit Servolenkung	0-N1874	VB [BT]	S
1.6 HDi 110	02/04-	9HY (DV6TED4), 9HZ (DV6TED4)	1560	→ 10/2005	0-N1339	VB [BT]	S

CM³

Art. Nr.

**307 SW (3H)**

1.6 HDI 110	02/04-	9HY (DV6TED4), 9HZ (DV6TED4)	1560	Orga.10556→11073; ⚡	0-N1924	VB [DG]	
1.6 HDI 110, 1.6 HDI 90	02/04-	9HV (DV6ATED4), 9HX (DV6ATED4), 9HY (DV6TED4), 9HZ (DV6TED4)	1560	Orga.→10555	0-N1418	VB [DG]	
1.6 HDI 110, 1.6 HDI 90	02/04-	9HV (DV6ATED4), 9HX (DV6ATED4), 9HY (DV6TED4), 9HZ (DV6TED4)	1560	Orga.10556→11073	0-N1807	VB [DG]	
1.6 HDI 90	12/06-	9HV (DV6ATED4), 9HX (DV6ATED4)	1560	03/2007 →	0-N1502	VB [BT]	S
1.6 HDI 90	12/06-	9HV (DV6ATED4), 9HX (DV6ATED4)	1560	Orga.10549→11073; ⚡	0-N1924	VB [DG]	
2.0 16V	03/02-	RFN (EW10J4)	1997		0-N1391	VB [BT]	S
2.0 16V	03/02-	RFN (EW10J4)	1997		0-N1416	VB [DG]	
2.0 16V	03/02-	RFN (EW10J4)	1997		0-N1556S	VB [TE]	
2.0 16V	03/02-	RFN (EW10J4)	1997	→ 11/2004; ⚡	0-N1651	VB [DG]	S
2.0 16V	03/02-	RFN (EW10J4)	1997	Orga.10248→	0-N1840	VB [BT]	S
2.0 16V	03/02-	RFN (EW10J4)	1997	Rippenanzahl: 6; Orga.→08914; ⚡	0-N2094	VB [DG]	
2.0 16V	03/05-	RFJ (EW10A), RFN (EW10J4)	1997	Orga.→11270	0-N1840	VB [BT]	S
2.0 HDI 110, 2.0 HDI 90	03/02-	RHS (DW10ATED), RHY (DW10TD)	1997		0-N1471	VB [BT]	S
2.0 HDI 110, 2.0 HDI 90	03/02-	RHS (DW10ATED), RHY (DW10TD)	1997	⚡	0-N151	VB [DG]	
2.0 HDi 135	02/04-	RHR (DW10BTED4)	1997		0-N1327	VB [BT]	
2.0 HDi 135	02/04-	RHR (DW10BTED4)	1997	Orga.→11563	0-N2037	VB [BT]	S
2.0 HDi 135	02/04-	RHR (DW10BTED4)	1997	Orga.11564→	0-N2046	VB [BT]	S

308 (4A_, 4C_)

1.6 BioFlex	04/08-	NFU (TU5JP4)	1587	25.4x134	SK-1615	BTK	
1.6 BioFlex	04/08-	NFU (TU5JP4)	1587	25.4x134	SK-1615AQ1	BTKW	
1.6 HDi	09/07-	9HZ (DV6TED4)	1560	25x137	SK-1424	BTK	
1.6 HDi	09/07-	9HZ (DV6TED4)	1560	25x137	SK-1424AQ1	BTKW	
1.6 HDi	11/09-	9HP (DV6DTE), 9HR (DV6C)	1560	25x141	SK-1728	BTK	
1.6 HDi	11/09-	9HP (DV6DTE), 9HR (DV6C)	1560	25x141	SK-1728AQ1	BTKW	
2.0 HDi	09/07-	RHR (DW10BTED4)	1997	25.4x116	SK-1594	BTK	
2.0 HDi	09/07-	DW10BTED4	1997	25.4x116	SK-1594AQ1	BTKW	
2.0 HDi	09/07-	RHE (DW10CTED4), RHH (DW10CTED4), RHR (DW10BTED4)	1997	25x116	SK-1714	BTK	
2.0 HDi	09/07-	DW10CB	1997	25x116	SK-1714AQ1	BTKW	
2.0 HDi	07/10-	RHR (DW10BTED4)	1997	25.4x116	SK-1594AQ1	BTKW	
2.0 HDi	10/11-	RHE (DW10CTED4), RHH (DW10CTED4)	1997	25x116	SK-1714AQ1	BTKW	
1.6 BioFlex	04/08-	NFU (TU5JP4)	1587		0-N1359	TB [TE]	
1.6 BioFlex	04/08-	NFU (TU5JP4)	1587		0-N1360	TB [DG]	
1.6 HDi	09/07-	9HZ (DV6TED4)	1560		0-N1062	TB [TE]	
1.6 HDi	09/07-	9HZ (DV6TED4)	1560		0-N1066	TB [DG]	
1.6 HDi	11/09-	9HP (DV6DTE), 9HR (DV6C)	1560		0-N2224	TB [TE]	
1.6 HDi	11/09-	9HP (DV6DTE), 9HR (DV6C)	1560		0-N2382	TB [DG]	
1.6 HDi	03/13-	DV6C	1560		0-N2224	TB [TE]	
1.6 HDi	03/13-	DV6C	1560		0-N2382	TB [DG]	
2.0 HDi	09/07-	RHR (DW10BTED4)	1997		0-N1334	TB [DG]	
2.0 HDi	07/10-	RHR (DW10BTED4)	1997		0-N2063	TB [TE]	
1.4 16V	09/07-	8FR (EP3), 8FS (EP3), EP3	1397	⚡	0-N2055	VB [BT]	S
1.4 16V	09/07-	8FR (EP3), 8FS (EP3), EP3	1397	für OE: 11 28 7 598 832, 11 28 7 598 833	0-N2237	VB [DG]	
1.6 16V, 1.6 GTi	09/07-	5FT (EP6DT), 5FW (EP6), EP6, 5FX (EP6DT), 5FY (EP6DTS), EP6CDT, EP6CDTX	1598	⚡	0-N2055	VB [BT]	S
1.6 16V, 1.6 GTi	09/07-	5FT (EP6DT), 5FW (EP6), EP6, 5FX (EP6DT), 5FY (EP6DTS), EP6CDT, EP6CDTX	1598	für OE: 11 28 7 598 832, 11 28 7 598 833	0-N2237	VB [DG]	
1.6 BioFlex	04/08-	NFU (TU5JP4)	1587	⚡	0-N1673	VB [BT]	S
1.6 HDi	09/07-	9HP (DV6DTE), 9HZ (DV6TED4)	1560		0-N1502	VB [BT]	S
1.6 HDi	11/09-	9HP (DV6DTE), 9HR (DV6C)	1560	Rippenanzahl: 6; für Fahrzeuge mit Start-Stopp-Funktion, ⚡	0-N2355	VB [DG]	
1.6 HDi	11/09-	9HP (DV6DTE), 9HR (DV6C)	1560	für Fahrzeuge mit Start-Stopp-Funktion	0-N2392	VB [BT]	S
1.6 HDi	12/09-	9HR (DV6C)	1560	für Fahrzeuge ohne Start-Stopp-Funktion	0-N1502	VB [BT]	S
2.0 HDi	09/07-	RHR (DW10BTED4)	1997		0-N1327	VB [BT]	
2.0 HDi	09/07-	RHR (DW10BTED4)	1997	Orga.→11556	0-N2037	VB [BT]	S
2.0 HDi	09/07-	RHR (DW10BTED4)	1997	Orga.11557→	0-N2046	VB [BT]	S
2.0 HDi	10/11-	RHE (DW10CTED4), RHH (DW10CTED4)	1997		0-N2268	VB [BT]	S

308 CC

1.6 HDi	06/09-	9HR (DV6C)	1560	25x141	SK-1728	BTK	
1.6 HDi	06/09-	9HR (DV6C)	1560	25x141	SK-1728AQ1	BTKW	
2.0 HDi	04/09-	RHF (DW10BTED4), RHR (DW10BTED4)	1997	25.4x116	SK-1594	BTK	
2.0 HDi	04/09-	RHF (DW10BTED4), RHR (DW10BTED4)	1997	25.4x116	SK-1594AQ1	BTKW	

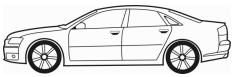

CM³



Art. Nr.



308 CC							
2.0 HDi	06/09-	RHH (DW10CTED4)	1997	25x116		SK-1714	BTK
2.0 HDi	06/09-	RHH (DW10CTED4)	1997	25x116		SK-1714AQ1	BTKW
1.6 HDi	06/09-	9HR (DV6C)	1560			0-N2224	TB [TE]
1.6 HDi	06/09-	9HR (DV6C)	1560			0-N2382	TB [DG]
1.6 HDi	03/13-	DV6C	1560			0-N2224	TB [TE]
1.6 HDi	03/13-	DV6C	1560			0-N2382	TB [DG]
2.0 HDi	04/09-	RHF (DW10BTED4), RHH (DW10CTED4), RHR (DW10BTED4)	1997			0-N1334	TB [DG]
2.0 HDi	04/09-	RHF (DW10BTED4), RHH (DW10CTED4)	1997			0-N2063	TB [TE]
1.6 16V, 1.6 THP	06/09-	5FT (EP6DT), 5FX (EP6DT), EP6, EP6CDT, EP6CDTX	1598	☼		0-N2055	VB [BT] S
1.6 16V, 1.6 THP	06/09-	5FT (EP6DT), 5FX (EP6DT), EP6, EP6CDT, EP6CDTX	1598		für OE: 11 28 7 598 832, 11 28 7 598 833	0-N2237	VB [DG]
1.6 HDi	06/09-	9HR (DV6C)	1560		für Fahrzeuge ohne Start-Stopp-Funktion	0-N1502	VB [BT] S
1.6 HDi	06/09-	9HR (DV6C)	1560		Rippenanzahl: 6; für Fahrzeuge mit Start-Stopp-Funktion, ☼	0-N2355	VB [DG]
1.6 HDi	06/09-	9HR (DV6C)	1560		für Fahrzeuge mit Start-Stopp-Funktion	0-N2392	VB [BT] S
2.0 HDi	04/09-	RHR (DW10BTED4)	1997			0-N1327	VB [BT]
2.0 HDi	04/09-	RHR (DW10BTED4)	1997		Orga. → 11556	0-N2037	VB [BT] S
2.0 HDi	04/09-	RHR (DW10BTED4)	1997		Orga. 11557 →	0-N2046	VB [BT] S
2.0 HDi	06/09-	RHH (DW10CTED4)	1997			0-N2268	VB [BT] S
308 SW							
1.6 Bioflex	03/09-	NFU (TU5JP4)	1587	25.4x134		SK-1615	BTK
1.6 Bioflex	03/09-	NFU (TU5JP4)	1587	25.4x134		SK-1615AQ1	BTKW
1.6 HDi	09/07-	9HV (DV6ATED4), 9HX (DV6ATED4), 9HZ (DV6TED4)	1560	25x137		SK-1424	BTK
1.6 HDi	09/07-	9HV (DV6ATED4), 9HX (DV6ATED4), 9HZ (DV6TED4)	1560	25x137		SK-1424AQ1	BTKW
1.6 HDi	11/09-	9HP (DV6DTED), 9HR (DV6C)	1560	25x141		SK-1728	BTK
1.6 HDi	11/09-	9HP (DV6DTED), 9HR (DV6C)	1560	25x141		SK-1728AQ1	BTKW
2.0 Bioflex	01/08-	RFJ (EW10A)	1997	25x153		SK-1600	BTK
2.0 Bioflex	01/08-	RFJ (EW10A)	1997	25x153		SK-1600AQ1	BTKW
2.0 HDi	09/07-	RHR (DW10BTED4)	1997	25.4x116; 01/2008 →		SK-1594	BTK
2.0 HDi	09/07-	RHR (DW10BTED4)	1997	25.4x116; 07/2009 →		SK-1594	BTK
2.0 HDi	09/07-	RHR (DW10BTED4)	1997	25.4x116		SK-1594AQ1	BTKW
2.0 HDi	06/09-	RHH (DW10CTED4)	1997	25x116		SK-1714	BTK
2.0 HDi	06/09-	RHE (DW10CTED4), RHH (DW10CTED4)	1997	25x116		SK-1714AQ1	BTKW
2.0 HDi	04/11-	RHE (DW10CTED4)	1997	25x116; 10/2011 →		SK-1714	BTK
1.6 Bioflex	03/09-	NFU (TU5JP4)	1587			0-N1359	TB [TE]
1.6 Bioflex	03/09-	NFU (TU5JP4)	1587			0-N1360	TB [DG]
1.6 HDi	09/07-	9HV (DV6ATED4), 9HX (DV6ATED4), 9HZ (DV6TED4)	1560			0-N1062	TB [TE]
1.6 HDi	09/07-	9HV (DV6ATED4), 9HX (DV6ATED4), 9HZ (DV6TED4)	1560			0-N1066	TB [DG]
1.6 HDi	11/09-	9HP (DV6DTED), 9HR (DV6C)	1560			0-N2224	TB [TE]
1.6 HDi	11/09-	9HP (DV6DTED), 9HR (DV6C)	1560			0-N2382	TB [DG]
1.6 HDi	03/13-	DV6C	1560			0-N2224	TB [TE]
1.6 HDi	03/13-	DV6C	1560			0-N2382	TB [DG]
2.0 Bioflex	01/08-	RFJ (EW10A)	1997			0-N1065	TB [DG]
2.0 Bioflex	01/08-	RFJ (EW10A)	1997			0-N1343	TB [TE]
2.0 HDi	09/07-	RHH (DW10CTED4), RHR (DW10BTED4)	1997			0-N1334	TB [DG]
2.0 HDi	09/07-	RHH (DW10CTED4), RHR (DW10BTED4)	1997			0-N2063	TB [TE]
1.4 16V	09/07-	8FR (EP3), 8FS (EP3)	1397	☼		0-N2055	VB [BT] S
1.4 16V	09/07-	8FR (EP3), 8FS (EP3)	1397		für OE: 11 28 7 598 832, 11 28 7 598 833	0-N2237	VB [DG]
1.6 16V	09/07-	5FT (EP6DT), 5FW (EP6), EP6, 5FX (EP6DT), 5FY (EP6DTS), EP6CDT	1598	☼		0-N2055	VB [BT] S
1.6 16V	09/07-	5FT (EP6DT), 5FW (EP6), EP6, 5FX (EP6DT), 5FY (EP6DTS), EP6CDT	1598		für OE: 11 28 7 598 832, 11 28 7 598 833	0-N2237	VB [DG]
1.6 Bioflex	03/09-	NFU (TU5JP4)	1587	☼		0-N1673	VB [BT] S
1.6 HDi	09/07-	9HP (DV6DTED), 9HV (DV6ATED4), 9HX (DV6ATED4), 9HZ (DV6TED4)	1560			0-N1502	VB [BT] S
1.6 HDi	11/09-	9HP (DV6DTED), 9HR (DV6C)	1560		Rippenanzahl: 6; für Fahrzeuge mit Start-Stopp-Funktion, ☼	0-N2355	VB [DG]
1.6 HDi	11/09-	9HP (DV6DTED), 9HR (DV6C)	1560		für Fahrzeuge mit Start-Stopp-Funktion	0-N2392	VB [BT] S
1.6 HDi	12/09-	9HR (DV6C)	1560		für Fahrzeuge ohne Start-Stopp-Funktion	0-N1502	VB [BT] S
2.0 Bioflex	01/08-	RFJ (EW10A)	1997			0-N1840	VB [BT] S
2.0 Bioflex, 2.0 HDi	09/07-	RFJ (EW10A), RHR (DW10BTED4)	1997			0-N1327	VB [BT]
2.0 Bioflex, 2.0 HDi	09/07-	RFJ (EW10A), RHR (DW10BTED4)	1997		Orga. → 11556	0-N2037	VB [BT] S

CM³

Art. Nr.

**308 SW**

2.0 Bioflex, 2.0 HDi	09/07-	RFJ (EW10A), RHR (DW10BTED4)	1997	Orga.11557→	0-N2046	VB [BT]	S
2.0 HDi	06/09-	RHE (DW10CTED4), RHH (DW10CTED4)	1997		0-N2268	VB [BT]	S

308 II

1.6 HDi	09/13-		1560	25x141	SK-1728	BTK	
1.6 HDi	09/13-		1560	25x141	SK-1728AQ1	BTKW	
1.2 THP 110, 1.2 THP 130, 1.2 VTi 72	09/13-	HMZ (EB2F), HNY (EB2DTS), HNZ (EB2DT)	1199		0-N2424	TB [DG]	
1.6 BlueHDi 120, 1.6 HDi 100	11/13-	BHY (DV6FD), BHZ (DV6FC)	1560		0-N2382	TB [DG]	
1.6 HDi	09/13-	DV6C	1560		0-N2382	TB [DG]	
1.6 HDi	09/13-	DV6DTE	1560		0-N2382	TB [DG]	
1.6	09/13-	5FV (EP6DT)	1598	für OE: 11 28 7 598 832, 11 28 7 598 833	0-N2237	VB [DG]	
1.6 HDi	09/13-		1560		0-N1502	VB [BT]	S

308 SW II

1.6 HDi 115	03/14-	DV6C	1560	25x141	SK-1728	BTK	
1.6 HDi 115	03/14-	DV6C	1560	25x141	SK-1728AQ1	BTKW	
1.6 HDi 92	03/14-		1560	25x141	SK-1728	BTK	
1.6 HDi 92	03/14-		1560	25x141	SK-1728AQ1	BTKW	
1.2 THP 110, 1.2 THP 130	03/14-	HNY (EB2DTS), HNZ (EB2DT)	1199		0-N2424	TB [DG]	
1.6 BlueHDi 120, 1.6 HDi 100	03/14-	BHY (DV6FD), BHZ (DV6FC)	1560		0-N2382	TB [DG]	
1.6 HDi 115	03/14-	DV6C	1560		0-N2382	TB [DG]	
1.6 HDi 92	03/14-	DV6DTE	1560		0-N2382	TB [DG]	
1.6 HDi 92	03/14-		1560		0-N1502	VB [BT]	S

309 I (10C, 10A)

1.1	10/85-07/89	E1	1118	17x104	SK-1003	BTK	
1.1	10/85-07/89	E1	1118	17x104	SK-1003AQ1	BTKW	
1.4	03/89-07/89	K1D (TU3A), K2B (TU3S)	1360	17x108	SK-1004	BTK	
1.4	03/89-07/89	TU3M	1360	17x108	SK-1004	BTK	
1.4	03/89-07/89	K1D (TU3A), K2B (TU3S), KDY (TU3M), KDZ (TU3M)	1360	17x108	SK-1004AQ1	BTKW	
1.4	03/89-07/89	KDY (TU3M), KDZ (TU3M)	1360	17x101	SK-1020	BTK	
1.4	03/89-07/89	TU3F2	1360	17x101	SK-1020AQ1	BTKW	
1.6	10/85-07/89	B1A (XU51C), B1D (XU51C)	1580	17x114	SK-1019	BTK	
1.6	01/86-07/89		1592	17x113	SK-1006	BTK	
1.6, 1.6 KAT	10/85-12/89	180Z (XU5J), B6B (XU5J), B1A (XU51C), B1A (XU51C), B1D (XU51C), B1E (XU51C), BAZ (XU5CP)	1580	17x113	SK-1006	BTK	
1.9 D	06/86-07/89	162 (XUD9), D9A (XUD9)	1905	25.39x136	SK-1007	BTK	
1.9 D	06/86-07/89	162 (XUD9), D9A (XUD9)	1905	25.4x136; 01/1987 →	SK-1007AQ1	BTKW	
1.9, 1.9 GTI	10/85-08/89	D2B (XU9S), D6B (XU9JA), DDZ (XU9M), DFZ (XU9J1), DKZ (XU9JAZ)	1905	17x113	SK-1006	BTK	
1.1	10/85-07/89	E1	1118		0-N811	TB [TE]	
1.4	03/89-07/89	K1D (TU3A), K2B (TU3S), KDY (TU3M), KDZ (TU3M)	1360		0-N811	TB [TE]	
1.6	10/85-07/89	180Z (XU5J), B6B (XU5J), B1A (XU51C), B1E (XU51C)	1580		0-N812	TB [TE]	
1.6	01/86-07/89		1592		0-N812	TB [TE]	
1.9 D	06/86-07/89	162 (XUD9), D9A (XUD9)	1905		0-N813	TB [TE]	
1.9 D	06/86-07/89	162 (XUD9), D9A (XUD9)	1905		0-N814	TB [DG]	
1.9, 1.9 GTI	10/85-07/89	D2B (XU9S), D6B (XU9JA), DDZ (XU9M), DFZ (XU9J1), DKZ (XU9JAZ)	1905		0-N812	TB [TE]	
1.9 D	06/86-07/89	162 (XUD9), D9A (XUD9)	1905		0-N2349	VB [DG]	
1.9 D	06/86-07/89	162 (XUD9), D9A (XUD9)	1905		0-N849	VB [TE]	

309 II (3C, 3A)

1.1	09/89-12/93	H1B (TU1), HDZ (TU1M)	1124	17x104	SK-1003	BTK	
1.1	09/89-12/93	H1B (TU1), HDZ (TU1M)	1124	17x104	SK-1003AQ1	BTKW	
1.4	07/89-12/93	TU3M	1361	17x108	SK-1004	BTK	
1.4	07/89-12/93	KDY (TU3M), KDZ (TU3M)	1361	17x108; →50355042	SK-1004AQ1	BTKW	
1.4	07/89-12/93	KDY (TU3M), KDZ (TU3M)	1361	17x101	SK-1020	BTK	
1.4	07/89-12/93	TU3F2	1361	17x101	SK-1020AQ1	BTKW	
1.4	07/90-12/93	K1D (TU3A)	1361	17x108	SK-1004	BTK	
1.4	07/90-12/93	K1D (TU3A)	1361	17x108	SK-1004AQ1	BTKW	
1.6	07/89-12/93	B2A (XU52C/K), BDY (XU5M2Z), BDY (XU5M3Z), BDZ (XU5M)	1580	17x113	SK-1006	BTK	
1.6 GTi	09/89-10/93		1580	17x113; → 01/1992	SK-1006	BTK	
1.6, 1.6 GTi	07/89-12/93	B2A (XU52C/K), BDY (XU5M2Z), BDY (XU5M3Z), BDZ (XU5M)	1580	17x114; 01/1992 →	SK-1019	BTK	
1.8 Diesel	07/89-12/93	161A (XUD7)	1769	25.39x136; Baumuster: 161A	SK-1007	BTK	



CM³



Art. Nr.



309 II (3C, 3A)

1.8 Diesel, 1.8 TD	07/89-12/93	161A (XUD7), A8B (XUD7TE)	1769	25.4x136	SK-1007AQ1	BTKW
1.8 TD	08/89-12/93	A8B (XUD7TE)	1769	25.39x136; Baumuster: A8B	SK-1007	BTK
1.9 Diesel	07/89-12/93	162 (XUD9), D9A (XUD9), DJZ (XUD9Y)	1905	25.39x136; Baumuster: 162	SK-1007	BTK
1.9 Diesel	07/89-12/93	162 (XUD9), D9A (XUD9), DJZ (XUD9Y)	1905	25.4x136	SK-1007AQ1	BTKW
1.9 GTI 16V	08/89-12/93	D6C (XU9J4), DFW (XU9J4Z)	1905	25x133	SK-1157	BTK
1.9, 1.9 GTI	07/89-12/93	D6B (XU9JA), DDZ (XU9M), DFZ (XU9J1), DKZ (XU9JAZ)	1905	17x113; → 01/1992	SK-1006	BTK
1.9, 1.9 GTI	07/89-12/93	DDZ (XU9M), DFZ (XU9J1), DKZ (XU9JAZ)	1905	17x114; 01/1992 →	SK-1019	BTK
1.1	08/90-12/93	HDZ (TU1M)	1124		0-N811	TB [TE]
1.4	07/89-12/93	K1D (TU3A), KDY (TU3M), KDZ (TU3M)	1361		0-N811	TB [TE]
1.6	07/89-12/93	B2A (XU52C/K), BDY (XU5M2Z), BDY (XU5M3Z), BDZ (XU5M)	1580	02/1992 →	0-N811	TB [TE]
1.6	07/89-12/93	B2A (XU52C/K), BDY (XU5M2Z), BDY (XU5M3Z), BDZ (XU5M)	1580	→ 01/1992	0-N812	TB [TE]
1.8 Diesel, 1.8 TD	07/89-12/93	161A (XUD7), A8B (XUD7TE)	1769		0-N813	TB [TE]
1.8 Diesel, 1.8 TD	07/89-12/93	161A (XUD7), A8B (XUD7TE)	1769		0-N814	TB [DG]
1.9 Diesel	07/89-12/93	162 (XUD9), D9A (XUD9), DJZ (XUD9Y)	1905		0-N813	TB [TE]
1.9 Diesel	07/89-12/93	162 (XUD9), D9A (XUD9), DJZ (XUD9Y)	1905		0-N814	TB [DG]
1.9 GTI 16V	08/89-12/93	D6C (XU9J4), DFW (XU9J4Z)	1905		0-N869	TB [TE]
1.9, 1.9 GTI	07/89-12/93	DDZ (XU9M), DFZ (XU9J1), DKZ (XU9JAZ)	1905	02/1992 →	0-N811	TB [TE]
1.9, 1.9 GTI	07/89-12/93	DDZ (XU9M), DFZ (XU9J1), DKZ (XU9JAZ)	1905	→ 01/1992	0-N812	TB [TE]
1.8 Diesel	07/89-12/93	161A (XUD7)	1769		0-N849	VB [TE]
1.8 Diesel, 1.8 TD	07/89-12/93	161A (XUD7), A8B (XUD7TE)	1769		0-N2349	VB [DG]
1.9 Diesel	07/89-12/93	162 (XUD9), D9A (XUD9), DJZ (XUD9Y)	1905		0-N2349	VB [DG]
1.9 Diesel	07/89-12/93	162 (XUD9), D9A (XUD9), DJZ (XUD9Y)	1905		0-N849	VB [TE]

405 I (15B)

1.4	01/87-07/92	K5A (TU3)	1360	17x108; 06/1987 →	SK-1004	BTK
1.4	01/87-07/92	K5A (TU3)	1360	17x108	SK-1004AQ1	BTKW
1.6	01/87-12/92	B1E (XU51C), B1E (XU51C), BAZ (XU5CP), B2A (XU52C/K), BDY (XU5M2Z), BDZ (XU5M), BDZ (XU5M)	1580	17x113	SK-1006	BTK
1.6 4x4	04/88-07/92	BDZ (XU5M)	1580	17x113; → 01/1992; :→70521462	SK-1006	BTK
1.6, 1.6 4x4	01/87-12/92	B1E (XU51C), B2A (XU52C/K), BDY (XU5M2Z), BDZ (XU5M), BDZ (XU5M)	1580	17x114; 01/1992 →; :70521463→	SK-1019	BTK
1.8 D 4x4	10/87-07/92	A8A (XUD7TE)	1769	25.39x136; Baumuster: A8A	SK-1007	BTK
1.8 D 4x4, 1.8 Turbo Diesel	10/87-12/92	A8A (XUD7TE), A8A (XUD7TE), AJZ (XUD7TEY)	1769	25.4x136	SK-1007AQ1	BTKW
1.8 Turbo Diesel	03/88-12/92	XUD7TE	1769	25.39x136; Baumuster: A8A, AJZ	SK-1007	BTK
1.9	01/89-12/92	D6A (XU9J2)	1905	17x113; :→70521462	SK-1006	BTK
1.9	01/89-12/92	D6A (XU9J2)	1905	17x114; :70521463→	SK-1019	BTK
1.9 4x4, 1.9 Sport MI-16, 1.9 SPort MI-16 4x4	06/87-12/92	D6C (XU9J4), DFW (XU9J4Z)	1905	25x133	SK-1157	BTK
1.9 Diesel	03/88-12/92	D9B (XUD9A), DJZ (XUD9Y)	1905	25.39x136	SK-1007	BTK
1.9 Diesel	03/88-12/92	D9B (XUD9A), DJZ (XUD9Y)	1905	25.4x136	SK-1007AQ1	BTKW
1.9, 1.9 4x4, 1.9 Injection	07/87-12/93	D2C (XU92C), D6A (XU9J2), DDZ (XU9M), DFZ (XU9J1), DKZ (XU9JAZ)	1905	17x113	SK-1006	BTK
1.9, 1.9 4x4, 1.9 Injection	07/87-12/93	D2C (XU92C), D6A (XU9J2), DDZ (XU9M), DFZ (XU9J1), DKZ (XU9JAZ)	1905	17x114; 01/1992 →; :70521463→	SK-1019	BTK
1.4	01/87-07/92	K5A (TU3)	1360		0-N811	TB [TE]
1.6	01/87-12/92	B1E (XU51C), B2A (XU52C/K), BDY (XU5M2Z), BDZ (XU5M), BDZ (XU5M)	1580	→ 01/1992	0-N812	TB [TE]
1.6	07/87-06/88	B1E (XU51C), BAZ (XU5CP)	1580		0-N812	TB [TE]
1.6, 1.6 4x4	01/87-12/92	B1E (XU51C), B2A (XU52C/K), BDY (XU5M2Z), BDZ (XU5M), BDZ (XU5M)	1580	02/1992 →	0-N811	TB [TE]
1.8 D 4x4, 1.8 Turbo Diesel	10/87-12/92	A8A (XUD7TE), A8A (XUD7TE), AJZ (XUD7TEY)	1769		0-N813	TB [TE]
1.8 D 4x4, 1.8 Turbo Diesel	10/87-12/92	A8A (XUD7TE), A8A (XUD7TE), AJZ (XUD7TEY)	1769		0-N814	TB [DG]
1.9 Diesel	03/88-12/92	D9B (XUD9A), DJZ (XUD9Y)	1905		0-N813	TB [TE]
1.9 Diesel	03/88-12/92	D9B (XUD9A), DJZ (XUD9Y)	1905		0-N814	TB [DG]
1.9 Sport MI-16, 1.9 SPort MI-16 4x4	07/87-12/92	D6C (XU9J4), DFW (XU9J4Z)	1905		0-N869	TB [TE]
1.9, 1.9 4x4, 1.9 Injection	06/87-12/93	D2C (XU92C), D6A (XU9J2), DDZ (XU9M), DFZ (XU9J1), DKZ (XU9JAZ)	1905	02/1992 →	0-N811	TB [TE]
1.9, 1.9 4x4, 1.9 Injection	07/87-12/92	D2C (XU92C), D6A (XU9J2), DDZ (XU9M), DFZ (XU9J1), DKZ (XU9JAZ)	1905	→ 01/1992	0-N812	TB [TE]
1.6	01/87-12/92	B1E (XU51C), B2A (XU52C/K), BDY (XU5M2Z), BDZ (XU5M), BDZ (XU5M)	1580	02/1992 →; *	0-N1405	VB [DG]
1.6	07/87-12/92	BDY (XU5M2Z), BDZ (XU5M), BDZ (XU5M)	1580		0-N124	VB [TE]
1.8 D 4x4, 1.8 Turbo Diesel	10/87-12/92	A8A (XUD7TE), A8A (XUD7TE), AJZ (XUD7TEY)	1769	*	0-N2349	VB [DG]



OPTIMAL[®]

PEUGEOT

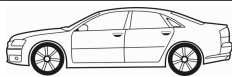

CM³



Art. Nr.



ohne Halter

405 I (15B)

1.8 Turbo Diesel	03/88-12/92	A8A (XUD7TE), AJZ (XUD7TEY)	1769		0-N931	VB [TE]
1.9	07/87-12/92	D2C (XU92C)	1905	02/1992 →; *	0-N1405	VB [DG]
1.9 Diesel	03/88-12/92	D9B (XUD9A), DJZ (XUD9Y)	1905	*	0-N2349	VB [DG]
1.9 Diesel	03/88-12/92	D9B (XUD9A), DJZ (XUD9Y)	1905		0-N931	VB [TE]
1.9 Sport MI-16, 1.9 SPort MI-16 4x4	07/87-12/92	D6C (XU9J4), DFW (XU9J4Z)	1905		0-N849	VB [TE]

405 I Break (15E)

1.4	05/88-07/92	K5A (TU3)	1360	17x108	SK-1004	BTK
1.4	05/88-07/92	K5A (TU3)	1360	17x108	SK-1004AQ1	BTKW
1.6	10/88-08/92	B1E (XU51C), BAZ (XU5CP), BDY (XU5M2Z), BDY (XU5M3Z), BDZ (XU5M), BDZ (XU5M)	1580	17x113	SK-1006	BTK
1.6, 1.6 SRi 4x4	04/88-07/92	B2A (XU52C/K), BDZ (XU5M)	1580	17x113; → 01/1992; →70521462	SK-1006	BTK
1.6, 1.6 SRi 4x4	04/88-08/92	B1E (XU51C), B2A (XU52C/K), BAZ (XU5CP), BDY (XU5M2Z), BDY (XU5M3Z), BDZ (XU5M), BDZ (XU5M)	1580	17x114; 01/1992 →; →70521463→	SK-1019	BTK
1.8 DT 4x4	05/90-07/92	A8A (XUD7TE)	1769	25.39x136; Baumuster: A8A	SK-1007	BTK
1.8 DT 4x4, 1.8 GLD, 1.8 TD	10/88-08/92	A8A (XUD7TE), A8A (XUD7TE), AJZ (XUD7TEY)	1769	25.4x136	SK-1007AQ1	BTKW
1.8 GLD	04/90-07/92		1769	25.39x136	SK-1007	BTK
1.8 TD	10/88-08/92	XUD7TE	1769	25.39x136; Baumuster: A8A, AJZ	SK-1007	BTK
1.9 Allrad	06/87-07/92	D6C (XU9J4)	1905	25x133	SK-1157	BTK
1.9 D	10/88-08/92	D9B (XUD9A), DJY (XUD9A), DJZ (XUD9Y)	1905	25.39x136	SK-1007	BTK
1.9 D	10/88-08/92	D9B (XUD9A), DJY (XUD9A), DJZ (XUD9Y)	1905	25.4x136	SK-1007AQ1	BTKW
1.9, 1.9 4x4	10/88-08/92	D2C (XU92C), DDZ (XU9M), DFZ (XU9J1), DKZ (XU9JAZ)	1905	17x113	SK-1006	BTK
1.9, 1.9 4x4, 1.9 Allrad	05/88-08/92	D2C (XU92C), DDZ (XU9M), DFZ (XU9J1), DKZ (XU9JAZ)	1905	17x114; 01/1992 →; →70521463→	SK-1019	BTK
1.9, 1.9 Allrad	05/88-07/92	DFZ (XU9J1)	1905	17x113; → 01/1992; →70521462	SK-1006	BTK
1.4	05/88-07/92	K5A (TU3)	1360		0-N811	TB [TE]
1.6	05/88-08/92	B1E (XU51C), B2A (XU52C/K), BAZ (XU5CP), BDY (XU5M2Z), BDY (XU5M3Z), BDZ (XU5M), BDZ (XU5M)	1580	→ 01/1992	0-N812	TB [TE]
1.6, 1.6 SRi 4x4	04/88-08/92	B1E (XU51C), B2A (XU52C/K), BAZ (XU5CP), BDY (XU5M2Z), BDY (XU5M3Z), BDZ (XU5M), BDZ (XU5M)	1580	02/1992 →	0-N811	TB [TE]
1.8 DT 4x4, 1.8 GLD, 1.8 TD	10/88-08/92	A8A (XUD7TE), A8A (XUD7TE), AJZ (XUD7TEY)	1769		0-N813	TB [TE]
1.8 DT 4x4, 1.8 GLD, 1.8 TD	10/88-08/92	A8A (XUD7TE), A8A (XUD7TE), AJZ (XUD7TEY)	1769		0-N814	TB [DG]
1.9 D	10/88-08/92	D9B (XUD9A), DJY (XUD9A), DJZ (XUD9Y)	1905		0-N813	TB [TE]
1.9 D	10/88-08/92	D9B (XUD9A), DJY (XUD9A), DJZ (XUD9Y)	1905		0-N814	TB [DG]
1.9, 1.9 4x4, 1.9 Allrad	05/88-08/92	D2C (XU92C), DDZ (XU9M), DFZ (XU9J1), DKZ (XU9JAZ)	1905	02/1992 →	0-N811	TB [TE]
1.9, 1.9 4x4, 1.9 Allrad	05/88-08/92	D2C (XU92C), DDZ (XU9M), DFZ (XU9J1), DKZ (XU9JAZ)	1905	→ 01/1992	0-N812	TB [TE]
1.4	05/88-07/92	K5A (TU3)	1360	mit Grundträger	0-N2337	VB [TE]
1.6	05/88-08/92	B1E (XU51C), B2A (XU52C/K), BAZ (XU5CP), BDY (XU5M2Z), BDY (XU5M3Z), BDZ (XU5M), BDZ (XU5M)	1580	02/1992 →; *	0-N1405	VB [DG]
1.6	10/88-08/92	BDY (XU5M2Z), BDY (XU5M3Z), BDZ (XU5M), BDZ (XU5M)	1580		0-N124	VB [TE]
1.8 DT 4x4, 1.8 TD	10/88-08/92	A8A (XUD7TE), A8A (XUD7TE), AJZ (XUD7TEY)	1769	*	0-N2349	VB [DG]
1.8 GLD	04/90-07/92	XUD7	1769	*	0-N2349	VB [DG]
1.8 TD	10/88-08/92	A8A (XUD7TE), AJZ (XUD7TEY)	1769		0-N931	VB [TE]
1.9 D	10/88-08/92	D9B (XUD9A), DJY (XUD9A), DJZ (XUD9Y)	1905	*	0-N2349	VB [DG]
1.9 D	10/88-08/92	D9B (XUD9A), DJY (XUD9A), DJZ (XUD9Y)	1905		0-N931	VB [TE]
1.9, 1.9 Allrad	05/88-08/92	D2C (XU92C), DFZ (XU9J1)	1905	02/1992 →; *	0-N1405	VB [DG]

405 II (4B)

1.4	08/92-10/95	KDX (TU3MC)	1361	17x108; → 12/1992	SK-1004AQ1	BTKW
1.4	08/92-10/95	KDX (TU3MC)	1361	17x101	SK-1020	BTK
1.4	08/92-10/95	KDX (TU3MC)	1361	17x101	SK-1020AQ1	BTKW
1.6	08/92-08/94	B2A (XU52C/K), BFZ (XU5JP)	1580	17x113; →70521462	SK-1006	BTK
1.6	08/92-10/95	BDY (XU5M2Z), BDY (XU5M3Z), BDZ (XU5M), BFZ (XU5JP)	1580	17x113; → 08/1994; →70521462	SK-1006	BTK
1.6	08/92-10/95	BDY (XU5M2Z), BDY (XU5M3Z), BDZ (XU5M), BFZ (XU5JP)	1580	17x114; →70521463→	SK-1019	BTK
1.8	08/92-10/95	LFZ (XU7JP)	1762	17x114	SK-1019	BTK
1.9 D	06/94-10/95	DJY (XUD9A)	1905	25.4x136	SK-1022	BTK
1.9 D, 1.9 TD	08/92-05/97	DHY (XUD9TE), DJZ (XUD9Y), XUD9TE	1905	25.39x136; → 01/1994	SK-1007	BTK



CM³



Art. Nr.



405 II (4B)							
1.9 D, 1.9 TD	08/92-05/97	DHY (XUD9TE), DJZ (XUD9Y), XUD9TE	1905	25.4x136; → 01/1994		SK-1007AQ1	BTKW
1.9 D, 1.9 TD	08/92-10/95	DHY (XUD9TE), DJZ (XUD9Y)	1905	25.4x136; 01/1994 →		SK-1022	BTK
1.9 TD	08/92-10/95	DHY (XUD9TE)	1905	25.4x136; 02/1994 →		SK-1022AQ2	BTKW
2.0 16V, 2.0 MI-16, 2.0 T 16 X4	08/92-10/95	RFT (XU10J4), RFY (XU10J4Z), RGZ (XU10J4TE/Z)	1998	25.4x134		SK-1158	BTK
2.0, 2.0 X4	08/92-10/95	RFX (XU10J2)	1998	17x114		SK-1019	BTK
1.4	08/92-10/95	KDX (TU3MC)	1361			0-N811	TB [TE]
1.6	08/92-05/97	B2A (XU52C/K), BFZ (XU5JP), BDY (XU5M2Z), BDY (XU5M3Z), BDZ (XU5M), BFZ (XU5JP)	1580			0-N811	TB [TE]
1.8	08/92-10/95	LFZ (XU7JP)	1762			0-N811	TB [TE]
1.8	08/96-11/99	LFZ (XU7JP)	1761			0-N811	TB [TE]
1.9 D	06/94-10/95	DJY (XUD9A)	1905			0-N900	TB [DG]
1.9 D	06/94-10/95	DJY (XUD9A)	1905			0-N901	TB [TE]
1.9 D, 1.9 TD	08/92-10/95	DHY (XUD9TE), DJZ (XUD9Y)	1905	→ 01/1994		0-N813	TB [TE]
1.9 D, 1.9 TD	08/92-10/95	DHY (XUD9TE), DJZ (XUD9Y)	1905	→ 01/1994		0-N814	TB [DG]
1.9 D, 1.9 TD	08/92-10/95	DHY (XUD9TE), DJZ (XUD9Y)	1905	02/1994 →		0-N900	TB [DG]
1.9 D, 1.9 TD	08/92-10/95	DHY (XUD9TE), DJZ (XUD9Y)	1905	02/1994 →		0-N901	TB [TE]
2.0 16V, 2.0 MI-16, 2.0 T 16 X4	08/92-10/95	RFT (XU10J4), RFY (XU10J4Z), RGZ (XU10J4TE/Z)	1998			0-N869	TB [TE]
2.0 16V, 2.0 MI-16, 2.0 T 16 X4	08/92-10/95	RFT (XU10J4), RFY (XU10J4Z), RGZ (XU10J4TE/Z)	1998			0-N911	TB [DG]
2.0, 2.0 X4	08/92-10/95	RFX (XU10J2)	1998	07/1993 →		0-N811	TB [TE]
2.0, 2.0 X4	08/92-10/95	RFX (XU10J2)	1998	→ 06/1993		0-N870	TB [TE]
1.4	08/92-10/95	KDX (TU3MC)	1361	mit Grundträger		0-N2337	VB [TE]
1.6	08/92-10/95	BDY (XU5M2Z), BDY (XU5M3Z), BDZ (XU5M), BFZ (XU5JP)	1580			0-N124	VB [TE]
1.6	08/92-10/95	BDY (XU5M2Z), BDY (XU5M3Z), BDZ (XU5M), BFZ (XU5JP)	1580	☼		0-N1405	VB [DG]
1.6	08/92-10/95	BDY (XU5M2Z), BDY (XU5M3Z), BDZ (XU5M), BFZ (XU5JP)	1580	☼		0-N1484	VB [BT] S
1.8	08/92-10/95	LFZ (XU7JP)	1762			0-N124	VB [TE]
1.8	08/92-10/95	LFZ (XU7JP)	1762	☼		0-N1405	VB [DG]
1.8	08/92-10/95	LFZ (XU7JP)	1762	☼		0-N1484	VB [BT] S
1.9 D	08/92-10/95	DJZ (XUD9Y)	1905	01/1993 →; ☼		0-N1751	VB [DG]
1.9 D	08/92-10/95	DJZ (XUD9Y)	1905	01/1993 →; ☼		0-N1756	VB [BT]
1.9 D	08/92-10/95	DJZ (XUD9Y)	1905	→ 12/1992; ☼		0-N2349	VB [DG]
1.9 D, 1.9 TD	08/92-10/95	DHY (XUD9TE), DJY (XUD9A)	1905	☼		0-N1751	VB [DG]
1.9 D, 1.9 TD	08/92-10/95	DHY (XUD9TE), DJY (XUD9A)	1905	☼		0-N1756	VB [BT]
1.9 D, 1.9 TD	08/92-10/95	DHY (XUD9TE), DJY (XUD9A), DJZ (XUD9Y)	1905			0-N931	VB [TE]
2.0 16V, 2.0 MI-16	08/92-10/95	RFT (XU10J4), RFY (XU10J4Z)	1998	☼		0-N1405	VB [DG]
2.0 16V, 2.0 MI-16	08/92-10/95	RFT (XU10J4), RFY (XU10J4Z)	1998	☼		0-N1484	VB [BT] S
2.0 16V, 2.0 MI-16, 2.0 T 16 X4	08/92-10/95	RFT (XU10J4), RFY (XU10J4Z), RGZ (XU10J4TE/Z)	1998			0-N124	VB [TE]
2.0, 2.0 X4	08/92-10/95	RFX (XU10J2)	1998	07/1993 →		0-N124	VB [TE]
2.0, 2.0 X4	08/92-10/95	RFX (XU10J2)	1998	07/1993 →; ☼		0-N1405	VB [DG]
2.0, 2.0 X4	08/92-10/95	RFX (XU10J2)	1998	07/1993 →; ☼		0-N1484	VB [BT] S
405 II Break (4E)							
1.4	08/92-10/96	KDX (TU3MC)	1361	17x108; → 12/1992		SK-1004AQ1	BTKW
1.4	08/92-10/96	KDX (TU3MC)	1361	17x101		SK-1020	BTK
1.4	08/92-10/96	KDX (TU3MC)	1361	17x101		SK-1020AQ1	BTKW
1.4	07/93-06/94	TU3M	1360	17x101		SK-1020	BTK
1.4	07/93-06/94	TU3M	1360	17x101		SK-1020AQ1	BTKW
1.6	08/92-10/96	BDY (XU5M2Z), BDY (XU5M3Z), BDZ (XU5M), BFZ (XU5JP)	1580	17x113; (☼): →70521462		SK-1006	BTK
1.6	08/92-10/96	BDY (XU5M2Z), BDY (XU5M3Z), BDZ (XU5M), BFZ (XU5JP)	1580	17x114; (☼):70521463 →		SK-1019	BTK
1.8	08/92-10/96	LFZ (XU7JP)	1762	17x114		SK-1019	BTK
1.9 D	06/94-10/96	DJY (XUD9A)	1905	25.4x136		SK-1022	BTK
1.9 D, 1.9 TD	08/92-10/96	DHY (XUD9TE), DJZ (XUD9Y), XUD9	1905	25.39x136; → 01/1994		SK-1007	BTK
1.9 D, 1.9 TD	08/92-10/96	DHY (XUD9TE), DJZ (XUD9Y), XUD9	1905	25.4x136; → 01/1994		SK-1007AQ1	BTKW
1.9 D, 1.9 TD	08/92-10/96	DHY (XUD9TE), DJZ (XUD9Y), XUD9	1905	25.4x136; 01/1994 →		SK-1022	BTK
1.9 TD	08/92-10/96	DHY (XUD9TE)	1905	25.4x136; 02/1994 →		SK-1022AQ2	BTKW
2.0 4x4	08/92-12/95	RGZ (XU10J4TE/Z)	1998	25.4x134		SK-1158	BTK
2.0, 2.0 4x4	08/92-10/96	RFX (XU10J2)	1998	17x114		SK-1019	BTK
1.4	08/92-10/96	KDX (TU3MC)	1361			0-N811	TB [TE]



OPTIMAL®

PEUGEOT



CM³



Art. Nr.



405 II Break (4E)

1.6	08/92-10/96	BDY (XU5M2Z), BDY (XU5M3Z), BDZ (XU5M), BFZ (XU5JP)	1580		0-N811	TB [TE]	
1.8	08/92-10/96	LFZ (XU7JP)	1762		0-N811	TB [TE]	
1.9 D	06/94-10/96	DJY (XUD9A)	1905		0-N900	TB [DG]	
1.9 D	06/94-10/96	DJY (XUD9A)	1905		0-N901	TB [TE]	
1.9 D, 1.9 TD	08/92-10/96	DHY (XUD9TE), DJZ (XUD9Y)	1905	→ 01/1994	0-N813	TB [TE]	
1.9 D, 1.9 TD	08/92-10/96	DHY (XUD9TE), DJZ (XUD9Y)	1905	→ 01/1994	0-N814	TB [DG]	
1.9 D, 1.9 TD	08/92-10/96	DHY (XUD9TE), DJZ (XUD9Y)	1905	02/1994 →	0-N900	TB [DG]	
1.9 D, 1.9 TD	08/92-10/96	DHY (XUD9TE), DJZ (XUD9Y)	1905	02/1994 →	0-N901	TB [TE]	
2.0, 2.0 4x4	08/92-10/96	RFX (XU10J2)	1998	07/1993 →	0-N811	TB [TE]	
2.0, 2.0 4x4	08/92-10/96	RFX (XU10J2)	1998	→ 06/1993	0-N870	TB [TE]	
1.4	08/92-10/96	KDX (TU3MC)	1361	mit Grundträger	0-N2337	VB [TE]	
1.4	07/93-06/94		1360	mit Grundträger	0-N2337	VB [TE]	
1.6	08/92-10/96	BDY (XU5M2Z), BDY (XU5M3Z), BDZ (XU5M), BFZ (XU5JP)	1580		0-N124	VB [TE]	
1.6	08/92-10/96	BDY (XU5M2Z), BDY (XU5M3Z), BDZ (XU5M), BFZ (XU5JP)	1580	☼	0-N1405	VB [DG]	
1.6	08/92-10/96	BDY (XU5M2Z), BDY (XU5M3Z), BDZ (XU5M), BFZ (XU5JP)	1580	☼	0-N1484	VB [BT]	S
1.8	08/92-10/96	LFZ (XU7JP)	1762		0-N124	VB [TE]	
1.8	08/92-10/96	LFZ (XU7JP)	1762	☼	0-N1405	VB [DG]	
1.8	08/92-10/96	LFZ (XU7JP)	1762	☼	0-N1484	VB [BT]	S
1.9 D	08/92-10/96	DJZ (XUD9Y)	1905	01/1993 →; ☼	0-N1751	VB [DG]	
1.9 D	08/92-10/96	DJZ (XUD9Y)	1905	01/1993 →; ☼	0-N1756	VB [BT]	
1.9 D	08/92-10/96	DJZ (XUD9Y)	1905	→ 12/1992; ☼	0-N2349	VB [DG]	
1.9 D, 1.9 TD	08/92-10/96	DHY (XUD9TE), DJY (XUD9A)	1905	☼	0-N1751	VB [DG]	
1.9 D, 1.9 TD	08/92-10/96	DHY (XUD9TE), DJY (XUD9A)	1905	☼	0-N1756	VB [BT]	
1.9 D, 1.9 TD	08/92-10/96	DHY (XUD9TE), DJY (XUD9A), DJZ (XUD9Y)	1905		0-N931	VB [TE]	
2.0, 2.0 4x4	08/92-10/96	RFX (XU10J2)	1998	07/1993 →	0-N124	VB [TE]	
2.0, 2.0 4x4	08/92-10/96	RFX (XU10J2)	1998	07/1993 →; ☼	0-N1405	VB [DG]	
2.0, 2.0 4x4	08/92-10/96	RFX (XU10J2)	1998	07/1993 →; ☼	0-N1484	VB [BT]	S

406 (8B)

1.6	11/95-05/04	BFZ (XU5JP)	1580	17x114	SK-1019	BTK	
1.8	05/97-05/04	LFX (XU7JB)	1761	17x114	SK-1019	BTK	
1.8 16V	11/95-10/00	LFY (XU7JP4)	1761	25x136; → 01/2000; Abgasnorm: Euro 3 (D3); Orga.→08469	SK-1082	BTK	
1.8 16V	11/95-10/00	LFY (XU7JP4)	1761	25x136; → 01/2000; Spannrollenbetätigung: manuell	SK-1082AQ1	BTKW	
1.8 16V	11/95-10/00	LFY (XU7JP4)	1761	25x136; Abgasnorm: Euro 2; mit Zubehör; Spannrollenbetätigung: automatisch	SK-1399	BTK	
1.8 16V	11/95-10/00	LFY (XU7JP4)	1761	25x136; Abgasnorm: Euro 3 (D3); mit Zubehör; Spannrollenbetätigung: automatisch	SK-1399	BTK	
1.8 16V	11/95-10/00	LFY (XU7JP4)	1761	25x136; → 01/2000; Abgasnorm: Euro 3 (D3); Orga.→08469; mit Zubehör; Spannrollenbetätigung: automatisch; Baumuster: PHASE 2	SK-1399AQ1	BTKW	
1.8 16V	11/95-10/00	LFY (XU7JP4)	1761	25x136; Abgasnorm: Euro 2; mit Zubehör; Spannrollenbetätigung: automatisch; Baumuster: PHASE 2	SK-1399AQ1	BTKW	
1.8 16V	11/95-10/00	LFY (XU7JP4)	1761	25x136; mit Zubehör; Spannrollenbetätigung: automatisch; Baumuster: PHASE 1	SK-1399AQ1	BTKW	
1.8 16V	10/00-05/04	6FZ (EW7J4)	1749	25.4x153	SK-1482	BTK	
1.8 16V	10/00-05/04	6FZ (EW7J4)	1749	25.4x153	SK-1482AQ1	BTKW	
1.9 D, 1.9 TD	01/96-05/04	DHW (XUD9SD), DHX (XUD9TE), DHY (XUD9TE)	1905	25.4x136	SK-1022	BTK	
1.9 D, 1.9 TD	01/96-05/04	DHW (XUD9SD), DHX (XUD9TE), DHY (XUD9TE)	1905	25.4x136; Orga.07390→	SK-1022AQ1	BTKW	
1.9 D, 1.9 TD	01/96-05/04	DHW (XUD9SD), DHX (XUD9TE), DHY (XUD9TE)	1905	25.4x136; Orga.→07389	SK-1022AQ2	BTKW	
2.0 16V	11/95-05/04	RFV (XU10J4R)	1998	25x136	SK-1082	BTK	
2.0 16V	11/95-05/04	RFV (XU10J4R)	1998	25x136	SK-1082AQ2	BTKW	
2.0 16V	01/99-06/04	RFN (EW10J4), RFR (DEW10J4)	1997	25.4x153	SK-1482	BTK	
2.0 16V	01/99-06/04	RFN (EW10J4), RFR (DEW10J4)	1997	25.4x153	SK-1482AQ1	BTKW	
2.0 16V HPI	05/01-05/04	RLZ (EW10D)	1997	25.4x143	SK-1393	BTK	
2.0 HDi 110	08/01-05/04	RHS (DW10ATED), RHZ (DW10ATED)	1997	25x141; Orga.8736→; mit Zubehör	SK-1085	BTK	
2.0 HDi 110, 2.0 HDi 90	06/98-05/04	RHY (DW10TD), RHZ (DW10ATED)	1997	25x141; → 10/2000; Orga.→8735; mit Zubehör	SK-1085	BTK	



CM³



Art. Nr.



ohne Halter

406 (8B)							
2.0 HDI 110, 2.0 HDI 90	06/98-05/04	RHS (DW10ATED), RHZ (DW10ATED), RHY (DW10TD), RHZ (DW10ATED)	1997	25.4x141; mit Zubehör	SK-1085AQ1	BTKW	
2.0 Turbo	04/96-05/04	RGX (XU10J2TE)	1998	17x114	SK-1019	BTK	
2.1 TD 12V	01/96-05/04	P8C (XUD11BTE)	2088	25.4x149	SK-1017	BTK	
2.1 TD 12V	01/96-05/04	P8C (XUD11BTE)	2088	25x149	SK-1017AQ1	BTKW	
2.2	07/00-05/04	3FZ (EW12J4)	2230	25.4x153	SK-1482	BTK	
2.2	07/00-05/04	3FZ (EW12J4)	2230	25.4x153	SK-1482AQ1	BTKW	
2.2 HDi	03/00-05/04	4HX (DW12TED4/FAP)	2179	25.4x146; 09/2000 → 10010	SK-1394	BTK	
2.2 HDi	03/00-05/04	4HX (DW12TED4/FAP)	2179	25.4x146; → 04/2004; Orga. → 10010	SK-1394AQ1	BTKW	
2.2 HDi	03/00-05/04	4HX (DW12TED4/FAP)	2179	25.4x146; 04/2004 →; Orga. 10011 →; Baumuster: 4HX	SK-1614	BTK	
2.2 HDi	03/00-05/04	4HX (DW12TED4/FAP)	2179	25.4x146; 04/2004 →; Orga. 10011 →	SK-1614AQ1	BTKW	
3.0 V6	03/00-05/04	XFX (ES9J4S)	2946	32x259	SK-1483	BTK	
3.0 V6	03/00-05/04	XFX (ES9J4S)	2946	32x259; 04/2000 →	SK-1483AQ1	BTKW	
1.6	11/95-05/04	BFZ (XU5JP)	1580		0-N811	TB [TE]	
1.8	05/97-05/04	LFX (XU7JB)	1761		0-N811	TB [TE]	
1.8 16V	11/95-10/00	LFY (XU7JP4)	1761	Orga.08470 →	0-N1058	TB [TE]	
1.8 16V	11/95-10/00	LFY (XU7JP4)	1761		0-N862	TB [DG]	
1.8 16V	11/95-10/00	LFY (XU7JP4)	1761	Orga. → 08469	0-N943	TB [TE]	
1.8 16V	10/00-05/04	6FZ (EW7J4)	1749		0-N1057	TB [TE]	
1.8 16V	10/00-05/04	6FZ (EW7J4)	1749		0-N1065	TB [DG]	
1.9 D, 1.9 TD	01/96-05/04	DHW (XUD9SD), DHX (XUD9TE), DHY (XUD9TE)	1905		0-N900	TB [DG]	
1.9 D, 1.9 TD	01/96-05/04	DHW (XUD9SD), DHX (XUD9TE), DHY (XUD9TE)	1905		0-N901	TB [TE]	
2.0 16V	11/95-05/04	RFV (XU10J4R)	1998		0-N862	TB [DG]	
2.0 16V	11/95-05/04	RFV (XU10J4R)	1998		0-N943	TB [TE]	
2.0 16V	01/99-06/04	RFN (EW10J4), RFR (DEW10J4)	1997		0-N1057	TB [TE]	
2.0 16V HPI	05/01-05/04	RLZ (EW10D)	1997		0-N1060	TB [TE]	
2.0 16V, 2.0 16V HPI	01/99-06/04	RFN (EW10J4), RFR (DEW10J4), RLZ (EW10D)	1997		0-N1065	TB [DG]	
2.0 HDi 110, 2.0 HDi 90	06/98-05/04	RHS (DW10ATED), RHZ (DW10ATED), RHY (DW10TD), RHZ (DW10ATED)	1997	Orga. → 08735	0-N118P	TB [TE]	
2.0 HDi 110, 2.0 HDi 90	06/98-05/04	RHS (DW10ATED), RHZ (DW10ATED), RHY (DW10TD), RHZ (DW10ATED)	1997	Orga. → 08735	0-N119P	TB [DG]	
2.0 HDi 110, 2.0 HDi 90	06/98-05/04	RHS (DW10ATED), RHZ (DW10ATED), RHY (DW10TD), RHZ (DW10ATED)	1997	Orga.08736 →	0-N1381	TB [DG]	
2.0, 2.0 Turbo	04/96-05/04	RGX (XU10J2TE), RGY (XU10J2TE)	1998		0-N811	TB [TE]	
2.1 TD 12V	01/96-05/04	P8C (XUD11BTE)	2088		0-N862	TB [DG]	
2.1 TD 12V	01/96-05/04	P8C (XUD11BTE)	2088		0-N871	TB [TE]	
2.2	07/00-05/04	3FZ (EW12J4)	2230		0-N1057	TB [TE]	
2.2	07/00-05/04	3FZ (EW12J4)	2230		0-N1065	TB [DG]	
2.2 HDi	03/00-05/04	4HX (DW12TED4/FAP)	2179	Orga. → 10010	0-N118P	TB [TE]	
2.2 HDi	03/00-05/04	4HX (DW12TED4/FAP)	2179	Orga. → 10010	0-N119P	TB [DG]	
2.2 HDi	03/00-05/04	4HX (DW12TED4/FAP)	2179	Orga. 10011 →	0-N1357	TB [TE]	
2.2 HDi	03/00-05/04	4HX (DW12TED4/FAP)	2179	Orga. 10011 →	0-N1358	TB [DG]	
3.0 24V, 3.0 V6	10/96-05/04	XFX (ES9J4S), XFX (ES9J4)	2946		0-N1056	TB [TE]	
3.0 24V, 3.0 V6	10/96-05/04	XFX (ES9J4S), XFX (ES9J4)	2946		0-N170	TB [DG]	
3.0 24V, 3.0 V6	10/96-05/04	XFX (ES9J4S), XFX (ES9J4)	2946		0-N171	TB [DG]	
1.6	11/95-05/04	BFZ (XU5JP)	1580	Orga. → 07904	0-N124	VB [TE]	
1.6	11/95-05/04	BFZ (XU5JP)	1580	☼	0-N1405	VB [DG]	
1.6	11/95-05/04	BFZ (XU5JP)	1580	☼	0-N1484	VB [BT]	S
1.6	11/95-05/04	BFZ (XU5JP)	1580	Orga.07905 →; ☼	0-N1968	VB [BT]	
1.8 16V	10/00-05/04	6FZ (EW7J4)	1749		0-N1391	VB [BT]	S
1.8 16V	10/00-05/04	6FZ (EW7J4)	1749		0-N1416	VB [DG]	
1.8, 1.8 16V	11/95-05/04	LFX (XU7JB), LFY (XU7JP4)	1761	Orga. → 7904	0-N124	VB [TE]	
1.8, 1.8 16V	11/95-05/04	LFX (XU7JB), LFY (XU7JP4)	1761	Generator-Ladestrom [A]: 90; ☼	0-N1402	VB [DG]	S
1.8, 1.8 16V	11/95-05/04	LFX (XU7JB), LFY (XU7JP4)	1761	Generator-Ladestrom [A]: 120; ☼	0-N1465S	VB [DG]	
1.8, 1.8 16V	11/95-05/04	LFX (XU7JB), LFY (XU7JP4)	1761	☼	0-N1484	VB [BT]	S
1.8, 1.8 16V	11/95-05/04	LFX (XU7JB), LFY (XU7JP4)	1761	Orga.7905 →; ☼	0-N1968	VB [BT]	
1.9 D, 1.9 TD	01/96-05/04	DHW (XUD9SD), DHX (XUD9TE), DHY (XUD9TE)	1905		0-N1320	VB [TE]	
1.9 D, 1.9 TD	01/96-05/04	DHW (XUD9SD), DHX (XUD9TE), DHY (XUD9TE)	1905		0-N1472	VB [BT]	S
1.9 D, 1.9 TD	01/96-05/04	DHW (XUD9SD), DHX (XUD9TE), DHY (XUD9TE)	1905		0-N1747	VB [VD]	
1.9 TD	01/96-05/04	DHX (XUD9TE), DHY (XUD9TE)	1905		0-N931	VB [TE]	
2.0 16V	11/95-05/04	RFV (XU10J4R)	1998	☼	0-N1713	VB [BT]	



OPTIMAL®

PEUGEOT



CM³



Art. Nr.



ohne Halter

406 (8B)							
2.0 16V	11/95-05/04	RFV (XU10J4R)	1998	✱		0-N1722	VB [DG]
2.0 16V, 2.0 16V HPi	01/99-06/04	RFN (EW10J4), RFR (DEW10J4), RLZ (EW10D)	1997			0-N1391	VB [BT] S
2.0 16V, 2.0 16V HPi	01/99-06/04	RFN (EW10J4), RFR (DEW10J4), RLZ (EW10D)	1997			0-N1416	VB [DG]
2.0 16V, 2.0 Turbo	11/95-05/04	RFV (XU10J4R), RGX (XU10J2TE)	1998	✱		0-N1463S	VB [DG]
2.0 16V, 2.0 Turbo	11/95-05/04	RFV (XU10J4R), RGX (XU10J2TE)	1998	✱		0-N1484	VB [BT] S
2.0 HDi 110, 2.0 HDi 90	06/98-05/04	RHS (DW10ATED), RHZ (DW10ATED), RHY (DW10TD), RHZ (DW10ATED)	1997			0-N1320	VB [TE]
2.0 HDi 110, 2.0 HDi 90	06/98-05/04	RHS (DW10ATED), RHZ (DW10ATED), RHY (DW10TD), RHZ (DW10ATED)	1997			0-N1493	VB [BT] S
2.0 HDi 110, 2.0 HDi 90	06/98-05/04	RHS (DW10ATED), RHZ (DW10ATED), RHY (DW10TD), RHZ (DW10ATED)	1997	✱		0-N151	VB [DG]
2.0 HDi 110, 2.0 HDi 90	06/98-05/04	RHS (DW10ATED), RHZ (DW10ATED), RHY (DW10TD), RHZ (DW10ATED)	1997	✱		0-N1748	VB [BT]
2.1 TD 12V	01/96-05/04	P8C (XUD11BTE)	2088			0-N1320	VB [TE]
2.1 TD 12V	01/96-05/04	P8C (XUD11BTE)	2088			0-N1472	VB [BT] S
2.1 TD 12V	01/96-05/04	P8C (XUD11BTE)	2088			0-N1747	VB [VD]
2.1 TD 12V	01/96-05/04	P8C (XUD11BTE)	2088			0-N931	VB [TE]
2.2	07/00-05/04	3FZ (EW12J4)	2230			0-N1391	VB [BT] S
2.2	07/00-05/04	3FZ (EW12J4)	2230			0-N1416	VB [DG]
2.2 HDi	03/00-05/04	4HX (DW12TED4/FAP)	2179			0-N1413	VB [DG]
2.2 HDi	03/00-05/04	4HX (DW12TED4/FAP)	2179			0-N1493	VB [BT] S
3.0 24V	10/96-05/04	XFZ (ES9J4)	2946			0-N2175	VB [BT]
3.0 24V, 3.0 V6	10/96-05/04	XFZ (ES9J4S), XFZ (ES9J4)	2946			0-N1449	VB [TE]
3.0 24V, 3.0 V6	10/96-05/04	XFZ (ES9J4S), XFZ (ES9J4)	2946			0-N1757	VB [VD]
3.0 V6	03/00-05/04	XFZ (ES9J4S)	2946			0-N1473	VB [BT] S
406 Break (8E/F)							
1.8	05/97-10/04	LFY (XU7JB)	1761	17x114		SK-1019	BTK
1.8 16V	10/96-10/00	LFY (XU7JP4)	1761	25x136; → 01/2000; Abgasnorm: Euro 3 (D3); Orga.→08469		SK-1082	BTK
1.8 16V	10/96-10/00	LFY (XU7JP4)	1761	25x136; 01/2000 →; Spannrollenbetätigung: manuell		SK-1082AQ1	BTKW
1.8 16V	10/96-10/00	LFY (XU7JP4)	1761	25x136; Abgasnorm: Euro 2; mit Zubehör; Spannrollenbetätigung: automatisch		SK-1399	BTK
1.8 16V	10/96-10/00	LFY (XU7JP4)	1761	25x136; Abgasnorm: Euro 3 (D3); mit Zubehör; Spannrollenbetätigung: automatisch		SK-1399	BTK
1.8 16V	10/96-10/00	LFY (XU7JP4)	1761	25x136; → 01/2000; Abgasnorm: Euro 3 (D3); Orga.→08469; mit Zubehör; Spannrollenbetätigung: automatisch; Baumuster: PHASE 2		SK-1399AQ1	BTKW
1.8 16V	10/96-10/00	LFY (XU7JP4)	1761	25x136; Abgasnorm: Euro 2; mit Zubehör; Spannrollenbetätigung: automatisch; Baumuster: PHASE 2		SK-1399AQ1	BTKW
1.8 16V	10/96-10/00	LFY (XU7JP4)	1761	25x136; mit Zubehör; Spannrollenbetätigung: automatisch; Baumuster: PHASE 1		SK-1399AQ1	BTKW
1.8 16V	10/00-10/04	6FZ (EW7J4)	1749	25.4x153		SK-1482	BTK
1.8 16V	10/00-10/04	6FZ (EW7J4)	1749	25.4x153		SK-1482AQ1	BTKW
1.9 D, 1.9 TD	10/96-10/04	DHW (XUD9SD), DHX (XUD9TE)	1905	25.4x136		SK-1022	BTK
1.9 D, 1.9 TD	10/96-10/04	DHW (XUD9SD), DHX (XUD9TE)	1905	25.4x136; Orga.07390→		SK-1022AQ1	BTKW
1.9 D, 1.9 TD	10/96-10/04	DHW (XUD9SD), DHX (XUD9TE)	1905	25.4x136; Orga.→07389		SK-1022AQ2	BTKW
2.0 16V	10/96-10/04	RFV (XU10J4R)	1998	25x136		SK-1082	BTK
2.0 16V	10/96-10/04	RFV (XU10J4R)	1998	25x136		SK-1082AQ2	BTKW
2.0 16V	01/99-10/04	RFN (EW10J4), RFR (DEW10J4)	1997	25.4x153		SK-1482	BTK
2.0 16V	01/99-10/04	RFN (EW10J4), RFR (DEW10J4)	1997	25.4x153		SK-1482AQ1	BTKW
2.0 16V HPi	05/01-10/04	RLZ (EW10D)	1997	25.4x143		SK-1393	BTK
2.0 HDi 110	08/01-10/04	RHS (DW10ATED), RHZ (DW10ATED)	1997	25x141; Orga.8736→; mit Zubehör		SK-1085	BTK
2.0 HDi 110, 2.0 HDi 90	02/99-10/04	RHY (DW10TD), RHZ (DW10ATED)	1997	25x141; → 10/2000; Orga.→8735; mit Zubehör		SK-1085	BTK
2.0 HDi 110, 2.0 HDi 90	02/99-10/04	RHS (DW10ATED), RHZ (DW10ATED), RHY (DW10TD), RHZ (DW10ATED)	1997	25.4x141; mit Zubehör		SK-1085AQ1	BTKW
2.0 Turbo	10/96-10/04	RGX (XU10J2TE)	1998	17x114		SK-1019	BTK
2.1 TD 12V	10/96-10/04	P8C (XUD11BTE)	2088	25.4x149		SK-1017	BTK
2.1 TD 12V	10/96-10/04	P8C (XUD11BTE)	2088	25x149		SK-1017AQ1	BTKW
2.2	07/00-10/04	3FZ (EW12J4)	2230	25.4x153		SK-1482	BTK
2.2	07/00-10/04	3FZ (EW12J4)	2230	25.4x153		SK-1482AQ1	BTKW
2.2 HDi	03/00-10/04	4HX (DW12TED4/FAP)	2179	25.4x146; → 04/2004; Orga.→10010		SK-1394	BTK
2.2 HDi	03/00-10/04	4HX (DW12TED4/FAP)	2179	25.4x146; → 04/2004; Orga.→10010		SK-1394AQ1	BTKW

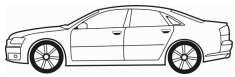

CM³



Art. Nr.



ohne Halter

406 Break (8E/F)

2.2 HDI	03/00-10/04	4HX (DW12TED4/FAP)	2179	25.4x146; 04/2004 →; Orga.10011→; Baumuster: 4HX	SK-1614	BTK
2.2 HDI	03/00-10/04	4HX (DW12TED4/FAP)	2179	25.4x146; 04/2004 →; Orga.10011→	SK-1614AQ1	BTKW
3.0 V6	03/00-10/04	XFX (ES9J4S)	2946	32x259	SK-1483	BTK
3.0 V6	03/00-10/04	XFX (ES9J4S)	2946	32x259; 04/2000 →	SK-1483AQ1	BTKW
1.8	05/97-10/04	LFX (XU7JB)	1761		0-N811	TB [TE]
1.8 16V	10/96-10/00	LFY (XU7JP4)	1761	Orga.08470→	0-N1058	TB [TE]
1.8 16V	10/96-10/00	LFY (XU7JP4)	1761		0-N862	TB [DG]
1.8 16V	10/96-10/00	LFY (XU7JP4)	1761	Orga.→08469	0-N943	TB [TE]
1.8 16V	10/00-10/04	6FZ (EW7J4)	1749		0-N1057	TB [TE]
1.8 16V	10/00-10/04	6FZ (EW7J4)	1749		0-N1065	TB [DG]
1.9 D, 1.9 TD	10/96-10/04	DHW (XUD9SD), DHX (XUD9TE)	1905		0-N900	TB [DG]
1.9 D, 1.9 TD	10/96-10/04	DHW (XUD9SD), DHX (XUD9TE)	1905		0-N901	TB [TE]
2.0 16V	10/96-10/04	RFV (XU10J4R)	1998		0-N862	TB [DG]
2.0 16V	10/96-10/04	RFV (XU10J4R)	1998		0-N943	TB [TE]
2.0 16V	01/99-10/04	RFN (EW10J4), RFR (DEW10J4)	1997		0-N1057	TB [TE]
2.0 16V HPI	05/01-10/04	RLZ (EW10D)	1997		0-N1060	TB [TE]
2.0 16V, 2.0 16V HPI	01/99-10/04	RFN (EW10J4), RFR (DEW10J4), RLZ (EW10D)	1997		0-N1065	TB [DG]
2.0 HDi 110, 2.0 HDi 90	02/99-10/04	RHS (DW10ATED), RHZ (DW10ATED), RHY (DW10TD), RHZ (DW10ATED)	1997	Orga.→08735	0-N118P	TB [TE]
2.0 HDi 110, 2.0 HDi 90	02/99-10/04	RHS (DW10ATED), RHZ (DW10ATED), RHY (DW10TD), RHZ (DW10ATED)	1997	Orga.→08735	0-N119P	TB [DG]
2.0 HDi 110, 2.0 HDi 90	02/99-10/04	RHS (DW10ATED), RHZ (DW10ATED), RHY (DW10TD), RHZ (DW10ATED)	1997	Orga.08736→	0-N1381	TB [DG]
2.0, 2.0 Turbo	10/96-10/04	RGX (XU10J2TE), RGY (XU10J2TE)	1998		0-N811	TB [TE]
2.1 TD 12V	10/96-10/04	P8C (XUD11BTE)	2088		0-N862	TB [DG]
2.1 TD 12V	10/96-10/04	P8C (XUD11BTE)	2088		0-N871	TB [TE]
2.2	07/00-10/04	3FZ (EW12J4)	2230		0-N1057	TB [TE]
2.2	07/00-10/04	3FZ (EW12J4)	2230		0-N1065	TB [DG]
2.2 HDI	03/00-10/04	4HX (DW12TED4/FAP)	2179	Orga.→10010	0-N118P	TB [TE]
2.2 HDI	03/00-10/04	4HX (DW12TED4/FAP)	2179	Orga.→10010	0-N119P	TB [DG]
2.2 HDI	03/00-10/04	4HX (DW12TED4/FAP)	2179	Orga.10011→	0-N1357	TB [TE]
2.2 HDI	03/00-10/04	4HX (DW12TED4/FAP)	2179	Orga.10011→	0-N1358	TB [DG]
3.0 24V, 3.0 V6	10/96-10/04	XFX (ES9J4S), XFX (ES9J4)	2946		0-N1056	TB [TE]
3.0 24V, 3.0 V6	10/96-10/04	XFX (ES9J4S), XFX (ES9J4)	2946		0-N170	TB [DG]
3.0 24V, 3.0 V6	10/96-10/04	XFX (ES9J4S), XFX (ES9J4)	2946		0-N171	TB [DG]
1.8 16V	10/00-10/04	6FZ (EW7J4)	1749		0-N1391	VB [BT] S
1.8 16V	10/00-10/04	6FZ (EW7J4)	1749		0-N1416	VB [DG]
1.8, 1.8 16V	10/96-10/04	LFX (XU7JB), LFY (XU7JP4)	1761	Orga.→7904	0-N124	VB [TE]
1.8, 1.8 16V	10/96-10/04	LFX (XU7JB), LFY (XU7JP4)	1761	Generator-Ladestrom [A]: 90; ⚡	0-N1402	VB [DG] S
1.8, 1.8 16V	10/96-10/04	LFX (XU7JB), LFY (XU7JP4)	1761	Generator-Ladestrom [A]: 120; ⚡	0-N1465S	VB [DG]
1.8, 1.8 16V	10/96-10/04	LFX (XU7JB), LFY (XU7JP4)	1761	⚡	0-N1484	VB [BT] S
1.8, 1.8 16V	10/96-10/04	LFX (XU7JB), LFY (XU7JP4)	1761	Orga.7905→; ⚡	0-N1968	VB [BT]
1.9 D, 1.9 TD	10/96-10/04	DHW (XUD9SD), DHX (XUD9TE)	1905		0-N1320	VB [TE]
1.9 D, 1.9 TD	10/96-10/04	DHW (XUD9SD), DHX (XUD9TE)	1905		0-N1472	VB [BT] S
1.9 D, 1.9 TD	10/96-10/04	DHW (XUD9SD), DHX (XUD9TE)	1905		0-N1747	VB [VD]
1.9 D, 1.9 TD	10/96-10/04	DHW (XUD9SD), DHX (XUD9TE)	1905		0-N931	VB [TE]
2.0 16V	10/96-10/04	RFV (XU10J4R)	1998	⚡	0-N1713	VB [BT]
2.0 16V	10/96-10/04	RFV (XU10J4R)	1998	⚡	0-N1722	VB [DG]
2.0 16V, 2.0 16V HPI	01/99-10/04	RFN (EW10J4), RFR (DEW10J4), RLZ (EW10D)	1997		0-N1391	VB [BT] S
2.0 16V, 2.0 16V HPI	01/99-10/04	RFN (EW10J4), RFR (DEW10J4), RLZ (EW10D)	1997		0-N1416	VB [DG]
2.0 16V, 2.0 Turbo	10/96-10/04	RFV (XU10J4R), RGX (XU10J2TE)	1998	⚡	0-N1463S	VB [DG]
2.0 16V, 2.0 Turbo	10/96-10/04	RFV (XU10J4R), RGX (XU10J2TE)	1998	⚡	0-N1484	VB [BT] S
2.0 HDi 110, 2.0 HDi 90	02/99-10/04	RHS (DW10ATED), RHZ (DW10ATED), RHY (DW10TD), RHZ (DW10ATED)	1997		0-N1320	VB [TE]
2.0 HDi 110, 2.0 HDi 90	02/99-10/04	RHS (DW10ATED), RHZ (DW10ATED), RHY (DW10TD), RHZ (DW10ATED)	1997		0-N1493	VB [BT] S
2.0 HDi 110, 2.0 HDi 90	02/99-10/04	RHS (DW10ATED), RHZ (DW10ATED), RHY (DW10TD), RHZ (DW10ATED)	1997	⚡	0-N151	VB [DG]
2.0 HDi 110, 2.0 HDi 90	02/99-10/04	RHS (DW10ATED), RHZ (DW10ATED), RHY (DW10TD), RHZ (DW10ATED)	1997	⚡	0-N1748	VB [BT]
2.1 TD 12V	10/96-10/04	P8C (XUD11BTE)	2088		0-N1320	VB [TE]
2.1 TD 12V	10/96-10/04	P8C (XUD11BTE)	2088		0-N1472	VB [BT] S
2.1 TD 12V	10/96-10/04	P8C (XUD11BTE)	2088		0-N1747	VB [VD]
2.1 TD 12V	10/96-10/04	P8C (XUD11BTE)	2088		0-N931	VB [TE]



OPTIMAL®

PEUGEOT



CM³



Art. Nr.



ohne Halter

406 Break (8E/F)

2.2	07/00-10/04	3FZ (EW12J4)	2230		0-N1391	VB [BT]	S
2.2	07/00-10/04	3FZ (EW12J4)	2230		0-N1416	VB [DG]	
2.2 HDI	03/00-10/04	4HX (DW12TED4/FAP)	2179		0-N1413	VB [DG]	
2.2 HDI	03/00-10/04	4HX (DW12TED4/FAP)	2179		0-N1493	VB [BT]	S
3.0 24V	10/96-10/04	XFZ (ES9J4)	2946		0-N2175	VB [BT]	
3.0 24V, 3.0 V6	10/96-10/04	XFX (ES9J4S), XFZ (ES9J4)	2946		0-N1449	VB [TE]	
3.0 24V, 3.0 V6	10/96-10/04	XFX (ES9J4S), XFZ (ES9J4)	2946		0-N1757	VB [VD]	
3.0 V6	03/00-10/04	XFX (ES9J4S)	2946		0-N1473	VB [BT]	S

406 Coupe (8C)

2.0 16V	03/97-12/04	RFV (XU10J4R)	1998	25x136	SK-1082	BTK	
2.0 16V	03/97-12/04	RFV (XU10J4R)	1998	25x136	SK-1082AQ2	BTKW	
2.0 16V	01/99-12/04	RFN (EW10J4), RFV (XU10J4R), RFR (DEW10J4)	1997	25.4x153	SK-1482	BTK	
2.0 16V	01/99-12/04	RFN (EW10J4), RFV (XU10J4R), RFR (DEW10J4)	1997	25.4x153	SK-1482AQ1	BTKW	
2.2	03/02-12/04	3FZ (EW12J4)	2230	25.4x153	SK-1482	BTK	
2.2	03/02-12/04	3FZ (EW12J4)	2230	25.4x153	SK-1482AQ1	BTKW	
2.2 HDI	03/00-12/04	4HX (DW12TED4/FAP)	2179	25.4x146; 09/2000 → 04/2004; Orga. → 10010	SK-1394	BTK	
2.2 HDI	03/00-12/04	4HX (DW12TED4/FAP)	2179	25.4x146; → 04/2004; Orga. → 10010	SK-1394AQ1	BTKW	
2.2 HDI	03/00-12/04	4HX (DW12TED4/FAP)	2179	25.4x146; 04/2004 →; Orga. 10011 →; Baumuster: 4HX	SK-1614	BTK	
2.2 HDI	03/00-12/04	4HX (DW12TED4/FAP)	2179	25.4x146; 04/2004 →; Orga. 10011 →	SK-1614AQ1	BTKW	
3.0 V6	03/00-12/04	XFX (ES9J4S)	2946	32x259	SK-1483	BTK	
3.0 V6	03/00-12/04	XFX (ES9J4S)	2946	32x259; 04/2000 →	SK-1483AQ1	BTKW	
2.0 16V	03/97-12/04	RFV (XU10J4R)	1998		0-N862	TB [DG]	
2.0 16V	03/97-12/04	RFV (XU10J4R)	1998		0-N943	TB [TE]	
2.0 16V	01/99-12/04	RFN (EW10J4), RFV (XU10J4R), RFR (DEW10J4)	1997		0-N1057	TB [TE]	
2.0 16V	01/99-12/04	RFN (EW10J4), RFV (XU10J4R), RFR (DEW10J4)	1997		0-N1065	TB [DG]	
2.2	03/02-12/04	3FZ (EW12J4)	2230		0-N1057	TB [TE]	
2.2	03/02-12/04	3FZ (EW12J4)	2230		0-N1065	TB [DG]	
2.2 HDI	03/00-12/04	4HX (DW12TED4/FAP)	2179	Orga. → 10010	0-N118P	TB [TE]	
2.2 HDI	03/00-12/04	4HX (DW12TED4/FAP)	2179	Orga. → 10010	0-N119P	TB [DG]	
2.2 HDI	03/00-12/04	4HX (DW12TED4/FAP)	2179	Orga. 10011 →	0-N1357	TB [TE]	
2.2 HDI	03/00-12/04	4HX (DW12TED4/FAP)	2179	Orga. 10011 →	0-N1358	TB [DG]	
3.0 V6, 3.0 V6 24V	03/97-12/04	XFX (ES9J4S), XFZ (ES9J4)	2946		0-N1056	TB [TE]	
3.0 V6, 3.0 V6 24V	03/97-12/04	XFX (ES9J4S), XFZ (ES9J4)	2946		0-N170	TB [DG]	
3.0 V6, 3.0 V6 24V	03/97-12/04	XFX (ES9J4S), XFZ (ES9J4)	2946		0-N171	TB [DG]	
2.0 16V	03/97-12/04	RFV (XU10J4R)	1998	✱	0-N1463S	VB [DG]	
2.0 16V	03/97-12/04	RFV (XU10J4R)	1998	✱	0-N1484	VB [BT]	S
2.0 16V	03/97-12/04	RFV (XU10J4R)	1998	✱	0-N1713	VB [BT]	
2.0 16V	03/97-12/04	RFV (XU10J4R)	1998	✱	0-N1722	VB [DG]	
2.0 16V	01/99-12/04	RFN (EW10J4), RFV (XU10J4R), RFR (DEW10J4)	1997		0-N1391	VB [BT]	S
2.0 16V	01/99-12/04	RFN (EW10J4), RFV (XU10J4R), RFR (DEW10J4)	1997		0-N1416	VB [DG]	
2.2	03/02-12/04	3FZ (EW12J4)	2230		0-N1391	VB [BT]	S
2.2	03/02-12/04	3FZ (EW12J4)	2230		0-N1416	VB [DG]	
2.2 HDI	03/00-12/04	4HX (DW12TED4/FAP)	2179		0-N1413	VB [DG]	
2.2 HDI	03/00-12/04	4HX (DW12TED4/FAP)	2179		0-N1493	VB [BT]	S
3.0 V6	03/00-12/04	XFX (ES9J4S)	2946		0-N1473	VB [BT]	S
3.0 V6 24V	03/97-12/04	XFZ (ES9J4)	2946		0-N2175	VB [BT]	
3.0 V6, 3.0 V6 24V	03/97-12/04	XFX (ES9J4S), XFZ (ES9J4)	2946		0-N1449	VB [TE]	
3.0 V6, 3.0 V6 24V	03/97-12/04	XFX (ES9J4S), XFZ (ES9J4)	2946		0-N1757	VB [VD]	

407 (6D_)

1.6 HdI 110	05/04-	9HY (DV6TED4), 9HZ (DV6TED4)	1560	25x137	SK-1424	BTK	
1.6 HdI 110	05/04-	9HY (DV6TED4), 9HZ (DV6TED4)	1560	25x137	SK-1424AQ1	BTKW	
1.8	05/04-	6FZ (EW7J4)	1749	25.4x153	SK-1482	BTK	
1.8	05/04-	6FZ (EW7J4)	1749	25.4x153	SK-1482AQ1	BTKW	
1.8 16V	09/05-	6FY (EW7A)	1749	25x153	SK-1600	BTK	
1.8 16V	09/05-	6FY (EW7A)	1749	25x153	SK-1600AQ1	BTKW	
2.0	05/04-	RFN (EW10J4)	1997	25.4x153	SK-1482	BTK	
2.0	05/04-	RFN (EW10J4)	1997	25.4x153	SK-1482AQ1	BTKW	
2.0 16V	09/05-	RFJ (EW10A)	1997	25x153	SK-1600	BTK	
2.0 16V, 2.0 Bioflex	09/05-	RFJ (EW10A)	1997	25x153	SK-1600AQ1	BTKW	



CM³



Art. Nr.



407 (6D_)

2.0 Bioflex	09/07-	RFJ (EW10A)	1997	25x153; 01/2009 →	SK-1600	BTK	
2.0 HDi	08/08-	RHF (DW10BTED4), RHR (DW10BTED4)	1997	25.4x116; 06/2009 →	SK-1594	BTK	
2.0 HDi	07/09-	RHE (DW10CTED4), RHH (DW10CTED4)	1997	25x116	SK-1714	BTK	
2.0 HDi	07/09-	RHE (DW10CTED4), RHH (DW10CTED4)	1997	25x116	SK-1714AQ1	BTKW	
2.0 HDi, 2.0 HDi 135	05/04-	RHH (DW10CTED4), RHR (DW10BTED4)	1997	25.4x116	SK-1594	BTK	
2.0 HDi, 2.0 HDi 135	05/04-	RHF (DW10BTED4), RHR (DW10BTED4), RHR (DW10BTED4)	1997	25.4x116	SK-1594AQ1	BTKW	
2.2 HDi 170	05/06-	4HT (DW12BTED4)	2179	25.4x118; → 12/2006	SK-1588	BTK	
2.2 HDi, 2.2 HDi 170	05/06-	4HP (DW12BTED4), 4HT (DW12BTED4)	2179	25.4x118	SK-1692	BTK	
2.2 HDi, 2.2 HDi 170	05/06-	4HP (DW12BTED4), 4HT (DW12BTED4)	2179	25.4x118	SK-1692AQ1	BTKW	
2.2, 2.2 16V	05/04-	3FY (EW12J4), 3FZ (EW12J4)	2230	25.4x153	SK-1482	BTK	
2.2, 2.2 16V	05/04-	3FY (EW12J4), 3FZ (EW12J4)	2230	25.4x153	SK-1482AQ1	BTKW	
2.7 HDi	10/05-	UHZ (DT17)	2720	29x195; 20x85	SK-1675	BTK	
2.7 HDi	10/05-	UHZ (DT17)	2720	29x195	SK-1742	BTK	
3.0	05/04-	XFV (ES9A)	2946	32x259	SK-1483	BTK	
3.0	05/04-	XFV (ES9A)	2946	32x259	SK-1483AQ1	BTKW	
1.6 HDi 110	05/04-	9HY (DV6TED4), 9HZ (DV6TED4)	1560		0-N1062	TB [TE]	
1.6 HDi 110	05/04-	9HY (DV6TED4), 9HZ (DV6TED4)	1560		0-N1066	TB [DG]	
1.8	05/04-	6FZ (EW7J4)	1749		0-N1057	TB [TE]	
1.8 16V	09/05-	6FY (EW7A)	1749		0-N1343	TB [TE]	
1.8, 1.8 16V	05/04-	6FY (EW7A), 6FZ (EW7J4)	1749		0-N1065	TB [DG]	
2.0	05/04-	RFN (EW10J4)	1997		0-N1057	TB [TE]	
2.0 16V, 2.0 Bioflex	09/05-	RFJ (EW10A)	1997		0-N1343	TB [TE]	
2.0 HDi	08/08-	RHE (DW10CTED4), RHF (DW10BTED4), RHR (DW10BTED4), RHH (DW10CTED4)	1997		0-N2063	TB [TE]	
2.0 HDi, 2.0 HDi 135	05/04-	RHE (DW10CTED4), RHF (DW10BTED4), RHR (DW10BTED4), RHH (DW10CTED4), RHR (DW10BTED4)	1997		0-N1334	TB [DG]	
2.0, 2.0 16V, 2.0 Bioflex	05/04-	RFJ (EW10A), RFN (EW10J4)	1997		0-N1065	TB [DG]	
2.2 HDi, 2.2 HDi 170	05/06-	4HP (DW12BTED4), 4HT (DW12BTED4)	2179		0-N1334	TB [DG]	
2.2 HDi, 2.2 HDi 170	05/06-	4HP (DW12BTED4), 4HT (DW12BTED4)	2179		0-N2018	TB [BT]	
2.2, 2.2 16V	05/04-	3FY (EW12J4), 3FZ (EW12J4)	2230		0-N1057	TB [TE]	
2.2, 2.2 16V	05/04-	3FY (EW12J4), 3FZ (EW12J4)	2230		0-N1065	TB [DG]	
2.7 HDi	10/05-	UHZ (DT17)	2720		0-N1613	TB [TE]	
2.7 HDi	10/05-	UHZ (DT17)	2720		0-N1614	TB [TE]	
2.7 HDi	10/05-	UHZ (DT17)	2720		0-N1615	TB [DG]	
3.0	05/04-	XFV (ES9A)	2946		0-N1056	TB [TE]	
3.0	05/04-	XFV (ES9A)	2946		0-N170	TB [DG]	
3.0	05/04-	XFV (ES9A)	2946		0-N171	TB [DG]	
1.6 HDi 110	05/04-	9HY (DV6TED4), 9HZ (DV6TED4)	1560	Orga. → 11619, 11920	0-N1418	VB [DG]	
1.6 HDi 110	05/04-	9HY (DV6TED4), 9HZ (DV6TED4)	1560	09/2008 →; Orga. 11620 →	0-N1502	VB [BT]	S
1.6 HDi 110	05/04-	9HY (DV6TED4), 9HZ (DV6TED4)	1560	Orga. → 10555	0-N1636	VB [BT]	S
1.6 HDi 110	05/04-	9HY (DV6TED4), 9HZ (DV6TED4)	1560	Orga. 11620, 11921 →	0-N1807	VB [DG]	
1.6 HDi 110	05/04-	9HY (DV6TED4), 9HZ (DV6TED4)	1560	Orga. 11620, 11921 →	0-N1808	VB [BT]	S
1.8	05/04-	6FZ (EW7J4)	1749		0-N1391	VB [BT]	S
1.8	05/04-	6FZ (EW7J4)	1749		0-N1416	VB [DG]	
1.8 16V	09/05-	6FY (EW7A)	1749		0-N1840	VB [BT]	S
2.0	05/04-	RFN (EW10J4)	1997	Orga. → 10247	0-N1391	VB [BT]	S
2.0	05/04-	RFN (EW10J4)	1997	Orga. → 10247	0-N1416	VB [DG]	
2.0	05/04-	RFN (EW10J4)	1997	Orga. 10248 →	0-N1840	VB [BT]	S
2.0	05/04-	RFN (EW10J4)	1997	Rippenanzahl: 6; Orga. → 10247; ✖	0-N2094	VB [DG]	
2.0 16V, 2.0 Bioflex	09/05-	RFJ (EW10A)	1997		0-N1840	VB [BT]	S
2.0 HDi	07/09-	RHE (DW10CTED4), RHH (DW10CTED4)	1997		0-N2268	VB [BT]	S
2.0 HDi 135	05/04-	RHR (DW10BTED4)	1997		0-N1327	VB [BT]	
2.0 HDi 135	05/04-	RHR (DW10BTED4)	1997	Orga. → 11193	0-N2037	VB [BT]	S
2.0 HDi 135	05/04-	RHR (DW10BTED4)	1997	Orga. 11194 →	0-N2046	VB [BT]	S
2.2 HDi, 2.2 HDi 170	05/06-	4HP (DW12BTED4), 4HT (DW12BTED4)	2179		0-N2042	VB [BT]	S
2.2, 2.2 16V	05/04-	3FY (EW12J4), 3FZ (EW12J4)	2230	Orga. → 10247	0-N1391	VB [BT]	S
2.2, 2.2 16V	05/04-	3FY (EW12J4), 3FZ (EW12J4)	2230	Orga. → 10247	0-N1416	VB [DG]	
2.2, 2.2 16V	05/04-	3FY (EW12J4), 3FZ (EW12J4)	2230	Orga. 10248 →	0-N1840	VB [BT]	S
2.2, 2.2 16V	05/04-	3FY (EW12J4), 3FZ (EW12J4)	2230	Rippenanzahl: 6; Orga. → 10247; ✖	0-N2094	VB [DG]	
3.0	05/04-	XFV (ES9A)	2946	Orga. → 10055	0-N1449	VB [TE]	
3.0	05/04-	XFV (ES9A)	2946		0-N1473	VB [BT]	S
3.0	05/04-	XFV (ES9A)	2946		0-N1757	VB [VD]	

407 Coupe (6C_)

2.0 HDi	10/05-	RHH (DW10CTED4), RHR (DW10BTED4)	1997	25.4x116	SK-1594	BTK	
---------	--------	----------------------------------	------	----------	---------	-----	--

CM³

Art. Nr.



ohne Halter

407 Coupe (6C_)

2.0 HDi	10/05-	RHR (DW10BTED4)	1997	25.4x116	SK-1594AQ1	BTKW	
2.0 HDi	06/09-	RHE (DW10CTED4), RHH (DW10CTED4)	1997	25x116	SK-1714	BTK	
2.0 HDi	06/09-	RHE (DW10CTED4), RHH (DW10CTED4)	1997	25x116	SK-1714AQ1	BTKW	
2.2 16V	10/05-	3FY (EW12J4)	2230	25.4x153	SK-1482	BTK	
2.2 16V	10/05-	3FY (EW12J4)	2230	25.4x153	SK-1482AQ1	BTKW	
2.7 HDi	10/05-	UHZ (DT17)	2720	29x195; 20x85	SK-1675	BTK	
2.7 HDi	10/05-	UHZ (DT17)	2720	29x195	SK-1742	BTK	
3.0 HDi	06/09-	DT20C	2992	29x195	SK-1742	BTK	
3.0 V6	10/05-	XFV (ES9A)	2946	32x259	SK-1483	BTK	
3.0 V6	10/05-	XFV (ES9A)	2946	32x259	SK-1483AQ1	BTKW	
2.0 HDi	10/05-	RHE (DW10CTED4), RHH (DW10CTED4), RHR (DW10BTED4)	1997		0-N1334	TB [DG]	
2.0 HDi	06/09-	RHE (DW10CTED4), RHH (DW10CTED4)	1997		0-N2063	TB [TE]	
2.2 16V	10/05-	3FY (EW12J4)	2230		0-N1057	TB [TE]	
2.2 16V	10/05-	3FY (EW12J4)	2230		0-N1065	TB [DG]	
2.7 HDi	10/05-	UHZ (DT17)	2720		0-N1613	TB [TE]	
2.7 HDi	10/05-	UHZ (DT17)	2720		0-N1614	TB [TE]	
2.7 HDi	10/05-	UHZ (DT17)	2720		0-N1615	TB [DG]	
3.0 HDi	06/09-	DT20C	2992		0-N1613	TB [TE]	
3.0 HDi	06/09-	DT20C	2992		0-N1614	TB [TE]	
3.0 HDi	06/09-	DT20C	2992		0-N1615	TB [DG]	
3.0 V6	10/05-	XFV (ES9A)	2946		0-N1056	TB [TE]	
3.0 V6	10/05-	XFV (ES9A)	2946		0-N170	TB [DG]	
3.0 V6	10/05-	XFV (ES9A)	2946		0-N171	TB [DG]	
2.0 HDi	10/05-	RHR (DW10BTED4)	1997		0-N1327	VB [BT]	
2.0 HDi	10/05-	RHR (DW10BTED4)	1997	Orga.→11193	0-N2037	VB [BT]	S
2.0 HDi	10/05-	RHR (DW10BTED4)	1997	Orga.11194→	0-N2046	VB [BT]	S
2.0 HDi	06/09-	RHE (DW10CTED4), RHH (DW10CTED4)	1997		0-N2268	VB [BT]	S
2.2 16V	10/05-	3FY (EW12J4)	2230	Orga.→10247	0-N1391	VB [BT]	S
2.2 16V	10/05-	3FY (EW12J4)	2230	Orga.→10247	0-N1416	VB [DG]	
2.2 16V	10/05-	3FY (EW12J4)	2230	Orga.10248→	0-N1840	VB [BT]	S
2.2 16V	10/05-	3FY (EW12J4)	2230	Rippenanzahl: 6; Orga.→10247; ✱	0-N2094	VB [DG]	
3.0 V6	10/05-	XFV (ES9A)	2946	Orga.→10055	0-N1449	VB [TE]	
3.0 V6	10/05-	XFV (ES9A)	2946		0-N1473	VB [BT]	S
3.0 V6	10/05-	XFV (ES9A)	2946		0-N1757	VB [VD]	

407 SW (6E_)

1.6 HDi 110	05/04-	9HZ (DV6TED4), 9HZ (DV6TED4)	1560	25x137	SK-1424	BTK	
1.6 HDi 110	05/04-	9HZ (DV6TED4), 9HZ (DV6TED4)	1560	25x137	SK-1424AQ1	BTKW	
1.8	05/04-	6FZ (EW7J4)	1749	25.4x153; 08/2004 →	SK-1482	BTK	
1.8	05/04-	6FZ (EW7J4)	1749	25.4x153	SK-1482AQ1	BTKW	
1.8 16V	09/05-	6FY (EW7A)	1749	25x153	SK-1600	BTK	
1.8 16V	09/05-	6FY (EW7A)	1749	25x153	SK-1600AQ1	BTKW	
2.0	05/04-	RFN (EW10J4)	1997	25.4x153; 08/2004 →	SK-1482	BTK	
2.0	05/04-	RFN (EW10J4)	1997	25.4x153	SK-1482AQ1	BTKW	
2.0 16V	09/05-	RFJ (EW10A)	1997	25x153	SK-1600	BTK	
2.0 16V, 2.0 Bioflex	09/05-	RFJ (EW10A)	1997	25x153	SK-1600AQ1	BTKW	
2.0 Bioflex	01/08-	RFJ (EW10A)	1997	25x153; 01/2009 →	SK-1600	BTK	
2.0 HDi	08/08-	RHR (DW10BTED4)	1997	25.4x116; 06/2009 →	SK-1594	BTK	
2.0 HDi	07/09-	RHE (DW10CTED4), RHH (DW10CTED4)	1997	25x116	SK-1714	BTK	
2.0 HDi	07/09-	RHE (DW10CTED4), RHH (DW10CTED4)	1997	25x116	SK-1714AQ1	BTKW	
2.0 HDi, 2.0 HDi 135	05/04-	RHH (DW10CTED4), RHR (DW10BTED4)	1997	25.4x116	SK-1594	BTK	
2.0 HDi, 2.0 HDi 135	05/04-	RHR (DW10BTED4)	1997	25.4x116	SK-1594AQ1	BTKW	
2.2	05/04-	3FZ (EW12J4)	2230	25.4x153; 08/2004 →	SK-1482	BTK	
2.2 16V	09/05-	3FY (EW12J4)	2230	25.4x153	SK-1482	BTK	
2.2 HDi 170	05/06-	4HT (DW12BTED4)	2179	25.4x118; → 12/2006	SK-1588	BTK	
2.2 HDi, 2.2 HDi 170	05/06-	4HP (DW12BTED4), 4HT (DW12BTED4)	2179	25.4x118	SK-1692	BTK	
2.2 HDi, 2.2 HDi 170	05/06-	4HP (DW12BTED4), 4HT (DW12BTED4)	2179	25.4x118	SK-1692AQ1	BTKW	
2.2, 2.2 16V	05/04-	3FY (EW12J4), 3FZ (EW12J4)	2230	25.4x153	SK-1482AQ1	BTKW	
2.7 HDi	10/05-	UHZ (DT17)	2720	29x195; 20x85	SK-1675	BTK	
2.7 HDi	10/05-	UHZ (DT17)	2720	29x195	SK-1742	BTK	
3.0	05/04-	XFV (ES9A)	2946	32x259; 08/2004 →	SK-1483	BTK	
3.0	05/04-	XFV (ES9A)	2946	32x259	SK-1483AQ1	BTKW	
1.6 HDi 110	05/04-	9HZ (DV6TED4), 9HZ (DV6TED4)	1560		0-N1062	TB [TE]	
1.6 HDi 110	05/04-	9HZ (DV6TED4), 9HZ (DV6TED4)	1560		0-N1066	TB [DG]	
1.8	05/04-	6FZ (EW7J4)	1749		0-N1057	TB [TE]	



CM³



Art. Nr.



407 SW (6E_)							
1.8 16V	09/05-	6FY (EW7A)	1749			0-N1343	TB [TE]
1.8, 1.8 16V	05/04-	6FY (EW7A), 6FZ (EW7J4)	1749			0-N1065	TB [DG]
2.0	05/04-	RFN (EW10J4)	1997			0-N1057	TB [TE]
2.0 16V, 2.0 Bioflex	09/05-	RFJ (EW10A)	1997			0-N1343	TB [TE]
2.0 HDi	08/08-	RHE (DW10CTED4), RHH (DW10CTED4), RHR (DW10BTED4)	1997			0-N2063	TB [TE]
2.0 HDi, 2.0 HDi 135	05/04-	RHE (DW10CTED4), RHH (DW10CTED4), RHR (DW10BTED4)	1997			0-N1334	TB [DG]
2.0, 2.0 16V, 2.0 Bioflex	05/04-	RFJ (EW10A), RFN (EW10J4)	1997			0-N1065	TB [DG]
2.2 HDi, 2.2 HDi 170	05/06-	4HP (DW12BTED4), 4HT (DW12BTED4)	2179			0-N1334	TB [DG]
2.2 HDi, 2.2 HDi 170	05/06-	4HP (DW12BTED4), 4HT (DW12BTED4)	2179			0-N2018	TB [BT]
2.2, 2.2 16V	05/04-	3FY (EW12J4), 3FZ (EW12J4)	2230			0-N1057	TB [TE]
2.2, 2.2 16V	05/04-	3FY (EW12J4), 3FZ (EW12J4)	2230			0-N1065	TB [DG]
2.7 HDi	10/05-	UHZ (DT17)	2720			0-N1613	TB [TE]
2.7 HDi	10/05-	UHZ (DT17)	2720			0-N1614	TB [TE]
2.7 HDi	10/05-	UHZ (DT17)	2720			0-N1615	TB [DG]
3.0	05/04-	XFV (ES9A)	2946			0-N1056	TB [TE]
3.0	05/04-	XFV (ES9A)	2946			0-N170	TB [DG]
3.0	05/04-	XFV (ES9A)	2946			0-N171	TB [DG]
1.6 HDi 110	05/04-	9HZ (DV6TED4), 9HZ (DV6TED4)	1560	Orga.→11619, 11920		0-N1418	VB [DG]
1.6 HDi 110	05/04-	9HZ (DV6TED4), 9HZ (DV6TED4)	1560	09/2008 →; Orga.11620→		0-N1502	VB [BT] S
1.6 HDi 110	05/04-	9HZ (DV6TED4), 9HZ (DV6TED4)	1560	Orga.→10555		0-N1636	VB [BT] S
1.6 HDi 110	05/04-	9HZ (DV6TED4), 9HZ (DV6TED4)	1560	Orga.11620, 11921→		0-N1807	VB [DG]
1.6 HDi 110	05/04-	9HZ (DV6TED4), 9HZ (DV6TED4)	1560	Orga.11620, 11921→		0-N1808	VB [BT] S
1.8	05/04-	6FZ (EW7J4)	1749			0-N1391	VB [BT] S
1.8	05/04-	6FZ (EW7J4)	1749			0-N1416	VB [DG]
1.8 16V	09/05-	6FY (EW7A)	1749			0-N1840	VB [BT] S
2.0	05/04-	RFN (EW10J4)	1997	Orga.→10247		0-N1391	VB [BT] S
2.0	05/04-	RFN (EW10J4)	1997	Orga.→10247		0-N1416	VB [DG]
2.0	05/04-	RFN (EW10J4)	1997	Orga.10248→		0-N1840	VB [BT] S
2.0	05/04-	RFN (EW10J4)	1997	Rippenanzahl: 6; Orga.→10247; ✖		0-N2094	VB [DG]
2.0 16V, 2.0 Bioflex	09/05-	RFJ (EW10A)	1997			0-N1840	VB [BT] S
2.0 HDi	07/09-	RHE (DW10CTED4), RHH (DW10CTED4)	1997			0-N2268	VB [BT] S
2.0 HDi 135	05/04-	RHR (DW10BTED4)	1997			0-N1327	VB [BT]
2.0 HDi 135	05/04-	RHR (DW10BTED4)	1997	Orga.→11193		0-N2037	VB [BT] S
2.0 HDi 135	05/04-	RHR (DW10BTED4)	1997	Orga.11194→		0-N2046	VB [BT] S
2.2 HDi, 2.2 HDi 170	05/06-	4HP (DW12BTED4), 4HT (DW12BTED4)	2179			0-N2042	VB [BT] S
2.2, 2.2 16V	05/04-	3FY (EW12J4), 3FZ (EW12J4)	2230	Orga.→10247		0-N1391	VB [BT] S
2.2, 2.2 16V	05/04-	3FY (EW12J4), 3FZ (EW12J4)	2230	Orga.→10247		0-N1416	VB [DG]
2.2, 2.2 16V	05/04-	3FY (EW12J4), 3FZ (EW12J4)	2230	Orga.10248→		0-N1840	VB [BT] S
2.2, 2.2 16V	05/04-	3FY (EW12J4), 3FZ (EW12J4)	2230	Rippenanzahl: 6; Orga.→10247; ✖		0-N2094	VB [DG]
3.0	05/04-	XFV (ES9A)	2946	Orga.→10055		0-N1449	VB [TE]
3.0	05/04-	XFV (ES9A)	2946			0-N1473	VB [BT] S
3.0	05/04-	XFV (ES9A)	2946			0-N1757	VB [VD]
408							
1.6 HDi	11/10-	9HL (DV6C)	1560			0-N2224	TB [TE]
1.6 HDi	11/10-	9HL (DV6C)	1560			0-N2382	TB [DG]
2.0, 2.0 16V	02/10-	RFJ (EW10A)	1997			0-N1343	TB [TE]
1.6 16V, 1.6 Turbo	02/10-		1598	für OE: 11 28 7 598 832, 11 28 7 598 833		0-N2237	VB [DG]
505 (551A)							
2.0 GTi, 2.0 Ti,STi	08/79-08/91	829 (ZEJ)	1995	19x118; :53473→		SK-1091	BTK
2.2	05/81-08/91	851 (ZDJ)	2165	19x118; :30139→		SK-1092	BTK
2.2	05/81-08/91	851 (ZDJ)	2165	19x118; :32028→		SK-1092	BTK
2.2, 2.2 GTi	08/83-12/93	851B (ZDJL), 851X (ZDJL)	2165	19x118; :30139, 32028→		SK-1092	BTK
2.0 Ti,STi	08/79-10/86	829 (ZEJ)	1995			0-N882	TB [TE]
2.2, 2.2 GTi	05/81-12/93	851 (ZDJ), 851B (ZDJL), 851X (ZDJL)	2165			0-N882	TB [TE]
505 Break (551D)							
2.2, 2.2 GTi	09/85-12/93	851B (ZDJL), 851X (ZDJL)	2165	19x118; :30139→		SK-1092	BTK
2.2, 2.2 GTi	09/85-12/93	851B (ZDJL), 851X (ZDJL)	2165	19x118; :32028→		SK-1092	BTK
2.2, 2.2 GTi	09/85-12/93	851B (ZDJL), 851X (ZDJL)	2165			0-N882	TB [TE]
508							
1.6 HDi	11/10-	9HD (DV6CTED), 9HR (DV6C)	1560	25x141		SK-1728	BTK
1.6 HDi	11/10-	9HD (DV6CTED), 9HR (DV6C)	1560	25x141		SK-1728AQ1	BTKW
2.0 HDi	11/10-	RHF (DW10BTED4), RHR (DW10BTED4)	1997	25.4x116		SK-1594	BTK



OPTIMAL®

PEUGEOT



CM³



Art. Nr.



ohne Halter

508							
2.0 HDi	11/10-	DW10BTED4	1997	25.4x116	SK-1594AQ1	BTKW	
2.0 HDi	11/10-	RHF (DW10BTED4)	1997	25.4x116	SK-1594AQ1	BTKW	
2.0 HDi	11/10-	DW10CTED4	1997	25x116	SK-1714AQ1	BTKW	
2.0 HDi, 2.0 HDi AWC, 2.0 HDi RXH Hybrid4	11/10-	RHC (DW10CTED4), RHH (DW10CTED4), RHR (DW10BTED4)	1997	25x116	SK-1714	BTK	
2.0 HDi, 2.0 HDi AWC, 2.0 HDi RXH Hybrid4	11/10-	RHC (DW10CTED4), RHH (DW10CTED4)	1997	25x116	SK-1714AQ1	BTKW	
2.2 HDi	11/10-	4HL (DW12C)	2179	25.4x118	SK-1692	BTK	
2.2 HDi	11/10-	4HL (DW12C)	2179	25.4x118	SK-1692AQ1	BTKW	
1.6 HDi	11/10-	9HD (DV6CTED), 9HR (DV6C)	1560		0-N2224	TB [TE]	
1.6 HDi	11/10-	9HD (DV6CTED), 9HR (DV6C)	1560		0-N2382	TB [DG]	
2.0 HDi	11/10-	RHF (DW10BTED4), RHH (DW10CTED4), RHR (DW10BTED4)	1997		0-N1334	TB [DG]	
2.0 HDi	11/10-	RHF (DW10BTED4), RHH (DW10CTED4)	1997		0-N2063	TB [TE]	
2.2 HDi	11/10-	4HL (DW12C)	2179		0-N1334	TB [DG]	
2.2 HDi	11/10-	4HL (DW12C)	2179		0-N2018	TB [BT]	
1.6 HDi	11/10-	9HD (DV6CTED), 9HR (DV6C)	1560	für Fahrzeuge ohne Start-Stopp-Funktion	0-N1502	VB [BT]	S
1.6 HDi	11/10-	9HR (DV6C)	1560	Rippenanzahl: 6; für Fahrzeuge mit Start-Stopp-Funktion, ⚡	0-N2355	VB [DG]	
1.6 HDi	11/10-	9HR (DV6C)	1560	für Fahrzeuge mit Start-Stopp-Funktion	0-N2392	VB [BT]	S
1.6 THP, 1.6 VTi	11/10-	5FH (EP6C), 5FN (EP6CDT), 5FS (EP6C), EP6CDT	1598	⚡	0-N2055	VB [BT]	S
1.6, 1.6 THP, 1.6 VTi	11/10-	5FH (EP6C), 5FN (EP6CDT), 5FS (EP6C), 5GZ (EP6FDT), EP6CDT	1598	für OE: 11 28 7 598 832, 11 28 7 598 833	0-N2237	VB [DG]	
2.0 HDi	11/10-	RHF (DW10BTED4)	1997		0-N1327	VB [BT]	
2.0 HDi	11/10-	RHF (DW10BTED4)	1997		0-N2037	VB [BT]	S
2.0 HDi RXH Hybrid4	11/10-	DW10CTED4	1997		0-N2268	VB [BT]	S
2.0 HDi, 2.0 HDi AWC	11/10-	RHC (DW10CTED4), RHH (DW10CTED4)	1997		0-N2268	VB [BT]	S
2.2 HDi	11/10-	4HL (DW12C)	2179		0-N2042	VB [BT]	S
508 SW							
1.6 HDi	11/10-	9HD (DV6CTED), 9HR (DV6C)	1560	25x141	SK-1728	BTK	
1.6 HDi	11/10-	9HD (DV6CTED), 9HR (DV6C)	1560	25x141	SK-1728AQ1	BTKW	
2.0 HDi	11/10-	RHF (DW10BTED4), RHR (DW10BTED4)	1997	25.4x116	SK-1594	BTK	
2.0 HDi	11/10-	DW10BTED4	1997	25.4x116	SK-1594AQ1	BTKW	
2.0 HDi	11/10-	RHF (DW10BTED4)	1997	25.4x116	SK-1594AQ1	BTKW	
2.0 HDi	11/10-	DW10CTED4	1997	25x116	SK-1714AQ1	BTKW	
2.0 HDi, 2.0 HDi RXH Hybrid4	11/10-	RHC (DW10CTED4), RHH (DW10CTED4), RHR (DW10BTED4)	1997	25x116	SK-1714	BTK	
2.0 HDi, 2.0 HDi RXH Hybrid4	11/10-	RHC (DW10CTED4), RHH (DW10CTED4)	1997	25x116	SK-1714AQ1	BTKW	
2.2 HDi	11/10-	4HL (DW12C)	2179	25.4x118	SK-1692	BTK	
2.2 HDi	11/10-	4HL (DW12C)	2179	25.4x118	SK-1692AQ1	BTKW	
1.6 HDi	11/10-	9HD (DV6CTED), 9HR (DV6C)	1560		0-N2224	TB [TE]	
1.6 HDi	11/10-	9HD (DV6CTED), 9HR (DV6C)	1560		0-N2382	TB [DG]	
2.0 HDi, 2.0 HDi RXH Hybrid4	11/10-	RHC (DW10CTED4), RHF (DW10BTED4), RHH (DW10CTED4), RHR (DW10BTED4)	1997		0-N1334	TB [DG]	
2.0 HDi, 2.0 HDi RXH Hybrid4	11/10-	RHC (DW10CTED4), RHF (DW10BTED4), RHH (DW10CTED4)	1997		0-N2063	TB [TE]	
2.2 HDi	11/10-	4HL (DW12C)	2179		0-N1334	TB [DG]	
2.2 HDi	11/10-	4HL (DW12C)	2179		0-N2018	TB [BT]	
1.6 HDi	11/10-	9HD (DV6CTED), 9HR (DV6C)	1560	für Fahrzeuge ohne Start-Stopp-Funktion	0-N1502	VB [BT]	S
1.6 HDi	11/10-	9HR (DV6C)	1560	Rippenanzahl: 6; für Fahrzeuge mit Start-Stopp-Funktion, ⚡	0-N2355	VB [DG]	
1.6 HDi	11/10-	9HR (DV6C)	1560	für Fahrzeuge mit Start-Stopp-Funktion	0-N2392	VB [BT]	S
1.6 THP, 1.6 VTi	11/10-	5FH (EP6C), 5FS (EP6C), 5FX (EP6DT), EP6CDT	1598	⚡	0-N2055	VB [BT]	S
1.6 THP, 1.6 VTi	11/10-	5FH (EP6C), 5FS (EP6C), 5FX (EP6DT), EP6CDT	1598	für OE: 11 28 7 598 832, 11 28 7 598 833	0-N2237	VB [DG]	
2.0 HDi	11/10-	RHF (DW10BTED4)	1997		0-N1327	VB [BT]	
2.0 HDi	11/10-	RHF (DW10BTED4)	1997		0-N2037	VB [BT]	S
2.0 HDi, 2.0 HDi RXH Hybrid4	11/10-	RHC (DW10CTED4), RHH (DW10CTED4)	1997		0-N2268	VB [BT]	S
2.2 HDi	11/10-	4HL (DW12C)	2179		0-N2042	VB [BT]	S
605 (6B)							
2.0	06/89-09/99	R5A (XU102C), RFZ (XU10J2Z)	1998	17x114; 01/1993 →	SK-1019	BTK	
2.0	06/89-09/99	R5A (XU102C), RFZ (XU10J2Z)	1998	17x114; → 01/1993	SK-1159	BTK	
2.0 16V	07/94-09/99	RFV (XU10J4R)	1998	25x136	SK-1082	BTK	
2.0 16V	07/94-09/99	RFV (XU10J4R)	1998	25x136	SK-1082AQ2	BTKW	
2.0 Turbo	07/91-09/99	RGX (XU10J2TE), RGY (XU10J2TE)	1998	17x114	SK-1019	BTK	
2.1 D	06/89-07/95	P9A (XUD11A)	2138	25.4x144; mit Zubehör	SK-1016	BTK	



CM³



Art. Nr.



605 (6B)							
2.1 TD 12V, 2.1 Turbo Diesel	06/89-09/99	P8C (XUD11BTE), PHZ (XUD11ATE)	2088	25.4x149		SK-1017	BTK
2.1 TD 12V, 2.1 Turbo Diesel	06/89-09/99	P8C (XUD11BTE), PHZ (XUD11ATE)	2088	25x149		SK-1017AQ1	BTKW
2.5 Turbo Diesel	07/94-09/99	THY (DK5ATE)	2446	28x141		SK-1034	BTK
2.5 Turbo Diesel	07/94-09/99	THY (DK5ATE)	2446	28x141; 19x106		SK-1683	BTK
2.0	06/89-09/99	R5A (XU102C), RFZ (XU10J2Z)	1998		07/1993 →	0-N811	TB [TE]
2.0	06/89-09/99	RFZ (XU10J2Z)	1998		→ 06/1993	0-N870	TB [TE]
2.0 16V	07/94-09/99	RFV (XU10J4R)	1998			0-N862	TB [DG]
2.0 16V	07/94-09/99	RFV (XU10J4R)	1998			0-N943	TB [TE]
2.0 Turbo	07/91-09/99	RGX (XU10J2TE), RGY (XU10J2TE)	1998			0-N811	TB [TE]
2.1 D	06/89-07/95	P9A (XUD11A)	2138			0-N862	TB [DG]
2.1 D	06/89-07/95	P9A (XUD11A)	2138			0-N871	TB [TE]
2.1 TD 12V, 2.1 Turbo Diesel	06/89-09/99	P8C (XUD11BTE), PHZ (XUD11ATE)	2088			0-N862	TB [DG]
2.1 TD 12V, 2.1 Turbo Diesel	06/89-09/99	P8C (XUD11BTE), PHZ (XUD11ATE)	2088			0-N871	TB [TE]
2.5 Turbo Diesel	07/94-09/99	THY (DK5ATE)	2446			0-N1222	TB [TE]
2.5 Turbo Diesel	07/94-09/99	THY (DK5ATE)	2446			0-N944	TB [TE]
2.5 Turbo Diesel	07/94-09/99	THY (DK5ATE)	2446			0-N945	TB [DG]
3.0 V6	04/97-09/99	XFZ (ES9J4)	2946			0-N1056	TB [TE]
3.0 V6	04/97-09/99	XFZ (ES9J4)	2946			0-N170	TB [DG]
3.0 V6	04/97-09/99	XFZ (ES9J4)	2946			0-N171	TB [DG]
2.0	06/89-09/99	R5A (XU102C), RFZ (XU10J2Z)	1998	06/1995 →; ☼		0-N1713	VB [BT]
2.0	06/89-09/99	R5A (XU102C), RFZ (XU10J2Z)	1998	06/1995 →; ☼		0-N1722	VB [DG]
2.0	06/89-09/99	R5A (XU102C), RFZ (XU10J2Z)	1998	☼		0-N2153	VB [DG]
2.0 16V	07/94-09/99	RFV (XU10J4R)	1998	→ 06/1995		0-N124	VB [TE]
2.0 16V	07/94-09/99	RFV (XU10J4R)	1998	→ 06/1995; ☼		0-N1405	VB [DG]
2.0 16V	07/94-09/99	RFV (XU10J4R)	1998	07/1995 →; ☼		0-N1463S	VB [DG]
2.0 16V	07/94-09/99	RFV (XU10J4R)	1998	07/1995 →; ☼		0-N1713	VB [BT]
2.0 16V	07/94-09/99	RFV (XU10J4R)	1998	07/1995 →; ☼		0-N1722	VB [DG]
2.0 16V, 2.0 Turbo	07/91-09/99	RFV (XU10J4R), RGX (XU10J2TE), RGY (XU10J2TE)	1998	☼		0-N1484	VB [BT] S
2.0 Turbo	07/91-09/99	RGX (XU10J2TE), RGY (XU10J2TE)	1998	☼		0-N1463S	VB [DG]
2.0 Turbo	07/91-09/99	RGX (XU10J2TE), RGY (XU10J2TE)	1998	☼		0-N1713	VB [BT]
2.0 Turbo	07/91-09/99	RGX (XU10J2TE), RGY (XU10J2TE)	1998	☼		0-N1722	VB [DG]
2.0 Turbo	07/91-09/99	RGX (XU10J2TE), RGY (XU10J2TE)	1998	→ 06/1995; ☼		0-N2153	VB [DG]
2.1 D	06/89-07/95	P9A (XUD11A)	2138	06/1995 →		0-N1320	VB [TE]
2.1 D	06/89-07/95	P9A (XUD11A)	2138	06/1995 →; ☼		0-N1472	VB [BT] S
2.1 D	06/89-07/95	P9A (XUD11A)	2138	06/1995 →; ☼		0-N1747	VB [VD]
2.1 D	06/89-07/95	P9A (XUD11A)	2138	→ 06/1995; ☼		0-N2153	VB [DG]
2.1 TD 12V, 2.1 Turbo Diesel	06/89-09/99	P8C (XUD11BTE), PHZ (XUD11ATE)	2088	06/1995 →		0-N1320	VB [TE]
2.1 TD 12V, 2.1 Turbo Diesel	06/89-09/99	P8C (XUD11BTE), PHZ (XUD11ATE)	2088	06/1995 →; ☼		0-N1472	VB [BT] S
2.1 TD 12V, 2.1 Turbo Diesel	06/89-09/99	P8C (XUD11BTE), PHZ (XUD11ATE)	2088	06/1995 →; ☼		0-N1747	VB [VD]
2.1 TD 12V, 2.1 Turbo Diesel	06/89-09/99	P8C (XUD11BTE), PHZ (XUD11ATE)	2088	→ 06/1995; ☼		0-N2153	VB [DG]
2.5 Turbo Diesel	07/94-09/99	THY (DK5ATE)	2446			0-N1959	VB [VD]
2.5 Turbo Diesel	07/94-09/99	THY (DK5ATE)	2446			0-N2154	VB [TE]
2.5 Turbo Diesel	07/94-09/99	THY (DK5ATE)	2446	☼		0-N2172	VB [TE] S
2.5 Turbo Diesel	07/94-09/99	THY (DK5ATE)	2446			0-N2173	VB [DG]
3.0	08/89-06/94	UFZ	2963	Rippenanzahl: 5; ☼		0-N2348	VB [DG]
3.0	08/89-06/94	UKZ	2963	Rippenanzahl: 5; ☼		0-N2348	VB [DG]
3.0 V6	04/97-09/99	XFZ (ES9J4)	2946			0-N1449	VB [TE]
3.0 V6	04/97-09/99	XFZ (ES9J4)	2946			0-N1757	VB [VD]
3.0 V6	04/97-09/99	XFZ (ES9J4)	2946			0-N2175	VB [BT]
3.0, 3.0 SV 24	08/89-09/99	SFZ (ZPJ/Z), UFZ (ZPJ), SKZ (ZPJ4/Z), UKZ (ZPJ4/Z), UFZ (ZPJ), UKZ (ZPJ4/Z)	2963	☼		0-N1973	VB [DG]
3.0, 3.0 SV 24	08/89-09/99	UFZ (ZPJ), UKZ (ZPJ4/Z)	2963	Rippenanzahl: 5; ☼		0-N2348	VB [DG]
607 (9D, 9U)							
2.0	02/00-	RFN (EW10J4)	1997	25.4x153		SK-1482	BTK
2.0	02/00-	RFN (EW10J4)	1997	25.4x153		SK-1482AQ1	BTKW
2.0 HDI	05/00-	RHZ (DW10ATED)	1997	25x141; mit Zubehör		SK-1085	BTK
2.0 HDI	05/00-07/04	RHS (DW10ATED), RHZ (DW10ATED)	1997	25.4x141; mit Zubehör		SK-1085AQ1	BTKW
2.0 HDI	03/01-07/04	RHS (DW10ATED)	1997	25x141; 08/2002 →; mit Zubehör		SK-1085	BTK
2.0 HDI	09/05-	RHR (DW10BTED4)	1997	25.4x116		SK-1594	BTK
2.0 HDI	09/05-	RHR (DW10BTED4)	1997	25.4x116		SK-1594AQ1	BTKW
2.2 16V	02/00-	3FY (EW12J4), 3FZ (EW12J4)	2230	25.4x153		SK-1482	BTK
2.2 16V	02/00-	3FY (EW12J4), 3FZ (EW12J4)	2230	25.4x153		SK-1482AQ1	BTKW
2.2 HDI	02/00-	4HX (DW12TED4/FAP)	2179	25.4x146; → 04/2004; Orga.→10010		SK-1394	BTK
2.2 HDI	02/00-	4HX (DW12TED4/FAP)	2179	25.4x146; → 04/2004; Orga.→10010		SK-1394AQ1	BTKW



OPTIMAL®

PEUGEOT



CM³



Art. Nr.



ohne Halter

607 (9D, 9U)

2.2 HDI	02/00-	4HX (DW12TED4/FAP)	2179	25.4x146; 04/2004 →; Orga.10011→; Baumuster: 4HX	SK-1614	BTK	
2.2 HDI	02/00-	4HX (DW12TED4/FAP)	2179	25.4x146; 04/2004 →; Orga.10011→	SK-1614AQ1	BTKW	
2.2 HDi	05/06-	4HT (DW12BTED4)	2179	25.4x118; → 01/2007	SK-1588	BTK	
2.2 HDi	05/06-	4HT (DW12BTED4)	2179	25.4x118	SK-1692	BTK	
2.2 HDi	05/06-	4HT (DW12BTED4)	2179	25.4x118	SK-1692AQ1	BTKW	
2.7 HDi 24V	12/04-	DT17TED4	2721	29x195; 20x85	SK-1675	BTK	
2.7 HDi 24V	12/04-	DT17TED4	2721	29x195	SK-1742	BTK	
3.0 V6 24V	02/00-	XFX (ES9J4S)	2946	32x259	SK-1483	BTK	
3.0 V6 24V	02/00-	XFX (ES9J4S)	2946	32x259; 04/2000 →	SK-1483AQ1	BTKW	
3.0 V6 24V	03/04-	XFV (ES9A), XFX (ES9J4S)	2946	32x259; 08/2004 →	SK-1483	BTK	
3.0 V6 24V	03/04-	XFV (ES9A), XFX (ES9J4S)	2946	32x259	SK-1483AQ1	BTKW	
2.0	02/00-	RFN (EW10J4)	1997		0-N1057	TB [TE]	
2.0	02/00-	RFN (EW10J4)	1997		0-N1065	TB [DG]	
2.0 HDi	05/00-07/04	RHS (DW10ATED), RHZ (DW10ATED)	1997		0-N118P	TB [TE]	
2.0 HDi	05/00-07/04	RHS (DW10ATED), RHZ (DW10ATED)	1997		0-N1381	TB [DG]	
2.0 HDI	09/05-	RHR (DW10BTED4)	1997		0-N1334	TB [DG]	
2.2 16V	02/00-	3FY (EW12J4), 3FZ (EW12J4)	2230		0-N1057	TB [TE]	
2.2 16V	02/00-	3FY (EW12J4), 3FZ (EW12J4)	2230		0-N1065	TB [DG]	
2.2 HDI	02/00-	4HX (DW12TED4/FAP)	2179	Orga.→10010	0-N118P	TB [TE]	
2.2 HDI	02/00-	4HX (DW12TED4/FAP)	2179	Orga.→10010	0-N119P	TB [DG]	
2.2 HDI	02/00-	4HX (DW12TED4/FAP)	2179	Orga.10011→	0-N1357	TB [TE]	
2.2 HDI	02/00-	4HX (DW12TED4/FAP)	2179	Orga.10011→	0-N1358	TB [DG]	
2.2 HDi	05/06-	4HT (DW12BTED4)	2179		0-N1334	TB [DG]	
2.2 HDi	05/06-	4HT (DW12BTED4)	2179		0-N2018	TB [BT]	
2.7 HDi 24V	12/04-	DT17TED4	2721		0-N1613	TB [TE]	
2.7 HDi 24V	12/04-	DT17TED4	2721		0-N1614	TB [TE]	
2.7 HDi 24V	12/04-	DT17TED4	2721		0-N1615	TB [DG]	
3.0 V6 24V	02/00-	XFV (ES9A), XFX (ES9J4S), XFX (ES9J4S)	2946		0-N1056	TB [TE]	
3.0 V6 24V	02/00-	XFV (ES9A), XFX (ES9J4S), XFX (ES9J4S)	2946		0-N170	TB [DG]	
3.0 V6 24V	02/00-	XFV (ES9A), XFX (ES9J4S), XFX (ES9J4S)	2946		0-N171	TB [DG]	
2.0	02/00-	RFN (EW10J4)	1997		0-N1391	VB [BT]	S
2.0	02/00-	RFN (EW10J4)	1997		0-N1416	VB [DG]	
2.0 HDi	05/00-07/04	RHS (DW10ATED), RHZ (DW10ATED)	1997		0-N1413	VB [DG]	
2.0 HDi	05/00-07/04	RHS (DW10ATED), RHZ (DW10ATED)	1997		0-N1493	VB [BT]	S
2.0 HDI	09/05-	RHR (DW10BTED4)	1997		0-N1327	VB [BT]	
2.0 HDI	09/05-	RHR (DW10BTED4)	1997	Orga.→11073	0-N2037	VB [BT]	S
2.0 HDI	09/05-	RHR (DW10BTED4)	1997	Orga.11074→	0-N2046	VB [BT]	S
2.2 16V	02/00-	3FY (EW12J4), 3FZ (EW12J4)	2230		0-N1391	VB [BT]	S
2.2 16V	02/00-	3FY (EW12J4), 3FZ (EW12J4)	2230		0-N1416	VB [DG]	
2.2 16V	02/00-	3FZ (EW12J4)	2230		0-N2276	VB [DG]	
2.2 HDI	02/00-	4HX (DW12TED4/FAP)	2179		0-N1413	VB [DG]	
2.2 HDI	02/00-	4HX (DW12TED4/FAP)	2179		0-N1493	VB [BT]	S
2.2 HDi	05/06-	4HT (DW12BTED4)	2179		0-N2042	VB [BT]	S
3.0 V6 24V	02/00-	XFX (ES9J4S)	2946		0-N1449	VB [TE]	
3.0 V6 24V	02/00-	XFV (ES9A), XFX (ES9J4S), XFX (ES9J4S)	2946		0-N1473	VB [BT]	S
3.0 V6 24V	02/00-	XFV (ES9A), XFX (ES9J4S), XFX (ES9J4S)	2946		0-N1757	VB [VD]	
3.0 V6 24V	03/04-	XFV (ES9A), XFX (ES9J4S)	2946	Orga.→10919	0-N1449	VB [TE]	

806 (221)

1.8	07/95-08/02	LFW (XU7JP)	1761	17x114; 07/1996 →	SK-1019	BTK	
1.9 TD	07/95-08/02	DHX (XUD9TE)	1905	25.4x136; 10/1997 →	SK-1022	BTK	
1.9 TD	07/95-08/02	DHX (XUD9TE), DHY (XUD9TE)	1905	25.4x136; Orga.07390→	SK-1022AQ1	BTKW	
1.9 TD	07/95-08/02	DHX (XUD9TE), DHY (XUD9TE)	1905	25.4x136; Orga.→07389	SK-1022AQ2	BTKW	
1.9 TD	05/97-08/02	DHY (XUD9TE)	1905	25.4x136	SK-1022	BTK	
2.0 16V	05/98-09/00	RFV (XU10J4R)	1998	25x136	SK-1082	BTK	
2.0 16V	05/98-09/00	RFV (XU10J4R)	1998	25x136	SK-1082AQ2	BTKW	
2.0 16V	09/00-08/02	RFN (EW10J4)	1997	25.4x153	SK-1482	BTK	
2.0 16V	09/00-08/02	RFN (EW10J4)	1997	25.4x153	SK-1482AQ1	BTKW	
2.0 HDI	08/99-08/02	RHZ (DW10ATED)	1997	25x141; → 04/2000; Orga.→08560; mit Zubehör	SK-1085	BTK	
2.0 HDI	08/99-08/02	RHZ (DW10ATED)	1997	25.4x141; mit Zubehör	SK-1085AQ1	BTKW	
2.0 HDI	08/99-08/02	RHZ (DW10ATED)	1997	25.4x144	SK-1534	BTK	
2.0 HDI 16V	08/99-08/02	RHW (DW10ATED4)	1997	25.4x144; 02/2001 →	SK-1534	BTK	
2.0 HDI 16V	08/99-08/02	RHW (DW10ATED4)	1997	25.4x144; 02/2001 →	SK-1534AQ1	BTKW	
2.0, 2.0 Turbo	06/94-08/02	RFU (XU10J2), RGX (XU10J2TE)	1998	17x114	SK-1019	BTK	

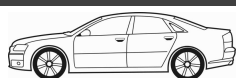

CM³



Art. Nr.



806 (221)							
2.1 td 12V	06/96-08/99	P8C (XUD11BTE)	2088	25.4x149	SK-1017	BTK	
2.1 td 12V	06/96-08/99	P8C (XUD11BTE)	2088	25x149	SK-1017AQ1	BTKW	
1.8	07/95-08/02	LFW (XU7JP)	1761		0-N811	TB [TE]	
1.9 TD	07/95-08/02	DHX (XUD9TE), DHY (XUD9TE)	1905		0-N900	TB [DG]	
1.9 TD	07/95-08/02	DHX (XUD9TE), DHY (XUD9TE)	1905		0-N901	TB [TE]	
2.0 16V	05/98-09/00	RFV (XU10J4R)	1998		0-N862	TB [DG]	
2.0 16V	05/98-09/00	RFV (XU10J4R)	1998		0-N943	TB [TE]	
2.0 16V	09/00-08/02	RFN (EW10J4)	1997		0-N1057	TB [TE]	
2.0 16V	09/00-08/02	RFN (EW10J4)	1997		0-N1065	TB [DG]	
2.0 HDI	08/99-08/02	RHZ (DW10ATED)	1997	Orga.→08560	0-N118P	TB [TE]	
2.0 HDI	08/99-08/02	RHZ (DW10ATED)	1997	Orga.→08560	0-N119P	TB [DG]	
2.0 HDI	08/99-08/02	RHZ (DW10ATED)	1997	Orga.08561→	0-N1381	TB [DG]	
2.0 HDI 16V	08/99-08/02	RHW (DW10ATED4)	1997		0-N118P	TB [TE]	
2.0 HDI 16V	08/99-08/02	RHW (DW10ATED4)	1997		0-N119P	TB [DG]	
2.0, 2.0 Turbo	06/94-08/02	RFU (XU10J2), RGX (XU10J2TE)	1998		0-N811	TB [TE]	
2.1 td 12V	06/96-08/99	P8C (XUD11BTE)	2088		0-N862	TB [DG]	
2.1 td 12V	06/96-08/99	P8C (XUD11BTE)	2088		0-N871	TB [TE]	
1.8	07/95-08/02	LFW (XU7JP)	1761		0-N124	VB [TE]	
1.8	07/95-08/02	LFW (XU7JP)	1761	☼	0-N1405	VB [DG]	
1.8	07/95-08/02	LFW (XU7JP)	1761	☼	0-N1484	VB [BT]	S
1.9 TD	07/95-08/02	DHX (XUD9TE), DHY (XUD9TE)	1905		0-N1320	VB [TE]	
1.9 TD	07/95-08/02	DHX (XUD9TE), DHY (XUD9TE)	1905		0-N1472	VB [BT]	S
1.9 TD	07/95-08/02	DHX (XUD9TE), DHY (XUD9TE)	1905		0-N1747	VB [VD]	
1.9 TD	07/95-08/02	DHX (XUD9TE), DHY (XUD9TE)	1905		0-N931	VB [TE]	
2.0	06/94-08/02	RFU (XU10J2)	1998		0-N124	VB [TE]	
2.0	06/94-08/02	RFU (XU10J2)	1998	☼	0-N1405	VB [DG]	
2.0 16V	05/98-09/00	RFV (XU10J4R)	1998	☼	0-N1463S	VB [DG]	
2.0 16V	05/98-09/00	RFV (XU10J4R)	1998	☼	0-N1713	VB [BT]	
2.0 16V	05/98-09/00	RFV (XU10J4R)	1998	☼	0-N1722	VB [DG]	
2.0 16V	09/00-08/02	RFN (EW10J4)	1997		0-N1391	VB [BT]	S
2.0 16V	09/00-08/02	RFN (EW10J4)	1997		0-N1416	VB [DG]	
2.0 HDI	08/99-08/02	RHZ (DW10ATED)	1997		0-N151	VB [DG]	
2.0 HDI 16V	08/99-08/02	RHW (DW10ATED4)	1997	☼	0-N151	VB [DG]	
2.0 HDI, 2.0 HDI 16V	08/99-08/02	RHW (DW10ATED4), RHZ (DW10ATED)	1997		0-N1320	VB [TE]	
2.0 HDI, 2.0 HDI 16V	08/99-08/02	RHW (DW10ATED4), RHZ (DW10ATED)	1997		0-N1493	VB [BT]	S
2.0 HDI, 2.0 HDI 16V	08/99-08/02	RHW (DW10ATED4), RHZ (DW10ATED)	1997	☼	0-N1748	VB [BT]	
2.0 Turbo	06/94-08/02	RGX (XU10J2TE)	1998	Orga.→7389	0-N124	VB [TE]	
2.0 Turbo	06/94-08/02	RGX (XU10J2TE)	1998	Orga.→7389; ☼	0-N1405	VB [DG]	
2.0 Turbo	06/94-08/02	RGX (XU10J2TE)	1998	Orga.7390→; ☼	0-N1463S	VB [DG]	
2.0 Turbo	06/94-08/02	RGX (XU10J2TE)	1998	Orga.7390→; ☼	0-N1713	VB [BT]	
2.0 Turbo	06/94-08/02	RGX (XU10J2TE)	1998	Orga.7390→; ☼	0-N1722	VB [DG]	
2.0, 2.0 16V, 2.0 Turbo	06/94-08/02	RFU (XU10J2), RFV (XU10J4R), RGX (XU10J2TE)	1998	☼	0-N1484	VB [BT]	S
2.1 td 12V	06/96-08/99	P8C (XUD11BTE)	2088		0-N1320	VB [TE]	
2.1 td 12V	06/96-08/99	P8C (XUD11BTE)	2088		0-N1472	VB [BT]	S
2.1 td 12V	06/96-08/99	P8C (XUD11BTE)	2088		0-N1747	VB [VD]	
2.1 td 12V	06/96-08/99	P8C (XUD11BTE)	2088		0-N931	VB [TE]	

807 (E)							
2.0	06/02-	RFN (EW10J4)	1997	25.4x153	SK-1482	BTK	
2.0	06/02-	RFN (EW10J4)	1997	25.4x153	SK-1482AQ1	BTKW	
2.0 16V	09/05-	RFJ (EW10A)	1997	25x153	SK-1600	BTK	
2.0 16V	09/05-	RFJ (EW10A)	1997	25x153	SK-1600AQ1	BTKW	
2.0 HDi	06/02-05/06	RHM (DW10ATED4), RHT (DW10ATED4), RHW (DW10ATED4), RHW (DW10ATED4)	1997	25.4x144	SK-1534	BTK	
2.0 HDi	06/02-	RHM (DW10ATED4), RHT (DW10ATED4), RHW (DW10ATED4)	1997	25.4x144; 08/2002 →	SK-1534AQ1	BTKW	
2.0 HDi	04/04-05/06	RHW (DW10ATED4)	1997	25.4x144	SK-1534AQ1	BTKW	
2.0 HDi	02/06-	RHK (DW10UTED4), RHR (DW10BTED4)	1997	25.4x116	SK-1594	BTK	
2.0 HDi	02/06-	RHK (DW10UTED4)	1997	25.4x116	SK-1594AQ1	BTKW	
2.0 HDi	06/06-	DW10BTED4	1997	25.4x116	SK-1594AQ1	BTKW	
2.0 HDi	06/06-	RHR (DW10BTED4)	1997	25x116	SK-1714	BTK	
2.0 HDi	06/06-	RHH (DW10CTED4), RHR (DW10BTED4)	1997	25x116	SK-1714AQ1	BTKW	
2.0 HDi	06/09-	RHH (DW10CTED4)	1997	25x116; 05/2010 →	SK-1714	BTK	
2.2	06/02-	3FZ (EW12J4)	2230	25.4x153	SK-1482	BTK	
2.2	06/02-	3FZ (EW12J4)	2230	25.4x153	SK-1482AQ1	BTKW	



OPTIMAL®

PEUGEOT



CM³



Art. Nr.



ohne Halter

807 (E)

2.2 HDi	06/02-	4HW (DW12BTED4), 4HX (DW12TED4/FAP), 4HZ (DW12TED4)	2179	25.4x146; → 04/2004; Orga.→10010	SK-1394	BTK	
2.2 HDi	06/02-	4HW (DW12BTED4), 4HX (DW12TED4/FAP), 4HZ (DW12TED4)	2179	25.4x146; → 04/2004; Orga.→10010	SK-1394AQ1	BTKW	
2.2 HDi	06/02-	4HW (DW12BTED4), 4HX (DW12TED4/FAP)	2179	25.4x146; 04/2004 →; Orga.10011→	SK-1614	BTK	
2.2 HDi	06/02-	4HW (DW12BTED4), 4HX (DW12TED4/FAP)	2179	25.4x146; 04/2004 →; Orga.10011→	SK-1614AQ1	BTKW	
2.2 HDi	04/04-	4HZ (DW12TED4)	2179	25.4x146; Orga.10011→	SK-1614AQ1	BTKW	
2.2 HDi	06/06-	4HT (DW12BTED4)	2179	25.4x118	SK-1692	BTK	
2.2 HDi	06/06-	4HT (DW12BTED4)	2179	25.4x118	SK-1692AQ1	BTKW	
3.0 V6	06/02-	XFX (ES9J4S)	2946	32x259	SK-1483	BTK	
3.0 V6	06/02-	XFX (ES9J4S)	2946	32x259	SK-1483AQ1	BTKW	
2.0	06/02-	RFN (EW10J4)	1997		0-N1057	TB [TE]	
2.0 16V	09/05-	RFJ (EW10A)	1997		0-N1343	TB [TE]	
2.0 HDi	06/02-05/06	RHM (DW10ATED4), RHT (DW10ATED4), RHW (DW10ATED4), RHW (DW10ATED4)	1997		0-N118P	TB [TE]	
2.0 HDi	06/02-05/06	RHM (DW10ATED4), RHT (DW10ATED4), RHW (DW10ATED4), RHW (DW10ATED4)	1997		0-N119P	TB [DG]	
2.0 HDi	02/06-	RHH (DW10CTED4), RHK (DW10UTED4), RHR (DW10BTED4)	1997		0-N1334	TB [DG]	
2.0 HDi	06/09-	RHH (DW10CTED4)	1997		0-N2063	TB [TE]	
2.0, 2.0 16V	06/02-	RFJ (EW10A), RFN (EW10J4)	1997		0-N1065	TB [DG]	
2.2	06/02-	3FZ (EW12J4)	2230		0-N1057	TB [TE]	
2.2	06/02-	3FZ (EW12J4)	2230		0-N1065	TB [DG]	
2.2 HDi	06/02-	4HW (DW12BTED4), 4HX (DW12TED4/FAP)	2179	Orga.→10010	0-N118P	TB [TE]	
2.2 HDi	06/02-	4HW (DW12BTED4), 4HX (DW12TED4/FAP)	2179	Orga.→10010	0-N119P	TB [DG]	
2.2 HDi	06/02-	4HW (DW12BTED4), 4HX (DW12TED4/FAP)	2179	Orga.10011→	0-N1357	TB [TE]	
2.2 HDi	06/02-	4HW (DW12BTED4), 4HX (DW12TED4/FAP)	2179	Orga.10011→	0-N1358	TB [DG]	
2.2 HDi	06/06-	4HT (DW12BTED4)	2179		0-N1334	TB [DG]	
2.2 HDi	06/06-	4HT (DW12BTED4)	2179		0-N2018	TB [BT]	
3.0 V6	06/02-	XFX (ES9J4S)	2946		0-N1056	TB [TE]	
3.0 V6	06/02-	XFX (ES9J4S)	2946		0-N170	TB [DG]	
3.0 V6	06/02-	XFX (ES9J4S)	2946		0-N171	TB [DG]	
2.0	06/02-	RFN (EW10J4)	1997		0-N1391	VB [BT]	S
2.0	06/02-	RFN (EW10J4)	1997	Orga.→10247	0-N1416	VB [DG]	
2.0	06/02-	RFN (EW10J4)	1997	Orga.10248→	0-N2276	VB [DG]	
2.0 16V	09/05-	RFJ (EW10A)	1997		0-N1840	VB [BT]	S
2.0 HDi	06/02-05/06	RHM (DW10ATED4), RHT (DW10ATED4), RHW (DW10ATED4), RHW (DW10ATED4)	1997		0-N1320	VB [TE]	
2.0 HDi	06/02-	DW10UTED4	1997		0-N1327	VB [BT]	
2.0 HDi	06/02-05/06	RHM (DW10ATED4), RHT (DW10ATED4), RHW (DW10ATED4), RHW (DW10ATED4)	1997		0-N1493	VB [BT]	S
2.0 HDi	06/02-	DW10UTED4	1997	06/2006 →11073	0-N2037	VB [BT]	S
2.0 HDi	06/02-	DW10UTED4	1997	06/2006 →; Orga.11074→	0-N2046	VB [BT]	S
2.0 HDi	02/06-	RHK (DW10UTED4), RHR (DW10BTED4)	1997		0-N1327	VB [BT]	
2.0 HDi	02/06-	RHK (DW10UTED4), RHR (DW10BTED4)	1997	Orga.→11073	0-N2037	VB [BT]	S
2.0 HDi	02/06-	RHK (DW10UTED4)	1997	Orga.11074→	0-N2046	VB [BT]	S
2.0 HDi	06/09-	RHH (DW10CTED4)	1997		0-N2268	VB [BT]	S
2.2	06/02-	3FZ (EW12J4)	2230		0-N1391	VB [BT]	S
2.2	06/02-	3FZ (EW12J4)	2230	Orga.→10247	0-N1416	VB [DG]	
2.2	06/02-	3FZ (EW12J4)	2230	Orga.10248→	0-N2276	VB [DG]	
2.2 HDi	06/02-	4HW (DW12BTED4), 4HX (DW12TED4/FAP)	2179		0-N1413	VB [DG]	
2.2 HDi	06/02-	4HW (DW12BTED4), 4HX (DW12TED4/FAP)	2179		0-N1493	VB [BT]	S
2.2 HDi	06/06-	4HT (DW12BTED4)	2179		0-N2042	VB [BT]	S
3.0 V6	06/02-	XFX (ES9J4S)	2946		0-N1449	VB [TE]	
3.0 V6	06/02-	XFX (ES9J4S)	2946		0-N1473	VB [BT]	S
3.0 V6	06/02-	XFX (ES9J4S)	2946		0-N1757	VB [VD]	

1007 (KM_)

1.4	04/05-	KFV (TU3JP)	1360	17x104	SK-1354	BTK	
1.4	04/05-	KFV (TU3JP)	1360	17x104	SK-1354AQ1	BTKW	
1.4 16V	10/05-	KFU (ET3J4)	1360	25x135	SK-1598	BTK	
1.4 16V	10/05-	KFU (ET3J4)	1360	25x135	SK-1598AQ1	BTKW	

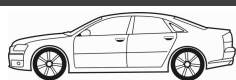

CM³



Art. Nr.



ohne Halter

1007 (KM_)							
1.4 HDi	04/05-	8HX (DV4TD), 8HZ (DV4TD)	1398	25.4x144	SK-1391	BTK	
1.4 HDi	04/05-	8HX (DV4TD), 8HZ (DV4TD)	1398	25.4x144	SK-1391AQ1	BTKW	
1.6 16V	04/05-	NFU (TU5JP4)	1587	25.4x134	SK-1615	BTK	
1.6 16V	04/05-	NFU (TU5JP4)	1587	25.4x134	SK-1615AQ1	BTKW	
1.6 HDi	06/07-	9HZ (DV6TED4)	1560	25x137	SK-1424	BTK	
1.6 HDi	06/07-	9HZ (DV6TED4)	1560	25x137	SK-1424AQ1	BTKW	
1.4	04/05-	KFV (TU3JP)	1360		0-N1277	TB [TE]	
1.4 16V	10/05-	KFU (ET3J4)	1360		0-N1338	TB [TE]	
1.4 16V	10/05-	KFU (ET3J4)	1360		0-N1456	TB [DG]	
1.4 HDi	04/05-	8HX (DV4TD), 8HZ (DV4TD)	1398		0-N1062	TB [TE]	
1.4 HDi	04/05-	8HX (DV4TD), 8HZ (DV4TD)	1398		0-N1066	TB [DG]	
1.6 16V	04/05-	NFU (TU5JP4)	1587		0-N1359	TB [TE]	
1.6 16V	04/05-	NFU (TU5JP4)	1587		0-N1360	TB [DG]	
1.6 HDi	06/07-	9HZ (DV6TED4)	1560		0-N1062	TB [TE]	
1.6 HDi	06/07-	9HZ (DV6TED4)	1560		0-N1066	TB [DG]	
1.4	04/05-	KFV (TU3JP)	1360		0-N1455	VB [TE]	
1.4 HDi	04/05-	8HX (DV4TD), 8HZ (DV4TD)	1398	→ 03/2007; Orga.→11073	0-N1339	VB [BT]	S
1.4 HDi	04/05-	8HX (DV4TD), 8HZ (DV4TD)	1398	Orga.→11073	0-N1418	VB [DG]	
1.4 HDi	04/05-	8HX (DV4TD), 8HZ (DV4TD)	1398	03/2007 →; Orga.11074→	0-N1502	VB [BT]	S
1.4, 1.4 16V	04/05-	KFU (ET3J4), KFV (TU3JP)	1360	✳	0-N1673	VB [BT]	S
1.6 16V	04/05-	NFU (TU5JP4)	1587	Orga.→10289	0-N1455	VB [TE]	
1.6 16V	04/05-	NFU (TU5JP4)	1587	Orga.10290→; ✳	0-N1673	VB [BT]	S
1.6 HDi	06/07-	9HZ (DV6TED4)	1560	Orga.11074→	0-N1502	VB [BT]	S
1.6 HDi	06/07-	9HZ (DV6TED4)	1560	Orga.→11073	0-N1807	VB [DG]	
1.6 HDi	06/07-	9HZ (DV6TED4)	1560	Orga.→11073; ✳	0-N1924	VB [DG]	
2008							
1.4 HDi	06/13-	8HR (DV4C)	1398	25.4x139	SK-1732	BTK	
1.4 HDi	06/13-	8HR (DV4C)	1398	25.4x139	SK-1732AQ1	BTKW	
1.6 HDi	03/13-	9HD (DV6CTED), 9HP (DV6DTED)	1560	25x141	SK-1728	BTK	
1.6 HDi	03/13-	9HD (DV6CTED), 9HP (DV6DTED)	1560	25x141	SK-1728AQ1	BTKW	
1.2 THP 110, 1.2 THP 130, 1.2 VTi	03/13-	HMZ (EB2F), HNY (EB2DTS), HNZ (EB2DT)	1199		0-N2424	TB [DG]	
1.4 HDi	06/13-	8HR (DV4C)	1398		0-N2224	TB [TE]	
1.4 HDi	06/13-	8HR (DV4C)	1398		0-N2382	TB [DG]	
1.6 BlueHdi 100, 1.6 BlueHdi 120, 1.6 HDi	03/13-	9HD (DV6CTED), 9HP (DV6DTED), BHY (DV6FD), BHZ (DV6FC)	1560		0-N2382	TB [DG]	
1.6 HDi	03/13-	9HD (DV6CTED), 9HP (DV6DTED)	1560		0-N2224	TB [TE]	
1.4 HDi	06/13-	8HR (DV4C)	1398		0-N1502	VB [BT]	S
1.4 HDi	06/13-	8HR (DV4C)	1398	Rippenanzahl: 6; für Fahrzeuge mit Start-Stopp-Funktion, ✳	0-N2355	VB [DG]	
1.4 HDi	06/13-	8HR (DV4C)	1398	für Fahrzeuge mit Start-Stopp-Funktion	0-N2392	VB [BT]	S
1.6 HDi	03/13-	9HP (DV6DTED)	1560	Rippenanzahl: 6; für Fahrzeuge mit Start-Stopp-Funktion, ✳	0-N2355	VB [DG]	
1.6 HDi	03/13-	9HP (DV6DTED)	1560	für Fahrzeuge mit Start-Stopp-Funktion	0-N2392	VB [BT]	S
1.6 VTi	03/13-	5FS (EP6C)	1598	für OE: 11 28 7 598 832, 11 28 7 598 833	0-N2237	VB [DG]	
3008							
1.6 HDi	06/09-	9HZ (DV6TED4)	1560	25x137	SK-1424	BTK	
1.6 HDi	06/09-	9HZ (DV6TED4)	1560	25x137	SK-1424AQ1	BTKW	
1.6 HDi	08/10-	9HD (DV6CTED), 9HR (DV6C)	1560	25x141	SK-1728	BTK	
1.6 HDi	08/10-	9HD (DV6CTED), 9HR (DV6C)	1560	25x141	SK-1728AQ1	BTKW	
2.0 HDi	06/09-	DW10CTED4	1997	25x116	SK-1714	BTK	
2.0 HDi, 2.0 Hybrid4	06/09-	RHC (DW10CTED4), RHH (DW10CTED4)	1997	25x116	SK-1714	BTK	
2.0 HDi, 2.0 Hybrid4	06/09-	AHX (DW10FD), RHE (DW10CTED4), RHC (DW10CTED4), RHH (DW10CTED4)	1997	25x116	SK-1714AQ1	BTKW	
1.6 BlueHdi 120, 1.6 HDi	08/10-	9HD (DV6CTED), 9HR (DV6C), BHZ (DV6FC)	1560		0-N2382	TB [DG]	
1.6 HDi	06/09-	9HZ (DV6TED4)	1560		0-N1062	TB [TE]	
1.6 HDi	06/09-	9HZ (DV6TED4)	1560		0-N1066	TB [DG]	
1.6 HDi	08/10-	9HD (DV6CTED), 9HR (DV6C)	1560		0-N2224	TB [TE]	
2.0 HDi, 2.0 Hybrid4	06/09-	AHX (DW10FD), RHE (DW10CTED4), RHC (DW10CTED4), RHH (DW10CTED4)	1997		0-N1334	TB [DG]	
2.0 HDi, 2.0 Hybrid4	06/09-	AHX (DW10FD), RHE (DW10CTED4), RHC (DW10CTED4), RHH (DW10CTED4)	1997		0-N2063	TB [TE]	
1.6 HDi	06/09-	9HZ (DV6TED4)	1560		0-N1502	VB [BT]	S
1.6 HDi	08/10-	9HD (DV6CTED), 9HR (DV6C)	1560	für Fahrzeuge ohne Start-Stopp-Funktion	0-N1502	VB [BT]	S
1.6 HDi	08/10-	9HR (DV6C)	1560	Rippenanzahl: 6; für Fahrzeuge mit Start-Stopp-Funktion, ✳	0-N2355	VB [DG]	
1.6 HDi	08/10-	9HR (DV6C)	1560	für Fahrzeuge mit Start-Stopp-Funktion	0-N2392	VB [BT]	S



OPTIMAL®

PEUGEOT



CM³



Art. Nr.



3008							
1.6 THP, 1.6 VTi	06/09-	5FS (EP6C), 5FW (EP6), EP6, 5FV (EP6DT), 5FX (EP6DT)	1598	☼		0-N2055	VB [BT] S
1.6 THP, 1.6 VTi	06/09-	5FS (EP6C), 5FW (EP6), EP6, 5FV (EP6DT), 5FX (EP6DT)	1598	für OE: 11 28 7 598 832, 11 28 7 598 833		0-N2237	VB [DG]
2.0 HDi, 2.0 Hybrid4	06/09-	AHX (DW10FD), RHE (DW10CTED4), RHC (DW10CTED4), RHH (DW10CTED4)	1997			0-N2268	VB [BT] S

4007 (GP_)							
2.2 HDi	02/07-	4HK (DW12MTED4), 4HN (DW12MTED4)	2179	25.4x118		SK-1692	BTK
2.2 HDi	02/07-	4HK (DW12MTED4), 4HN (DW12MTED4)	2179	25.4x118		SK-1692AQ1	BTKW
2.2 HDi	02/07-	4HK (DW12MTED4), 4HN (DW12MTED4)	2179			0-N1334	TB [DG]
2.2 HDi	02/07-	4HK (DW12MTED4), 4HN (DW12MTED4)	2179			0-N2018	TB [BT]
2.0, 2.0 4x4	11/10-	4B11	1998			0-N2048	VB [DG]
2.0, 2.0 4x4	11/10-	4B11	1998			0-N2112	VB [BT] S
2.2 HDi	02/07-	4HK (DW12MTED4), 4HN (DW12MTED4)	2179			0-N2019	VB [DG]
2.2 HDi	02/07-	4HK (DW12MTED4), 4HN (DW12MTED4)	2179			0-N2116	VB [BT] S
2.4 16V	01/08-	SFY (4B12-MMC), SFZ (4B12-MMC)	2360			0-N2048	VB [DG]
2.4 16V	01/08-	SFY (4B12-MMC), SFZ (4B12-MMC)	2360			0-N2112	VB [BT] S

4008							
1.6 HDi, 1.6 HDi AWC	05/12-	9HD (DV6C)	1560	25x141		SK-1728	BTK
1.6 HDi, 1.6 HDi AWC	05/12-	9HD (DV6C)	1560	25x141		SK-1728AQ1	BTKW
1.6 HDi	05/12-	DV6C	1560			0-N2224	TB [TE]
1.6 HDi AWC	05/12-	9HD (DV6C)	1560			0-N2224	TB [TE]
1.6 HDi, 1.6 HDi AWC	05/12-	DV6C	1560			0-N2382	TB [DG]
1.6 HDi AWC	05/12-	9HD (DV6C)	1560			0-N1502	VB [BT] S
2.0	05/13-	4B11	1998			0-N2294	VB [DG]
2.0 AWC	05/12-	4B11	1998			0-N2048	VB [DG]
2.0 AWC	05/12-	4B11	1998			0-N2112	VB [BT] S
2.0 AWC	05/12-	4B11	1998	Orga.13115→		0-N2294	VB [DG]
2.0 AWC	05/12-	4B11	1998			0-N2354	VB [DG]

5008							
1.6 HDi	09/09-	9HZ (DV6TED4)	1560	25x137		SK-1424	BTK
1.6 HDi	09/09-	9HZ (DV6TED4)	1560	25x137		SK-1424AQ1	BTKW
1.6 HDi	08/10-	9HD (DV6CTED), 9HR (DV6C)	1560	25x141		SK-1728	BTK
1.6 HDi	08/10-	9HD (DV6CTED), 9HR (DV6C)	1560	25x141		SK-1728AQ1	BTKW
2.0 HDi	06/09-	AHV (DW10FD), RHD (DW10CTED4), AHX (DW10FD), RHE (DW10CTED4), RHH (DW10CTED4)	1997	25x116		SK-1714	BTK
2.0 HDi	06/09-	AHV (DW10FD), RHD (DW10CTED4), AHX (DW10FD), RHE (DW10CTED4), RHH (DW10CTED4)	1997	25x116		SK-1714AQ1	BTKW
1.6 BlueHdi 120, 1.6 HDi	08/10-	9HD (DV6CTED), 9HR (DV6C), BHZ (DV6FC)	1560			0-N2382	TB [DG]
1.6 HDi	09/09-	9HZ (DV6TED4)	1560			0-N1062	TB [TE]
1.6 HDi	09/09-	9HZ (DV6TED4)	1560			0-N1066	TB [DG]
1.6 HDi	08/10-	9HD (DV6CTED), 9HR (DV6C)	1560			0-N2224	TB [TE]
2.0 HDi	06/09-	AHV (DW10FD), RHD (DW10CTED4), AHX (DW10FD), RHE (DW10CTED4), RHH (DW10CTED4)	1997			0-N1334	TB [DG]
2.0 HDi	06/09-	AHV (DW10FD), RHD (DW10CTED4), AHX (DW10FD), RHE (DW10CTED4), RHH (DW10CTED4)	1997			0-N2063	TB [TE]
1.6 16V	09/09-	5FS (EP6C), 5FW (EP6), EP6, EP6CDT	1598	☼		0-N2055	VB [BT] S
1.6 16V	09/09-	5FS (EP6C), 5FW (EP6), EP6, EP6CDT	1598	für OE: 11 28 7 598 832, 11 28 7 598 833		0-N2237	VB [DG]
1.6 HDi	09/09-	9HZ (DV6TED4)	1560			0-N1502	VB [BT] S
1.6 HDi	08/10-	9HD (DV6CTED), 9HR (DV6C)	1560	für Fahrzeuge ohne Start-Stopp-Funktion		0-N1502	VB [BT] S
1.6 HDi	08/10-	9HR (DV6C)	1560	Rippenanzahl: 6; für Fahrzeuge mit Start-Stopp-Funktion, ☼		0-N2355	VB [DG]
1.6 HDi	08/10-	9HR (DV6C)	1560	für Fahrzeuge mit Start-Stopp-Funktion		0-N2392	VB [BT] S
2.0 HDi	06/09-	AHX (DW10FD), RHE (DW10CTED4), RHH (DW10CTED4)	1997			0-N2268	VB [BT] S
2.0 HDi	02/12-	DW10CTED4	1997			0-N2268	VB [BT] S

BIPPER (AA_)							
1.4	02/08-	KFV (TU3A)	1360	17x104; 01/2010 →; Baumuster: AA_		SK-1354	BTK
1.4	02/08-	KFV (TU3A)	1360	17x104; 01/2010 →		SK-1354AQ1	BTKW
1.4 HDi	02/08-	8HS (DV4TED)	1398	25.4x144		SK-1391	BTK
1.4 HDi	02/08-	8HS (DV4TED)	1398	25.4x144		SK-1391AQ1	BTKW
1.4	02/08-	KFV (TU3A)	1360			0-N1277	TB [TE]

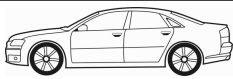

CM³



Art. Nr.



BIPPER (AA_)

1.4 HDi	02/08-	8HS (DV4TED)	1398		0-N1062	TB [TE]	
1.4 HDi	02/08-	8HS (DV4TED)	1398		0-N1066	TB [DG]	
1.3 HDi 75	10/10-	199 A9.000	1248		0-N2390	VB [BT]	S
1.4	02/08-	KFV (TU3A)	1360		0-N1419	VB [DG]	
1.4	02/08-	KFV (TU3A)	1360		0-N1620	VB [BT]	S
1.4 HDi	02/08-	8HS (DV4TED)	1398		0-N1807	VB [DG]	
1.4 HDi	02/08-	8HS (DV4TED)	1398		0-N1808	VB [BT]	S

BIPPER Tepee

1.4	04/08-	KFV (TU3A)	1360	17x104	SK-1354	BTK	
1.4	04/08-	KFV (TU3A)	1360	17x104	SK-1354AQ1	BTKW	
1.4 HDi	04/08-	8HS (DV4TED)	1398	25.4x144	SK-1391	BTK	
1.4 HDi	04/08-	8HS (DV4TED)	1398	25.4x144	SK-1391AQ1	BTKW	
1.4	04/08-	KFV (TU3A)	1360		0-N1277	TB [TE]	
1.4 HDi	04/08-	8HS (DV4TED)	1398		0-N1062	TB [TE]	
1.4 HDi	04/08-	8HS (DV4TED)	1398		0-N1066	TB [DG]	
1.3 HDi 75	10/10-	199 A9.000	1248		0-N2390	VB [BT]	S
1.4	04/08-	KFV (TU3A)	1360		0-N1419	VB [DG]	
1.4	04/08-	KFV (TU3A)	1360		0-N1620	VB [BT]	S
1.4 HDi	04/08-	8HS (DV4TED)	1398		0-N1807	VB [DG]	

BOXER Bus (230P)

1.9 D, 1.9 TD, 1.9 TD 4x4	03/94-04/02	D8C (XUD9UTF), D9B (XUD9AU), DHY (XUD9TE)	1905	25.4x136	SK-1022	BTK	
1.9 D, 1.9 TD, 1.9 TD 4x4	03/94-04/02	D8C (XUD9UTF), D9B (XUD9AU), DHY (XUD9TE)	1905	25.4x136; 02/1997 →	SK-1022AQ1	BTKW	
1.9 D, 1.9 TD, 1.9 TD 4x4	03/94-04/02	D8C (XUD9UTF), D9B (XUD9AU), DHY (XUD9TE)	1905	25.4x136; Orga. → 07389	SK-1022AQ2	BTKW	
2.0 i, 2.0 i 4x4	03/94-04/02	RFW (XU10J2)	1998	25.4x114	SK-1079	BTK	
2.5 D, 2.5 D 4x4, 2.5 TD, 2.5 TD 4x4	07/94-04/02	T8A (DJ5T), T9A (DJ5)	2446	28x141	SK-1034	BTK	
2.5 DT	10/97-11/01		2499	30x152	SK-1035	BTK	
2.5 TDI, 2.5 TDI 4x4	01/97-04/02	THX (DJ5TED)	2446	32x147	SK-1087	BTK	
2.8 D	01/99-02/02	8140.63 (F28D)	2798	30x153; Baumuster: 230P	SK-1046	BTK	
2.8 D	01/99-02/02	8140.63 (F28D)	2798	mit Spanndämpfer, Spannrolle	SK-1679	BTK	
2.8 HDi	11/00-04/02	8140.43S (F28DTCR)	2798	30x154; 12/2001 →; ohne Spanndämpfer, Spannrolle	SK-1153	BTK	
2.8 HDi, 2.8 HDi 4x4	10/00-04/02	8140.43S (F28DTCR)	2798	30x152	SK-1035	BTK	
1.9 D, 1.9 TD, 1.9 TD 4x4	03/94-04/02	D8C (XUD9UTF), D9B (XUD9AU), DHY (XUD9TE)	1905		0-N900	TB [DG]	
1.9 D, 1.9 TD, 1.9 TD 4x4	03/94-04/02	D8C (XUD9UTF), D9B (XUD9AU), DHY (XUD9TE)	1905		0-N901	TB [TE]	
2.0 i, 2.0 i 4x4	03/94-04/02	RFW (XU10J2)	1998		0-N943	TB [TE]	
2.5 D, 2.5 D 4x4, 2.5 TD, 2.5 TD 4x4	07/94-04/02	T8A (DJ5T), T9A (DJ5)	2446		0-N944	TB [TE]	
2.5 D, 2.5 D 4x4, 2.5 TD, 2.5 TD 4x4	07/94-04/02	T8A (DJ5T), T9A (DJ5)	2446		0-N945	TB [DG]	
2.5 DT	10/97-11/01		2499		0-N1617	TB [BT]	
2.5 DT	10/97-11/01		2499		0-N816	TB [DG]	
2.5 DT	10/97-11/01		2499		0-N821	TB [DG]	
2.5 TDI, 2.5 TDI 4x4	01/97-04/02	THX (DJ5TED)	2446		0-N214	TB [BT]	
2.5 TDI, 2.5 TDI 4x4	01/97-04/02	THX (DJ5TED)	2446		0-N215	TB [TE]	
2.8 D, 2.8 HDi, 2.8 HDi 4x4, 2.8 HDi Allrad	01/99-04/02	8140.43S (F28DTCR), 8140.63 (F28D)	2798		0-N1617	TB [BT]	
2.8 D, 2.8 HDi, 2.8 HDi 4x4, 2.8 HDi Allrad	01/99-04/02	8140.43S (F28DTCR), 8140.63 (F28D)	2798		0-N816	TB [DG]	
2.8 HDi, 2.8 HDi 4x4, 2.8 HDi Allrad	10/00-04/02	8140.43S (F28DTCR)	2798		0-N821	TB [DG]	
1.9 D, 1.9 TD, 1.9 TD 4x4	03/94-04/02	D8C (XUD9UTF), D9B (XUD9AU), DHY (XUD9TE)	1905		0-N931	VB [TE]	
2.0 i, 2.0 i 4x4	03/94-04/02	RFW (XU10J2)	1998		0-N124	VB [TE]	
2.5 D, 2.5 D 4x4, 2.5 TD, 2.5 TD 4x4	07/94-04/02	T8A (DJ5T), T9A (DJ5)	2446		0-N1749	VB [BT]	S
2.5 D, 2.5 D 4x4, 2.5 TD, 2.5 TD 4x4	07/94-04/02	T8A (DJ5T), T9A (DJ5)	2446	ch. → S15236900; ㊦	0-N1899	VB [TE]	
2.5 D, 2.5 D 4x4, 2.5 TD, 2.5 TD 4x4, 2.5 TDI, 2.5 TDI 4x4	07/94-04/02	T8A (DJ5T), T9A (DJ5), THX (DJ5TED)	2446		0-N095	VB [TE]	
2.5 DT	10/97-11/01		2499	mit Anbaumaterial	0-N1711S	VB [TE]	
2.5 TDI, 2.5 TDI 4x4	01/97-04/02	THX (DJ5TED)	2446		0-N1750	VB [BT]	
2.5 TDI, 2.5 TDI 4x4	01/97-04/02	THX (DJ5TED)	2446		0-N1904	VB [TE]	
2.5 TDI, 2.5 TDI 4x4	01/97-04/02	THX (DJ5TED)	2446		0-N1975	VB [BT]	
2.8 D	01/99-02/02	8140.63 (F28D)	2798	mit Anbaumaterial	0-N1711S	VB [TE]	
2.8 HDi, 2.8 HDi 4x4, 2.8 HDi Allrad	10/00-04/02	8140.43S (F28DTCR)	2798		0-N1387	VB [DG]	

BOXER Kasten (230L)

1.9 D, 1.9 DT 4x4, 1.9 TD	03/94-04/02	D8C (XUD9UTF), D9B (XUD9AU), DJY (XUD9A), XUD9TE	1905	25.4x136	SK-1022	BTK	
1.9 D, 1.9 TD	03/94-04/02	D8C (XUD9UTF), D9B (XUD9AU)	1905	25.4x136; 02/1997 →	SK-1022AQ1	BTKW	



OPTIMAL®

PEUGEOT

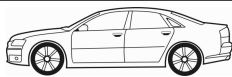

CM³



Art. Nr.



ohne Halter

BOXER Kasten (230L)

1.9 D, 1.9 TD	03/94-04/02	D8C (XUD9UTF), DJY (XUD9A)	1905	25.4x136	SK-1022AQ2	BTKW
1.9 DT 4x4	03/96-09/98	XUD9TE	1905	25.4x136; → 01/1997	SK-1022AQ2	BTKW
2.0 4x4, 2.0 i	06/94-04/02	RFW (XU10J2)	1998	25.4x114	SK-1079	BTK
2.0 HDI	08/01-04/02	RHV (DW10UTD)	1997	25x141; mit Zubehör	SK-1085	BTK
2.0 HDI	08/01-04/02	RHV (DW10UTD)	1997	25.4x141; mit Zubehör	SK-1085AQ1	BTKW
2.5 D, 2.5 D 4x4, 2.5 TD	03/94-04/02	T8A (DJ5T), T9A (DJ5)	2446	28x141	SK-1034	BTK
2.5 DT	10/97-11/01		2499	30x152	SK-1035	BTK
2.5 TDI, 2.5 TDI 4x4	01/97-04/02	THX (DJ5TED)	2446	32x147	SK-1087	BTK
2.8 D	01/99-02/02	8140.63 (F28D)	2798	30x153; Baumuster: 230L	SK-1046	BTK
2.8 D	01/99-02/02	8140.63 (F28D)	2798	mit Spanndämpfer, Spannrolle	SK-1679	BTK
2.8 HDI	11/00-04/02	8140.43S (F28DTCR)	2798	30x154; 12/2001 →; ohne Spanndämpfer, Spannrolle	SK-1153	BTK
2.8 HDI, 2.8 HDi 4x4	10/00-04/02	8140.43S (F28DTCR)	2798	30x152	SK-1035	BTK
1.9 D, 1.9 TD	03/94-04/02	D8C (XUD9UTF), D9B (XUD9AU), DJY (XUD9A), XUD9TE	1905		0-N900	TB [DG]
1.9 D, 1.9 TD	03/94-04/02	D8C (XUD9UTF), D9B (XUD9AU), DJY (XUD9A), XUD9TE	1905		0-N901	TB [TE]
2.0 i	06/94-04/02	RFW (XU10J2)	1998		0-N943	TB [TE]
2.5 D, 2.5 D 4x4, 2.5 TD	03/94-04/02	T8A (DJ5T), T9A (DJ5)	2446		0-N944	TB [TE]
2.5 D, 2.5 D 4x4, 2.5 TD	03/94-04/02	T8A (DJ5T), T9A (DJ5)	2446		0-N945	TB [DG]
2.5 DT	10/97-11/01		2499		0-N1617	TB [BT]
2.5 DT	10/97-11/01		2499		0-N816	TB [DG]
2.5 DT	10/97-11/01		2499		0-N821	TB [DG]
2.5 TDI, 2.5 TDI 4x4	01/97-04/02	THX (DJ5TED)	2446		0-N214	TB [BT]
2.5 TDI, 2.5 TDI 4x4	01/97-04/02	THX (DJ5TED)	2446		0-N215	TB [TE]
2.8 D, 2.8 HDI, 2.8 HDi 4x4	01/99-04/02	8140.43S (F28DTCR), 8140.63 (F28D)	2798		0-N1617	TB [BT]
2.8 D, 2.8 HDI, 2.8 HDi 4x4	01/99-04/02	8140.43S (F28DTCR), 8140.63 (F28D)	2798		0-N816	TB [DG]
2.8 HDI, 2.8 HDi 4x4	10/00-04/02	8140.43S (F28DTCR)	2798		0-N821	TB [DG]
1.9 D, 1.9 TD	03/94-04/02	D8C (XUD9UTF), D9B (XUD9AU), DJY (XUD9A), XUD9TE	1905		0-N931	VB [TE]
2.0 HDI	08/01-04/02	RHV (DW10UTD)	1997	*	0-N1471	VB [BT] S
2.0 i	06/94-04/02	RFW (XU10J2)	1998		0-N124	VB [TE]
2.5 D, 2.5 D 4x4, 2.5 TD	03/94-04/02	T8A (DJ5T), T9A (DJ5)	2446		0-N1749	VB [BT] S
2.5 D, 2.5 D 4x4, 2.5 TD	03/94-04/02	T8A (DJ5T), T9A (DJ5)	2446	ch.→S15236900; *	0-N1899	VB [TE]
2.5 D, 2.5 D 4x4, 2.5 TD, 2.5 TDI, 2.5 TDI 4x4	03/94-04/02	T8A (DJ5T), T9A (DJ5), THX (DJ5TED)	2446		0-N095	VB [TE]
2.5 DT	10/97-11/01		2499	mit Anbaumaterial	0-N1711S	VB [TE]
2.5 TDI, 2.5 TDI 4x4	01/97-04/02	THX (DJ5TED)	2446		0-N1750	VB [BT]
2.5 TDI, 2.5 TDI 4x4	01/97-04/02	THX (DJ5TED)	2446		0-N1904	VB [TE]
2.5 TDI, 2.5 TDI 4x4	01/97-04/02	THX (DJ5TED)	2446		0-N1975	VB [BT]
2.8 D	01/99-02/02	8140.63 (F28D)	2798	mit Anbaumaterial	0-N1711S	VB [TE]
2.8 HDi, 2.8 HDi 4x4	10/00-04/02	8140.43S (F28DTCR)	2798		0-N1387	VB [DG]

BOXER Pritsche/Fahrgestell (ZCT_)

1.9 TD	06/94-04/02	D8C (XUD9UTF), XUD9TE, DHY (XUD9TE), XUD9TE	1905	25.4x136	SK-1022	BTK
1.9 TD	06/94-04/02	DHY (XUD9TE), XUD9TE	1905	25.4x136; Orga.07390→	SK-1022AQ1	BTKW
1.9 TD	07/94-04/02	D8C (XUD9UTF), XUD9TE	1905	25.4x136; 02/1997 →	SK-1022AQ1	BTKW
1.9 TD	07/94-04/02	D8C (XUD9UTF), XUD9TE	1905	25.4x136	SK-1022AQ2	BTKW
2.0, 2.0 i	06/94-04/02	RFL (XU10J2U), RFW (XU10J2)	1998	25.4x114	SK-1079	BTK
2.5 D, 2.5 D 4x4, 2.5 TD	03/94-04/02	T8A (DJ5T), T9A (DJ5)	2446	28x141	SK-1034	BTK
2.5 TDI, 2.5 TDI 4x4	01/97-04/02	THX (DJ5TED)	2446	32x147	SK-1087	BTK
2.8 D	01/99-02/02	8140.63 (F28D)	2798	30x153	SK-1046	BTK
2.8 D	01/99-02/02	8140.63 (F28D)	2798	mit Spanndämpfer, Spannrolle	SK-1679	BTK
2.8 HDi	10/00-04/02	8140.43S (F28DTCR)	2798	30x152	SK-1035	BTK
2.8 HDI	11/00-04/02	8140.43S (F28DTCR)	2798	30x154; 12/2001 →; ohne Spanndämpfer, Spannrolle	SK-1153	BTK
1.9 TD	06/94-04/02	D8C (XUD9UTF), XUD9TE, DHY (XUD9TE), XUD9TE	1905		0-N900	TB [DG]
1.9 TD	06/94-04/02	D8C (XUD9UTF), XUD9TE, DHY (XUD9TE), XUD9TE	1905		0-N901	TB [TE]
2.0 i	06/94-04/02	RFW (XU10J2)	1998		0-N943	TB [TE]
2.5 D, 2.5 D 4x4, 2.5 TD	03/94-04/02	T8A (DJ5T), T9A (DJ5)	2446		0-N944	TB [TE]
2.5 D, 2.5 D 4x4, 2.5 TD	03/94-04/02	T8A (DJ5T), T9A (DJ5)	2446		0-N945	TB [DG]
2.5 TDI, 2.5 TDI 4x4	01/97-04/02	THX (DJ5TED)	2446		0-N214	TB [BT]
2.5 TDI, 2.5 TDI 4x4	01/97-04/02	THX (DJ5TED)	2446		0-N215	TB [TE]
2.8 D, 2.8 HDi, 2.8 HDi Allrad	01/99-04/02	8140.43S (F28DTCR), 8140.63 (F28D)	2798		0-N1617	TB [BT]
2.8 D, 2.8 HDi, 2.8 HDi Allrad	01/99-04/02	8140.43S (F28DTCR), 8140.63 (F28D)	2798		0-N816	TB [DG]

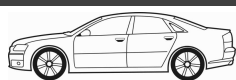

CM³



Art. Nr.



ohne Halter

BOXER Pritsche/Fahrgestell (ZCT_)

2.8 HDi, 2.8 HDi Allrad	10/00-04/02	8140.43S (F28DTCR)	2798		0-N821	TB [DG]
1.9 TD	06/94-04/02	D8C (XUD9UTF), XUD9TE, DHY (XUD9TE), XUD9TE	1905		0-N931	VB [TE]
2.0 i	06/94-04/02	RFW (XU10J2)	1998		0-N124	VB [TE]
2.5 D, 2.5 D 4x4, 2.5 TD	03/94-04/02	T8A (DJ5T), T9A (DJ5)	2446		0-N1749	VB [BT] S
2.5 D, 2.5 D 4x4, 2.5 TD	03/94-04/02	T8A (DJ5T), T9A (DJ5)	2446	ch.→S15236900; ☼	0-N1899	VB [TE]
2.5 D, 2.5 D 4x4, 2.5 TD, 2.5 TDI, 2.5 TDI 4x4	03/94-04/02	T8A (DJ5T), T9A (DJ5), THX (DJ5TED)	2446		0-N095	VB [TE]
2.5 TDI, 2.5 TDI 4x4	01/97-04/02	THX (DJ5TED)	2446		0-N1750	VB [BT]
2.5 TDI, 2.5 TDI 4x4	01/97-04/02	THX (DJ5TED)	2446		0-N1904	VB [TE]
2.5 TDI, 2.5 TDI 4x4	01/97-04/02	THX (DJ5TED)	2446		0-N1975	VB [BT]
2.8 D	01/99-02/02	8140.63 (F28D)	2798	mit Anbaumaterial	0-N1711S	VB [TE]
2.8 HDi, 2.8 HDi Allrad	10/00-04/02	8140.43S (F28DTCR)	2798		0-N1387	VB [DG]

BOXER Bus (244, Z_)

2.0	04/02-	RFL (XU10J2U)	1998	25.4x114	SK-1079	BTK
2.0 HDi	04/02-	DW10TD	1997	25x141; mit Zubehör	SK-1085	BTK
2.0 HDi	04/02-	RHV (DW10TD), RHV (DW10UTD)	1997	25.4x141; mit Zubehör	SK-1085AQ1	BTKW
2.2 HDi	04/02-	4HY (DW12UTED)	2179	25.4x143; → 04/2004	SK-1609	BTK
2.2 HDi	04/02-	4HY (DW12UTED)	2179	25.4x143; → 04/2004	SK-1609AQ1	BTKW
2.2 HDi	04/02-	4HY (DW12UTED)	2179	25x143; 04/2004 → 06/2006	SK-1617	BTK
2.2 HDi	04/02-	4HY (DW12UTED)	2179	25x143; 04/2004 →	SK-1617AQ1	BTKW
2.8 HDi, 2.8 HDi 4x4	04/02-	8140.43N, 8140.43S (F28DTCR)	2798	30x152	SK-1035	BTK
2.8 HDi, 2.8 HDi 4x4	04/02-	8140.43S (F28DTCR)	2798	30x154; ohne Spanndämpfer, Spannrolle	SK-1153	BTK
2.8 HDi, 2.8 HDi 4x4	04/02-	8140.43S (F28DTCR)	2798	30x152; 04/2004 →; mit Spanndämpfer, Spannrolle	SK-1680	BTK
2.0	04/02-	RFL (XU10J2U)	1998		0-N943	TB [TE]
2.0 HDi	04/02-	RHV (DW10TD), RHV (DW10UTD)	1997		0-N118P	TB [TE]
2.0 HDi	04/02-	RHV (DW10TD), RHV (DW10UTD)	1997		0-N119P	TB [DG]
2.2 HDi	04/02-	4HY (DW12UTED)	2179	→ 04/2004	0-N118P	TB [TE]
2.2 HDi	04/02-	4HY (DW12UTED)	2179	→ 04/2004	0-N119P	TB [DG]
2.2 HDi	04/02-	4HY (DW12UTED)	2179	04/2004 →	0-N1357	TB [TE]
2.2 HDi	04/02-	4HY (DW12UTED)	2179	04/2004 →	0-N1358	TB [DG]
2.8 HDi, 2.8 HDi 4x4	04/02-	8140.43N, 8140.43S (F28DTCR)	2798		0-N1617	TB [BT]
2.8 HDi, 2.8 HDi 4x4	04/02-	8140.43N, 8140.43S (F28DTCR)	2798		0-N816	TB [DG]
2.8 HDi, 2.8 HDi 4x4	04/02-	8140.43N, 8140.43S (F28DTCR)	2798		0-N821	TB [DG]
2.0	04/02-	RFL (XU10J2U)	1998		0-N124	VB [TE]
2.0 HDi	04/02-	RHV (DW10TD), RHV (DW10UTD)	1997	→ 05/2004; ☼	0-N1421	VB [DG]
2.0 HDi	04/02-	RHV (DW10TD), RHV (DW10UTD)	1997	☼	0-N1421	VB [DG]
2.0 HDi	04/02-	RHV (DW10TD), RHV (DW10UTD)	1997	05/2004 →; ☼, ☼	0-N1471	VB [BT] S
2.0 HDi	04/02-	RHV (DW10TD), RHV (DW10UTD)	1997	→ 05/2004; ☼	0-N1493	VB [BT] S
2.0 HDi	04/02-	RHV (DW10TD), RHV (DW10UTD)	1997	→ 05/2004	0-N1748	VB [BT]
2.2 HDi	04/02-	4HY (DW12UTED)	2179	→ 04/2004; ☼	0-N1421	VB [DG]
2.2 HDi	04/02-	4HY (DW12UTED)	2179	☼	0-N1421	VB [DG]
2.2 HDi	04/02-	4HY (DW12UTED)	2179	04/2004 →; ☼, ☼	0-N1471	VB [BT] S
2.2 HDi	04/02-	4HY (DW12UTED)	2179	→ 04/2004; ☼	0-N1493	VB [BT] S
2.2 HDi	04/02-	4HY (DW12UTED)	2179	→ 04/2004	0-N1748	VB [BT]
2.8 HDi	04/04-	8140.43N	2798	‡; mit Anbaumaterial	0-N1386	VB [TE]
2.8 HDi	04/04-	8140.43N	2798	☼:3980847→; mit Anbaumaterial	0-N1711S	VB [TE]
2.8 HDi, 2.8 HDi 4x4	04/02-	8140.43S (F28DTCR)	2798		0-N1387	VB [DG]

BOXER Kasten (244)

2.0	04/02-	RFL (XU10J2U)	1998	25.4x114	SK-1079	BTK
2.0 HDi	04/02-	DW10TD	1997	25x141; mit Zubehör	SK-1085	BTK
2.0 HDi	04/02-	RHV (DW10TD), RHV (DW10UTD)	1997	25.4x141; mit Zubehör	SK-1085AQ1	BTKW
2.2 HDi	04/02-	4HY (DW12UTED)	2179	25.4x143; → 04/2004	SK-1609	BTK
2.2 HDi	04/02-	4HY (DW12UTED)	2179	25.4x143; → 04/2004	SK-1609AQ1	BTKW
2.2 HDi	04/02-	4HY (DW12UTED)	2179	25x143; 04/2004 → 06/2006	SK-1617	BTK
2.2 HDi	04/02-	4HY (DW12UTED)	2179	25x143; 04/2004 →	SK-1617AQ1	BTKW
2.8 HDi, 2.8 HDi 4x4	04/02-	8140.43N, 8140.43S (F28DTCR)	2798	30x152	SK-1035	BTK
2.8 HDi, 2.8 HDi 4x4	04/02-	8140.43S (F28DTCR)	2798	30x154; ohne Spanndämpfer, Spannrolle	SK-1153	BTK
2.8 HDi, 2.8 HDi 4x4	04/02-	8140.43S (F28DTCR)	2798	30x152; 04/2004 →; mit Spanndämpfer, Spannrolle	SK-1680	BTK
2.0	04/02-	RFL (XU10J2U)	1998		0-N943	TB [TE]
2.0 HDi	04/02-	RHV (DW10TD), RHV (DW10UTD)	1997		0-N118P	TB [TE]
2.0 HDi	04/02-	RHV (DW10TD), RHV (DW10UTD)	1997		0-N119P	TB [DG]
2.2 HDi	04/02-	4HY (DW12UTED)	2179	→ 04/2004	0-N118P	TB [TE]

CM³

Art. Nr.

**BOXER Kasten (244)**

2.2 HDi	04/02-	4HY (DW12UTED)	2179	→ 04/2004	0-N119P	TB [DG]	
2.2 HDi	04/02-	4HY (DW12UTED)	2179	04/2004 →	0-N1357	TB [TE]	
2.2 HDi	04/02-	4HY (DW12UTED)	2179	04/2004 →	0-N1358	TB [DG]	
2.8 HDi, 2.8 HDi 4x4	04/02-	8140.43N, 8140.43S (F28DTCR)	2798		0-N1617	TB [BT]	
2.8 HDi, 2.8 HDi 4x4	04/02-	8140.43N, 8140.43S (F28DTCR)	2798		0-N816	TB [DG]	
2.8 HDi, 2.8 HDi 4x4	04/02-	8140.43N, 8140.43S (F28DTCR)	2798		0-N821	TB [DG]	
2.0	04/02-	RFL (XU10J2U)	1998		0-N124	VB [TE]	
2.0 HDi	04/02-	RHV (DW10TD), RHV (DW10UTD)	1997	→ 05/2004; ✖	0-N1421	VB [DG]	
2.0 HDi	04/02-	RHV (DW10TD), RHV (DW10UTD)	1997	✖	0-N1421	VB [DG]	
2.0 HDi	04/02-	RHV (DW10TD), RHV (DW10UTD)	1997	05/2004 →; ✖, ✖	0-N1471	VB [BT]	S
2.0 HDi	04/02-	RHV (DW10TD), RHV (DW10UTD)	1997	→ 05/2004; ✖	0-N1493	VB [BT]	S
2.0 HDi	04/02-	RHV (DW10TD), RHV (DW10UTD)	1997	→ 05/2004	0-N1748	VB [BT]	
2.2 HDi	04/02-	4HY (DW12UTED)	2179	→ 04/2004; ✖	0-N1421	VB [DG]	
2.2 HDi	04/02-	4HY (DW12UTED)	2179	✖	0-N1421	VB [DG]	
2.2 HDi	04/02-	4HY (DW12UTED)	2179	04/2004 →; ✖, ✖	0-N1471	VB [BT]	S
2.2 HDi	04/02-	4HY (DW12UTED)	2179	→ 04/2004; ✖	0-N1493	VB [BT]	S
2.2 HDi	04/02-	4HY (DW12UTED)	2179	→ 04/2004	0-N1748	VB [BT]	
2.8 HDi	04/04-	8140.43N	2798	:3980847→; mit Anbaumaterial	0-N1711S	VB [TE]	
2.8 HDi, 2.8 HDi 4x4	04/02-	8140.43N, 8140.43S (F28DTCR)	2798	†; mit Anbaumaterial	0-N1386	VB [TE]	
2.8 HDi, 2.8 HDi 4x4	04/02-	8140.43S (F28DTCR)	2798		0-N1387	VB [DG]	

BOXER Pritsche/Fahrgestell (244)

2.0 HDi	04/02-	DW10TD	1997	25x141; mit Zubehör	SK-1085	BTK	
2.0 HDi	04/02-	RHV (DW10TD), RHV (DW10UTD)	1997	25.4x141; mit Zubehör	SK-1085AQ1	BTKW	
2.2 HDi	04/02-	4HY (DW12UTED)	2179	25.4x143; → 04/2004	SK-1609	BTK	
2.2 HDi	04/02-	4HY (DW12UTED)	2179	25.4x143; → 04/2004	SK-1609AQ1	BTKW	
2.2 HDi	04/02-	4HY (DW12UTED)	2179	25x143; 04/2004 → 06/2006	SK-1617	BTK	
2.2 HDi	04/02-	4HY (DW12UTED)	2179	25x143; 04/2004 →	SK-1617AQ1	BTKW	
2.8 HDi, 2.8 HDi 4x4	04/02-	8140.43N, 8140.43S (F28DTCR)	2798	30x152	SK-1035	BTK	
2.8 HDi, 2.8 HDi 4x4	04/02-	8140.43S (F28DTCR)	2798	30x154; ohne Spanndämpfer, Spannrolle	SK-1153	BTK	
2.8 HDi, 2.8 HDi 4x4	04/02-	8140.43S (F28DTCR)	2798	30x152; 04/2004 →; mit Spanndämpfer, Spannrolle	SK-1680	BTK	
2.0 HDi	04/02-	RHV (DW10TD), RHV (DW10UTD)	1997		0-N118P	TB [TE]	
2.0 HDi	04/02-	RHV (DW10TD), RHV (DW10UTD)	1997		0-N119P	TB [DG]	
2.2 HDi	04/02-	4HY (DW12UTED)	2179	→ 04/2004	0-N118P	TB [TE]	
2.2 HDi	04/02-	4HY (DW12UTED)	2179	→ 04/2004	0-N119P	TB [DG]	
2.2 HDi	04/02-	4HY (DW12UTED)	2179	04/2004 →	0-N1357	TB [TE]	
2.2 HDi	04/02-	4HY (DW12UTED)	2179	04/2004 →	0-N1358	TB [DG]	
2.8 HDi, 2.8 HDi 4x4	04/02-	8140.43N, 8140.43S (F28DTCR)	2798		0-N1617	TB [BT]	
2.8 HDi, 2.8 HDi 4x4	04/02-	8140.43N, 8140.43S (F28DTCR)	2798		0-N816	TB [DG]	
2.8 HDi, 2.8 HDi 4x4	04/02-	8140.43N, 8140.43S (F28DTCR)	2798		0-N821	TB [DG]	
2.0 HDi	04/02-	RHV (DW10TD), RHV (DW10UTD)	1997	→ 05/2004; ✖	0-N1421	VB [DG]	
2.0 HDi	04/02-	RHV (DW10TD), RHV (DW10UTD)	1997	✖	0-N1421	VB [DG]	
2.0 HDi	04/02-	RHV (DW10TD), RHV (DW10UTD)	1997	05/2004 →; ✖, ✖	0-N1471	VB [BT]	S
2.0 HDi	04/02-	RHV (DW10TD), RHV (DW10UTD)	1997	→ 05/2004; ✖	0-N1493	VB [BT]	S
2.0 HDi	04/02-	RHV (DW10TD), RHV (DW10UTD)	1997	→ 05/2004	0-N1748	VB [BT]	
2.2 HDi	04/02-	4HY (DW12UTED)	2179	→ 04/2004; ✖	0-N1421	VB [DG]	
2.2 HDi	04/02-	4HY (DW12UTED)	2179	✖	0-N1421	VB [DG]	
2.2 HDi	04/02-	4HY (DW12UTED)	2179	04/2004 →; ✖, ✖	0-N1471	VB [BT]	S
2.2 HDi	04/02-	4HY (DW12UTED)	2179	→ 04/2004; ✖	0-N1493	VB [BT]	S
2.2 HDi	04/02-	4HY (DW12UTED)	2179	→ 04/2004	0-N1748	VB [BT]	
2.8 HDi	04/04-	8140.43N	2798	†; mit Anbaumaterial	0-N1386	VB [TE]	
2.8 HDi	04/04-	8140.43N	2798	:3980847→; mit Anbaumaterial	0-N1711S	VB [TE]	
2.8 HDi, 2.8 HDi 4x4	04/02-	8140.43S (F28DTCR)	2798		0-N1387	VB [DG]	

BOXER Bus

2.2 HDi 100, 2.2 HDi 110, 2.2 HDi 120, 2.2 HDi 130, 2.2 HDi 150	04/06-	4HG (P22DTE), 4HH (P22DTE), 4HJ (P22DTE), 4HU (P22DTE), 4HV (P22DTE)	2198		0-N1392	VB [DG]	
2.2 HDi 100, 2.2 HDi 110, 2.2 HDi 120, 2.2 HDi 130, 2.2 HDi 150	04/06-	4HG (P22DTE), 4HH (P22DTE), 4HJ (P22DTE), 4HU (P22DTE), 4HV (P22DTE)	2198	Rippenanzahl: 6	0-N1460	VB [DG]	
2.2 HDi 100, 2.2 HDi 110, 2.2 HDi 120, 2.2 HDi 130, 2.2 HDi 150	04/06-	4HG (P22DTE), 4HH (P22DTE), 4HJ (P22DTE), 4HU (P22DTE), 4HV (P22DTE)	2198		0-N2014	VB [BT]	S
3.0 HDi 145, 3.0 HDi 160, 3.0 HDi 175	04/06-	F30DT	2999	mit Anbaumaterial	0-N1711S	VB [TE]	
3.0 HDi 160	04/06-	F1CE0481D (F30DT)	2999		0-N1714	VB [BT]	S

BOXER Kasten

2.2 HDi 100, 2.2 HDi 110, 2.2 HDi 120, 2.2 HDi 130, 2.2 HDi 150	04/06-	4HG (P22DTE), 4HH (P22DTE), 4HJ (P22DTE), 4HU (P22DTE), 4HV (P22DTE)	2198		0-N1392	VB [DG]	
---	--------	--	------	--	---------	---------	--

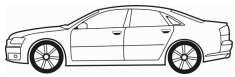

CM³



Art. Nr.



BOXER Kasten							
2.2 HDi 100, 2.2 HDi 110, 2.2 HDi 120, 2.2 HDi 130, 2.2 HDi 150	04/06-	4HG (P22DTE), 4HH (P22DTE), 4HJ (P22DTE), 4HU (P22DTE), 4HV (P22DTE)	2198	Rippenanzahl: 6		0-N1460	VB [DG]
2.2 HDi 100, 2.2 HDi 110, 2.2 HDi 120, 2.2 HDi 130, 2.2 HDi 150	04/06-	4HG (P22DTE), 4HH (P22DTE), 4HJ (P22DTE), 4HU (P22DTE), 4HV (P22DTE)	2198			0-N2014	VB [BT] S
3.0 D	07/06-	F30DT	2998	mit Anbaumaterial		0-N1711S	VB [TE]
3.0 D	07/06-	F1CE0481D (F30DT)	2998			0-N1714	VB [BT] S
3.0 HDi 145, 3.0 HDi 175	04/10-	F30DT	2999	mit Anbaumaterial		0-N1711S	VB [TE]
3.0 HDi 160	04/06-	F1CE0481D (F30DT)	2999	mit Anbaumaterial		0-N1711S	VB [TE]
3.0 HDi 160	04/06-	F1CE0481D (F30DT)	2999			0-N1714	VB [BT] S

BOXER Pritsche/Fahrgestell							
2.2 HDi 100, 2.2 HDi 110, 2.2 HDi 120, 2.2 HDi 130, 2.2 HDi 150	04/06-	4HG (P22DTE), 4HH (P22DTE), 4HJ (P22DTE), 4HU (P22DTE), 4HV (P22DTE)	2198			0-N1392	VB [DG]
2.2 HDi 100, 2.2 HDi 110, 2.2 HDi 120, 2.2 HDi 130, 2.2 HDi 150	04/06-	4HG (P22DTE), 4HH (P22DTE), 4HJ (P22DTE), 4HU (P22DTE), 4HV (P22DTE)	2198	Rippenanzahl: 6		0-N1460	VB [DG]
2.2 HDi 100, 2.2 HDi 110, 2.2 HDi 120, 2.2 HDi 130, 2.2 HDi 150	04/06-	4HG (P22DTE), 4HH (P22DTE), 4HJ (P22DTE), 4HU (P22DTE), 4HV (P22DTE)	2198			0-N2014	VB [BT] S
3.0 D	02/07-	F30DT	2998	mit Anbaumaterial		0-N1711S	VB [TE]
3.0 D	02/07-	F1CE0481D (F30DT)	2998			0-N1714	VB [BT] S
3.0 HDi 145, 3.0 HDi 175	04/10-	F30DT	2999	mit Anbaumaterial		0-N1711S	VB [TE]
3.0 HDi 160	04/06-	F1CE0481D (F30DT)	2999	mit Anbaumaterial		0-N1711S	VB [TE]
3.0 HDi 160	04/06-	F1CE0481D (F30DT)	2999			0-N1714	VB [BT] S

EXPERT (224)							
1.6	02/96-	222A2 (1580 SPI)	1581	15x138		SK-1031	BTK
1.8	10/96-09/00	LFZ (XU7JP)	1761	17x114		SK-1019	BTK
1.9 D	12/03-	WJY (DW8B), WJZ (DW8)	1868	25.4x140; Baumuster: WJZ		SK-1086	BTK
1.9 D	12/03-	WJY (DW8B), WJZ (DW8)	1868	25.4x140		SK-1086AQ1	BTKW
1.9 D, 1.9 TD	02/96-	D8B (XUD9TE), D9B (XUD9AU), DHX (XUD9TE)	1905	25.4x136		SK-1022	BTK
1.9 D, 1.9 TD	02/96-	D8B (XUD9TE), D9B (XUD9AU), DHX (XUD9TE)	1905	25.4x136; 02/1997 →		SK-1022AQ1	BTKW
1.9 D, 1.9 TD	02/96-	D9B (XUD9AU), DHX (XUD9TE)	1905	25.4x136; → 01/1997		SK-1022AQ2	BTKW
1.9 TD	02/96-	D8B (XUD9TE)	1905	25.4x136		SK-1022AQ2	BTKW
2.0	07/00-	RFN (EW10J4)	1997	25.4x153; 10/2000 →		SK-1482	BTK
2.0	07/00-	RFN (EW10J4)	1997	25.4x153; → 10/2006		SK-1482AQ1	BTKW
2.0 HDi	07/00-	RHZ (DW10ATED), RHZ (DW10BTED), RHZ (DW10CTED)	1997	25x141; 12/2001 → 11/2003; mit Zubehör		SK-1085	BTK
2.0 HDi	07/00-	RHZ (DW10ATED), RHZ (DW10BTED), RHZ (DW10CTED)	1997	25.4x141; mit Zubehör		SK-1085AQ1	BTKW
2.0 HDi	07/00-	RHW (DW10ATED4)	1997	25.4x144; → 04/2004; Orga.→10010		SK-1534	BTK
2.0 HDi	07/00-	RHZ (DW10ATED), RHZ (DW10BTED), RHZ (DW10CTED)	1997	25.4x144; Orga.→10010		SK-1534	BTK
2.0 HDi	07/00-	RHW (DW10ATED4)	1997	25.4x144; 10/2000 → 04/2004; Orga.→10010		SK-1534AQ1	BTKW
2.0 HDi	07/00-	RHZ (DW10ATED), RHZ (DW10BTED), RHZ (DW10CTED)	1997	25.4x144; Orga.→10010		SK-1534AQ1	BTKW
2.0 HDi	07/00-	RHW (DW10ATED4)	1997	25x144; 04/2004 →; Orga.10011→		SK-1616	BTK
2.0 HDi	10/00-11/03	RHX (DW10BTED)	1997	25x141; mit Zubehör		SK-1085	BTK
2.0 HDi	10/00-11/03	RHX (DW10BTED)	1997	25.4x141; Orga.09868→; mit Zubehör		SK-1085AQ1	BTKW
1.6	02/96-	222A2 (1580 SPI)	1581			0-N822	TB [TE]
1.8	10/96-09/00	LFZ (XU7JP)	1761			0-N811	TB [TE]
1.9 D	12/03-	WJY (DW8B), WJZ (DW8)	1868			0-N118P	TB [TE]
1.9 D	12/03-	DW8B	1868			0-N1381	TB [DG]
1.9 D, 1.9 TD	02/96-	D8B (XUD9TE), D9B (XUD9AU), DHX (XUD9TE)	1905			0-N900	TB [DG]
1.9 D, 1.9 TD	02/96-	D8B (XUD9TE), D9B (XUD9AU), DHX (XUD9TE)	1905			0-N901	TB [TE]
2.0	07/00-	RFN (EW10J4)	1997			0-N1057	TB [TE]
2.0	07/00-	RFN (EW10J4)	1997			0-N1065	TB [DG]
2.0 HDi	07/00-	RHZ (DW10ATED), RHZ (DW10BTED), RHZ (DW10CTED)	1997	Orga.→08560		0-N118P	TB [TE]
2.0 HDi	07/00-	RHW (DW10ATED4)	1997	Orga.→10010		0-N118P	TB [TE]
2.0 HDi	07/00-	RHZ (DW10ATED), RHZ (DW10BTED), RHZ (DW10CTED)	1997	Orga.→08560		0-N119P	TB [DG]
2.0 HDi	07/00-	RHW (DW10ATED4)	1997	Orga.→10010		0-N119P	TB [DG]
2.0 HDi	07/00-	RHW (DW10ATED4)	1997	Orga.10011→		0-N1357	TB [TE]
2.0 HDi	07/00-	RHW (DW10ATED4)	1997	Orga.10011→		0-N1358	TB [DG]
2.0 HDi	07/00-	RHZ (DW10ATED), RHZ (DW10BTED), RHZ (DW10CTED)	1997	Orga.08561→		0-N1381	TB [DG]
2.0 HDi	10/00-11/03	RHX (DW10BTED)	1997	Orga.09868→		0-N118P	TB [TE]



CM³



Art. Nr.



EXPERT (224)

2.0 HDi	10/00-11/03	RHX (DW10BTED)	1997	Orga.09868→	0-N119P	TB [DG]	
2.0 HDi	10/00-11/03	RHX (DW10BTED)	1997	Orga.→09867	0-N1381	TB [DG]	
1.8	10/96-09/00	LFZ (XU7JP)	1761	Orga.→7904	0-N124	VB [TE]	
1.8	10/96-09/00	LFZ (XU7JP)	1761	☼	0-N1405	VB [DG]	
1.8	10/96-09/00	LFZ (XU7JP)	1761	☼	0-N1484	VB [BT]	S
1.8	10/96-09/00	LFZ (XU7JP)	1761	Orga.7905→; ☼	0-N1968	VB [BT]	
1.9 D	12/03-	DW8, DW8B	1868	☼, für Fahrzeuge mit Servolenkung	0-N1320	VB [TE]	
1.9 D	12/03-	DW8B	1868	☼	0-N1471	VB [BT]	S
1.9 D	12/03-	DW8B	1868	Orga.→09519; ☼	0-N1472	VB [BT]	S
1.9 D	12/03-	WJY (DW8B), WJZ (DW8)	1868	☼, für Fahrzeuge ohne Servolenkung	0-N1681	VB [BT]	
1.9 D	12/03-	DW8B	1868	Orga.→09519; ☼	0-N1747	VB [VD]	
1.9 D, 1.9 TD	02/96-	D8B (XUD9TE), D9B (XUD9AU), DHX (XUD9TE)	1905		0-N1320	VB [TE]	
1.9 D, 1.9 TD	02/96-	D8B (XUD9TE), D9B (XUD9AU), DHX (XUD9TE)	1905		0-N1472	VB [BT]	S
1.9 D, 1.9 TD	02/96-	D8B (XUD9TE), D9B (XUD9AU), DHX (XUD9TE)	1905		0-N1747	VB [VD]	
1.9 D, 1.9 TD	02/96-	D8B (XUD9TE), D9B (XUD9AU), DHX (XUD9TE)	1905		0-N931	VB [TE]	
2.0	07/00-	RFN (EW10J4)	1997		0-N1391	VB [BT]	S
2.0	07/00-	RFN (EW10J4)	1997	Orga.→10613	0-N1416	VB [DG]	
2.0	07/00-	RFN (EW10J4)	1997	Orga.10265→	0-N2276	VB [DG]	
2.0 HDi	07/00-11/03	RHW (DW10ATED4), RHX (DW10BTED), RHZ (DW10ATED), RHZ (DW10BTED), RHZ (DW10CTED)	1997		0-N1320	VB [TE]	
2.0 HDi	07/00-11/03	RHW (DW10ATED4), RHX (DW10BTED), RHZ (DW10ATED), RHZ (DW10BTED), RHZ (DW10CTED)	1997		0-N1493	VB [BT]	S
2.0 HDi	07/00-11/03	RHW (DW10ATED4), RHX (DW10BTED), RHZ (DW10ATED), RHZ (DW10BTED), RHZ (DW10CTED)	1997	☼	0-N151	VB [DG]	
2.0 HDi	07/00-11/03	RHW (DW10ATED4), RHX (DW10BTED), RHZ (DW10ATED), RHZ (DW10BTED), RHZ (DW10CTED)	1997	☼	0-N1748	VB [BT]	

EXPERT Kasten (222)

1.6	02/96-	222A2 (1580 SPI)	1581	15x138	SK-1031	BTK	
1.8	10/96-09/00	LFZ (XU7JP)	1761	17x114	SK-1019	BTK	
1.9 D 70	12/98-	WJY (DW8B), WJZ (DW8)	1868	25.4x140; Baumuster: WJZ	SK-1086	BTK	
1.9 D 70	12/98-	DW8	1868	25.4x140	SK-1086AQ1	BTKW	
1.9 D, 1.9 TD	02/96-	D8B (XUD9TE), D9B (XUD9AU), DHX (XUD9TE)	1905	25.4x136	SK-1022	BTK	
1.9 D, 1.9 TD	02/96-	D8B (XUD9TE), D9B (XUD9AU), DHX (XUD9TE)	1905	25.4x136; 02/1997 →	SK-1022AQ1	BTKW	
1.9 D, 1.9 TD	02/96-	D8B (XUD9TE), D9B (XUD9AU), DHX (XUD9TE)	1905	25.4x136; → 01/1997	SK-1022AQ2	BTKW	
2.0	09/02-	RFN (EW10J4)	1997	25.4x153	SK-1482	BTK	
2.0	09/02-	RFN (EW10J4)	1997	25.4x153; → 10/2006	SK-1482AQ1	BTKW	
2.0 HDi	07/00-	RHX (DW10BTED)	1997	25x141; → 11/2003; mit Zubehör	SK-1085	BTK	
2.0 HDi	07/00-	RHZ (DW10ATED), RHZ (DW10BTED), RHZ (DW10CTED)	1997	25x141; 12/2001 → 11/2003; mit Zubehör	SK-1085	BTK	
2.0 HDi	07/00-	RHZ (DW10ATED), RHZ (DW10BTED), RHZ (DW10CTED)	1997	25.4x141; mit Zubehör	SK-1085AQ1	BTKW	
2.0 HDi	07/00-	RHX (DW10BTED)	1997	25.4x141; Orga.09868→; mit Zubehör	SK-1085AQ1	BTKW	
2.0 HDi	07/00-	RHW (DW10ATED4)	1997	25.4x144; → 04/2004; Orga.→10010	SK-1534	BTK	
2.0 HDi	07/00-	RHZ (DW10ATED), RHZ (DW10BTED), RHZ (DW10CTED)	1997	25.4x144; Orga.→10010	SK-1534	BTK	
2.0 HDi	07/00-	RHW (DW10ATED4)	1997	25.4x144; → 04/2004; Orga.→10010	SK-1534AQ1	BTKW	
2.0 HDi	07/00-	RHZ (DW10ATED), RHZ (DW10BTED), RHZ (DW10CTED)	1997	25.4x144; Orga.→10010	SK-1534AQ1	BTKW	
2.0 HDi	07/00-	RHW (DW10ATED4)	1997	25x144; 04/2004 →; Orga.10011→	SK-1616	BTK	
1.6	02/96-	222A2 (1580 SPI)	1581		0-N822	TB [TE]	
1.8	10/96-09/00	LFZ (XU7JP)	1761		0-N811	TB [TE]	
1.9 D 70	12/98-	WJY (DW8B), WJZ (DW8)	1868		0-N118P	TB [TE]	
1.9 D 70	12/98-	WJY (DW8B), WJZ (DW8)	1868		0-N1381	TB [DG]	
1.9 D, 1.9 TD	02/96-	D8B (XUD9TE), D9B (XUD9AU), DHX (XUD9TE)	1905		0-N900	TB [DG]	
1.9 D, 1.9 TD	02/96-	D8B (XUD9TE), D9B (XUD9AU), DHX (XUD9TE)	1905		0-N901	TB [TE]	
2.0	09/02-	RFN (EW10J4)	1997		0-N1057	TB [TE]	
2.0	09/02-	RFN (EW10J4)	1997		0-N1065	TB [DG]	



CM³



Art. Nr.



EXPERT Kasten (222)

2.0 HDI	07/00-	RHZ (DW10ATED), RHZ (DW10BTED), RHZ (DW10CTED)	1997	Orga.→08560	0-N118P	TB [TE]	
2.0 HDI	07/00-	RHW (DW10ATED4)	1997	Orga.→10010	0-N118P	TB [TE]	
2.0 HDI	07/00-	RHX (DW10BTED)	1997	Orga.09868→	0-N118P	TB [TE]	
2.0 HDI	07/00-	RHZ (DW10ATED), RHZ (DW10BTED), RHZ (DW10CTED)	1997	Orga.→08560	0-N119P	TB [DG]	
2.0 HDI	07/00-	RHW (DW10ATED4)	1997	Orga.→10010	0-N119P	TB [DG]	
2.0 HDI	07/00-	RHX (DW10BTED)	1997	Orga.09868→	0-N119P	TB [DG]	
2.0 HDI	07/00-	RHW (DW10ATED4)	1997	Orga.10011→	0-N1357	TB [TE]	
2.0 HDI	07/00-	RHW (DW10ATED4)	1997	Orga.10011→	0-N1358	TB [DG]	
2.0 HDI	07/00-	RHX (DW10BTED)	1997	Orga.→09867	0-N1381	TB [DG]	
2.0 HDI	07/00-	RHZ (DW10ATED), RHZ (DW10BTED), RHZ (DW10CTED)	1997	Orga.08561→	0-N1381	TB [DG]	
1.8	10/96-09/00	LFZ (XU7JP)	1761	Orga.→7904	0-N124	VB [TE]	
1.8	10/96-09/00	LFZ (XU7JP)	1761	☼	0-N1405	VB [DG]	
1.8	10/96-09/00	LFZ (XU7JP)	1761	☼	0-N1484	VB [BT]	S
1.8	10/96-09/00	LFZ (XU7JP)	1761	Orga.7905→; ☼	0-N1968	VB [BT]	
1.9 D 70	12/98-	DW8B	1868	für Fahrzeuge mit Servolenkung	0-N1309	VB [DG]	
1.9 D 70	12/98-	DW8	1868	Orga.08375→; für Fahrzeuge mit Servolenkung	0-N1309	VB [DG]	
1.9 D 70	12/98-	DW8, DW8B	1868		0-N1320	VB [TE]	
1.9 D 70	12/98-	DW8	1868	Orga.→08374	0-N1455	VB [TE]	
1.9 D 70	12/98-	DW8, DW8B	1868	Orga.08375→; für Fahrzeuge mit Servolenkung, ☼	0-N1471	VB [BT]	S
1.9 D 70	12/98-	DW8B	1868	Orga.→09520; ☼, für Fahrzeuge mit Servolenkung	0-N1472	VB [BT]	S
1.9 D 70	12/98-	DW8	1868	☼, für Fahrzeuge mit Servolenkung	0-N1472	VB [BT]	S
1.9 D 70	12/98-	DW8, DW8B	1868		0-N1545	VB [DG]	
1.9 D 70	12/98-	DW8	1868	☼, ☼, für Fahrzeuge ohne Servolenkung	0-N1681	VB [BT]	
1.9 D 70	12/98-	DW8B	1868	Orga.→09520; ☼, für Fahrzeuge mit Servolenkung	0-N1747	VB [VD]	
1.9 D 70	12/98-	DW8	1868	☼, für Fahrzeuge mit Servolenkung	0-N1747	VB [VD]	
1.9 D 70	12/98-	DW8B	1868	Orga.09521→; ☼, für Fahrzeuge mit Servolenkung	0-N1945	VB [BT]	S
1.9 D, 1.9 TD	02/96-	D8B (XUD9TE), D9B (XUD9AU), DHX (XUD9TE)	1905		0-N1320	VB [TE]	
1.9 D, 1.9 TD	02/96-	D8B (XUD9TE), D9B (XUD9AU), DHX (XUD9TE)	1905		0-N1472	VB [BT]	S
1.9 D, 1.9 TD	02/96-	D8B (XUD9TE), D9B (XUD9AU), DHX (XUD9TE)	1905		0-N1747	VB [VD]	
1.9 D, 1.9 TD	02/96-	D8B (XUD9TE), D9B (XUD9AU), DHX (XUD9TE)	1905		0-N931	VB [TE]	
2.0	09/02-	RFN (EW10J4)	1997		0-N1391	VB [BT]	S
2.0	09/02-	RFN (EW10J4)	1997	Orga.→10613	0-N1416	VB [DG]	
2.0	09/02-	RFN (EW10J4)	1997	Orga.10614→	0-N2276	VB [DG]	
2.0 HDI	07/00-	RHW (DW10ATED4), RHX (DW10BTED), RHZ (DW10ATED), RHZ (DW10BTED), RHZ (DW10CTED)	1997		0-N1320	VB [TE]	
2.0 HDI	07/00-	RHW (DW10ATED4), RHX (DW10BTED), RHZ (DW10ATED), RHZ (DW10BTED), RHZ (DW10CTED)	1997		0-N1493	VB [BT]	S
2.0 HDI	07/00-	RHW (DW10ATED4), RHX (DW10BTED), RHZ (DW10ATED), RHZ (DW10BTED), RHZ (DW10CTED)	1997	☼	0-N151	VB [DG]	
2.0 HDI	07/00-	RHW (DW10ATED4), RHX (DW10BTED), RHZ (DW10ATED), RHZ (DW10BTED), RHZ (DW10CTED)	1997	☼	0-N1748	VB [BT]	

EXPERT Pritsche/Fahrgestell (223)

1.6	02/96-	222A2 (1580 SPI)	1581	15x138	SK-1031	BTK	
1.9 D	06/98-11/03	WJY (DW8B), WJZ (DW8)	1868	25.4x140; Baumuster: WJZ	SK-1086	BTK	
1.9 D	06/98-11/03	WJY (DW8B), WJZ (DW8)	1868	25.4x140	SK-1086AQ1	BTKW	
1.9 D, 1.9 TD	02/96-	D8B (XUD9TE), D9B (XUD9AU), DHX (XUD9TE)	1905	25.4x136	SK-1022	BTK	
1.9 D, 1.9 TD	02/96-	D8B (XUD9TE), D9B (XUD9AU), DHX (XUD9TE)	1905	25.4x136; 02/1997 →	SK-1022AQ1	BTKW	
1.9 D, 1.9 TD	02/96-	D8B (XUD9TE), D9B (XUD9AU), DHX (XUD9TE)	1905	25.4x136; → 01/1997	SK-1022AQ2	BTKW	
2.0 HDi	10/00-10/06	RHW (DW10ATED4)	1997	25x141; mit Zubehör	SK-1085	BTK	
2.0 HDi	10/00-10/06	RHW (DW10ATED4)	1997	25.4x141; mit Zubehör	SK-1085AQ1	BTKW	
1.6	02/96-	222A2 (1580 SPI)	1581		0-N822	TB [TE]	
1.9 D	06/98-11/03	WJY (DW8B), WJZ (DW8)	1868		0-N118P	TB [TE]	



OPTIMAL®

PEUGEOT



CM³



Art. Nr.



EXPERT Pritsche/Fahrgestell (223)

1.9 D	06/98-11/03	WJY (DW8B), WJZ (DW8)	1868		0-N1381	TB [DG]	
1.9 D, 1.9 TD	02/96-	D8B (XUD9TE), D9B (XUD9AU), DHX (XUD9TE)	1905		0-N900	TB [DG]	
1.9 D, 1.9 TD	02/96-	D8B (XUD9TE), D9B (XUD9AU), DHX (XUD9TE)	1905		0-N901	TB [TE]	
2.0 HDi	10/00-10/06	RHW (DW10ATED4)	1997	Orga.→08560	0-N118P	TB [TE]	
2.0 HDi	10/00-10/06	RHW (DW10ATED4)	1997	Orga.→08560	0-N119P	TB [DG]	
2.0 HDi	10/00-10/06	RHW (DW10ATED4)	1997	Orga.08561→	0-N1381	TB [DG]	
1.9 D	06/98-11/03	DW8, DW8B	1868	☼, für Fahrzeuge mit Servolenkung	0-N1320	VB [TE]	
1.9 D	06/98-11/03	DW8, DW8B	1868	Orga.08375→; für Fahrzeuge mit Servolenkung, ☼	0-N1471	VB [BT]	S
1.9 D	06/98-11/03	DW8B	1868	Orga.→09520; ☼, für Fahrzeuge mit Servolenkung	0-N1472	VB [BT]	S
1.9 D	06/98-11/03	DW8	1868	☼, für Fahrzeuge mit Servolenkung	0-N1472	VB [BT]	S
1.9 D	06/98-11/03	DW8	1868	☼, ☼, für Fahrzeuge ohne Servolenkung	0-N1681	VB [BT]	
1.9 D	06/98-11/03	DW8B	1868	Orga.→09519; ☼, für Fahrzeuge mit Servolenkung	0-N1747	VB [VD]	
1.9 D	06/98-11/03	DW8	1868	☼, für Fahrzeuge mit Servolenkung	0-N1747	VB [VD]	
1.9 D, 1.9 TD	02/96-	D8B (XUD9TE), D9B (XUD9AU), DHX (XUD9TE)	1905		0-N1320	VB [TE]	
1.9 D, 1.9 TD	02/96-	D8B (XUD9TE), D9B (XUD9AU), DHX (XUD9TE)	1905		0-N1472	VB [BT]	S
1.9 D, 1.9 TD	02/96-	D8B (XUD9TE), D9B (XUD9AU), DHX (XUD9TE)	1905		0-N1747	VB [VD]	
1.9 D, 1.9 TD	02/96-	D8B (XUD9TE), D9B (XUD9AU), DHX (XUD9TE)	1905		0-N931	VB [TE]	
2.0 HDi	10/00-10/06	RHZ	1997	☼	0-N1320	VB [TE]	
2.0 HDi	10/00-10/06	RHW (DW10ATED4)	1997		0-N1493	VB [BT]	S
2.0 HDi	10/00-10/06	RHW (DW10ATED4)	1997	☼	0-N151	VB [DG]	
2.0 HDi	10/00-10/06	RHW (DW10ATED4)	1997	☼	0-N1748	VB [BT]	

EXPERT Kasten (VF3A_, VF3U_, VF3X_)

1.6 HDi 90	01/07-	9HU (DV6UTED4)	1560	25x137	SK-1424	BTK	
1.6 HDi 90	01/07-	9HU (DV6UTED4)	1560	25x137	SK-1424AQ1	BTKW	
1.6 HDi 90 8V	01/07-	9HH (DV6DUM), 9HM (DV6UC)	1560	25x141	SK-1728	BTK	
1.6 HDi 90 8V	01/07-	9HH (DV6DUM), 9HM (DV6UC)	1560	25x141	SK-1728AQ1	BTKW	
2.0 16V	01/07-	RFH (EW10A), RFJ (EW10A)	1997	25x153	SK-1600	BTK	
2.0 16V	01/07-	RFH (EW10A), RFJ (EW10A)	1997	25x153	SK-1600AQ1	BTKW	
2.0 HDi 100, 2.0 HDi 130, 2.0 HDi 130 4x4, 2.0 HDi 165	09/09-	AHZ (DW10CD), RHH (DW10CTED4)	1997	25x116	SK-1714AQ1	BTKW	
2.0 HDi 100, 2.0 HDi 130, 2.0 HDi 165	09/09-	AHZ (DW10CD), RHH (DW10CTED4)	1997	25x116	SK-1714	BTK	
2.0 HDi 120, 2.0 HDi 120 4x4, 2.0 HDi 140	01/07-	RHK (DW10UTED4), RHR (DW10BTED4)	1997	25.4x116	SK-1594	BTK	
2.0 HDi 120, 2.0 HDi 120 4x4, 2.0 HDi 140	01/07-	RHK (DW10UTED4), RHR (DW10BTED4)	1997	25.4x116	SK-1594AQ1	BTKW	
1.6 HDi 90	01/07-	9HU (DV6UTED4)	1560		0-N1062	TB [TE]	
1.6 HDi 90	01/07-	9HU (DV6UTED4)	1560		0-N1066	TB [DG]	
1.6 HDi 90 8V	01/07-	9HH (DV6DUM), 9HM (DV6UC)	1560		0-N2224	TB [TE]	
1.6 HDi 90 8V	01/07-	9HH (DV6DUM), 9HM (DV6UC)	1560		0-N2382	TB [DG]	
2.0 16V	01/07-	RFH (EW10A), RFJ (EW10A)	1997		0-N1065	TB [DG]	
2.0 16V	01/07-	RFH (EW10A), RFJ (EW10A)	1997		0-N1343	TB [TE]	
2.0 HDi 100, 2.0 HDi 120, 2.0 HDi 130, 2.0 HDi 140, 2.0 HDi 165	01/07-	AHZ (DW10CD), RHH (DW10CTED4), RHK (DW10UTED4), RHR (DW10BTED4)	1997		0-N1334	TB [DG]	
2.0 HDi 100, 2.0 HDi 130, 2.0 HDi 165	09/09-	AHZ (DW10CD), RHH (DW10CTED4)	1997		0-N2063	TB [TE]	
1.6 HDi 90	01/07-	9HU (DV6UTED4)	1560		0-N1808	VB [BT]	S
1.6 HDi 90, 1.6 HDi 90 8V	01/07-	9HH (DV6DUM), 9HM (DV6UC), 9HU (DV6UTED4)	1560		0-N1807	VB [DG]	
2.0 16V	01/07-	RFH (EW10A), RFJ (EW10A)	1997		0-N1840	VB [BT]	S
2.0 HDi 100, 2.0 HDi 130, 2.0 HDi 165	09/09-	AHZ (DW10CD), RHH (DW10CTED4)	1997		0-N2268	VB [BT]	S
2.0 HDi 120, 2.0 HDi 140	01/07-	RHK (DW10UTED4), RHR (DW10BTED4)	1997		0-N1327	VB [BT]	
2.0 HDi 120, 2.0 HDi 140	01/07-	RHK (DW10UTED4), RHR (DW10BTED4)	1997	Orga.→11073	0-N2037	VB [BT]	S
2.0 HDi 120, 2.0 HDi 140	01/07-	RHK (DW10UTED4), RHR (DW10BTED4)	1997	Orga.11074→	0-N2046	VB [BT]	S

EXPERT Pritsche/Fahrgestell

1.6 HDi 90	01/07-	9HU (DV6UTED4)	1560	25x137	SK-1424	BTK	
1.6 HDi 90	01/07-	9HU (DV6UTED4)	1560	25x137	SK-1424AQ1	BTKW	
2.0 HDi 120	01/07-	RHK (DW10UTED4)	1997	25.4x116; 06/2007 →	SK-1594	BTK	
2.0 HDi 120, 2.0 HDi 140	01/07-	RHK (DW10UTED4), RHR (DW10BTED4)	1997	25.4x116	SK-1594AQ1	BTKW	
2.0 HDi 140	01/07-	RHR (DW10BTED4)	1997	25.4x116	SK-1594	BTK	
1.6 HDi 90	01/07-	9HU (DV6UTED4)	1560		0-N1062	TB [TE]	
1.6 HDi 90	01/07-	9HU (DV6UTED4)	1560		0-N1066	TB [DG]	
2.0 HDi 120, 2.0 HDi 140	01/07-	RHK (DW10UTED4), RHR (DW10BTED4)	1997		0-N1334	TB [DG]	



CM³



Art. Nr.



EXPERT Pritsche/Fahrgestell							
1.6 HDi 90	01/07-	9HU (DV6UTED4)	1560			0-N1807	VB [DG]
1.6 HDi 90	01/07-	9HU (DV6UTED4)	1560			0-N1808	VB [BT] S
2.0 HDi 120, 2.0 HDi 140	01/07-	RHK (DW10UTED4), RHR (DW10BTED4)	1997			0-N1327	VB [BT]
2.0 HDi 120, 2.0 HDi 140	01/07-	RHK (DW10UTED4), RHR (DW10BTED4)	1997	Orga.→11073		0-N2037	VB [BT] S
2.0 HDi 120, 2.0 HDi 140	01/07-	RHK (DW10UTED4), RHR (DW10BTED4)	1997	Orga.11074→		0-N2046	VB [BT] S
EXPERT Tepee (VF3V_)							
1.6 HDi 90	01/07-	9HU (DV6UTED4)	1560	25x137; Baumuster: Expert		SK-1424	BTK
1.6 HDi 90	01/07-	9HU (DV6UTED4)	1560	25x137; Baumuster: Expert Tepee		SK-1424	BTK
1.6 HDi 90	01/07-	9HU (DV6UTED4)	1560	25x137; Baumuster: Expert		SK-1424AQ1	BTKW
1.6 HDi 90	01/07-	9HU (DV6UTED4)	1560	25x137; Baumuster: Expert Tepee		SK-1424AQ1	BTKW
1.6 HDi 90 8V	01/07-	9HH (DV6DUM), 9HM (DV6UC)	1560	25x141		SK-1728	BTK
1.6 HDi 90 8V	01/07-	9HH (DV6DUM), 9HM (DV6UC)	1560	25x141		SK-1728AQ1	BTKW
2.0 16V	01/07-	RFH (EW10A), RFJ (EW10A)	1997	25x153		SK-1600	BTK
2.0 16V	01/07-	RFH (EW10A), RFJ (EW10A)	1997	25x153		SK-1600AQ1	BTKW
2.0 HDi 100, 2.0 HDi 130, 2.0 HDi 165	09/09-	AHY (DW10CE), AHZ (DW10CD), RHH (DW10CTED4)	1997	25x116		SK-1714	BTK
2.0 HDi 100, 2.0 HDi 130, 2.0 HDi 165	09/09-	AHY (DW10CE), AHZ (DW10CD), RHH (DW10CTED4)	1997	25x116		SK-1714AQ1	BTKW
2.0 HDi 120 4x4	01/07-	RHK (DW10UTED4)	1997	25.4x116		SK-1594AQ1	BTKW
2.0 HDi 120, 2.0 HDi 120 4x4, 2.0 HDi 140	01/07-	RHK (DW10UTED4), RHR (DW10BTED4)	1997	25.4x116		SK-1594	BTK
2.0 HDi 120, 2.0 HDi 140	01/07-	RHK (DW10UTED4), RHR (DW10BTED4)	1997	25.4x116; Baumuster: Expert		SK-1594AQ1	BTKW
2.0 HDi 120, 2.0 HDi 140	01/07-	RHK (DW10UTED4), RHR (DW10BTED4)	1997	25.4x116; Baumuster: Expert Tepee		SK-1594AQ1	BTKW
1.6 HDi 90	01/07-	9HU (DV6UTED4)	1560			0-N1062	TB [TE]
1.6 HDi 90	01/07-	9HU (DV6UTED4)	1560			0-N1066	TB [DG]
1.6 HDi 90 8V	01/07-	9HH (DV6DUM), 9HM (DV6UC)	1560			0-N2224	TB [TE]
1.6 HDi 90 8V	01/07-	9HH (DV6DUM), 9HM (DV6UC)	1560			0-N2382	TB [DG]
2.0 16V	01/07-	RFH (EW10A), RFJ (EW10A)	1997			0-N1065	TB [DG]
2.0 16V	01/07-	RFH (EW10A), RFJ (EW10A)	1997			0-N1343	TB [TE]
2.0 HDi 100, 2.0 HDi 120, 2.0 HDi 120 4x4, 2.0 HDi 130, 2.0 HDi 140, 2.0 HDi 165	01/07-	AHY (DW10CE), AHZ (DW10CD), RHH (DW10CTED4), RHK (DW10UTED4), RHR (DW10BTED4)	1997			0-N1334	TB [DG]
2.0 HDi 100, 2.0 HDi 130, 2.0 HDi 165	09/09-	AHY (DW10CE), AHZ (DW10CD), RHH (DW10CTED4)	1997			0-N2063	TB [TE]
1.6 HDi 90	01/07-	9HU (DV6UTED4)	1560			0-N1808	VB [BT] S
1.6 HDi 90, 1.6 HDi 90 8V	01/07-	9HH (DV6DUM), 9HM (DV6UC), 9HU (DV6UTED4)	1560			0-N1807	VB [DG]
2.0 16V	01/07-	RFH (EW10A), RFJ (EW10A)	1997			0-N1840	VB [BT] S
2.0 HDi 100, 2.0 HDi 130, 2.0 HDi 165	09/09-	AHY (DW10CE), AHZ (DW10CD), RHH (DW10CTED4)	1997			0-N2268	VB [BT] S
2.0 HDi 120, 2.0 HDi 120 4x4, 2.0 HDi 140	01/07-	RHK (DW10UTED4), RHR (DW10BTED4)	1997			0-N1327	VB [BT]
2.0 HDi 120, 2.0 HDi 120 4x4, 2.0 HDi 140	01/07-	RHK (DW10UTED4), RHR (DW10BTED4)	1997	Orga.→11073		0-N2037	VB [BT] S
2.0 HDi 120, 2.0 HDi 120 4x4, 2.0 HDi 140	01/07-	RHK (DW10UTED4), RHR (DW10BTED4)	1997	Orga.11074→		0-N2046	VB [BT] S
J5 Bus (280P)							
2.5 D	09/81-09/90	CRD93 (U25/661)	2498	32x118		SK-1018S	BTK
2.5 D	09/81-09/90	CRD93 (U25/661)	2498			0-N815	TB [TE]
2.5 D	09/81-09/90	CRD93 (U25/661)	2498			0-N822	TB [TE]
J5 Kasten (280L)							
1.9 D	09/87-08/90	D9B (XUD9A), XUD9	1905	25.39x136		SK-1007	BTK
2.5 D	09/81-08/90	CRD93	2498	32x118		SK-1018S	BTK
2.5 D, 2.5 DT	09/81-08/90	CRD93, CRD93L, CRD93LS (U25/673)	2498			0-N822	TB [TE]
J5 Pritsche/Fahrgestell (280L)							
2.5 D	09/81-09/90	CRD93 (U25/661)	2500	32x118		SK-1018S	BTK
2.5 D	09/81-09/90	CRD93 (U25/661)	2500			0-N815	TB [TE]
2.5 D	09/81-09/90	CRD93 (U25/661)	2500			0-N822	TB [TE]
2.5 D 4x4, 2.5 DT	09/81-08/90	CRD93, CRD93L	2498			0-N822	TB [TE]
J5 Bus (290P)							
1.9 D	10/90-02/94	D9B (XUD9A)	1905	25.39x136		SK-1007	BTK
1.9 D	10/90-02/94	D9B (XUD9A)	1905	25.4x136; → 01/1994		SK-1007AQ1	BTKW
1.9 D	10/90-02/94	D9B (XUD9A)	1905	25.4x136; 02/1994 →		SK-1022	BTK
1.9 D	10/90-02/94	D9B (XUD9A)	1905	25.4x136; 02/1994 →		SK-1022AQ2	BTKW
2.5 D, 2.5 D 4x4, 2.5 TD, 2.5 TD 4x4	10/90-02/94	CRD93 (U25/661), CRD93LS (U25/673)	2500	32x118		SK-1018S	BTK
1.9 D	10/90-02/94	D9B (XUD9A)	1905	→ 01/1994		0-N813	TB [TE]
1.9 D	10/90-02/94	D9B (XUD9A)	1905	→ 01/1994		0-N814	TB [DG]
1.9 D	10/90-02/94	D9B (XUD9A)	1905	02/1994 →		0-N900	TB [DG]
1.9 D	10/90-02/94	D9B (XUD9A)	1905	02/1994 →		0-N901	TB [TE]



CM³



Art. Nr.



ohne Halter

J5 Bus (290P)							
2.5 D, 2.5 D 4x4, 2.5 TD, 2.5 TD 4x4	10/90-02/94	CRD93 (U25/661), CRD93LS (U25/673)	2500			0-N815	TB [TE]
2.5 D, 2.5 D 4x4, 2.5 TD, 2.5 TD 4x4	10/90-02/94	CRD93 (U25/661), CRD93LS (U25/673)	2500			0-N822	TB [TE]
J5 Kasten (290L)							
1.9 D	10/90-03/94	D9B (XUD9A)	1905	25.39x136		SK-1007	BTK
1.9 D	10/90-03/94	D9B (XUD9A)	1905	25.4x136; → 01/1994		SK-1007AQ1	BTKW
1.9 D	10/90-03/94	D9B (XUD9A)	1905	25.4x136; 02/1994 →		SK-1022	BTK
1.9 D	10/90-03/94	D9B (XUD9A)	1905	25.4x136; 02/1994 →		SK-1022AQ2	BTKW
2.5 D	09/90-01/94	CRD93	2498	32x118		SK-1018S	BTK
2.5 D 4x4, 2.5 TD 4x4	10/90-03/94	CRD93 (U25/661), CRD93LS (U25/673)	2500	32x118		SK-1018S	BTK
1.9 D	10/90-03/94	D9B (XUD9A)	1905	→ 01/1994		0-N813	TB [TE]
1.9 D	10/90-03/94	D9B (XUD9A)	1905	→ 01/1994		0-N814	TB [DG]
1.9 D	10/90-03/94	D9B (XUD9A)	1905	02/1994 →		0-N900	TB [DG]
1.9 D	10/90-03/94	D9B (XUD9A)	1905	02/1994 →		0-N901	TB [TE]
2.5 D 4x4, 2.5 TD 4x4	10/90-03/94	CRD93 (U25/661), CRD93LS (U25/673)	2500			0-N815	TB [TE]
2.5 D 4x4, 2.5 TD 4x4	10/90-03/94	CRD93 (U25/661), CRD93LS (U25/673)	2500			0-N822	TB [TE]
2.5 D, 2.5 DT	09/90-01/94	CRD93, CRD93L	2498			0-N822	TB [TE]
J5 Pritsche/Fahrgestell (290L)							
1.9 D	10/90-02/94	D9B (XUD9A)	1905	25.39x136		SK-1007	BTK
1.9 D	10/90-02/94	D9B (XUD9A)	1905	25.4x136; → 01/1994		SK-1007AQ1	BTKW
1.9 D	10/90-02/94	D9B (XUD9A)	1905	25.4x136; 02/1994 →		SK-1022	BTK
1.9 D	10/90-02/94	D9B (XUD9A)	1905	25.4x136; 02/1994 →		SK-1022AQ2	BTKW
2.5 D, 2.5 D 4x4, 2.5 TD, 2.5 TD 4x4	10/90-02/94	CRD93 (U25/661), CRD93LS (U25/673)	2500	32x118		SK-1018S	BTK
1.9 D	10/90-02/94	D9B (XUD9A)	1905	→ 01/1994		0-N813	TB [TE]
1.9 D	10/90-02/94	D9B (XUD9A)	1905	→ 01/1994		0-N814	TB [DG]
1.9 D	10/90-02/94	D9B (XUD9A)	1905	02/1994 →		0-N900	TB [DG]
1.9 D	10/90-02/94	D9B (XUD9A)	1905	02/1994 →		0-N901	TB [TE]
2.5 D, 2.5 D 4x4, 2.5 TD, 2.5 TD 4x4	10/90-02/94	CRD93 (U25/661), CRD93LS (U25/673)	2500			0-N815	TB [TE]
2.5 D, 2.5 D 4x4, 2.5 TD, 2.5 TD 4x4	10/90-02/94	CRD93 (U25/661), CRD93LS (U25/673)	2500			0-N822	TB [TE]
PARTNER Combispace (5F)							
1.1	06/96-	TU1JP	1124	17x104; 09/2000 → 07/2001; →3762433; Orga. →9008		SK-1003	BTK
1.1	06/96-	TU1M	1124	17x104		SK-1003AQ1	BTKW
1.1	06/96-	TU1JP	1124	17x104; →3762434		SK-1003AQ1	BTKW
1.1	06/96-	HDZ (TU1M), HFX (TU1JP)	1124	17x100; 07/2001 →; :3762434 →		SK-1353	BTK
1.1	06/96-	HDZ (TU1M), HFX (TU1JP)	1124	17x100; 11/2002 →; :3762434 →		SK-1353	BTK
1.1	06/96-	TU1JP	1124	17x100; :3762434 →		SK-1353AQ1	BTKW
1.4	06/96-10/06	KFW (TU3JP), KFX (TU3JP), KFX (TU3JP), TU32	1360	17x108; →3666765		SK-1004	BTK
1.4	06/96-	KFW (TU3JP), KFX (TU3JP), TU32	1360	17x108; →3666766		SK-1004AQ1	BTKW
1.4	06/96-10/06	KFW (TU3JP), KFX (TU3JP), KFX (TU3JP), TU32	1360	17x104; :3666766 →		SK-1354	BTK
1.4	06/96-10/06	KFW (TU3JP), KFX (TU3JP), KFX (TU3JP), TU32	1360	17x104; :3666766 →		SK-1354AQ1	BTKW
1.4	11/02-10/06	KFW (TU3JP)	1360	17x108; →3666765		SK-1004AQ1	BTKW
1.6 16V	07/01-	NFU (TU5JP4)	1587	25.4x134; → 03/2008; →1806404; mit Zubehör		SK-1392	BTK
1.6 16V	07/01-	NFU (TU5JP4)	1587	25.4x134; → 08/2007; mit Zubehör		SK-1392	BTK
1.6 16V	07/01-	NFU (TU5JP4)	1587	25.4x134; → 09/2005; →1806404; mit Zubehör		SK-1392	BTK
1.6 16V	07/01-	NFU (TU5JP4)	1587	25.4x134; →1806404; mit Zubehör		SK-1392AQ1	BTKW
1.6 16V	07/01-	NFU (TU5JP4)	1587	25.4x134; → 03/2008; :1806405 →		SK-1615	BTK
1.6 16V	07/01-	NFU (TU5JP4)	1587	25.4x134; :1806405 →		SK-1615AQ1	BTKW
1.6 HDi 75, 1.6 HDi 90	10/05-	9HW (DV6BTED4), 9HX (DV6ATED4)	1560	25x137		SK-1424	BTK
1.6 HDi 75, 1.6 HDi 90	10/05-	9HW (DV6BTED4), 9HX (DV6ATED4)	1560	25x137		SK-1424AQ1	BTKW
1.8	05/97-	LFX (XU7JB)	1761	17x114		SK-1019	BTK
1.9 D	05/96-12/98	DJY (XUD9A), XUD9	1905	25.4x136		SK-1022	BTK
1.9 D	05/96-12/98	DJY (XUD9A), XUD9	1905	25.4x136; 02/1997 →		SK-1022AQ1	BTKW
1.9 D	05/96-12/98	DJY (XUD9A), XUD9	1905	25.4x136; → 01/1997		SK-1022AQ2	BTKW
1.9 D	12/98-	WJY (DW8B), WJZ (DW8)	1868	25.4x140		SK-1086	BTK
1.9 D	12/98-	WJY (DW8B), WJZ (DW8)	1868	25.4x140		SK-1086AQ1	BTKW
1.9 D 4x4	04/04-08/05	WJY (DW8B)	1868	25.4x140; Baumuster: WJY		SK-1086	BTK
1.9 D 4x4	04/04-08/05	DW8	1868	25.4x140		SK-1086AQ1	BTKW
2.0 HDI	02/00-	RHY (DW10TD)	1997	25x141; → 10/2000; Orga. →8735; mit Zubehör		SK-1085	BTK
2.0 HDi 4x4	04/04-08/05	RHY (DW10TD)	1997	25x141; mit Zubehör		SK-1085	BTK
2.0 HDI, 2.0 HDi 4x4	02/00-08/05	RHY (DW10TD)	1997	25.4x141; mit Zubehör		SK-1085AQ1	BTKW

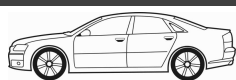

CM³



Art. Nr.



PARTNER Combispace (5F)

1.1	06/96-	TU1JP	1124	→:3762434→	0-N1277	TB [TE]	
1.1	06/96-	TU1M	1124		0-N811	TB [TE]	
1.1	06/96-	TU1JP	1124	→:3762433	0-N811	TB [TE]	
1.4	06/96-	KFW (TU3JP), KFX (TU3JP), TU32	1360	→:3666766→	0-N1277	TB [TE]	
1.4	06/96-	KFW (TU3JP), KFX (TU3JP), TU32	1360	→:3666765	0-N811	TB [TE]	
1.4	11/02-10/06	KFW (TU3JP)	1360		0-N1277	TB [TE]	
1.6 16V	07/01-	NFU (TU5JP4)	1587	→:1806404	0-N1061	TB [TE]	
1.6 16V	07/01-	NFU (TU5JP4)	1587	→:1806404	0-N122	TB [DG]	
1.6 16V	07/01-	NFU (TU5JP4)	1587	→:1806405→	0-N1359	TB [TE]	
1.6 16V	07/01-	NFU (TU5JP4)	1587	→:1806405→	0-N1360	TB [DG]	
1.6 HDi 75, 1.6 HDi 90	10/05-	9HW (DV6BTED4), 9HX (DV6ATED4)	1560		0-N1062	TB [TE]	
1.6 HDi 75, 1.6 HDi 90	10/05-	9HW (DV6BTED4), 9HX (DV6ATED4)	1560		0-N1066	TB [DG]	
1.8	05/97-	LFX (XU7JB)	1761		0-N811	TB [TE]	
1.9 D	05/96-12/98	DJY (XUD9A), XUD9	1905		0-N900	TB [DG]	
1.9 D	05/96-12/98	DJY (XUD9A), XUD9	1905		0-N901	TB [TE]	
1.9 D	12/98-	WJY (DW8B), WJZ (DW8)	1868		0-N1381	TB [DG]	
1.9 D 4x4	04/04-08/05	DW8	1868		0-N1381	TB [DG]	
1.9 D, 1.9 D 4x4	12/98-08/05	WJY (DW8B), WJY (DW8B), WJZ (DW8)	1868		0-N118P	TB [TE]	
2.0 HDi, 2.0 HDi 4x4	02/00-08/05	RHY (DW10TD)	1997	Orga.→08735	0-N118P	TB [TE]	
2.0 HDi, 2.0 HDi 4x4	02/00-08/05	RHY (DW10TD)	1997	Orga.→08735	0-N119P	TB [DG]	
2.0 HDi, 2.0 HDi 4x4	02/00-08/05	RHY (DW10TD)	1997	Orga.08736→	0-N1381	TB [DG]	
1.1	06/96-	HDZ (TU1M), HFX (TU1JP)	1124	→ 12/2001	0-N125	VB [TE]	S
1.1	06/96-	HDZ (TU1M), HFX (TU1JP)	1124	01/2002 →; *	0-N1419	VB [DG]	
1.1	06/96-	HDZ (TU1M), HFX (TU1JP)	1124	01/2002 →; *	0-N1620	VB [BT]	S
1.1	06/96-	HDZ (TU1M), HFX (TU1JP)	1124	01/2002 →	0-N1949	VB [TE]	
1.4	06/96-	KFW (TU3JP), KFX (TU3JP), TU32	1360	→ 12/2001	0-N125	VB [TE]	S
1.4	06/96-	KFW (TU3JP), KFX (TU3JP), TU32	1360	01/2002 →; *	0-N1419	VB [DG]	
1.4	06/96-	KFW (TU3JP), KFX (TU3JP), TU32	1360	01/2002 →	0-N1620	VB [BT]	S
1.4	06/96-	KFW (TU3JP), KFX (TU3JP), TU32	1360	01/2002 →	0-N1949	VB [TE]	
1.4	11/02-10/06	KFW (TU3JP)	1360	*	0-N1419	VB [DG]	
1.4	11/02-10/06	KFW (TU3JP)	1360	*	0-N1620	VB [BT]	S
1.4	11/02-10/06	KFW (TU3JP)	1360		0-N1949	VB [TE]	
1.6 16V	07/01-	NFU (TU5JP4)	1587	Orga.→12110; *	0-N1419	VB [DG]	
1.6 16V	07/01-	NFU (TU5JP4)	1587	*	0-N1620	VB [BT]	S
1.6 16V	07/01-	NFU (TU5JP4)	1587	Orga.12110→; *	0-N1874	VB [BT]	S
1.6 16V	07/01-	NFU (TU5JP4)	1587		0-N1949	VB [TE]	
1.6 16V	07/01-	NFU (TU5JP4)	1587	Orga.12110→; *	0-N2191	VB [DG]	
1.6 HDi 75	02/06-	9HW (DV6BTED4)	1560	Orga.→10570	0-N1418	VB [DG]	
1.6 HDi 75, 1.6 HDi 90	10/05-	9HW (DV6BTED4), 9HX (DV6ATED4)	1560	Orga.→10570; *	0-N1420	VB [DG]	
1.6 HDi 75, 1.6 HDi 90	10/05-	9HW (DV6BTED4), 9HX (DV6ATED4)	1560	Orga.→10570	0-N1636	VB [BT]	S
1.6 HDi 75, 1.6 HDi 90	10/05-	9HW (DV6BTED4), 9HX (DV6ATED4)	1560	Orga.10571→	0-N1807	VB [DG]	
1.6 HDi 75, 1.6 HDi 90	10/05-	9HW (DV6BTED4), 9HX (DV6ATED4)	1560	Orga.10571→	0-N1808	VB [BT]	S
1.6 HDi 90	10/05-	9HX (DV6ATED4)	1560		0-N1418	VB [DG]	
1.8	05/97-	LFX (XU7JB)	1761	Orga.07510FV, 08028FL→	0-N124	VB [TE]	
1.8	05/97-	LFX (XU7JB)	1761	Generator-Ladestrom [A]: 90; *	0-N1402	VB [DG]	S
1.8	05/97-	LFX (XU7JB)	1761	Orga.0812077→; *	0-N1413	VB [DG]	
1.8	05/97-	LFX (XU7JB)	1761	Generator-Ladestrom [A]: 120; *	0-N1465S	VB [DG]	
1.8	05/97-	LFX (XU7JB)	1761	*	0-N1484	VB [BT]	S
1.8	05/97-	LFX (XU7JB)	1761	Orga.0812077→; *	0-N1968	VB [BT]	
1.9 D	05/96-12/98	DJY (XUD9A), XUD9	1905		0-N1320	VB [TE]	
1.9 D	05/96-12/98	XUD9	1905	*	0-N1472	VB [BT]	S
1.9 D	05/96-12/98	XUD9	1905	*	0-N1747	VB [VD]	
1.9 D	05/96-12/98	DJY (XUD9A), XUD9	1905		0-N931	VB [TE]	
1.9 D	06/96-	DJY (XUD9A)	1905		0-N1472	VB [BT]	S
1.9 D	06/96-	DJY (XUD9A)	1905		0-N1747	VB [VD]	
1.9 D	12/98-	DW8B	1868	für Fahrzeuge mit Servolenkung	0-N1309	VB [DG]	
1.9 D	12/98-	DW8	1868	Orga.08400→; für Fahrzeuge mit Servolenkung	0-N1309	VB [DG]	
1.9 D	12/98-	DW8	1868	Orga.→08399	0-N1455	VB [TE]	
1.9 D	12/98-	DW8, DW8B	1868	Orga.08400→; für Fahrzeuge mit Servolenkung, *	0-N1471	VB [BT]	S
1.9 D	12/98-	WJY (DW8B), WJZ (DW8)	1868	Orga.→09610; *, für Fahrzeuge mit Servolenkung	0-N1472	VB [BT]	S
1.9 D	12/98-	WJY (DW8B), WJZ (DW8)	1868	*, *, für Fahrzeuge ohne Servolenkung	0-N1681	VB [BT]	
1.9 D	12/98-	WJY (DW8B), WJZ (DW8)	1868	Orga.→09610; *, für Fahrzeuge mit Servolenkung	0-N1747	VB [VD]	



OPTIMAL®

PEUGEOT



CM³



Art. Nr.



ohne Halter

PARTNER Combispacer (5F)

1.9 D	12/98-	WJY (DW8B), WJZ (DW8)	1868	Orga.09611→; für Fahrzeuge mit Servolenkung	0-N1945	VB [BT]	S
1.9 D 4x4	04/04-08/05	WJY (DW8B)	1868	für Fahrzeuge mit Servolenkung	0-N1309	VB [DG]	
1.9 D 4x4	04/04-08/05	DW8	1868	Orga.08400→; für Fahrzeuge mit Servolenkung,	0-N1471	VB [BT]	S
1.9 D 4x4	04/04-08/05	DW8	1868	für Fahrzeuge mit Servolenkung	0-N1472	VB [BT]	S
1.9 D 4x4	04/04-08/05	DW8	1868	für Fahrzeuge ohne Servolenkung	0-N1681	VB [BT]	
1.9 D 4x4	04/04-08/05	DW8	1868	für Fahrzeuge mit Servolenkung	0-N1747	VB [VD]	
1.9 D, 1.9 D 4x4	12/98-08/05	WJY (DW8B), WJY (DW8B), WJZ (DW8)	1868		0-N1320	VB [TE]	
1.9 D, 1.9 D 4x4	12/98-08/05	WJY (DW8B), WJY (DW8B), WJZ (DW8)	1868		0-N1545	VB [DG]	
2.0 HDi, 2.0 HDi 4x4	02/00-08/05	RHY (DW10TD)	1997		0-N1320	VB [TE]	
2.0 HDi, 2.0 HDi 4x4	02/00-08/05	RHY (DW10TD)	1997		0-N1493	VB [BT]	S
2.0 HDi, 2.0 HDi 4x4	02/00-08/05	RHY (DW10TD)	1997		0-N151	VB [DG]	
2.0 HDi, 2.0 HDi 4x4	02/00-08/05	RHY (DW10TD)	1997		0-N1748	VB [BT]	

PARTNER Kasten (5)

1.1	06/96-	HDZ (TU1M)	1124	17x104; → 07/2001; →3762433; Orga.→9008	SK-1003	BTK	
1.1	06/96-	HDZ (TU1M)	1124	17x104; → 07/2001; →3762433; Orga.→09008	SK-1003AQ1	BTKW	
1.1	06/96-	HDZ (TU1M)	1124	17x100; 07/2001 →; :3762434 →	SK-1353	BTK	
1.1	06/96-	HDZ (TU1M)	1124	17x100; 07/2001 →; :3762434 →	SK-1353AQ1	BTKW	
1.4	06/96-	KFX (TU3JP), TU32	1360	17x108; →3666765	SK-1004	BTK	
1.4	06/96-	KFX (TU3JP), TU32	1360	17x104; :3666766 →	SK-1354	BTK	
1.4	06/96-	KFX (TU3JP), TU32	1360	17x104; :3666766 →	SK-1354AQ1	BTKW	
1.4 BiFuel	04/03-	KFW (TU3JP)	1360	17x104	SK-1354	BTK	
1.4 BiFuel	04/03-	KFW (TU3JP)	1360	17x104	SK-1354AQ1	BTKW	
1.4, 1.4 BiFuel	06/96-	KFW (TU3JP), KFX (TU3JP), TU32	1360	17x108; →3666766	SK-1004AQ1	BTKW	
1.6	09/00-10/02	NFU (TU5JP4)	1587	25.4x134; →1806404; mit Zubehör	SK-1392	BTK	
1.6	09/00-10/02	NFU (TU5JP4)	1587	25.4x134; →1806404; mit Zubehör	SK-1392AQ1	BTKW	
1.6	09/00-10/02	NFU (TU5JP4)	1587	25.4x134; :1806405 →	SK-1615	BTK	
1.6	09/00-10/02	NFU (TU5JP4)	1587	25.4x134; Orga.1125478 →	SK-1615AQ1	BTKW	
1.6 HDi 75, 1.6 HDi 90	02/06-	9HW (DV6BTED4), 9HX (DV6ATED4)	1560	25x137; Baumuster: Ranch	SK-1424	BTK	
1.6 HDi 75, 1.6 HDi 90	02/06-	9HW (DV6BTED4), 9HX (DV6ATED4)	1560	25x137; Baumuster: Ranch	SK-1424AQ1	BTKW	
1.8 D	06/96-02/98	A9A (XUD7)	1769	25.4x136; Baumuster: A9A	SK-1022	BTK	
1.8 D	06/96-02/98	A9A (XUD7)	1769	25.4x136; 02/1997 →	SK-1022AQ1	BTKW	
1.8 D	06/96-	A9A (XUD7)	1769	25.4x136; → 01/1997	SK-1022AQ2	BTKW	
1.9 D	05/96-12/98	DJY (XUD9A)	1905	25.4x136	SK-1022	BTK	
1.9 D	05/96-12/98	DJY (XUD9A)	1905	25.4x136; 02/1997 →	SK-1022AQ1	BTKW	
1.9 D	05/96-12/98	DJY (XUD9A)	1905	25.4x136; → 01/1997	SK-1022AQ2	BTKW	
1.9 D	06/96-	WJY (DW8B), WJZ (DW8)	1868	25.4x140	SK-1086	BTK	
1.9 D 4x4	04/04-	WJY (DW8B)	1868	25.4x140; Baumuster: WJY	SK-1086	BTK	
1.9 D, 1.9 D 4x4	06/96-	WJY (DW8B), WJY (DW8B), WJZ (DW8)	1868	25.4x140	SK-1086AQ1	BTKW	
2.0 HDi	04/00-	RHY (DW10TD)	1997	25x141; → 10/2000; Orga.→8735; mit Zubehör	SK-1085	BTK	
2.0 HDi 4x4	04/04-	RHY (DW10TD)	1997	25x141; → 06/2005; mit Zubehör	SK-1085	BTK	
2.0 HDi, 2.0 HDi 4x4	04/00-	RHY (DW10TD)	1997	25.4x141; mit Zubehör	SK-1085AQ1	BTKW	
1.1	06/96-	HDZ (TU1M)	1124	:3762434 →	0-N1277	TB [TE]	
1.1	06/96-	HDZ (TU1M)	1124	:→3762433	0-N811	TB [TE]	
1.4	11/02-10/06	KFV (TU3A)	1360		0-N1277	TB [TE]	
1.4, 1.4 BiFuel	06/96-	KFW (TU3JP), KFX (TU3JP), TU32	1360	:3666766 →	0-N1277	TB [TE]	
1.4, 1.4 BiFuel	06/96-	KFW (TU3JP), KFX (TU3JP), TU32	1360	:→3666765	0-N811	TB [TE]	
1.6	09/00-10/02	NFU (TU5JP4)	1587	:1806405 →	0-N1359	TB [TE]	
1.6	09/00-10/02	NFU (TU5JP4)	1587	:1806405 →	0-N1360	TB [DG]	
1.6 HDi 75, 1.6 HDi 90	02/06-	9HW (DV6BTED4), 9HX (DV6ATED4)	1560		0-N1062	TB [TE]	
1.6 HDi 75, 1.6 HDi 90	02/06-	9HW (DV6BTED4), 9HX (DV6ATED4)	1560		0-N1066	TB [DG]	
1.8	03/97-08/00	LFX (XU7JB)	1761		0-N811	TB [TE]	
1.8 D	06/96-02/98	A9A (XUD7)	1769		0-N900	TB [DG]	
1.8 D	06/96-02/98	A9A (XUD7)	1769		0-N901	TB [TE]	
1.9 D	05/96-12/98	DJY (XUD9A)	1905		0-N900	TB [DG]	
1.9 D	05/96-12/98	DJY (XUD9A)	1905		0-N901	TB [TE]	
1.9 D, 1.9 D 4x4	06/96-	WJY (DW8B), WJY (DW8B), WJZ (DW8)	1868		0-N118P	TB [TE]	
1.9 D, 1.9 D 4x4	06/96-	WJY (DW8B), WJY (DW8B), WJZ (DW8)	1868		0-N1381	TB [DG]	
2.0 HDi, 2.0 HDi 4x4	04/00-	RHY (DW10TD)	1997	Orga.→08735	0-N118P	TB [TE]	
2.0 HDi, 2.0 HDi 4x4	04/00-	RHY (DW10TD)	1997	Orga.→08735	0-N119P	TB [DG]	
2.0 HDi, 2.0 HDi 4x4	04/00-	RHY (DW10TD)	1997	Orga.08736 →	0-N1381	TB [DG]	
1.1	06/96-	HDZ (TU1M)	1124	→ 12/2001	0-N125	VB [TE]	S



CM³



Art. Nr.



ohne Halter

PARTNER Kasten (5)

1.1	06/96-	HDZ (TU1M)	1124	01/2002 →; ⚡	0-N1419	VB [DG]	
1.1	06/96-	HDZ (TU1M)	1124	01/2002 →; ⚡	0-N1620	VB [BT]	S
1.1	06/96-	HDZ (TU1M)	1124	01/2002 →	0-N1949	VB [TE]	
1.4	06/96-	KFX (TU3JP), TU32	1360	→ 12/2001	0-N125	VB [TE]	S
1.4	06/96-	KFX (TU3JP), TU32	1360	01/2002 →; ⚡	0-N1419	VB [DG]	
1.4	06/96-	KFX (TU3JP), TU32	1360	01/2002 →; ⚡	0-N1620	VB [BT]	S
1.4	06/96-	KFX (TU3JP), TU32	1360	01/2002 →	0-N1949	VB [TE]	
1.4 BiFuel	04/03-	KFW (TU3JP)	1360		0-N1949	VB [TE]	
1.4, 1.4 BiFuel	11/02-10/06	KFV (TU3A), KFW (TU3JP)	1360	⚡	0-N1419	VB [DG]	
1.4, 1.4 BiFuel	11/02-10/06	KFV (TU3A), KFW (TU3JP)	1360	⚡	0-N1620	VB [BT]	S
1.6	09/00-10/02	NFU (TU5JP4)	1587	⚡	0-N1419	VB [DG]	
1.6	09/00-10/02	NFU (TU5JP4)	1587	⚡	0-N1620	VB [BT]	S
1.6 HDi 75	02/06-	9HW (DV6BTED4)	1560	Orga.→10570	0-N1418	VB [DG]	
1.6 HDi 75, 1.6 HDi 90	02/06-	9HW (DV6BTED4), 9HX (DV6ATED4)	1560	Orga.→10570; ⚡	0-N1420	VB [DG]	
1.6 HDi 75, 1.6 HDi 90	02/06-	9HW (DV6BTED4), 9HX (DV6ATED4)	1560	Orga.→10570	0-N1636	VB [BT]	S
1.6 HDi 75, 1.6 HDi 90	02/06-	9HW (DV6BTED4), 9HX (DV6ATED4)	1560	Orga.10571→	0-N1807	VB [DG]	
1.6 HDi 75, 1.6 HDi 90	02/06-	9HW (DV6BTED4), 9HX (DV6ATED4)	1560	Orga.10571→	0-N1808	VB [BT]	S
1.6 HDi 90	02/06-	9HX (DV6ATED4)	1560		0-N1418	VB [DG]	
1.8	03/97-08/00	LFX (XU7JB)	1761	Generator-Ladestrom [A]: 90; ⚡	0-N1402	VB [DG]	S
1.8	03/97-08/00	LFX (XU7JB)	1761	⚡	0-N1413	VB [DG]	
1.8 D	06/96-02/98	A9A (XUD7)	1769		0-N1320	VB [TE]	
1.8 D	06/96-02/98	A9A (XUD7)	1769		0-N1472	VB [BT]	S
1.8 D	06/96-02/98	A9A (XUD7)	1769		0-N1747	VB [VD]	
1.8 D	06/96-	A9A (XUD7)	1769		0-N931	VB [TE]	
1.9 D	05/96-12/98	DJY (XUD9A)	1905		0-N1320	VB [TE]	
1.9 D	05/96-12/98	DJY (XUD9A)	1905		0-N1472	VB [BT]	S
1.9 D	05/96-12/98	DJY (XUD9A)	1905		0-N1747	VB [VD]	
1.9 D	06/96-	DW8B	1868	für Fahrzeuge mit Servolenkung	0-N1309	VB [DG]	
1.9 D	06/96-	DW8	1868	Orga.08400→; für Fahrzeuge mit Servolenkung	0-N1309	VB [DG]	
1.9 D	06/96-	DW8	1868	Orga.→08399	0-N1455	VB [TE]	
1.9 D	06/96-	DW8, DW8B	1868	Orga.08400→; für Fahrzeuge mit Servolenkung, ⚡	0-N1471	VB [BT]	S
1.9 D	06/96-	DJY (XUD9A)	1905		0-N931	VB [TE]	
1.9 D 4x4	04/04-	WJY (DW8B)	1868	für Fahrzeuge mit Servolenkung	0-N1309	VB [DG]	
1.9 D 4x4	04/04-	WJY (DW8B)	1868	für Fahrzeuge mit Servolenkung, ⚡	0-N1471	VB [BT]	S
1.9 D, 1.9 D 4x4	06/96-	WJY (DW8B), WJY (DW8B), WJZ (DW8)	1868		0-N1320	VB [TE]	
1.9 D, 1.9 D 4x4	06/96-	WJY (DW8B), WJY (DW8B), WJZ (DW8)	1868	Orga.→09610; ⚡, für Fahrzeuge mit Servolenkung	0-N1472	VB [BT]	S
1.9 D, 1.9 D 4x4	06/96-	WJY (DW8B), WJY (DW8B), WJZ (DW8)	1868		0-N1545	VB [DG]	
1.9 D, 1.9 D 4x4	06/96-	WJY (DW8B), WJY (DW8B), WJZ (DW8)	1868	⚡, ⚡, für Fahrzeuge ohne Servolenkung	0-N1681	VB [BT]	
1.9 D, 1.9 D 4x4	06/96-	WJY (DW8B), WJY (DW8B), WJZ (DW8)	1868	Orga.→09610; ⚡, für Fahrzeuge mit Servolenkung	0-N1747	VB [VD]	
1.9 D, 1.9 D 4x4	06/96-	WJY (DW8B), WJY (DW8B), WJZ (DW8)	1868	Orga.09611→; ⚡, für Fahrzeuge mit Servolenkung	0-N1945	VB [BT]	S
2.0 HDi	04/00-	RHY (DW10TD)	1997		0-N1320	VB [TE]	
2.0 HDi 4x4	04/04-	RHY (DW10TD)	1997	⚡	0-N1320	VB [TE]	
2.0 HDi, 2.0 HDi 4x4	04/00-	RHY (DW10TD)	1997		0-N1493	VB [BT]	S
2.0 HDi, 2.0 HDi 4x4	04/00-	RHY (DW10TD)	1997	⚡	0-N151	VB [DG]	
2.0 HDi, 2.0 HDi 4x4	04/00-	RHY (DW10TD)	1997	⚡	0-N1748	VB [BT]	

PARTNER Kasten

1.6	04/08-	NFR (TU5JP4B), NFU (TU5JP4)	1587	25.4x134	SK-1615	BTK	
1.6	04/08-	NFR (TU5JP4B), NFU (TU5JP4)	1587	25.4x134	SK-1615AQ1	BTKW	
1.6	04/10-	5FS (EP6C)	1598	25.4x134	SK-1615	BTK	
1.6	04/10-	5FS (EP6C)	1598	25.4x134	SK-1615AQ1	BTKW	
1.6 BlueHdi 75	01/15-	DV6ETED, DV6ETED4	1560	25x141	SK-1728	BTK	
1.6 BlueHdi 75	01/15-	DV6ETEDM	1560	25x141	SK-1728	BTK	
1.6 BlueHdi 75	01/15-	DV6ETED, DV6ETED4	1560	25x141	SK-1728AQ1	BTKW	
1.6 BlueHdi 75	01/15-	DV6ETEDM	1560	25x141	SK-1728AQ1	BTKW	
1.6 HDi	04/08-	9HT (DV6BUTED4)	1560	25x137	SK-1424	BTK	
1.6 HDi	04/08-	9HT (DV6BUTED4)	1560	25x137	SK-1424AQ1	BTKW	
1.6 HDi, 1.6 HDi 4x4	04/08-	9HS (DV6TED4BU), 9HX (DV6ATED4), 9HZ (DV6TED4)	1560	25x137	SK-1424	BTK	
1.6 HDi, 1.6 HDi 4x4	04/08-	9HS (DV6TED4BU), 9HX (DV6ATED4), 9HZ (DV6TED4)	1560	25x137	SK-1424AQ1	BTKW	
1.6 HDi, 1.6 HDi 90	04/10-	9HF (DV6DTED), 9HL (DV6C), 9HP (DV6DTED)	1560	25x141	SK-1728	BTK	

CM³

Art. Nr.

**PARTNER Kasten**

1.6 HDi, 1.6 HDi 90	04/10-	9HF (DV6DTED), 9HL (DV6C), 9HP (DV6DTED)	1560	25x141		SK-1728AQ1	BTKW
1.6	04/08-	NFR (TU5JP4B), NFU (TU5JP4)	1587			0-N1359	TB [TE]
1.6	04/08-	NFR (TU5JP4B), NFU (TU5JP4)	1587			0-N1360	TB [DG]
1.6 BlueHdi 100, 1.6 BlueHdi 120, 1.6 HDi, 1.6 HDi 90	04/10-	9HF (DV6DTED), 9HL (DV6C), 9HP (DV6DTED), BHY (DV6FD), BHZ (DV6FC)	1560			0-N2382	TB [DG]
1.6 HDi	04/08-	9HS (DV6TED4BU), 9HX (DV6ATED4), 9HT (DV6BTED4), 9HW (DV6BTED4), 9HW (DV6BTED4), 9HZ (DV6TED4)	1560			0-N1062	TB [TE]
1.6 HDi	04/08-	9HS (DV6TED4BU), 9HX (DV6ATED4), 9HT (DV6BTED4), 9HW (DV6BTED4), 9HW (DV6BTED4), 9HZ (DV6TED4)	1560			0-N1066	TB [DG]
1.6 HDi	08/10-	DV6C	1560			0-N2382	TB [DG]
1.6 HDi, 1.6 HDi 90	04/10-	9HF (DV6DTED), 9HL (DV6C), 9HP (DV6DTED)	1560			0-N2224	TB [TE]
1.6	04/08-	NFR (TU5JP4B)	1587			0-N1419	VB [DG]
1.6	04/08-	NFU (TU5JP4)	1587	Orga. → 12110; ☼		0-N1419	VB [DG]
1.6	04/08-	NFU (TU5JP4)	1587	Orga. → 12110; ☼		0-N1620	VB [BT] S
1.6	04/08-	NFR (TU5JP4B)	1587			0-N1874	VB [BT] S
1.6	04/08-	NFU (TU5JP4)	1587	Orga. 12110 →; ☼		0-N1874	VB [BT] S
1.6	04/08-	NFU (TU5JP4)	1587	Orga. 12110 →; ☼		0-N2191	VB [DG]
1.6	04/10-	5FK (EP6CB), 5FS (EP6C)	1598	☼		0-N2055	VB [BT] S
1.6	04/10-	5FK (EP6CB), 5FS (EP6C)	1598	für OE: 11 28 7 598 832, 11 28 7 598 833		0-N2237	VB [DG]
1.6 HDi	04/08-	9HZ (DV6TED4)	1560			0-N1502	VB [BT] S
1.6 HDi	04/08-	DV6TED4BU	1560			0-N1502	VB [BT] S
1.6 HDi	04/08-	9HS (DV6TED4BU), 9HX (DV6ATED4), 9HT (DV6BTED4), 9HW (DV6BTED4), 9HW (DV6BTED4)	1560			0-N1808	VB [BT] S
1.6 HDi	03/13-	DV6C	1560			0-N1502	VB [BT] S
1.6 HDi 90	04/10-	9HP (DV6DTED)	1560	für Fahrzeuge ohne Start-Stopp-Funktion		0-N1502	VB [BT] S
1.6 HDi, 1.6 HDi 4x4	04/08-	9HS (DV6TED4BU), 9HX (DV6ATED4), 9HT (DV6BTED4), 9HW (DV6BTED4), 9HW (DV6BTED4)	1560			0-N1807	VB [DG]
1.6 HDi, 1.6 HDi 90	04/10-	9HL (DV6C), 9HP (DV6DTED)	1560	Rippenanzahl: 6; für Fahrzeuge mit Start-Stopp-Funktion, ☼		0-N2355	VB [DG]
1.6 HDi, 1.6 HDi 90	04/10-	9HL (DV6C), 9HP (DV6DTED)	1560	für Fahrzeuge mit Start-Stopp-Funktion		0-N2392	VB [BT] S

PARTNER Pritsche/Fahrgestell

1.6 HDi	01/09-	9HS (DV6TED4BU), 9HX (DV6ATED4)	1560	25x137		SK-1424	BTK
1.6 HDi	01/09-	9HS (DV6TED4BU), 9HX (DV6ATED4)	1560	25x137		SK-1424AQ1	BTKW
1.6 HDi	03/13-	9HF (DV6DTED)	1560	25x141		SK-1728	BTK
1.6 HDi	03/13-	9HF (DV6DTED)	1560	25x141		SK-1728AQ1	BTKW
1.6 HDi	01/09-	9HS (DV6TED4BU), 9HX (DV6ATED4), 9HT (DV6BTED4)	1560			0-N1062	TB [TE]
1.6 HDi	01/09-	9HS (DV6TED4BU), 9HX (DV6ATED4), 9HT (DV6BTED4)	1560			0-N1066	TB [DG]
1.6 HDi	03/13-	9HF (DV6DTED)	1560			0-N2224	TB [TE]
1.6 HDi	03/13-	9HF (DV6DTED)	1560			0-N2382	TB [DG]
1.6 HDi	01/09-	9HS (DV6TED4BU), 9HX (DV6ATED4)	1560			0-N1807	VB [DG]
1.6 HDi	01/09-	9HT (DV6BTED4)	1560	☼		0-N1807	VB [DG]

PARTNER Tepee

1.6	04/08-	NFR (TU5JP4B), NFU (TU5JP4)	1587	25.4x134		SK-1615	BTK
1.6	04/08-	NFR (TU5JP4B), NFU (TU5JP4)	1587	25.4x134		SK-1615AQ1	BTKW
1.6	04/10-	5FK (EP6CB), 5FS (EP6C)	1598	25.4x134		SK-1615	BTK
1.6	04/10-	5FK (EP6CB), 5FS (EP6C)	1598	25.4x134		SK-1615AQ1	BTKW
1.6 BlueHdi 75	01/15-	DV6ETED4	1560	25x141		SK-1728	BTK
1.6 BlueHdi 75	01/15-	DV6ETED4	1560	25x141		SK-1728AQ1	BTKW
1.6 HDi	04/08-	9HN (DV6ETED4), 9HT (DV6BTED4), 9HW (DV6BTED4), 9HV (DV6TED4), 9HX (DV6ATED4), 9HZ (DV6TED4)	1560	25x137		SK-1424	BTK
1.6 HDi	04/08-	9HN (DV6ETED4), 9HT (DV6BTED4), 9HW (DV6BTED4), 9HV (DV6TED4), 9HX (DV6ATED4), 9HZ (DV6TED4)	1560	25x137		SK-1424AQ1	BTKW
1.6 HDi, 1.6 HDi 90	04/10-	9HF (DV6DTED), 9HL (DV6C), 9HP (DV6DTED)	1560	25x141		SK-1728	BTK
1.6 HDi, 1.6 HDi 90	04/10-	9HF (DV6DTED), 9HL (DV6C), 9HP (DV6DTED)	1560	25x141		SK-1728AQ1	BTKW
1.6	04/08-	NFR (TU5JP4B), NFU (TU5JP4)	1587			0-N1359	TB [TE]
1.6	04/08-	NFR (TU5JP4B), NFU (TU5JP4)	1587			0-N1360	TB [DG]
1.6 BlueHdi 100, 1.6 BlueHdi 120, 1.6 HDi, 1.6 HDi 90	04/10-	9HF (DV6DTED), 9HL (DV6C), 9HP (DV6DTED), BHY (DV6FD), BHZ (DV6FC)	1560			0-N2382	TB [DG]

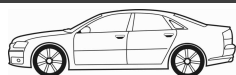

CM³



Art. Nr.



ohne Halter

PARTNER Tepee							
1.6 HDi	04/08-	9HN (DV6ETED4), 9HT (DV6BTED4), 9HW (DV6BTED4), 9HV (DV6TED4), 9HX (DV6ATED4), 9HZ (DV6TED4)	1560			0-N1066	TB [DG]
1.6 HDi	08/10-	9HF (DV6DTEd), 9HL (DV6C)	1560			0-N2224	TB [TE]
1.6 HDi 90	04/10-	DV6DTEd	1560			0-N2224	TB [TE]
1.6 HDi, 1.6 HDi 90	04/08-	9HN (DV6ETED4), 9HT (DV6BTED4), 9HW (DV6BTED4), 9HP (DV6DTEd), 9HV (DV6TED4), 9HX (DV6ATED4), 9HZ (DV6TED4)	1560			0-N1062	TB [TE]
1.6	04/08-	NFR (TU5JP4B)	1587			0-N1419	VB [DG]
1.6	04/08-	NFU (TU5JP4)	1587	Orga.→12110; ⚠		0-N1419	VB [DG]
1.6	04/08-	NFU (TU5JP4)	1587	Orga.→12110; ⚠		0-N1620	VB [BT] S
1.6	04/08-	NFR (TU5JP4B)	1587			0-N1874	VB [BT] S
1.6	04/08-	NFU (TU5JP4)	1587	Orga.12110→; ⚠		0-N1874	VB [BT] S
1.6	04/08-	NFU (TU5JP4)	1587	Orga.12110→; ⚠		0-N2191	VB [DG]
1.6	04/10-	5FK (EP6CB), 5FS (EP6C)	1598	⚠		0-N2055	VB [BT] S
1.6	04/10-	5FK (EP6CB), 5FS (EP6C)	1598	für OE: 11 28 7 598 832, 11 28 7 598 833		0-N2237	VB [DG]
1.6 HDi	04/08-	9HL (DV6C), 9HZ (DV6TED4)	1560			0-N1502	VB [BT] S
1.6 HDi	04/08-	DV6TED4	1560			0-N1502	VB [BT] S
1.6 HDi	04/08-	9HN (DV6ETED4), 9HT (DV6BTED4), 9HW (DV6BTED4), 9HV (DV6TED4), 9HX (DV6ATED4)	1560			0-N1807	VB [DG]
1.6 HDi	04/08-	9HN (DV6ETED4), 9HT (DV6BTED4), 9HW (DV6BTED4), 9HV (DV6TED4), 9HX (DV6ATED4)	1560			0-N1808	VB [BT] S
1.6 HDi 90	04/10-	9HP (DV6DTEd)	1560	für Fahrzeuge ohne Start-Stopp-Funktion		0-N1502	VB [BT] S
1.6 HDi, 1.6 HDi 90	04/10-	9HF (DV6DTEd), 9HL (DV6C), 9HP (DV6DTEd)	1560	Rippenanzahl: 6; für Fahrzeuge mit Start-Stopp-Funktion, ⚠		0-N2355	VB [DG]
1.6 HDi, 1.6 HDi 90	04/10-	9HF (DV6DTEd), 9HL (DV6C), 9HP (DV6DTEd)	1560	für Fahrzeuge mit Start-Stopp-Funktion		0-N2392	VB [BT] S
RCZ							
2.0 HDi	03/10-	RHH (DW10CTED4)	1997	25x116		SK-1714	BTK
2.0 HDi	03/10-	RHH (DW10CTED4)	1997	25x116		SK-1714AQ1	BTKW
2.0 HDi	03/10-	RHH (DW10CTED4)	1997			0-N1334	TB [DG]
2.0 HDi	03/10-	RHH (DW10CTED4)	1997			0-N2063	TB [TE]
1.6 16V	03/10-	EP6CDT, EP6CDTX	1598	⚠		0-N2055	VB [BT] S
1.6 16V, 1.6 THP 270	03/10-	5FG (EP6CDTR), EP6CDT, EP6CDTX	1598	für OE: 11 28 7 598 832, 11 28 7 598 833		0-N2237	VB [DG]
2.0 HDi	03/10-	RHH (DW10CTED4)	1997			0-N2268	VB [BT] S



OPTIMAL®

PEUGEOT (DF-PSA)



CM³



Art. Nr.



ohne Halter

206									
1.4	07/06-02/09	TU3AF	1361			0-N811	TB [TE]		
1.6	01/06-02/09	TU5JP4	1587			0-N1359	TB [TE]		
1.6	01/06-02/09	TU5JP4	1587			0-N1360	TB [DG]		
1.4	07/06-02/09	TU3AF	1361			0-N1419	VB [DG]		
1.6	01/06-02/09	TU5JP4	1587			0-N1419	VB [DG]		
307 Schrägheck									
2.0	02/08-	EW10A	1997	25x153		SK-1600	BTK		
307 Stufenheck									
1.6	08/04-	TU5JP4	1587	:1806405→		0-N1359	TB [TE]		
1.6	08/04-	TU5JP4	1587	:1806405→		0-N1360	TB [DG]		
2.0	08/04-05/06	EW10A, EW10J4	1997			0-N1065	TB [DG]		
1.6	08/04-	TU5JP4	1587			0-N1673	VB [BT]		S

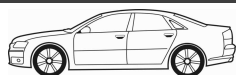

CM³



Art. Nr.



ohne Halter

ACCLAIM								
2.5	09/88-09/95	EDM	2501			0-N1693	FB [DG]	
BREEZE								
2.4 16 V	12/95-04/01	EDZ	2429	28x146		SK-1700	BTK	
2.4 16 V	12/95-04/01	EDZ	2429	28x146		SK-1701	BTK	
2.4 16V	12/95-04/01	EDZ	2429	28x146; 10/1998 → 09/2000		SK-1700	BTK	
2.4 16V	12/95-04/01	EDZ	2429	28x146; 10/1998 → 09/2000		SK-1701	BTK	
2.4 16 V	12/95-04/01	EDZ	2429			0-N1962	TB [DG]	
2.4 16V	12/95-04/01	EDZ	2429	10/1998 → 09/2000		0-N1962	TB [DG]	
2.0 16V	12/95-04/01	ECB	1996			0-N1555	VB [BT]	S
2.4 16 V, 2.4 16V	12/95-04/01	EDZ	2429			0-N1555	VB [BT]	S
NEON II Stufenheck								
2.0 16V	08/99-	ECB, ECH	1996	01/2002 →; ohne Grundträger		0-N1836	VB [BT]	
VOYAGER / GRAND VOYAGER								
3.3 Flex-Fuel, 3.3 i, 3.3 LE	10/89-09/90	EGA, EGM	3301			0-N1698	VB [BT]	S
VOYAGER / GRAND VOYAGER								
2.4 i	01/95-03/01	EDZ	2429	28x146; 11/1995 → 12/2000		SK-1700	BTK	
2.4 i	01/95-03/01	EDZ	2429	28x146; 11/1995 → 12/2000; Baumuster: 1997		SK-1701	BTK	
3.0	01/95-03/01	EFA	2972	25.4x149; 11/1995 →		SK-1308	BTK	
2.4 i	01/95-03/01	EDZ	2429	11/1995 →; Baumuster: 1997		0-N1962	TB [DG]	
2.4 i	01/95-03/01	EDZ	2429			0-N2059	TB [TE]	
2.5 TD	01/95-03/01	ENC	2499			0-N1546	VB [DG]	
3.3 Flex-Fuel, 3.3 i, 3.3 LE	01/95-03/01	EGA, EGM	3301			0-N1698	VB [BT]	S
3.3 i	01/95-03/01	EGM	3301	11/1995 →; ☼		0-N1695	VB [DG]	
3.8 i, 3.8 i AWD	01/95-03/01	EGH	3778	10/1998 →; ☼		0-N1695	VB [DG]	
3.8 i, 3.8 i AWD	01/95-03/01	EGH	3778	11/1995 →; ☼		0-N1695	VB [DG]	
3.8 i, 3.8 i AWD	01/95-03/01	EGH	3778			0-N1698	VB [BT]	S

CM³

Art. Nr.



FIREBIRD Cabriolet							
3.4	01/93-12/95	L32	3350			0-N1684	VB [DG]
3.4	01/93-12/95	L32	3350	✳		0-N1690	VB [DG]
3.8	10/94-12/97	L36	3791			0-N1685	VB [DG]
5.7	01/93-12/96	LT1	5733			0-N1684	VB [DG]
5.7	01/93-12/96	LT1	5733			0-N1685	VB [DG]
5.7	01/93-12/96	LT1	5733			0-N1689	VB [DG]
FIREBIRD							
3.4	11/92-12/95	L32	3351			0-N1684	VB [DG]
3.4	11/92-12/95	L32	3351	✳		0-N1690	VB [DG]
3.8	10/94-12/97	L36	3791			0-N1685	VB [DG]
G3 [USA]							
1.8 16V	01/08-12/09		1600			0-N194	TB [TE]
1.8 16V	01/08-12/09		1600			0-N938	TB [DG]
GRAND PRIX VI Coupe							
3.8 GT, 3.8 GT Power	07/96-12/03	L36, L67	3791			0-N1685	VB [DG]
GRAND PRIX VI Stufenheck							
3.8, 3.8 GT Power	07/96-12/03	L36, L67	3791			0-N1685	VB [DG]
MONTANA							
3.4	04/98-08/05	LA1	3350			0-N1658	VB [BT]
3.4	04/98-08/05	LA1	3350			0-N1685	VB [DG]
3.4	04/98-08/05	LA1	3350			0-N1690	VB [DG]
SOLSTICE Cabriolet							
2.4 VVTi	03/05-	LE5	2384			0-N2283	VB [DG]
2.4 VVTi	03/05-	LE5	2384			0-N2299	VB [BT] S
SUNFIRE							
2.2	11/98-10/02	LN2	2190			0-N1691	VB [DG]
2.2	11/98-10/02	LN2	2190			0-N1692	VB [DG]
SUNFIRE Coupe							
2.2 SE	11/98-10/02	LN2	2190			0-N1691	VB [DG]
2.2 SE	11/98-10/02	LN2	2190			0-N1692	VB [DG]
TRANS SPORT							
3.1	07/89-03/97	LG6	3128	✳		0-N1688	VB [DG]
3.1	07/89-03/97	LG6, LH0, LH0	3135	✳		0-N1688	VB [DG]
3.1	07/89-03/97	LG6	3128	✳		0-N1690	VB [DG]
3.1	07/89-03/97	LG6, LH0, LH0	3135	✳		0-N1690	VB [DG]
3.1	07/89-03/97	LG6	3128	✳		0-N1848	VB [BT] S
3.1	07/89-03/97	LG6, LH0, LH0	3135	✳		0-N1848	VB [BT] S
3.8	07/89-03/97	L27	3791	01/1995 →		0-N1687	VB [DG]
TRANS SPORT							
3.4	03/97-09/98	LA1	3350	01/1998 →		0-N1684	VB [DG]
3.4	03/97-09/98	LA1	3350	→ 12/1997		0-N1688	VB [DG]
3.4	03/97-12/99	LA1	3350			0-N1848	VB [BT] S
3.4	09/98-12/99	LA1	3350			0-N1684	VB [DG]

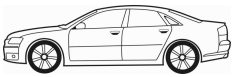

CM³



Art. Nr.



911 (964)							
3.3 Turbo, 3.3 Turbo S	08/90-09/93	M 30.69, M 30.69S	3299			0-N904	TB [DG]
3.6 Turbo	01/93-09/93	M 64.50	3600			0-N904	TB [DG]
911 (991)							
3.4 Carrera, 3.4 Carrera 4	12/11-	MA1.04, MAB.04	3436			0-N2291	TB [VD]
3.8 Carrera 4S, 3.8 Carrera S, 3.8 Turbo, 3.8 Turbo S	12/11-	MA1.03, MAB.03, MA1.71	3800			0-N2291	TB [VD]
3.4 Carrera, 3.4 Carrera 4	12/11-	MA1.04, MAB.04	3436	für OE: 9A1 102 211 01		0-N2272	VB [TE]
3.4 Carrera, 3.4 Carrera 4	12/11-	MA1.04, MAB.04	3436	für Fahrzeuge mit elektrischer Servolenkung		0-N2295	VB [DG]
3.8 Carrera 4S, 3.8 Carrera S, 3.8 Turbo, 3.8 Turbo S	12/11-	MA1.03, MAB.03, MA1.71	3800	für OE: 9A1 102 211 01		0-N2272	VB [TE]
3.8 Carrera 4S, 3.8 Carrera S, 3.8 Turbo, 3.8 Turbo S	12/11-	MA1.03, MAB.03, MA1.71	3800	für Fahrzeuge mit elektrischer Servolenkung		0-N2295	VB [DG]
911 Cabriolet (991)							
3.4 Carrera, 3.4 Carrera 4	03/12-	MA1.04, MAB.04	3436			0-N2291	TB [VD]
3.8 Carrera 4S, 3.8 Carrera S	03/12-	MA1.03, MAB.03	3800			0-N2291	TB [VD]
3.4 Carrera, 3.4 Carrera 4	03/12-	MA1.04, MAB.04	3436	für OE: 9A1 102 211 01		0-N2272	VB [TE]
3.4 Carrera, 3.4 Carrera 4	03/12-	MA1.04, MAB.04	3436	für Fahrzeuge mit elektrischer Servolenkung		0-N2295	VB [DG]
3.8 Carrera 4S, 3.8 Carrera S	03/12-	MA1.03, MAB.03	3800	für OE: 9A1 102 211 01		0-N2272	VB [TE]
3.8 Carrera 4S, 3.8 Carrera S	03/12-	MA1.03, MAB.03	3800	für Fahrzeuge mit elektrischer Servolenkung		0-N2295	VB [DG]
911 (996)							
3.4 Carrera	09/97-09/01	M 96.01	3387			0-N2069	VB [DG]
3.4 Carrera	09/97-09/01	M 96.01	3387			0-N2070	VB [DG]
3.4 Carrera 4	09/97-09/01	M 96.01, M 96.04	3387			0-N2069	VB [DG]
3.4 Carrera 4	09/97-09/01	M 96.01, M 96.04	3387			0-N2070	VB [DG]
3.4 Carrera 4	09/97-09/01	M 96.04	3387	☞		0-N2078	VB [DG]
3.4 Carrera, 3.4 Carrera 4	09/97-09/01	M 96.01	3387	☞		0-N2078	VB [DG]
3.4 Carrera, 3.4 Carrera 4	09/97-09/01	M 96.01	3387	☞		0-N2079	VB [DG]
3.4 Carrera, 3.4 Carrera 4	05/01-08/05	M 96.02	3387	☞		0-N2078	VB [DG]
3.6 Carrera, 3.6 Carrera 4, 3.6 Carrera 4S, 3.6 Carrera S	10/01-08/05	M 96.03	3596			0-N2069	VB [DG]
3.6 Carrera, 3.6 Carrera 4, 3.6 Carrera 4S, 3.6 Carrera S	10/01-08/05	M 96.03	3596			0-N2070	VB [DG]
3.6 Carrera, 3.6 Carrera 4, 3.6 Carrera 4S, 3.6 Carrera S	10/01-08/05	M 96.03	3596	☞		0-N2078	VB [DG]
3.6 Carrera, 3.6 Carrera 4, 3.6 Carrera 4S, 3.6 Carrera S	10/01-08/05	M 96.03	3596	☞		0-N2079	VB [DG]
3.6 GT2, 3.6 S, 3.6 Turbo 4, 3.6 Turbo 4S	06/00-08/05	M 96.70	3600			0-N2071	VB [DG]
3.6 GT2, 3.6 S, 3.6 Turbo 4, 3.6 Turbo 4S	06/00-08/05	M 96.70	3600	☞		0-N2073	VB [DG]
3.6 GT2, 3.6 S, 3.6 Turbo 4, 3.6 Turbo 4S	06/00-08/05	M 96.70	3600			0-N2080	VB [BT]
3.6 GT3	03/99-08/05	M 96.76	3598			0-N2080	VB [BT]
3.6 GT3	03/99-08/05	M 96.76	3598			0-N2090	VB [DG]
3.6 GT3	03/03-08/05	M 96.79	3600			0-N2090	VB [DG]
911 Cabriolet (996)							
3.4 Carrera	02/98-09/01	M 96.01	3387			0-N2069	VB [DG]
3.4 Carrera	02/98-09/01	M 96.01	3387			0-N2070	VB [DG]
3.4 Carrera	02/98-09/01	M 96.01	3387	☞		0-N2078	VB [DG]
3.4 Carrera	02/98-09/01	M 96.01	3387	☞		0-N2079	VB [DG]
3.4 Carrera 4	02/98-09/01	M 96.02	3387			0-N2069	VB [DG]
3.4 Carrera 4	02/98-09/01	M 96.02	3387			0-N2070	VB [DG]
3.4 Carrera 4	02/98-09/01	M 96.02	3387	☞		0-N2079	VB [DG]
3.4 Carrera, 3.4 Carrera 4	02/98-08/05	M 96.02	3387	☞		0-N2078	VB [DG]
3.6 Carrera, 3.6 Carrera 4, 3.6 Carrera 4S, 3.6 Carrera S	10/01-08/05	M 96.03	3596			0-N2069	VB [DG]
3.6 Carrera, 3.6 Carrera 4, 3.6 Carrera 4S, 3.6 Carrera S	10/01-08/05	M 96.03	3596			0-N2070	VB [DG]
3.6 Carrera, 3.6 Carrera 4, 3.6 Carrera 4S, 3.6 Carrera S	10/01-08/05	M 96.03	3596	☞		0-N2078	VB [DG]
3.6 Carrera, 3.6 Carrera 4, 3.6 Carrera 4S, 3.6 Carrera S	10/01-08/05	M 96.03	3596	☞		0-N2079	VB [DG]
3.6 S, 3.6 Turbo 4, 3.6 Turbo 4S	10/03-08/05	M 96.70	3600			0-N2071	VB [DG]
3.6 S, 3.6 Turbo 4, 3.6 Turbo 4S	10/03-08/05	M 96.70	3600	☞		0-N2073	VB [DG]
3.6 S, 3.6 Turbo 4, 3.6 Turbo 4S	10/03-08/05	M 96.70	3600			0-N2080	VB [BT]
911 (997)							
3.8 Turbo, 3.8 Turbo S	09/09-12/12	MA1.70	3800			0-N2291	TB [VD]
3.6 Carrera, 3.6 Carrera 4	07/04-12/08	M 96.05	3596	für Fahrzeuge mit Tiptronic		0-N2068	VB [DG]
3.6 Carrera, 3.6 Carrera 4	07/04-12/08	M 96.05	3596			0-N2069	VB [DG]



CM³



Art. Nr.



911 (997)								
3.6 Carrera, 3.6 Carrera 4	07/04-12/08	M 96.05	3596				0-N2070	VB [DG]
3.6 Carrera, 3.6 Carrera 4	07/04-12/08	M 96.05	3596				0-N2077	VB [BT]
3.6 GT 3, 3.6 Turbo	03/06-12/09	M 97.70, M 97.76	3600				0-N2071	VB [DG]
3.6 GT 3, 3.6 Turbo	03/06-12/09	M 97.70, M 97.76	3600	†			0-N2073	VB [DG]
3.6 GT 3, 3.6 Turbo	03/06-12/09	M 97.70, M 97.76	3600				0-N2080	VB [BT]
3.8 Carrera 4S, 3.8 Carrera S	07/04-12/08	M 97.01	3824				0-N2069	VB [DG]
3.8 Carrera 4S, 3.8 Carrera S	07/04-12/08	M 97.01	3824				0-N2070	VB [DG]
3.8 Carrera 4S, 3.8 Carrera S	07/04-12/08	M 97.01	3824				0-N2077	VB [BT]
3.8 Carrera 4S, 3.8 Carrera S	07/04-12/08	M 97.01	3824				0-N2078	VB [DG]
3.8 Carrera 4S, 3.8 Carrera S	07/04-12/08	M 97.01	3824				0-N2079	VB [DG]
3.8 Turbo, 3.8 Turbo S	09/09-12/12	MA1.70	3800		für OE: 9A1 102 211 01		0-N2272	VB [TE]
3.8 Turbo, 3.8 Turbo S	09/09-12/12	MA1.70	3800		für Fahrzeuge mit elektrischer Servolenkung		0-N2295	VB [DG]
911 Cabriolet (997)								
3.8 Turbo, 3.8 Turbo S	09/09-12/12	MA1.70	3800				0-N2291	TB [VD]
3.6 Carrera, 3.6 Carrera 4	04/05-12/08	M 96.05	3596		für Fahrzeuge mit Tiptronic		0-N2068	VB [DG]
3.6 Carrera, 3.6 Carrera 4	04/05-12/08	M 96.05	3596				0-N2069	VB [DG]
3.6 Carrera, 3.6 Carrera 4	04/05-12/08	M 96.05	3596				0-N2070	VB [DG]
3.6 Carrera, 3.6 Carrera 4	04/05-12/08	M 96.05	3596				0-N2077	VB [BT]
3.6 Turbo	09/07-12/09	M 97.70	3600				0-N2071	VB [DG]
3.6 Turbo	09/07-12/09	M 97.70	3600	†			0-N2073	VB [DG]
3.6 Turbo	09/07-12/09	M 97.70	3600				0-N2080	VB [BT]
3.8 Carrera 4S, 3.8 Carrera S	04/05-12/08	M 97.01	3824				0-N2069	VB [DG]
3.8 Carrera 4S, 3.8 Carrera S	04/05-12/08	M 97.01	3824				0-N2070	VB [DG]
3.8 Carrera 4S, 3.8 Carrera S	04/05-12/08	M 97.01	3824				0-N2077	VB [BT]
3.8 Carrera 4S, 3.8 Carrera S	04/05-12/08	M 97.01	3824				0-N2078	VB [DG]
3.8 Carrera 4S, 3.8 Carrera S	04/05-12/08	M 97.01	3824				0-N2079	VB [DG]
3.8 Turbo, 3.8 Turbo S	09/09-12/12	MA1.70	3800		für OE: 9A1 102 211 01		0-N2272	VB [TE]
3.8 Turbo, 3.8 Turbo S	09/09-12/12	MA1.70	3800		für Fahrzeuge mit elektrischer Servolenkung		0-N2295	VB [DG]
911 Targa (997)								
3.6 Carrera 4	07/06-12/08	M 96.05	3596		für Fahrzeuge mit Tiptronic		0-N2068	VB [DG]
3.6 Carrera 4	07/06-12/08	M 96.05	3596				0-N2069	VB [DG]
3.6 Carrera 4	07/06-12/08	M 96.05	3596				0-N2070	VB [DG]
3.6 Carrera 4	07/06-12/08	M 96.05	3596				0-N2077	VB [BT]
3.8 Carrera 4S	07/06-12/08	M 97.01	3824				0-N2069	VB [DG]
3.8 Carrera 4S	07/06-12/08	M 97.01	3824				0-N2070	VB [DG]
3.8 Carrera 4S	07/06-12/08	M 97.01	3824				0-N2077	VB [BT]
3.8 Carrera 4S	07/06-12/08	M 97.01	3824				0-N2078	VB [DG]
3.8 Carrera 4S	07/06-12/08	M 97.01	3824				0-N2079	VB [DG]
924								
2.0, 2.0 Carrera GT, 2.0 Turbo	11/75-08/89	M 31.01, M 31.03, M 31.50, XJ, XK	1984		18x121; mit Zubehör		SK-1026	BTK
2.0, 2.0 Carrera GT, 2.0 Turbo	11/75-08/89	M 31.01, M 31.03, M 31.50, XJ, XK	1984				0-N805	TB [TE]
BOXSTER (986)								
2.5	09/96-08/99	M 96.20	2480				0-N2069	VB [DG]
2.7	08/99-12/04	M 96.22, M 96.23	2687				0-N2069	VB [DG]
2.7	07/02-12/04	M 96.23	2687				0-N2070	VB [DG]
S 3.2, S 3.2	08/99-12/04	M 96.21, M 96.24	3179				0-N2069	VB [DG]
S 3.2, S 3.2	07/02-12/04	M 96.24	3179				0-N2070	VB [DG]
BOXSTER (987)								
2.9	06/09-12/11	MA1.20	2893				0-N2291	TB [VD]
S 3.4	06/09-12/11	MA1.21	3436				0-N2291	TB [VD]
2.7	11/04-12/06	M 96.25	2687				0-N2068	VB [DG]
2.7	11/04-12/09	M 96.25, M 97.20	2687				0-N2069	VB [DG]
2.7	11/04-12/09	M 96.25, M 97.20	2687				0-N2070	VB [DG]
2.7	11/04-12/09	M 96.25, M 97.20	2687				0-N2077	VB [BT]
2.7	11/04-12/09	M 96.25, M 97.20	2687	†			0-N2078	VB [DG]
2.7	11/04-12/09	M 96.25, M 97.20	2687	†			0-N2079	VB [DG]
2.7	07/06-12/09	M 97.20	2687		für Fahrzeuge mit Tiptronic		0-N2068	VB [DG]
2.9	06/09-12/11	MA1.20	2893		für OE: 9A1 102 211 01		0-N2272	VB [TE]
2.9	06/09-12/11	MA1.20	2893		für Fahrzeuge mit elektrischer Servolenkung		0-N2295	VB [DG]
S 3.2	11/04-12/06	M 96.26	3179				0-N2068	VB [DG]
S 3.2	11/04-12/06	M 96.26	3179				0-N2069	VB [DG]
S 3.2	11/04-12/06	M 96.26	3179				0-N2070	VB [DG]
S 3.2	11/04-12/06	M 96.26	3179				0-N2077	VB [BT]

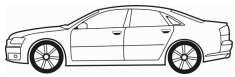

CM³



Art. Nr.



BOXSTER (987)							
S 3.2	11/04-12/06	M 96.26	3179			0-N2078	VB [DG]
S 3.2	11/04-12/06	M 96.26	3179			0-N2079	VB [DG]
S 3.4	07/06-12/09	M 97.21, M 97.22	3387		für Fahrzeuge mit Tiptronic	0-N2068	VB [DG]
S 3.4	07/06-12/09	M 97.21, M 97.22	3387			0-N2069	VB [DG]
S 3.4	07/06-12/09	M 97.21, M 97.22	3387			0-N2070	VB [DG]
S 3.4	07/06-12/09	M 97.21, M 97.22	3387			0-N2077	VB [BT]
S 3.4	07/06-12/09	M 97.21, M 97.22	3387			0-N2078	VB [DG]
S 3.4	07/06-12/09	M 97.21, M 97.22	3387			0-N2079	VB [DG]
S 3.4	06/09-12/11	MA1.21	3436		für OE: 9A1 102 211 01	0-N2272	VB [TE]
S 3.4	06/09-12/11	MA1.21	3436		für Fahrzeuge mit elektrischer Servolenkung	0-N2295	VB [DG]

BOXSTER Spyder (987)							
Spyder 3.4	06/10-12/11	MA1.21	3436			0-N2291	TB [VD]
Spyder 3.4	06/10-12/11	MA1.21	3436		für OE: 9A1 102 211 01	0-N2272	VB [TE]
Spyder 3.4	06/10-12/11	MA1.21	3436		für Fahrzeuge mit elektrischer Servolenkung	0-N2295	VB [DG]

BOXSTER (981)							
2.7	04/12-	MA1.22	2706			0-N2291	TB [VD]
S 3.4	04/12-	MA1.23	3436			0-N2291	TB [VD]
2.7	04/12-	MA1.22	2706		für OE: 9A1 102 211 01	0-N2272	VB [TE]
2.7	04/12-	MA1.22	2706		für Fahrzeuge mit elektrischer Servolenkung	0-N2295	VB [DG]
S 3.4	04/12-	MA1.23	3436		für OE: 9A1 102 211 01	0-N2272	VB [TE]
S 3.4	04/12-	MA1.23	3436		für Fahrzeuge mit elektrischer Servolenkung	0-N2295	VB [DG]

CAYENNE (955, 9PA)							
3.0 TDI	02/09-09/10	M 05.9D	2967			0-N131	TB [DG]
3.2	10/03-09/07	M02.2Y	3189			0-N2110	VB [DG]
3.6	02/07-09/10	M 55.01	3598			0-N2110	VB [DG]
GTS 4.8, S 4.8, Turbo S 4.8	02/07-09/10	M 48.01, M 48.51	4806		für OE: 948 102 403 00, 948 102 403 21, 948 102 403 22, 948 102 403 23	0-N2272	VB [TE]
S 4.5, Turbo 4.5, Turbo S 4.5	09/02-09/07	M 48.00, M 48.50, M 48.50S	4511		für OE: 948 102 359 02, 948 102 359 03, 948 102 359 04	0-N2272	VB [TE]

CAYENNE (92A)							
3.0 Diesel	06/10-	M 05.9E	2967			0-N131	TB [DG]
3.0 Diesel	06/10-	MCR.C, MCR.CA, MCR.CB, MCV.VC	2967			0-N2287	VB [BT] S
3.0 S, 3.0 S E-Hybrid, 3.0 S Hybrid	06/10-	M 06.EC, MCG.E, MCG.EA, MCG.FA, M 06.EC, MCJ.T	2995			0-N1830	VB [BT] S
3.0 S, 3.0 S E-Hybrid, 3.0 S Hybrid	06/10-	M 06.EC, MCG.E, MCG.EA, MCG.FA, M 06.EC, MCJ.T	2995			0-N2289	VB [BT] S
3.0 S, 3.0 S E-Hybrid, 3.0 S Hybrid	06/10-	M 06.EC, MCG.E, MCG.EA, MCG.FA, M 06.EC, MCJ.T	2995			0-N2351	VB [DG]
3.0 S, 3.0 S Hybrid	06/10-	M 06.EC, MCG.E, MCG.EA, MCG.FA, M 06.EC, MCJ.T	2995			0-N2199	VB [DG]
4.8 GTS, 4.8 S, 4.8 Turbo, 4.8 Turbo S	06/10-	M 48.02, M 48.52	4806		für OE: 948 102 403 00, 948 102 403 21, 948 102 403 22, 948 102 403 23	0-N2272	VB [TE]

CAYMAN (987)							
2.9	02/09-12/12	MA1.20	2893			0-N2291	TB [VD]
R 3.4, S 3.4	02/09-06/13	MA1.21	3436			0-N2291	TB [VD]
2.7	07/06-12/09	M 97.20	2687		für Fahrzeuge mit Tiptronic	0-N2068	VB [DG]
2.7	07/06-12/09	M 97.20	2687			0-N2069	VB [DG]
2.7	07/06-12/09	M 97.20	2687			0-N2070	VB [DG]
2.7	07/06-12/09	M 97.20	2687			0-N2077	VB [BT]
2.7	07/06-12/09	M 97.20	2687			0-N2078	VB [DG]
2.7	07/06-12/09	M 97.20	2687			0-N2079	VB [DG]
2.9	02/09-12/12	MA1.20	2893		für OE: 9A1 102 211 01	0-N2272	VB [TE]
2.9	02/09-12/12	MA1.20	2893		für Fahrzeuge mit elektrischer Servolenkung	0-N2295	VB [DG]
R 3.4, S 3.4	02/09-06/13	MA1.21	3436		für OE: 9A1 102 211 01	0-N2272	VB [TE]
R 3.4, S 3.4	02/09-06/13	MA1.21	3436		für Fahrzeuge mit elektrischer Servolenkung	0-N2295	VB [DG]
S 3.4 Sport, S 3.4	11/05-12/12	M 97.21, M 97.22	3387			0-N2069	VB [DG]
S 3.4	11/05-12/09	M 97.21	3387		für Fahrzeuge mit Tiptronic	0-N2068	VB [DG]
S 3.4	11/05-12/09	M 97.21	3387			0-N2070	VB [DG]
S 3.4	11/05-12/09	M 97.21	3387			0-N2077	VB [BT]

PANAMERA (970)							
3.0 D	08/11-	MCR.CB, MCR.CC	2967			0-N2287	VB [BT] S
3.0 S E-Hybrid, 3.0 S Hybrid	03/11-	MCG.EA, MCG.FA	2995			0-N1830	VB [BT] S
3.0 S E-Hybrid, 3.0 S Hybrid	03/11-	MCG.EA, MCG.FA	2995			0-N2289	VB [BT] S
3.0 S E-Hybrid, 3.0 S Hybrid	03/11-	MCG.EA, MCG.FA	2995			0-N2351	VB [DG]
3.0 S Hybrid	03/11-	MCG.EA, MCG.FA	2995			0-N2199	VB [DG]

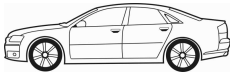

CM³



Art. Nr.



ohne Halter

PANAMERA (970)

3.6, 3.6 4	05/10-	M 46.20, M 46.40	3605	für OE: 948 102 403 00, 948 102 403 21, 948 102 403 22, 948 102 403 23	0-N2272	VB [TE]	
4.8 4S, 4.8 GTS, 4.8 S, 4.8 Turbo, 4.8 Turbo S	09/09-	M 48.20, M 48.40, M 48.70	4806	für OE: 948 102 403 00, 948 102 403 21, 948 102 403 22, 948 102 403 23	0-N2272	VB [TE]	

PANAMERA [USA]

4.8, 4.8 4S	01/10-12/10		4806	für OE: 948 102 403 00, 948 102 403 21, 948 102 403 22, 948 102 403 23	0-N2272	VB [TE]	
-------------	-------------	--	------	--	----------------	---------	--



CM³



Art. Nr.



ohne Halter

AEROBACK Hatchback (C2_A, C9_L)							
1.3	10/88-11/96	4 G 13, 4 G 13 P	1298	06/1990 →	0-N987	TB [TE]	
1.3	01/91-09/93	4 G 13	1298		0-N987	TB [TE]	
1.5	10/88-06/91		1468	06/1990 →	0-N987	TB [TE]	
1.5, 1.5 LX	10/88-11/96	4 G 15, 4 G 15 M	1468		0-N987	TB [TE]	
IMPIAN							
1.6	09/01-	4 G 18 P	1584		0-N1129	TB [TE]	
JUMBUCK Pick-up							
1.5	05/02-	4 G 15	1468		0-N1129	TB [TE]	
PERSONA 300 (C9_M)							
313i	03/96-	G 13 B	1299	22x92	SK-1234	BTK	
315 GLi/GLSi, 315 GLSi	03/96-	4 G 15 M, G 15 B	1468	22x92	SK-1234	BTK	
1.3	08/00-	4 G 13 M	1298		0-N987	TB [TE]	
313i	03/96-	G 13 B	1299		0-N987	TB [TE]	
315 GLi/GLSi, 315 GLSi	03/96-	4 G 15 M, G 15 B	1468		0-N1129	TB [TE]	
315 GLi/GLSi, 315 GLSi	03/96-	4 G 15 M, G 15 B	1468	→ 11/1998	0-N181	TB [TE]	
316, 316 GLXi	03/96-	4 G 92	1597		0-N052	TB [TE]	
318 16V GTI	03/96-	4 G 93 (DOHC)	1834		0-N060	TB [TE]	
PERSONA 400 (C9_S)							
413	01/94-	4 G 13 P	1299	22x92; 03/1996 →	SK-1234	BTK	
415 GLi/GLSi	01/94-	4 G 15	1468	22x92	SK-1234	BTK	
1.3	10/05-	4 G 13 M	1298		0-N987	TB [TE]	
1.5	05/95-	4 G 15 M	1468		0-N1129	TB [TE]	
413	01/94-	4 G 13 P	1299		0-N987	TB [TE]	
415 GLi/GLSi	01/94-	4 G 15	1468	01/1996 →	0-N1129	TB [TE]	
415 GLi/GLSi	01/94-	4 G 15	1468	→ 11/1998	0-N181	TB [TE]	
415 GLi/GLSi	01/94-	4 G 15	1468	→ 12/1995	0-N987	TB [TE]	
416, 416 GLXi	01/94-02/02	4 G 92	1597		0-N052	TB [TE]	
418	05/96-	4 G 93 (DOHC)	1834		0-N055	TB [DG]	
418	05/96-	4 G 93 (DOHC)	1834		0-N056	TB [TE]	
420 GLS D, 420 TD	05/96-	4 D 68, 4 D 68 T	1998		0-N058	TB [DG]	
420 GLS D, 420 TD	05/96-	4 D 68, 4 D 68 T	1998		0-N065	TB [TE]	
420 GLS D, 420 TD	05/96-	4 D 68, 4 D 68 T	1998		0-N179	TB [TE]	
PERSONA 400 Hatchback (C9_C, C9_S)							
413 GLSi	01/94-	4 G 13	1299	22x92	SK-1234	BTK	
415 GLi/GLSi	01/94-	4 G 15	1468	22x92	SK-1234	BTK	
1.3	10/05-	4 G 13 M	1298		0-N987	TB [TE]	
1.5	10/05-	4 G 15 M	1468		0-N1129	TB [TE]	
1.8	08/00-12/01	4 G 93 (DOHC)	1834		0-N060	TB [TE]	
413 GLSi	01/94-	4 G 13	1299		0-N987	TB [TE]	
415 GLi/GLSi	01/94-	4 G 15	1468	01/1996 →	0-N1129	TB [TE]	
415 GLi/GLSi	01/94-	4 G 15	1468	→ 11/1998	0-N181	TB [TE]	
415 GLi/GLSi	01/94-	4 G 15	1468	→ 12/1995	0-N987	TB [TE]	
416 GLXi, 416 i	01/94-	4 G 92	1597		0-N052	TB [TE]	
418 GLXi	05/96-	4 G 93 (DOHC)	1834		0-N055	TB [DG]	
418 GLXi	05/96-	4 G 93 (DOHC)	1834		0-N056	TB [TE]	
420 D, 420 GLS D	05/96-	4 D 68, 4 D 68 T	1998		0-N058	TB [DG]	
420 D, 420 GLS D	05/96-	4 D 68, 4 D 68 T	1998		0-N065	TB [TE]	
420 D, 420 GLS D	05/96-	4 D 68, 4 D 68 T	1998		0-N179	TB [TE]	
SAGA Hatchback							
1.3 12V Aeroback, 1.3 GLS 12V	01/91-06/96	4 G 13	1298		0-N987	TB [TE]	
1.3 GLS	10/88-06/91		1298	06/1990 →	0-N987	TB [TE]	
1.5 12V Aeroback	08/92-06/96	4 G 15 P	1468	01/1996 →	0-N1129	TB [TE]	
1.5 12V Aeroback	08/92-06/96	4 G 15 P	1468	→ 12/1995	0-N987	TB [TE]	
1.5 GLS	10/88-06/91		1468	06/1990 →	0-N987	TB [TE]	
1.5 GLS 12V	01/91-06/96	4 G 15	1468		0-N987	TB [TE]	
SAGA Stufenheck							
1.3 12V	08/92-06/96	4 G 13 P	1298	01/1996 →	0-N1129	TB [TE]	
1.3 12V, 1.3 GLE 12V	01/91-06/96	4 G 13, 4 G 13 P	1298		0-N987	TB [TE]	
1.3 GLE	10/88-06/91	4 G 13	1298	06/1990 →	0-N987	TB [TE]	
1.5 12V	08/92-06/96	4 G 15 P	1468	01/1996 →	0-N1129	TB [TE]	
1.5 12V	08/92-06/96	4 G 15 P	1468	→ 12/1995	0-N987	TB [TE]	
1.5 GLE	10/88-06/91		1468	06/1990 →	0-N987	TB [TE]	
1.5 GLE 12V	01/91-06/96	4 G 15	1468		0-N987	TB [TE]	

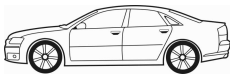

CM³



Art. Nr.



ohne Halter

SALOON Stufenheck (C2_S)

1.3	01/91-06/96	4 G 13, 4 G 13 M	1298		0-N987	TB [TE]
1.5	01/91-11/96	4 G 15	1468		0-N987	TB [TE]

SATRIA (C9_M)

1.3	07/96-	4 G 13	1299		0-N987	TB [TE]
1.3	08/00-	4 G 13 M	1298		0-N987	TB [TE]
1.5	04/96-	4 G 15	1468		0-N1129	TB [TE]

SAVVY

1.2	10/05-		1149	23.4x95	SK-1486	BTK
1.2	10/05-		1149	23.4x95	SK-1486AQ1	BTKW

WIRA

1.3	08/00-	4 G 13, 4 G 13 M	1298		0-N987	TB [TE]
1.5	08/00-	4 G 15, 4 G 15 M	1468		0-N1129	TB [TE]
2.0 D	01/00-	4 D 68	1998		0-N058	TB [DG]
2.0 D	01/00-	4 D 68	1998		0-N065	TB [TE]
2.0 D	01/00-	4 D 68	1998		0-N179	TB [TE]

WIRA Hatchback

1.3	08/00-	4 G 13, 4 G 13 M	1298		0-N987	TB [TE]
1.5	08/00-	4 G 15 M	1468		0-N1129	TB [TE]
2.0 D	01/00-	4 D 68	1998		0-N058	TB [DG]
2.0 D	01/00-	4 D 68	1998		0-N065	TB [TE]
2.0 D	01/00-	4 D 68	1998		0-N179	TB [TE]



CM³



Art. Nr.



ohne Halter

G-MODELL (W 460)							
250 GD	10/87-12/92	OM 602.930	2497	Rippenanzahl: 6; ☼	0-N1288	VB [DG]	
250 GD	10/87-12/92	OM 602.930	2497		0-N1289	VB [BT]	
250 GD	10/87-12/92	OM 602.930	2497	:→004190; hydraulisch	0-N1926	VB [VD]	
250 GD	10/87-12/92	OM 602.930	2497		0-N846	VB [TE]	
250 GD	10/87-12/92	OM 602.930	2497	:→004190	0-N565592	FB [TE]	
G-MODELL (W 461)							
230 GE	06/93-	M 102.996	2298	mit Anbaumaterial; für Fahrzeuge mit Servolenkung	0-N1013	VB [BT]	S
230 GE	06/93-	M 102.996	2298	:021734→;	0-N2144	VB [VD]	
230 GE	06/93-	M 102.996	2298	:054115→; ; ☼	0-N2144	VB [VD]	
230 GE	06/93-	M 102.996	2298	:000255→; :→021733; ; ☼	0-N2145	VB [VD]	
230 GE	06/93-	M 102.996	2298	:000935→; :→054114;	0-N2145	VB [VD]	
230 GE	06/93-	M 102.996	2298		0-N846	VB [TE]	
230 GE	06/93-	M 102.996	2298	für Fahrzeuge ohne Servolenkung	0-N847	VB [TE]	
290 GD/G 290 D	04/92-	OM 602.942	2874	:000036, 000581→	0-N1043	VB [BT]	
290 GD/G 290 D	04/92-	OM 602.942	2874	Rippenanzahl: 6; ☼	0-N1288	VB [DG]	
290 GD/G 290 D	04/92-	OM 602.942	2874	:→000035, 000580	0-N1289	VB [BT]	
290 GD/G 290 D	04/92-	OM 602.942	2874		0-N1452	VB [TE]	
290 GD/G 290 D	04/92-	OM 602.942	2874	:→000035, 000580, 049508; hydraulisch	0-N1926	VB [VD]	
290 GD/G 290 D	04/92-	OM 602.942	2874	:000036, 000581→	0-N2147	VB [VD]	
290 GD/G 290 D	04/92-	OM 602.942	2874		0-N846	VB [TE]	
290 GD/G 290 D	04/92-	OM 602.942	2874	:→000035, 000580, 049508	0-N565592	FB [TE]	
G-MODELL (W 463)							
230 GE	06/90-06/93	M 102.989	2298	mit Anbaumaterial	0-N1013	VB [BT]	S
230 GE	06/90-06/93	M 102.989	2298		0-N846	VB [TE]	
300 GD	09/89-	OM 603.931	2996	:001146, 003135→	0-N1043	VB [BT]	
300 GD	09/89-	OM 603.931	2996	Rippenanzahl: 6	0-N1288	VB [DG]	
300 GD	09/89-	OM 603.931	2996	:→001145, 003134	0-N1289	VB [BT]	
300 GD	09/89-	OM 603.931	2996	:→001145, 003134, 004190; hydraulisch	0-N1926	VB [VD]	
300 GD	09/89-	OM 603.931	2996	:001146, 003135→	0-N2147	VB [VD]	
300 GD, G 300 TD	09/89-	OM 603.931, OM 606.964	2996		0-N846	VB [TE]	
300 GE	06/90-	M 103.987	2960		0-N1011	VB [BT]	S
300 GE	06/90-	M 103.987	2960		0-N1278	VB [TE]	
300 GE	06/90-	M 103.987	2960		0-N2146	VB [VD]	
350 G Turbo D	09/91-	OM 603.972	3449	:002394→	0-N1043	VB [BT]	
350 G Turbo D	09/91-	OM 603.972	3449	Rippenanzahl: 6; ☼	0-N1288	VB [DG]	
350 G Turbo D	09/91-	OM 603.972	3449	:→002393	0-N1289	VB [BT]	
350 G Turbo D	09/91-	OM 603.972	3449	:→002393, 049508; hydraulisch	0-N1926	VB [VD]	
350 G Turbo D	09/91-	OM 603.972	3449	:002394→	0-N2147	VB [VD]	
350 G Turbo D	09/91-	OM 603.972	3449		0-N846	VB [TE]	
G 300 TD	08/96-	OM 606.964	2996		0-N1043	VB [BT]	
G 300 TD	08/96-	OM 606.964	2996		0-N2147	VB [VD]	
G 320	09/94-12/97	M 104.996	3199		0-N1283	VB [TE]	
G 320	09/94-12/97	M 104.996	3199	:→002383	0-N2141	VB [TE]	
G 500	04/98-	M 113.962	4966		0-N1645	VB [BT]	S
G 55 AMG	04/99-	M 113.982	5439		0-N1645	VB [BT]	S
300 GD	09/89-	OM 603.931	2996	:→001145, 003134, 004190	0-N565592	FB [TE]	
350 G Turbo D	09/91-	OM 603.972	3449	:→002393, 049508	0-N565592	FB [TE]	



CM³



Art. Nr.



ohne Halter

9 (L42_)

1.6 D	10/82-12/88	F8M 700, F8M 720, F8M 730	1596	25.4x153; 02/1988 →	SK-1012	BTK
1.6 D	10/82-12/88	F8M 700, F8M 720, F8M 730	1596	25.4x153; 08/1983 → 01/1988	SK-1015	BTK
1.7	09/84-12/89	F2N 700, F2N 704	1721	19.05x124	SK-1010	BTK
1.7	09/84-12/89	F2N 700, F2N 704	1721	19x125; 02/1988 →	SK-1011	BTK
1.7	10/86-12/88	F2N 708, F2N 710, F2N 798, F2N 730, F3N 708, F3N 718	1721	19.05x124; → 12/1987	SK-1010	BTK
1.7	10/86-12/88	F2N 708, F2N 710, F2N 798, F2N 730, F3N 708, F3N 718	1721	19x125; 01/1988 →	SK-1011	BTK
1.6 D	10/82-12/88	F8M 700, F8M 720, F8M 730	1596	02/1988 →	0-N173	TB [TE]
1.6 D	10/82-12/88	F8M 700, F8M 720, F8M 730	1596	02/1988 →	0-N854	TB [DG]
1.6 D	10/82-12/88	F8M 700, F8M 720, F8M 730	1596	→ 01/1988	0-N883	TB [TE]
1.6 D	10/82-12/88	F8M 700, F8M 720, F8M 730	1596	→ 01/1988	0-N887	TB [DG]
1.7	09/84-12/89	F2N 700, F2N 704, F2N 708, F2N 710, F2N 798, F2N 730, F3N 708, F3N 718	1721	02/1988 →	0-N173	TB [TE]
1.7	09/84-12/89	F2N 700, F2N 704, F2N 708, F2N 710, F2N 798, F2N 730, F3N 708, F3N 718	1721	02/1988 →	0-N854	TB [DG]
1.7	09/84-12/89	F2N 700, F2N 704, F2N 708, F2N 710, F2N 798, F2N 730, F3N 708, F3N 718	1721	→ 01/1988	0-N856	TB [TE]
1.7	09/84-12/89	F2N 700, F2N 704, F2N 708, F2N 710, F2N 798, F2N 730, F3N 708, F3N 718	1721	→ 01/1988	0-N887	TB [DG]

11 (B/C37_)

1.6 D	08/83-12/88	F8M 700, F8M 720, F8M 730	1596	25.4x153; 02/1988 →	SK-1012	BTK
1.6 D	08/83-12/88	F8M 700, F8M 720, F8M 730	1596	25.4x153; 02/1984 → 01/1988	SK-1015	BTK
1.7	10/83-12/87	F2N 700, F2N 704	1721	19.05x124	SK-1010	BTK
1.7	10/84-12/88	F3N 718	1721	19.05x124; 07/1986 → 12/1987	SK-1010	BTK
1.7	10/84-12/88	F2N 708, F2N 710, F2N 798, F2N 730, F2N 732, F2N 742, F3N 718	1721	19x125; 01/1988 →	SK-1011	BTK
1.7	10/86-12/88	F2N 708, F2N 710, F2N 798, F2N 730, F2N 732, F2N 742	1721	19.05x124; → 12/1987	SK-1010	BTK
1.7	06/87-12/88	F3N 708	1721	19x125; 02/1988 →	SK-1011	BTK
1.6 D	08/83-12/88	F8M 700, F8M 720, F8M 730	1596	02/1988 →	0-N173	TB [TE]
1.6 D	08/83-12/88	F8M 700, F8M 720, F8M 730	1596	02/1988 →	0-N854	TB [DG]
1.6 D	08/83-12/88	F8M 700, F8M 720, F8M 730	1596	→ 01/1988	0-N883	TB [TE]
1.6 D	08/83-12/88	F8M 700, F8M 720, F8M 730	1596	→ 01/1988	0-N887	TB [DG]
1.7	10/83-12/87	F2N 700, F2N 704	1721		0-N856	TB [TE]
1.7	10/83-12/87	F2N 700, F2N 704	1721		0-N887	TB [DG]
1.7	10/84-12/88	F2N 708, F2N 710, F2N 798, F2N 730, F2N 732, F2N 742, F3N 708, F3N 718	1721	02/1988 →	0-N173	TB [TE]
1.7	10/84-12/88	F2N 708, F2N 710, F2N 798, F2N 730, F2N 732, F2N 742, F3N 708, F3N 718	1721	02/1988 →	0-N854	TB [DG]
1.7	10/84-12/88	F2N 708, F2N 710, F2N 798, F2N 730, F2N 732, F2N 742, F3N 708, F3N 718	1721	→ 01/1988	0-N856	TB [TE]
1.7	10/84-12/88	F2N 708, F2N 710, F2N 798, F2N 730, F2N 732, F2N 742, F3N 708, F3N 718	1721	→ 01/1988	0-N887	TB [DG]
1.6 D	08/83-12/88	F8M 700, F8M 720, F8M 730	1596		0-N141	VB [DG]

11 Kasten (S37_)

1.6 D	08/83-12/88	F8M 700, F8M 720, F8M 730	1596	25.4x153; 02/1988 →	SK-1012	BTK
1.6 D	08/83-12/88	F8M 700, F8M 720, F8M 730	1596	25.4x153; 02/1984 → 01/1988	SK-1015	BTK
1.6 D	08/83-12/88	F8M 700, F8M 720, F8M 730	1596	02/1988 →	0-N173	TB [TE]
1.6 D	08/83-12/88	F8M 700, F8M 720, F8M 730	1596	02/1988 →	0-N854	TB [DG]
1.6 D	08/83-12/88	F8M 700, F8M 720, F8M 730	1596		0-N141	VB [DG]

18 (134_)

2.0	05/82-07/86	J6R 716	1995	19x116; (1995):24262 →	SK-1091	BTK
2.1 Diesel	11/81-07/86	852 710, J8S 711, J8S 711	2068	25x148	SK-1014	BTK
2.1 Diesel	11/81-07/86	852 710, J8S 710	2068	25x148	SK-1063	BTK
2.1 Diesel, 2.1 TD	11/81-07/86	J8S 711, J8S 712	2068	25x148	SK-1063	BTK
2.1 TD	11/81-07/86	J8S 712	2068	25x148; 05/1984 →	SK-1014	BTK
2.0	05/82-07/86	J6R 716	1995		0-N882	TB [TE]
2.1 Diesel, 2.1 TD	11/81-07/86	852 710, J8S 711, J8S 712	2068		0-N857	TB [DG]
2.1 Diesel, 2.1 TD	11/81-07/86	852 710, J8S 711, J8S 712	2068	mit Anbaumaterial	0-N913	TB [TE]
2.2 i	06/84-07/86	J7T 718	2165		0-N882	TB [TE]
2.0	05/82-07/86	J6R 716	1995		0-N1734	VB [DG]

18 Kasten

2.1 Diesel	11/81-07/86	852 710, J8S 711	2068	25x148	SK-1014	BTK
2.1 Diesel	11/81-07/86	852 710	2068	25x148	SK-1063	BTK

18 Variable (135_)

2.0, 2.0 4x4	10/81-12/86	J6R 714, J6R 716, J6R 716	1995	19x116; (1995):24262 →	SK-1091	BTK
--------------	-------------	---------------------------	------	------------------------	---------	-----

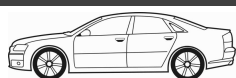

CM³



Art. Nr.



ohne Halter

18 Variable (135_)							
2.1 Diesel	05/79-07/86	852 710, J8S 711, J8S 711	2068	25x148		SK-1014	BTK
2.1 Diesel	05/79-07/86	J8S 711	2068	25x148		SK-1063	BTK
2.1 Diesel	11/80-07/86	852 710, J8S 710	2068	25x148		SK-1063	BTK
2.0, 2.0 4x4	10/81-12/86	J6R 714, J6R 716, J6R 716	1995			0-N882	TB [TE]
2.1 Diesel	11/80-07/86	852 710, J8S 711	2068			0-N857	TB [DG]
2.1 Diesel	11/80-07/86	852 710, J8S 711	2068	mit Anbaumaterial		0-N913	TB [TE]
2.0	10/81-07/86	J6R 716	1995			0-N1734	VB [DG]
19 I (B/C53_)							
1.4	01/88-12/92	E6J 700, E6J 701, E7J 700	1390	17x95		SK-1021	BTK
1.4	01/88-12/92	E6J 700, E6J 701, E7J 700	1390	17x95		SK-1021AQ1	BTKW
1.4	01/89-04/92	C3J 710	1397	17x95		SK-1021	BTK
1.7	09/88-04/92	F2N 720, F3N 740, F3N 741, F3N 742, F3N 743, F3N 746	1721	19x125		SK-1011	BTK
1.8 16V	06/89-04/92	F7P 704	1764	25x148; 02/1990 →		SK-1171	BTK
1.9 D, 1.9 DT	09/88-04/92	F8Q 610, F8Q 706, F8Q 742, F8Q 740	1870	25.4x153		SK-1012	BTK
1.2	01/88-12/92	C1G 730	1237			0-N863	TB [TE]
1.4	01/88-12/92	E6J 700, E6J 701, E7J 700	1390			0-N863	TB [TE]
1.7	09/88-04/92	F3N 740, F3N 741, F3N 742, F3N 743	1721			0-N173	TB [TE]
1.7	09/88-04/92	F3N 740, F3N 741, F3N 742, F3N 743	1721			0-N854	TB [DG]
1.8 16V	06/89-04/92	F7P 704	1764			0-N880	TB [TE]
1.8 16V	06/89-04/92	F7P 704	1764			0-N881	TB [DG]
1.9 D, 1.9 DT	09/88-04/92	F8Q 610, F8Q 706, F8Q 742, F8Q 740	1870			0-N173	TB [TE]
1.9 D, 1.9 DT	09/88-04/92	F8Q 610, F8Q 706, F8Q 742, F8Q 740	1870			0-N854	TB [DG]
1.7	09/88-04/92	F3N 740, F3N 741, F3N 742, F3N 743	1721			0-N138	VB [DG]
1.8 16V	06/89-04/92	F7P 704	1764			0-N138	VB [DG]
1.8 16V	06/89-04/92	F7P 704	1764	mit Anbaumaterial		0-N139	VB [TE]
1.9 D	09/88-04/92	F8Q 706	1870	☼		0-N141	VB [DG]
1.9 D	09/88-04/92	F8Q 706, F8Q 742	1870	mit Anbaumaterial, mit Zubehör		0-N1753	VB [DG]
19 I Cabriolet (D53_)							
1.7	07/91-04/92	F2N 724, F3N 742, F3N 743	1721	19x125		SK-1011	BTK
1.8 16V	07/91-04/92	F7P 700, F7P 704	1764	25x148		SK-1171	BTK
1.7	07/91-04/92	F2N 724, F3N 742, F3N 743	1721			0-N173	TB [TE]
1.7	07/91-04/92	F2N 724, F3N 742, F3N 743	1721			0-N854	TB [DG]
1.8 16V	07/91-04/92	F7P 700, F7P 704	1764			0-N880	TB [TE]
1.8 16V	07/91-04/92	F7P 700, F7P 704	1764			0-N881	TB [DG]
1.7	07/91-04/92	F3N 742, F3N 743	1721			0-N138	VB [DG]
1.8 16V	07/91-04/92	F7P 700, F7P 704	1764			0-N138	VB [DG]
1.8 16V	07/91-04/92	F7P 700, F7P 704	1764	mit Anbaumaterial		0-N139	VB [TE]
19 I Chamade (L53_)							
1.4	07/88-08/90	E6J 700, E6J 701	1390	17x95		SK-1021	BTK
1.7	07/88-12/92	F2N 720, F2N 721, F3N 740, F3N 741, F3N 742, F3N 743	1721	19x125		SK-1011	BTK
1.7	08/88-12/92	F3N 746	1721	19x125; 09/1990 →		SK-1011	BTK
1.8 16V	06/89-08/90	F7P 700	1764	25x148		SK-1171	BTK
1.8 16V	10/89-04/92	F7P 704	1764	25x148; 02/1990 →		SK-1171	BTK
1.9 D, 1.9 DT, 1.9 TD	10/89-04/92	F8Q 706, F8Q 742, F8Q 740	1870	25.4x153		SK-1012	BTK
1.2	01/88-12/92	C1G 730	1237			0-N863	TB [TE]
1.4	07/88-04/92	E6J 700, E6J 701, E7J 700	1390			0-N863	TB [TE]
1.7	07/88-12/92	F2N 720, F2N 721, F3N 740, F3N 741, F3N 742, F3N 743, F3N 746	1721			0-N173	TB [TE]
1.7	07/88-12/92	F2N 720, F2N 721, F3N 740, F3N 741, F3N 742, F3N 743, F3N 746	1721			0-N854	TB [DG]
1.8 16V	10/89-04/92	F7P 704	1764			0-N880	TB [TE]
1.8 16V	10/89-04/92	F7P 704	1764			0-N881	TB [DG]
1.9 D, 1.9 DT, 1.9 TD	10/89-04/92	F8Q 706, F8Q 742, F8Q 740	1870			0-N173	TB [TE]
1.9 D, 1.9 DT, 1.9 TD	10/89-04/92	F8Q 706, F8Q 742, F8Q 740	1870			0-N854	TB [DG]
1.7	07/88-12/92	F2N 720, F2N 721, F3N 740, F3N 741, F3N 742, F3N 743, F3N 746	1721			0-N138	VB [DG]
1.8 16V	10/89-04/92	F7P 704	1764			0-N138	VB [DG]
1.8 16V	10/89-04/92	F7P 704	1764	mit Anbaumaterial		0-N139	VB [TE]
1.9 D	10/89-04/92	F8Q 706	1870	☼		0-N141	VB [DG]
1.9 D	10/89-04/92	F8Q 706, F8Q 742	1870	mit Anbaumaterial, mit Zubehör		0-N1753	VB [DG]
19 I Kasten (S53_)							
1.4	01/88-12/92	E6J 700	1390	17x95		SK-1021	BTK
1.4	01/88-12/92	E6J 700	1390	17x95		SK-1021AQ1	BTKW

CM³

Art. Nr.

**19 I Kasten (S53_)**

1.9 D	01/88-12/92	F8Q 706, F8Q 742	1870	25.4x153; 07/1988 →	SK-1012	BTK
1.2	01/88-12/92	C1G 730	1237		0-N863	TB [TE]
1.4	01/88-12/92	E6J 700	1390		0-N863	TB [TE]
1.9 D	01/88-12/92	F8Q 706, F8Q 742	1870		0-N173	TB [TE]
1.9 D	01/88-12/92	F8Q 706, F8Q 742	1870		0-N854	TB [DG]
1.9 D	01/88-12/92	F8Q 706	1870	✳	0-N141	VB [DG]
1.9 D	01/88-12/92	F8Q 706, F8Q 742	1870	mit Anbaumaterial, mit Zubehör	0-N1753	VB [DG]

19 II (B/C53_)

1.2	05/92-09/94	E7F 730	1171	17x95	SK-1021	BTK
1.2	05/92-09/94	E7F 730	1171	17x95	SK-1021AQ1	BTKW
1.4	01/92-12/95	E6J 700, E7J 706, E7J 742	1390	17x95	SK-1021	BTK
1.4	01/92-12/95	E6J 700, E7J 706, E7J 742	1390	17x95	SK-1021AQ1	BTKW
1.7	04/92-12/95	F3N 740, F3N 741, F3N 743, F3N 746	1721	19x125	SK-1011	BTK
1.8	04/92-12/95	F3P 682, F3P 765, F3P 700, F3P 706, F3P 707, F3P 708, F3P 760, F3P 706, F3P 760	1794	19x125	SK-1011	BTK
1.8 16V	04/92-12/95	F7P 704	1764	25x148	SK-1171	BTK
1.9 D, 1.9 dT	04/92-12/95	F8Q 742, F8Q 744	1870	25.4x153	SK-1012	BTK
1.2	04/92-12/95	C1G 730	1237		0-N863	TB [TE]
1.2	05/92-09/94	E7F 730	1171		0-N863	TB [TE]
1.4	01/92-12/95	E6J 700, E7J 706, E7J 742	1390		0-N863	TB [TE]
1.7	04/92-12/95	F3N 740, F3N 741, F3N 743	1721		0-N173	TB [TE]
1.7	04/92-12/95	F3N 740, F3N 741, F3N 743	1721		0-N854	TB [DG]
1.8	04/92-12/95	F3P 682, F3P 765, F3P 700, F3P 706, F3P 707, F3P 708, F3P 760, F3P 706, F3P 760	1794		0-N173	TB [TE]
1.8	04/92-12/95	F3P 682, F3P 765, F3P 700, F3P 706, F3P 707, F3P 708, F3P 760, F3P 706, F3P 760	1794		0-N854	TB [DG]
1.8 16V	04/92-12/95	F7P 704	1764		0-N880	TB [TE]
1.8 16V	04/92-12/95	F7P 704	1764		0-N881	TB [DG]
1.9 D, 1.9 dT	04/92-12/95	F8Q 742, F8Q 744	1870		0-N173	TB [TE]
1.9 D, 1.9 dT	04/92-12/95	F8Q 742, F8Q 744	1870		0-N854	TB [DG]
1.7	04/92-12/95	F3N 740, F3N 741, F3N 743	1721		0-N138	VB [DG]
1.8	04/92-12/95	F3P 682, F3P 765, F3P 700, F3P 706, F3P 707, F3P 708, F3P 760, F3P 706, F3P 760	1794		0-N138	VB [DG]
1.8 16V	04/92-12/95	F7P 704	1764		0-N138	VB [DG]
1.8 16V	04/92-12/95	F7P 704	1764	mit Anbaumaterial	0-N139	VB [TE]
1.9 D, 1.9 dT	04/92-12/95	F8Q 742, F8Q 744	1870	mit Anbaumaterial, mit Zubehör	0-N1753	VB [DG]

19 II Cabriolet (D53_, 853_)

1.7	04/92-09/93	F3N 742, F3N 743	1721	19x125	SK-1011	BTK
1.8	04/92-06/96	F3P 704, F3P 705, F3P 706, F3P 707, F3P 708, F3P 760	1794	19x125; 03/1993 →	SK-1011	BTK
1.8	09/93-06/96	F3P 682, F3P 764, F3P 765, F3P 706, F3P 760	1794	19x125	SK-1011	BTK
1.8 16V	04/92-06/96	F7P 704	1764	25x148	SK-1171	BTK
1.7	04/92-09/93	F3N 742, F3N 743	1721		0-N173	TB [TE]
1.7	04/92-09/93	F3N 742, F3N 743	1721		0-N854	TB [DG]
1.8	04/92-06/96	F3P 682, F3P 764, F3P 765, F3P 704, F3P 705, F3P 706, F3P 707, F3P 708, F3P 760, F3P 706, F3P 760	1794		0-N173	TB [TE]
1.8	04/92-06/96	F3P 682, F3P 764, F3P 765, F3P 704, F3P 705, F3P 706, F3P 707, F3P 708, F3P 760, F3P 706, F3P 760	1794		0-N854	TB [DG]
1.8 16V	04/92-06/96	F7P 704	1764		0-N880	TB [TE]
1.8 16V	04/92-06/96	F7P 704	1764		0-N881	TB [DG]
1.7	04/92-09/93	F3N 742, F3N 743	1721		0-N138	VB [DG]
1.8	04/92-06/96	F3P 682, F3P 764, F3P 765, F3P 704, F3P 705, F3P 706, F3P 707, F3P 708, F3P 760, F3P 706, F3P 760	1794		0-N138	VB [DG]
1.8 16V	04/92-06/96	F7P 704	1764		0-N138	VB [DG]
1.8 16V	04/92-06/96	F7P 704	1764	mit Anbaumaterial	0-N139	VB [TE]

19 II Chamade (L53_)

1.2	05/92-09/94	E7F 730	1171	17x95	SK-1021	BTK
1.2	05/92-09/94	E7F 730	1171	17x95	SK-1021AQ1	BTKW
1.4	11/93-12/95	E6J 700, E7J 706, E7J 742	1390	17x95	SK-1021	BTK
1.4	11/93-12/95	E6J 700, E7J 706, E7J 742	1390	17x95	SK-1021AQ1	BTKW
1.7	04/92-12/95	F2N 720, F2N 721, F3N 740, F3N 741, F3N 742, F3N 743	1721	19x125	SK-1011	BTK



CM³



Art. Nr.



ohne Halter

19 II Chamade (L53_)								
1.8	04/92-12/95	F3P 700, F3P 700, F3P 706, F3P 704, F3P 705, F3P 706, F3P 707, F3P 708, F3P 760, F3P 706, F3P 760, F3P 765	1794	19x125		SK-1011	BTK	
1.8	05/94-12/95	F3P 682	1783	19x125		SK-1011	BTK	
1.8 16V	04/92-12/95	F7P 704	1764	25x148; 10/1994 →		SK-1171	BTK	
1.9 D , 1.9 dT	04/92-12/95	F8Q 740, F8Q 744, F8Q 742, F8Q 744	1870	25.4x153		SK-1012	BTK	
1.2	05/92-09/94	E7F 730	1171			0-N863	TB [TE]	
1.4	11/93-12/95	E6J 700, E7J 706, E7J 742	1390			0-N863	TB [TE]	
1.7	04/92-12/95	F2N 720, F2N 721, F3N 740, F3N 741, F3N 742, F3N 743	1721			0-N173	TB [TE]	
1.7	04/92-12/95	F2N 720, F2N 721, F3N 740, F3N 741, F3N 742, F3N 743	1721			0-N854	TB [DG]	
1.8	04/92-12/95	F3P 700, F3P 700, F3P 706, F3P 704, F3P 705, F3P 706, F3P 707, F3P 708, F3P 760, F3P 706, F3P 760, F3P 765	1794			0-N173	TB [TE]	
1.8	04/92-12/95	F3P 700, F3P 700, F3P 706, F3P 704, F3P 705, F3P 706, F3P 707, F3P 708, F3P 760, F3P 706, F3P 760, F3P 765	1794			0-N854	TB [DG]	
1.8	05/94-12/95	F3P 682	1783			0-N173	TB [TE]	
1.8	05/94-12/95	F3P 682	1783			0-N854	TB [DG]	
1.8 16V	04/92-12/95	F7P 704	1764			0-N880	TB [TE]	
1.8 16V	04/92-12/95	F7P 704	1764			0-N881	TB [DG]	
1.9 D , 1.9 dT	04/92-12/95	F8Q 740, F8Q 744, F8Q 742, F8Q 744	1870			0-N173	TB [TE]	
1.9 D , 1.9 dT	04/92-12/95	F8Q 740, F8Q 744, F8Q 742, F8Q 744	1870			0-N854	TB [DG]	
1.7	04/92-12/95	F2N 720, F2N 721, F3N 740, F3N 741, F3N 742, F3N 743	1721			0-N138	VB [DG]	
1.8	04/92-12/95	F3P 700, F3P 700, F3P 706, F3P 704, F3P 705, F3P 706, F3P 707, F3P 708, F3P 760, F3P 706, F3P 760, F3P 765	1794			0-N138	VB [DG]	
1.8	05/94-12/95	F3P 682	1783			0-N138	VB [DG]	
1.8 16V	04/92-12/95	F7P 704	1764			0-N138	VB [DG]	
1.8 16V	04/92-12/95	F7P 704	1764	mit Anbaumaterial		0-N139	VB [TE]	
1.9 D , 1.9 dT	04/92-12/95	F8Q 740, F8Q 744, F8Q 742, F8Q 744	1870	mit Anbaumaterial, mit Zubehör		0-N1753	VB [DG]	
19 II Kasten (S53_)								
1.4	03/92-12/95	E6J 700	1390	17x95		SK-1021	BTK	
1.4	03/92-12/95	E6J 700	1390	17x95		SK-1021AQ1	BTKW	
1.9 D , 1.9 dT	03/92-12/95	F8Q 706, F8Q 742, F8Q 740	1870	25.4x153		SK-1012	BTK	
1.2	03/92-12/95	C1G 730	1237			0-N863	TB [TE]	
1.4	03/92-12/95	E6J 700	1390			0-N863	TB [TE]	
1.9 D , 1.9 dT	03/92-12/95	F8Q 706, F8Q 742, F8Q 740	1870			0-N173	TB [TE]	
1.9 D , 1.9 dT	03/92-12/95	F8Q 706, F8Q 742, F8Q 740	1870			0-N854	TB [DG]	
1.9 D	03/92-12/95	F8Q 706	1870	☼		0-N141	VB [DG]	
1.9 D , 1.9 dT	03/92-12/95	F8Q 706, F8Q 742, F8Q 740	1870	mit Anbaumaterial, mit Zubehör		0-N1753	VB [DG]	
20 (127_)								
2.1 Diesel	10/80-12/83	852	2068	25x148		SK-1014	BTK	
2.1 Diesel	10/80-12/83	852	2068	25x148		SK-1063	BTK	
2.0	10/77-12/83	829 700, 829 701, 829.01, 829 702, 829 703	1995			0-N882	TB [TE]	
2.1 Diesel , 2.1 TD	10/80-12/83	852, J8S 702	2068			0-N857	TB [DG]	
2.1 Diesel , 2.1 TD	10/80-12/83	852, J8S 702	2068	mit Anbaumaterial		0-N913	TB [TE]	
2.2	10/80-12/83	851 700	2165			0-N882	TB [TE]	
21 (B48_)								
1.4	09/89-05/93	C2J 770	1397	19x125		SK-1011	BTK	
1.7	07/89-06/94	F2N 711, F2N 754, F2N 712, F3N 726, F3N 722, F3N 723, F3N 726	1721	19x125		SK-1011	BTK	
1.9 D	09/89-01/94	F8Q 710	1870	25.4x153		SK-1012	BTK	
2.0 , 2.0 4x4 , 2.0 TXI	07/89-12/93	J7R 740, J7R 740, J7R 754, J7R 746, J7R 747, J7R 750, J7R 751	1995	19x116		SK-1091	BTK	
2.1 D	07/89-06/94	J8S 600, J8S 740, J8S 704, J8S 784, J8S 784	2068	25x148		SK-1014	BTK	
2.1 D	07/89-05/93	J8S 704	2068	25x148		SK-1063	BTK	
2.1 D	09/89-06/94	J8S 600, J8S 740, J8S 784	2068	25x148		SK-1063	BTK	
2.1 Turbo-D	09/89-06/94	J8S 786, J8S 788	2068	25x148		SK-1014	BTK	
2.1 Turbo-D	09/89-06/94	J8S 714	2068	25x148		SK-1063	BTK	
2.2	07/89-05/93	J7T 755	2165	19x118; Baumuster: B48K		SK-1092	BTK	
2.2 , 2.2 4x4	09/89-06/94	J7T 754	2165	19x118; Baumuster: B48K		SK-1092	BTK	
1.7	09/89-06/94	F3N 722, F3N 723, F3N 726	1721			0-N173	TB [TE]	
1.7	09/89-06/94	F3N 722, F3N 723, F3N 726	1721			0-N854	TB [DG]	
1.9 D	09/89-01/94	F8Q 710	1870			0-N173	TB [TE]	



CM³



Art. Nr.



21 (B48_)

1.9 D	09/89-01/94	F8Q 710	1870		0-N854	TB [DG]
2.0, 2.0 4x4	09/89-12/93	J7R 740, J7R 746, J7R 747	1995		0-N882	TB [TE]
2.1 D, 2.1 Turbo-D	09/89-06/94	J8S 600, J8S 740, J8S 714, J8S 786, J8S 788, J8S 784	2068		0-N857	TB [DG]
2.1 D, 2.1 Turbo-D	09/89-06/94	J8S 600, J8S 740, J8S 714, J8S 786, J8S 788, J8S 784	2068	mit Anbaumaterial	0-N913	TB [TE]
2.2, 2.2 4x4	09/89-06/94	J7T 754, J7T 755	2165		0-N882	TB [TE]

21 Kasten (S48_)

1.7	06/86-04/95	F2N 710	1721	19.05x124; → 12/1987	SK-1010	BTK
1.7	06/86-04/95	F2N 710	1721	19x125; 01/1988 →	SK-1011	BTK
1.9 D	06/86-08/94	F8Q 710	1870	25.4x153	SK-1012	BTK
2.1 D	06/86-08/94	J8S 704	2068	25x148	SK-1014	BTK
2.1 D	06/86-08/94	J8S 704	2068	25x148	SK-1063	BTK
1.7	06/86-04/95	F2N 710	1721	02/1988 →	0-N173	TB [TE]
1.7	06/86-04/95	F2N 710	1721	02/1988 →	0-N854	TB [DG]
1.9 D	06/86-08/94	F8Q 710	1870		0-N173	TB [TE]
1.9 D	06/86-08/94	F8Q 710	1870		0-N854	TB [DG]

21 Kombi (K48_)

1.7	06/86-03/93	F2N 710, F2N 712, F2N 750, F2N 752, F3N 722, F3N 723	1721	19.05x124; → 12/1987	SK-1010	BTK
1.7	06/86-03/93	F2N 710, F2N 712, F2N 750, F2N 752, F3N 722, F3N 723	1721	19x125; 01/1988 →	SK-1011	BTK
1.7	05/88-06/93	F3N 726	1721	19x125	SK-1011	BTK
1.7	10/89-12/93	F3N 722, F3N 723	1721	19x125; 04/1992 →	SK-1011	BTK
1.9 D	03/86-08/94	F8Q 710	1870	25.4x153	SK-1012	BTK
2.0, 2.0 4x4	03/86-02/94	J6R 758, J6R 759, J6R 792, J7R 740, J7R 746, J7R 747, J7R 750, J7R 751	1995	19x116	SK-1091	BTK
2.1 D, 2.1 D 4x4	10/86-09/95	J8S 600, J8S 740, J8S 704, J8S 784	2068	25x148	SK-1014	BTK
2.1 D, 2.1 D 4x4	10/86-09/95	J8S 600, J8S 740, J8S 704, J8S 784	2068	25x148	SK-1063	BTK
2.1 Turbo-D	10/86-11/93	J8S 714	2068	25x148	SK-1014	BTK
2.1 Turbo-D	10/86-11/93	J8S 714	2068	25x148	SK-1063	BTK
2.2, 2.2 4x4	06/86-12/93	J7T 754	2165	19x118	SK-1092	BTK
1.7	06/86-03/93	F2N 710, F2N 712, F2N 750, F2N 752, F3N 722, F3N 723	1721	02/1988 →	0-N173	TB [TE]
1.7	06/86-03/93	F2N 710, F2N 712, F2N 750, F2N 752, F3N 722, F3N 723	1721	02/1988 →	0-N854	TB [DG]
1.7	06/86-03/93	F2N 710, F2N 712, F2N 750, F2N 752, F3N 722, F3N 723	1721	→ 01/1988	0-N856	TB [TE]
1.7	06/86-03/93	F2N 710, F2N 712, F2N 750, F2N 752, F3N 722, F3N 723	1721	→ 01/1988	0-N887	TB [DG]
1.7	05/88-12/93	F3N 722, F3N 723, F3N 726	1721		0-N173	TB [TE]
1.7	05/88-12/93	F3N 722, F3N 723, F3N 726	1721		0-N854	TB [DG]
1.9 D	03/86-08/94	F8Q 710	1870		0-N173	TB [TE]
1.9 D	03/86-08/94	F8Q 710	1870		0-N854	TB [DG]
2.0, 2.0 4x4	03/86-02/94	J7R 740, J7R 746, J7R 747, J7R 750, J7R 751	1995		0-N882	TB [TE]
2.1 D, 2.1 D 4x4, 2.1 Turbo-D	10/86-09/95	J8S 600, J8S 740, J8S 704, J8S 714, J8S 786, J8S 788, J8S 784	2068		0-N857	TB [DG]
2.1 D, 2.1 D 4x4, 2.1 Turbo-D	10/86-09/95	J8S 600, J8S 740, J8S 704, J8S 714, J8S 786, J8S 788, J8S 784	2068	mit Anbaumaterial	0-N913	TB [TE]
2.2, 2.2 4x4	06/86-12/93	J7T 754, J7T 755	2165		0-N882	TB [TE]

21 Stufenheck (L48_)

1.7	03/86-02/94	F2N 710, F2N 752, F3N 722, F3N 723	1721	19.05x124; → 12/1987	SK-1010	BTK
1.7	03/86-12/87	F2N 712	1721	19.05x124	SK-1010	BTK
1.7	03/86-02/94	F2N 710, F2N 752, F3N 722, F3N 723	1721	19x125; 01/1988 →	SK-1011	BTK
1.7	07/86-02/94	F2N 750, F3N 726	1721	19x125; 06/1988 →	SK-1011	BTK
1.7	09/89-02/94	F3N 722, F3N 723	1721	19x125	SK-1011	BTK
1.9 D	08/89-10/93	F8Q 710	1870	25.4x153	SK-1012	BTK
2.0, 2.0 4x4	03/86-06/94	J6R 758, J6R 759, J6R 792, J6R 793, J6R 792, J6R 793, J7R 740, J7R 746, J7R 747, J7R 750, J7R 751	1995	19x116	SK-1091	BTK
2.1 D, 2.1 TD	03/86-06/94	J8S 600, J8S 740, J8S 704, J8S 784	2068	25x148	SK-1014	BTK
2.1 D, 2.1 TD	03/86-06/94	J8S 600, J8S 740, J8S 704, J8S 784	2068	25x148	SK-1063	BTK
2.1 Turbo-D	03/86-06/94	J8S 714, J8S 786, J8S 788	2068	25x148; 04/1986 →	SK-1014	BTK
2.1 Turbo-D	03/86-06/94	J8S 714, J8S 786, J8S 788	2068	25x148; 07/1989 →	SK-1014	BTK
2.1 Turbo-D	03/86-06/94	J8S 714	2068	25x148	SK-1063	BTK
2.2	04/86-06/89	J7T 755	2165	19x118	SK-1092	BTK
2.2, 2.2 4x4	07/86-02/94	J7T 754	2165	19x118	SK-1092	BTK



CM³



Art. Nr.



ohne Halter

21 Stufenheck (L48_)

1.7	03/86-02/94	F2N 710, F2N 750, F3N 726, F2N 752, F3N 722, F3N 723	1721	02/1988 →		0-N173	TB [TE]
1.7	03/86-02/94	F2N 710, F2N 750, F3N 726, F2N 752, F3N 722, F3N 723	1721	02/1988 →		0-N854	TB [DG]
1.7	03/86-02/94	F2N 710, F2N 750, F3N 726, F2N 752, F3N 722, F3N 723	1721	→ 01/1988		0-N856	TB [TE]
1.7	03/86-12/87	F2N 712	1721			0-N856	TB [TE]
1.7	03/86-02/94	F2N 710, F2N 750, F3N 726, F2N 752, F3N 722, F3N 723	1721	→ 01/1988		0-N887	TB [DG]
1.7	03/86-12/87	F2N 712	1721			0-N887	TB [DG]
1.7	09/89-02/94	F3N 722, F3N 723	1721			0-N173	TB [TE]
1.7	09/89-02/94	F3N 722, F3N 723	1721			0-N854	TB [DG]
1.9 D	08/89-10/93	F8Q 710	1870			0-N173	TB [TE]
1.9 D	08/89-10/93	F8Q 710	1870			0-N854	TB [DG]
2.0, 2.0 4x4, 2.0 Turbo, 2.0 Turbo 4x4	03/86-06/94	J6R 758, J6R 758, J6R 759, J6R 792, J6R 793, J7R 740, J7R 746, J7R 747, J7R 750, J7R 751, J7R 752, J7R 756	1995			0-N882	TB [TE]
2.1 D, 2.1 TD, 2.1 Turbo-D	03/86-06/94	J8S 600, J8S 740, J8S 704, J8S 714, J8S 786, J8S 788, J8S 784	2068			0-N857	TB [DG]
2.1 D, 2.1 TD, 2.1 Turbo-D	03/86-06/94	J8S 600, J8S 740, J8S 704, J8S 714, J8S 786, J8S 788, J8S 784	2068	mit Anbaumaterial		0-N913	TB [TE]
2.2, 2.2 4x4	07/86-02/94	J7T 754, J7T 755	2165			0-N882	TB [TE]

25 (B29_)

2.0, 2.0 12V	04/84-12/93	J6R 706, J6R 707, J6R 760, J6R 762, J6R 763, J7R 720, J7R 721, J7R 722, J7R 723, J7R 726	1995	19x116		SK-1091	BTK
2.1 Diesel	04/84-05/89	J8S 706	2068	25x148		SK-1063	BTK
2.1 Diesel	06/89-12/92	J8S 736	2068	25x148		SK-1014	BTK
2.1 Diesel	06/89-12/92	J8S 736	2068	25x148; → 03/1992		SK-1063	BTK
2.1 Diesel, 2.1 Turbo-D	04/84-12/92	J8S 706, J8S 708, J8S 738	2068	25x148; 05/1984 →		SK-1014	BTK
2.1 Turbo-D	04/84-12/92	J8S 708	2068	25x148; → 03/1992		SK-1063	BTK
2.2	04/84-12/89	J7T 706, J7T 707	2165	19x118; Baumuster: B29E		SK-1092	BTK
2.2	04/84-12/89	J7T 730	2165	19x118; Baumuster: B29E		SK-1092	BTK
2.2	11/85-03/89	J7T 708, J7T 732	2165	19x118; Baumuster: B29B		SK-1092	BTK
2.2	09/86-12/92	J7T 732	2165	19x118; Baumuster: B29B		SK-1092	BTK
2.0, 2.0 12V	04/84-12/93	J6R 706, J6R 707, J6R 760, J6R 762, J6R 763, J7R 720, J7R 721, J7R 722, J7R 723, J7R 726	1995			0-N882	TB [TE]
2.1 Diesel, 2.1 Turbo-D	04/84-12/92	J8S 706, J8S 708, J8S 738, J8S 736	2068			0-N857	TB [DG]
2.1 Diesel, 2.1 Turbo-D	04/84-12/92	J8S 706, J8S 708, J8S 738, J8S 736	2068	mit Anbaumaterial		0-N913	TB [TE]
2.2	04/84-12/92	J7T 706, J7T 707, J7T 714, J7T 715, J7T 708, J7T 732, J7T 708, J7T 732, J7T 733, J7T 730, J7T 731	2165			0-N882	TB [TE]

30 (127_)

2.1 Turbo-D	02/82-03/86	J8S 702	2068	25x148		SK-1014	BTK
2.1 Turbo-D	02/82-03/86	J8S 702	2068	25x148; → 06/1984		SK-1063	BTK
2.1 Turbo-D	02/82-03/86	J8S 702	2068			0-N857	TB [DG]
2.1 Turbo-D	02/82-03/86	J8S 702	2068	mit Anbaumaterial		0-N913	TB [TE]

AVANTIME (DE0_)

2.0 16V Turbo	11/01-05/03	F4R 760, F4R 761	1998	27x126		SK-1624	BTK
2.0 16V Turbo	11/01-05/03	F4R 760, F4R 761	1998	27x126		SK-1624AQ1	BTKW
2.2 dCi	05/02-05/03	G9T 712	2188	25x89; mit Zubehör		SK-1489	BTK
3.0 V6	09/01-05/03	L7X 720, L7X 721	2946	32x259		SK-1483	BTK
3.0 V6	09/01-05/03	L7X 720, L7X 721	2946	32x259		SK-1483AQ1	BTKW
2.0 16V Turbo	11/01-05/03	F4R 760, F4R 761	1998			0-N1365	TB [DG]
2.0 16V Turbo	11/01-05/03	F4R 760, F4R 761	1998			0-N200	TB [TE]
2.2 dCi	05/02-05/03	G9T 712	2188			0-N1269	TB [TE]
2.2 dCi	05/02-05/03	G9T 712	2188			0-N1270	TB [DG]
3.0 V6	09/01-05/03	L7X 720, L7X 721	2946			0-N1056	TB [TE]
3.0 V6	09/01-05/03	L7X 720, L7X 721	2946			0-N170	TB [DG]
3.0 V6	09/01-05/03	L7X 720, L7X 721	2946			0-N171	TB [DG]
2.0 16V Turbo	11/01-05/03	F4R 760, F4R 761	1998	☼		0-N1409	VB [DG]
2.0 16V Turbo	11/01-05/03	F4R 760, F4R 761	1998	☼		0-N1611	VB [BT] S
2.2 dCi	05/02-05/03	G9T 712	2188			0-N1409	VB [DG]
2.2 dCi	05/02-05/03	G9T 712	2188			0-N1731	VB [BT] S
3.0 V6	09/01-05/03	L7X 720, L7X 721	2946			0-N1449	VB [TE]
3.0 V6	09/01-05/03	L7X 720, L7X 721	2946			0-N1473	VB [BT] S
3.0 V6	09/01-05/03	L7X 720, L7X 721	2946			0-N1757	VB [VD]

CM³

Art. Nr.



CAPTUR

1.5 dCi 110, 1.5 dCi 90	06/13-	K9K 608, K9K 609, K9K 612, K9K 646	1461		0-N2423	TB [TE]	
0.9 TCe 90	06/13-	H4Bt400	898		0-N2308	VB [BT]	S
1.2 TCe 120	06/13-	H5F 403	1197		0-N2308	VB [BT]	S
1.5 dCi 110, 1.5 dCi 90	06/13-	K9K 608, K9K 609, K9K 612, K9K 646	1461	☞	0-N2253	VB [DG]	

CLIO I (B/C57_, 5/357_)

1.2	05/90-09/98	E5F 710, E7F 700, E7F 708, E7F 750, E7F 706	1171	17x95	SK-1021	BTK	
1.2	05/90-09/98	E5F 710, E7F 700, E7F 708, E7F 750, E7F 706	1171	17x95	SK-1021AQ1	BTKW	
1.2	01/96-09/98	D7F 730	1149	17x87; 05/1996 →; Baumuster: 357K, 357Y, 557K, 557Y	SK-1081	BTK	
1.2	01/96-09/98	D7F 730	1149	17x87; 05/1996 →; Baumuster: 357Y, 557Y	SK-1081	BTK	
1.2	01/96-09/98	D7F 730	1149	17x87	SK-1081AQ2	BTKW	
1.4	05/90-09/98	E6J 712, E6J 713, E6J 760, E7J 601, E7J 718, E7J 719, E7J 754, E7J 710, E7J 711, E7J 756, E7J 757	1390	17x95	SK-1021	BTK	
1.4	05/90-09/98	E6J 712, E6J 713, E6J 760, E7J 601, E7J 718, E7J 719, E7J 754, E7J 710, E7J 711, E7J 756, E7J 757	1390	17x95	SK-1021AQ1	BTKW	
1.7	01/91-12/93	F2N 770	1721	19x125	SK-1011	BTK	
1.8, 1.8 Rsi	01/91-09/98	F3P 710, F3P 710, F3P 714, F3P 712, F3P 754, F3P 755	1794	19x125	SK-1011	BTK	
1.8 16V	01/91-03/96	F7P 722	1764	25x148	SK-1171	BTK	
1.8, 1.8 Rsi	08/90-09/98	F3P 755, F3P 758	1783	19x125	SK-1011	BTK	
1.9 D	01/91-09/98	F8Q 730, F8Q 732	1870	25.4x151; 1	SK-1013	BTK	
1.9 D	01/91-09/98	F8Q 730, F8Q 732	1870	25.4x151; 10/1996 →; beinhaltetete Rollen: 2	SK-1108S	BTK	
1.9 D	05/96-02/98	F8Q 632, F8Q 676, F8Q 696, F8Q 714	1870	25.4x151; → 09/1996	SK-1013	BTK	
1.9 D	05/96-02/98	F8Q 632, F8Q 676, F8Q 696, F8Q 714	1870	25.4x151; 09/1996 →; beinhaltetete Rollen: 3; mit Zahnrad	SK-1108	BTK	
1.9 D	05/96-02/98	F8Q 632, F8Q 676, F8Q 696, F8Q 714	1870	25.4x151; 09/1996 →; beinhaltetete Rollen: 2	SK-1108S	BTK	
1.9 D	01/97-09/98	F8Q 678	1870	25.4x151; beinhaltetete Rollen: 2	SK-1108S	BTK	
Williams	01/94-09/98	F7R 700	1998	25x148	SK-1089	BTK	
Williams	01/94-09/98	F7R 700	1998	25x148	SK-1171	BTK	
1.2	05/90-09/98	E5F 710, E7F 700, E7F 708, E7F 750, E7F 706	1171		0-N863	TB [TE]	
1.2	01/96-09/98	D7F 730	1149		0-N863	TB [TE]	
1.4	01/91-09/98	E7J 601, E7J 718, E7J 719, E7J 754, E7J 710, E7J 711, E7J 756, E7J 757	1390		0-N863	TB [TE]	
1.7	01/91-12/93	F2N 770	1721		0-N173	TB [TE]	
1.7	01/91-12/93	F2N 770	1721		0-N854	TB [DG]	
1.8, 1.8 Rsi	01/91-09/98	F3P 710, F3P 710, F3P 714, F3P 712, F3P 754, F3P 755	1794		0-N173	TB [TE]	
1.8, 1.8 Rsi	01/91-09/98	F3P 710, F3P 710, F3P 714, F3P 712, F3P 754, F3P 755	1794		0-N854	TB [DG]	
1.8 16V	01/91-03/96	F7P 722	1764		0-N880	TB [TE]	
1.8 16V	01/91-03/96	F7P 722	1764		0-N881	TB [DG]	
1.8 Rsi	08/95-09/98	F3P 758	1783		0-N173	TB [TE]	
1.8, 1.8 Rsi	08/90-09/98	F3P 755, F3P 758	1783		0-N854	TB [DG]	
1.9 D	05/96-02/98	F8Q 696	1870		0-N147	TB [DG]	
1.9 D, 1.9 D	01/91-09/98	F8Q 678, F8Q 730, F8Q 732	1870		0-N173	TB [TE]	
1.9 D, 1.9 D	01/91-09/98	F8Q 632, F8Q 676, F8Q 696, F8Q 714, F8Q 678, F8Q 730, F8Q 732	1870		0-N881	TB [DG]	
Williams	01/94-09/98	F7R 700	1998		0-N880	TB [TE]	
Williams	01/94-09/98	F7R 700	1998		0-N881	TB [DG]	
1.2	01/96-09/98	D7F 730	1149		0-N1589	VB [TE]	
1.7	01/91-12/93	F2N 770	1721	mit Anbaumaterial, mit Zubehör	0-N1753	VB [DG]	
1.8	08/90-04/96	F3P 755	1783		0-N138	VB [DG]	
1.8	08/90-04/96	F3P 755	1783	mit Anbaumaterial, mit Zubehör; ☞	0-N2176	VB [DG]	
1.8	01/91-09/98	F3P 710, F3P 714	1794	→ 01/1993; mit Anbaumaterial, mit Zubehör	0-N1753	VB [DG]	
1.8	01/91-09/98	F3P 710	1794	☞: → 930100; mit Anbaumaterial, mit Zubehör	0-N1753	VB [DG]	
1.8	01/91-09/98	F3P 710, F3P 710, F3P 714	1794	01/1993 →; mit Anbaumaterial, mit Zubehör	0-N2176	VB [DG]	
1.8, 1.8 Rsi	01/91-09/98	F3P 710, F3P 714, F3P 712	1794		0-N138	VB [DG]	
1.8, 1.8 Rsi	01/93-09/98	F3P 712, F3P 754, F3P 755	1794	mit Anbaumaterial, mit Zubehör	0-N2176	VB [DG]	
1.8 16V	01/91-03/96	F7P 722	1764	mit Anbaumaterial	0-N139	VB [TE]	
1.8 Rsi	01/93-08/95	F3P 712	1794	mit Anbaumaterial, mit Zubehör	0-N1753	VB [DG]	
1.8 Rsi	08/95-09/98	F3P 758	1783	mit Anbaumaterial, mit Zubehör	0-N2176	VB [DG]	



CM³



Art. Nr.



CLIO I (B/C57_, 5/357_)							
Williams	01/94-09/98	F7R 700	1998	mit Anbaumaterial	0-N139	VB [TE]	
CLIO I Kasten (S57_)							
1.2	01/91-09/98	E7F 706, E7F 750	1171	17x95	SK-1021	BTK	
1.2	01/91-09/98	E7F 706, E7F 750	1171	17x95	SK-1021AQ1	BTKW	
1.9 D	01/91-09/98	F8Q 730, F8Q 732	1870	25.4x151; beinhaltetete Rollen: 2	SK-1108S	BTK	
1.9 D, 1.9 RND	01/91-09/98	F8Q 678, F8Q 730, F8Q 732	1870	25.4x151; → 09/1996	SK-1013	BTK	
1.2	01/91-09/98	E7F 706, E7F 750	1171		0-N863	TB [TE]	
1.9 D	01/91-09/98	F8Q 730, F8Q 732	1870		0-N173	TB [TE]	
1.9 D, 1.9 RND	01/91-09/98	F8Q 678, F8Q 730, F8Q 732	1870		0-N881	TB [DG]	
CLIO II (BB0/1/2_, CB0/1/2_)							
1.2	09/98-	D7F 720, D7F 726	1149	17x87; Baumuster: BB0A, BB0F, BB10, BB1K	SK-1081	BTK	
1.2	06/01-		1149	23.4x95; Baumuster: BB05, BB0W, BB11, BB27	SK-1486	BTK	
1.2, 1.2 LPG	09/98-06/09	D7F 722, D7F 764, D7F 766	1149	17x87	SK-1081	BTK	
1.2, 1.2 LPG	09/98-06/09	D7F 720, D7F 726, D7F 746, D7F 764, D7F 766, D7F 722, D7F 764, D7F 766	1149	17x87	SK-1081AQ2	BTKW	
1.2 16V	06/01-	D4F706, D4F712	1149	23.4x95; Baumuster: BB05, BB0W, BB11, BB27	SK-1486	BTK	
1.2, 1.2 16V	06/01-	D4F 706, D4F 712, D4F 714, D4F 722, D4F 728	1149	23.4x95	SK-1486AQ1	BTKW	
1.4	09/98-05/05	E7J 634, E7J 780, K7J 700	1390	17x96	SK-1338	BTK	
1.4	09/98-05/05	E7J 634, E7J 780, K7J 700	1390	17x96	SK-1338AQ1	BTKW	
1.4 16V	10/99-09/04	K4J 710, K4J 711, K4J 712, K4J 713, K4J 712, K4J 713	1390	27x132; mit Zubehör	SK-1088	BTK	
1.4 16V	10/99-09/04	K4J 710, K4J 711, K4J 712, K4J 713, K4J 712, K4J 713	1390	27x132; mit Zubehör	SK-1088AQ1	BTKW	
1.5 dCi	06/01-	K9K 700, K9K 704	1461	27x123; → 08/2003; mit Zubehör; Baumuster: BB07, BB1W, CB07, CB1W	SK-1487	BTK	
1.5 dCi	06/01-	K9K 702	1461	27x123; → 08/2003; mit Zubehör; Baumuster: BB08, CB08	SK-1487	BTK	
1.5 dCi	06/01-10/03	K9K 702	1461	27x123; mit Zubehör; Baumuster: BB08, CB08	SK-1487	BTK	
1.5 dCi	06/01-10/03	K9K 700, K9K 704, K9K 700, K9K 714, K9K 702, K9K 718, K9K 740	1461	27x123; mit Zubehör	SK-1487AQ1	BTKW	
1.5 dCi	06/01-12/06	K9K 704	1461	27x123; → 08/2003; mit Zubehör	SK-1487AQ1	BTKW	
1.5 dCi	06/01-	K9K 700, K9K 704, K9K 702, K9K 712	1461	27x123; 04/2004 →; mit Zubehör	SK-1487AQ2	BTKW	
1.5 dCi	06/01-10/03	K9K 700, K9K 714, K9K 702, K9K 718, K9K 740	1461	27x123; mit Zubehör	SK-1487AQ2	BTKW	
1.5 dCi	01/04-	K9K 712	1461	27x123; mit Zubehör	SK-1487	BTK	
1.5 dCi	01/04-	K9K 712	1461	27x123; → 03/2004; mit Zubehör	SK-1487AQ1	BTKW	
1.5 dCi	08/04-	K9K 700, K9K 714	1461	27x123; mit Zubehör; Baumuster: BB2J, CB2J	SK-1487	BTK	
1.5 dCi	06/05-	K9K 740	1461	27x123; mit Zubehör; Baumuster: BB3M, CB3M	SK-1487	BTK	
1.5 dCi	02/07-	K9K 718	1461	27x123; mit Zubehör; Baumuster: CB3N	SK-1487	BTK	
1.6	09/98-05/05	K7M 744, K7M 745	1598	17x96	SK-1338	BTK	
1.6	09/98-05/05	K7M 744, K7M 745	1598	17x96	SK-1338AQ2	BTKW	
1.6 16V, 1.6 Hi-Flex	09/98-02/10	K4M 708, K4M 740, K4M 742, K4M 743, K4M 744, K4M 745, K4M 748, K4M 748	1598	27x132; mit Zubehör	SK-1088	BTK	
1.6 16V, 1.6 Hi-Flex	09/98-02/10	K4M 708, K4M 740, K4M 742, K4M 743, K4M 744, K4M 745, K4M 748, K4M 748	1598	27x132; mit Zubehör	SK-1088AQ1	BTKW	
1.9 D	09/98-05/05	F8Q 630	1870	25.4x151; beinhaltetete Rollen: 3; mit Zahnrad; Baumuster: BB02, BB0E, CB0E	SK-1108	BTK	
1.9 D	09/98-05/05	F8Q 630	1870	25.4x151; beinhaltetete Rollen: 2; Baumuster: BB02, BB0E, CB0E	SK-1108S	BTK	
1.9 D	02/00-05/01	F8Q 630, F8Q 632	1870	25.4x151; beinhaltetete Rollen: 3; mit Zahnrad; Baumuster: BB0J, CB0J	SK-1108	BTK	
1.9 D	02/00-05/01	F8Q 630, F8Q 632	1870	25.4x151; beinhaltetete Rollen: 2; Baumuster: BB0J, CB0J	SK-1108S	BTK	
1.9 dTi	12/99-05/05	F9Q 780	1870	26x153; beinhaltetete Rollen: 4; mit Zahnrad; mit Zubehör	SK-1490	BTK	
1.9 dTi	12/99-05/05	F9Q 780	1870	26x153; beinhaltetete Rollen: 2	SK-1620	BTK	
1.9 dTi	12/99-05/05	F9Q 780	1870	26x153; beinhaltetete Rollen: 3; mit Zubehör	SK-1622	BTK	
2.0 16V Sport	02/00-	F4R 730, F4R 736	1998	27x128	SK-1494	BTK	
2.0 16V Sport	02/00-	F4R 730, F4R 736, F4R 738	1998	27x128	SK-1631	BTK	
3.0 V6 Sport	11/00-12/02	L7X 760	2946	32x259; 06/2001 →	SK-1483	BTK	
3.0 V6 Sport	11/00-12/02	L7X 760, L7X 762	2946	32x259	SK-1483AQ1	BTKW	
3.0 V6 Sport	12/02-	L7X 762	2946	32x259	SK-1483	BTK	
1.2	09/98-05/01	D7F 720, D7F 726, D7F 746, D7F 764, D7F 766, D7F 722	1149		0-N863	TB [TE]	

CM³

Art. Nr.



ohne Halter

CLIO II (BB0/1/2_, CB0/1/2_)

1.2, 1.2 16V	06/01-	D4F 706, D4F 712, D4F 714, D4F 722, D4F 728	1149		0-N1112	TB [TE]	
1.4	09/98-05/05	E7J 780	1390		0-N145	TB [TE]	
1.4	09/98-05/05	K7J 700	1390		0-N145	TB [TE]	
1.4 16V	10/99-09/04	K4J 710, K4J 711, K4J 712, K4J 713, K4J 712, K4J 713	1390		0-N198	TB [TE]	
1.4 16V	10/99-09/04	K4J 710, K4J 711, K4J 712, K4J 713, K4J 712, K4J 713	1390		0-N262	TB [DG]	
1.5 dCi	06/01-12/06	K9K 700, K9K 704, K9K 700, K9K 714, K9K 702, K9K 704, K9K 712, K9K 718, K9K 740	1461		0-N1111	TB [TE]	
1.6	09/98-05/05	K7M 744	1598		0-N145	TB [TE]	
1.6	09/98-05/05	K7M 745	1598		0-N145	TB [TE]	
1.6 16V , 1.6 Flex, 1.6 Hi-Flex	09/98-02/10	K4M 708, K4M 740, K4M 742, K4M 743, K4M 744, K4M 745, K4M 748, K4M 740, K4M 748, K4M 748	1598		0-N262	TB [DG]	
1.6 16V , 1.6 Hi-Flex	09/98-02/10	K4M 708, K4M 740, K4M 742, K4M 743, K4M 744, K4M 745, K4M 748, K4M 748	1598		0-N198	TB [TE]	
1.9 D	09/98-05/05	F8Q 630, F8Q 630, F8Q 632	1870		0-N173	TB [TE]	
1.9 D	09/98-05/05	F8Q 630, F8Q 630, F8Q 632	1870		0-N881	TB [DG]	
1.9 D , 1.9 dTi	09/98-05/05	F8Q 630, F8Q 630, F8Q 632, F9Q 780	1870		0-N147	TB [DG]	
1.9 dTi	12/99-05/05	F9Q 780	1870		0-N1106	TB [DG]	
1.9 dTi	12/99-05/05	F9Q 780	1870		0-N199	TB [TE]	
2.0 16V Sport	02/00-	F4R 730, F4R 736, F4R 738	1998		0-N1259	TB [DG]	
2.0 16V Sport	02/00-	F4R 730, F4R 736	1998	04/2001 →	0-N1365	TB [DG]	
2.0 16V Sport	02/00-	F4R 730, F4R 736, F4R 738	1998		0-N200	TB [TE]	
2.0 16V Sport	02/00-	F4R 730, F4R 736	1998	→ 04/2001	0-N262	TB [DG]	
2.0 16V Sport	01/04-	F4R 738	1998		0-N1365	TB [DG]	
3.0 V6 Sport	11/00-12/02	L7X 760, L7X 762	2946		0-N1056	TB [TE]	
3.0 V6 Sport	11/00-12/02	L7X 760, L7X 762	2946		0-N170	TB [DG]	
3.0 V6 Sport	11/00-12/02	L7X 760, L7X 762	2946		0-N171	TB [DG]	
1.2	09/98-	D7F 720, D7F 726	1149	→ 04/2000	0-N1589	VB [TE]	
1.2	09/98-	D7F 720, D7F 726	1149	04/2000 →; ☼, für Fahrzeuge mit Servolenkung	0-N1592	VB [DG]	
1.2	09/98-	D7F 746	1149	☼, für Fahrzeuge mit Servolenkung	0-N1592	VB [DG]	
1.2	09/98-	D7F 720, D7F 726	1149	→ 04/2000; ☼	0-N1736	VB [DG]	
1.2	09/98-	D7F 746, D7F 764, D7F 766	1149		0-N2222	VB [TE]	
1.2	09/98-	D7F 720, D7F 726	1149	04/2000 →	0-N2222	VB [TE]	
1.2	03/99-05/01	D7F 722	1149	→ 04/2000	0-N1589	VB [TE]	
1.2	03/99-05/01	D7F 722	1149	04/2000 →; ☼, für Fahrzeuge mit Servolenkung	0-N1592	VB [DG]	
1.2	03/99-05/01	D7F 722	1149	→ 04/2000; ☼, für Fahrzeuge mit Servolenkung	0-N1736	VB [DG]	
1.2	03/99-05/01	D7F 722	1149	04/2000 →	0-N2222	VB [TE]	
1.2, 1.2 16V	06/01-	D4F 706, D4F 712, D4F 714, D4F 722, D4F 728	1149	☼, für Fahrzeuge mit Servolenkung	0-N1592	VB [DG]	
1.2, 1.2 16V	06/01-	D4F 706, D4F 712, D4F 714, D4F 722, D4F 728	1149	☼, für Fahrzeuge ohne Servolenkung	0-N2222	VB [TE]	
1.4	09/98-05/05	E7J 634, E7J 780, K7J 700	1390	☼	0-N1626	VB [BT]	S
1.4	09/98-05/05	E7J 634, E7J 780, K7J 700	1390		0-N1635	VB [DG]	
1.4	09/98-05/05	E7J 634, E7J 780, K7J 700	1390	☼	0-N1721	VB [BT]	
1.4 16V	10/99-09/04	K4J 712, K4J 713	1390		0-N1307	VB [DG]	
1.4 16V	10/99-09/04	K4J 710, K4J 711, K4J 712, K4J 713, K4J 712, K4J 713	1390	☼	0-N1314	VB [TE]	
1.4 16V	10/99-09/04	K4J 712, K4J 713	1390	☼	0-N1663	VB [BT]	S
1.4 16V	08/00-	K4J 710, K4J 711	1390	→ 06/2004	0-N1307	VB [DG]	
1.4 16V	08/00-	K4J 710, 711	1390	06/2004 →; ☼	0-N1476	VB [BT]	S
1.4 16V	08/00-	K4J 710, K4J 711	1390	→ 06/2004; ☼	0-N1663	VB [BT]	S
1.5 dCi	06/01-	K9K 700, K9K 704, K9K 700, K9K 714, K9K 702, K9K 712, K9K 740	1461	→ 09/2005; ☼	0-N1474	VB [BT]	
1.5 dCi	06/01-10/03	K9K 702	1461	☼	0-N1474	VB [BT]	
1.5 dCi	06/01-10/03	K9K 702	1461	☼	0-N1476	VB [BT]	S
1.5 dCi	06/01-12/06	K9K 700, K9K 704, K9K 700, K9K 714, K9K 702, K9K 704, K9K 712	1461	→ 09/2005; ☼	0-N1476	VB [BT]	S
1.5 dCi	06/01-	K9K 700, K9K 704, K9K 700, K9K 714, K9K 702, K9K 712	1461	01/2005 →; ☼	0-N1664	VB [BT]	S
1.5 dCi	06/01-	K9K 700, K9K 704, K9K 700, K9K 714, K9K 712, K9K 740	1461	09/2005 →; ☼	0-N1664	VB [BT]	S
1.5 dCi	06/01-	K9K 700, K9K 704, K9K 700, K9K 714, K9K 702, K9K 712, K9K 718, K9K 740	1461	→ 12/2007; Rippenanzahl: 6; ☼	0-N1898	VB [BT]	S
1.5 dCi	06/01-12/06	K9K 702, K9K 704	1461	Rippenanzahl: 6; ☼	0-N1898	VB [BT]	S



CM³



Art. Nr.



ohne Halter

CLIO II (BB0/1/2_, CB0/1/2_)							
1.5 dCi	06/01-	K9K 700, K9K 704, K9K 700, K9K 714, K9K 718, K9K 740	1461	12/2007 →; ☼		0-N2253	VB [DG]
1.5 dCi	06/05-	K9K 740	1461	☼		0-N1664	VB [BT] S
1.5 dCi	02/07-	K9K 718	1461			0-N1664	VB [BT] S
1.6	09/98-05/05	K7M 744, K7M 745	1598	☼		0-N1626	VB [BT] S
1.6	09/98-05/05	K7M 744, K7M 745	1598			0-N1635	VB [DG]
1.6	09/98-05/05	K7M 744, K7M 745	1598	☼		0-N1721	VB [BT]
1.6 16V	09/98-	K4M 708, K4M 740, K4M 742, K4M 743, K4M 744, K4M 745, K4M 748	1598			0-N1307	VB [DG]
1.6 16V , 1.6 Hi-Flex	09/98-02/10	K4M 708, K4M 740, K4M 742, K4M 743, K4M 744, K4M 745, K4M 748, K4M 748	1598	☼		0-N1314	VB [TE]
1.6 16V , 1.6 Hi-Flex	09/98-02/10	K4M 708, K4M 740, K4M 742, K4M 743, K4M 744, K4M 745, K4M 748, K4M 748	1598	☼		0-N1663	VB [BT] S
2.0 16V Sport	02/00-	F4R 730, F4R 736, F4R 738	1998	☼		0-N1475S	VB [TE]
2.0 16V Sport	02/00-	F4R 730, F4R 736, F4R 738	1998	☼		0-N1729	VB [DG]
3.0 V6 Sport	11/00-12/02	L7X 760, L7X 762	2946			0-N1449	VB [TE]
3.0 V6 Sport	11/00-12/02	L7X 760, L7X 762	2946			0-N1473	VB [BT] S
3.0 V6 Sport	11/00-12/02	L7X 760, L7X 762	2946			0-N1757	VB [VD]
3.0 V6 Sport	12/02-	L7X 762	2946	→ 05/2005		0-N1803	VB [DG]
CLIO II Kasten (SB0/1/2_)							
1.1	09/98-	D7F 720, D7F 726	1149	17x87		SK-1081	BTK
1.1 , 1.2	09/98-10/03	D7F 720, D7F 726, D7F 746, D7F 722, D7F 726, D7F 746	1149	17x87		SK-1081AQ2	BTKW
1.2	03/99-10/03	D7F 722, D7F 726, D7F 746	1149	17x87		SK-1081	BTK
1.5 dCi	06/01-10/04	K9K 700, K9K 704, K9K 702	1461	27x123; → 08/2003; mit Zubehör		SK-1487	BTK
1.5 dCi	06/01-	K9K 700, K9K 704	1461	27x123; mit Zubehör		SK-1487AQ1	BTKW
1.5 dCi	06/01-10/04	K9K 702	1461	27x123; → 08/2003; mit Zubehör		SK-1487AQ1	BTKW
1.5 dCi	06/01-10/04	K9K 700, K9K 704, K9K 702, K9K 702, K9K 710, K9K 716	1461	27x123; 04/2004 →; mit Zubehör		SK-1487AQ2	BTKW
1.5 dCi	11/03-	K9K 702, K9K 710, K9K 716, K9K 714	1461	27x123; mit Zubehör		SK-1487	BTK
1.5 dCi	11/03-	K9K 702, K9K 710, K9K 716	1461	27x123; → 03/2004; mit Zubehör		SK-1487AQ1	BTKW
1.5 dCi	04/04-	K9K 714	1461	27x123; mit Zubehör		SK-1487AQ2	BTKW
1.9 D	09/98-	F8Q 630	1870	25.4x151; beinhaltetete Rollen: 3; mit Zahnrad		SK-1108	BTK
1.9 D	09/98-	F8Q 630	1870	25.4x151; beinhaltetete Rollen: 2		SK-1108S	BTK
1.9 D	03/99-05/01	F8Q 632, F8Q 662	1870	25.4x151; beinhaltetete Rollen: 3; mit Zahnrad		SK-1108	BTK
1.9 D	03/99-05/01	F8Q 632, F8Q 662	1870	25.4x151; beinhaltetete Rollen: 2		SK-1108S	BTK
1.9 DTi	02/00-05/01	F9Q 780	1870	26x153; 04/2001 →; beinhaltetete Rollen: 4; mit Zahnrad; mit Zubehör		SK-1490	BTK
1.9 DTi	02/00-05/01	F9Q 780	1870	26x153; beinhaltetete Rollen: 2		SK-1620	BTK
1.9 DTi	02/00-05/01	F9Q 780	1870	26x153; 04/2001 →; beinhaltetete Rollen: 3; mit Zubehör		SK-1622	BTK
1.1 , 1.2	09/98-10/03	D7F 720, D7F 726, D7F 746, D7F 722, D7F 726, D7F 746	1149			0-N863	TB [TE]
1.5 dCi	06/01-10/04	K9K 700, K9K 704, K9K 702, K9K 702, K9K 710, K9K 716, K9K 714	1461			0-N1111	TB [TE]
1.9 D	09/98-05/01	F8Q 630, F8Q 632, F8Q 662	1870			0-N173	TB [TE]
1.9 D	09/98-05/01	F8Q 630, F8Q 632, F8Q 662	1870			0-N881	TB [DG]
1.9 D , 1.9 DTi	09/98-05/01	F8Q 630, F8Q 632, F8Q 662, F9Q 780	1870			0-N147	TB [DG]
1.1 , 1.2	09/98-10/03	D7F 720, D7F 726, D7F 746, D7F 722, D7F 726, D7F 746	1149	→ 04/2000		0-N1589	VB [TE]
1.1 , 1.2	09/98-10/03	D7F 720, D7F 726, D7F 746, D7F 722, D7F 726, D7F 746	1149	→ 04/2000; ☼, für Fahrzeuge mit Servolenkung		0-N1736	VB [DG]
1.1 , 1.2	09/98-10/03	D7F 720, D7F 726, D7F 746, D7F 722, D7F 726, D7F 746	1149	04/2000 →		0-N2222	VB [TE]
1.5 dCi	06/01-	K9K 700, K9K 704, K9K 702, K9K 710, K9K 716, K9K 714	1461	→ 09/2005; ☼		0-N1474	VB [BT]
1.5 dCi	06/01-10/04	K9K 702	1461	☼		0-N1474	VB [BT]
1.5 dCi	06/01-	K9K 700, K9K 704, K9K 702, K9K 710, K9K 716, K9K 714	1461	→ 09/2005; ☼		0-N1476	VB [BT] S
1.5 dCi	06/01-10/04	K9K 702	1461	☼		0-N1476	VB [BT] S
1.5 dCi	06/01-	K9K 700, K9K 704, K9K 702, K9K 710, K9K 716, K9K 714	1461	01/2005 →; ☼		0-N1664	VB [BT] S
1.5 dCi	06/01-	K9K 700, K9K 704, K9K 714	1461	09/2005 →; ☼		0-N1664	VB [BT] S
1.5 dCi	06/01-	K9K 700, K9K 704	1461	→ 12/2007; Rippenanzahl: 6; ☼		0-N1898	VB [BT] S
1.5 dCi	06/01-	K9K 700, K9K 704, K9K 714	1461	12/2007 →; ☼		0-N2253	VB [DG]
1.5 dCi	11/03-	K9K 716	1461	12/2007 →; ☼		0-N2253	VB [DG]
CLIO III (BR0/1, CR0/1)							
1.2	10/05-	D4F 764	1149	23.4x95; Baumuster: BR01, BR03, BR0E, CR0E		SK-1486	BTK



CM³



Art. Nr.



CLIO III (BR0/1, CR0/1)

1.2, 1.2 16V, 1.2 16V Hi-Flex	06/05-	D4F 706, D4F 740, D4F 740, D4F 740, D4F 742, D4F 764, D4F 784, D4F 786	1149	23.4x95	SK-1486AQ1	BTKW	
1.2 16V	06/05-	D4F 764	1149	23.4x95; 10/2005 →; Baumuster: BR01, BR03, BR0E, CR0E	SK-1486	BTK	
1.2 16V	06/05-	D4F 706, D4F 740	1149	23.4x95; Baumuster: BR02, BR0J, BR11, CR02, CR0J, CR11	SK-1486	BTK	
1.2 16V, 1.2 16V Hi-Flex	06/05-	D4F 740, D4F 740, D4F 742, D4F 784, D4F 786	1149	23.4x95	SK-1486	BTK	
1.4 16V	06/05-	K4J 780	1390	27x132; mit Zubehör	SK-1088	BTK	
1.4 16V	06/05-	K4J 780	1390	27x132; mit Zubehör	SK-1088AQ1	BTKW	
1.5 dCi	05/05-	K9K 750, K9K 752, K9K 764, K9K 774, K9K 770, K9K 772	1461	27x123; mit Zubehör	SK-1487	BTK	
1.5 dCi	05/05-	K9K 714, K9K 768, K9K 750, K9K 752, K9K 764, K9K 774, K9K 766, K9K 772	1461	27x123; mit Zubehör	SK-1487AQ2	BTKW	
1.5 dCi	06/05-	K9K 752	1461	27x123; 11/2006 →; mit Zubehör	SK-1487	BTK	
1.5 dCi	06/05-	K9K 768	1461	27x123; mit Zubehör	SK-1487	BTK	
1.5 dCi	06/05-	K9K 766	1461	27x123; mit Zubehör; Baumuster: BR17, CR17	SK-1487	BTK	
1.5 dCi	06/05-	K9K 772	1461	27x123; mit Zubehör	SK-1487AQ1	BTKW	
1.5 dCi	08/10-	K9K 770	1461	27x123; mit Zubehör	SK-1487AQ3	BTKW	
1.6 16V	06/05-	K4M 800, K4M 801, K4M 804	1598	27x132	SK-1630AQ1	BTKW	
1.6 16V, 1.6 16V GT	06/05-	K4M 800, K4M 801, K4M 804, K4M 862	1598	27x132	SK-1630	BTK	
1.6 Hi-Flex	05/05-02/10	K4M 748	1598	27x132; mit Zubehör	SK-1088	BTK	
1.6 Hi-Flex	05/05-02/10	K4M 748	1598	27x132; mit Zubehör	SK-1088AQ1	BTKW	
2.0 16V Sport	02/06-	F4R 830	1998	27x126; Baumuster: CR0N, CR1P	SK-1624	BTK	
2.0 16V Sport	02/06-	F4R 830	1998	27x126	SK-1624AQ1	BTKW	
1.2, 1.2 16V, 1.2 16V Hi-Flex	06/05-	D4F 706, D4F 740, D4F 740, D4F 740, D4F 742, D4F 764, D4F 784	1149		0-N1112	TB [TE]	
1.4 16V	06/05-	K4J 780	1390		0-N198	TB [TE]	
1.4 16V	06/05-	K4J 780	1390		0-N262	TB [DG]	
1.5 dCi	05/05-	K9K 714, K9K 768, K9K 750, K9K 752, K9K 764, K9K 774, K9K 766, K9K 770, K9K 772	1461		0-N1111	TB [TE]	
1.6 16V, 1.6 16V GT	06/05-	K4M 800, K4M 801, K4M 804, K4M 862	1598		0-N1368	TB [TE]	
1.6 16V, 1.6 16V GT, 1.6 Hi-Flex	05/05-02/10	K4M 748, K4M 800, K4M 801, K4M 804, K4M 862	1598		0-N262	TB [DG]	
2.0 16V Sport	02/06-	F4R 830	1998		0-N1365	TB [DG]	
2.0 16V Sport	02/06-	F4R 830	1998		0-N200	TB [TE]	
1.2, 1.2 16V, 1.2 16V Hi-Flex	06/05-	D4F 706, D4F 740, D4F 740, D4F 740, D4F 742, D4F 764, D4F 784	1149		0-N1743	VB [DG]	
1.2 16V	06/05-	D4F 764	1149		0-N1664	VB [BT]	S
1.4 16V	06/05-	K4J 780	1390	☼	0-N1474	VB [BT]	
1.4 16V	06/05-	K4J 780	1390	☼	0-N1664	VB [BT]	S
1.4 16V	06/05-	K4J 780	1390	Rippenanzahl: 6; ☼	0-N1898	VB [BT]	S
1.5 dCi	05/05-	K9K 714, K9K 768, K9K 752, K9K 764, K9K 774, K9K 766, K9K 772	1461	→ 09/2005; ☼	0-N1474	VB [BT]	
1.5 dCi	05/05-	K9K 714, K9K 768, K9K 752, K9K 764, K9K 774, K9K 766	1461	09/2005 →; ☼	0-N1664	VB [BT]	S
1.5 dCi	05/05-	K9K 714, K9K 768, K9K 752, K9K 764, K9K 774, K9K 766, K9K 772	1461	☼	0-N1664	VB [BT]	S
1.5 dCi	05/05-	K9K 714, K9K 768, K9K 752, K9K 764, K9K 774, K9K 766	1461	→ 12/2007; Rippenanzahl: 6; ☼	0-N1898	VB [BT]	S
1.5 dCi	05/05-	K9K 750, K9K 752, K9K 766	1461	12/2007 →; ☼	0-N2253	VB [DG]	
1.5 dCi	06/05-	K9K 750, K9K 752, K9K 770	1461		0-N1664	VB [BT]	S
1.5 dCi	06/05-	K9K 768	1461	12/2007 →; ☼	0-N2253	VB [DG]	
1.5 dCi	08/10-	K9K 770	1461	☼	0-N2253	VB [DG]	
1.6 16V	06/05-	K4M 800, K4M 801, K4M 804	1598	→ 05/2006; ☼	0-N1474	VB [BT]	
1.6 16V	06/05-	K4M 800, K4M 801, K4M 804	1598	09/2005 →; ☼	0-N1664	VB [BT]	S
1.6 16V	06/05-	K4M 800, K4M 801, K4M 804	1598	☼	0-N1664	VB [BT]	S
1.6 16V	06/05-	K4M 801	1598	→ 04/2009; Rippenanzahl: 6; ☼	0-N1898	VB [BT]	S
1.6 16V	06/05-	K4M 800	1598	→ 12/2007; Rippenanzahl: 6; ☼	0-N1898	VB [BT]	S
1.6 16V	06/05-	K4M 804	1598	→ 12/2007; Rippenanzahl: 6; ☼	0-N1898	VB [BT]	S
1.6 16V	06/05-	K4M 801	1598	04/2009 →; ☼	0-N2253	VB [DG]	
1.6 16V	06/05-	K4M 800	1598	12/2007 →; ☼	0-N2253	VB [DG]	
1.6 16V	06/05-	K4M 804	1598	12/2007 →; ☼	0-N2253	VB [DG]	
1.6 16V GT	06/09-	K4M 862	1598		0-N1664	VB [BT]	S
1.6 Hi-Flex	05/05-02/10	K4M 748	1598	☼	0-N1663	VB [BT]	S
2.0 16V	09/06-	M4R 700, M4R 701	1997		0-N1869	VB [BT]	S
2.0 16V Sport	02/06-	F4R 830	1998		0-N1427	VB [BT]	S



CM³



Art. Nr.



ohne Halter

CLIO Grandtour (KR0/1_)							
1.2 16V, 1.2 16V Hi-Flex	02/08-	D4F 740, D4F 764, D4F 784, D4F 786	1149	23.4x95	SK-1486	BTK	
1.2 16V, 1.2 16V Hi-Flex	02/08-	D4F 740, D4F 764, D4F 784, D4F 786	1149	23.4x95	SK-1486AQ1	BTKW	
1.4 16V	02/10-	K4J 780	1390	27x132; mit Zubehör	SK-1088	BTK	
1.4 16V	02/10-	K4J 780	1390	27x132; mit Zubehör	SK-1088AQ1	BTKW	
1.5 dCi	02/08-	K9K 752, K9K 764, K9K 774, K9K 766, K9K 770, K9K 770, K9K 772, K9K 772	1461	27x123; mit Zubehör	SK-1487	BTK	
1.5 dCi	02/08-	K9K 768	1461	27x123; mit Zubehör	SK-1487	BTK	
1.5 dCi	02/08-	K9K 714, K9K 768, K9K 752, K9K 764, K9K 774, K9K 766, K9K 770, K9K 772	1461	27x123; mit Zubehör	SK-1487AQ2	BTKW	
1.5 dCi	08/10-	K9K 772	1461	27x123; mit Zubehör	SK-1487AQ2	BTKW	
1.5 dCi	08/10-	K9K 770	1461	27x123; mit Zubehör	SK-1487AQ3	BTKW	
1.6 16V	02/08-	K4M 800, K4M 801, K4M 862	1598	27x132	SK-1630	BTK	
1.6 16V	02/08-	K4M 800, K4M 801	1598	27x132	SK-1630AQ1	BTKW	
1.2 16V, 1.2 16V Hi-Flex	02/08-	D4F 740, D4F 764, D4F 784	1149		0-N1112	TB [TE]	
1.4 16V	02/10-	K4J 780	1390		0-N198	TB [TE]	
1.4 16V	02/10-	K4J 780	1390	→ 12/2010	0-N262	TB [DG]	
1.5 dCi	02/08-	K9K 714, K9K 768, K9K 752, K9K 764, K9K 774, K9K 766, K9K 770, K9K 770, K9K 772, K9K 772	1461		0-N1111	TB [TE]	
1.6 16V	02/08-	K4M 800, K4M 801, K4M 862	1598		0-N1368	TB [TE]	
1.6 16V	02/08-	K4M 800, K4M 801, K4M 862	1598		0-N262	TB [DG]	
1.2 16V, 1.2 16V Hi-Flex	02/08-	D4F 740, D4F 764, D4F 784	1149		0-N1743	VB [DG]	
1.4 16V	02/10-	K4J 780	1390		0-N1664	VB [BT]	S
1.5 dCi	02/08-	K9K 714, K9K 768, K9K 764, K9K 774, K9K 766, K9K 770, K9K 772	1461		0-N1664	VB [BT]	S
1.5 dCi	02/08-	K9K 752, K9K 766, K9K 770	1461	✳	0-N2253	VB [DG]	
1.5 dCi	02/08-	K9K 768	1461	✳	0-N2253	VB [DG]	
1.5 dCi	08/10-	K9K 770	1461		0-N1664	VB [BT]	S
1.5 dCi	08/10-	K9K 770	1461	✳	0-N2253	VB [DG]	
1.6 16V	02/08-	K4M 800, K4M 801, K4M 862	1598		0-N1664	VB [BT]	S
1.6 16V	02/08-	K4M 801	1598	04/2009 →; ✳	0-N2253	VB [DG]	
1.6 16V	02/08-	K4M 800	1598	✳	0-N2253	VB [DG]	
CLIO IV							
1.5 dCi 75, 1.5 dCi 90	11/12-	K9K 608, K9K 612	1461	27x119	SK-1730	BTK	
1.5 dCi 75, 1.5 dCi 90	11/12-	K9K 608, K9K 612	1461	27x119	SK-1730AQ1	BTKW	
1.5 dCi 75, 1.5 dCi 90	11/12-	K9K 608, K9K 612	1461		0-N2423	TB [TE]	
0.9 TCe 90	11/12-	H4Bt400	898		0-N2308	VB [BT]	S
1.2 TCe 120	03/13-	H5F 403	1197		0-N2308	VB [BT]	S
1.5 dCi 75, 1.5 dCi 90	11/12-	K9K 608, K9K 612	1461	✳	0-N2253	VB [DG]	
1.5 dCi 90	11/12-	K9K 608	1461		0-N2290	VB [BT]	S
CLIO Grandtour IV							
1.5 dCi 75, 1.5 dCi 90	01/13-	K9K 608, K9K 612	1461	27x119	SK-1730	BTK	
1.5 dCi 75, 1.5 dCi 90	01/13-	K9K 608, K9K 612	1461	27x119	SK-1730AQ1	BTKW	
1.5 dCi 75, 1.5 dCi 90	01/13-	K9K 608, K9K 612	1461		0-N2423	TB [TE]	
0.9 TCe 90	01/13-	H4Bt400	898		0-N2308	VB [BT]	S
1.2 TCe 120	03/13-	H5F 403	1197		0-N2308	VB [BT]	S
1.5 dCi 75, 1.5 dCi 90	01/13-	K9K 608, K9K 612	1461	✳	0-N2253	VB [DG]	
1.5 dCi 90	01/13-	K9K 608	1461		0-N2290	VB [BT]	S
DUSTER							
1.6 16V	02/12-	K4M 616	1598	27x132; mit Zubehör	SK-1088	BTK	
1.6 16V	02/12-	K4M 616	1598		0-N262	TB [DG]	
1.6 16V	02/12-	K4M 616	1598	✳	0-N2265	VB [BT]	S
1.6 16V	02/12-	K4M 616	1598	✳	0-N2275	VB [DG]	
ESPACE I (J11_)							
2.0, 2.0 i, 2.0 i Quadra	07/84-12/92	J6R 234, J6R 236, J6R 734, J7R 760	1995	19x116	SK-1091	BTK	
2.1 TD	10/84-12/90	J8S 240, J8S 774, J8S 776	2068	25x148	SK-1014	BTK	
2.1 TD	10/84-12/90	J8S 240	2068	25x148	SK-1063	BTK	
2.2, 2.2 Quadra	07/86-12/90	J7T 770	2165	19x118	SK-1092	BTK	
2.0, 2.0 i, 2.0 i Quadra	07/84-12/92	J6R 234, J6R 236, J6R 734, J7R 760	1995		0-N882	TB [TE]	
2.1 TD	10/84-12/90	J8S 240, J8S 774, J8S 776	2068		0-N857	TB [DG]	
2.1 TD	10/84-12/90	J8S 240, J8S 774, J8S 776	2068	mit Anbaumaterial	0-N913	TB [TE]	
2.2, 2.2 Quadra	07/86-12/90	J7T 770	2165		0-N882	TB [TE]	
ESPACE II (J/S63_)							
2.0	01/91-10/96	J7R 768	1995	19x116	SK-1091	BTK	



CM³



Art. Nr.



ESPACE II (J/S63_)

2.1 RTDT Quadra, 2.1 TD	01/91-10/96	J8S 610, J8S 772, J8S 776, J8S 778, J8S 612, J8S 772	2068	25x148	SK-1014	BTK
2.1 RTDT Quadra, 2.1 TD	01/91-10/96	J8S 612, J8S 772	2068	25x148	SK-1063	BTK
2.1 TD	01/91-10/96	J8S 610	2068	25x148	SK-1063	BTK
2.2, 2.2 4x4	01/91-12/96	J7T 772, J7T 773, J7T 772, J7T 773, J7T 776	2165	19x118	SK-1092	BTK
2.0	01/91-10/96	J7R 768	1995		0-N882	TB [TE]
2.1 TD	01/91-10/96	J8S 610, J8S 772, J8S 776, J8S 778, J8S 612	2068		0-N857	TB [DG]
2.1 TD	01/91-10/96	J8S 610, J8S 772, J8S 776, J8S 778, J8S 612	2068	mit Anbaumaterial	0-N913	TB [TE]
2.2, 2.2 4x4	01/91-12/96	J7T 772, J7T 773, J7T 772, J7T 773, J7T 776	2165		0-N882	TB [TE]

ESPACE III (JE0_)

1.9 dTi	02/99-10/02	F9Q 722	1870	26x153; → 10/2000; beinhaltetete Rollen: 3; mit Zahnrad	SK-1084	BTK
1.9 dTi	02/99-10/02	F9Q 722	1870	26x153; → 10/2000; beinhaltetete Rollen: 2	SK-1114	BTK
1.9 dTi	02/99-10/02	F9Q 722	1870	26x153; 10/2000 → 06/2001; beinhaltetete Rollen: 4; mit Zahnrad; mit Zubehör	SK-1490	BTK
1.9 dTi	02/99-10/02	F9Q 722	1870	26x153; 10/2000 →; beinhaltetete Rollen: 2	SK-1620	BTK
1.9 dTi	02/99-10/02	F9Q 722	1870	26x153; 06/2001 →; beinhaltetete Rollen: 3; mit Zubehör	SK-1622	BTK
2.0	11/96-10/00	F3R 728, F3R 729, F3R 742, F3R 768, F3R 769	1998	19x127	SK-1036	BTK
2.0	11/96-10/00	F3R 742, F3R 768, F3R 769	1998	19x127; mit Zahnrad	SK-1099	BTK
2.0	09/01-10/02	F4R 700, F4R 701	1998	27x128	SK-1631	BTK
2.0 16V	10/98-10/02	F4R 700, F4R 701	1998	27x128; 06/1999 → 04/2001	SK-1494	BTK
2.0 16V	10/98-10/02	F4R 700, F4R 701	1998	27x128; → 05/1999	SK-1625	BTK
2.0 16V	10/98-10/02	F4R 700, F4R 701	1998	27x128; 04/2001 →	SK-1631	BTK
2.2 12V TD	11/96-10/00	G8T 716	2188	25.4x163; Baumuster: JE0P	SK-1096	BTK
2.2 12V TD	11/96-10/00	G8T 714, G8T 716, G8T 760	2188	25.4x163	SK-1096AQ1	BTKW
2.2 D, 2.2 dCi	11/97-10/02	G8T 716, G9T 710	2188	25.4x163	SK-1096	BTK
2.2 dCi	07/00-10/02	G9T 642, G9T 710, G9T 710	2188	25x89; mit Zubehör	SK-1489	BTK
3.0 V6 24V	10/98-10/02	L7X 727	2946	32x259; 12/1999 →	SK-1483	BTK
1.9 dTi	02/99-10/02	F9Q 722	1870	10/2000 →	0-N1106	TB [DG]
1.9 dTi	02/99-10/02	F9Q 722	1870		0-N147	TB [DG]
1.9 dTi	02/99-10/02	F9Q 722	1870	→ 10/2000	0-N148	TB [DG]
1.9 dTi	02/99-10/02	F9Q 722	1870	→ 10/2000	0-N173	TB [TE]
1.9 dTi	02/99-10/02	F9Q 722	1870	10/2000 →	0-N199	TB [TE]
2.0	11/96-10/00	F3R 742, F3R 768, F3R 769	1998		0-N146	TB [DG]
2.0	11/96-10/00	F3R 728, F3R 729, F3R 742, F3R 768, F3R 769	1998		0-N173	TB [TE]
2.0	11/96-10/00	F3R 728, F3R 729, F3R 742, F3R 768, F3R 769	1998		0-N854	TB [DG]
2.0	09/01-10/02	F4R 700, F4R 701	1998		0-N1259	TB [DG]
2.0	09/01-10/02	F4R 700, F4R 701	1998		0-N1365	TB [DG]
2.0 16V	10/98-10/02	F4R 700, F4R 701	1998	→ 05/1999	0-N1259	TB [DG]
2.0 16V	10/98-10/02	F4R 700, F4R 701	1998	05/1999 →	0-N1259	TB [DG]
2.0 16V	10/98-10/02	F4R 700, F4R 701	1998	04/2001 →	0-N1365	TB [DG]
2.0 16V	10/98-10/02	F4R 700, F4R 701	1998	05/1999 → 04/2001	0-N262	TB [DG]
2.0, 2.0 16V	10/98-10/02	F4R 700, F4R 701	1998		0-N200	TB [TE]
2.2 12V TD, 2.2 D	11/96-10/00	G8T 714, G8T 716, G8T 760, G8T 716	2188		0-N112	TB [TE]
2.2 12V TD, 2.2 D	11/96-10/00	G8T 714, G8T 716, G8T 760, G8T 716	2188		0-N965	TB [DG]
2.2 dCi	07/00-10/02	G9T 642, G9T 710, G9T 710	2188		0-N1269	TB [TE]
2.2 dCi	07/00-10/02	G9T 642, G9T 710, G9T 710	2188		0-N1270	TB [DG]
3.0 V6 24V	10/98-10/02	L7X 727	2946		0-N1056	TB [TE]
3.0 V6 24V	10/98-10/02	L7X 727	2946		0-N170	TB [DG]
3.0 V6 24V	10/98-10/02	L7X 727	2946		0-N171	TB [DG]
1.9 dTi	02/99-10/02	F9Q 722	1870	06/2001 →	0-N1469	VB [BT]
1.9 dTi	02/99-10/02	F9Q 722	1870	→ 06/2001	0-N1470	VB [BT]
1.9 dTi	02/99-10/02	F9Q 722	1870		0-N1729	VB [DG]
2.0	11/96-10/00	F3R 728, F3R 729, F3R 742, F3R 768, F3R 769	1998	mit Anbaumaterial	0-N139	VB [TE]
2.0, 2.0 16V	10/98-10/02	F4R 700, F4R 701	1998		0-N1307	VB [DG]
2.0, 2.0 16V	10/98-10/02	F4R 700, F4R 701	1998	☼	0-N1663	VB [BT]
2.2 12V TD, 2.2 D	11/96-10/00	G8T 714, G8T 716, G8T 760, G8T 716	2188	☼	0-N1488	VB [BT]
2.2 12V TD, 2.2 D	11/96-10/00	G8T 714, G8T 716, G8T 760, G8T 716	2188		0-N1590	VB [DG]
2.2 12V TD, 2.2 D	11/96-10/00	G8T 714, G8T 716, G8T 760, G8T 716	2188	☼	0-N1752	VB [BT]



CM³



Art. Nr.



ESPACE III (JE0_)

2.2 12V TD , 2.2 D	11/96-10/00	G8T 714, G8T 716, G8T 760, G8T 716	2188	☼		0-N1916	VB [BT]	
2.2 12V TD , 2.2 D	11/96-10/00	G8T 714, G8T 716, G8T 760, G8T 716	2188	☼		0-N2179	VB [TE]	
2.2 dCi	07/00-10/02	G9T 642, G9T 710, G9T 710	2188			0-N1409	VB [DG]	
2.2 dCi	07/00-10/02	G9T 642, G9T 710, G9T 710	2188			0-N1731	VB [BT]	S
3.0	11/96-10/98	Z7X 775	2963		mit Grundträger; ☼	0-N2333	VB [TE]	
3.0	11/96-10/98	Z7X 775	2963		mit Grundträger	0-N2334	VB [TE]	
3.0	11/96-10/98	Z7X 775	2963		Rippenanzahl: 5; mit Grundträger; für Fahrzeuge mit Servolenkung	0-N2335	VB [TE]	
3.0	11/96-10/98	Z7X 775	2963		mit Grundträger	0-N2336	VB [TE]	
3.0	11/96-10/98	Z7X 775	2963		mit Grundträger; ☼	0-N2342	VB [DG]	
3.0 V6 24V	10/98-10/02	L7X 727	2946			0-N1449	VB [TE]	
3.0 V6 24V	10/98-10/02	L7X 727	2946			0-N1757	VB [VD]	
3.0 V6 24V	10/98-10/02	L7X 727	2946			0-N2175	VB [BT]	

ESPACE IV (JK0/1_)

1.9 dCi	11/02-	F9Q 820	1870		26x132; 04/2003 →; Baumuster: JK0U	SK-1493	BTK	
1.9 dCi	11/02-	F9Q 680, F9Q 820, F9Q 826	1870		26x132; 04/2003 →	SK-1493AQ1	BTKW	
1.9 dCi	04/03-02/05	F9Q 820	1870		26x132	SK-1493	BTK	
1.9 dCi	04/03-02/05	F9Q 820	1870		26x132	SK-1493AQ1	BTKW	
1.9 dCi	04/03-02/05	F9Q 820	1870		26x132	SK-1493AQ2	BTKW	
2.0	11/02-	F4R 792	1998		27x126; 05/2004 →	SK-1624	BTK	
2.0 , 2.0 Turbo	11/02-02/05	F4R 790, F4R 794, F4R 795, F4R 796, F4R 797, F4R 796, F4R 797, F4R 896, F4R 897	1998		27x126	SK-1624	BTK	
2.0 , 2.0 Turbo	11/02-02/05	F4R 790, F4R 792, F4R 794, F4R 795, F4R 796, F4R 797, F4R 796, F4R 797, F4R 896, F4R 897	1998		27x126	SK-1624AQ1	BTKW	
2.2 dCi	11/02-	G9T 645, G9T 742, G9T 743	2188		25x89; mit Zubehör	SK-1489	BTK	
3.0 dCi	11/02-	P9X 701, P9X 715	2958		25x116	SK-1611	BTK	
1.9 dCi	11/02-02/05	F9Q 680, F9Q 820, F9Q 826, F9Q 820	1870		mit Grundträger	0-N1173	TB [BT]	
2.0 , 2.0 Turbo	11/02-02/05	F4R 790, F4R 792, F4R 794, F4R 795, F4R 796, F4R 797, F4R 796, F4R 797, F4R 896, F4R 897	1998			0-N1365	TB [DG]	
2.0 , 2.0 Turbo	11/02-02/05	F4R 790, F4R 792, F4R 794, F4R 795, F4R 796, F4R 797, F4R 796, F4R 797, F4R 896, F4R 897	1998			0-N200	TB [TE]	
2.2 dCi	11/02-	G9T 645, G9T 742, G9T 743	2188			0-N1269	TB [TE]	
2.2 dCi	11/02-	G9T 645, G9T 742, G9T 743	2188			0-N1270	TB [DG]	
3.0 dCi	11/02-	P9X 701, P9X 715	2958			0-N1353	TB [TE]	
3.0 dCi	11/02-	P9X 701, P9X 715	2958			0-N1354	TB [DG]	
3.0 dCi	11/02-	P9X 701, P9X 715	2958			0-N1355	TB [DG]	
1.9 dCi	11/02-02/05	F9Q 680, F9Q 820, F9Q 826, F9Q 820	1870			0-N1409	VB [DG]	
1.9 dCi	11/02-02/05	F9Q 680, F9Q 820, F9Q 826, F9Q 820	1870			0-N1611	VB [BT]	S
2.0 , 2.0 Turbo	11/02-02/05	F4R 790, F4R 792, F4R 794, F4R 795, F4R 796, F4R 797, F4R 796, F4R 797, F4R 896, F4R 897	1998			0-N1409	VB [DG]	
2.0 , 2.0 Turbo	11/02-02/05	F4R 790, F4R 792, F4R 794, F4R 795, F4R 796, F4R 797, F4R 796, F4R 797, F4R 896, F4R 897	1998	☼		0-N1611	VB [BT]	S
2.0 dCi	01/06-	M9R 740, M9R 750, M9R 760, M9R 761, M9R 762, M9R 763, M9R 763, M9R 740, M9R 750, M9R 815, M9R 760, M9R 761, M9R 762, M9R 763, M9R 815	1995			0-N1739	VB [DG]	
2.0 dCi	01/06-	M9R 740, M9R 750, M9R 760, M9R 761, M9R 762, M9R 763, M9R 763, M9R 740, M9R 750, M9R 815, M9R 760, M9R 761, M9R 762, M9R 763, M9R 815	1995			0-N2039	VB [BT]	S
2.2 dCi	11/02-	G9T 645, G9T 742, G9T 743	2188			0-N1409	VB [DG]	
2.2 dCi	11/02-	G9T 645, G9T 742, G9T 743	2188			0-N1731	VB [BT]	S
3.0 dCi	11/02-	P9X 701	2958		Rippenanzahl: 6	0-N1461	VB [DG]	
3.0 dCi	11/02-	P9X 701	2958			0-N1633	VB [DG]	
3.0 dCi	11/02-	P9X 701	2958			0-N1717	VB [BT]	S
3.0 dCi	01/06-	P9X 715	2958			0-N2045	VB [BT]	S
3.0 dCi	01/06-	P9X 715	2958			0-N2177	VB [DG]	
3.0 dCi	01/06-	P9X 715	2958		Rippenanzahl: 7	0-N2178	VB [DG]	

EXPRESS Pick-up

1.9 D	07/95-10/97	F8Q 640	1870		25.4x151; → 08/1996	SK-1013	BTK	
1.9 D	07/95-10/99	F8Q 724, F8Q 776	1870		25.4x151; → 09/1996	SK-1013	BTK	
1.9 D	07/95-10/97	F8Q 640	1870		25.4x151; 09/1996 →; beinhaltete Rollen: 3; mit Zahnrad	SK-1108	BTK	
1.9 D	07/95-10/99	F8Q 640, F8Q 724, F8Q 776	1870		25.4x151; 09/1996 →; beinhaltete Rollen: 2	SK-1108S	BTK	

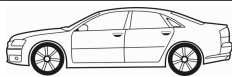
CM³

Art. Nr.



ohne Halter

FLUENCE (L30_)

1.5 dCi	02/10-	K9K 832	1461	27x123; 02/2010 →; mit Zubehör	SK-1487	BTK	
1.5 dCi	02/10-	K9K 830, K9K 834, K9K 836, K9K 837	1461	27x123; mit Zubehör	SK-1487	BTK	
1.5 dCi	02/10-	K9K 832	1461	27x123; 02/2010 →; mit Zubehör	SK-1487AQ2	BTKW	
1.5 dCi	02/10-	K9K 830	1461	27x123; mit Zubehör	SK-1487AQ2	BTKW	
1.5 dCi	02/10-	K9K 834, K9K 836, K9K 837	1461	27x123; mit Zubehör	SK-1487AQ3	BTKW	
1.6 16V	02/10-	K4M 838, K4M 838, K4M 839	1598	27x132	SK-1630	BTK	
1.6 16V	02/10-	K4M 838, K4M 838, K4M 839	1598	27x132	SK-1630AQ1	BTKW	
1.5 dCi	02/10-	K9K 830, K9K 832, K9K 834, K9K 836, K9K 837	1461		0-N1111	TB [TE]	
1.6 16V	02/10-	K4M 838, K4M 839	1598		0-N1368	TB [TE]	
1.6 16V	02/10-	K4M 838, K4M 838, K4M 839	1598		0-N262	TB [DG]	
1.5 dCi	02/10-	K9K 830, K9K 832, K9K 834, K9K 836, K9K 837	1461		0-N1664	VB [BT]	S
1.6 16V	02/10-	K4M 838, K4M 839	1598		0-N1664	VB [BT]	S
1.6 16V	02/10-	K4M 838, K4M 839	1598		0-N2240	VB [DG]	

FUEGO (136_)

2.1 TD	08/82-10/85	J8S 712	2068	25x148; 10/1982 →	SK-1014	BTK	
2.1 TD	08/82-10/85	J8S 712	2068	25x148	SK-1063	BTK	
2.0 TX/GTX	10/80-10/85	829 710, J6R 710, J6R 712, J6R 713, J6R 715, J6R 726	1995		0-N882	TB [TE]	
2.1 TD	08/82-10/85	J8S 712	2068		0-N857	TB [DG]	
2.1 TD	08/82-10/85	J8S 712	2068	mit Anbaumaterial	0-N913	TB [TE]	

GRAND SCÉNIC II (JM0/1_)

1.5 dCi	04/04-	K9K 728	1461	27x123; mit Zubehör; Baumuster: JM02	SK-1487	BTK	
1.5 dCi	04/04-	K9K 728	1461	27x123; mit Zubehör	SK-1487AQ1	BTKW	
1.5 dCi	04/04-	K9K 728, K9K P 732	1461	27x123; mit Zubehör	SK-1487AQ2	BTKW	
1.5 dCi	05/05-	K9K 728	1461	27x123; mit Zubehör	SK-1487	BTK	
1.6	04/04-11/08	K4M 761, K4M 782, K4M 812	1598	27x132	SK-1630	BTK	
1.6	04/04-11/08	K4M 761, K4M 782, K4M 812	1598	27x132	SK-1630AQ1	BTKW	
1.6	06/06-	K4M 788	1598	27x132; mit Zubehör	SK-1088	BTK	
1.6	06/06-	K4M 788	1598	27x132; mit Zubehör	SK-1088AQ1	BTKW	
1.9 dCi	04/04-	F9Q 812	1870	26x133; Baumuster: JM0G, JM12, JM15	SK-1580	BTK	
1.9 dCi	04/04-	F9Q 812, F9Q 816, F9Q 818, F9Q EE 804, F9Q J 803	1870	26x133	SK-1580AQ1	BTKW	
1.9 dCi	05/05-	F9Q 816, F9Q 818, F9Q EE 804, F9Q J 803	1870	26x133	SK-1580	BTK	
1.9 dCi	05/05-	F9Q E 804	1870	26x133; 06/2006 →	SK-1580	BTK	
1.9 dCi	05/05-	F9Q 803	1870	26x133	SK-1580AQ1	BTKW	
2.0	04/04-	F4R 770, F4R 771, F4R 776	1998	27x126	SK-1624	BTK	
2.0	04/04-	F4R 770, F4R 771	1998	27x126	SK-1624AQ1	BTKW	
2.0	04/04-	F4R 776	1998	27x126	SK-1624AQ1	BTKW	
1.5 dCi	04/04-	K9K 728, K9K P 732	1461		0-N1111	TB [TE]	
1.6	04/04-	K4M 761, K4M 782	1598		0-N1368	TB [TE]	
1.6	06/06-	K4M 788	1598		0-N198	TB [TE]	
1.6, 1.6 Flex	04/04-11/08	K4M 761, K4M 782, K4M 766, K4M 788, K4M 812	1598		0-N262	TB [DG]	
1.9 dCi	04/04-	F9Q 812, F9Q 816, F9Q 818, F9Q EE 804, F9Q J 803, F9Q E 804	1870	mit Anbaumaterial	0-N1323	TB [TE]	
2.0	04/04-	F4R 770, F4R 771, F4R 776	1998		0-N1365	TB [DG]	
2.0	04/04-	F4R 770, F4R 771, F4R 776	1998		0-N200	TB [TE]	
1.5 dCi	04/04-	K9K 728, K9K P 732	1461	→ 09/2005; ☼	0-N1474	VB [BT]	
1.5 dCi	04/04-	K9K 728	1461	→ 01/2005; ☼	0-N1476	VB [BT]	S
1.5 dCi	04/04-	K9K 728	1461	01/2005 →; ☼	0-N1664	VB [BT]	S
1.5 dCi	04/04-	K9K 728, K9K P 732	1461	09/2005 →; ☼	0-N1664	VB [BT]	S
1.5 dCi	04/04-	K9K 728	1461	→ 12/2007; Rippenanzahl: 6; ☼	0-N1898	VB [BT]	S
1.5 dCi	04/04-	K9K 728	1461	12/2007 →; ☼	0-N2253	VB [DG]	
1.5 dCi	05/05-	K9K P 732	1461	☼	0-N1664	VB [BT]	S
1.6	04/04-	K4M 761, K4M 782	1598	→ 05/2006; ☼	0-N1474	VB [BT]	
1.6	04/04-	K4M 761, K4M 782	1598	04/2005 →; ☼	0-N1664	VB [BT]	S
1.6	04/04-	K4M 761, K4M 782	1598	09/2005 →; ☼	0-N1664	VB [BT]	S
1.6	06/06-	K4M 788	1598		0-N1664	VB [BT]	S
1.6	06/06-11/08	K4M 812	1598	12/2007 →; ☼	0-N2253	VB [DG]	
1.9 dCi	04/04-	F9Q 812, F9Q 816, F9Q 818, F9Q EE 804, F9Q J 803, F9Q E 804	1870		0-N1427	VB [BT]	S
2.0	04/04-	F4R 770, F4R 771, F4R 776	1998		0-N1427	VB [BT]	S
2.0 dCi	09/05-	M9R 700, M9R 721, M9R 722	1995		0-N1739	VB [DG]	
2.0 dCi	09/05-	M9R 700, M9R 721, M9R 722	1995		0-N2039	VB [BT]	S

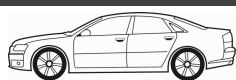

CM³



Art. Nr.



ohne Halter

GRAND SCÉNIC III (JZ0/1_)								
1.5 dCi	02/09-	K9K 636, K9K 836, K9K 837, K9K 830, K9K 832, K9K 846	1461	27x123; mit Zubehör	SK-1487	BTK		
1.5 dCi	02/09-	K9K 830, K9K 832	1461	27x123; mit Zubehör	SK-1487AQ2	BTKW		
1.5 dCi	04/09-	K9K 836, K9K 837	1461	27x123; mit Zubehör	SK-1487AQ3	BTKW		
1.5 dCi	04/09-	K9K636	1461	27x119	SK-1730	BTK		
1.5 dCi	04/09-	K9K636	1461	27x119	SK-1730AQ1	BTKW		
1.5 dCi	11/10-	K9K 846	1461	27x123; mit Zubehör	SK-1487AQ3	BTKW		
1.6 16V , 1.6 16V Bifuel	02/09-	K4M 858, K4M 866	1598	27x132	SK-1630	BTK		
1.6 16V , 1.6 16V Bifuel	02/09-	K4M 858, K4M 866	1598	27x132	SK-1630AQ1	BTKW		
1.9 dCi	02/09-	F9Q 870, F9Q 872	1870	26x133	SK-1698	BTK		
1.9 dCi	02/09-	F9Q 870, F9Q 872	1870	26x133	SK-1698AQ1	BTKW		
1.5 dCi	02/09-	K9K 636, K9K 836, K9K 837, K9K 830, K9K 832, K9K 846	1461		0-N1111	TB [TE]		
1.5 dCi	04/09-	K9K 636	1461		0-N2423	TB [TE]		
1.6 16V , 1.6 16V Bifuel	02/09-	K4M 858, K4M 866	1598		0-N1368	TB [TE]		
1.6 16V , 1.6 16V Bifuel	02/09-	K4M 858, K4M 866	1598		0-N262	TB [DG]		
1.9 dCi	02/09-	F9Q 870, F9Q 872	1870		0-N2060	TB [TE]		
1.2 Tce	04/12-	H5F 400, H5F 404	1197		0-N2308	VB [BT]	S	
1.2 Tce	04/12-	H5F 400, H5F 404	1197		0-N2344	VB [DG]		
1.4 16V	02/09-	H4J 700	1397		0-N2279	VB [BT]	S	
1.4 16V	02/09-	H4J 700	1397		0-N2344	VB [DG]		
1.5 dCi	02/09-	K9K 830, K9K 832	1461	→ 01/2011	0-N1664	VB [BT]	S	
1.5 dCi	04/09-	K9K 836	1461	→ 01/2011	0-N1664	VB [BT]	S	
1.5 dCi	04/09-	K9K 837	1461	→ 01/2011	0-N1664	VB [BT]	S	
1.6 16V	02/09-	K4M 858	1598		0-N1664	VB [BT]	S	
1.6 dCi	04/11-	R9M 402, R9M 404	1598		0-N1739	VB [DG]		
1.6 dCi	04/11-	R9M 402, R9M 404	1598		0-N2280	VB [BT]	S	
1.9 dCi	02/09-	F9Q 870, F9Q 872	1870		0-N1427	VB [BT]	S	
2.0 16V	02/09-	M4R 711	1997		0-N1869	VB [BT]	S	
2.0 dCi	02/09-	M9R 610, M9R 615	1995		0-N1739	VB [DG]		
2.0 dCi	02/09-	M9R 610, M9R 615	1995		0-N2039	VB [BT]	S	
KADJAR								
1.5 dCi 110	06/15-	K9K 646, K9K 647	1461	27x119	SK-1730	BTK		
1.5 dCi 110	06/15-	K9K 646, K9K 647	1461	27x119	SK-1730AQ1	BTKW		
1.5 dCi 110	06/15-	K9K 646, K9K 647	1461		0-N2423	TB [TE]		
KANGOO (KC0/1_)								
1.2	08/97-	D7F 710, D7F 720, D7F 722, D7F 726, D7F 744, D7F 746	1149	17x87	SK-1081	BTK		
1.2	08/97-	D7F 710, D7F 720, D7F 722, D7F 726, D7F 744, D7F 746	1149	17x87	SK-1081AQ2	BTKW		
1.2	08/97-	D7F 710, D7F 720, D7F 722, D7F 726, D7F 744, D7F 746	1149	23.4x95; 07/2001 →; Baumuster: KC05	SK-1486	BTK		
1.2	08/97-	D7F 710, D7F 720, D7F 722, D7F 726, D7F 744, D7F 746	1149	23.4x95; 07/2001 →	SK-1486AQ1	BTKW		
1.2 16V	06/01-	D4F712, D4F714	1149	23.4x95; Baumuster: KC03, KC05, KC0T, KC0W	SK-1486	BTK		
1.2 16V	06/01-	D4F 712	1149	23.4x95	SK-1486AQ1	BTKW		
1.4	08/97-	E7J 634, E7J 635, E7J 780, K7J 700, K7J 701	1390	17x96; 06/2005 →	SK-1338	BTK		
1.4	08/97-	E7J 634, E7J 635, E7J 780	1390	17x96	SK-1338AQ1	BTKW		
1.4	08/97-	K7J 700, K7J 701	1390	17x96	SK-1338AQ2	BTKW		
1.5 dCi	12/01-	K9K 700, K9K 704, K9K 704	1461	27x123; → 08/2003; mit Zubehör	SK-1487	BTK		
1.5 dCi	12/01-	K9K 700, K9K 704, K9K 702, K9K 710, K9K 714	1461	27x123; mit Zubehör	SK-1487AQ1	BTKW		
1.5 dCi	12/01-	K9K 700, K9K 704, K9K 702, K9K 710, K9K 704	1461	27x123; 04/2004 →; mit Zubehör	SK-1487AQ2	BTKW		
1.5 dCi	07/02-	K9K 702, K9K 710	1461	27x123; 07/2003 → 08/2003; mit Zubehör	SK-1487	BTK		
1.5 dCi	07/03-	K9K 704	1461	27x123; → 03/2004; mit Zubehör	SK-1487AQ1	BTKW		
1.5 dCi	06/05-	K9K 714	1461	27x123; 06/2008 →; mit Zubehör	SK-1487	BTK		
1.5 dCi	06/05-	K9K 718	1461	27x123; mit Zubehör	SK-1487	BTK		
1.5 dCi	06/05-	K9K 714, K9K 718	1461	27x123; mit Zubehör	SK-1487AQ2	BTKW		
1.6 16V, 1.6 16V 4x4	06/01-	K4M 706, K4M 750, K4M 752, K4M 753, K4M 750, K4M 752, K4M 753	1598	27x132; mit Zubehör	SK-1088	BTK		
1.6 16V, 1.6 16V 4x4	06/01-	K4M 706, K4M 750, K4M 752, K4M 753, K4M 750, K4M 752, K4M 753	1598	27x132; mit Zubehör	SK-1088AQ1	BTKW		
1.9 dCi 4x4	10/01-	F9Q 790	1870	26x153; mit Zubehör	SK-1663	BTK		
1.9 dTi	02/00-	F9Q 780	1870	26x153; → 12/2003; beinhaltet Rollen: 4; mit Zahnrad; mit Zubehör	SK-1490	BTK		



OPTIMAL®

RENAULT



CM³



Art. Nr.



ohne Halter

KANGOO (KC0/1_)

1.9 dTi	02/00-	F9Q 780	1870	26x153; beinhalten Rollen: 2	SK-1620	BTK	
1.9 dTi	02/00-	F9Q 780	1870	26x153; → 12/2003; beinhalten Rollen: 3; mit Zubehör	SK-1622	BTK	
1.9 RXED, D 55 1.9	08/97-06/01	F8Q 630, F8Q 632, F8Q 662	1870	25.4x151; beinhalten Rollen: 3; mit Zahnrad	SK-1108	BTK	
1.9 RXED, D 55 1.9	08/97-06/01	F8Q 630, F8Q 632, F8Q 662	1870	25.4x151; beinhalten Rollen: 2	SK-1108S	BTK	
D 65 1.9	08/97-	F8Q 630	1870	25.4x151; beinhalten Rollen: 3; mit Zahnrad; Baumuster: KC02, KC0E	SK-1108	BTK	
D 65 1.9	08/97-	F8Q 630	1870	25.4x151; beinhalten Rollen: 2; Baumuster: KC02, KC0E	SK-1108S	BTK	
1.2	08/97-	D7F 710, D7F 720, D7F 722, D7F 726, D7F 744, D7F 746	1149		0-N863	TB [TE]	
1.2 16V	06/01-	D4F 712, D4F 714, D4F 716, D4F 730	1149		0-N1112	TB [TE]	
1.4	08/97-	E7J 634	1390		0-N145	TB [TE]	
1.4	08/97-	E7J 635	1390		0-N145	TB [TE]	
1.4	08/97-	E7J 780	1390		0-N145	TB [TE]	
1.4	08/97-	K7J 701	1390		0-N145	TB [TE]	
1.5 dCi	12/01-	K9K 700, K9K 704, K9K 702, K9K 710, K9K 704, K9K 714, K9K 718	1461		0-N1111	TB [TE]	
1.6	09/99-06/01	K7M 746	1598		0-N145	TB [TE]	
1.6 16V, 1.6 16V 4x4, 1.6 16V bivalent	06/01-	K4M 706, K4M 750, K4M 752, K4M 753, K4M 750, K4M 752, K4M 753, K4M 850	1598		0-N198	TB [TE]	
1.6 16V, 1.6 16V 4x4, 1.6 16V bivalent	06/01-	K4M 706, K4M 750, K4M 752, K4M 753, K4M 750, K4M 752, K4M 753, K4M 850	1598		0-N262	TB [DG]	
1.9 dCi 4x4	10/01-	F9Q 782	1870		0-N1106	TB [DG]	
1.9 dCi 4x4	10/01-	F9Q 782, F9Q 790	1870		0-N147	TB [DG]	
1.9 dCi 4x4	10/01-	F9Q 790	1870		0-N148	TB [DG]	
1.9 dCi 4x4	10/01-	F9Q 790	1870		0-N1571	TB [TE]	
1.9 dCi 4x4	10/01-	F9Q 790	1870	→ 10/2009	0-N173	TB [TE]	
1.9 dCi 4x4	10/01-	F9Q 782	1870		0-N199	TB [TE]	
1.9 dCi 4x4, 1.9 dTi, 1.9 RXED, D 55 1.9, D 65 1.9	08/97-06/01	F8Q 630, F8Q 632, F8Q 662, F9Q 780, F9Q 790	1870		0-N147	TB [DG]	
1.9 dTi	02/00-	F9Q 780	1870		0-N1106	TB [DG]	
1.9 dTi	02/00-	F9Q 780	1870		0-N199	TB [TE]	
1.9 RXED, D 55 1.9, D 65 1.9	08/97-06/01	F8Q 630, F8Q 632, F8Q 662	1870		0-N173	TB [TE]	
1.9 RXED, D 55 1.9, D 65 1.9	08/97-06/01	F8Q 630, F8Q 632, F8Q 662	1870		0-N881	TB [DG]	
1.2	08/97-	D7F 710, D7F 720, D7F 722, D7F 726, D7F 744, D7F 746	1149	→ 04/2000	0-N1589	VB [TE]	
1.2	08/97-	D7F 710, D7F 720, D7F 722, D7F 726, D7F 744, D7F 746	1149	04/2000 →; ⚠, für Fahrzeuge mit Servolenkung	0-N1592	VB [DG]	
1.2	08/97-	D7F 710, D7F 720, D7F 722, D7F 726, D7F 744, D7F 746	1149	→ 04/2000; ⚠, für Fahrzeuge mit Servolenkung	0-N1736	VB [DG]	
1.2	08/97-	D7F 710, D7F 720, D7F 722, D7F 726, D7F 744, D7F 746	1149	04/2000 →	0-N2222	VB [TE]	
1.2 16V	06/01-	D4F 712, D4F 714, D4F 716, D4F 730	1149	⚠	0-N1589	VB [TE]	
1.2 16V	06/01-	D4F 712, D4F 714, D4F 716, D4F 730	1149	⚠, für Fahrzeuge mit Servolenkung	0-N1592	VB [DG]	
1.2 16V	06/01-	D4F 712, D4F 714, D4F 716, D4F 730	1149		0-N2222	VB [TE]	
1.4	08/97-	E7J 634, E7J 635, K7J 700, K7J 701	1390		0-N1307	VB [DG]	
1.4	08/97-	E7J 634, E7J 635, K7J 700, K7J 701	1390	⚠	0-N1314	VB [TE]	
1.4	08/97-	E7J 780	1390	⚠	0-N1626	VB [BT]	S
1.4	08/97-	E7J 780	1390		0-N1635	VB [DG]	
1.4	08/97-	E7J 634, E7J 635, K7J 700, K7J 701	1390	⚠	0-N1663	VB [BT]	S
1.4	08/97-	E7J 780	1390	⚠	0-N1721	VB [BT]	
1.5 dCi	12/01-	K9K 700, K9K 704, K9K 702, K9K 710, K9K 704, K9K 714, K9K 718	1461	→ 09/2005; ⚠	0-N1474	VB [BT]	
1.5 dCi	12/01-	K9K 700, K9K 704, K9K 702, K9K 710, K9K 704	1461	→ 01/2005; ⚠	0-N1476	VB [BT]	S
1.5 dCi	12/01-	K9K 700, K9K 704, K9K 702, K9K 710, K9K 704	1461	01/2005 →; ⚠	0-N1664	VB [BT]	S
1.5 dCi	12/01-	K9K 700, K9K 704, K9K 702, K9K 710, K9K 704, K9K 718	1461	09/2005 →; ⚠	0-N1664	VB [BT]	S
1.5 dCi	12/01-	K9K 700, K9K 704, K9K 704, K9K 714, K9K 718	1461	→ 12/2007; Rippenanzahl: 6; ⚠	0-N1898	VB [BT]	S
1.5 dCi	12/01-	K9K 704	1461	12/2007 →; ⚠, für Fahrzeuge ohne Servolenkung	0-N2253	VB [DG]	
1.5 dCi	07/02-	K9K 702, K9K 710	1461	Rippenanzahl: 6; ⚠	0-N1898	VB [BT]	S
1.5 dCi	06/05-	K9K 714	1461		0-N1664	VB [BT]	S
1.5 dCi	06/05-	K9K 718	1461	⚠	0-N1664	VB [BT]	S
1.6 16V, 1.6 16V 4x4	06/01-	K4M 706, K4M 750, K4M 752, K4M 753, K4M 750, K4M 752, K4M 753	1598		0-N1307	VB [DG]	
1.6, 1.6 16V, 1.6 16V 4x4	09/99-06/01	K4M 706, K4M 750, K4M 752, K4M 753, K4M 750, K4M 752, K4M 753, K7M 746	1598	⚠	0-N1314	VB [TE]	



CM³



Art. Nr.



ohne Halter

KANGOO (KC0/1_)								
1.6, 1.6 16V, 1.6 16V 4x4	09/99-06/01	K4M 706, K4M 750, K4M 752, K4M 753, K4M 750, K4M 752, K4M 753, K7M 746	1598	✳		0-N1663	VB [BT]	S
KANGOO Rapid (FC0/1_)								
1.2	08/97-	D7F 720, D7F 726, D7F 746	1149	17x87		SK-1081	BTK	
1.2	07/98-07/01	D7F 764, D7F 766	1149	17x87		SK-1081	BTK	
1.2, 1.2 BiFuel	08/97-07/01	D7F 710, D7F 720, D7F 722, D7F 726, D7F 744, D7F 746, D7F 710, D7F 744, D7F 764, D7F 766	1149	17x87		SK-1081AQ2	BTKW	
1.2 16V	10/01-	D4F 712, D4F 714, D4F 730	1149	23.4x95		SK-1486	BTK	
1.2 16V	10/01-	D4F 712	1149	23.4x95		SK-1486AQ1	BTKW	
1.4	08/97-	E7J 634, E7J 635, E7J 780, K7J 701	1390	17x96; 06/2005 → 11/2009		SK-1338	BTK	
1.4	08/97-	E7J 634, E7J 635, E7J 780	1390	17x96		SK-1338AQ1	BTKW	
1.4	08/97-	K7J 701	1390	17x96		SK-1338AQ2	BTKW	
1.5 dCi	12/01-	K9K 702, K9K 704	1461	27x123; → 08/2003; mit Zubehör		SK-1487	BTK	
1.5 dCi	12/01-	K9K 700, K9K 702	1461	27x123; 08/2003 →; mit Zubehör		SK-1487	BTK	
1.5 dCi	12/01-	K9K 700, K9K 702, K9K 704, K9K 702, K9K 710, K9K 704	1461	27x123; mit Zubehör		SK-1487AQ1	BTKW	
1.5 dCi	12/01-	K9K 700, K9K 702, K9K 704, K9K 702, K9K 710, K9K 704	1461	27x123; 04/2004 →; mit Zubehör		SK-1487AQ2	BTKW	
1.5 dCi	12/02-	K9K 702, K9K 710, K9K 704	1461	27x123; → 08/2003; mit Zubehör		SK-1487	BTK	
1.5 dCi	06/05-	K9K 704, K9K 716, K9K 714, K9K 718	1461	27x123; mit Zubehör		SK-1487	BTK	
1.5 dCi	06/05-	K9K 704, K9K 716, K9K 714, K9K 718	1461	27x123; mit Zubehör		SK-1487AQ2	BTKW	
1.6 16V, 1.6 16V 4x4, 1.6 16V bivalent	10/01-	K4M 706, K4M 752, K4M 750, K4M 752, K4M 753, K4M 850	1598	27x132; mit Zubehör		SK-1088	BTK	
1.6 16V, 1.6 16V 4x4, 1.6 16V bivalent	10/01-	K4M 706, K4M 752, K4M 750, K4M 752, K4M 753, K4M 850	1598	27x132; mit Zubehör		SK-1088AQ1	BTKW	
1.9 D	09/99-06/03	F8Q 632	1870	25.4x151; beinhaltetete Rollen: 2		SK-1108S	BTK	
1.9 D, D 55 1.9	08/97-06/03	F8Q 632, F8Q 662	1870	25.4x151; beinhaltetete Rollen: 3; mit Zahnrad		SK-1108	BTK	
1.9 dCi, 1.9 dCi 4x4	10/01-	F9Q 790	1870	26x153; mit Zubehör		SK-1663	BTK	
1.9 dCi, 1.9 dCi 4x4, 1.9 dTi	02/00-	F9Q 782	1870	26x153; beinhaltetete Rollen: 2		SK-1620	BTK	
1.9 dCi 4x4	07/03-	F9Q 790	1870	26x153; mit Zubehör		SK-1663	BTK	
1.9 dTi	02/00-	F9Q 780	1870	26x153; → 12/2003; beinhaltetete Rollen: 4; mit Zahnrad; mit Zubehör		SK-1490	BTK	
1.9 dTi	02/00-	F9Q 780	1870	26x153; 07/2001 →; beinhaltetete Rollen: 2		SK-1620	BTK	
1.9 dTi	02/00-	F9Q 780	1870	26x153; beinhaltetete Rollen: 2		SK-1620	BTK	
1.9 dTi	02/00-	F9Q 780	1870	26x153; → 12/2003; beinhaltetete Rollen: 3; mit Zubehör		SK-1622	BTK	
D 55 1.9	08/97-	F8Q 662	1870	25.4x151; 07/2001 →; beinhaltetete Rollen: 2		SK-1108S	BTK	
D 65 1.9	08/97-	F8Q 630	1870	25.4x151; beinhaltetete Rollen: 3; mit Zahnrad		SK-1108	BTK	
D 65 1.9	08/97-	F8Q 630	1870	25.4x151; beinhaltetete Rollen: 2		SK-1108S	BTK	
1.2	08/97-07/01	D7F 710, D7F 720, D7F 722, D7F 726, D7F 744, D7F 746, D7F 764, D7F 766	1149			0-N863	TB [TE]	
1.2 16V	10/01-	D4F 712, D4F 714, D4F 730	1149			0-N1112	TB [TE]	
1.4	08/97-	E7J 634	1390			0-N145	TB [TE]	
1.4	08/97-	E7J 780	1390			0-N145	TB [TE]	
1.4	08/97-	K7J 701	1390			0-N145	TB [TE]	
1.5 dCi	12/01-	K9K 700, K9K 702, K9K 704, K9K 702, K9K 710, K9K 704, K9K 704, K9K 716, K9K 714, K9K 718	1461			0-N1111	TB [TE]	
1.6 16V, 1.6 16V 4x4, 1.6 16V bivalent	10/01-	K4M 706, K4M 752, K4M 750, K4M 752, K4M 753, K4M 850	1598			0-N198	TB [TE]	
1.6 16V, 1.6 16V 4x4, 1.6 16V bivalent	10/01-	K4M 706, K4M 752, K4M 750, K4M 752, K4M 753, K4M 850	1598			0-N262	TB [DG]	
1.9 D, 1.9 dCi, 1.9 dCi 4x4, 1.9 dTi, D 55 1.9, D 65 1.9	08/97-06/03	F8Q 630, F8Q 632, F8Q 632, F8Q 662, F9Q 780, F9Q 782, F9Q 782, F9Q 790, F9Q 790	1870			0-N147	TB [DG]	
1.9 D, D 55 1.9, D 65 1.9	08/97-06/03	F8Q 630, F8Q 632, F8Q 632, F8Q 662	1870			0-N173	TB [TE]	
1.9 D, D 55 1.9, D 65 1.9	08/97-06/03	F8Q 630, F8Q 632, F8Q 632, F8Q 662	1870			0-N881	TB [DG]	
1.9 dCi, 1.9 dCi 4x4	10/01-	F9Q 790	1870	→ 10/2009		0-N173	TB [TE]	
1.9 dCi, 1.9 dCi 4x4	07/03-	F9Q 782, F9Q 782, F9Q 790, F9Q 790	1870			0-N148	TB [DG]	
1.9 dCi, 1.9 dCi 4x4	07/03-	F9Q 782, F9Q 782, F9Q 790, F9Q 790	1870			0-N1571	TB [TE]	
1.9 dCi 4x4	10/01-	F9Q 782, F9Q 790	1870			0-N147	TB [DG]	
1.9 dCi 4x4	10/01-	F9Q 790	1870			0-N148	TB [DG]	
1.9 dCi 4x4	10/01-	F9Q 790	1870			0-N1571	TB [TE]	
1.9 dCi 4x4	10/01-	F9Q 782	1870			0-N199	TB [TE]	
1.9 dCi 4x4	07/03-	F9Q 790	1870	→ 10/2009		0-N173	TB [TE]	
1.9 dCi 4x4, 1.9 dTi	02/00-	F9Q 780, F9Q 782, F9Q 790	1870			0-N1106	TB [DG]	
1.9 dTi	02/00-	F9Q 780	1870			0-N199	TB [TE]	

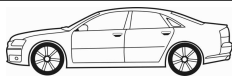

CM³



Art. Nr.



KANGOO Rapid (FC0/1_)							
1.2	08/97-07/01	D7F 710, D7F 720, D7F 722, D7F 726, D7F 744, D7F 746, D7F 764, D7F 766	1149	→ 04/2000	0-N1589	VB [TE]	
1.2	08/97-07/01	D7F 710, D7F 720, D7F 722, D7F 726, D7F 744, D7F 746, D7F 764, D7F 766	1149	04/2000 →; ☼, für Fahrzeuge mit Servolenkung	0-N1592	VB [DG]	
1.2	08/97-07/01	D7F 710, D7F 720, D7F 722, D7F 726, D7F 744, D7F 746, D7F 764, D7F 766	1149	→ 04/2000; ☼, für Fahrzeuge mit Servolenkung	0-N1736	VB [DG]	
1.2	08/97-07/01	D7F 710, D7F 720, D7F 722, D7F 726, D7F 744, D7F 746, D7F 764, D7F 766	1149	04/2000 →	0-N2222	VB [TE]	
1.2 16V	10/01-	D4F 712, D4F 730	1149	☼, für Fahrzeuge mit Servolenkung	0-N1592	VB [DG]	
1.2 16V	10/01-	D4F 712, D4F 730	1149	11/2005 →	0-N2222	VB [TE]	
1.4	08/97-	E7J 634, E7J 635, K7J 701	1390		0-N1307	VB [DG]	
1.4	08/97-	E7J 634, E7J 635, K7J 701	1390	☼	0-N1314	VB [TE]	
1.4	08/97-	E7J 780	1390	☼	0-N1626	VB [BT]	S
1.4	08/97-	E7J 780	1390		0-N1635	VB [DG]	
1.4	08/97-	E7J 634, E7J 635, K7J 701	1390	☼	0-N1663	VB [BT]	S
1.4	08/97-	E7J 780	1390	☼	0-N1721	VB [BT]	
1.5 dCi	12/01-	K9K 700, K9K 702, K9K 704, K9K 702, K9K 710, K9K 704, K9K 714, K9K 718	1461	→ 09/2005; ☼	0-N1474	VB [BT]	
1.5 dCi	12/01-	K9K 700, K9K 702, K9K 704, K9K 702, K9K 710, K9K 704	1461	→ 01/2005; ☼	0-N1476	VB [BT]	S
1.5 dCi	12/01-	K9K 700, K9K 702, K9K 704, K9K 702, K9K 710, K9K 704	1461	01/2005 →; ☼	0-N1664	VB [BT]	S
1.5 dCi	12/01-	K9K 700, K9K 702, K9K 704, K9K 702, K9K 710, K9K 704, K9K 714, K9K 718	1461	09/2005 →; ☼	0-N1664	VB [BT]	S
1.5 dCi	12/01-	K9K 704	1461	→ 12/2007; Rippenanzahl: 6; ☼	0-N1898	VB [BT]	S
1.5 dCi	12/01-	K9K 704	1461	12/2007 →; ☼, für Fahrzeuge ohne Servolenkung	0-N2253	VB [DG]	
1.5 dCi	12/02-	K9K 704, K9K 704, K9K 716, K9K 714, K9K 718	1461	→ 12/2007; Rippenanzahl: 6; ☼	0-N1898	VB [BT]	S
1.5 dCi	12/02-	K9K 704, K9K 704, K9K 716	1461	12/2007 →; ☼, für Fahrzeuge ohne Servolenkung	0-N2253	VB [DG]	
1.5 dCi	04/03-	K9K 702, K9K 710	1461	Rippenanzahl: 6; ☼	0-N1898	VB [BT]	S
1.5 dCi	06/05-	K9K 714, K9K 718	1461	☼	0-N1664	VB [BT]	S
1.5 dCi	10/05-	K9K 704, K9K 716	1461		0-N1664	VB [BT]	S
1.6 16V 4x4 , 1.6 16V bivalent	10/01-	K4M 750, K4M 752, K4M 753, K4M 850	1598	☼	0-N1663	VB [BT]	S
1.6 16V, 1.6 16V 4x4	10/01-	K4M 706, K4M 752, K4M 750, K4M 752, K4M 753	1598		0-N1307	VB [DG]	
1.6 16V, 1.6 16V 4x4	10/01-	K4M 706, K4M 752, K4M 750, K4M 752, K4M 753	1598	☼	0-N1314	VB [TE]	
KANGOO / GRAND KANGOO (KW0/1_)							
1.5 dCi	02/08-	K9K 714, K9K 800, K9K 840	1461	27x123; 06/2008 →; mit Zubehör	SK-1487	BTK	
1.5 dCi	02/08-	K9K 806	1461	27x123; mit Zubehör; Baumuster: KW0F	SK-1487	BTK	
1.5 dCi	02/08-	K9K 802	1461	27x123; 05/2008 →; mit Zubehör	SK-1487AQ2	BTKW	
1.5 dCi	02/08-	K9K 714, K9K 800, K9K 840	1461	27x123; 06/2008 →; mit Zubehör	SK-1487AQ2	BTKW	
1.5 dCi	11/12-	K9K 808	1461	27x123; mit Zubehör	SK-1487AQ3	BTKW	
1.5 dCi	11/12-	K9K608	1461	27x119	SK-1730	BTK	
1.5 dCi	11/12-	K9K608	1461	27x119	SK-1730AQ1	BTKW	
1.5 dCi , 1.5 dCi 110	02/08-	K9K 608, K9K 802, K9K 802, K9K 804, K9K 808	1461	27x123; mit Zubehör	SK-1487	BTK	
1.5 dCi , 1.5 dCi 110	02/08-	K9K 804, K9K 804, K9K 806	1461	27x123; mit Zubehör	SK-1487AQ2	BTKW	
1.5 dCi 110	09/10-	K9K 816	1461	27x123; mit Zubehör	SK-1487AQ3	BTKW	
1.5 dCi, 1.5 dCi 110	11/12-	K9K 636, K9K 808	1461	27x119	SK-1730	BTK	
1.5 dCi, 1.5 dCi 110	11/12-	K9K 636, K9K 808	1461	27x119	SK-1730AQ1	BTKW	
1.6	02/08-	K7M 750	1598	17x96; → 11/2009	SK-1338	BTK	
1.6	02/08-	K7M 750	1598	17.3x96; 11/2009 →	SK-1704AQ1	BTKW	
1.6 16V , 1.6 16V Hi-Flex	02/08-	K4M 830, K4M 831, K4M 834, K4M 850	1598	27x132; mit Zubehör	SK-1088	BTK	
1.6 16V , 1.6 16V Hi-Flex	02/08-	K4M 830, K4M 831, K4M 834, K4M 850	1598	27x132; mit Zubehör	SK-1088AQ1	BTKW	
1.5 dCi	11/12-	K9K 608	1461		0-N2423	TB [TE]	
1.5 dCi , 1.5 dCi 110	02/08-	K9K 714, K9K 800, K9K 840, K9K 802, K9K 804, K9K 804, K9K 806	1461		0-N1111	TB [TE]	
1.5 dCi 110	03/13-	K9K 636	1461		0-N2423	TB [TE]	
1.6	02/08-	K7M 750	1598		0-N145	TB [TE]	
1.6	02/08-	K7M 750	1598	11/2009 →	0-N2062	TB [TE]	
1.6 16V	02/08-	K4M 830, K4M 831	1598		0-N262	TB [DG]	
1.6 16V Hi-Flex	02/08-	K4M 830	1598		0-N262	TB [DG]	
1.6 16V , 1.6 16V Hi-Flex	02/08-	K4M 830, K4M 831, K4M 834, K4M 850	1598		0-N198	TB [TE]	
1.2 TCe 115	07/13-	H5F 400	1197		0-N2308	VB [BT]	S
1.5 dCi	02/08-	K9K 714, K9K 800, K9K 840, K9K 802, K9K 804, K9K 806	1461		0-N1664	VB [BT]	S

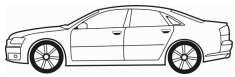

CM³



Art. Nr.



KANGOO / GRAND KANGOO (KW0/1_)

1.5 dCi	02/08-	K9K 608, K9K 802, K9K 714, K9K 800, K9K 840, K9K 802, K9K 804, K9K 808	1461	☼	0-N2253	VB [DG]	
1.5 dCi	11/12-	K9K 608, K9K 802	1461		0-N2290	VB [BT]	S
1.5 dCi, 1.5 dCi 110	02/08-	K9K 802, K9K 804, K9K 804, K9K 806	1461	Rippenanzahl: 6; ☼	0-N1898	VB [BT]	S
1.6 16V	02/08-	K4M 830	1598		0-N1664	VB [BT]	S
1.6 16V	02/08-	K4M 831	1598		0-N1664	VB [BT]	S
1.6 16V	02/08-	K4M 831	1598	→ 04/2009; Rippenanzahl: 6; ☼	0-N1898	VB [BT]	S
1.6 16V	02/08-	K4M 831	1598	04/2009 →; ☼	0-N2253	VB [DG]	
1.6 16V	02/08-	K4M 830	1598	☼	0-N2253	VB [DG]	
1.6 16V Hi-Flex	02/08-	K4M 834, K4M 850	1598		0-N1307	VB [DG]	
1.6 16V Hi-Flex	02/08-	K4M 834, K4M 850	1598	☼	0-N1314	VB [TE]	
1.6 16V Hi-Flex	02/08-	K4M 834, K4M 850	1598	☼	0-N1663	VB [BT]	S
1.6 16V Hi-Flex	02/08-	K4M 834, K4M 850	1598		0-N1664	VB [BT]	S

KANGOO BE BOP (KW0/1_)

1.5 dCi	02/09-	K9K 804, K9K 806, K9K 808	1461	27x123; mit Zubehör	SK-1487	BTK	
1.5 dCi	02/09-	K9K 806	1461	27x123; mit Zubehör	SK-1487AQ2	BTKW	
1.5 dCi	06/09-	K9K 804, K9K 808	1461	27x123; mit Zubehör	SK-1487AQ3	BTKW	
1.6	02/09-	K4M 830	1598	27x132; mit Zubehör	SK-1088	BTK	
1.6	02/09-	K4M 830	1598	27x132; mit Zubehör	SK-1088AQ1	BTKW	
1.5 dCi, 1.5 dCi 75	02/09-	K9K 802, K9K 804, K9K 806, K9K 808	1461		0-N1111	TB [TE]	
1.6	02/09-	K4M 830	1598		0-N198	TB [TE]	
1.6	02/09-	K4M 830	1598		0-N262	TB [DG]	
1.5 dCi, 1.5 dCi 75	02/09-	K9K 802, K9K 804, K9K 806, K9K 808	1461		0-N1664	VB [BT]	S
1.5 dCi, 1.5 dCi 75	02/09-	K9K 802, K9K 804, K9K 806	1461	Rippenanzahl: 6; ☼	0-N1898	VB [BT]	S
1.5 dCi, 1.5 dCi 75	02/09-	K9K 802, K9K 806, K9K 808	1461	☼	0-N2253	VB [DG]	
1.6	02/09-	K4M 830	1598		0-N1664	VB [BT]	S
1.6	02/09-	K4M 830	1598	☼	0-N2253	VB [DG]	

KANGOO Express (FW0/1_)

1.5 dCi, 1.5 dCi 110, 1.5 dCi 75, 1.5 dCi 85	02/08-	K9K 608, K9K 808, K9K 800, K9K 800, K9K 802, K9K 804, K9K 806	1461	27x123; mit Zubehör	SK-1487AQ2	BTKW	
1.5 dCi, 1.5 dCi 110, 1.5 dCi 75, 1.5 dCi 85, 1.5 dCi 90	02/08-	K9K 608, K9K 808, K9K 800, K9K 800, K9K 802, K9K 804, K9K 806	1461	27x123; mit Zubehör	SK-1487	BTK	
1.5 dCi 110	09/13-	K9K 636	1461	27x119	SK-1730	BTK	
1.5 dCi 110	09/13-	K9K 636	1461	27x119	SK-1730AQ1	BTKW	
1.5 dCi 75, 1.5 dCi 90	06/09-	K9K 608, K9K 808	1461	27x119; Baumuster: Kangoo Express	SK-1730	BTK	
1.5 dCi 75, 1.5 dCi 90	06/09-	K9K 608, K9K 808	1461	27x119; Baumuster: Kangoo Rapid	SK-1730	BTK	
1.5 dCi 75, 1.5 dCi 90	06/09-	K9K 608, K9K 808	1461	27x119; Baumuster: Kangoo Express	SK-1730AQ1	BTKW	
1.5 dCi 75, 1.5 dCi 90	06/09-	K9K 608, K9K 808	1461	27x119; Baumuster: Kangoo Rapid	SK-1730AQ1	BTKW	
1.5 dCi 90	06/09-	K9K 608, K9K 808	1461	27x123; mit Zubehör	SK-1487AQ3	BTKW	
1.6	02/08-	K7M 750	1598	17x96; → 11/2009	SK-1338	BTK	
1.6	02/08-	K7M 750	1598	17.3x96; 11/2009 →	SK-1704	BTK	
1.6	02/08-	K7M 750	1598	17.3x96; 11/2009 →; Baumuster: Kangoo Express	SK-1704AQ1	BTKW	
1.6 16V, 1.6 16V LPG	02/08-	K4M 830, K4M 834	1598	27x132; mit Zubehör	SK-1088	BTK	
1.6 16V, 1.6 16V LPG	02/08-	K4M 830, K4M 834	1598	27x132; mit Zubehör	SK-1088AQ1	BTKW	
1.5 dCi, 1.5 dCi 110, 1.5 dCi 75, 1.5 dCi 85, 1.5 dCi 90	02/08-	K9K 608, K9K 808, K9K 800, K9K 800, K9K 802, K9K 804, K9K 806	1461		0-N1111	TB [TE]	
1.5 dCi 110	09/13-	K9K 636	1461		0-N2423	TB [TE]	
1.6	02/08-	K7M 750	1598		0-N145	TB [TE]	
1.6	02/08-	K7M 750	1598	11/2009 →	0-N2062	TB [TE]	
1.6 16V, 1.6 16V LPG	02/08-	K4M 830, K4M 834	1598		0-N198	TB [TE]	
1.6 16V, 1.6 16V LPG	02/08-	K4M 830, K4M 834	1598		0-N262	TB [DG]	
1.2 TCe 115	07/13-	H5F 400	1197		0-N2308	VB [BT]	S
1.5 dCi, 1.5 dCi 110	02/08-	K9K 804, K9K 806	1461	Rippenanzahl: 6; ☼	0-N1898	VB [BT]	S
1.5 dCi, 1.5 dCi 110, 1.5 dCi 75, 1.5 dCi 85, 1.5 dCi 90	02/08-	K9K 608, K9K 808, K9K 800, K9K 800, K9K 802, K9K 804, K9K 806	1461		0-N1664	VB [BT]	S
1.5 dCi, 1.5 dCi 110, 1.5 dCi 75, 1.5 dCi 85, 1.5 dCi 90	02/08-	K9K 608, K9K 808, K9K 800, K9K 800, K9K 802, K9K 804, K9K 806	1461	☼	0-N2253	VB [DG]	
1.6 16V	02/08-	K4M 830	1598		0-N1307	VB [DG]	
1.6 16V	02/08-	K4M 830	1598	☼	0-N1314	VB [TE]	
1.6 16V	02/08-	K4M 830	1598		0-N1664	VB [BT]	S
1.6 16V, 1.6 16V LPG	02/08-	K4M 830, K4M 834	1598	☼	0-N2253	VB [DG]	

KOLEOS (HY_)

2.0 dCi, 2.0 dCi 4x4	09/08-	M9R 830, M9R 832, M9R 855, M9R 856, M9R 862, M9R 865, M9R 866, M9R 855, M9R 856, M9R 862, M9R 865, M9R 866	1995		0-N1739	VB [DG]	
----------------------	--------	--	------	--	---------	---------	--



OPTIMAL®

RENAULT



CM³



Art. Nr.



ohne Halter

KOLEOS (HY_)

2.0 dCi , 2.0 dCi 4x4	09/08-	M9R 830, M9R 832, M9R 855, M9R 856, M9R 862, M9R 865, M9R 866, M9R 855, M9R 856, M9R 862, M9R 865, M9R 866	1995		0-N2039	VB [BT]	S
2.5 , 2.5 4x4	09/08-	2TR 700, 2TR 702, 2TR 703	2488		0-N2211	VB [BT]	S

LAGUNA I (B56_ , 556_)

1.6 16V	11/97-03/01	K4M 720, K4M 724	1598	27x132; mit Zubehör	SK-1088	BTK	
1.6 16V	11/97-03/01	K4M 720, K4M 724	1598	27x132; mit Zubehör	SK-1088AQ1	BTKW	
1.8	11/93-03/01	F3P 676, F3P 720, F3P 724	1794	19x125	SK-1011	BTK	
1.8	06/95-03/01	F3P 670, F3P 678, F3P 674	1783	19x125	SK-1011	BTK	
1.8 16V	04/98-03/01	F4P 760, F4P 770	1783	27x128; Baumuster: B563, B564	SK-1494	BTK	
1.8 16V	04/98-03/01	F4P 760, F4P 770	1783	27x128; 07/1998 →	SK-1625	BTK	
1.8 16V	04/98-03/01	F4P 760, F4P 770	1783	27x128	SK-1631	BTK	
1.9 dCi	09/99-03/01	F9Q 718	1870	26x132; Baumuster: B56W	SK-1493	BTK	
1.9 dCi	09/99-03/01	F9Q 718	1870	26x132	SK-1493AQ1	BTKW	
1.9 dCi	09/99-03/01	F9Q 718	1870	26x132	SK-1493AQ2	BTKW	
1.9 dTi	10/97-03/01	F9Q 710	1870	26x153; → 10/2000; beinhaltete Rollen: 3; mit Zahnrad	SK-1084	BTK	
1.9 dTi	10/97-03/01	F9Q 716	1870	26x153; beinhaltete Rollen: 3; mit Zahnrad	SK-1084	BTK	
1.9 dTi	10/97-03/01	F9Q 710	1870	26x153; → 10/2000; beinhaltete Rollen: 2	SK-1114	BTK	
1.9 dTi	10/97-03/01	F9Q 710	1870	26x153; 10/2000 →; beinhaltete Rollen: 2	SK-1620	BTK	
2.0	11/93-03/01	F3R 611, F3R 722, F3R 723, F3R 722, F3R 768	1998	19x127	SK-1036	BTK	
2.0	06/95-03/01	F3R 611, F3R 722, F3R 768	1998	19x127; mit Zahnrad	SK-1099	BTK	
2.0	06/95-02/01	N7Q 704	1948	23x148; → 12/1997; mit Zubehör	SK-1103AQ1	BTKW	
2.0	06/95-02/01	N7Q 700	1948	23x148; mit Zubehör	SK-1103AQ1	BTKW	
2.0	06/95-02/01	N7Q 700, N7Q 704	1948	23x142; 12/1997 →	SK-1491	BTK	
2.0	06/95-02/01	N7Q 704	1948	23x142; 12/1997 →	SK-1491AQ1	BTKW	
2.0 16V	06/95-03/01	N7Q 700, N7Q 704	1948	23x148; → 12/1997; mit Zubehör	SK-1103AQ1	BTKW	
2.0 16V	06/95-03/01	N7Q 704	1948	23x142; 12/1997 →	SK-1491	BTK	
2.0 16V	06/95-03/01	N7Q 700, N7Q 704	1948	23x142; 12/1997 →	SK-1491AQ1	BTKW	
2.0 16V	06/95-03/01	N7Q 700, N7Q 704	1948	27x128	SK-1494	BTK	
2.0, 2.0 16V	06/95-03/01	N7Q 700, N7Q 704	1948	23x148; → 12/1997; mit Zubehör	SK-1103	BTK	
2.0, 2.0 16V	09/99-03/01	F4R 780	1998	27x128	SK-1494	BTK	
2.2 D	11/93-03/01	G8T 706, G8T 752, G8T 790, G8T 794	2188	25.4x157	SK-1095	BTK	
2.2 D	11/93-03/01	G8T 752, G8T 792, G8T 794	2188	25.4x163	SK-1096	BTK	
2.2 D	11/93-03/01	G8T 752, G8T 794	2188	25.4x163	SK-1096AQ1	BTKW	
2.2 D	11/93-03/01	G8T 706, G8T 790	2188	25.4x157; → 05/1995	SK-1645	BTK	
2.2 dT	03/96-03/01	G8T 760	2188	25.4x163; Baumuster: B569	SK-1096	BTK	
2.2 dT	03/96-03/01	G8T 760	2188	25.4x163	SK-1096AQ1	BTKW	
3.0 24V	03/97-03/01	L7X 700, L7X 701	2946	32x259; 12/1999 →	SK-1483	BTK	
1.6 16V	11/97-03/01	K4M 720, K4M 724	1598		0-N198	TB [TE]	
1.6 16V	11/97-03/01	K4M 720, K4M 724	1598		0-N262	TB [DG]	
1.8	11/93-03/01	F3P 676, F3P 720, F3P 724	1794		0-N173	TB [TE]	
1.8	11/93-03/01	F3P 676, F3P 720, F3P 724	1794		0-N854	TB [DG]	
1.8	06/95-02/01	F3P 674	1783		0-N146	TB [DG]	
1.8	06/95-06/98	F3P 676	1794		0-N146	TB [DG]	
1.8	06/95-03/01	F3P 670, F3P 678, F3P 674	1783		0-N173	TB [TE]	
1.8	06/95-03/01	F3P 670, F3P 678, F3P 674	1783		0-N854	TB [DG]	
1.8 16V	04/98-03/01	F4P 760, F4P 770	1783		0-N1259	TB [DG]	
1.8 16V	04/98-03/01	F4P 760, F4P 770	1783		0-N1365	TB [DG]	
1.8 16V	04/98-03/01	F4P 760, F4P 770	1783		0-N200	TB [TE]	
1.8 16V	04/98-03/01	F4P 760, F4P 770	1783		0-N262	TB [DG]	
1.9 dCi	09/99-03/01	F9Q 718	1870	mit Grundträger	0-N1173	TB [BT]	
1.9 dTi	10/97-03/01	F9Q 710, F9Q 717	1870	10/2000 →	0-N1106	TB [DG]	
1.9 dTi	10/97-03/01	F9Q 710, F9Q 716, F9Q 717	1870		0-N147	TB [DG]	
1.9 dTi	10/97-03/01	F9Q 716	1870		0-N148	TB [DG]	
1.9 dTi	10/97-03/01	F9Q 710	1870	→ 10/2000	0-N148	TB [DG]	
1.9 dTi	10/97-03/01	F9Q 716	1870		0-N173	TB [TE]	
1.9 dTi	10/97-03/01	F9Q 710	1870	→ 10/2000	0-N173	TB [TE]	
1.9 dTi	10/97-03/01	F9Q 717	1870		0-N199	TB [TE]	
1.9 dTi	10/97-03/01	F9Q 710	1870	10/2000 →	0-N199	TB [TE]	
2.0	11/93-03/01		1994		0-N173	TB [TE]	
2.0	11/93-03/01	F3R 611, F3R 722, F3R 723, F3R 722, F3R 768	1998		0-N173	TB [TE]	
2.0	11/93-03/01		1994		0-N854	TB [DG]	



CM³



Art. Nr.



ohne Halter

LAGUNA I (B56_, 556_)

2.0	11/93-03/01	F3R 611, F3R 722, F3R 723, F3R 722, F3R 768	1998		0-N854	TB [DG]	
2.0	06/95-03/01	F3R 611, F3R 722, F3R 768	1998		0-N146	TB [DG]	
2.0, 2.0 16V	06/95-03/01	N7Q 700, N7Q 704	1948	12/1997 →	0-N137	TB [TE]	
2.0, 2.0 16V	06/95-03/01	N7Q 700, N7Q 704	1948	→ 12/1997	0-N930	TB [TE]	
2.0, 2.0 16V	06/95-03/01	N7Q 700, N7Q 704	1948		0-N958	TB [DG]	
2.0, 2.0 16V	09/99-03/01	F4R 780	1998		0-N1259	TB [DG]	
2.0, 2.0 16V	09/99-03/01	F4R 780	1998		0-N200	TB [TE]	
2.0, 2.0 16V	09/99-03/01	F4R 780	1998		0-N262	TB [DG]	
2.2 D	11/93-03/01	G8T 706, G8T 752, G8T 790, G8T 794	2188		0-N277	TB [DG]	
2.2 D	11/93-03/01	G8T 706, G8T 790	2188		0-N964	TB [DG]	
2.2 D	11/93-03/01	G8T 752, G8T 794	2188		0-N965	TB [DG]	
2.2 D, 2.2 dT	11/93-03/01	G8T 706, G8T 752, G8T 790, G8T 794, G8T 760	2188		0-N112	TB [TE]	
2.2 dT	03/96-03/01	G8T 760	2188		0-N965	TB [DG]	
3.0 24V	03/97-03/01	L7X 700, L7X 701	2946	12/1999 →	0-N1056	TB [TE]	
3.0 24V	03/97-03/01	L7X 700, L7X 701	2946		0-N170	TB [DG]	
3.0 24V	03/97-03/01	L7X 700, L7X 701	2946		0-N171	TB [DG]	
1.6 16V	11/97-03/01	K4M 720, K4M 724	1598		0-N1307	VB [DG]	
1.6 16V	11/97-03/01	K4M 720, K4M 724	1598	✳	0-N1314	VB [TE]	
1.6 16V	11/97-03/01	K4M 720, K4M 724	1598	✳	0-N1663	VB [BT]	S
1.8	11/93-03/01	F3P 676, F3P 720, F3P 724	1794	mit Anbaumaterial	0-N139	VB [TE]	
1.8	06/95-03/01	F3P 670, F3P 678, F3P 674	1783	mit Anbaumaterial	0-N139	VB [TE]	
1.8 16V	04/98-03/01	F4P 760, F4P 770	1783		0-N1307	VB [DG]	
1.8 16V	04/98-03/01	F4P 760, F4P 770	1783	✳	0-N1663	VB [BT]	S
1.9 dCi	09/99-03/01	F9Q 718	1870		0-N1611	VB [BT]	S
1.9 dTi	10/97-03/01	F9Q 710, F9Q 716, F9Q 717	1870	✳	0-N1470	VB [BT]	S
1.9 dTi	10/97-03/01	F9Q 710, F9Q 716, F9Q 717	1870	✳	0-N1729	VB [DG]	
2.0	11/93-03/01		1994	mit Anbaumaterial	0-N139	VB [TE]	
2.0	11/93-03/01	F3R 611, F3R 722, F3R 723, F3R 722, F3R 768	1998	mit Anbaumaterial	0-N139	VB [TE]	
2.0, 2.0 16V	06/95-03/01	N7Q 700, N7Q 704	1948		0-N143	VB [DG]	
2.0, 2.0 16V	06/95-03/01	N7Q 700, N7Q 704	1948		0-N1518	VB [BT]	S
2.0, 2.0 16V	06/95-03/01	N7Q 700, N7Q 704	1948	📅: →121997	0-N2223	VB [VD]	
2.0, 2.0 16V	09/99-03/01	F4R 780	1998		0-N1307	VB [DG]	
2.0, 2.0 16V	09/99-03/01	F4R 780	1998	✳	0-N1663	VB [BT]	S
2.2 D	11/93-03/01	G8T 752, G8T 794	2188		0-N1488	VB [BT]	S
2.2 D	11/93-03/01	G8T 752, G8T 794	2188		0-N1590	VB [DG]	
2.2 D	11/93-03/01	G8T 706, G8T 790	2188	†	0-N1602	VB [DG]	
2.2 D	11/93-03/01	G8T 752, G8T 794	2188	✳	0-N1752	VB [BT]	
2.2 D	11/93-03/01	G8T 752, G8T 794	2188		0-N1916	VB [BT]	
2.2 D	11/93-03/01	G8T 706, G8T 790	2188	Rippenanzahl: 6	0-N2013	VB [DG]	
2.2 D	11/93-03/01	G8T 706, G8T 790	2188		0-N2016	VB [BT]	
2.2 D	11/93-03/01	G8T 752, G8T 794	2188		0-N2179	VB [TE]	
2.2 dT	03/96-03/01	G8T 760	2188		0-N1488	VB [BT]	S
2.2 dT	03/96-03/01	G8T 760	2188		0-N1590	VB [DG]	
2.2 dT	03/96-03/01	G8T 760	2188	✳	0-N1752	VB [BT]	
2.2 dT	03/96-03/01	G8T 760	2188		0-N1916	VB [BT]	
2.2 dT	03/96-03/01	G8T 760	2188		0-N2179	VB [TE]	
3.0	11/93-03/01	Z7X 760, Z7X 765	2963	mit Grundträger; ✳	0-N2333	VB [TE]	
3.0	11/93-03/01	Z7X 760, Z7X 765	2963	mit Grundträger	0-N2334	VB [TE]	
3.0	11/93-03/01	Z7X 760, Z7X 765	2963	Rippenanzahl: 5; mit Grundträger; für Fahrzeuge mit Servolenkung	0-N2335	VB [TE]	
3.0	11/93-03/01	Z7X 760, Z7X 765	2963	mit Grundträger	0-N2336	VB [TE]	
3.0	11/93-03/01	Z7X 760, Z7X 765	2963	mit Grundträger; ✳	0-N2342	VB [DG]	
3.0 24V	03/97-03/01	L7X 700, L7X 701	2946		0-N1449	VB [TE]	
3.0 24V	03/97-03/01	L7X 700, L7X 701	2946		0-N1757	VB [VD]	
3.0 24V	03/97-03/01	L7X 700, L7X 701	2946		0-N2175	VB [BT]	

LAGUNA I Grandtour (K56_)

1.6 16V	11/97-03/01	K4M 720, K4M 724	1598	27x132; mit Zubehör	SK-1088	BTK	
1.6 16V	11/97-03/01	K4M 720, K4M 724	1598	27x132; mit Zubehör	SK-1088AQ1	BTKW	
1.8	09/95-03/01	F3P 670, F3P 678	1783	19x125	SK-1011	BTK	
1.8	09/95-03/01	F3P 720, F3P 724	1794	19x125	SK-1011	BTK	
1.8 16V	04/98-03/01	F4P 760	1783	27x128	SK-1494	BTK	
1.8 16V	04/98-03/01	F4P 760	1783	27x128; 07/1998 →	SK-1625	BTK	
1.8 16V	04/98-03/01	F4P 760	1783	27x128	SK-1631	BTK	



CM³



Art. Nr.



ohne Halter

LAGUNA I Grandtour (K56_)

1.9 dCi	09/99-03/01	F9Q 718	1870	26x132	SK-1493	BTK	
1.9 dCi	09/99-03/01	F9Q 718	1870	26x132	SK-1493AQ1	BTKW	
1.9 dCi	09/99-03/01	F9Q 718	1870	26x132	SK-1493AQ2	BTKW	
1.9 dTi	10/97-03/01	F9Q 710	1870	26x153; → 10/2000; beinhaltetete Rollen: 3; mit Zahnrad	SK-1084	BTK	
1.9 dTi	10/97-03/01	F9Q 716	1870	26x153; beinhaltetete Rollen: 3; mit Zahnrad	SK-1084	BTK	
1.9 dTi	10/97-03/01	F9Q 710	1870	26x153; → 10/2000; beinhaltetete Rollen: 2	SK-1114	BTK	
1.9 dTi	10/97-03/01	F9Q 710	1870	26x153; 10/2000 →; beinhaltetete Rollen: 2	SK-1620	BTK	
2.0	09/95-03/01	F3R722	1998	19x127	SK-1036	BTK	
2.0	09/95-03/01	F3R722	1998	19x127; mit Zahnrad	SK-1099	BTK	
2.0	10/98-01/01	F3R 728, F3R 768	1998	19x127	SK-1036	BTK	
2.0	10/98-01/01	F3R 728, F3R 768	1998	19x127; mit Zahnrad	SK-1099	BTK	
2.0 16V	09/95-03/01	N7Q 700, N7Q 704	1948	23x148; → 12/1997; mit Zubehör	SK-1103	BTK	
2.0 16V	09/95-03/01	N7Q 704	1948	23x148; → 12/1997; mit Zubehör	SK-1103AQ1	BTKW	
2.0 16V	09/95-03/01	N7Q 700, N7Q 704	1948	23x142; 12/1997 →	SK-1491	BTK	
2.0 16V	09/95-03/01	N7Q 704	1948	23x142; 12/1997 →	SK-1491AQ1	BTKW	
2.0 16V	09/95-03/01	N7Q 700, N7Q 704	1948	27x128	SK-1494	BTK	
2.0 16V	09/99-03/01	F4R 780	1998	27x128	SK-1494	BTK	
2.2 D	09/95-03/01	G8T 706, G8T 752, G8T 790, G8T 794	2188	25.4x157	SK-1095	BTK	
2.2 D	09/95-03/01	G8T 752, G8T 792, G8T 794	2188	25.4x163	SK-1096	BTK	
2.2 D	09/95-03/01	G8T 752, G8T 794	2188	25.4x163	SK-1096AQ1	BTKW	
2.2 D	09/95-03/01	G8T 706, G8T 790	2188	25.4x157; → 11/1999	SK-1645	BTK	
2.2 dT	03/96-03/01	G8T 760	2188	25.4x163	SK-1096	BTK	
2.2 dT	03/96-03/01	G8T 760	2188	25.4x163	SK-1096AQ1	BTKW	
3.0 24V	03/97-03/01	L7X 700, L7X 701	2946	32x259; 12/1999 →	SK-1483	BTK	
1.6 16V	11/97-03/01	K4M 720, K4M 724	1598		0-N198	TB [TE]	
1.6 16V	11/97-03/01	K4M 720, K4M 724	1598		0-N262	TB [DG]	
1.8	09/95-03/01	F3P 670, F3P 678	1783		0-N173	TB [TE]	
1.8	09/95-03/01	F3P 720, F3P 724	1794		0-N173	TB [TE]	
1.8	09/95-03/01	F3P 670, F3P 678	1783		0-N854	TB [DG]	
1.8	09/95-03/01	F3P 720, F3P 724	1794		0-N854	TB [DG]	
1.8 16V	04/98-03/01	F4P 760	1783		0-N1259	TB [DG]	
1.8 16V	04/98-03/01	F4P 760	1783		0-N1365	TB [DG]	
1.8 16V	04/98-03/01	F4P 760	1783		0-N200	TB [TE]	
1.8 16V	04/98-03/01	F4P 760	1783		0-N262	TB [DG]	
1.9 dCi	09/99-03/01	F9Q 718	1870	mit Grundträger	0-N1173	TB [BT]	
1.9 dTi	10/97-03/01	F9Q 710, F9Q 717	1870	10/2000 →	0-N1106	TB [DG]	
1.9 dTi	10/97-03/01	F9Q 710, F9Q 716, F9Q 717	1870		0-N147	TB [DG]	
1.9 dTi	10/97-03/01	F9Q 716	1870		0-N148	TB [DG]	
1.9 dTi	10/97-03/01	F9Q 710	1870	→ 10/2000	0-N148	TB [DG]	
1.9 dTi	10/97-03/01	F9Q 716	1870		0-N173	TB [TE]	
1.9 dTi	10/97-03/01	F9Q 710	1870	→ 10/2000	0-N173	TB [TE]	
1.9 dTi	10/97-03/01	F9Q 717	1870		0-N199	TB [TE]	
1.9 dTi	10/97-03/01	F9Q 710	1870	10/2000 →	0-N199	TB [TE]	
2.0	09/95-03/01	F3R 722, F3R 723, F3R 728, F3R 768	1998		0-N173	TB [TE]	
2.0	09/95-03/01	F3R 722, F3R 723, F3R 728, F3R 768	1998		0-N854	TB [DG]	
2.0	10/98-01/01	F3R 728, F3R 768	1998		0-N146	TB [DG]	
2.0 16V	09/95-03/01	N7Q 700, N7Q 704	1948	12/1997 →	0-N137	TB [TE]	
2.0 16V	09/95-03/01	N7Q 700, N7Q 704	1948	→ 12/1997	0-N930	TB [TE]	
2.0 16V	09/95-03/01	N7Q 700, N7Q 704	1948		0-N958	TB [DG]	
2.0 16V	09/99-03/01	F4R 780	1998		0-N1259	TB [DG]	
2.0 16V	09/99-03/01	F4R 780	1998		0-N200	TB [TE]	
2.0 16V	09/99-03/01	F4R 780	1998		0-N262	TB [DG]	
2.2 D	09/95-03/01	G8T 706, G8T 752, G8T 790, G8T 794	2188		0-N277	TB [DG]	
2.2 D	09/95-03/01	G8T 706, G8T 790	2188		0-N964	TB [DG]	
2.2 D	09/95-03/01	G8T 752, G8T 794	2188		0-N965	TB [DG]	
2.2 D, 2.2 dT	09/95-03/01	G8T 706, G8T 752, G8T 790, G8T 794, G8T 760	2188		0-N112	TB [TE]	
2.2 dT	03/96-03/01	G8T 760	2188		0-N965	TB [DG]	
3.0 24V	03/97-03/01	L7X 700, L7X 701	2946	12/1999 →	0-N1056	TB [TE]	
3.0 24V	03/97-03/01	L7X 700, L7X 701	2946		0-N170	TB [DG]	
3.0 24V	03/97-03/01	L7X 700, L7X 701	2946		0-N171	TB [DG]	
1.6 16V	11/97-03/01	K4M 720, K4M 724	1598		0-N1307	VB [DG]	
1.6 16V	11/97-03/01	K4M 720, K4M 724	1598	⊗	0-N1314	VB [TE]	
1.6 16V	11/97-03/01	K4M 720, K4M 724	1598	⊗	0-N1663	VB [BT]	S
1.8	09/95-03/01	F3P 670, F3P 678	1783	mit Anbaumaterial	0-N139	VB [TE]	

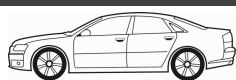

CM³



Art. Nr.



ohne Halter

LAGUNA I Grandtour (K56_)							
1.8	09/95-03/01	F3P 720, F3P 724	1794	mit Anbaumaterial	0-N139	VB [TE]	
1.8 16V	04/98-03/01	F4P 760	1783		0-N1307	VB [DG]	
1.8 16V	04/98-03/01	F4P 760	1783	☼	0-N1663	VB [BT]	S
1.9 dCi	09/99-03/01	F9Q 718	1870		0-N1611	VB [BT]	S
1.9 dTi	10/97-03/01	F9Q 710, F9Q 716, F9Q 717	1870	☼	0-N1470	VB [BT]	S
1.9 dTi	10/97-03/01	F9Q 710, F9Q 716, F9Q 717	1870	☼	0-N1729	VB [DG]	
2.0	09/95-03/01	F3R 722, F3R 723, F3R 728, F3R 768	1998	mit Anbaumaterial	0-N139	VB [TE]	
2.0 16V	09/95-03/01	N7Q 700, N7Q 704	1948		0-N143	VB [DG]	
2.0 16V	09/95-03/01	N7Q 700, N7Q 704	1948		0-N1518	VB [BT]	S
2.0 16V	09/95-03/01	N7Q 700, N7Q 704	1948	☼ → 121997	0-N2223	VB [VD]	
2.0 16V	09/99-03/01	F4R 780	1998		0-N1307	VB [DG]	
2.0 16V	09/99-03/01	F4R 780	1998	☼	0-N1663	VB [BT]	S
2.2 D	09/95-03/01	G8T 752, G8T 794	2188		0-N1488	VB [BT]	S
2.2 D	09/95-03/01	G8T 752, G8T 794	2188		0-N1590	VB [DG]	
2.2 D	09/95-03/01	G8T 706, G8T 790	2188	†	0-N1602	VB [DG]	
2.2 D	09/95-03/01	G8T 752, G8T 794	2188	☼	0-N1752	VB [BT]	
2.2 D	09/95-03/01	G8T 752, G8T 794	2188		0-N1916	VB [BT]	
2.2 D	09/95-03/01	G8T 706, G8T 790	2188	Rippenanzahl: 6	0-N2013	VB [DG]	
2.2 D	09/95-03/01	G8T 706, G8T 790	2188		0-N2016	VB [BT]	
2.2 D	09/95-03/01	G8T 752, G8T 794	2188		0-N2179	VB [TE]	
2.2 dT	03/96-03/01	G8T 760	2188		0-N1488	VB [BT]	S
2.2 dT	03/96-03/01	G8T 760	2188		0-N1590	VB [DG]	
2.2 dT	03/96-03/01	G8T 760	2188	☼	0-N1752	VB [BT]	
2.2 dT	03/96-03/01	G8T 760	2188		0-N1916	VB [BT]	
2.2 dT	03/96-03/01	G8T 760	2188		0-N2179	VB [TE]	
3.0	02/96-03/01	Z7X 765	2963	mit Grundträger; ☼	0-N2333	VB [TE]	
3.0	02/96-03/01	Z7X 765	2963	mit Grundträger	0-N2334	VB [TE]	
3.0	02/96-03/01	Z7X 765	2963	Rippenanzahl: 5; mit Grundträger; für Fahrzeuge mit Servolenkung	0-N2335	VB [TE]	
3.0	02/96-03/01	Z7X 765	2963	mit Grundträger	0-N2336	VB [TE]	
3.0	02/96-03/01	Z7X 765	2963	mit Grundträger; ☼	0-N2342	VB [DG]	
3.0 24V	03/97-03/01	L7X 700, L7X 701	2946		0-N1449	VB [TE]	
3.0 24V	03/97-03/01	L7X 700, L7X 701	2946		0-N1757	VB [VD]	
3.0 24V	03/97-03/01	L7X 700, L7X 701	2946		0-N2175	VB [BT]	

LAGUNA II (BG0/1_)							
1.6 16V	03/01-	K4M 710, K4M 714	1598	27x132; mit Zubehör	SK-1088	BTK	
1.6 16V	03/01-	K4M 710, K4M 714	1598	27x132; mit Zubehör	SK-1088AQ1	BTKW	
1.6 16V	02/05-	K4M 716	1598	27x132	SK-1630	BTK	
1.6 16V	02/05-	K4M 716	1598	27x132	SK-1630AQ1	BTKW	
1.8 16V	03/01-	F4P 770, F4P 771, F4P 773, F4P 774, F4P 775, F4P 770, F4P 772, F4P 770, F4P 773, F4P 770, F4P 774	1783	27x126; → 04/2001; mit Zubehör	SK-1623	BTK	
1.8 16V	03/01-	F4P 770, F4P 774	1783	27x126; Baumuster: BG04, BG06, BG0B, BG0C	SK-1624	BTK	
1.8 16V	03/01-	F4P 771, F4P 773	1783	27x126; Baumuster: BG04, BG06, BG0B, BG0C	SK-1624	BTK	
1.8 16V	03/01-	F4P 770, F4P 772	1783	27x126; Baumuster: BG0B, BG0C, BG0J, BG0M	SK-1624	BTK	
1.8 16V	03/01-	F4P 770	1783	27x126; Baumuster: BG0J	SK-1624	BTK	
1.8 16V	03/01-	F4P 770, F4P 771	1783	27x126	SK-1624AQ1	BTKW	
1.8 16V	03/01-	F4P 770	1783	27x126; 04/2001 →	SK-1624AQ1	BTKW	
1.8 16V	03/01-	F4P 770	1783	27x126; 05/2001 →	SK-1624AQ1	BTKW	
1.9 dCi	03/01-	F9Q 718, F9Q 754	1870	26x132; 09/2001 →	SK-1493	BTK	
1.9 dCi	03/01-	F9Q 670	1870	26x132; Baumuster: BG0G	SK-1493	BTK	
1.9 dCi	03/01-	F9Q 718, F9Q 754, F9Q 752, F9Q 754	1870	26x132	SK-1493AQ1	BTKW	
1.9 dCi	03/01-	F9Q 750	1870	26x132	SK-1493AQ1	BTKW	
1.9 dCi	03/01-	F9Q 718, F9Q 754, F9Q 752, F9Q 754	1870	26x132	SK-1493AQ2	BTKW	
1.9 dCi	03/01-	F9Q 750	1870	26x132	SK-1493AQ2	BTKW	
1.9 dCi	06/01-	F9Q 752	1870	26x132; Baumuster: BG0E	SK-1493	BTK	
1.9 dCi	10/01-	F9Q 754	1870	26x132; Baumuster: BG0R	SK-1493	BTK	
1.9 dCi	03/04-	F9Q 664	1870	26x133	SK-1580	BTK	
1.9 dCi	03/04-	F9Q 664, F9Q 758, F9Q 759	1870	26x133	SK-1580AQ1	BTKW	
1.9 dCi	01/05-	F9Q 674	1870	26x133; Baumuster: BG1A, BG1W	SK-1580	BTK	
1.9 dCi	05/05-	F9Q 758, F9Q 759	1870	26x133; Baumuster: BG1A, BG1V	SK-1580	BTK	
2.0 16V	08/02-	F4R 714	1998	27x126	SK-1624	BTK	
2.0 16V	08/02-	F4R 712, F4R 713	1998	27x126; Baumuster: BG00, BG0K, BG0W	SK-1624	BTK	



CM³



Art. Nr.



ohne Halter

LAGUNA II (BG0/1_)

2.0 16V	08/02-	F4R 712, F4R 713	1998	27x126	SK-1624AQ1	BTKW	
2.0 16V	01/05-	F4R 784, F4R 786, F4R 787	1998	27x126; Baumuster: BG03, BG0T, BG0Z, BG1Y	SK-1624	BTK	
2.0 16V	01/05-	F4R 886, F4R 887	1998	27x126; Baumuster: BG1Y	SK-1624	BTK	
2.0 16V Turbo	01/03-	F4R 764, F4R 765	1998	27x126; 09/2003 →; Baumuster: BG0S, BG1L, BG1M	SK-1624	BTK	
2.0 16V, 2.0 16V Turbo	01/03-	F4R 764, F4R 765, F4R 786, F4R 787, F4R 784, F4R 786, F4R 787, F4R 886, F4R 887	1998	27x126	SK-1624AQ1	BTKW	
2.2 dCi	10/01-10/05	G9T 600, G9T 600, G9T 605, G9T 706, G9T 707, G9T 700, G9T 702	2188	25x89; mit Zubehör	SK-1489	BTK	
3.0 V6 24V	03/01-	L7X 731	2946	32x259	SK-1483	BTK	
3.0 V6 24V	03/01-	L7X 731	2946	32x259	SK-1483AQ1	BTKW	
1.6 16V	03/01-	K4M 710, K4M 714	1598		0-N198	TB [TE]	
1.6 16V	03/01-	K4M 710, K4M 714, K4M 716	1598		0-N262	TB [DG]	
1.6 16V	02/05-	K4M 716	1598		0-N1368	TB [TE]	
1.8 16V	03/01-	F4P 770, F4P 771, F4P 773, F4P 774, F4P 775, F4P 770, F4P 772, F4P 770, F4P 773, F4P 770, F4P 774	1783		0-N1365	TB [DG]	
1.8 16V	03/01-	F4P 770, F4P 771, F4P 773, F4P 774, F4P 775, F4P 770, F4P 772, F4P 770, F4P 773, F4P 770, F4P 774	1783		0-N200	TB [TE]	
1.8 16V	03/01-	F4P 770, F4P 771, F4P 773, F4P 774, F4P 775, F4P 770, F4P 772, F4P 770, F4P 773	1783	→ 04/2001	0-N262	TB [DG]	
1.9 dCi	03/01-	F9Q 650, F9Q 670, F9Q 674, F9Q 750, F9Q 718, F9Q 754, F9Q 752, F9Q 754	1870	mit Grundträger	0-N1173	TB [BT]	
1.9 dCi	03/01-	F9Q 674	1870	mit Anbaumaterial	0-N1323	TB [TE]	
1.9 dCi	03/04-	F9Q 664, F9Q 674, F9Q 758, F9Q 758, F9Q 759	1870	mit Anbaumaterial	0-N1323	TB [TE]	
2.0 16V, 2.0 16V Turbo	08/02-	F4R 712, F4R 713, F4R 714, F4R 715, F4R 764, F4R 765, F4R 786, F4R 787, F4R 784, F4R 786, F4R 787, F4R 886, F4R 887	1998		0-N1365	TB [DG]	
2.0 16V, 2.0 16V Turbo	08/02-	F4R 712, F4R 713, F4R 714, F4R 715, F4R 764, F4R 765, F4R 786, F4R 787, F4R 784, F4R 786, F4R 787, F4R 886, F4R 887	1998		0-N200	TB [TE]	
2.0 16V IDE	04/01-	F5R 700	1998		0-N1365	TB [DG]	
2.0 16V IDE	04/01-	F5R 700	1998		0-N200	TB [TE]	
2.0 16V IDE	04/01-	F5R 700, F5R 701	1998	→ 04/2001	0-N262	TB [DG]	
2.2 dCi	10/01-10/05	G9T 600, G9T 600, G9T 605, G9T 706, G9T 707, G9T 700, G9T 702	2188		0-N1269	TB [TE]	
2.2 dCi	10/01-10/05	G9T 600, G9T 600, G9T 605, G9T 706, G9T 707, G9T 700, G9T 702	2188		0-N1270	TB [DG]	
3.0 V6 24V	03/01-	L7X 731	2946		0-N1056	TB [TE]	
3.0 V6 24V	03/01-	L7X 731	2946		0-N170	TB [DG]	
3.0 V6 24V	03/01-	L7X 731	2946		0-N171	TB [DG]	
1.6 16V	03/01-	K4M 710, K4M 714, K4M 716	1598		0-N1307	VB [DG]	
1.6 16V	03/01-	K4M 710, K4M 714	1598	☼	0-N1314	VB [TE]	
1.6 16V	03/01-	K4M 710, K4M 714	1598	☼	0-N1663	VB [BT]	S
1.6 16V	02/05-	K4M 716	1598		0-N1663	VB [BT]	S
1.8 16V	03/01-	F4P 770, F4P 771, F4P 773, F4P 774, F4P 775, F4P 770, F4P 772, F4P 770, F4P 773	1783		0-N1409	VB [DG]	
1.8 16V	03/01-	F4P 770, F4P 771, F4P 773, F4P 774, F4P 775, F4P 770, F4P 772, F4P 770, F4P 773	1783		0-N1611	VB [BT]	S
1.9 dCi	03/01-	F9Q 750	1870	04/2001 → 03/2002	0-N1307	VB [DG]	
1.9 dCi	03/01-	F9Q 754	1870	04/2001 → 03/2002	0-N1307	VB [DG]	
1.9 dCi	03/01-	F9Q 754	1870	04/2002 →	0-N1409	VB [DG]	
1.9 dCi	03/01-	F9Q 718, F9Q 754	1870		0-N1611	VB [BT]	S
1.9 dCi	03/01-	F9Q 650, F9Q 670, F9Q 674, F9Q 750, F9Q 664, F9Q 674, F9Q 758, F9Q 752, F9Q 754, F9Q 758, F9Q 759	1870	☼	0-N1611	VB [BT]	S
1.9 dCi	06/01-	F9Q 752, F9Q 754	1870	→ 03/2002	0-N1307	VB [DG]	
1.9 dCi	06/01-	F9Q 752	1870	☼	0-N1802	VB [BT]	S
1.9 dCi	03/04-	F9Q 664, F9Q 674, F9Q 758, F9Q 758, F9Q 759	1870	☼	0-N1409	VB [DG]	
2.0 16V, 2.0 16V IDE, 2.0 16V Turbo	04/01-	F4R 712, F4R 713, F4R 714, F4R 715, F4R 764, F4R 765, F4R 786, F4R 787, F4R 784, F4R 786, F4R 787, F4R 886, F4R 887, F5R 700, F5R 701	1998	☼	0-N1611	VB [BT]	S
2.0 16V, 2.0 16V Turbo	08/02-	F4R 712, F4R 713, F4R 714, F4R 715, F4R 764, F4R 765, F4R 786, F4R 787, F4R 784, F4R 786, F4R 787, F4R 886, F4R 887	1998	☼	0-N1409	VB [DG]	
2.0 16V IDE	04/01-	F5R 700, F5R 701	1998		0-N1409	VB [DG]	
2.0 dCi	08/05-	M9R 740, M9R 760	1995		0-N1739	VB [DG]	

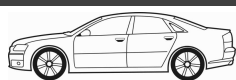

CM³



Art. Nr.



ohne Halter

LAGUNA II (BG0/1_)							
2.0 dCi	08/05-	M9R 740, M9R 760	1995			0-N2039	VB [BT] S
2.2 dCi	10/01-	G9T 600, G9T 605, G9T 706, G9T 707, G9T 700, G9T 702	2188			0-N1409	VB [DG]
2.2 dCi	10/01-	G9T 600, G9T 605, G9T 706, G9T 707, G9T 700, G9T 702	2188	Rippenanzahl: 6		0-N1648	VB [DG]
2.2 dCi	10/01-10/05	G9T 600, G9T 600, G9T 605, G9T 706, G9T 707, G9T 700, G9T 702	2188			0-N1731	VB [BT] S
3.0 V6 24V	03/01-	L7X 731	2946			0-N1449	VB [TE]
3.0 V6 24V	03/01-	L7X 731	2946			0-N1473	VB [BT] S
3.0 V6 24V	03/01-	L7X 731	2946			0-N1757	VB [VD]
3.0 V6 24V	03/01-	L7X 731	2946	05/2004 → 09/2007		0-N1803	VB [DG]

LAGUNA II Grandtour (KG0/1_)							
1.6 16V	03/01-	K4M 710, K4M 714	1598	27x132; mit Zubehör		SK-1088	BTK
1.6 16V	03/01-	K4M 710, K4M 714	1598	27x132; mit Zubehör		SK-1088AQ1	BTKW
1.6 16V	02/05-	K4M 716	1598	27x132		SK-1630	BTK
1.6 16V	02/05-	K4M 716	1598	27x132		SK-1630AQ1	BTKW
1.8 16V	03/01-	F4P 770, F4P 770, F4P 771, F4P 774, F4P 775, F4P 770, F4P 773, F4P 770, F4P 774	1783	27x126; → 04/2001; mit Zubehör		SK-1623	BTK
1.8 16V	03/01-	F4P 770	1783	27x126		SK-1624	BTK
1.8 16V	03/01-	F4P 771, F4P 773	1783	27x126		SK-1624	BTK
1.8 16V	03/01-	F4P 770, F4P 774	1783	27x126		SK-1624AQ1	BTKW
1.8 16V	03/01-	F4P 770	1783	27x126; 04/2001 →		SK-1624AQ1	BTKW
1.8 16V	03/01-	F4P 771	1783	27x126; 04/2001 →		SK-1624AQ1	BTKW
1.9 dCi	03/01-	F9Q 670	1870	26x132		SK-1493	BTK
1.9 dCi	03/01-	F9Q 718, F9Q 754	1870	26x132; 09/2001 →		SK-1493	BTK
1.9 dCi	03/01-	F9Q 718, F9Q 754, F9Q 752	1870	26x132		SK-1493AQ1	BTKW
1.9 dCi	03/01-	F9Q 750	1870	26x132		SK-1493AQ1	BTKW
1.9 dCi	03/01-	F9Q 718, F9Q 754, F9Q 752	1870	26x132		SK-1493AQ2	BTKW
1.9 dCi	03/01-	F9Q 750	1870	26x132		SK-1493AQ2	BTKW
1.9 dCi	06/01-	F9Q 752	1870	26x132		SK-1493	BTK
1.9 dCi	03/04-	F9Q 664, F9Q 758, F9Q 759	1870	26x133		SK-1580	BTK
1.9 dCi	03/04-	F9Q 664, F9Q 758, F9Q 759	1870	26x133		SK-1580AQ1	BTKW
1.9 dCi	01/05-	F9Q 674	1870	26x133; Baumuster: KG1W		SK-1580	BTK
2.0 16V	08/02-	F4R 712, F4R 713	1998	27x126; Baumuster: KG00, KG0W		SK-1624	BTK
2.0 16V	08/02-	F4R 712, F4R 713	1998	27x126		SK-1624AQ1	BTKW
2.0 16V Turbo	01/03-	F4R 764, F4R 765	1998	27x126; 09/2003 →; Baumuster: KG0S, KG1L		SK-1624	BTK
2.0 16V, 2.0 16V Turbo	01/03-	F4R 764, F4R 765, F4R 786, F4R 787, F4R 784, F4R 786, F4R 787, F4R 886, F4R 887	1998	27x126		SK-1624AQ1	BTKW
2.0, 2.0 16V	09/02-09/07	F4R 713, F4R 714, F4R 715, F4R 784, F4R 786, F4R 787, F4R 886, F4R 887	1998	27x126		SK-1624	BTK
2.2 dCi	10/01-10/05	G9T 600, G9T 600, G9T 706, G9T 707, G9T 702	2188	25x89; mit Zubehör		SK-1489	BTK
3.0 V6 24V	03/01-	L7X 731	2946	32x259		SK-1483	BTK
3.0 V6 24V	03/01-	L7X 731	2946	32x259		SK-1483AQ1	BTKW
1.6 16V	02/05-	K4M 716	1598			0-N1368	TB [TE]
1.6 16V, 1.6 FlexFuel	03/01-10/03	K4M 710, K4M 714, K4M 718	1598			0-N198	TB [TE]
1.6 16V, 1.6 FlexFuel	03/01-10/03	K4M 710, K4M 714, K4M 716, K4M 718	1598			0-N262	TB [DG]
1.8 16V	03/01-	F4P 770, F4P 770, F4P 771, F4P 774, F4P 775, F4P 770, F4P 773, F4P 770, F4P 774	1783			0-N1365	TB [DG]
1.8 16V	03/01-	F4P 770, F4P 770, F4P 771, F4P 774, F4P 775, F4P 770, F4P 773, F4P 770, F4P 774	1783			0-N200	TB [TE]
1.8 16V	03/01-	F4P 770, F4P 771, F4P 774, F4P 775, F4P 770, F4P 773, F4P 770, F4P 774	1783	→ 04/2001		0-N262	TB [DG]
1.9 dCi	03/01-	F9Q 670, F9Q 674, F9Q 750, F9Q 718, F9Q 754, F9Q 752	1870	mit Grundträger		0-N1173	TB [BT]
1.9 dCi	03/01-	F9Q 674	1870	mit Anbaumaterial		0-N1323	TB [TE]
1.9 dCi	03/04-	F9Q 664, F9Q 674, F9Q 758, F9Q 758, F9Q 759	1870	mit Anbaumaterial		0-N1323	TB [TE]
2.0 16V IDE	04/01-	F5R 700	1998			0-N1365	TB [DG]
2.0 16V IDE	04/01-	F5R 700	1998			0-N200	TB [TE]
2.0 16V IDE	04/01-	F5R 700, F5R 701	1998	→ 04/2001		0-N262	TB [DG]
2.0, 2.0 16V, 2.0 16V Turbo	08/02-05/05	F4R 712, F4R 713, F4R 714, F4R 715, F4R 713, F4R 764, F4R 765, F4R 786, F4R 787, F4R 784, F4R 786, F4R 787, F4R 886, F4R 887	1998			0-N1365	TB [DG]
2.0, 2.0 16V, 2.0 16V Turbo	08/02-05/05	F4R 712, F4R 713, F4R 714, F4R 715, F4R 713, F4R 764, F4R 765, F4R 786, F4R 787, F4R 784, F4R 786, F4R 787, F4R 886, F4R 887	1998			0-N200	TB [TE]



CM³



Art. Nr.



LAGUNA II Grandtour (KG0/1_)

2.2 dCi	10/01-10/05	G9T 600, G9T 600, G9T 706, G9T 707, G9T 702	2188			0-N1269	TB [TE]	
2.2 dCi	10/01-10/05	G9T 600, G9T 600, G9T 706, G9T 707, G9T 702	2188			0-N1270	TB [DG]	
3.0 V6 24V	03/01-	L7X 731	2946			0-N1056	TB [TE]	
3.0 V6 24V	03/01-	L7X 731	2946			0-N170	TB [DG]	
3.0 V6 24V	03/01-	L7X 731	2946			0-N171	TB [DG]	
1.6 16V	03/01-	K4M 710, K4M 714, K4M 716	1598			0-N1307	VB [DG]	
1.6 16V	03/01-	K4M 710, K4M 714	1598	☼		0-N1663	VB [BT]	S
1.6 16V	02/05-	K4M 716	1598			0-N1663	VB [BT]	S
1.6 16V, 1.6 FlexFuel	03/01-10/03	K4M 710, K4M 714, K4M 718	1598	☼		0-N1314	VB [TE]	
1.6 FlexFuel	06/01-10/03	K4M 714	1598	☼		0-N1663	VB [BT]	S
1.8 16V	03/01-	F4P 770, F4P 771, F4P 774, F4P 775, F4P 770, F4P 773, F4P 770, F4P 774	1783			0-N1409	VB [DG]	
1.8 16V	03/01-	F4P 770, F4P 771, F4P 774, F4P 775, F4P 770, F4P 773, F4P 770, F4P 774	1783			0-N1611	VB [BT]	S
1.9 dCi	03/01-	F9Q 750	1870		04/2001 → 03/2002	0-N1307	VB [DG]	
1.9 dCi	03/01-	F9Q 754	1870		04/2001 → 03/2002	0-N1307	VB [DG]	
1.9 dCi	03/01-	F9Q 754	1870		04/2002 →	0-N1409	VB [DG]	
1.9 dCi	03/01-	F9Q 718, F9Q 754	1870			0-N1611	VB [BT]	S
1.9 dCi	03/01-	F9Q 664, F9Q 670, F9Q 674, F9Q 750, F9Q 674, F9Q 758, F9Q 752, F9Q 758, F9Q 759	1870	☼		0-N1611	VB [BT]	S
1.9 dCi	06/01-	F9Q 752	1870		→ 03/2002	0-N1307	VB [DG]	
1.9 dCi	06/01-	F9Q 752	1870	☼		0-N1802	VB [BT]	S
1.9 dCi	03/04-	F9Q 664, F9Q 674, F9Q 758, F9Q 758, F9Q 759	1870	☼		0-N1409	VB [DG]	
2.0 16V, 2.0 16V IDE, 2.0 16V Turbo	04/01-	F4R 712, F4R 713, F4R 714, F4R 715, F4R 764, F4R 765, F4R 786, F4R 787, F4R 784, F4R 786, F4R 787, F4R 886, F4R 887, F5R 700, F5R 701	1998	☼		0-N1611	VB [BT]	S
2.0 16V, 2.0 16V Turbo	08/02-	F4R 712, F4R 713, F4R 714, F4R 715, F4R 764, F4R 765, F4R 786, F4R 787, F4R 784, F4R 786, F4R 787, F4R 886, F4R 887	1998	☼		0-N1409	VB [DG]	
2.0 16V IDE	04/01-	F5R 700, F5R 701	1998			0-N1409	VB [DG]	
2.0 dCi	08/05-	M9R 740, M9R 760	1995			0-N1739	VB [DG]	
2.0 dCi	08/05-	M9R 740, M9R 760	1995			0-N2039	VB [BT]	S
2.2 dCi	10/01-10/05	G9T 600, G9T 600, G9T 706, G9T 707, G9T 702	2188			0-N1409	VB [DG]	
2.2 dCi	10/01-	G9T 600, G9T 706, G9T 707, G9T 702	2188		Rippenanzahl: 6	0-N1648	VB [DG]	
2.2 dCi	10/01-10/05	G9T 600, G9T 600, G9T 706, G9T 707, G9T 702	2188			0-N1731	VB [BT]	S
3.0 V6 24V	03/01-	L7X 731	2946			0-N1449	VB [TE]	
3.0 V6 24V	03/01-	L7X 731	2946			0-N1473	VB [BT]	S
3.0 V6 24V	03/01-	L7X 731	2946			0-N1757	VB [VD]	
3.0 V6 24V	03/01-	L7X 731	2946		05/2004 → 09/2007	0-N1803	VB [DG]	

LAGUNA III (BT0/1)

1.5 dCi	10/07-	K9K 780	1461	27x123; mit Zubehör; Baumuster: BT00, BT0A, BT0T		SK-1487	BTK	
1.5 dCi	10/07-	K9K 780	1461	27x123; mit Zubehör		SK-1487AQ2	BTKW	
1.5 dCi	10/07-	K9K 782	1461	27x123; mit Zubehör		SK-1487AQ3	BTKW	
1.6 16V	10/07-	K4M 824	1598	27x132		SK-1630	BTK	
1.6 16V	10/07-	K4M 824	1598	27x132		SK-1630AQ1	BTKW	
2.0 16V Turbo	10/07-	F4R 811	1998	27x126		SK-1624	BTK	
2.0 16V Turbo, 2.0 GT	10/07-	F4R 800, F4R 811	1998	27x126		SK-1624AQ1	BTKW	
2.0 GT	03/08-	F4R 800	1998	27x126; Baumuster: BT0G		SK-1624	BTK	
1.5 dCi	10/07-	K9K 780	1461			0-N1111	TB [TE]	
1.6 16V	10/07-	K4M 824	1598			0-N1368	TB [TE]	
1.6 16V	10/07-	K4M 824	1598			0-N262	TB [DG]	
2.0 16V Turbo, 2.0 GT	10/07-	F4R 800, F4R 811	1998			0-N1365	TB [DG]	
2.0 16V Turbo, 2.0 GT	10/07-	F4R 800, F4R 811	1998			0-N200	TB [TE]	
1.5 dCi	10/07-	K9K 780	1461			0-N1664	VB [BT]	S
1.6 16V	10/07-	K4M 824	1598	→ 10/2009		0-N1307	VB [DG]	
1.6 16V	10/07-	K4M 824	1598	→ 10/2009		0-N1663	VB [BT]	S
1.6 16V	10/07-	K4M 824	1598	10/2009 →		0-N2265	VB [BT]	S
1.6 16V	10/07-	K4M 824	1598	10/2009 →		0-N2275	VB [DG]	
2.0 16V	10/07-	M4R 704	1998			0-N1869	VB [BT]	S
2.0 16V Hi-Flex	10/07-	M4R 726	1997			0-N1869	VB [BT]	S
2.0 16V Turbo, 2.0 GT	10/07-	F4R 800, F4R 811	1998	☼		0-N1409	VB [DG]	



CM³



Art. Nr.



ohne Halter

LAGUNA III (BT0/1)							
2.0 16V Turbo, 2.0 GT	10/07-	F4R 800, F4R 811	1998	☼		0-N1611	VB [BT] S
2.0 dCi	01/08-	M9R 800	1995			0-N1739	VB [DG]
2.0 dCi, 2.0 dCi GT	10/07-	M9R 742, M9R 744, M9R 802, M9R 802, M9R 805, M9R 814, M9R 816	1995			0-N1739	VB [DG]
2.0 dCi, 2.0 dCi GT	10/07-	M9R 742, M9R 744, M9R 802, M9R 800, M9R 809, M9R 815, M9R 802, M9R 805, M9R 814, M9R 816	1995			0-N2039	VB [BT] S
3.0 dCi	09/08-	V9X 791, V9X 891	2998			0-N1739	VB [DG]
3.5 V6	04/08-	V4Y 713	3498	09/2008 →		0-N2213	VB [BT] S

LAGUNA Coupe (DT0/1)							
1.5 dCi	03/12-	K9K 846	1461	27x123; mit Zubehör		SK-1487AQ3	BTKW
2.0 16V Turbo	09/08-	F4R 811	1998	27x126		SK-1624	BTK
2.0 16V Turbo	09/08-	F4R 811, F4Rt 811	1998	27x126		SK-1624AQ1	BTKW
2.0 GT	09/08-	F4R 800, F4Rt 800	1998	27x126		SK-1624	BTK
2.0 16V Turbo, 2.0 GT	09/08-	F4R 800, F4Rt 800, F4R 811, F4Rt 811	1998			0-N1365	TB [DG]
2.0 16V Turbo, 2.0 GT	09/08-	F4R 800, F4Rt 800, F4R 811, F4Rt 811	1998			0-N200	TB [TE]
2.0 16V Turbo, 2.0 GT	09/08-	F4R 800, F4Rt 800, F4R 811, F4Rt 811	1998	☼		0-N1409	VB [DG]
2.0 16V Turbo, 2.0 GT	09/08-	F4R 800, F4Rt 800, F4R 811, F4Rt 811	1998	☼		0-N1611	VB [BT] S
2.0 dCi	09/08-	M9R 800, M9R 809, M9R 815, M9R 802, M9R 805, M9R 814	1995			0-N1739	VB [DG]
2.0 dCi, 2.0 dCi GT	09/08-	M9R 800, M9R 809, M9R 815, M9R 802, M9R 805, M9R 814, M9R 816, M9R 820	1995			0-N2039	VB [BT] S
2.0 dCi GT	09/08-	M9R 816	1995			0-N1739	VB [DG]
3.0 dCi	09/08-	V9X 791, V9X 891, V9X 891	2998			0-N1739	VB [DG]
3.5 V6	09/08-	V4Y 713	3498			0-N2213	VB [BT] S

LAGUNA III Grandtour (KT0/1)							
1.5 dCi	10/07-	K9K 780	1461	27x123; 02/2008 →; mit Zubehör		SK-1487	BTK
1.5 dCi	10/07-	K9K 780	1461	27x123; mit Zubehör		SK-1487AQ2	BTKW
1.5 dCi	10/07-	K9K 782	1461	27x123; mit Zubehör		SK-1487AQ3	BTKW
1.6 16V	10/07-	K4M 824	1598	27x132		SK-1630	BTK
1.6 16V	10/07-	K4M 824	1598	27x132		SK-1630AQ1	BTKW
2.0 16V Turbo, 2.0 GT	10/07-	F4R 800, F4R 811	1998	27x126		SK-1624	BTK
2.0 16V Turbo, 2.0 GT	10/07-	F4R 800, F4R 811	1998	27x126		SK-1624AQ1	BTKW
1.5 dCi	10/07-	K9K 780	1461			0-N1111	TB [TE]
1.6 16V	10/07-	K4M 824	1598			0-N1368	TB [TE]
1.6 16V	10/07-	K4M 824	1598			0-N262	TB [DG]
2.0 16V Turbo, 2.0 GT	10/07-	F4R 800, F4R 811	1998			0-N1365	TB [DG]
2.0 16V Turbo, 2.0 GT	10/07-	F4R 800, F4R 811	1998			0-N200	TB [TE]
1.5 dCi	10/07-	K9K 780	1461			0-N1664	VB [BT] S
1.6 16V	10/07-	K4M 824	1598	→ 10/2009		0-N1307	VB [DG]
1.6 16V	10/07-	K4M 824	1598	→ 10/2009		0-N1663	VB [BT] S
1.6 16V	10/07-	K4M 824	1598	10/2009 →		0-N2265	VB [BT] S
1.6 16V	10/07-	K4M 824	1598	10/2009 →		0-N2275	VB [DG]
2.0 16V	10/07-	M4R 704	1998			0-N1869	VB [BT] S
2.0 16V Hi-Flex	10/07-	M4R 704, M4R 726	1997			0-N1869	VB [BT] S
2.0 16V Turbo, 2.0 GT	10/07-	F4R 800, F4R 811	1998	☼		0-N1409	VB [DG]
2.0 16V Turbo, 2.0 GT	10/07-	F4R 800, F4R 811	1998	☼		0-N1611	VB [BT] S
2.0 dCi	01/08-	M9R 800	1995			0-N1739	VB [DG]
2.0 dCi, 2.0 dCi GT	10/07-	M9R 742, M9R 744, M9R 802, M9R 802, M9R 805, M9R 814, M9R 816, M9R 820	1995			0-N1739	VB [DG]
2.0 dCi, 2.0 dCi GT	10/07-	M9R 742, M9R 744, M9R 802, M9R 800, M9R 809, M9R 815, M9R 802, M9R 805, M9R 814, M9R 816, M9R 820	1995			0-N2039	VB [BT] S
3.0 dCi	09/08-	V9X 791, V9X 891	2998			0-N1739	VB [DG]
3.5 V6	04/08-	V4Y 713	3498			0-N2213	VB [BT] S

LATITUDE (L70_)							
1.5 dCi	07/10-	K9K 782	1461	27x123; mit Zubehör		SK-1487AQ3	BTKW
2.0 16V, 2.0 16V eco2	02/11-	M4R 746	1997			0-N1869	VB [BT] S
2.0 dCi 150, 2.0 dCi 175	02/11-	M9R 804, M9R 817, M9R 844, M9R 824, M9R 846	1995			0-N1739	VB [DG]
2.0 dCi 150, 2.0 dCi 175	02/11-	M9R 804, M9R 817, M9R 844, M9R 824, M9R 846	1995			0-N2039	VB [BT] S

LOGAN I (LS_)							
1.4	09/04-	K7J 710	1390	17x96; → 11/2009		SK-1338	BTK
1.4	09/04-	K7J 710	1390	17x96; → 11/2009		SK-1338AQ2	BTKW
1.4	09/04-	K7J 710	1390	17.3x96; 11/2009 →		SK-1704AQ1	BTKW

CM³

Art. Nr.



LOGAN I (LS_)

1.5 dCi	04/07-	K9K 792	1461	27x123; mit Zubehör	SK-1487	BTK	
1.5 dCi	04/07-	K9K 792	1461	27x123; mit Zubehör	SK-1487AQ2	BTKW	
1.6	09/04-	K7M 710	1598	17x96; → 11/2009	SK-1338	BTK	
1.6	09/04-	K7M 710	1598	17.3x96; 11/2009 →	SK-1704	BTK	
1.6	09/04-	K7M 710	1598	17.3x96; 11/2009 →	SK-1704AQ1	BTKW	
1.6	04/07-	K4M 690	1598	27x132; mit Zubehör	SK-1088	BTK	
1.6	04/07-	K4M 690	1598	27x132; mit Zubehör	SK-1088AQ1	BTKW	
1.4	09/04-	K7J 710	1390	11/2009 →	0-N2062	TB [TE]	
1.5 dCi	04/07-	K9K 792, K9K 796	1461		0-N1111	TB [TE]	
1.6	09/04-	K7M 710	1598	11/2009 →	0-N2062	TB [TE]	
1.6	04/07-	K4M 690	1598		0-N198	TB [TE]	
1.6	04/07-	K4M 690	1598		0-N262	TB [DG]	
1.4	09/04-	K7J 710	1390	→ 09/2009	0-N1307	VB [DG]	
1.4	09/04-	K7J 710	1390	→ 09/2009; für Fahrzeuge mit Servolenkung,	0-N1314	VB [TE]	
1.4	09/04-	K7J 710	1390	→ 09/2009; für Fahrzeuge mit Servolenkung	0-N1663	VB [BT]	S
1.4	09/04-	K7J 710	1390	09/2009 →; für Fahrzeuge mit Servolenkung	0-N2265	VB [BT]	S
1.4	09/04-	K7J 710	1390	09/2009 →; für Fahrzeuge mit Servolenkung	0-N2275	VB [DG]	
1.5 dCi	04/07-	K9K 792	1461		0-N1474	VB [BT]	
1.5 dCi	04/07-	K9K 792	1461		0-N1664	VB [BT]	S
1.5 dCi	04/07-	K9K 792	1461	→ 12/2007; Rippenanzahl: 6;	0-N1898	VB [BT]	S
1.5 dCi	04/07-	K9K 792	1461	12/2007 →; für Fahrzeuge ohne Servolenkung	0-N2253	VB [DG]	
1.5 dCi	02/08-	K9K 796	1461	für Fahrzeuge ohne Servolenkung	0-N2253	VB [DG]	
1.6	09/04-	K7M 710	1598	→ 09/2009	0-N1307	VB [DG]	
1.6	09/04-	K7M 710	1598	→ 09/2009; für Fahrzeuge mit Servolenkung,	0-N1314	VB [TE]	
1.6	09/04-	K7M 710	1598	→ 09/2009; für Fahrzeuge mit Servolenkung	0-N1663	VB [BT]	S
1.6	09/04-	K7M 710	1598	09/2009 →; für Fahrzeuge mit Servolenkung	0-N2265	VB [BT]	S
1.6	09/04-	K7M 710	1598	09/2009 →; für Fahrzeuge mit Servolenkung	0-N2275	VB [DG]	
1.6	04/07-	K4M 690	1598	→ 10/2009	0-N1307	VB [DG]	
1.6	04/07-	K4M 690	1598	→ 10/2009; für Fahrzeuge mit Servolenkung	0-N1663	VB [BT]	S
1.6	04/07-	K4M 690	1598		0-N1664	VB [BT]	S
1.6	04/07-	K4M 690	1598	10/2009 →; für Fahrzeuge mit Servolenkung	0-N2265	VB [BT]	S
1.6	04/07-	K4M 690	1598	10/2009 →; für Fahrzeuge mit Servolenkung	0-N2275	VB [DG]	

LOGAN I Kombi (KS_)

1.4	10/07-	K7J 710	1390	17x96; → 11/2009	SK-1338	BTK	
1.4	10/07-	K7J 710	1390	17x96; → 11/2009	SK-1338AQ2	BTKW	
1.4	10/07-	K7J 710	1390	17.3x96; 11/2009 →	SK-1704AQ1	BTKW	
1.5 dCi	04/07-	K9K 792	1461	27x123; mit Zubehör	SK-1487	BTK	
1.5 dCi	04/07-	K9K 792	1461	27x123; mit Zubehör	SK-1487AQ2	BTKW	
1.6	04/07-	K4M 697	1598	27x132; mit Zubehör	SK-1088	BTK	
1.6	04/07-	K4M 697	1598	27x132; mit Zubehör	SK-1088AQ1	BTKW	
1.6	04/07-	K7M 710	1598	17x96; → 11/2009	SK-1338	BTK	
1.6	04/07-	K7M 710	1598	17.3x96; 11/2009 →	SK-1704	BTK	
1.6	04/07-	K7M 710	1598	17.3x96; 11/2009 →	SK-1704AQ1	BTKW	
1.4	10/07-	K7J 710	1390	11/2009 →	0-N2062	TB [TE]	
1.5 dCi	04/07-	K9K 792, K9K 796	1461		0-N1111	TB [TE]	
1.6	04/07-	K4M 697	1598		0-N198	TB [TE]	
1.6	04/07-	K7M 710	1598	11/2009 →	0-N2062	TB [TE]	
1.6	04/07-	K4M 697	1598		0-N262	TB [DG]	
1.4	10/07-	K7J 710	1390	→ 09/2009	0-N1307	VB [DG]	
1.4	10/07-	K7J 710	1390	→ 09/2009; für Fahrzeuge mit Servolenkung,	0-N1314	VB [TE]	
1.4	10/07-	K7J 710	1390	→ 09/2009; für Fahrzeuge mit Servolenkung	0-N1663	VB [BT]	S
1.4	10/07-	K7J 710	1390	09/2009 →; für Fahrzeuge mit Servolenkung	0-N2265	VB [BT]	S
1.4	10/07-	K7J 710	1390	09/2009 →; für Fahrzeuge mit Servolenkung	0-N2275	VB [DG]	

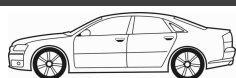

CM³



Art. Nr.



LOGAN I Kombi (KS_)							
1.5 dCi	04/07-	K9K 792	1461			0-N1664	VB [BT] S
1.5 dCi	04/07-	K9K 792	1461	→ 12/2007; Rippenanzahl: 6; ☼		0-N1898	VB [BT] S
1.5 dCi	04/07-	K9K 792	1461	12/2007 →; ☼, für Fahrzeuge ohne Servolenkung		0-N2253	VB [DG]
1.5 dCi	02/08-	K9K 796	1461	☼, für Fahrzeuge ohne Servolenkung		0-N2253	VB [DG]
1.6	04/07-	K7M 710	1598	→ 09/2009		0-N1307	VB [DG]
1.6	04/07-	K4M 697	1598	→ 10/2009		0-N1307	VB [DG]
1.6	04/07-	K7M 710	1598	→ 09/2009; für Fahrzeuge mit Servolenkung, ☼		0-N1314	VB [TE]
1.6	04/07-	K7M 710	1598	→ 09/2009; ☼, für Fahrzeuge mit Servolenkung		0-N1663	VB [BT] S
1.6	04/07-	K4M 697	1598	→ 10/2009; ☼, für Fahrzeuge mit Servolenkung		0-N1663	VB [BT] S
1.6	04/07-	K4M 697	1598	☼		0-N1664	VB [BT] S
1.6	04/07-	K7M 710	1598	09/2009 →; ☼, für Fahrzeuge mit Servolenkung		0-N2265	VB [BT] S
1.6	04/07-	K4M 697	1598	10/2009 →; ☼, für Fahrzeuge mit Servolenkung		0-N2265	VB [BT] S
1.6	04/07-	K7M 710	1598	09/2009 →; ☼, für Fahrzeuge mit Servolenkung		0-N2275	VB [DG]
1.6	04/07-	K4M 697	1598	10/2009 →; ☼, für Fahrzeuge mit Servolenkung		0-N2275	VB [DG]
LOGAN EXPRESS							
1.6	04/07-	K7M 710	1598	17.3x96; 11/2009 →		SK-1704	BTK
1.6	04/07-	K7M 710	1598	17.3x96; 11/2009 →		SK-1704AQ1	BTKW
1.5 dCi	04/07-	K9K 792	1461	12/2007 →; ☼, für Fahrzeuge ohne Servolenkung		0-N2253	VB [DG]
1.6	04/07-	K7M 710	1598	→ 09/2009; ☼, für Fahrzeuge mit Servolenkung		0-N1663	VB [BT] S
1.6	04/07-	K7M 710	1598	09/2009 →; ☼, für Fahrzeuge mit Servolenkung		0-N2265	VB [BT] S
1.6	04/07-	K7M 710	1598	09/2009 →; ☼, für Fahrzeuge mit Servolenkung		0-N2275	VB [DG]
LOGAN II							
1.6	04/14-	K7M 812	1598	17.3x96		SK-1704AQ1	BTKW
LOGAN II Kombi							
1.6	12/13-	K7M 812	1598	17.3x96		SK-1704AQ1	BTKW
MASTER I Bus (T_)							
2.0	06/85-10/89	J5R 728	1995	19x116; 10/1986 →		SK-1091	BTK
2.4 D	09/86-10/89	S8U 731	2445	30x152		SK-1035	BTK
2.4 D	09/86-10/89	S8U 731	2445	30x152		SK-1657	BTK
2.4 D	09/86-10/89	S8U 731	2445	30x152; mit Spanndämpfer, Spannrolle		SK-1680	BTK
28-35 2,5 TD	08/89-07/98	8140.27.2580, S9U 702	2499	30x153; 08/1993 →; Baumuster: T35		SK-1046	BTK
28-35 2.0	10/86-07/98	J5R 718	1995	19x116; 10/1989 →		SK-1091	BTK
28-35 2.1 D	08/80-07/98	J8S 330	2068	25x148		SK-1014	BTK
28-35 2.1 D	08/80-07/98	J8S 330	2068	25x148; → 04/1995		SK-1063	BTK
28-35 2.5 D	08/89-07/98	8140.67.2510, S8U 742	2499	30x152; 10/1990 →		SK-1035	BTK
28-35 2.5 D	08/89-07/98	8140.67.2510, S8U 742	2499	30x152; 08/1993 →		SK-1657	BTK
30 2,2	08/80-07/98	J7T 782, J7T 788	2165	19x118; Baumuster: T30		SK-1092	BTK
35 2,5 TD	08/89-07/98	8140.27.2500, 8140.27.2510, S9U 714	2499	30x153; Baumuster: T35		SK-1046	BTK
28-35 2,5 TD, 28-35 2,5 D, 35 2,5 TD	08/89-07/98	8140.27.2500, 8140.27.2510, S9U 714, 8140.27.2580, S9U 702, 8140.67.2510, S8U 742	2499			0-N1617	TB [BT]
28-35 2,5 TD, 28-35 2,5 D, 35 2,5 TD	08/89-07/98	8140.27.2500, 8140.27.2510, S9U 714, 8140.27.2580, S9U 702, 8140.67.2510, S8U 742	2499			0-N816	TB [DG]
28-35 2.0	08/80-07/98	829 731, J5R 718	1995			0-N882	TB [TE]
28-35 2.1 D	08/80-07/98	J8S 330	2068			0-N857	TB [DG]
28-35 2.1 D	08/80-07/98	J8S 330	2068	mit Anbaumaterial		0-N913	TB [TE]
28-35 2.4 D	08/80-08/89	8140.61.2300, S8U 731	2445			0-N1617	TB [BT]
28-35 2.4 D	08/80-08/89	8140.61.2300, S8U 731	2445			0-N816	TB [DG]
28-35 2.4 D	08/80-08/89	8140.61.2300, S8U 731	2445			0-N821	TB [DG]
28-35 2.5 D	08/89-07/98	8140.67.2510, S8U 742	2499			0-N821	TB [DG]
30 2,2	08/80-07/98	J7T 782, J7T 788	2165			0-N882	TB [TE]
MASTER I Kasten (T_)							
2.4 D	07/83-08/86	S8U 730	2445	30x152; mit Spanndämpfer, Spannrolle		SK-1680	BTK
2.4 D	09/86-12/92	S8U 730	2445	30x152; → 10/1989		SK-1035	BTK
2.4 D	09/86-12/92	S8U 730	2445	30x152; → 10/1989		SK-1657	BTK



CM³



Art. Nr.



ohne Halter

MASTER I Kasten (T__)

2.4 D	09/86-12/92	S8U 730	2445	30x152; → 10/1989; mit Spanndämpfer, Spannrolle	SK-1680	BTK
2.4 D, 28-35 2.4 D	08/80-08/89	8140.61.2300, S8U 731, S8U 730	2445	30x152	SK-1035	BTK
2.4 D, 28-35 2.4 D	08/80-08/89	8140.61.2300, S8U 731, S8U 730	2445	30x152	SK-1657	BTK
28-35 2,5 D	08/89-07/98	8140.67.2510, S8U 742	2499	30x152; 10/1990 →	SK-1035	BTK
28-35 2,5 D	08/89-07/98	8140.67.2510, S8U 742	2499	30x152; 11/1989 →	SK-1657	BTK
28-35 2,5 TD, 35 2,5 TD	08/89-07/98	8140.27.2500, 8140.27.2510, S9U 714, S9U 740, 8140.27.2580, S9U 702	2499	30x153; :1307401→	SK-1046	BTK
28-35 2.0	08/80-10/86	829 731	1995	19x116	SK-1091	BTK
28-35 2.0	10/86-07/98	J5R 718	1995	19x116; 10/1989 →	SK-1091	BTK
28-35 2.1 D	08/80-07/98	J8S 330	2068	25x148	SK-1014	BTK
28-35 2.1 D	08/80-07/98	J8S 330	2068	25x148; → 04/1995	SK-1063	BTK
28-35 2.4 D	08/80-08/89	8140.61.2300, S8U 731	2445	30x152; 09/1986 →; mit Spanndämpfer, Spannrolle	SK-1680	BTK
30 2,2	08/80-07/98	J7T 782, J7T 788	2165	19x118; 01/1991 →	SK-1092	BTK
35 2,5 TD	08/89-07/98	8140.27.2500, 8140.27.2510, S9U 714, S9U 740	2499	30x153	SK-1045	BTK
28-35 2,5 D	08/89-07/98	8140.67.2510, S8U 742	2499		0-N821	TB [DG]
28-35 2,5 D, 28-35 2,5 TD, 35 2,5 TD	08/89-07/98	8140.27.2500, 8140.27.2510, S9U 714, S9U 740, 8140.27.2580, S9U 702, 8140.67.2510, S8U 742	2499		0-N1617	TB [BT]
28-35 2,5 D, 28-35 2,5 TD, 35 2,5 TD	08/89-07/98	8140.27.2500, 8140.27.2510, S9U 714, S9U 740, 8140.27.2580, S9U 702, 8140.67.2510, S8U 742	2499		0-N816	TB [DG]
28-35 2.0	08/80-07/98	829 731, J5R 718	1995		0-N882	TB [TE]
28-35 2.4 D	08/80-08/89	8140.61.2300, S8U 731	2445		0-N1617	TB [BT]
28-35 2.4 D	08/80-08/89	8140.61.2300, S8U 731	2445		0-N816	TB [DG]
28-35 2.4 D	08/80-08/89	8140.61.2300, S8U 731	2445		0-N821	TB [DG]
30 2,2	08/80-07/98	J7T 782, J7T 788	2165		0-N882	TB [TE]

MASTER I Pritsche/Fahrgestell (P__)

2.0, 28-35 2.0	10/82-07/93	829 730, J5R 718	1995	19x116	SK-1091	BTK
2.1 D	11/89-07/93	J8S 330	2068	25x148	SK-1063	BTK
2.2	08/93-02/98	J7T 788	2165	19x118	SK-1092	BTK
2.4 D	08/93-02/98	S8U 730	2445	30x152	SK-1657	BTK
2.4 D	08/93-02/98	S8U 730	2445	30x152; mit Spanndämpfer, Spannrolle	SK-1680	BTK
2.5 D	07/80-10/89	S8U 742	2499	30x152	SK-1657	BTK
2.5 DT	11/89-10/93	S9U 702	2499	30x153	SK-1045	BTK
2.5 DT	11/89-02/98	S9U 702, S9U 740	2499	30x153	SK-1046	BTK
28-35 2.5 D	09/80-07/98	8140.61.2300, S8U 731	2445	30x152; → 10/1989	SK-1035	BTK
28-35 2.5 D	09/80-07/98	8140.61.2300, S8U 731	2445	30x152; → 10/1989	SK-1657	BTK
28-35 2.5 D	09/80-07/98	8140.61.2300, S8U 731	2445	30x152; → 10/1989; mit Spanndämpfer, Spannrolle	SK-1680	BTK
2.2	08/93-02/98	J7T 788	2165		0-N882	TB [TE]
2.5 DT	11/89-10/93	S9U 702	2499		0-N1617	TB [BT]
2.5 DT	11/89-02/98	S9U 702, S9U 740	2499		0-N816	TB [DG]
28-35 2.0	10/82-07/98	829 730, J5R 728	1995		0-N882	TB [TE]
28-35 2.5 D	09/80-07/98	8140.61.2300, S8U 731	2445		0-N1617	TB [BT]
28-35 2.5 D	09/80-07/98	8140.61.2300, S8U 731	2445		0-N816	TB [DG]
28-35 2.5 D	09/80-07/98	8140.61.2300, S8U 731	2445		0-N821	TB [DG]

MASTER II Bus (JD)

1.9 dCi 80	11/01-	F9Q 772, F9Q 774	1870	26x132; Baumuster: T28, T39	SK-1493	BTK
1.9 dCi 80, 1.9 dTi	09/00-	F9Q 770, F9Q 772, F9Q 774	1870	26x132	SK-1493AQ1	BTKW
1.9 dCi 80, 1.9 dTi	09/00-	F9Q 770, F9Q 772, F9Q 774	1870	26x132	SK-1493AQ2	BTKW
1.9 dTi	09/00-	F9Q 770	1870	26x153; 02/2001 → 09/2003; beinhaltet Rollen: 4; mit Zahnrad; mit Zubehör	SK-1490	BTK
1.9 dTi	09/00-	F9Q 770	1870	26x132	SK-1493	BTK
1.9 dTi	09/00-	F9Q 770	1870	26x153; beinhaltet Rollen: 2	SK-1620	BTK
2.2 dCi 90	09/00-	G9T 720, G9T 722, G9T 750	2188	25x89; mit Zubehör; Baumuster: T28, T39	SK-1489	BTK
2.5 D	07/98-01/01	S8U 770	2499	30x152	SK-1035	BTK
2.5 dCi	01/04-	G9U 750	2464	25x89; mit Zubehör; Baumuster: T39	SK-1489	BTK
2.5 dCi	08/06-	G9U 754	2464	25x89; mit Zubehör	SK-1489	BTK
2.5 dCi	08/06-	G9U 632, G9U 650	2464	25x89; mit Zubehör; Baumuster: T28, T39	SK-1489	BTK
2.5 dCi 100	10/03-	G9U 754	2463	25x89; mit Zubehör; Baumuster: T28	SK-1489	BTK
2.5 dCi 120	10/01-	G9U 720, G9U 724	2463	25x89; mit Zubehör; Baumuster: T28, T39	SK-1489	BTK
2.8 dTi	07/98-10/01	S9W 702	2799	30x154; Baumuster: T28, T39	SK-1153	BTK
2.8 dTi	07/98-10/01	S9W 702	2799	mit Spanndämpfer, Spannrolle; Baumuster: Master T28	SK-1681	BTK



CM³



Art. Nr.



MASTER II Bus (JD)							
2.8 dTI	07/98-10/01	S9W 702	2799	mit Spanndämpfer, Spannrolle; Baumuster: Master T35	SK-1681	BTK	
2.8 dTI	07/98-10/01	S9W 702	2799	mit Spanndämpfer, Spannrolle; Baumuster: Master T39	SK-1681	BTK	
1.9 dCi 80	11/01-	F9Q 772, F9Q 774	1870	mit Grundträger	0-N1173	TB [BT]	
1.9 dTI	09/00-	F9Q 770	1870		0-N1106	TB [DG]	
1.9 dTI	09/00-	F9Q 770	1870		0-N147	TB [DG]	
1.9 dTI	09/00-	F9Q 770	1870		0-N199	TB [TE]	
2.2 dCi 90	09/00-	G9T 720, G9T 722, G9T 750	2188		0-N1269	TB [TE]	
2.2 dCi 90	09/00-	G9T 720, G9T 722, G9T 750	2188		0-N1270	TB [DG]	
2.5 D	07/98-01/01	S8U 770	2499		0-N1617	TB [BT]	
2.5 D	07/98-01/01	S8U 770	2499		0-N816	TB [DG]	
2.5 D	07/98-01/01	S8U 770	2499		0-N821	TB [DG]	
2.5 dCi	01/04-	G9U 632, G9U 650, G9U 750, G9U 754	2464		0-N1269	TB [TE]	
2.5 dCi	01/04-	G9U 632, G9U 650, G9U 750, G9U 754	2464		0-N1270	TB [DG]	
2.5 dCi 100 , 2.5 dCi 120	10/01-	G9U 720, G9U 750, G9U 754, G9U 754	2463		0-N1269	TB [TE]	
2.5 dCi 100 , 2.5 dCi 120	10/01-	G9U 720, G9U 750, G9U 754, G9U 754	2463		0-N1270	TB [DG]	
2.8 dTI	07/98-10/01	S9W 702	2799		0-N1617	TB [BT]	
2.8 dTI	07/98-10/01	S9W 702	2799		0-N816	TB [DG]	
1.9 dCi 80	11/01-	F9Q 772, F9Q 774	1870		0-N1307	VB [DG]	
1.9 dCi 80	11/01-	F9Q 772, F9Q 774	1870	☼	0-N1611	VB [BT]	S
1.9 dCi 80	11/01-	F9Q 772, F9Q 774	1870	☼	0-N1802	VB [BT]	S
2.2 dCi 90	09/00-	G9T 720, G9T 722, G9T 750	2188		0-N1409	VB [DG]	
2.2 dCi 90	09/00-	G9T 720, G9T 722, G9T 750	2188	☼	0-N1731	VB [BT]	S
2.2 dCi 90	09/00-	G9T 720, G9T 722, G9T 750	2188	☼, für Fahrzeuge ohne Nebenantrieb	0-N1875	VB [BT]	S
2.5 D	07/98-01/01	S8U 770	2499	☼	0-N1591	VB [DG]	
2.5 D	07/98-01/01	S8U 770	2499	Rippenanzahl: 5	0-N1650	VB [DG]	
2.5 dCi	01/04-	G9U 632, G9U 650, G9U 750, G9U 754	2464		0-N1409	VB [DG]	
2.5 dCi	01/04-	G9U 632, G9U 650, G9U 750, G9U 754	2464	☼	0-N1731	VB [BT]	S
2.5 dCi	01/04-	G9U 632, G9U 650, G9U 750, G9U 754	2464	☼, für Fahrzeuge ohne Nebenantrieb	0-N1875	VB [BT]	S
2.5 dCi	08/06-	G9U 632, G9U 650, G9U 754	2464	für Riemenlänge [mm]=1795; ☼	0-N1731	VB [BT]	S
2.5 dCi	08/06-	G9U 632, G9U 650, G9U 754	2464	09/2010 →; für Fahrzeuge mit Nebenantrieb, ☼	0-N1739	VB [DG]	
2.5 dCi	08/06-	G9U 632, G9U 650, G9U 754	2464	09/2010 →; ☼	0-N1739	VB [DG]	
2.5 dCi 100	10/03-	G9U 754	2463	für Riemenlänge [mm]=1795; ☼	0-N1731	VB [BT]	S
2.5 dCi 100 , 2.5 dCi 120	10/01-	G9U 720, G9U 750, G9U 754, G9U 754	2463		0-N1409	VB [DG]	
2.5 dCi 100 , 2.5 dCi 120	10/01-	G9U 720, G9U 750, G9U 754, G9U 754	2463	☼	0-N1731	VB [BT]	S
2.5 dCi 100 , 2.5 dCi 120	10/01-	G9U 720, G9U 750, G9U 754, G9U 754	2463	09/2010 →; für Fahrzeuge mit Nebenantrieb, ☼	0-N1739	VB [DG]	
2.5 dCi 100 , 2.5 dCi 120	10/01-	G9U 720, G9U 750, G9U 754, G9U 754	2463	09/2010 →; ☼	0-N1739	VB [DG]	
2.5 dCi 100 , 2.5 dCi 120	10/01-	G9U 720, G9U 750, G9U 754, G9U 754	2463	☼, für Fahrzeuge ohne Nebenantrieb	0-N1875	VB [BT]	S
2.8 dTI	07/98-10/01	S9W 702	2799	☼	0-N1591	VB [DG]	
2.8 dTI	07/98-10/01	S9W 702	2799	Rippenanzahl: 5	0-N1650	VB [DG]	
MASTER II Kasten (FD)							
1.9 dCi 80	11/01-	F9Q 772, F9Q 774	1870	26x132; Baumuster: T28	SK-1493	BTK	
1.9 dCi 80, 1.9 dTI	09/00-	F9Q 770, F9Q 772, F9Q 774	1870	26x132	SK-1493AQ1	BTKW	
1.9 dCi 80, 1.9 dTI	09/00-	F9Q 770, F9Q 772, F9Q 774	1870	26x132	SK-1493AQ2	BTKW	
1.9 dTI	09/00-	F9Q 770	1870	26x153; 02/2001 → 09/2003; beinhaltetete Rollen: 4; mit Zahnrad; mit Zubehör	SK-1490	BTK	
1.9 dTI	09/00-	F9Q 770	1870	26x132	SK-1493	BTK	
1.9 dTI	09/00-	F9Q 770	1870	26x153; beinhaltetete Rollen: 2	SK-1620	BTK	
2.2 dCi 90	09/00-	G9T 720, G9T 722, G9T 750	2188	25x89; mit Zubehör; Baumuster: T28	SK-1489	BTK	
2.5 D	07/98-01/01	S8U 770	2499	30x152	SK-1035	BTK	
2.5 dCi	01/04-	G9U 632, G9U 650, G9U 750	2464	25x89; mit Zubehör; Baumuster: T28	SK-1489	BTK	
2.5 dCi	08/06-	G9U 650, G9U 754	2464	25x89; mit Zubehör	SK-1489	BTK	
2.5 dCi 100	10/03-	G9U 754	2463	25x89; mit Zubehör; Baumuster: T28	SK-1489	BTK	
2.5 dCi 120	10/01-	G9U 720, G9U 724	2463	25x89; mit Zubehör; Baumuster: T28	SK-1489	BTK	
2.8 dTI	07/98-10/01	S9W 702	2799	30x154; Baumuster: T28	SK-1153	BTK	
2.8 dTI	07/98-10/01	S9W 702	2799	mit Spanndämpfer, Spannrolle; Baumuster: Master T28	SK-1681	BTK	
2.8 dTI	07/98-10/01	S9W 702	2799	mit Spanndämpfer, Spannrolle; Baumuster: Master T33	SK-1681	BTK	
2.8 dTI	07/98-10/01	S9W 702	2799	mit Spanndämpfer, Spannrolle; Baumuster: Master T35	SK-1681	BTK	
1.9 dCi 80	11/01-	F9Q 772, F9Q 774	1870	mit Grundträger	0-N1173	TB [BT]	
1.9 dTI	09/00-	F9Q 770	1870		0-N1106	TB [DG]	
1.9 dTI	09/00-	F9Q 770	1870		0-N147	TB [DG]	



CM³



Art. Nr.



ohne Halter

MASTER II Kasten (FD)

1.9 dTi	09/00-	F9Q 770	1870			0-N199	TB [TE]	
2.2 dCi 90	09/00-	G9T 720, G9T 722, G9T 750	2188			0-N1269	TB [TE]	
2.2 dCi 90	09/00-	G9T 720, G9T 722, G9T 750	2188			0-N1270	TB [DG]	
2.5 D	07/98-01/01	S8U 770	2499			0-N1617	TB [BT]	
2.5 D	07/98-01/01	S8U 770	2499			0-N816	TB [DG]	
2.5 D	07/98-01/01	S8U 770	2499			0-N821	TB [DG]	
2.5 dCi	01/04-	G9U 632, G9U 650, G9U 650, G9U 754, G9U 750	2464			0-N1269	TB [TE]	
2.5 dCi	01/04-	G9U 632, G9U 650, G9U 650, G9U 754, G9U 750	2464			0-N1270	TB [DG]	
2.5 dCi 100 , 2.5 dCi 120	10/01-	G9U 720, G9U 724, G9U 750, G9U 754, G9U 754	2463			0-N1269	TB [TE]	
2.5 dCi 100 , 2.5 dCi 120	10/01-	G9U 720, G9U 724, G9U 750, G9U 754, G9U 754	2463			0-N1270	TB [DG]	
2.8 dTi	07/98-10/01	S9W 702	2799			0-N1617	TB [BT]	
2.8 dTi	07/98-10/01	S9W 702	2799			0-N816	TB [DG]	
1.9 dCi 80	11/01-	F9Q 772, F9Q 774	1870			0-N1307	VB [DG]	
1.9 dCi 80	11/01-	F9Q 772, F9Q 774	1870	☼		0-N1611	VB [BT]	S
1.9 dCi 80	11/01-	F9Q 772, F9Q 774	1870	☼		0-N1802	VB [BT]	S
2.2 dCi 90	09/00-	G9T 720, G9T 722, G9T 750	2188			0-N1409	VB [DG]	
2.2 dCi 90	09/00-	G9T 720, G9T 722, G9T 750	2188			0-N1731	VB [BT]	S
2.2 dCi 90	09/00-	G9T 720, G9T 722, G9T 750	2188	☼		0-N1875	VB [BT]	S
2.5 D	07/98-01/01	S8U 770	2499	☼		0-N1591	VB [DG]	
2.5 D	07/98-01/01	S8U 770	2499		Rippenanzahl: 5	0-N1650	VB [DG]	
2.5 dCi	01/04-	G9U 632, G9U 650, G9U 650, G9U 754, G9U 750	2464			0-N1409	VB [DG]	
2.5 dCi	01/04-	G9U 632, G9U 650, G9U 650, G9U 754, G9U 750	2464	☼		0-N1731	VB [BT]	S
2.5 dCi	01/04-	G9U 632, G9U 650, G9U 650, G9U 754, G9U 750	2464	☼, für Fahrzeuge ohne Nebenantrieb		0-N1875	VB [BT]	S
2.5 dCi	08/06-	G9U 632, G9U 650, G9U 650, G9U 754	2464	für Riemenlänge [mm]=1795; ☼		0-N1731	VB [BT]	S
2.5 dCi	08/06-	G9U 632, G9U 650, G9U 650, G9U 754	2464	09/2010 →, für Fahrzeuge mit Nebenantrieb, ☼		0-N1739	VB [DG]	
2.5 dCi	08/06-	G9U 632, G9U 650, G9U 650, G9U 754	2464	09/2010 →, ☼		0-N1739	VB [DG]	
2.5 dCi 100	10/03-	G9U 754	2463			0-N1409	VB [DG]	
2.5 dCi 100	10/03-	G9U 754	2463	für Riemenlänge [mm]=1795; ☼		0-N1731	VB [BT]	S
2.5 dCi 100	10/03-	G9U 754	2463	☼		0-N1731	VB [BT]	S
2.5 dCi 100 , 2.5 dCi 120	10/01-	G9U 720, G9U 724, G9U 750, G9U 754, G9U 754	2463	09/2010 →, für Fahrzeuge mit Nebenantrieb, ☼		0-N1739	VB [DG]	
2.5 dCi 100 , 2.5 dCi 120	10/01-	G9U 720, G9U 724, G9U 750, G9U 754, G9U 754	2463	09/2010 →, ☼		0-N1739	VB [DG]	
2.5 dCi 100 , 2.5 dCi 120	10/01-	G9U 720, G9U 724, G9U 750, G9U 754, G9U 754	2463	☼, für Fahrzeuge ohne Nebenantrieb		0-N1875	VB [BT]	S
2.5 dCi 120	10/01-	G9U 720, G9U 724, G9U 750, G9U 754	2463			0-N1731	VB [BT]	S
2.8 dTi	07/98-10/01	S9W 702	2799	☼		0-N1591	VB [DG]	
2.8 dTi	07/98-10/01	S9W 702	2799		Rippenanzahl: 5	0-N1650	VB [DG]	

MASTER II Pritsche/Fahrgestell (ED/HD/UD)

2.2 dCi 90	09/00-	G9T 720, G9T 722, G9T 750	2188	25x89; mit Zubehör		SK-1489	BTK	
2.5 D	07/98-01/01	S8U 770	2499	30x152		SK-1035	BTK	
2.5 dCi	01/04-	G9U 632, G9U 650, G9U 750	2464	25x89; mit Zubehör		SK-1489	BTK	
2.5 dCi	08/06-	G9U 650, G9U 754	2464	25x89; 01/2008 →; mit Zubehör; Baumuster: T28		SK-1489	BTK	
2.5 dCi 100	10/03-	G9U 754	2463	25x89; mit Zubehör		SK-1489	BTK	
2.5 dCi 120	10/01-	G9U 720, G9U 724	2463	25x89; mit Zubehör		SK-1489	BTK	
2.8 dTi	07/98-10/01	S9W 702	2799	30x154		SK-1153	BTK	
2.8 dTi	07/98-10/01	S9W 702	2799	mit Spanndämpfer, Spannrolle		SK-1681	BTK	
2.2 dCi 90	09/00-	G9T 720, G9T 722, G9T 750	2188			0-N1269	TB [TE]	
2.2 dCi 90	09/00-	G9T 720, G9T 722, G9T 750	2188			0-N1270	TB [DG]	
2.5 D	07/98-01/01	S8U 770	2499			0-N1617	TB [BT]	
2.5 D	07/98-01/01	S8U 770	2499			0-N816	TB [DG]	
2.5 D	07/98-01/01	S8U 770	2499			0-N821	TB [DG]	
2.5 dCi	01/04-	G9U 632, G9U 650, G9U 650, G9U 754, G9U 750	2464			0-N1269	TB [TE]	
2.5 dCi	01/04-	G9U 632, G9U 650, G9U 650, G9U 754, G9U 750	2464			0-N1270	TB [DG]	
2.5 dCi 100 , 2.5 dCi 120	10/01-	G9U 720, G9U 724, G9U 750, G9U 754, G9U 754	2463			0-N1269	TB [TE]	
2.5 dCi 100 , 2.5 dCi 120	10/01-	G9U 720, G9U 724, G9U 750, G9U 754, G9U 754	2463			0-N1270	TB [DG]	

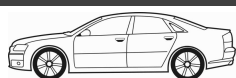

CM³



Art. Nr.



ohne Halter

MASTER II Pritsche/Fahrgestell (ED/HD/UD)							
2.8 dTI	07/98-10/01	S9W 702	2799			0-N1617	TB [BT]
2.8 dTI	07/98-10/01	S9W 702	2799			0-N816	TB [DG]
2.2 dCi 90	09/00-	G9T 720, G9T 722, G9T 750	2188			0-N1409	VB [DG]
2.2 dCi 90	09/00-	G9T 720, G9T 722, G9T 750	2188			0-N1731	VB [BT] S
2.2 dCi 90	09/00-	G9T 720, G9T 722, G9T 750	2188	☼		0-N1875	VB [BT] S
2.5 D	07/98-01/01	S8U 770	2499	☼		0-N1591	VB [DG]
2.5 D	07/98-01/01	S8U 770	2499	Rippenanzahl: 5		0-N1650	VB [DG]
2.5 dCi	01/04-	G9U 632, G9U 650, G9U 650, G9U 754, G9U 750	2464			0-N1409	VB [DG]
2.5 dCi	01/04-	G9U 632, G9U 650, G9U 650, G9U 754, G9U 750	2464	☼		0-N1731	VB [BT] S
2.5 dCi	01/04-	G9U 632, G9U 650, G9U 650, G9U 754, G9U 750	2464	☼, für Fahrzeuge ohne Nebenantrieb		0-N1875	VB [BT] S
2.5 dCi	08/06-	G9U 632, G9U 650, G9U 650, G9U 754	2464	für Riemenlänge [mm]=1795; ☼		0-N1731	VB [BT] S
2.5 dCi	08/06-	G9U 632, G9U 650, G9U 650, G9U 754	2464	09/2010 →; für Fahrzeuge mit Nebenantrieb, ☼		0-N1739	VB [DG]
2.5 dCi	08/06-	G9U 632, G9U 650, G9U 650, G9U 754	2464	09/2010 →; ☼		0-N1739	VB [DG]
2.5 dCi 100	10/03-	G9U 754	2463			0-N1409	VB [DG]
2.5 dCi 100	10/03-	G9U 754	2463	für Riemenlänge [mm]=1795; ☼		0-N1731	VB [BT] S
2.5 dCi 100	10/03-	G9U 754	2463	☼		0-N1731	VB [BT] S
2.5 dCi 100	10/03-	G9U 754	2463	09/2010 →; für Fahrzeuge mit Nebenantrieb, ☼		0-N1739	VB [DG]
2.5 dCi 100	10/03-	G9U 754	2463	09/2010 →; ☼		0-N1739	VB [DG]
2.5 dCi 100 , 2.5 dCi 120	10/01-	G9U 720, G9U 724, G9U 750, G9U 754, G9U 754	2463	☼, für Fahrzeuge ohne Nebenantrieb		0-N1875	VB [BT] S
2.5 dCi 120	10/01-	G9U 720, G9U 724, G9U 750, G9U 754	2463			0-N1731	VB [BT] S
2.8 dTI	07/98-10/01	S9W 702	2799	☼		0-N1591	VB [DG]
2.8 dTI	07/98-10/01	S9W 702	2799	Rippenanzahl: 5		0-N1650	VB [DG]
MASTER III Bus (JV)							
2.3 dCi 100 FWD , 2.3 dCi 125 FWD , 2.3 dCi FWD	02/11-	M9T 670, M9T 672, M9T 676, M9T 870, M9T 680	2299			0-N1739	VB [DG]
2.3 dCi 100 FWD , 2.3 dCi 125 FWD , 2.3 dCi FWD	02/11-	M9T 670, M9T 672, M9T 676, M9T 870, M9T 680	2299			0-N2039	VB [BT] S
MASTER III Kasten (FV)							
2.3 dCi [RWD]	02/10-	M9T 694, M9T 698, M9T 896	2299			0-N1739	VB [DG]
2.3 dCi [RWD]	02/10-	M9T 694, M9T 698, M9T 896	2299			0-N2039	VB [BT] S
2.3 dCi [RWD] , 2.3 dCi FWD	02/10-	M9T 670, M9T 672, M9T 676, M9T 698, M9T 870, M9T 890, M9T 896, M9T 670, M9T 672, M9T 676, M9T 870, M9T 890, M9T 678, M9T 680, M9T 694, M9T 696, M9T 698, M9T 896, M9T 686, M9T 690, M9T 692, M9T 696, M9T 698, M9T 870, M9T 890, M9T 896, M9T 690, M9T 692, M9T	2298			0-N1739	VB [DG]
2.3 dCi [RWD] , 2.3 dCi FWD	02/10-	M9T 670, M9T 672, M9T 676, M9T 698, M9T 870, M9T 890, M9T 896, M9T 670, M9T 672, M9T 676, M9T 870, M9T 890, M9T 678, M9T 680, M9T 694, M9T 696, M9T 698, M9T 896, M9T 686, M9T 690, M9T 692, M9T 696, M9T 698, M9T 870, M9T 890, M9T 896, M9T 690, M9T 692, M9T	2298			0-N2039	VB [BT] S
MASTER III Pritsche/Fahrgestell (EV, HV, UV)							
2.3 dCi [RWD] , 2.3 dCi FWD	02/10-	M9T 670, M9T 672, M9T 676, M9T 696, M9T 698, M9T 870, M9T 890, M9T 896, M9T 670, M9T 672, M9T 676, M9T 870, M9T 890, M9T 670, M9T 690, M9T 692, M9T 870, M9T 890, M9T 678, M9T 680, M9T 698, M9T 896, M9T 686, M9T 690, M9T 692, M9T 698, M9T 870, M9T 890, M9T	2298			0-N1739	VB [DG]
2.3 dCi [RWD] , 2.3 dCi FWD	02/10-	M9T 670, M9T 672, M9T 676, M9T 696, M9T 698, M9T 870, M9T 890, M9T 896, M9T 670, M9T 672, M9T 676, M9T 870, M9T 890, M9T 670, M9T 690, M9T 692, M9T 870, M9T 890, M9T 678, M9T 680, M9T 698, M9T 896, M9T 686, M9T 690, M9T 692, M9T 698, M9T 870, M9T 890, M9T	2298			0-N2039	VB [BT] S
MEGANE I (BA0/1_)							
1.4 16V	03/99-08/03	K4J 714, K4J 750	1390	27x132; mit Zubehör		SK-1088	BTK
1.4 16V	03/99-08/03	K4J 714, K4J 750	1390	27x132; mit Zubehör		SK-1088AQ1	BTKW
1.4 e	01/96-08/03	E7J 764	1390	17x95; → 09/2000		SK-1021	BTK

CM³

Art. Nr.



ohne Halter

MEGANE I (BA0/1_)

1.4 e	01/96-08/03	E7J 626, E7J 764	1390	17x96	SK-1338	BTK
1.4 e	01/96-08/03	E7J 626, E7J 764	1390	17x96	SK-1338AQ1	BTKW
1.4 Eco	01/96-03/99	E7J 624	1390	17x95	SK-1021	BTK
1.6 16V, 1.6 LPG	03/99-08/03	K4M 700, K4M 701, K4M 704, K4M 708, K4M 704	1598	27x132; mit Zubehör	SK-1088	BTK
1.6 16V, 1.6 LPG	03/99-08/03	K4M 700, K4M 701, K4M 704, K4M 708, K4M 704	1598	27x132; mit Zubehör	SK-1088AQ1	BTKW
1.6 e, 1.6 i	01/96-03/99	K7M 702, K7M 703, K7M 790, K7M 720	1598	17x95	SK-1021	BTK
1.6 e, 1.6 i	01/96-03/99	K7M 702, K7M 703, K7M 790, K7M 720	1598	17x95	SK-1021AQ2	BTKW
1.6 i	01/96-03/99	K7M 720	1598	17x96	SK-1338	BTK
1.6 i	01/96-03/99	K7M 720	1598	17x96	SK-1338AQ2	BTKW
1.8 16V	01/01-08/03	F4P 720, F4P 722	1783	27x128; → 04/2001	SK-1494	BTK
1.8 16V	01/01-08/03	F4P 720, F4P 722	1783	27x128	SK-1631	BTK
1.9 D Eco, 1.9 dT	01/96-08/03	F8Q 620, F8Q 624, F8Q 784, F8Q 786	1870	25.4x153; → 09/1996	SK-1012	BTK
1.9 D Eco, 1.9 dT	01/96-08/03	F8Q 620, F8Q 624, F8Q 784, F8Q 786	1870	25.4x153; 09/1996 →	SK-1107	BTK
1.9 D, 1.9 D Eco, 1.9 dT	01/96-08/03	F8Q 620, F8Q 624, F8Q 784, F8Q 784, F8Q 786	1870	25.4x153; 09/1996 →	SK-1083	BTK
1.9 D, 1.9 dTi, 1.9 TDI	04/96-08/03	F8Q 784, F9Q 730, F9Q 731, F9Q 734, F9Q 736	1870	25.4x153	SK-1107	BTK
1.9 dCi	03/99-08/03	F9Q 732, F9Q 733, F9Q 732, F9Q 738	1870	26x153; beinhaltetete Rollen: 3; mit Zahnrad	SK-1084	BTK
1.9 dCi	03/99-08/03	F9Q 732, F9Q 733, F9Q 732, F9Q 738	1870	26x153; beinhaltetete Rollen: 2	SK-1114	BTK
1.9 dTi	03/97-02/01	F9Q 736	1870	26x153; → 10/2000; beinhaltetete Rollen: 3; mit Zahnrad	SK-1084	BTK
1.9 dTi	03/97-02/01	F9Q 734	1870	26x153; beinhaltetete Rollen: 3; mit Zahnrad	SK-1084	BTK
1.9 dTi	03/97-02/01	F9Q 730	1870	26x153; beinhaltetete Rollen: 2	SK-1114	BTK
1.9 dTi	03/97-02/01	F9Q 730, F9Q 731, F9Q 734, F9Q 736	1870	26x153; 10/2000 →; beinhaltetete Rollen: 4; mit Zahnrad; mit Zubehör	SK-1490	BTK
1.9 dTi	03/97-02/01	F9Q 730, F9Q 731, F9Q 734, F9Q 736	1870	26x153; 06/1999 →; beinhaltetete Rollen: 2	SK-1620	BTK
1.9 dTi	03/97-02/01	F9Q 731	1870	26x153; beinhaltetete Rollen: 2	SK-1620	BTK
1.9 dTi	03/97-02/01	F9Q 730, F9Q 731, F9Q 734, F9Q 736	1870	26x153; 04/1997 →; beinhaltetete Rollen: 3; mit Zubehör	SK-1622	BTK
1.9 dTi	02/01-08/03	F9Q 744	1870	26x153; → 08/2002; beinhaltetete Rollen: 4; mit Zahnrad; mit Zubehör	SK-1490	BTK
1.9 dTi	02/01-08/03	F9Q 744	1870	26x153; beinhaltetete Rollen: 2	SK-1620	BTK
1.9 dTi	02/01-08/03	F9Q 744	1870	26x153; → 08/2002; beinhaltetete Rollen: 3; mit Zubehör	SK-1622	BTK
1.9 TDI	09/96-08/03	F8Q 784	1870	25.4x153	SK-1083	BTK
2.0 16V	07/96-08/03	F7R 710, F7R 714	1998	25x148	SK-1089	BTK
2.0 16V	07/96-08/03	F7R 710, F7R 714	1998	25x148	SK-1171	BTK
2.0 i	01/96-08/03	F3R 750, F3R 751	1998	19x127	SK-1036	BTK
2.0 i	03/99-08/03	F3R 750, F3R 751	1998	19x127; mit Zahnrad	SK-1099	BTK
1.4 16V	03/99-08/03	K4J 714, K4J 750	1390		0-N198	TB [TE]
1.4 16V	03/99-08/03	K4J 714, K4J 750	1390		0-N262	TB [DG]
1.4 e	01/96-08/03	E7J 626	1390		0-N145	TB [TE]
1.4 e	01/96-08/03	E7J 764	1390		0-N863	TB [TE]
1.4 Eco	01/96-03/99	E7J 624	1390		0-N863	TB [TE]
1.6 16V	03/99-08/03	K4M 700, K4M 701, K4M 704, K4M 708	1598		0-N198	TB [TE]
1.6 16V, 1.6 LPG	03/99-08/03	K4M 700, K4M 701, K4M 704, K4M 708, K4M 704	1598		0-N262	TB [DG]
1.6 e	01/96-03/99	K7M 702, K7M 703, K7M 790	1598		0-N863	TB [TE]
1.6 i	01/96-03/99	K7M 720	1598		0-N145	TB [TE]
1.8 16V	01/01-08/03	F4P 720, F4P 722	1783		0-N1259	TB [DG]
1.8 16V	01/01-08/03	F4P 720, F4P 722	1783	04/2001 →	0-N1365	TB [DG]
1.8 16V	01/01-08/03	F4P 720, F4P 722	1783		0-N200	TB [TE]
1.8 16V	01/01-08/03	F4P 720, F4P 722	1783	→ 04/2001	0-N262	TB [DG]
1.9 D Eco	01/96-08/03	F8Q 624	1870		0-N147	TB [DG]
1.9 D, 1.9 D Eco, 1.9 dCi, 1.9 dT, 1.9 TDI	01/96-08/03	F8Q 620, F8Q 624, F8Q 784, F8Q 784, F8Q 786, F9Q 732, F9Q 733, F9Q 732, F9Q 738	1870		0-N173	TB [TE]
1.9 D, 1.9 D Eco, 1.9 dT, 1.9 TDI	01/96-08/03	F8Q 620, F8Q 624, F8Q 784, F8Q 784, F8Q 786	1870		0-N854	TB [DG]
1.9 dCi	03/99-08/03	F9Q 732, F9Q 733, F9Q 732, F9Q 738	1870		0-N148	TB [DG]
1.9 dCi, 1.9 dTi	03/99-08/03	F9Q 732, F9Q 733, F9Q 732, F9Q 738, F9Q 744	1870		0-N147	TB [DG]
1.9 dT	01/96-08/03	F8Q 786	1870		0-N147	TB [DG]
1.9 dTi	03/97-02/01	F9Q 731	1870		0-N1106	TB [DG]
1.9 dTi	03/97-02/01	F9Q 736	1870	10/2000 →	0-N1106	TB [DG]
1.9 dTi	03/97-02/01	F9Q 731, F9Q 734, F9Q 736	1870		0-N147	TB [DG]
1.9 dTi	03/97-02/01	F9Q 730, F9Q 734	1870		0-N148	TB [DG]



CM³



Art. Nr.



ohne Halter

MEGANE I (BA0/1_)							
1.9 dTi	03/97-02/01	F9Q 736	1870	→ 10/2000		0-N148	TB [DG]
1.9 dTi	03/97-02/01	F9Q 730, F9Q 734	1870			0-N173	TB [TE]
1.9 dTi	03/97-02/01	F9Q 736	1870	→ 10/2000		0-N173	TB [TE]
1.9 dTi	03/97-02/01	F9Q 731	1870			0-N199	TB [TE]
1.9 dTi	03/97-02/01	F9Q 736	1870	10/2000 →		0-N199	TB [TE]
1.9 dTi	02/01-08/03	F9Q 744	1870			0-N1106	TB [DG]
1.9 dTi	02/01-08/03	F9Q 744	1870			0-N199	TB [TE]
2.0 16V	07/96-08/03	F7R 710, F7R 714	1998			0-N880	TB [TE]
2.0 16V	07/96-08/03	F7R 710, F7R 714	1998			0-N881	TB [DG]
2.0 i	01/96-08/03	F3R 750, F3R 751	1998			0-N173	TB [TE]
2.0 i	01/96-08/03	F3R 750, F3R 751	1998			0-N854	TB [DG]
2.0 i	03/99-08/03	F3R 750, F3R 751	1998	06/1999 → 04/2001		0-N262	TB [DG]
1.4 16V	03/99-08/03	K4J 714, K4J 750	1390			0-N1307	VB [DG]
1.4 16V	03/99-08/03	K4J 714, K4J 750	1390	☼		0-N1314	VB [TE]
1.4 16V	03/99-08/03	K4J 714, K4J 750	1390	☼		0-N1663	VB [BT] S
1.4 e	01/96-08/03	E7J 626	1390			0-N1307	VB [DG]
1.4 e	01/96-08/03	E7J 626	1390	☼		0-N1314	VB [TE]
1.4 e	01/96-08/03	E7J 764	1390	→ 08/1996		0-N149	VB [TE]
1.4 e	01/96-08/03	E7J 764	1390	09/1996 →		0-N150	VB [DG]
1.4 e	01/96-08/03	E7J 626	1390	☼		0-N1663	VB [BT] S
1.6 16V	03/99-08/03	K4M 700, K4M 701, K4M 704, K4M 708	1598			0-N1307	VB [DG]
1.6 16V	03/99-08/03	K4M 700, K4M 701, K4M 704, K4M 708	1598	☼		0-N1314	VB [TE]
1.6 16V , 1.6 LPG	03/99-08/03	K4M 700, K4M 701, K4M 704, K4M 708, K4M 704	1598	☼		0-N1663	VB [BT] S
1.6 e , 1.6 i	01/96-03/99	K7M 702, K7M 703, K7M 790, K7M 720	1598	→ 08/1996		0-N149	VB [TE]
1.6 e , 1.6 i	01/96-03/99	K7M 702, K7M 703, K7M 790, K7M 720	1598	09/1996 →		0-N150	VB [DG]
1.8 16V	01/01-08/03	F4P 720, F4P 722	1783			0-N1307	VB [DG]
1.8 16V	01/01-08/03	F4P 720, F4P 722	1783			0-N1663	VB [BT] S
1.9 D Eco , 1.9 dT	01/96-08/03	F8Q 620, F8Q 624, F8Q 784, F8Q 786	1870	09/1996 →		0-N1470	VB [BT] S
1.9 D Eco , 1.9 dT	01/96-08/03	F8Q 620, F8Q 624, F8Q 784, F8Q 786	1870	→ 09/1996		0-N152	VB [BT] S
1.9 D, 1.9 D Eco , 1.9 dCi , 1.9 dT , 1.9 TDI	01/96-08/03	F8Q 620, F8Q 624, F8Q 784, F8Q 784, F8Q 786, F9Q 732, F9Q 733, F9Q 732, F9Q 738	1870			0-N1729	VB [DG]
1.9 D, 1.9 TDI	04/96-08/03	F8Q 784	1870			0-N1470	VB [BT] S
1.9 dCi	03/99-08/03	F9Q 732, F9Q 733, F9Q 732, F9Q 738	1870			0-N1469	VB [BT]
1.9 dTi	03/97-02/01	F9Q 730, F9Q 731, F9Q 734, F9Q 736	1870	☼		0-N1470	VB [BT] S
1.9 dTi	03/97-08/03	F9Q 730, F9Q 731, F9Q 734, F9Q 736, F9Q 744	1870	☼		0-N1729	VB [DG]
1.9 dTi	02/01-08/03	F9Q 744	1870	☼		0-N1469	VB [BT]
2.0 16V	07/96-08/03	F7R 710, F7R 714	1998			0-N1479S	VB [TE]
2.0 16V	07/96-08/03	F7R 710, F7R 714	1998			0-N1729	VB [DG]
2.0 i	01/96-08/03	F3R 750, F3R 751	1998	mit Anbaumaterial		0-N139	VB [TE]
MEGANE I Cabriolet (EA0/1_)							
1.4 16V	03/99-08/03	K4J 714, K4J 750	1390	27x132; mit Zubehör		SK-1088	BTK
1.4 16V	03/99-08/03	K4J 714, K4J 750	1390	27x132; mit Zubehör		SK-1088AQ1	BTKW
1.6 16V	03/99-08/03	K4M 700, K4M 701, K4M 708	1598	27x132; mit Zubehör		SK-1088	BTK
1.6 16V	03/99-08/03	K4M 700, K4M 701, K4M 708	1598	27x132; mit Zubehör		SK-1088AQ1	BTKW
1.6 e	10/96-03/99	K7M 702, K7M 703	1598	17x95		SK-1021	BTK
1.6 e	10/96-03/99	K7M 702, K7M 703	1598	17x95		SK-1021AQ2	BTKW
2.0 , 2.0 i	04/97-08/03	F3R 750, F3R 798, F3R 791, F3R 796	1998	19x127		SK-1036	BTK
2.0 , 2.0 i	04/97-08/03	F3R 750, F3R 798, F3R 791, F3R 796	1998	19x127; mit Zahnrad		SK-1099	BTK
2.0 16V	10/96-11/99	F7R 710, F7R 714	1998	25x148		SK-1089	BTK
2.0 16V	10/96-11/99	F7R 710, F7R 714	1998	25x148		SK-1171	BTK
2.0 16V	01/02-08/03	F4R 746, F4R 770	1998	27x126		SK-1624	BTK
2.0 16V	01/02-08/03	F4R 746, F4R 770	1998	27x126		SK-1624AQ1	BTKW
2.0 16V	01/02-08/03	F4R 746, F4R 770	1998	27x128		SK-1625	BTK
1.4 16V	03/99-08/03	K4J 714, K4J 750	1390			0-N198	TB [TE]
1.4 16V	03/99-08/03	K4J 714, K4J 750	1390			0-N262	TB [DG]
1.6 16V	03/99-08/03	K4M 700, K4M 701, K4M 708	1598			0-N198	TB [TE]
1.6 16V	03/99-08/03	K4M 700, K4M 701, K4M 708	1598			0-N262	TB [DG]
1.6 e	10/96-03/99	K7M 702, K7M 703	1598			0-N863	TB [TE]
2.0 , 2.0 i	04/97-08/03	F3R 750, F3R 798, F3R 791, F3R 796	1998			0-N173	TB [TE]
2.0 , 2.0 i	04/97-08/03	F3R 750, F3R 798, F3R 791, F3R 796	1998			0-N854	TB [DG]
2.0 16V	10/96-11/99	F7R 710, F7R 714	1998			0-N880	TB [TE]
2.0 16V	10/96-11/99	F7R 710, F7R 714	1998			0-N881	TB [DG]
2.0 16V	01/02-08/03	F4R 746	1998			0-N1259	TB [DG]

CM³

Art. Nr.



ohne Halter

MEGANE I Cabriolet (EA0/1_)

2.0 16V	01/02-08/03	F4R 746, F4R 770	1998		0-N1365	TB [DG]	
2.0 16V	01/02-08/03	F4R 746, F4R 770	1998		0-N200	TB [TE]	
2.0 16V IDE	11/99-08/03	F4R 746, F5R 740	1998		0-N1259	TB [DG]	
2.0 i	03/99-08/03	F3R 791, F3R 796	1998		0-N146	TB [DG]	
1.4 16V	03/99-08/03	K4J 714, K4J 750	1390		0-N1307	VB [DG]	
1.4 16V	03/99-08/03	K4J 714, K4J 750	1390	☼	0-N1314	VB [TE]	
1.4 16V	03/99-08/03	K4J 714, K4J 750	1390	☼	0-N1663	VB [BT]	S
1.6 16V	03/99-08/03	K4M 700, K4M 701, K4M 708	1598		0-N1307	VB [DG]	
1.6 16V	03/99-08/03	K4M 700, K4M 701, K4M 708	1598	☼	0-N1314	VB [TE]	
1.6 16V	03/99-08/03	K4M 700, K4M 701, K4M 708	1598	☼	0-N1663	VB [BT]	S
1.6 e	10/96-03/99	K7M 702, K7M 703	1598	07/1997 →; ☼	0-N149	VB [TE]	
1.6 e	10/96-03/99	K7M 702, K7M 703	1598		0-N150	VB [DG]	
2.0, 2.0 i	04/97-08/03	F3R 750, F3R 798, F3R 791, F3R 796	1998	mit Anbaumaterial	0-N139	VB [TE]	
2.0 16V	10/96-11/99	F7R 710, F7R 714	1998		0-N1479S	VB [TE]	
2.0 16V	10/96-11/99	F7R 710, F7R 714	1998		0-N1729	VB [DG]	
2.0 16V	01/02-08/03	F4R 746	1998		0-N1307	VB [DG]	
2.0 16V	01/02-08/03	F4R 770	1998		0-N1427	VB [BT]	S
2.0 16V	01/02-08/03	F4R 746	1998	☼	0-N1663	VB [BT]	S
2.0 16V IDE	11/99-08/03	F4R 746, F5R 740	1998		0-N1307	VB [DG]	
2.0 16V IDE	11/99-08/03	F4R 746, F5R 740	1998	☼	0-N1663	VB [BT]	S

MEGANE I Classic (LA0/1_)

1.4	09/96-08/03	E7J 764	1390	17x95	SK-1021	BTK	
1.4	09/96-08/03	E7J 626, E7J 764	1390	17x96	SK-1338	BTK	
1.4	09/96-08/03	E7J 626, E7J 764	1390	17x96	SK-1338AQ1	BTKW	
1.4 16V	03/99-08/03	K4J 714, K4J 750	1390	27x132; mit Zubehör	SK-1088	BTK	
1.4 16V	03/99-08/03	K4J 714, K4J 750	1390	27x132; mit Zubehör	SK-1088AQ1	BTKW	
1.6 16V	03/99-08/03	K4M 700, K4M 701, K4M 708	1598	27x132; mit Zubehör	SK-1088	BTK	
1.6 16V	03/99-08/03	K4M 700, K4M 701, K4M 708	1598	27x132; mit Zubehör	SK-1088AQ1	BTKW	
1.6 e, 1.6 i	09/96-03/99	K7M 702, K7M 703, K7M 790, K7M 720	1598	17x95	SK-1021	BTK	
1.6 e, 1.6 i	09/96-03/99	K7M 702, K7M 703, K7M 790, K7M 720	1598	17x95	SK-1021AQ2	BTKW	
1.6 i	09/96-03/99	K7M 720	1598	17x96	SK-1338	BTK	
1.6 i	09/96-03/99	K7M 720	1598	17x96	SK-1338AQ2	BTKW	
1.8 16V	01/01-08/03	F4P 720, F4P 722	1783	27x128; → 04/2001	SK-1494	BTK	
1.8 16V	01/01-08/03	F4P 720, F4P 722	1783	27x128	SK-1631	BTK	
1.9 D	09/96-08/03	F8Q 620, F8Q 624	1870	25.4x153	SK-1083	BTK	
1.9 D, 1.9 dT, 1.9 TDI	09/96-08/03	F8Q 620, F8Q 624, F8Q 784, F8Q 784, F8Q 786	1870	25.4x153	SK-1107	BTK	
1.9 dCi, 1.9 dTi	03/99-08/03	F9Q 732, F9Q 733, F9Q 738, F9Q 733, F9Q 744	1870	26x153; beinhaltetete Rollen: 3; mit Zahnrad	SK-1084	BTK	
1.9 dCi, 1.9 dTi	03/99-08/03	F9Q 732, F9Q 733, F9Q 738, F9Q 733, F9Q 744	1870	26x153; beinhaltetete Rollen: 2	SK-1114	BTK	
1.9 dTi	03/97-02/01	F9Q 736	1870	26x153; → 10/2000; beinhaltetete Rollen: 3; mit Zahnrad	SK-1084	BTK	
1.9 dTi	03/97-02/01	F9Q 734	1870	26x153; beinhaltetete Rollen: 3; mit Zahnrad	SK-1084	BTK	
1.9 dTi	03/97-02/01	F9Q 730, F9Q 731, F9Q 734, F9Q 736	1870	25.4x153; 06/1997 →	SK-1107	BTK	
1.9 dTi	03/97-02/01	F9Q 730	1870	26x153; beinhaltetete Rollen: 2	SK-1114	BTK	
1.9 dTi	03/97-02/01	F9Q 730, F9Q 731, F9Q 734, F9Q 736	1870	26x153; 10/2000 →; beinhaltetete Rollen: 4; mit Zahnrad; mit Zubehör	SK-1490	BTK	
1.9 dTi	03/97-02/01	F9Q 731	1870	26x153; 06/1997 →; beinhaltetete Rollen: 2	SK-1620	BTK	
1.9 dTi	03/97-02/01	F9Q 730, F9Q 731, F9Q 734, F9Q 736	1870	26x153; 04/1997 →; beinhaltetete Rollen: 3; mit Zubehör	SK-1622	BTK	
1.9 dTi	02/01-08/03	F9Q 744	1870	26x153; → 08/2002; beinhaltetete Rollen: 4; mit Zahnrad; mit Zubehör	SK-1490	BTK	
1.9 dTi	02/01-08/03	F9Q 744	1870	26x153; beinhaltetete Rollen: 2	SK-1620	BTK	
1.9 dTi	02/01-08/03	F9Q 744	1870	26x153; → 08/2002; beinhaltetete Rollen: 3; mit Zubehör	SK-1622	BTK	
2.0 i	03/99-08/03	F3R 791, F3R 796, F3R 797, F3R 798	1998	19x127; mit Zahnrad	SK-1099	BTK	
2.0 i, 2.0 RT	09/96-08/03	F3R 750, F3R 751, F3R 752, F3R 791, F3R 796, F3R 797, F3R 798	1998	19x127	SK-1036	BTK	
1.4	09/96-08/03	E7J 626	1390		0-N145	TB [TE]	
1.4	09/96-08/03	E7J 764	1390		0-N863	TB [TE]	
1.4 16V	03/99-08/03	K4J 714, K4J 750	1390		0-N198	TB [TE]	
1.4 16V	03/99-08/03	K4J 714, K4J 750	1390		0-N262	TB [DG]	
1.6 16V	03/99-08/03	K4M 700, K4M 701, K4M 708	1598		0-N198	TB [TE]	
1.6 16V	03/99-08/03	K4M 700, K4M 701, K4M 708	1598		0-N262	TB [DG]	
1.6 16V, 1.6 e, 1.6 i	09/96-08/03	K4M 700, K4M 701, K4M 708, K7M 702, K7M 703, K7M 790, K7M 720	1598		0-N145	TB [TE]	
1.6 e	09/96-03/99	K7M 702, K7M 703, K7M 790	1598		0-N863	TB [TE]	

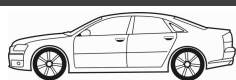

CM³



Art. Nr.



ohne Halter

MEGANE I Classic (LA0/1_)							
1.8 16V	01/01-08/03	F4P 720, F4P 722	1783			0-N1259	TB [DG]
1.8 16V	01/01-08/03	F4P 720, F4P 722	1783	04/2001 →		0-N1365	TB [DG]
1.8 16V	01/01-08/03	F4P 720, F4P 722	1783			0-N200	TB [TE]
1.8 16V	01/01-08/03	F4P 720, F4P 722	1783	→ 04/2001		0-N262	TB [DG]
1.9 D	09/96-08/03	F8Q 624	1870			0-N147	TB [DG]
1.9 D , 1.9 dCi , 1.9 dT , 1.9 TDI	09/96-08/03	F8Q 620, F8Q 624, F8Q 784, F8Q 784, F8Q 786, F9Q 732, F9Q 733, F9Q 738	1870			0-N173	TB [TE]
1.9 D , 1.9 dT , 1.9 TDI	09/96-08/03	F8Q 620, F8Q 624, F8Q 784, F8Q 784, F8Q 786	1870			0-N854	TB [DG]
1.9 dCi	02/01-08/03	F9Q 732, F9Q 733, F9Q 738	1870			0-N148	TB [DG]
1.9 dCi , 1.9 dTi	02/01-08/03	F9Q 732, F9Q 733, F9Q 738, F9Q 744	1870			0-N147	TB [DG]
1.9 dT	09/96-08/03	F8Q 786	1870			0-N147	TB [DG]
1.9 dTi	03/97-02/01	F9Q 731	1870			0-N1106	TB [DG]
1.9 dTi	03/97-02/01	F9Q 736	1870	10/2000 →		0-N1106	TB [DG]
1.9 dTi	03/97-02/01	F9Q 731, F9Q 734, F9Q 736	1870			0-N147	TB [DG]
1.9 dTi	03/97-02/01	F9Q 730, F9Q 734	1870			0-N148	TB [DG]
1.9 dTi	03/97-02/01	F9Q 736	1870	→ 10/2000		0-N148	TB [DG]
1.9 dTi	03/97-02/01	F9Q 730, F9Q 734	1870			0-N173	TB [TE]
1.9 dTi	03/97-02/01	F9Q 736	1870	→ 10/2000		0-N173	TB [TE]
1.9 dTi	03/97-02/01	F9Q 731	1870			0-N199	TB [TE]
1.9 dTi	03/97-02/01	F9Q 736	1870	10/2000 →		0-N199	TB [TE]
1.9 dTi	02/01-08/03	F9Q 744	1870			0-N1106	TB [DG]
1.9 dTi	02/01-08/03	F9Q 744	1870			0-N199	TB [TE]
2.0 i	09/96-08/03	F3R 791, F3R 796, F3R 797, F3R 798	1998			0-N146	TB [DG]
2.0 i	09/96-08/03	F3R 750, F3R 751, F3R 752, F3R 791, F3R 796, F3R 797, F3R 798	1998			0-N173	TB [TE]
2.0 i	09/96-08/03	F3R 750, F3R 751, F3R 752, F3R 791, F3R 796, F3R 797, F3R 798	1998			0-N854	TB [DG]
2.0 i	03/99-08/03	F3R 791, F3R 796, F3R 797, F3R 798	1998			0-N173	TB [TE]
2.0 i	03/99-08/03	F3R 750, F3R 751, F3R 752, F3R 791, F3R 796, F3R 797, F3R 798	1998	06/1999 → 04/2001		0-N262	TB [DG]
1.4	09/96-08/03	E7J 626	1390			0-N1307	VB [DG]
1.4	09/96-08/03	E7J 626	1390	☼		0-N1314	VB [TE]
1.4	09/96-08/03	E7J 626, E7J 764	1390	07/1997 → 12/1998; ☼		0-N149	VB [TE]
1.4	09/96-08/03	E7J 764	1390			0-N150	VB [DG]
1.4	09/96-08/03	E7J 626	1390	☼		0-N1663	VB [BT] S
1.4 16V	03/99-08/03	K4J 714, K4J 750	1390			0-N1307	VB [DG]
1.4 16V	03/99-08/03	K4J 714, K4J 750	1390	☼		0-N1314	VB [TE]
1.4 16V	03/99-08/03	K4J 714, K4J 750	1390	☼		0-N1663	VB [BT] S
1.6 16V	03/99-08/03	K4M 700, K4M 701, K4M 708	1598			0-N1307	VB [DG]
1.6 16V	03/99-08/03	K4M 700, K4M 701, K4M 708	1598	☼		0-N1314	VB [TE]
1.6 16V	03/99-08/03	K4M 700, K4M 701, K4M 708	1598	☼		0-N1663	VB [BT] S
1.6 e , 1.6 i	09/96-03/99	K7M 702, K7M 703, K7M 790, K7M 720	1598	07/1997 →; ☼		0-N149	VB [TE]
1.6 e , 1.6 i	09/96-03/99	K7M 702, K7M 703, K7M 790, K7M 720	1598			0-N150	VB [DG]
1.8 16V	01/01-08/03	F4P 720, F4P 722	1783			0-N1307	VB [DG]
1.8 16V	01/01-08/03	F4P 720, F4P 722	1783			0-N1663	VB [BT] S
1.9 D	09/96-08/03	F8Q 620, F8Q 624	1870	→ 09/1996		0-N152	VB [BT] S
1.9 D	09/96-08/03	F8Q 620, F8Q 624	1870	→ 09/1996		0-N1729	VB [DG]
1.9 D , 1.9 dT	09/96-08/03	F8Q 620, F8Q 624, F8Q 784, F8Q 786	1870			0-N1470	VB [BT] S
1.9 dCi	02/01-08/03	F9Q 732, F9Q 733, F9Q 738	1870			0-N1469	VB [BT]
1.9 dCi	02/01-08/03	F9Q 732, F9Q 733, F9Q 738	1870			0-N1729	VB [DG]
1.9 dTi	02/01-08/03	F9Q 744	1870	☼		0-N1469	VB [BT]
1.9 dTi , 1.9 TDI	09/96-08/03	F8Q 784, F9Q 730, F9Q 731, F9Q 734, F9Q 736	1870	☼		0-N1470	VB [BT] S
1.9 dTi , 1.9 TDI	09/96-08/03	F8Q 784, F9Q 730, F9Q 731, F9Q 734, F9Q 736, F9Q 744	1870	☼		0-N1729	VB [DG]
2.0 i	09/96-08/03	F3R 750, F3R 751, F3R 752, F3R 791, F3R 796, F3R 797, F3R 798	1998	mit Anbaumaterial		0-N139	VB [TE]
MEGANE I Coach (DA0/1_)							
1.4 16V	03/99-08/03	K4J 714, K4J 750	1390	27x132; mit Zubehör		SK-1088	BTK
1.4 16V	03/99-08/03	K4J 714, K4J 750	1390	27x132; mit Zubehör		SK-1088AQ1	BTKW
1.6 16V	03/99-08/03	K4M 700, K4M 701, K4M 708	1598	27x132; mit Zubehör		SK-1088	BTK
1.6 16V	03/99-08/03	K4M 700, K4M 701, K4M 708	1598	27x132; mit Zubehör		SK-1088AQ1	BTKW
1.6 e	03/96-03/99	K7M 702, K7M 703	1598	17x95		SK-1021	BTK
1.6 e	03/96-03/99	K7M 702, K7M 703	1598	17x95		SK-1021AQ2	BTKW
1.9 dCi	02/01-08/03	F9Q 732, F9Q 733	1870	26x153; beinhaltete Rollen: 3; mit Zahnrad		SK-1084	BTK
1.9 dCi	02/01-08/03	F9Q 732, F9Q 733	1870	26x153; beinhaltete Rollen: 2		SK-1114	BTK

CM³

Art. Nr.



ohne Halter

MEGANE I Coach (DA0/1_)

1.9 dTi	03/97-02/01	F9Q 736	1870	26x153; → 10/2000; beinhaltetete Rollen: 3; mit Zahnrad	SK-1084	BTK	
1.9 dTi	03/97-02/01	F9Q 734	1870	26x153; beinhaltetete Rollen: 3; mit Zahnrad	SK-1084	BTK	
1.9 dTi	03/97-02/01	F9Q 736	1870	26x153; → 10/2000; beinhaltetete Rollen: 2	SK-1114	BTK	
1.9 dTi	03/97-02/01	F9Q 734	1870	26x153; beinhaltetete Rollen: 2	SK-1114	BTK	
1.9 dTi	03/97-02/01	F9Q 731, F9Q 734, F9Q 736	1870	26x153; 02/1999 → 12/2000; beinhaltetete Rollen: 4; mit Zahnrad; mit Zubehör	SK-1490	BTK	
1.9 dTi	03/97-02/01	F9Q 731	1870	26x153; 06/1997 →; beinhaltetete Rollen: 2	SK-1620	BTK	
1.9 dTi	03/97-02/01	F9Q 731, F9Q 734, F9Q 736	1870	26x153; → 12/2000; beinhaltetete Rollen: 3; mit Zubehör	SK-1622	BTK	
2.0 16V	03/96-11/99	F7R 710, F7R 714	1998	25x148	SK-1089	BTK	
2.0 16V	03/96-11/99	F7R 710, F7R 714	1998	25x148	SK-1171	BTK	
2.0 16V	01/02-08/03	F4R 746	1998	27x128	SK-1631	BTK	
2.0 16V IDE	11/99-08/03	F5R 740	1998	27x128; → 04/2001	SK-1494	BTK	
2.0 16V IDE	11/99-08/03	F5R 740	1998	27x128; 04/2001 →	SK-1631	BTK	
2.0 i	03/96-08/03	F3R 750, F3R 751, F3R 798, F3R 791, F3R 796	1998	19x127	SK-1036	BTK	
2.0 i	03/96-08/03	F3R 750, F3R 751, F3R 798, F3R 791, F3R 796	1998	19x127; mit Zahnrad	SK-1099	BTK	
1.4 16V	03/99-08/03	K4J 714, K4J 750	1390		0-N198	TB [TE]	
1.4 16V	03/99-08/03	K4J 714, K4J 750	1390		0-N262	TB [DG]	
1.6 16V	03/99-08/03	K4M 700, K4M 701, K4M 708	1598		0-N198	TB [TE]	
1.6 16V	03/99-08/03	K4M 700, K4M 701, K4M 708	1598		0-N262	TB [DG]	
1.6 e	03/96-03/99	K7M 702, K7M 703	1598		0-N863	TB [TE]	
1.9 dCi	02/01-08/03	F9Q 732, F9Q 733	1870		0-N148	TB [DG]	
1.9 dCi	02/01-08/03	F9Q 732, F9Q 733	1870		0-N173	TB [TE]	
1.9 dCi , 1.9 dTi	03/97-08/03	F9Q 731, F9Q 734, F9Q 736, F9Q 732, F9Q 733	1870		0-N147	TB [DG]	
1.9 dTi	03/97-02/01	F9Q 731	1870		0-N1106	TB [DG]	
1.9 dTi	03/97-02/01	F9Q 736	1870	10/2000 →	0-N1106	TB [DG]	
1.9 dTi	03/97-02/01	F9Q 734	1870		0-N148	TB [DG]	
1.9 dTi	03/97-02/01	F9Q 736	1870	→ 10/2000	0-N148	TB [DG]	
1.9 dTi	03/97-02/01	F9Q 734	1870		0-N173	TB [TE]	
1.9 dTi	03/97-02/01	F9Q 736	1870	→ 10/2000	0-N173	TB [TE]	
1.9 dTi	03/97-02/01	F9Q 731	1870		0-N199	TB [TE]	
1.9 dTi	03/97-02/01	F9Q 736	1870	10/2000 →	0-N199	TB [TE]	
2.0 16V	03/96-11/99	F7R 710, F7R 714	1998		0-N880	TB [TE]	
2.0 16V	03/96-11/99	F7R 710, F7R 714	1998		0-N881	TB [DG]	
2.0 16V	01/02-08/03	F4R 746	1998		0-N1365	TB [DG]	
2.0 16V	01/02-08/03	F4R 746	1998		0-N200	TB [TE]	
2.0 16V, 2.0 16V IDE	11/99-08/03	F4R 746, F5R 740	1998		0-N1259	TB [DG]	
2.0 i	03/96-08/03	F3R 750, F3R 751, F3R 798, F3R 791, F3R 796	1998		0-N173	TB [TE]	
2.0 i	03/96-08/03	F3R 750, F3R 751, F3R 798, F3R 791, F3R 796	1998		0-N854	TB [DG]	
2.0 i	03/99-08/03	F3R 791, F3R 796	1998		0-N146	TB [DG]	
1.4 16V	03/99-08/03	K4J 714, K4J 750	1390		0-N1307	VB [DG]	
1.4 16V	03/99-08/03	K4J 714, K4J 750	1390	✘	0-N1314	VB [TE]	
1.4 16V	03/99-08/03	K4J 714, K4J 750	1390	✘	0-N1663	VB [BT]	S
1.6 16V	03/99-08/03	K4M 700, K4M 701, K4M 708	1598		0-N1307	VB [DG]	
1.6 16V	03/99-08/03	K4M 700, K4M 701, K4M 708	1598	✘	0-N1314	VB [TE]	
1.6 16V	03/99-08/03	K4M 700, K4M 701, K4M 708	1598	✘	0-N1663	VB [BT]	S
1.6 e	03/96-03/99	K7M 702, K7M 703	1598	→ 08/1996	0-N149	VB [TE]	
1.6 e	03/96-03/99	K7M 702, K7M 703	1598	09/1996 →	0-N150	VB [DG]	
1.9 dCi	02/01-08/03	F9Q 732, F9Q 733	1870		0-N1469	VB [BT]	
1.9 dCi	02/01-08/03	F9Q 732, F9Q 733	1870		0-N1729	VB [DG]	
1.9 dTi	03/97-02/01	F9Q 731, F9Q 734, F9Q 736	1870	✘	0-N1470	VB [BT]	S
1.9 dTi	03/97-02/01	F9Q 731, F9Q 734, F9Q 736	1870	✘	0-N1729	VB [DG]	
2.0 16V	03/96-11/99	F7R 710, F7R 714	1998		0-N1479S	VB [TE]	
2.0 16V	03/96-11/99	F7R 710, F7R 714	1998		0-N1729	VB [DG]	
2.0 16V, 2.0 16V IDE	11/99-08/03	F4R 746, F5R 740	1998		0-N1307	VB [DG]	
2.0 16V, 2.0 16V IDE	11/99-08/03	F4R 746, F5R 740	1998	✘	0-N1663	VB [BT]	S
2.0 i	03/96-08/03	F3R 750, F3R 751, F3R 798, F3R 791, F3R 796	1998	mit Anbaumaterial	0-N139	VB [TE]	

MEGANE I Grandtour (KA0/1_)

1.4 16V	03/99-08/03	K4J 714, K4J 750	1390	27x132; mit Zubehör	SK-1088	BTK	
1.4 16V	03/99-08/03	K4J 714, K4J 750	1390	27x132; mit Zubehör	SK-1088AQ1	BTKW	

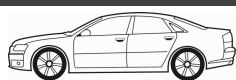

CM³



Art. Nr.



ohne Halter

MEGANE I Grandtour (KA0/1_)							
1.4 e	03/99-08/03	E7J 626	1390	17x96		SK-1338	BTK
1.4 e	03/99-08/03	E7J 626	1390	17x96		SK-1338AQ1	BTKW
1.6 16V	03/99-08/03	K4M 700, K4M 701, K4M 704, K4M 708	1598	27x132; mit Zubehör		SK-1088	BTK
1.6 16V	03/99-08/03	K4M 700, K4M 701, K4M 704, K4M 708	1598	27x132; mit Zubehör		SK-1088AQ1	BTKW
1.6 e	03/99-08/03	K7M 702, K7M 703	1598	17x95		SK-1021	BTK
1.6 e	03/99-08/03	K7M 702, K7M 703	1598	17x95		SK-1021AQ2	BTKW
1.8 16V	01/01-08/03	F4P 720, F4P 722	1783	27x128; → 04/2001		SK-1494	BTK
1.8 16V	01/01-08/03	F4P 720, F4P 722	1783	27x128		SK-1631	BTK
1.9 D	04/99-08/03	F8Q 622, F8Q 790	1870	25.4x153		SK-1083	BTK
1.9 D	04/99-08/03	F8Q 622, F8Q 790	1870	25.4x153		SK-1107	BTK
1.9 dCi, 1.9 dTi	02/01-08/03	F9Q 732, F9Q 733, F9Q 738, F9Q 744	1870	26x153; beinhaltetete Rollen: 3; mit Zahnrad		SK-1084	BTK
1.9 dCi, 1.9 dTi	02/01-08/03	F9Q 732, F9Q 733, F9Q 738, F9Q 744	1870	26x153; beinhaltetete Rollen: 2		SK-1114	BTK
1.9 dTi	03/99-02/01	F9Q 736	1870	26x153; → 10/2000; beinhaltetete Rollen: 3; mit Zahnrad		SK-1084	BTK
1.9 dTi	03/99-02/01	F9Q 736	1870	26x153; → 10/2000; beinhaltetete Rollen: 2		SK-1114	BTK
1.9 dTi	03/99-02/01	F9Q 731, F9Q 736	1870	26x153; beinhaltetete Rollen: 4; mit Zahnrad; mit Zubehör		SK-1490	BTK
1.9 dTi	03/99-02/01	F9Q 731	1870	26x153; beinhaltetete Rollen: 2		SK-1620	BTK
1.9 dTi	03/99-02/01	F9Q 731, F9Q 736	1870	26x153; beinhaltetete Rollen: 3; mit Zubehör		SK-1622	BTK
1.9 dTi	02/01-08/03	F9Q 744	1870	26x153; → 02/2003; beinhaltetete Rollen: 4; mit Zahnrad; mit Zubehör		SK-1490	BTK
1.9 dTi	02/01-08/03	F9Q 744	1870	26x153; beinhaltetete Rollen: 2		SK-1620	BTK
1.9 dTi	02/01-08/03	F9Q 744	1870	26x153; → 02/2003; beinhaltetete Rollen: 3; mit Zubehör		SK-1622	BTK
1.4 16V	03/99-08/03	K4J 714, K4J 750	1390			0-N198	TB [TE]
1.4 16V	03/99-08/03	K4J 714, K4J 750	1390			0-N262	TB [DG]
1.4 e	03/99-08/03	E7J 626	1390			0-N145	TB [TE]
1.6 16V	03/99-08/03	K4M 700, K4M 701, K4M 704, K4M 708	1598			0-N198	TB [TE]
1.6 16V	03/99-08/03	K4M 700, K4M 701, K4M 704, K4M 708	1598			0-N262	TB [DG]
1.6 e	03/99-08/03	K7M 702, K7M 703	1598			0-N863	TB [TE]
1.8 16V	01/01-08/03	F4P 720, F4P 722	1783			0-N1259	TB [DG]
1.8 16V	01/01-08/03	F4P 720, F4P 722	1783	04/2001 →		0-N1365	TB [DG]
1.8 16V	01/01-08/03	F4P 720, F4P 722	1783			0-N200	TB [TE]
1.8 16V	01/01-08/03	F4P 720, F4P 722	1783	→ 04/2001		0-N262	TB [DG]
1.9 D	04/99-08/03	F8Q 622, F8Q 790	1870			0-N854	TB [DG]
1.9 D, 1.9 dCi	04/99-08/03	F8Q 622, F8Q 790, F9Q 732, F9Q 733, F9Q 738	1870			0-N173	TB [TE]
1.9 D, 1.9 dCi, 1.9 dTi	03/99-08/03	F8Q 622, F8Q 790, F9Q 731, F9Q 736, F9Q 732, F9Q 733, F9Q 738, F9Q 744	1870			0-N147	TB [DG]
1.9 dCi	02/01-08/03	F9Q 732, F9Q 733, F9Q 738	1870			0-N148	TB [DG]
1.9 dTi	03/99-02/01	F9Q 731	1870			0-N1106	TB [DG]
1.9 dTi	03/99-02/01	F9Q 736	1870	10/2000 →		0-N1106	TB [DG]
1.9 dTi	03/99-02/01	F9Q 736	1870	→ 10/2000		0-N148	TB [DG]
1.9 dTi	03/99-02/01	F9Q 736	1870	→ 10/2000		0-N173	TB [TE]
1.9 dTi	03/99-02/01	F9Q 731	1870			0-N199	TB [TE]
1.9 dTi	03/99-02/01	F9Q 736	1870	10/2000 →		0-N199	TB [TE]
1.9 dTi	02/01-08/03	F9Q 744	1870			0-N1106	TB [DG]
1.9 dTi	02/01-08/03	F9Q 744	1870			0-N199	TB [TE]
1.4 16V, 1.4 e	03/99-08/03	E7J 626, K4J 714, K4J 750	1390			0-N1307	VB [DG]
1.4 16V, 1.4 e	03/99-08/03	E7J 626, K4J 714, K4J 750	1390	☼		0-N1314	VB [TE]
1.4 16V, 1.4 e	03/99-08/03	E7J 626, K4J 714, K4J 750	1390	☼		0-N1663	VB [BT] S
1.6 16V	03/99-08/03	K4M 700, K4M 701, K4M 704, K4M 708	1598			0-N1307	VB [DG]
1.6 16V	03/99-08/03	K4M 700, K4M 701, K4M 704, K4M 708	1598	☼		0-N1314	VB [TE]
1.6 16V	03/99-08/03	K4M 700, K4M 701, K4M 704, K4M 708	1598	☼		0-N1663	VB [BT] S
1.6 e	03/99-08/03	K7M 702, K7M 703	1598	☼		0-N149	VB [TE]
1.6 e	03/99-08/03	K7M 702, K7M 703	1598			0-N150	VB [DG]
1.8 16V	01/01-08/03	F4P 720, F4P 722	1783			0-N1307	VB [DG]
1.8 16V	01/01-08/03	F4P 720, F4P 722	1783			0-N1663	VB [BT] S
1.9 D	04/99-08/03	F8Q 622, F8Q 790	1870			0-N1470	VB [BT] S
1.9 D, 1.9 dCi	04/99-08/03	F8Q 622, F8Q 790, F9Q 732, F9Q 733, F9Q 738	1870			0-N1729	VB [DG]
1.9 dCi	02/01-08/03	F9Q 732, F9Q 733, F9Q 738	1870			0-N1469	VB [BT]
1.9 dTi	03/99-02/01	F9Q 731, F9Q 736	1870	☼		0-N1470	VB [BT] S
1.9 dTi	03/99-08/03	F9Q 731, F9Q 736, F9Q 744	1870	☼		0-N1729	VB [DG]
1.9 dTi	02/01-08/03	F9Q 744	1870	☼		0-N1469	VB [BT]
MEGANE II (BM0/1_, CM0/1_)							
1.4 16V	11/02-02/08	K4J 730, K4J 740, K4J 732	1390	27x132; mit Zubehör		SK-1088	BTK

CM³

Art. Nr.



ohne Halter

MEGANE II (BM0/1_, CM0/1_)

1.4 16V	11/02-02/08	K4J 730, K4J 740, K4J 732	1390	27x132; mit Zubehör	SK-1088AQ1	BTKW
1.5 dCi	11/02-02/08	K9K 722	1461	27x123; → 08/2003; mit Zubehör	SK-1487	BTK
1.5 dCi	11/02-02/08	K9K 722, K9K 728, K9K 729	1461	27x123; mit Zubehör	SK-1487AQ1	BTKW
1.5 dCi	11/02-02/08	K9K 722, K9K 728, K9K 729	1461	27x123; 04/2004 →; mit Zubehör	SK-1487AQ2	BTKW
1.5 dCi	10/03-03/06	K9K 728, K9K 729	1461	27x123; → 03/2006; mit Zubehör	SK-1487	BTK
1.5 dCi	05/05-02/08	K9K 724	1461	27x123; mit Zubehör; Baumuster: BM1F, CM1F	SK-1487	BTK
1.5 dCi	05/05-06/08	K9K 732, K9K 734	1461	27x123; mit Zubehör	SK-1487	BTK
1.5 dCi	05/05-06/08	K9K 724, K9K 732, K9K 734, K9K 734	1461	27x123; mit Zubehör	SK-1487AQ2	BTKW
1.5 dCi	01/07-02/08	K9K 734	1461	27x123; → 02/2008; mit Zubehör	SK-1487	BTK
1.6 16V	11/02-06/08	K4M 760, K4M 760, K4M 812, K4M 813	1598	27x132	SK-1630	BTK
1.6 16V	11/02-06/08	K4M 760, K4M 760, K4M 812, K4M 813	1598	27x132	SK-1630AQ1	BTKW
1.6, 1.6 Flex-Fuel	06/05-02/08	K4M 788	1598	27x132; mit Zubehör	SK-1088	BTK
1.6, 1.6 Flex-Fuel	06/05-02/08	K4M 788	1598	27x132; mit Zubehör	SK-1088AQ1	BTKW
1.9 dCi	11/02-02/08	F9Q 800	1870	26x133; Baumuster: BMOG, CMOG	SK-1580	BTK
1.9 dCi	11/02-02/08	F9Q 804	1870	26x133; Baumuster: BM17, BM1D, CM14, CM17	SK-1580	BTK
1.9 dCi	11/02-08/06	F9Q 808	1870	26x133; Baumuster: BM00, CM00	SK-1580	BTK
1.9 dCi	11/02-12/09	F9Q 800, F9Q 803, F9Q 804, F9Q 816, F9Q 818, F9Q 804, F9Q 816, F9Q 818, F9Q 808	1870	26x133	SK-1580AQ1	BTKW
1.9 dCi	05/05-02/08	F9Q 804	1870	26x133; Baumuster: BM14, BM1D, CM14	SK-1580	BTK
1.9 dCi	05/05-12/09	F9Q 803	1870	26x133; Baumuster: BM14, CM14	SK-1580	BTK
1.9 dCi	05/05-02/08	F9Q 804	1870	26x133	SK-1580AQ1	BTKW
2.0	08/06-02/08	F4R 774	1998	27x126; Baumuster: BM1V, CM1V, CM2H, CM2J	SK-1624	BTK
2.0 16V	11/02-02/08	F4R 770	1998	27x126; Baumuster: CM0U, MB0U	SK-1624	BTK
2.0 16V Turbo	05/04-02/08	F4R 776	1998	27x126; Baumuster: BM0W, BM1T, BM2P, BM2R	SK-1624	BTK
2.0 Renault Sport	05/04-10/09	F4R 774	1998	27x126; Baumuster: BM0M, BM11, CM0M, CM11	SK-1624	BTK
2.0 Renault Sport	05/04-10/09	F4R 774	1998	27x126	SK-1624AQ1	BTKW
2.0, 2.0 16V, 2.0 16V Turbo	11/02-02/08	F4R 770, F4R 774, F4R 776	1998	27x126	SK-1624AQ1	BTKW
1.4 16V	11/02-02/08	K4J 730, K4J 740, K4J 732	1390		0-N198	TB [TE]
1.4 16V	11/02-02/08	K4J 730, K4J 740, K4J 732	1390		0-N262	TB [DG]
1.5 dCi	11/02-06/08	K9K 722, K9K 724, K9K 728, K9K 729, K9K 732, K9K 734, K9K 734	1461		0-N1111	TB [TE]
1.6 16V	11/02-06/08	K4M 760, K4M 760, K4M 812, K4M 813	1598		0-N1368	TB [TE]
1.6 16V	01/06-06/08	K4M 812, K4M 813	1598		0-N262	TB [DG]
1.6, 1.6 16V, 1.6 Flex-Fuel	11/02-02/08	K4M 760, K4M 788	1598		0-N262	TB [DG]
1.6, 1.6 Flex-Fuel	06/05-02/08	K4M 788	1598		0-N198	TB [TE]
1.9 dCi	11/02-02/08	F9Q 800, F9Q 804, F9Q 816, F9Q 818, F9Q 808	1870	mit Anbaumaterial	0-N1323	TB [TE]
1.9 dCi	05/05-02/08	F9Q 804	1870	mit Anbaumaterial	0-N1323	TB [TE]
1.9 dCi	05/05-12/09	F9Q 803	1870	mit Anbaumaterial	0-N1323	TB [TE]
2.0, 2.0 16V, 2.0 16V Turbo, 2.0 Renault Sport	11/02-10/09	F4R 770, F4R 774, F4R 774, F4Rt 774, F4R 776	1998		0-N1365	TB [DG]
2.0, 2.0 16V, 2.0 16V Turbo, 2.0 Renault Sport	11/02-10/09	F4R 770, F4R 774, F4R 774, F4Rt 774, F4R 776	1998		0-N200	TB [TE]
1.4 16V	11/02-02/08	K4J 730, K4J 740, K4J 732	1390	☼	0-N1474	VB [BT]
1.4 16V	11/02-02/08	K4J 730, K4J 740, K4J 732	1390	→ 04/2005; ☼	0-N1476	VB [BT] S
1.4 16V	11/02-02/08	K4J 730, K4J 740, K4J 732	1390	04/2005 →; ☼	0-N1664	VB [BT] S
1.4 16V	11/02-02/08	K4J 730, K4J 740, K4J 732	1390	Rippenanzahl: 6; ☼	0-N1898	VB [BT] S
1.5 dCi	11/02-06/08	K9K 722, K9K 724, K9K 728, K9K 729, K9K 732, K9K 734	1461	→ 09/2005; ☼	0-N1474	VB [BT]
1.5 dCi	11/02-02/08	K9K 722, K9K 728, K9K 729	1461	→ 01/2005; ☼	0-N1476	VB [BT] S
1.5 dCi	11/02-02/08	K9K 722, K9K 728, K9K 729	1461	01/2005 →; ☼	0-N1664	VB [BT] S
1.5 dCi	11/02-06/08	K9K 722, K9K 724, K9K 728, K9K 729, K9K 732, K9K 734	1461	09/2005 →; ☼	0-N1664	VB [BT] S
1.5 dCi	11/02-02/08	K9K 722, K9K 724, K9K 728, K9K 729	1461	→ 12/2007; Rippenanzahl: 6; ☼	0-N1898	VB [BT] S
1.5 dCi	11/02-02/08	K9K 722, K9K 724	1461	12/2007 →; ☼	0-N2253	VB [DG]
1.5 dCi	05/05-06/08	K9K 724, K9K 732, K9K 734	1461	☼	0-N1664	VB [BT] S
1.5 dCi	05/05-06/08	K9K 732	1461	→ 12/2007; Rippenanzahl: 6; ☼	0-N1898	VB [BT] S
1.5 dCi	01/07-02/08	K9K 734	1461		0-N1664	VB [BT] S
1.5 dCi	01/07-02/08	K9K 734	1461	Rippenanzahl: 6; ☼	0-N1898	VB [BT] S
1.6 16V	11/02-02/08	K4M 760	1598	→ 05/2006; ☼	0-N1474	VB [BT]
1.6 16V	11/02-02/08	K4M 760	1598	→ 04/2005; ☼	0-N1476	VB [BT] S
1.6 16V	11/02-02/08	K4M 760	1598	04/2005 →; ☼	0-N1664	VB [BT] S
1.6 16V	11/02-02/08	K4M 760	1598	09/2005 →; ☼	0-N1664	VB [BT] S



CM³



Art. Nr.



MEGANE II (BM0/1_, CM0/1_)

1.6 16V	11/02-02/08	K4M 760	1598	Rippenanzahl: 6; ☼	0-N1898	VB [BT]	S
1.6 16V	01/06-06/08	K4M 760, K4M 812, K4M 813	1598		0-N1664	VB [BT]	S
1.6 16V	01/06-06/08	K4M 813	1598	→ 04/2009; Rippenanzahl: 6; ☼	0-N1898	VB [BT]	S
1.6 16V	01/06-06/08	K4M 812	1598	→ 12/2007; Rippenanzahl: 6; ☼	0-N1898	VB [BT]	S
1.6 16V	01/06-06/08	K4M 813	1598	04/2008 →; ☼	0-N2253	VB [DG]	
1.6 16V	01/06-06/08	K4M 812	1598	12/2007 →; ☼	0-N2253	VB [DG]	
1.6, 1.6 Flex-Fuel	06/05-02/08	K4M 788	1598	☼	0-N1664	VB [BT]	S
1.9 dCi	11/02-12/09	F9Q 800, F9Q 803, F9Q 804, F9Q 816, F9Q 818, F9Q 804, F9Q 816, F9Q 818, F9Q 804, F9Q 818, F9Q 808	1870		0-N1427	VB [BT]	S
2.0 dCi	09/05-02/08	M9R 700, M9R 722, M9R 724	1995		0-N1739	VB [DG]	
2.0 dCi	09/05-02/08	M9R 700, M9R 722, M9R 724	1995		0-N2039	VB [BT]	S
2.0, 2.0 16V, 2.0 16V Turbo, 2.0 Renault Sport	11/02-10/09	F4R 770, F4R 774, F4R 774, F4Rt 774, F4R 776	1998		0-N1427	VB [BT]	S

MEGANE II Coupé-Cabriolet (EM0/1_)

1.5 dCi	03/06-06/09	K9K 732, K9K 734	1461	27x123; mit Zubehör	SK-1487	BTK	
1.5 dCi	03/06-06/09	K9K 732, K9K 734	1461	27x123; mit Zubehör	SK-1487AQ2	BTKW	
1.5 dCi	01/07-06/09	K9K 734	1461	27x123; mit Zubehör	SK-1487AQ1	BTKW	
1.6, 1.6 16V	09/03-03/09	K4M 760, K4M 761, K4M 760, K4M 812, K4M 812, K4M 813, K4M 813	1598	27x132	SK-1630	BTK	
1.6, 1.6 16V	09/03-03/09	K4M 760, K4M 761, K4M 760, K4M 761, K4M 812, K4M 812, K4M 813, K4M 813	1598	27x132	SK-1630AQ1	BTKW	
1.9 dCi	09/03-03/09	F9Q 800, F9Q 803, F9Q 804	1870	26x133	SK-1580	BTK	
1.9 dCi	09/03-03/09	F9Q 804	1870	26x133	SK-1580	BTK	
1.9 dCi	09/03-03/09	F9Q 800, F9Q 803, F9Q 804, F9Q 804, F9Q 816, F9Q 818	1870	26x133	SK-1580AQ1	BTKW	
1.9 dCi	05/05-03/09	F9Q 804	1870	26x133	SK-1580AQ1	BTKW	
2.0, 2.0 16V Turbo	09/03-12/09	F4R 770, F4R 770, F4R 771, F4R 776	1998	27x126	SK-1624	BTK	
2.0, 2.0 16V Turbo	09/03-12/09	F4R 770, F4R 771, F4R 776	1998	27x126	SK-1624AQ1	BTKW	
1.5 dCi	03/06-06/09	K9K 732, K9K 734	1461		0-N1111	TB [TE]	
1.6	09/03-03/09	K4M 760, K4M 761, K4M 788	1598		0-N262	TB [DG]	
1.6 16V	01/06-06/08	K4M 812, K4M 813	1598		0-N262	TB [DG]	
1.6, 1.6 16V	09/03-03/09	K4M 760, K4M 761, K4M 760, K4M 761, K4M 812, K4M 812, K4M 813, K4M 813	1598		0-N1368	TB [TE]	
1.9 dCi	09/03-03/09	F9Q 800, F9Q 803, F9Q 804, F9Q 804, F9Q 816, F9Q 818	1870	mit Anbaumaterial	0-N1323	TB [TE]	
1.9 dCi	05/05-03/09	F9Q 804	1870	mit Anbaumaterial	0-N1323	TB [TE]	
2.0, 2.0 16V Turbo	09/03-12/09	F4R 770, F4R 771, F4R 776	1998		0-N1365	TB [DG]	
2.0, 2.0 16V Turbo	09/03-12/09	F4R 770, F4R 771, F4R 776	1998		0-N200	TB [TE]	
1.5 dCi	03/06-06/08	K9K 732	1461		0-N1664	VB [BT]	S
1.5 dCi	03/06-06/08	K9K 732	1461	→ 12/2007; Rippenanzahl: 6; ☼	0-N1898	VB [BT]	S
1.5 dCi	01/07-06/09	K9K 734	1461		0-N1664	VB [BT]	S
1.5 dCi	01/07-06/09	K9K 728	1461	→ 12/2007; Rippenanzahl: 6; ☼	0-N1898	VB [BT]	S
1.6	09/03-03/09	K4M 760, K4M 761	1598	→ 05/2006; ☼	0-N1474	VB [BT]	
1.6	09/03-03/09	K4M 760, K4M 761	1598	→ 04/2005; ☼	0-N1476	VB [BT]	S
1.6	09/03-03/09	K4M 760, K4M 761	1598	04/2005 →; ☼	0-N1664	VB [BT]	S
1.6	09/03-03/09	K4M 760, K4M 761	1598	09/2005 →; ☼	0-N1664	VB [BT]	S
1.6	09/03-03/09	K4M 760, K4M 761	1598	Rippenanzahl: 6; ☼	0-N1898	VB [BT]	S
1.6 16V	01/06-06/08	K4M 812	1598	☼	0-N1476	VB [BT]	S
1.6 16V	01/06-06/08	K4M 760, K4M 761, K4M 812, K4M 812, K4M 813, K4M 813	1598		0-N1664	VB [BT]	S
1.6 16V	01/06-06/08	K4M 813	1598	→ 04/2009; Rippenanzahl: 6; ☼	0-N1898	VB [BT]	S
1.6 16V	01/06-06/08	K4M 812	1598	→ 12/2007; Rippenanzahl: 6; ☼	0-N1898	VB [BT]	S
1.6 16V	01/06-06/08	K4M 813	1598	04/2008 →; ☼	0-N2253	VB [DG]	
1.6 16V	01/06-06/08	K4M 812	1598	12/2007 →; ☼	0-N2253	VB [DG]	
1.9 dCi	09/03-03/09	F9Q 800, F9Q 803, F9Q 804, F9Q 804, F9Q 816, F9Q 818	1870		0-N1427	VB [BT]	S
2.0 dCi	09/05-03/09	M9R 700, M9R 722	1995		0-N1739	VB [DG]	
2.0 dCi	09/05-03/09	M9R 700, M9R 722	1995		0-N2039	VB [BT]	S
2.0, 2.0 16V Turbo	09/03-12/09	F4R 770, F4R 770, F4R 771, F4R 776	1998		0-N1427	VB [BT]	S

MEGANE II Grandtour (KM0/1_)

1.4	08/03-07/09	K4J 730, K4J 740	1390	27x132; mit Zubehör	SK-1088	BTK	
1.4	08/03-07/09	K4J 730, K4J 740	1390	27x132; mit Zubehör	SK-1088AQ1	BTKW	
1.5 dCi	08/03-05/06	K9K 722	1461	27x123; → 05/2006; mit Zubehör	SK-1487	BTK	
1.5 dCi	08/03-05/06	K9K 722, K9K 728, K9K 729	1461	27x123; mit Zubehör	SK-1487AQ1	BTKW	
1.5 dCi	08/03-05/06	K9K 722, K9K 728, K9K 729	1461	27x123; 04/2004 →; mit Zubehör	SK-1487AQ2	BTKW	
1.5 dCi	02/04-03/06	K9K 728, K9K 729	1461	27x123; → 03/2006; mit Zubehör	SK-1487	BTK	

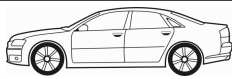
CM³

Art. Nr.



ohne Halter

MEGANE II Grandtour (KM0/1_)

1.5 dCi	05/05-06/08	K9K 734	1461	27x123; mit Zubehör; Baumuster: KM16	SK-1487	BTK	
1.5 dCi	05/05-07/09	K9K 724	1461	27x123; mit Zubehör; Baumuster: KM1F	SK-1487	BTK	
1.5 dCi	05/05-07/09	K9K 724, K9K 728, K9K 732, K9K 734	1461	27x123; mit Zubehör	SK-1487AQ2	BTKW	
1.5 dCi	01/07-07/09	K9K 728	1461	27x123; mit Zubehör	SK-1487	BTK	
1.6 16V, 1.6 16V Hi-Flex	05/05-07/09	K4M 762, K4M 762, K4M 856	1598	27x132; mit Zubehör	SK-1088	BTK	
1.6 16V, 1.6 16V Hi-Flex	05/05-07/09	K4M 762, K4M 762, K4M 856	1598	27x132; mit Zubehör	SK-1088AQ1	BTKW	
1.6, 1.6 16V	08/03-08/09	K4M 760, K4M 761, K4M 760, K4M 761, K4M 812, K4M 813, K4M 813	1598	27x132	SK-1630	BTK	
1.6, 1.6 16V	08/03-08/09	K4M 760, K4M 761, K4M 760, K4M 761, K4M 812, K4M 813, K4M 813	1598	27x132	SK-1630AQ1	BTKW	
1.9 dCi	08/03-07/09	F9Q 800, F9Q 808	1870	26x133	SK-1580	BTK	
1.9 dCi	08/03-07/09	F9Q 800, F9Q 803, F9Q 804, F9Q 804, F9Q 818, F9Q 808	1870	26x133	SK-1580AQ1	BTKW	
1.9 dCi	05/05-07/09	F9Q 804, F9Q 818	1870	26x133; 03/2007 →; Baumuster: KM14	SK-1580	BTK	
1.9 dCi	05/05-07/09	F9Q 803, F9Q 804, F9Q 818	1870	26x133; Baumuster: KM14	SK-1580	BTK	
2.0	08/03-07/09	F4R 770, F4R 771	1998	27x126	SK-1624	BTK	
2.0	08/03-07/09	F4R 770	1998	27x126	SK-1624AQ1	BTKW	
1.4	08/03-07/09	K4J 730, K4J 740	1390		0-N198	TB [TE]	
1.4	08/03-07/09	K4J 730, K4J 740	1390		0-N262	TB [DG]	
1.5 dCi	08/03-07/09	K9K 722, K9K 724, K9K 728, K9K 728, K9K 729, K9K 732, K9K 734	1461		0-N1111	TB [TE]	
1.6 16V	01/06-08/09	K4M 812, K4M 813	1598		0-N262	TB [DG]	
1.6 16V Hi-Flex	02/08-07/09	K4M 762, K4M 856	1598		0-N198	TB [TE]	
1.6, 1.6 16V	08/03-08/09	K4M 760, K4M 761, K4M 760, K4M 761, K4M 812, K4M 813, K4M 813	1598		0-N1368	TB [TE]	
1.6, 1.6 16V Hi-Flex	08/03-07/09	K4M 760, K4M 761, K4M 762, K4M 856	1598		0-N262	TB [DG]	
1.9 dCi	08/03-07/09	F9Q 800, F9Q 803, F9Q 804, F9Q 808, F9Q 818	1870	mit Anbaumaterial	0-N1323	TB [TE]	
1.9 dCi	05/05-07/09	F9Q 804	1870	mit Anbaumaterial	0-N1323	TB [TE]	
2.0	08/03-07/09	F4R 770, F4R 771	1998		0-N1365	TB [DG]	
2.0	08/03-07/09	F4R 770, F4R 771	1998		0-N200	TB [TE]	
1.4	08/03-07/09	K4J 730, K4J 740	1390	☼	0-N1474	VB [BT]	
1.4	08/03-07/09	K4J 730, K4J 740	1390	→ 04/2005; ☼	0-N1476	VB [BT]	S
1.4	08/03-07/09	K4J 730, K4J 740	1390	04/2005 →; ☼	0-N1664	VB [BT]	S
1.4	08/03-07/09	K4J 730, K4J 740	1390	Rippenanzahl: 6; ☼	0-N1898	VB [BT]	S
1.5 dCi	08/03-07/09	K9K 722, K9K 724, K9K 728, K9K 729, K9K 732, K9K 734	1461	→ 09/2005; ☼	0-N1474	VB [BT]	
1.5 dCi	08/03-05/06	K9K 722, K9K 728, K9K 729	1461	→ 01/2005; ☼	0-N1476	VB [BT]	S
1.5 dCi	08/03-05/06	K9K 722, K9K 728, K9K 729	1461	01/2005 →; ☼	0-N1664	VB [BT]	S
1.5 dCi	08/03-07/09	K9K 722, K9K 724, K9K 728, K9K 729, K9K 732, K9K 734	1461	09/2005 →; ☼	0-N1664	VB [BT]	S
1.5 dCi	08/03-07/09	K9K 722, K9K 724, K9K 728, K9K 728, K9K 729	1461	→ 12/2007; Rippenanzahl: 6; ☼	0-N1898	VB [BT]	S
1.5 dCi	05/05-07/09	K9K 724, K9K 732, K9K 734	1461	☼	0-N1664	VB [BT]	S
1.5 dCi	05/05-06/08	K9K 732	1461	→ 12/2007; Rippenanzahl: 6; ☼	0-N1898	VB [BT]	S
1.5 dCi	05/05-07/09	K9K 724, K9K 728	1461	12/2007 →; ☼	0-N2253	VB [DG]	
1.5 dCi	01/07-07/09	K9K 728	1461		0-N1664	VB [BT]	S
1.6	08/03-07/09	K4M 760, K4M 761	1598	→ 05/2006; ☼	0-N1474	VB [BT]	
1.6	08/03-07/09	K4M 760, K4M 761	1598	→ 04/2005; ☼	0-N1476	VB [BT]	S
1.6	08/03-07/09	K4M 760, K4M 761	1598	04/2005 →; ☼	0-N1664	VB [BT]	S
1.6	08/03-07/09	K4M 760, K4M 761	1598	09/2005 →; ☼	0-N1664	VB [BT]	S
1.6	08/03-07/09	K4M 760, K4M 761	1598	Rippenanzahl: 6; ☼	0-N1898	VB [BT]	S
1.6 16V	01/06-08/09	K4M 812	1598	☼	0-N1476	VB [BT]	S
1.6 16V	01/06-08/09	K4M 760, K4M 761, K4M 812, K4M 813, K4M 813	1598		0-N1664	VB [BT]	S
1.6 16V	01/06-08/09	K4M 813	1598	→ 04/2009; Rippenanzahl: 6; ☼	0-N1898	VB [BT]	S
1.6 16V	01/06-08/09	K4M 812	1598	→ 12/2007; Rippenanzahl: 6; ☼	0-N1898	VB [BT]	S
1.6 16V	01/06-08/09	K4M 813	1598	04/2009 →; ☼	0-N2253	VB [DG]	
1.6 16V	01/06-08/09	K4M 812	1598	12/2007 →; ☼	0-N2253	VB [DG]	
1.6 16V Hi-Flex	02/08-07/09	K4M 762, K4M 856	1598	☼	0-N1664	VB [BT]	S
1.9 dCi	08/03-07/09	F9Q 800, F9Q 803, F9Q 804, F9Q 804, F9Q 818, F9Q 808, F9Q 818	1870		0-N1427	VB [BT]	S
2.0	08/03-07/09	F4R 770, F4R 771	1998		0-N1427	VB [BT]	S
2.0 dCi	09/05-07/09	M9R 700, M9R 722	1995		0-N1739	VB [DG]	
2.0 dCi	09/05-07/09	M9R 700, M9R 722	1995		0-N2039	VB [BT]	S

MEGANE II Stufenheck (LM0/1_)

1.4	09/03-	K4J 730, K4J 740, K4J 732	1390	27x132; mit Zubehör	SK-1088	BTK	
1.4	09/03-	K4J 730, K4J 740, K4J 732	1390	27x132; mit Zubehör	SK-1088AQ1	BTKW	



CM³



Art. Nr.



MEGANE II Stufenheck (LM0/1_)							
1.5 dCi	09/03-	K9K 722, K9K 734	1461	27x123; → 11/2008; mit Zubehör	SK-1487	BTK	
1.5 dCi	09/03-	K9K 722, K9K 728, K9K 729	1461	27x123; mit Zubehör	SK-1487AQ1	BTKW	
1.5 dCi	09/03-	K9K 722, K9K 728, K9K 729	1461	27x123; 04/2004 →; mit Zubehör	SK-1487AQ2	BTKW	
1.5 dCi	02/04-	K9K 728, K9K 729	1461	27x123; → 08/2005; mit Zubehör	SK-1487	BTK	
1.5 dCi	05/05-	K9K 724, K9K 732	1461	27x123; mit Zubehör	SK-1487	BTK	
1.5 dCi	05/05-	K9K 724, K9K 732, K9K 734	1461	27x123; mit Zubehör	SK-1487AQ2	BTKW	
1.6	05/05-	K4M 762	1598	27x132; mit Zubehör	SK-1088	BTK	
1.6	05/05-	K4M 762	1598	27x132; mit Zubehör	SK-1088AQ1	BTKW	
1.6, 1.6 16V	09/03-	K4M 760, K4M 761, K4M 812, K4M 813, K4M 813	1598	27x132	SK-1630	BTK	
1.6, 1.6 16V	09/03-	K4M 760, K4M 761, K4M 812, K4M 813, K4M 813	1598	27x132	SK-1630AQ1	BTKW	
1.9 dCi	09/03-	F9Q 800	1870	26x133; Baumuster: LMOG	SK-1580	BTK	
1.9 dCi	09/03-12/05	F9Q 803, F9Q 804, F9Q 808	1870	26x133	SK-1580	BTK	
1.9 dCi	09/03-12/05	F9Q 800, F9Q 808	1870	26x133	SK-1580AQ1	BTKW	
1.9 dCi	05/05-	F9Q 803, F9Q 804	1870	26x133; Baumuster: LM14	SK-1580	BTK	
1.9 dCi	05/05-	F9Q 803	1870	26x133	SK-1580AQ1	BTKW	
1.9 dCi	05/05-	F9Q 804	1870	26x133	SK-1580AQ1	BTKW	
2.0	09/03-	F4R 770, F4R 771	1998	27x126	SK-1624	BTK	
2.0	09/03-	F4R 770, F4R 771	1998	27x126	SK-1624AQ1	BTKW	
1.4	09/03-	K4J 730, K4J 740, K4J 732	1390		0-N198	TB [TE]	
1.4	09/03-	K4J 730, K4J 740, K4J 732	1390		0-N262	TB [DG]	
1.5 dCi	09/03-	K9K 722, K9K 724, K9K 728, K9K 729, K9K 732, K9K 734	1461		0-N1111	TB [TE]	
1.6	09/03-	K4M 762, K4M 768	1598		0-N198	TB [TE]	
1.6 16V	01/06-	K4M 812, K4M 813	1598		0-N262	TB [DG]	
1.6, 1.6 16V, 1.6 Hi-Flex	09/03-	K4M 760, K4M 761, K4M 766, K4M 812, K4M 813, K4M 813	1598		0-N1368	TB [TE]	
1.6, 1.6 Hi-Flex	09/03-	K4M 760, K4M 761, K4M 762, K4M 766, K4M 768	1598		0-N262	TB [DG]	
1.9 dCi	09/03-12/05	F9Q 800, F9Q 803, F9Q 804, F9Q 808	1870	mit Anbaumaterial	0-N1323	TB [TE]	
1.9 dCi	05/05-	F9Q 803, F9Q 804	1870	mit Anbaumaterial	0-N1323	TB [TE]	
2.0	09/03-	F4R 770, F4R 771	1998		0-N1365	TB [DG]	
2.0	09/03-	F4R 770, F4R 771	1998		0-N200	TB [TE]	
1.4	09/03-	K4J 730, K4J 740, K4J 732	1390	☼	0-N1474	VB [BT]	
1.4	09/03-	K4J 730, K4J 740, K4J 732	1390	→ 04/2005; ☼	0-N1476	VB [BT]	S
1.4	09/03-	K4J 730, K4J 740, K4J 732	1390	04/2005 →; ☼	0-N1664	VB [BT]	S
1.4	09/03-	K4J 730, K4J 740, K4J 732	1390	Rippenanzahl: 6; ☼	0-N1898	VB [BT]	S
1.5 dCi	09/03-	K9K 722, K9K 724, K9K 728, K9K 729, K9K 732	1461	→ 09/2005; ☼	0-N1474	VB [BT]	
1.5 dCi	09/03-	K9K 722, K9K 728, K9K 729	1461	→ 01/2005; ☼	0-N1476	VB [BT]	S
1.5 dCi	09/03-	K9K 722, K9K 728, K9K 729	1461	01/2005 →; ☼	0-N1664	VB [BT]	S
1.5 dCi	09/03-	K9K 722, K9K 724, K9K 728, K9K 729	1461	09/2005 →; ☼	0-N1664	VB [BT]	S
1.5 dCi	09/03-	K9K 722, K9K 724, K9K 728, K9K 729, K9K 732	1461	→ 12/2007; Rippenanzahl: 6; ☼	0-N1898	VB [BT]	S
1.5 dCi	09/03-	K9K 722, K9K 724, K9K 728, K9K 729	1461	12/2007 →; ☼	0-N2253	VB [DG]	
1.5 dCi	05/05-	K9K 724, K9K 732	1461	☼	0-N1664	VB [BT]	S
1.5 dCi	01/07-	K9K 734	1461		0-N1664	VB [BT]	S
1.5 dCi	01/07-	K9K 728	1461	→ 12/2007; Rippenanzahl: 6; ☼	0-N1898	VB [BT]	S
1.6	09/03-	K4M 760, K4M 761	1598	→ 05/2006; ☼	0-N1474	VB [BT]	
1.6	09/03-	K4M 760, K4M 761	1598	→ 04/2005; ☼	0-N1476	VB [BT]	S
1.6	09/03-	K4M 760, K4M 761	1598	04/2005 →; ☼	0-N1664	VB [BT]	S
1.6	09/03-	K4M 762, K4M 768	1598	☼	0-N1664	VB [BT]	S
1.6	09/03-	K4M 760, K4M 761	1598	Rippenanzahl: 6; ☼	0-N1898	VB [BT]	S
1.6 16V	01/06-	K4M 812	1598	☼	0-N1476	VB [BT]	S
1.6 16V	01/06-	K4M 812, K4M 813, K4M 813	1598		0-N1664	VB [BT]	S
1.6 16V	01/06-	K4M 813	1598	→ 04/2009; Rippenanzahl: 6; ☼	0-N1898	VB [BT]	S
1.6 16V	01/06-	K4M 812	1598	→ 12/2007; Rippenanzahl: 6; ☼	0-N1898	VB [BT]	S
1.6 16V	01/06-	K4M 813	1598	04/2009 →; ☼	0-N2253	VB [DG]	
1.6 16V	01/06-	K4M 812	1598	12/2007 →; ☼	0-N2253	VB [DG]	
1.9 dCi	09/03-12/05	F9Q 800, F9Q 803, F9Q 804, F9Q 803, F9Q 804, F9Q 816, F9Q 818, F9Q 808	1870		0-N1427	VB [BT]	S
2.0	09/03-	F4R 770, F4R 771	1998		0-N1427	VB [BT]	S
2.0 dCi	09/05-	M9R 700, M9R 722	1995		0-N1739	VB [DG]	
2.0 dCi	09/05-	M9R 700, M9R 722	1995		0-N2039	VB [BT]	S

CM³

Art. Nr.



ohne Halter

MEGANE III Coupe (DZ0/1_)

1.5 dCi	11/08-	K9K 636, K9K 837, K9K 846, K9K J 836, K9K 830, K9K 832, K9K G 832, K9K H 834	1461	27x123; mit Zubehör	SK-1487	BTK	
1.5 dCi	11/08-	K9K 830, K9K 832, K9K G 832	1461	27x123; mit Zubehör	SK-1487AQ2	BTKW	
1.5 dCi	11/08-	K9K 636, K9K 837, K9K 846, K9K J 836, K9K H 834	1461	27x123; mit Zubehör	SK-1487AQ3	BTKW	
1.5 dCi	02/09-	K9K 636, K9K 837, K9K 846, K9K J 836	1461	27x119	SK-1730	BTK	
1.5 dCi	02/09-	K9K 636, K9K 837, K9K 846, K9K J 836	1461	27x119	SK-1730AQ1	BTKW	
1.6 16V	11/08-	K4M 848	1598	27x132; mit Zubehör	SK-1088	BTK	
1.6 16V	11/08-	K4M 848	1598	27x132; mit Zubehör	SK-1088AQ1	BTKW	
1.6 16V , 1.6 16V Bifuel	11/08-	K4M 858, K4M 866	1598	27x132	SK-1630	BTK	
1.6 16V , 1.6 16V Bifuel	11/08-	K4M 858, K4M 866	1598	27x132	SK-1630AQ1	BTKW	
1.9 dCi	11/08-	F9Q 870, F9Q 872	1870	26x133	SK-1698	BTK	
1.9 dCi	11/08-	F9Q 870, F9Q 872	1870	26x133	SK-1698AQ1	BTKW	
2.0 R.S.	11/08-	F4R 874	1998	27x126; 10/2011 →	SK-1624	BTK	
2.0 TCe	11/08-	F4R 870	1998	27x126	SK-1624	BTK	
2.0 TCe	05/09-	F4R 874	1998	27x126; 11/2009 →	SK-1624	BTK	
1.5 dCi	11/08-	K9K 636, K9K 837, K9K 846, K9K J 836, K9K 830, K9K 832, K9K G 832, K9K H 834	1461		0-N1111	TB [TE]	
1.6 16V	11/08-	K4M 848	1598		0-N198	TB [TE]	
1.6 16V , 1.6 16V Bifuel	11/08-	K4M 858, K4M 866	1598		0-N1368	TB [TE]	
1.6 16V , 1.6 16V Bifuel	11/08-	K4M 848, K4M 858, K4M 866	1598		0-N262	TB [DG]	
1.9 dCi	11/08-	F9Q 870, F9Q 872	1870		0-N2060	TB [TE]	
2.0 TCe	11/08-	F4R 870, F4R 874	1998		0-N1365	TB [DG]	
2.0 TCe	11/08-	F4R 870, F4R 874	1998		0-N200	TB [TE]	
1.2 TCe	03/12-	H5F 400	1198		0-N2308	VB [BT]	S
1.2 TCe	03/12-	H5F 400	1198		0-N2344	VB [DG]	
1.2 TCe	01/13-	H5F 404	1197		0-N2308	VB [BT]	S
1.2 TCe	01/13-	H5F 404	1197		0-N2344	VB [DG]	
1.4 TCe	04/09-	H4J 700	1397		0-N2279	VB [BT]	S
1.4 TCe	04/09-	H4J 700	1397		0-N2344	VB [DG]	
1.5 dCi	11/08-	K9K 636, K9K 837, K9K 846, K9K J 836, K9K 830, K9K 832, K9K G 832, K9K H 834	1461		0-N1664	VB [BT]	S
1.6 16V	11/08-	K4M 848	1598	*	0-N1664	VB [BT]	S
1.6 16V , 1.6 16V Bifuel	11/08-	K4M 858, K4M 866	1598		0-N1664	VB [BT]	S
1.6 dCi	04/11-	R9M 402	1598		0-N1739	VB [DG]	
1.6 dCi	04/11-	R9M 402	1598		0-N2280	VB [BT]	S
1.9 dCi	11/08-	F9Q 870, F9Q 872	1870		0-N1427	VB [BT]	S
2.0 CVT	05/09-	M4R 711	1997		0-N1869	VB [BT]	S
2.0 dCi	04/09-	M9R 610, M9R 615	1995		0-N1739	VB [DG]	
2.0 dCi	04/09-	M9R 610, M9R 615	1995		0-N2039	VB [BT]	S
2.0 R.S., 2.0 TCe	11/08-	F4R 870, F4R 874	1998		0-N1427	VB [BT]	S

MEGANE III Grandtour (KZ0/1)

1.5 dCi	02/09-	K9K 836, K9K 846	1461	27x123; 08/2009 →; mit Zubehör	SK-1487	BTK	
1.5 dCi	02/09-	K9K 836, K9K 837	1461	27x123; mit Zubehör, Baumuster: KZ09, KZ0D, KZ1G	SK-1487	BTK	
1.5 dCi	02/09-	K9K 836, K9K 846	1461	27x123; 08/2009 →; mit Zubehör	SK-1487AQ2	BTKW	
1.5 dCi	02/09-	K9K 636, K9K 836, K9K 837, K9K 846, K9K 834, K9K 846	1461	27x123; mit Zubehör	SK-1487AQ3	BTKW	
1.5 dCi	02/09-	K9K636	1461	27x119	SK-1730	BTK	
1.5 dCi	02/09-	K9K636	1461	27x119	SK-1730AQ1	BTKW	
1.5 dCi	05/09-	K9K 834	1461	27x123; mit Zubehör	SK-1487	BTK	
1.6 16V	05/09-	K4M 848	1598	27x132; mit Zubehör	SK-1088	BTK	
1.6 16V	05/09-	K4M 848	1598	27x132; mit Zubehör	SK-1088AQ1	BTKW	
1.6 16V , 1.6 16V Bifuel	11/08-	K4M 858, K4M 866	1598	27x132	SK-1630	BTK	
1.6 16V , 1.6 16V Bifuel	11/08-	K4M 858, K4M 866	1598	27x132	SK-1630AQ1	BTKW	
1.9 dCi	05/09-	F9Q 870, F9Q 872	1870	26x133; 08/2009 →	SK-1698	BTK	
1.9 dCi	05/09-	F9Q 870, F9Q 872	1870	26x133	SK-1698AQ1	BTKW	
2.0 TCe	11/08-	F4R 870, F4R 872	1998	27x126; 08/2009 →	SK-1624	BTK	
1.5 dCi	02/09-	K9K 636, K9K 836, K9K 837, K9K 846, K9K 834, K9K 836, K9K 846	1461		0-N1111	TB [TE]	
1.5 dCi	02/09-	K9K 636	1461		0-N2423	TB [TE]	
1.5 dCi	11/13-	K9K 846	1461		0-N2423	TB [TE]	
1.6 16V	05/09-	K4M 848	1598		0-N198	TB [TE]	
1.6 16V	05/09-	K4M 848	1598		0-N262	TB [DG]	
1.6 16V , 1.6 16V Bifuel	11/08-	K4M 858, K4M 866	1598		0-N1368	TB [TE]	
1.6 16V , 1.6 16V Bifuel	11/08-	K4M 858, K4M 866	1598		0-N262	TB [DG]	
1.9 dCi	05/09-	F9Q 870, F9Q 872	1870		0-N2060	TB [TE]	



CM³



Art. Nr.



ohne Halter

MEGANE III Grandtour (KZ0/1)

2.0 TCe	11/08-	F4R 870, F4R 872	1998		0-N1365	TB [DG]	
2.0 TCe	11/08-	F4R 870, F4R 872	1998		0-N200	TB [TE]	
1.2 TCe	03/12-	H5F 400	1198		0-N2308	VB [BT]	S
1.2 TCe	03/12-	H5F 400	1198		0-N2344	VB [DG]	
1.2 TCe	01/13-	H5F 404	1197		0-N2308	VB [BT]	S
1.2 TCe	01/13-	H5F 404	1197		0-N2344	VB [DG]	
1.4 TCe	05/09-	H4J 700	1397		0-N2279	VB [BT]	S
1.4 TCe	05/09-	H4J 700	1397		0-N2344	VB [DG]	
1.5 dCi	02/09-	K9K 636, K9K 836, K9K 837, K9K 846, K9K 834	1461		0-N1664	VB [BT]	S
1.5 dCi	02/09-	K9K 836	1461		0-N1664	VB [BT]	S
1.6 16V	05/09-	K4M 848	1598	✳	0-N1664	VB [BT]	S
1.6 16V , 1.6 16V Bifuel	11/08-	K4M 858, K4M 866	1598		0-N1664	VB [BT]	S
1.6 dCi	04/11-	R9M 402, R9M 404	1598		0-N1739	VB [DG]	
1.6 dCi	04/11-	R9M 402, R9M 404	1598		0-N2280	VB [BT]	S
1.9 dCi	05/09-	F9Q 870, F9Q 872	1870		0-N1427	VB [BT]	S
2.0 CVT	05/09-	M4R 711, M4R F 713	1997		0-N1869	VB [BT]	S
2.0 dCi	04/09-	M9R 610, M9R 615	1995		0-N1739	VB [DG]	
2.0 dCi	04/09-	M9R 610, M9R 615	1995		0-N2039	VB [BT]	S
2.0 TCe	11/08-	F4R 870, F4R 872	1998		0-N1427	VB [BT]	S

MEGANE III Schrägheck (BZ0_)

1.5 dCi	11/08-	K9K 636, K9K 656, K9K 657, K9K 836, K9K 837, K9K 846, K9K H 834	1461	27x123; mit Zubehör	SK-1487	BTK	
1.5 dCi	11/08-	K9K 846, K9K H 834	1461	27x123; mit Zubehör	SK-1487AQ3	BTKW	
1.5 dCi	02/09-	K9K G 832	1461	27x123; 06/2009 ->; mit Zubehör; Baumuster: BZ0B	SK-1487	BTK	
1.5 dCi	02/09-	K9K G 832	1461	27x123; 06/2009 ->; mit Zubehör	SK-1487AQ2	BTKW	
1.5 dCi	02/09-	K9K 836, K9K 837	1461	27x123; mit Zubehör	SK-1487AQ3	BTKW	
1.5 dCi	02/09-	K9K636	1461	27x119	SK-1730	BTK	
1.5 dCi	02/09-	K9K636	1461	27x119	SK-1730AQ1	BTKW	
1.5 dCi	12/09-	K9K 830	1461	27x123; mit Zubehör; Baumuster: BZ0A	SK-1487	BTK	
1.5 dCi	12/09-	K9K 830	1461	27x123; mit Zubehör	SK-1487AQ2	BTKW	
1.6 16V	11/08-	K4M 848	1598	27x132; mit Zubehör	SK-1088	BTK	
1.6 16V	11/08-	K4M 848	1598	27x132; mit Zubehör	SK-1088AQ1	BTKW	
1.6 16V , 1.6 16V Bifuel	11/08-	K4M 858, K4M 858, K4M 866, K4M 866	1598	27x132	SK-1630	BTK	
1.6 16V , 1.6 16V Bifuel	11/08-	K4M 858, K4M 858, K4M 866, K4M 866	1598	27x132	SK-1630AQ1	BTKW	
1.9 dCi	11/08-	F9Q 870, F9Q 872	1870	26x133	SK-1698	BTK	
1.9 dCi	11/08-	F9Q 870, F9Q 872	1870	26x133	SK-1698AQ1	BTKW	
2.0 TCe	11/08-	F4R 870	1998	27x126	SK-1624	BTK	
1.5 dCi	11/08-	K9K 636, K9K 656, K9K 657, K9K 836, K9K 837, K9K 846, K9K 830, K9K G 832, K9K H 834	1461		0-N1111	TB [TE]	
1.5 dCi	02/09-	K9K 636	1461		0-N2423	TB [TE]	
1.5 dCi	11/13-	K9K 846	1461		0-N2423	TB [TE]	
1.6 16V	11/08-	K4M 848	1598		0-N198	TB [TE]	
1.6 16V	11/08-	K4M 848	1598		0-N262	TB [DG]	
1.6 16V , 1.6 16V Bifuel	11/08-	K4M 858, K4M 866	1598		0-N1368	TB [TE]	
1.6 16V , 1.6 16V Bifuel	11/08-	K4M 858, K4M 858, K4M 866, K4M 866	1598		0-N262	TB [DG]	
1.9 dCi	11/08-	F9Q 870, F9Q 872	1870		0-N2060	TB [TE]	
2.0 TCe	11/08-	F4R 870	1998		0-N1365	TB [DG]	
2.0 TCe	11/08-	F4R 870	1998		0-N200	TB [TE]	
1.2 TCe	03/12-	H5F 400	1198		0-N2308	VB [BT]	S
1.2 TCe	03/12-	H5F 400	1198		0-N2344	VB [DG]	
1.2 TCe	01/13-	H5F 404	1197		0-N2308	VB [BT]	S
1.2 TCe	01/13-	H5F 404	1197		0-N2344	VB [DG]	
1.4 TCe	04/09-	H4J 700	1397		0-N2279	VB [BT]	S
1.4 TCe	04/09-	H4J 700	1397		0-N2344	VB [DG]	
1.5 dCi	11/08-	K9K 636, K9K 656, K9K 657, K9K 836, K9K 837, K9K 846, K9K 830, K9K G 832, K9K H 834	1461		0-N1664	VB [BT]	S
1.6 16V	11/08-	K4M 848	1598	✳	0-N1664	VB [BT]	S
1.6 16V , 1.6 16V Bifuel	11/08-	K4M 858, K4M 866	1598		0-N1664	VB [BT]	S
1.6 dCi	04/11-	R9M 402, R9M 404	1598		0-N1739	VB [DG]	
1.6 dCi	04/11-	R9M 402, R9M 404	1598		0-N2280	VB [BT]	S
1.9 dCi	11/08-	F9Q 870, F9Q 872	1870		0-N1427	VB [BT]	S
2.0 CVT	02/09-	M4R 711, M4R 713	1997		0-N1869	VB [BT]	S
2.0 dCi	04/09-	M9R 610, M9R 615	1995		0-N1739	VB [DG]	

CM³

Art. Nr.

**MEGANE III Schrägheck (BZ0_)**

2.0 dCi	04/09-	M9R 610, M9R 615	1995		0-N2039	VB [BT]	S
2.0 TCe	11/08-	F4R 870	1998		0-N1427	VB [BT]	S

MEGANE III Stufenheck

1.9 dCi	06/09-	F9Q 870, F9Q 872	1870	26x133	SK-1698	BTK	
1.9 dCi	06/09-	F9Q 870, F9Q 872	1870		0-N2060	TB [TE]	
1.9 dCi	06/09-	F9Q 870, F9Q 872	1870		0-N1427	VB [BT]	S

MEGANE CC (EZ0/1_)

1.5 dCi	06/10-	K9K 837, K9K 837	1461	27x123; mit Zubehör	SK-1487	BTK	
1.5 dCi	06/10-	K9K 837, K9K 837	1461	27x123; mit Zubehör	SK-1487AQ3	BTKW	
1.5 dCi	06/10-	K9K 837, K9K 837	1461	27x119	SK-1730	BTK	
1.5 dCi	06/10-	K9K 837, K9K 837	1461	27x119	SK-1730AQ1	BTKW	
1.6 16V	06/10-	K4M 858	1598	27x132	SK-1630	BTK	
1.6 16V	06/10-	K4M 858	1598	27x132	SK-1630AQ1	BTKW	
1.9 dCi	06/10-	F9Q 870	1870	26x133	SK-1698	BTK	
1.9 dCi	06/10-	F9Q 870	1870	26x133	SK-1698AQ1	BTKW	
2.0 TCe	06/10-	F4R 872	1998	27x126	SK-1624	BTK	
1.5 dCi	06/10-	K9K 837, K9K 837	1461		0-N1111	TB [TE]	
1.6 16V	06/10-	K4M 858	1598		0-N1368	TB [TE]	
1.6 16V	06/10-	K4M 858	1598		0-N262	TB [DG]	
1.9 dCi	06/10-	F9Q 870	1870		0-N2060	TB [TE]	
2.0 TCe	06/10-	F4R 870, F4R 872	1998		0-N1365	TB [DG]	
2.0 TCe	06/10-	F4R 870, F4R 872	1998		0-N200	TB [TE]	
1.2 TCe	01/13-	H5F 400	1197		0-N2308	VB [BT]	S
1.2 TCe	01/13-	H5F 404	1197		0-N2344	VB [DG]	
1.4 TCe	06/10-	H4J 700	1397		0-N2279	VB [BT]	S
1.4 TCe	06/10-	H4J 700	1397		0-N2344	VB [DG]	
1.5 dCi	06/10-	K9K 836	1461		0-N1664	VB [BT]	S
1.5 dCi	06/10-	K9K 837	1461		0-N1664	VB [BT]	S
1.6 16V	06/10-	K4M 858	1598		0-N1664	VB [BT]	S
1.6 16V	06/10-	K4M 866	1598		0-N1664	VB [BT]	S
1.6 dCi	04/11-	R9M 402	1598		0-N1739	VB [DG]	
1.6 dCi	04/11-	R9M 402	1598		0-N2280	VB [BT]	S
1.9 dCi	06/10-	F9Q 870	1870		0-N1427	VB [BT]	S
2.0 CVT	06/10-	M4R 711, M4R 713	1997		0-N1869	VB [BT]	S
2.0 dCi	06/10-	M9R 610	1995		0-N1739	VB [DG]	
2.0 dCi	06/10-	M9R 610	1995		0-N2039	VB [BT]	S
2.0 TCe , 2.0 Turbo	06/10-	F4R 870, F4R 872, F4R 874	1998		0-N1427	VB [BT]	S

MEGANE Scenic (JA0/1_)

1.4 i	01/97-09/99	E7J 764	1390	17x95	SK-1021	BTK	
1.6 16V	04/98-10/99	K4M 700, K4M 701, K4M 704, K4M 708	1598	27x132; mit Zubehör	SK-1088	BTK	
1.6 16V	04/98-10/99	K4M 700, K4M 701, K4M 704, K4M 708	1598	27x132; mit Zubehör	SK-1088AQ1	BTKW	
1.6 e	10/96-10/99	K7M 702, K7M 703	1598	17x95	SK-1021	BTK	
1.6 e	10/96-10/99	K7M 702, K7M 703	1598	17x95	SK-1021AQ2	BTKW	
1.6 i	01/97-09/99	K7M 720	1598	17x96	SK-1338	BTK	
1.6 i	01/97-09/99	K7M 720	1598	17x96	SK-1338AQ2	BTKW	
1.9 D , 1.9 dT	01/97-09/99	F8Q 784, F8Q 786, F8Q 790	1870	25.4x153	SK-1107	BTK	
1.9 dTi	04/97-09/99	F9Q 734	1870	26x153; beinhaltetete Rollen: 3; mit Zahnrad	SK-1084	BTK	
1.9 dTi	04/97-09/99	F9Q 730, F9Q 734	1870	26x153; beinhaltetete Rollen: 2	SK-1114	BTK	
1.9 dTi	04/97-09/99	F9Q 730, F9Q 734	1870	26x153; 06/1999 →; beinhaltetete Rollen: 2	SK-1620	BTK	
1.9 dTi	04/97-09/99	F9Q 730, F9Q 734	1870	26x153; beinhaltetete Rollen: 3; mit Zubehör	SK-1622	BTK	
2.0 i	01/97-09/99	F3R 750, F3R 751	1998	19x127; 05/1997 →	SK-1036	BTK	
2.0 i	01/99-09/99	F3R 796	1998	19x127	SK-1036	BTK	
2.0 i	01/99-09/99	F3R 796	1998	19x127; mit Zahnrad	SK-1099	BTK	
1.4 i	01/97-09/99	E7J 764	1390		0-N863	TB [TE]	
1.6 16V	04/98-10/99	K4M 700, K4M 701, K4M 704, K4M 708	1598		0-N198	TB [TE]	
1.6 16V	04/98-10/99	K4M 700, K4M 701, K4M 704, K4M 708	1598		0-N262	TB [DG]	
1.6 e	10/96-10/99	K7M 702, K7M 703	1598		0-N863	TB [TE]	
1.9 D	03/97-09/99	F8Q 790	1870		0-N147	TB [DG]	
1.9 D , 1.9 dT	01/97-09/99	F8Q 784, F8Q 786, F8Q 790	1870		0-N854	TB [DG]	
1.9 D , 1.9 dT , 1.9 dTi	01/97-09/99	F8Q 784, F8Q 786, F8Q 790, F9Q 730, F9Q 734	1870		0-N173	TB [TE]	
1.9 dT	01/97-09/99	F8Q 786	1870		0-N147	TB [DG]	
1.9 dTi	04/97-09/99	F9Q 734	1870		0-N147	TB [DG]	
1.9 dTi	04/97-09/99	F9Q 730, F9Q 734	1870		0-N148	TB [DG]	



CM³



Art. Nr.



MEGANE Scenic (JA0/1_)							
2.0 i	01/97-09/99	F3R 750, F3R 751, F3R 796	1998			0-N173	TB [TE]
2.0 i	01/99-09/99	F3R 796	1998			0-N146	TB [DG]
2.0 i , 2.0 RXE 4x4	01/97-10/99	F3R 750, F3R 750, F3R 751, F3R 796	1998			0-N854	TB [DG]
1.4 i	01/97-09/99	E7J 764	1390	07/1997 →; *		0-N149	VB [TE]
1.4 i	01/97-09/99	E7J 764	1390			0-N150	VB [DG]
1.6 16V	04/98-10/99	K4M 700, K4M 701, K4M 704, K4M 708	1598			0-N1307	VB [DG]
1.6 16V	04/98-10/99	K4M 700, K4M 701, K4M 704, K4M 708	1598	*		0-N1314	VB [TE]
1.6 16V	04/98-10/99	K4M 700, K4M 701, K4M 704, K4M 708	1598	*		0-N1663	VB [BT] S
1.6 e , 1.6 i	10/96-10/99	K7M 702, K7M 703, K7M 720	1598	07/1997 →; *		0-N149	VB [TE]
1.6 e , 1.6 i	10/96-10/99	K7M 702, K7M 703, K7M 720	1598			0-N150	VB [DG]
1.9 D , 1.9 dT	01/97-09/99	F8Q 784, F8Q 786, F8Q 790	1870			0-N1470	VB [BT] S
1.9 D , 1.9 dT	01/97-09/99	F8Q 784, F8Q 786, F8Q 790	1870			0-N1729	VB [DG]
1.9 dTi	04/97-09/99	F9Q 730, F9Q 734	1870	*		0-N1470	VB [BT] S
1.9 dTi	04/97-09/99	F9Q 730, F9Q 734	1870	*		0-N1729	VB [DG]
2.0 i	01/97-09/99	F3R 750, F3R 751, F3R 796	1998	mit Anbaumaterial		0-N139	VB [TE]

MODUS / GRAND MODUS (F/JP0_)							
1.2	12/04-	D4F 764	1149	23.4x95; 04/2005 →		SK-1486	BTK
1.2	12/04-	D4F 740	1149	23.4x95; Baumuster: JP0C		SK-1486	BTK
1.2	12/04-	D4F 764	1149	23.4x95; 04/2005 →		SK-1486AQ1	BTKW
1.2 , 1.2 16V Hi-Flex	12/04-	D4F 740, D4F 786	1149	23.4x95		SK-1486AQ1	BTKW
1.2 , 1.2 16V Hi-Flex	05/05-	D4F 740, D4F 786	1149	23.4x95		SK-1486	BTK
1.2 16V	05/07-	D4F 784	1149	23.4x95; 11/2007 →		SK-1486	BTK
1.2 16V	05/07-	D4F 784	1149	23.4x95; 11/2007 →		SK-1486AQ1	BTKW
1.4	12/04-	K4J 770, K4J 780	1390	27x132; mit Zubehör		SK-1088	BTK
1.4	12/04-	K4J 770, K4J 780	1390	27x132; mit Zubehör		SK-1088AQ1	BTKW
1.5 dCi	09/04-	K9K 750, K9K 752, K9K 760, K9K 766, K9K 762, K9K 768, K9K 764, K9K 772	1461	27x123; mit Zubehör		SK-1487AQ2	BTKW
1.5 dCi	12/04-	K9K 752	1461	27x123; mit Zubehör		SK-1487AQ1	BTKW
1.5 dCi	05/05-	K9K 764	1461	27x123; mit Zubehör; Baumuster: JP0H		SK-1487	BTK
1.5 dCi , 1.5 dCi 75, 1.5 dCi 90	09/04-	K9K 750, K9K 752, K9K 760, K9K 766, K9K 762, K9K 768, K9K 770, K9K 772	1461	27x123; mit Zubehör		SK-1487	BTK
1.5 dCi 75, 1.5 dCi 90	10/10-	K9K 750, K9K 770	1461	27x123; mit Zubehör; Baumuster: Grand Modus		SK-1487AQ3	BTKW
1.5 dCi 75, 1.5 dCi 90	10/10-	K9K 750, K9K 770	1461	27x123; mit Zubehör; Baumuster: Modus		SK-1487AQ3	BTKW
1.6	12/04-	K4M 790, K4M 791, K4M 800, K4M 801, K4M 794	1598	27x132		SK-1630	BTK
1.6	12/04-	K4M 790, K4M 791, K4M 800, K4M 801, K4M 794	1598	27x132		SK-1630AQ1	BTKW
1.2 , 1.2 16V , 1.2 16V Hi-Flex	12/04-	D4F 740, D4F 764, D4F 784	1149			0-N1112	TB [TE]
1.4	12/04-	K4J 770, K4J 780	1390			0-N198	TB [TE]
1.4	12/04-	K4J 770, K4J 780	1390			0-N262	TB [DG]
1.5 dCi , 1.5 dCi 75, 1.5 dCi 90	09/04-	K9K 750, K9K 752, K9K 760, K9K 766, K9K 762, K9K 768, K9K 764, K9K 770, K9K 772	1461			0-N1111	TB [TE]
1.6	12/04-	K4M 790, K4M 791, K4M 800, K4M 801, K4M 794	1598			0-N1368	TB [TE]
1.6	12/04-	K4M 790, K4M 791, K4M 800, K4M 801, K4M 794	1598			0-N262	TB [DG]
1.2 , 1.2 16V , 1.2 16V Hi-Flex	12/04-	D4F 740, D4F 764, D4F 784	1149			0-N1743	VB [DG]
1.4	12/04-	K4J 770, K4J 780	1390	→ 05/2006; *		0-N1474	VB [BT]
1.4	12/04-	K4J 770, K4J 780	1390	→ 04/2005; *		0-N1476	VB [BT] S
1.4	12/04-	K4J 770, K4J 780	1390	04/2005 →; *		0-N1664	VB [BT] S
1.5 dCi	09/04-	K9K 750, K9K 752, K9K 760, K9K 766, K9K 762, K9K 768	1461	→ 01/2005; *		0-N1476	VB [BT] S
1.5 dCi	09/04-	K9K 750	1461	01/2005 →		0-N1664	VB [BT] S
1.5 dCi	09/04-	K9K 750, K9K 752, K9K 764	1461	→ 12/2007; Rippenanzahl: 6; *		0-N1898	VB [BT] S
1.5 dCi	09/04-	K9K 750, K9K 752	1461	12/2007 →; *		0-N2253	VB [DG]
1.5 dCi	12/04-	K9K 752, K9K 760, K9K 766, K9K 762, K9K 768, K9K 764	1461	→ 09/2005; *		0-N1474	VB [BT]
1.5 dCi	12/04-	K9K 752, K9K 760, K9K 766, K9K 762, K9K 768	1461	01/2005 →; *		0-N1664	VB [BT] S
1.5 dCi	12/04-	K9K 760, K9K 766, K9K 762, K9K 768, K9K 764	1461	09/2005 →; *		0-N1664	VB [BT] S
1.5 dCi	12/04-	K9K 766	1461	→ 12/2007; Rippenanzahl: 6; *		0-N1898	VB [BT] S
1.5 dCi	12/04-	K9K 768	1461	→ 12/2007; Rippenanzahl: 6; *		0-N1898	VB [BT] S
1.5 dCi	12/04-	K9K 766	1461	12/2007 →; *		0-N2253	VB [DG]
1.5 dCi	12/04-	K9K 768	1461	12/2007 →; *		0-N2253	VB [DG]
1.5 dCi	05/05-	K9K 764, K9K 772	1461	*		0-N1664	VB [BT] S
1.5 dCi	05/07-	K9K 772	1461	*		0-N1664	VB [BT] S

**CM³**

Art. Nr.



ohne Halter

MODUS / GRAND MODUS (F/JP0_)

1.5 dCi 75, 1.5 dCi 90	10/10-	K9K 750, K9K 770	1461		0-N1664	VB [BT]	S
1.5 dCi 75, 1.5 dCi 90	10/10-	K9K 750, K9K 770	1461	☼	0-N2253	VB [DG]	
1.6	12/04-	K4M 790, K4M 791, K4M 800, K4M 801, K4M 794	1598	→ 05/2006; ☼	0-N1474	VB [BT]	
1.6	12/04-	K4M 790, K4M 791, K4M 800, K4M 801, K4M 794	1598	→ 04/2005; ☼	0-N1476	VB [BT]	S
1.6	12/04-	K4M 790, K4M 791, K4M 800, K4M 801, K4M 794	1598	04/2005 →; ☼	0-N1664	VB [BT]	S
1.6	12/04-	K4M 790, K4M 791, K4M 800, K4M 801, K4M 794	1598	09/2005 →; ☼	0-N1664	VB [BT]	S
1.6	12/04-	K4M 801	1598	→ 04/2009; Rippenanzahl: 6; ☼	0-N1898	VB [BT]	S
1.6	12/04-	K4M 794	1598	→ 07/2012; Rippenanzahl: 6; ☼	0-N1898	VB [BT]	S
1.6	12/04-	K4M 800	1598	→ 12/2007; Rippenanzahl: 6; ☼	0-N1898	VB [BT]	S
1.6	12/04-	K4M 790, K4M 791	1598	Rippenanzahl: 6; ☼	0-N1898	VB [BT]	S
1.6	12/04-	K4M 801	1598	04/2009 →; ☼	0-N2253	VB [DG]	
1.6	12/04-	K4M 794	1598	12/2007 →; ☼	0-N2253	VB [DG]	
1.6	12/04-	K4M 800	1598	12/2007 →; ☼	0-N2253	VB [DG]	

R12 [USA] Kombi

2.5 WRX AWD	01/76-12/77		1647		0-N2102	VB [DG]	
-------------	-------------	--	------	--	---------	---------	--

RAPID Kasten (F40_, G40_)

1.4, 1.4 RN	09/91-03/98	E6J 734, E7J 720, E7J 720, E7J 724, E7J 726, E7J 773, E7J 724, E7J 728, E7J 773	1390	17x95	SK-1021	BTK	
1.4, 1.4 RN	09/91-03/98	E6J 734, E7J 720, E7J 720, E7J 724, E7J 726, E7J 773, E7J 724, E7J 728, E7J 773	1390	17x95	SK-1021AQ1	BTKW	
1.6 D	03/86-08/98	F8M 720, F8M 730	1596	25.4x153; 02/1988 →	SK-1012	BTK	
1.6 D	03/86-08/98	F8M 736	1596	25.4x153; 09/1993 →	SK-1012	BTK	
1.6 D	03/86-08/98	F8M 720, F8M 730, F8M 736, F8M 760	1596	25.4x153	SK-1015	BTK	
1.6 D	09/93-04/95	F8M 736	1595	25.4x153	SK-1012	BTK	
1.9 D	09/91-03/98	F8Q 774, F8Q 776	1870	25.4x151; 09/1993 →	SK-1013	BTK	
1.9 D	09/91-03/98	F8Q 722, F8Q 724	1870	25.4x151; 1	SK-1013	BTK	
1.9 D	09/91-03/98	F8Q 646, F8Q 722, F8Q 724, F8Q 774, F8Q 776	1870	25.4x151; 10/1996 →; beinhaltetete Rollen: 2	SK-1108S	BTK	
1.9 D	09/94-03/98	F8Q 640, F8Q 682	1870	25.4x151; 07/1995 → 08/1996	SK-1013	BTK	
1.9 D	09/94-03/98	F8Q 640, F8Q 682	1870	25.4x151; 09/1996 →; beinhaltetete Rollen: 3; mit Zahnrad; Baumuster: F40P, G40B	SK-1108	BTK	
1.9 D	09/94-03/98	F8Q 640, F8Q 682	1870	25.4x151; 09/1996 →; beinhaltetete Rollen: 2; Baumuster: F40P, G40B	SK-1108S	BTK	
1.4, 1.4 RN	09/91-03/98	E6J 734, E7J 720, E7J 720, E7J 724, E7J 726, E7J 773, E7J 724, E7J 728, E7J 773	1390		0-N863	TB [TE]	
1.6 D	03/86-08/98	F8M 720, F8M 730, F8M 736, F8M 760	1596	02/1988 →	0-N173	TB [TE]	
1.6 D	03/86-08/98	F8M 720, F8M 730, F8M 736, F8M 760	1596	02/1988 →	0-N854	TB [DG]	
1.6 D	03/86-08/98	F8M 720, F8M 730, F8M 736, F8M 760	1596	→ 01/1988	0-N883	TB [TE]	
1.6 D	03/86-08/98	F8M 720, F8M 730, F8M 736, F8M 760	1596	→ 01/1988	0-N887	TB [DG]	
1.6 D	09/93-04/95	F8M 736	1595		0-N173	TB [TE]	
1.6 D	09/93-04/95	F8M 736	1595		0-N854	TB [DG]	
1.9 D	09/91-03/98	F8Q 640, F8Q 682, F8Q 646, F8Q 722, F8Q 724, F8Q 774, F8Q 776	1870		0-N173	TB [TE]	
1.9 D	09/91-03/98	F8Q 722, F8Q 724, F8Q 774, F8Q 776	1870		0-N881	TB [DG]	
1.9 D	09/94-03/98	F8Q 682	1870		0-N147	TB [DG]	
1.9 D	09/94-03/98	F8Q 640	1870		0-N881	TB [DG]	
1.9 D	09/94-03/98	F8Q 682	1870	09/1996 →	0-N881	TB [DG]	

SAFRANE I (B54_)

2.0, 2.0 12V	04/92-07/96	J7R 732, J7R 733, J7R 734, J7R 735	1995	19x116; → 02/1995	SK-1091	BTK	
2.1 dT	11/93-07/96	J8S 760	2068	25.4x148	SK-1093	BTK	
2.2	04/92-07/96	J7T 760, J7T 761, J7T 762	2165	19x118	SK-1092	BTK	
2.5 dT	12/92-07/96	S8U 762, S8U 763	2500	19x95	SK-1154	BTK	
2.0, 2.0 12V	04/92-07/96	J7R 732, J7R 733, J7R 734, J7R 735	1995		0-N882	TB [TE]	
2.1 dT	11/93-07/96	J8S 760	2068	mit Anbaumaterial	0-N913	TB [TE]	
2.2	04/92-07/96	J7T 760, J7T 761, J7T 762	2165		0-N882	TB [TE]	
2.5 dT	12/92-07/96	S8U 762, S8U 763	2500		0-N949	TB [TE]	
2.0, 2.0 12V	04/92-07/96	J7R 732, J7R 733, J7R 734, J7R 735	1995	mit Grundträger	0-N2332	VB [TE]	
2.2	04/92-07/96	J7T 760, J7T 761	2165	mit Grundträger	0-N2332	VB [TE]	
2.5 dT	12/92-07/96	S8U 762, S8U 763	2500		0-N144	VB [DG]	
3.0 Biturbo 4x4, 3.0 V6, 3.0 V6 4x4	12/92-07/96	Z7X 721, Z7X 722, Z7X 723, Z7X 721, Z7X 722, Z7X 723, Z7X 753, Z7X 753, Z7X 753, Z7X 726	2963	mit Grundträger; ☼	0-N2333	VB [TE]	

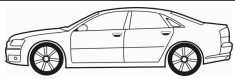

CM³



Art. Nr.



SAFRANE I (B54_)

3.0 Biturbo 4x4 , 3.0 V6 , 3.0 V6 4x4	12/92-07/96	Z7X 721, Z7X 722, Z7X 723, Z7X 721, Z7X 722, Z7X 723, Z7X 753, Z7X 753, Z7X 753, Z7X 726	2963	mit Grundträger	0-N2334	VB [TE]
3.0 Biturbo 4x4 , 3.0 V6 , 3.0 V6 4x4	12/92-07/96	Z7X 721, Z7X 722, Z7X 723, Z7X 721, Z7X 722, Z7X 723, Z7X 753, Z7X 753, Z7X 753, Z7X 726	2963	Rippenanzahl: 5; mit Grundträger; für Fahrzeuge mit Servolenkung	0-N2335	VB [TE]
3.0 Biturbo 4x4 , 3.0 V6 , 3.0 V6 4x4	12/92-07/96	Z7X 721, Z7X 722, Z7X 723, Z7X 721, Z7X 722, Z7X 723, Z7X 753, Z7X 753, Z7X 753, Z7X 726	2963	mit Grundträger	0-N2336	VB [TE]
3.0 Biturbo 4x4 , 3.0 V6 , 3.0 V6 4x4	12/92-07/96	Z7X 721, Z7X 722, Z7X 723, Z7X 721, Z7X 722, Z7X 723, Z7X 753, Z7X 753, Z7X 753, Z7X 726	2963	mit Grundträger; *	0-N2342	VB [DG]

SAFRANE II (B54_)

2.0 16V	07/96-12/00	N7Q 710, N7Q 711	1948	23x148; 11/1996 → 12/1997; mit Zubehör	SK-1103	BTK
2.0 16V	07/96-12/00	N7Q 710, N7Q 711	1948	23x148; → 12/1997; mit Zubehör	SK-1103AQ1	BTKW
2.0 16V	07/96-12/00	N7Q 710, N7Q 711	1948	23x142; 12/1997 →	SK-1491	BTK
2.0 16V	07/96-12/00	N7Q 710, N7Q 711	1948	23x142; 12/1997 →	SK-1491AQ1	BTKW
2.2 dT	07/96-12/00	G8T 740	2188	25.4x163; 11/1996 →; Baumuster: B54G	SK-1096	BTK
2.2 dT	07/96-12/00	G8T 740	2188	25.4x163	SK-1096AQ1	BTKW
2.5 20V	07/96-12/00	N7U 700, N7U 701	2435	23x148; 11/1996 → 12/1997; mit Zubehör	SK-1103	BTK
2.5 20V	07/96-12/00	N7U 700, N7U 701	2435	23x148; → 12/1997; mit Zubehör	SK-1103AQ1	BTKW
2.5 20V	07/96-12/00	N7U 700, N7U 701	2435	23x142; 12/1997 →	SK-1491	BTK
2.5 20V	07/96-12/00	N7U 700, N7U 701	2435	23x142; 12/1997 →	SK-1491AQ1	BTKW
2.9 24V	03/99-12/00	L7X 713	2946	32x259; 12/1999 →	SK-1483	BTK
2.0 16V	07/96-12/00	N7Q 710, N7Q 711	1948	12/1997 →	0-N137	TB [TE]
2.0 16V	07/96-12/00	N7Q 710, N7Q 711	1948	→ 12/1997	0-N930	TB [TE]
2.0 16V	07/96-12/00	N7Q 710, N7Q 711	1948		0-N958	TB [DG]
2.2 dT	07/96-12/00	G8T 740	2188		0-N112	TB [TE]
2.2 dT	07/96-12/00	G8T 740	2188		0-N965	TB [DG]
2.5 20V	07/96-12/00	N7U 700, N7U 701	2435	12/1997 →	0-N137	TB [TE]
2.5 20V	07/96-12/00	N7U 700, N7U 701	2435	→ 12/1997	0-N930	TB [TE]
2.5 20V	07/96-12/00	N7U 700, N7U 701	2435		0-N958	TB [DG]
2.9 24V	03/99-12/00	L7X 713	2946		0-N1056	TB [TE]
2.9 24V	03/99-12/00	L7X 713	2946		0-N170	TB [DG]
2.9 24V	03/99-12/00	L7X 713	2946		0-N171	TB [DG]
2.0 16V	07/96-12/00	N7Q 710, N7Q 711	1948		0-N143	VB [DG]
2.0 16V	07/96-12/00	N7Q 710, N7Q 711	1948		0-N1518	VB [BT] S
2.0 16V	07/96-12/00	N7Q 710, N7Q 711	1948	EMERSON: → 12/1997	0-N2223	VB [VD]
2.2 dT	07/96-12/00	G8T 740	2188		0-N1488	VB [BT] S
2.2 dT	07/96-12/00	G8T 740	2188		0-N1590	VB [DG]
2.2 dT	07/96-12/00	G8T 740	2188	*	0-N1752	VB [BT]
2.2 dT	07/96-12/00	G8T 740	2188		0-N1916	VB [BT]
2.2 dT	07/96-12/00	G8T 740	2188		0-N2179	VB [TE]
2.5 20V	07/96-12/00	N7U 700, N7U 701	2435		0-N143	VB [DG]
2.5 20V	07/96-12/00	N7U 700, N7U 701	2435		0-N1518	VB [BT] S
2.5 20V	07/96-12/00	N7U 700, N7U 701	2435	EMERSON: → 12/1997	0-N2223	VB [VD]
2.9 24V	03/99-12/00	L7X 713	2946		0-N1449	VB [TE]
2.9 24V	03/99-12/00	L7X 713	2946		0-N1757	VB [VD]
2.9 24V	03/99-12/00	L7X 713	2946		0-N2175	VB [BT]

SANDERO/STEPWAY I

1.4	02/09-	K7J 710	1390	17x96; → 11/2009	SK-1338	BTK
1.4	02/09-	K7J 710	1390	17x96; → 11/2009	SK-1338AQ2	BTKW
1.4	02/09-	K7J 710	1390	17.3x96; 11/2009 →	SK-1704	BTK
1.4	02/09-	K7J 710	1390	17.3x96; 11/2009 →	SK-1704AQ1	BTKW
1.6	12/07-	K4M 690, K7M 710	1598	17.3x96; 11/2009 →	SK-1704	BTK
1.6	12/07-	K4M 690, K7M 710	1598	17.3x96; 11/2009 →	SK-1704AQ1	BTKW
1.6	02/09-	K7M 710	1598	17x96; → 11/2009	SK-1338	BTK
1.6	02/09-	K7M 710	1598	17x96; → 11/2009	SK-1338AQ2	BTKW
1.6	02/09-	K7M 710	1598	17.3x96; 11/2009 →; Baumuster: Sandero Stepway	SK-1704AQ1	BTKW
1.6	11/10-	K7M 718	1598	17.3x96	SK-1704	BTK
1.6	11/10-	K7M 718	1598	17.3x96	SK-1704AQ1	BTKW
1.4	02/09-	K7J 710	1390	11/2009 →	0-N2062	TB [TE]
1.6	12/07-	K7M 710	1598	11/2009 →	0-N2062	TB [TE]
1.6	11/10-	K7M 718	1598		0-N2062	TB [TE]
1.4	02/09-	K7J 710	1390	→ 09/2009	0-N1307	VB [DG]



CM³



Art. Nr.



SANDERO/STEPWAY I

1.4	02/09-	K7J 710	1390	→ 09/2009; für Fahrzeuge mit Servolenkung,	0-N1314	VB [TE]	
1.4	02/09-	K7J 710	1390	→ 09/2009; für Fahrzeuge mit Servolenkung	0-N1663	VB [BT]	S
1.4	02/09-	K7J 710	1390	09/2009 →; für Fahrzeuge mit Servolenkung	0-N2265	VB [BT]	S
1.4	02/09-	K7J 710	1390	09/2009 →; für Fahrzeuge mit Servolenkung	0-N2275	VB [DG]	
1.6	12/07-	K7M 710	1598	→ 09/2009; für Fahrzeuge mit Servolenkung	0-N1663	VB [BT]	S
1.6	12/07-	K7M 710	1598	09/2009 →; für Fahrzeuge mit Servolenkung	0-N2265	VB [BT]	S
1.6	12/07-	K7M 710	1598	09/2009 →; für Fahrzeuge mit Servolenkung	0-N2275	VB [DG]	
1.6	02/09-	K7M 710	1598	→ 09/2009	0-N1307	VB [DG]	
1.6	02/09-	K7M 710	1598	→ 09/2009; für Fahrzeuge mit Servolenkung,	0-N1314	VB [TE]	
1.6	11/10-	K7M 718	1598	für Fahrzeuge mit Servolenkung	0-N2265	VB [BT]	S
1.6	11/10-	K7M 718	1598	für Fahrzeuge mit Servolenkung	0-N2275	VB [DG]	

SANDERO/STEPWAY II

1.6	11/13-	K7M 812	1598	17.3x96	SK-1704AQ1	BTKW	
-----	--------	---------	------	---------	-------------------	------	--

SCÉNIC I (JA0/1_)

1.4 16V	09/99-08/03	K4J 714, K4J 750	1390	27x132; mit Zubehör	SK-1088	BTK	
1.4 16V	09/99-08/03	K4J 714, K4J 750	1390	27x132; mit Zubehör	SK-1088AQ1	BTKW	
1.6, 1.6 BiFuel	09/99-09/03	K4M 700, K4M 706, K4M 704, K4M 708, K4M 709	1598	27x132; mit Zubehör	SK-1088	BTK	
1.6, 1.6 BiFuel	09/99-09/03	K4M 700, K4M 706, K4M 704, K4M 708, K4M 709	1598	27x132; mit Zubehör	SK-1088AQ1	BTKW	
1.8 16V, 1.8 4x4	07/00-08/03	F4P 720, F4P 722, F4P 722	1783	27x128	SK-1494	BTK	
1.8 16V, 1.8 4x4	07/00-08/03	F4P 720, F4P 722, F4P 722	1783	27x128	SK-1631	BTK	
1.9 D	09/99-03/01	F8Q 790	1870	25.4x153	SK-1107	BTK	
1.9 dCi, 1.9 dCi RX4, 1.9 dTi	09/99-08/03	F9Q 732, F9Q 733, F9Q 732, F9Q 748, F9Q 796, F9Q 740, F9Q 744	1870	26x153; beinhaltetete Rollen: 3; mit Zahnrad	SK-1084	BTK	
1.9 dCi, 1.9 dCi RX4, 1.9 dTi	09/99-08/03	F9Q 732, F9Q 733, F9Q 732, F9Q 748, F9Q 796, F9Q 740, F9Q 744	1870	26x153; beinhaltetete Rollen: 2	SK-1114	BTK	
1.9 dTi	09/99-08/03	F9Q 736	1870	26x153; → 10/2000; beinhaltetete Rollen: 3; mit Zahnrad	SK-1084	BTK	
1.9 dTi	09/99-08/03	F9Q 734	1870	26x153; beinhaltetete Rollen: 3; mit Zahnrad	SK-1084	BTK	
1.9 dTi	09/99-08/03	F9Q 736	1870	26x153; → 10/2000; beinhaltetete Rollen: 2	SK-1114	BTK	
1.9 dTi	09/99-08/03	F9Q 734	1870	26x153; beinhaltetete Rollen: 2	SK-1114	BTK	
1.9 dTi	09/99-08/03	F9Q 731, F9Q 734, F9Q 736	1870	26x153; → 06/2001; beinhaltetete Rollen: 4; mit Zahnrad; mit Zubehör	SK-1490	BTK	
1.9 dTi	09/99-08/03	F9Q 736	1870	26x153; 10/2000 →; beinhaltetete Rollen: 2	SK-1620	BTK	
1.9 dTi	09/99-08/03	F9Q 731, F9Q 734, F9Q 736, F9Q 744	1870	26x153; → 04/2003; beinhaltetete Rollen: 3; mit Zubehör	SK-1622	BTK	
1.9 dTi	02/01-08/03	F9Q 744	1870	26x153; → 04/2003; beinhaltetete Rollen: 4; mit Zahnrad; mit Zubehör	SK-1490	BTK	
1.9 dTi	02/01-08/03	F9Q 744	1870	26x153; beinhaltetete Rollen: 2	SK-1620	BTK	
2.0 16V, 2.0 16V RX4	09/99-08/03	F4R 740, F4R 741, F4R 744, F4R 747, F4R 740, F4R 741, F4R 746, F4R 744, F4R 746	1998	27x128; → 04/2001	SK-1494	BTK	
2.0 16V, 2.0 16V RX4	09/99-08/03	F4R 740, F4R 741, F4R 744, F4R 747, F4R 740, F4R 741, F4R 746, F4R 744, F4R 746	1998	27x128; 04/2001 →	SK-1631	BTK	
1.4 16V	09/99-08/03	K4J 714, K4J 750	1390		0-N198	TB [TE]	
1.4 16V	09/99-08/03	K4J 714, K4J 750	1390		0-N262	TB [DG]	
1.6	03/01-08/03	K4M 708, K4M 709	1598		0-N198	TB [TE]	
1.6, 1.6 BiFuel	09/99-09/03	K4M 700, K4M 706, K4M 704, K4M 708, K4M 709	1598		0-N262	TB [DG]	
1.8 16V	01/01-08/03	F4P 720, F4P 722	1783	04/2001 →	0-N1365	TB [DG]	
1.8 16V	01/01-08/03	F4P 720, F4P 722	1783	→ 04/2001	0-N262	TB [DG]	
1.8 16V, 1.8 4x4	07/00-08/03	F4P 720, F4P 722, F4P 722	1783		0-N1259	TB [DG]	
1.8 16V, 1.8 4x4	07/00-08/03	F4P 720, F4P 722, F4P 722	1783		0-N200	TB [TE]	
1.8 4x4	07/00-04/01	F4P 722	1783		0-N262	TB [DG]	
1.9 D	09/99-03/01	F8Q 790	1870		0-N854	TB [DG]	
1.9 D, 1.9 dCi, 1.9 dCi RX4, 1.9 dTi	09/99-08/03	F8Q 790, F9Q 731, F9Q 734, F9Q 736, F9Q 732, F9Q 733, F9Q 740, F9Q 744	1870		0-N147	TB [DG]	
1.9 dCi, 1.9 dCi RX4	09/99-08/03	F9Q 732, F9Q 733, F9Q 740	1870		0-N148	TB [DG]	
1.9 dCi, 1.9 dCi RX4	09/99-08/03	F9Q 732, F9Q 733, F9Q 740	1870		0-N173	TB [TE]	
1.9 dTi	09/99-08/03	F9Q 731	1870		0-N1106	TB [DG]	
1.9 dTi	09/99-08/03	F9Q 736	1870	10/2000 →	0-N1106	TB [DG]	
1.9 dTi	09/99-08/03	F9Q 734	1870		0-N148	TB [DG]	

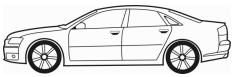

CM³



Art. Nr.



SCÉNIC I (JA0/1_)

1.9 dTi	09/99-08/03	F9Q 736	1870	→ 10/2000	0-N148	TB [DG]	
1.9 dTi	09/99-08/03	F9Q 734	1870		0-N173	TB [TE]	
1.9 dTi	09/99-08/03	F9Q 736	1870	→ 10/2000	0-N173	TB [TE]	
1.9 dTi	09/99-08/03	F9Q 731	1870		0-N199	TB [TE]	
1.9 dTi	09/99-08/03	F9Q 736	1870	10/2000 →	0-N199	TB [TE]	
1.9 dTi	02/01-08/03	F9Q 744	1870		0-N1106	TB [DG]	
1.9 dTi	02/01-08/03	F9Q 744	1870		0-N199	TB [TE]	
2.0 16V , 2.0 16V RX4	09/99-08/03	F4R 740, F4R 741, F4R 744, F4R 747, F4R 740, F4R 741, F4R 746, F4R 744, F4R 746	1998		0-N1259	TB [DG]	
2.0 16V , 2.0 16V RX4	09/99-08/03	F4R 740, F4R 741, F4R 744, F4R 747, F4R 740, F4R 741, F4R 746, F4R 744, F4R 746	1998	04/2001 →	0-N1365	TB [DG]	
2.0 16V , 2.0 16V RX4	09/99-08/03	F4R 740, F4R 741, F4R 744, F4R 747, F4R 740, F4R 741, F4R 746, F4R 744, F4R 746	1998		0-N200	TB [TE]	
2.0 16V , 2.0 16V RX4	09/99-08/03	F4R 740, F4R 741, F4R 744, F4R 747, F4R 740, F4R 741, F4R 746, F4R 744, F4R 746	1998	→ 04/2001	0-N262	TB [DG]	
1.4 16V	09/99-08/03	K4J 714, K4J 750	1390		0-N1307	VB [DG]	
1.4 16V	09/99-08/03	K4J 714, K4J 750	1390	☼	0-N1314	VB [TE]	
1.4 16V	09/99-08/03	K4J 714, K4J 750	1390	☼	0-N1663	VB [BT]	S
1.6	03/01-08/03	K4M 708, K4M 709	1598	☼	0-N1314	VB [TE]	
1.6, 1.6 BiFuel	09/99-09/03	K4M 700, K4M 706, K4M 704, K4M 708, K4M 709	1598	☼	0-N1663	VB [BT]	S
1.8 16V	01/01-08/03	F4P 720, F4P 722	1783	☼	0-N1663	VB [BT]	S
1.8 16V , 1.8 4x4	07/00-08/03	F4P 720, F4P 722, F4P 722	1783		0-N1307	VB [DG]	
1.8 4x4	07/00-04/01	F4P 722	1783		0-N1663	VB [BT]	S
1.9 dCi , 1.9 dCi RX4	09/99-08/03	F9Q 732, F9Q 733, F9Q 740	1870	03/2001 →	0-N1469	VB [BT]	
1.9 dCi , 1.9 dCi RX4	09/99-08/03	F9Q 732, F9Q 733, F9Q 740	1870	→ 03/2001	0-N1470	VB [BT]	S
1.9 dCi , 1.9 dCi RX4	09/99-08/03	F9Q 732, F9Q 733, F9Q 740	1870		0-N1729	VB [DG]	
1.9 dTi	09/99-08/03	F9Q 731, F9Q 734, F9Q 736	1870	03/2001 →; ☼	0-N1469	VB [BT]	
1.9 dTi	09/99-08/03	F9Q 731, F9Q 734, F9Q 736	1870	→ 03/2001; ☼	0-N1470	VB [BT]	S
1.9 dTi	09/99-08/03	F9Q 731, F9Q 734, F9Q 736, F9Q 744	1870	☼	0-N1729	VB [DG]	
1.9 dTi	02/01-08/03	F9Q 744	1870	☼	0-N1469	VB [BT]	
2.0 16V , 2.0 16V RX4	09/99-08/03	F4R 740, F4R 741, F4R 744, F4R 747, F4R 740, F4R 741, F4R 746, F4R 744, F4R 746	1998	☼	0-N1663	VB [BT]	S
2.0 16V, 2.0 16V RX4	09/99-08/03	F4R 740, F4R 741, F4R 744, F4R 747, F4R 740, F4R 741, F4R 746, F4R 744, F4R 746	1998		0-N1307	VB [DG]	

SCÉNIC II (JM0/1_)

1.4	06/03-	K4J 730, K4J 740, K4J 770	1390	27x132; mit Zubehör	SK-1088	BTK	
1.4	06/03-	K4J 730, K4J 740, K4J 770	1390	27x132; mit Zubehör	SK-1088AQ1	BTKW	
1.5 dCi	06/03-	K9K 722	1461	27x123; → 08/2003; mit Zubehör	SK-1487	BTK	
1.5 dCi	06/03-	K9K 722, K9K 728, K9K 729	1461	27x123; mit Zubehör	SK-1487AQ1	BTKW	
1.5 dCi	06/03-	K9K 722, K9K 728, K9K 729	1461	27x123; 04/2004 →; mit Zubehör	SK-1487AQ2	BTKW	
1.5 dCi	11/03-	K9K 724, K9K 728, K9K 729, K9K 732	1461	27x123; mit Zubehör	SK-1487	BTK	
1.5 dCi	05/05-	K9K 724, K9K 732, K9K 734	1461	27x123; mit Zubehör	SK-1487AQ2	BTKW	
1.5 dCi	01/07-	K9K 728	1461	27x123; mit Zubehör	SK-1487	BTK	
1.6	06/06-	K4M 788	1598	27x132; mit Zubehör	SK-1088	BTK	
1.6	06/06-	K4M 788	1598	27x132; mit Zubehör	SK-1088AQ1	BTKW	
1.6 , 1.6 16V	06/03-	K4M 706, K4M 766, K4M 812, K4M 813, K4M 761, K4M 782	1598	27x132	SK-1630	BTK	
1.6 , 1.6 16V	06/03-	K4M 706, K4M 766, K4M 812, K4M 813, K4M 761, K4M 782	1598	27x132	SK-1630AQ1	BTKW	
1.9 D	06/06-	F9Q 812	1870	26x133	SK-1580	BTK	
1.9 D, 1.9 dCi	06/03-	F9Q 804, F9Q 812, F9Q 812, F9Q J 803	1870	26x133	SK-1580AQ1	BTKW	
1.9 dCi	06/03-	F9Q 804, F9Q 812	1870	26x133	SK-1580	BTK	
1.9 dCi	05/05-	F9Q 803, F9Q 804	1870	26x133	SK-1580	BTK	
1.9 dCi	05/05-	F9Q 816, F9Q 818	1870	26x133	SK-1580	BTK	
1.9 dCi	05/05-	F9Q 803	1870	26x133	SK-1580AQ1	BTKW	
1.9 dCi	05/05-	F9Q 804	1870	26x133	SK-1580AQ1	BTKW	
2.0 , 2.0 16V Turbo	06/03-	F4R 770, F4R 771, F4R 776	1998	27x126	SK-1624	BTK	
2.0 , 2.0 16V Turbo	06/03-	F4R 770, F4R 771, F4R 776	1998	27x126	SK-1624AQ1	BTKW	
1.4	06/03-	K4J 730, K4J 740, K4J 770	1390		0-N198	TB [TE]	
1.4	06/03-	K4J 730, K4J 740	1390		0-N262	TB [DG]	
1.5 dCi	06/03-	K9K 722, K9K 724, K9K 728, K9K 729, K9K 732, K9K 734	1461		0-N1111	TB [TE]	
1.6	06/06-	K4M 788	1598		0-N198	TB [TE]	
1.6 , 1.6 16V	06/03-	K4M 706, K4M 766, K4M 812, K4M 813, K4M 761, K4M 782	1598		0-N1368	TB [TE]	
1.6 , 1.6 Hi-Flex	06/03-07/10	K4M 761, K4M 782, K4M 766, K4M 788	1598		0-N262	TB [DG]	
1.6 16V	10/05-	K4M 812, K4M 813	1598		0-N262	TB [DG]	

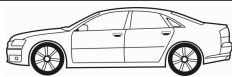
CM³

Art. Nr.



ohne Halter

SCÉNIC II (JM0/1_)

1.9 D, 1.9 dCi	06/03-	F9Q 804, F9Q 812, F9Q 812, F9Q J 803	1870	mit Anbaumaterial	0-N1323	TB [TE]	
1.9 dCi	05/05-	F9Q 803, F9Q 804	1870	mit Anbaumaterial	0-N1323	TB [TE]	
1.9 dCi	05/05-	F9Q 804	1870	mit Anbaumaterial	0-N1323	TB [TE]	
2.0, 2.0 16V Turbo	06/03-	F4R 770, F4R 771, F4R 776	1998		0-N1365	TB [DG]	
2.0, 2.0 16V Turbo	06/03-	F4R 770, F4R 771, F4R 776	1998		0-N200	TB [TE]	
1.4	06/03-	K4J 730, K4J 740	1390	☼	0-N1474	VB [BT]	
1.4	06/03-	K4J 730, K4J 740, K4J 770	1390	→ 04/2005; ☼	0-N1476	VB [BT]	S
1.4	06/03-	K4J 730, K4J 740, K4J 770	1390	04/2005 →; ☼	0-N1664	VB [BT]	S
1.4	06/03-	K4J 730, K4J 740, K4J 770	1390	Rippenanzahl: 6; ☼	0-N1898	VB [BT]	S
1.5 dCi	06/03-	K9K 722, K9K 724, K9K 728, K9K 729, K9K 732	1461	→ 09/2005; ☼	0-N1474	VB [BT]	
1.5 dCi	06/03-	K9K 722, K9K 728, K9K 729	1461	→ 01/2005; ☼	0-N1476	VB [BT]	S
1.5 dCi	06/03-	K9K 722, K9K 728, K9K 729	1461	01/2005 →; ☼	0-N1664	VB [BT]	S
1.5 dCi	06/03-	K9K 722, K9K 724, K9K 728, K9K 729, K9K 732, K9K 734	1461	09/2005 →; ☼	0-N1664	VB [BT]	S
1.5 dCi	06/03-	K9K 722, K9K 724, K9K 728, K9K 729	1461	→ 12/2007; Rippenanzahl: 6; ☼	0-N1898	VB [BT]	S
1.5 dCi	06/03-	K9K 722, K9K 728, K9K 729	1461	12/2007 →; ☼	0-N2253	VB [DG]	
1.5 dCi	05/05-	K9K 732	1461	09/2005 →; ☼	0-N1664	VB [BT]	S
1.5 dCi	05/05-	K9K 724, K9K 734	1461	☼	0-N1664	VB [BT]	S
1.5 dCi	05/05-	K9K 732	1461	→ 12/2007; Rippenanzahl: 6; ☼	0-N1898	VB [BT]	S
1.5 dCi	05/05-	K9K 724	1461	12/2007 →; ☼	0-N2253	VB [DG]	
1.5 dCi	01/07-	K9K 728	1461	→ 12/2007; Rippenanzahl: 6; ☼	0-N1898	VB [BT]	S
1.6	06/03-	K4M 761, K4M 782	1598	→ 05/2006; ☼	0-N1474	VB [BT]	
1.6	06/03-	K4M 761, K4M 782	1598	→ 04/2005; ☼	0-N1476	VB [BT]	S
1.6	06/03-	K4M 761, K4M 782	1598	04/2005 →; ☼	0-N1664	VB [BT]	S
1.6	06/03-	K4M 761, K4M 782	1598	09/2005 →; ☼	0-N1664	VB [BT]	S
1.6 16V	10/05-	K4M 812	1598	☼	0-N1476	VB [BT]	S
1.6 16V	10/05-	K4M 813	1598	→ 04/2009; Rippenanzahl: 6; ☼	0-N1898	VB [BT]	S
1.6 16V	10/05-	K4M 812	1598	→ 12/2007; Rippenanzahl: 6; ☼	0-N1898	VB [BT]	S
1.6 16V	10/05-	K4M 813	1598	04/2009 →; ☼	0-N2253	VB [DG]	
1.6 16V	10/05-	K4M 812	1598	12/2007 →; ☼	0-N2253	VB [DG]	
1.6, 1.6 16V	10/05-	K4M 706, K4M 766, K4M 812, K4M 813, K4M 788	1598		0-N1664	VB [BT]	S
1.9 D, 1.9 dCi	06/03-	F9Q 804, F9Q 804, F9Q 816, F9Q 818, F9Q J 803, F9Q 812, F9Q 812, F9Q J 803	1870		0-N1427	VB [BT]	S
2.0, 2.0 16V Turbo	06/03-	F4R 770, F4R 771, F4R 776	1998		0-N1427	VB [BT]	S
2.0 dCi	09/05-	M9R 700, M9R 721, M9R 722	1995		0-N1739	VB [DG]	
2.0 dCi	09/05-	M9R 700, M9R 721, M9R 722	1995		0-N2039	VB [BT]	S

SCÉNIC III (JZ0/1_)

1.5 dCi	02/09-	K9K 636, K9K 656, K9K 657, K9K 836, K9K 837, K9K 830, K9K 832, K9K 846	1461	27x123; mit Zubehör	SK-1487	BTK	
1.5 dCi	02/09-	K9K 830, K9K 832	1461	27x123; mit Zubehör	SK-1487AQ2	BTKW	
1.5 dCi	04/09-	K9K 636, K9K 656, K9K 657, K9K 836, K9K 837, K9K 846	1461	27x123; mit Zubehör	SK-1487AQ3	BTKW	
1.5 dCi	04/09-	K9K636	1461	27x119	SK-1730	BTK	
1.5 dCi	04/09-	K9K 636, K9K 656, K9K 657, K9K 836, K9K 837	1461	27x119	SK-1730AQ1	BTKW	
1.6 16V, 1.6 E85	02/09-	K4M 858, K4M 866	1598	27x132	SK-1630	BTK	
1.6 16V, 1.6 E85	02/09-	K4M 858, K4M 866	1598	27x132	SK-1630AQ1	BTKW	
1.9 dCi	02/09-	F9Q 870, F9Q 872	1870	26x133	SK-1698	BTK	
1.9 dCi	02/09-	F9Q 870, F9Q 872	1870	26x133	SK-1698AQ1	BTKW	
1.5 dCi	02/09-	K9K 636, K9K 656, K9K 657, K9K 836, K9K 837, K9K 830, K9K 832, K9K 846	1461		0-N1111	TB [TE]	
1.5 dCi	04/09-	K9K 636	1461		0-N2423	TB [TE]	
1.6 16V	02/09-	K4M 766	1598		0-N262	TB [DG]	
1.6 16V, 1.6 E85	02/09-	K4M 858, K4M 866	1598		0-N1368	TB [TE]	
1.6 E85	02/09-	K4M 866	1598		0-N262	TB [DG]	
1.9 dCi	02/09-	F9Q 870, F9Q 872	1870		0-N2060	TB [TE]	
1.2 Tce	04/12-	H5F 400, H5F 404	1197		0-N2308	VB [BT]	S
1.2 Tce	04/12-	H5F 400, H5F 404	1197		0-N2344	VB [DG]	
1.4 16V	02/09-	H4J 700	1397		0-N2279	VB [BT]	S
1.4 16V	02/09-	H4J 700	1397		0-N2344	VB [DG]	
1.5 dCi	02/09-	K9K 830, K9K 832, K9K 846	1461		0-N1664	VB [BT]	S
1.5 dCi	04/09-	K9K 836	1461		0-N1664	VB [BT]	S
1.5 dCi	04/09-	K9K 837	1461		0-N1664	VB [BT]	S
1.6 16V	02/09-	K4M 766	1598		0-N1664	VB [BT]	S
1.6 dCi	04/11-	R9M 402, R9M 404	1598		0-N1739	VB [DG]	



CM³



Art. Nr.



ohne Halter

SCÉNIC III (JZ0/1_)								
1.6 dCi	04/11-	R9M 402, R9M 404	1598			0-N2280	VB [BT]	S
1.6 E85	02/09-	K4M 866	1598			0-N1664	VB [BT]	S
1.9 dCi	02/09-	F9Q 870, F9Q 872	1870			0-N1427	VB [BT]	S
2.0 16V	02/09-	M4R 711	1997			0-N1869	VB [BT]	S
2.0 dCi	02/09-	M9R 610, M9R 615	1995			0-N1739	VB [DG]	
2.0 dCi	02/09-	M9R 610, M9R 615	1995			0-N2039	VB [BT]	S
SPORT SPIDER (EF0_)								
2.0	12/95-08/96	F7R 710	1998	25x148		SK-1171	BTK	
2.0 16V	03/95-10/99	F7R 710	1998	25x148; 09/1996 →		SK-1171	BTK	
2.0 16V	03/95-10/99	F7R 710	1998			0-N880	TB [TE]	
2.0, 2.0 16V	03/95-10/99	F7R 710	1998			0-N881	TB [DG]	
2.0 16V	03/95-10/99	F7R 710	1998			0-N1479S	VB [TE]	
SUPER 5 (B/C40_)								
1.6 D	04/85-12/90	F8M 730	1595	25.4x153; 02/1988 →		SK-1012	BTK	
1.6 D	04/85-12/90	F8M 730	1595	25.4x153; → 01/1988		SK-1015	BTK	
1.6 D	08/85-12/96	F8M 720, F8M 730	1596	25.4x153; 02/1988 →		SK-1012	BTK	
1.6 D	08/85-12/96	F8M 720, F8M 730	1596	25.4x153		SK-1015	BTK	
1.7	06/87-03/95	F2N 740, F2N 742	1721	19.05x124; → 12/1987		SK-1010	BTK	
1.7	09/88-09/90	F2N 740	1721	19x125		SK-1011	BTK	
1.7, 1.7 i	10/86-03/95	F3N 702, F3N 722, F3N 716, F3N 717	1721	19.05x124; 02/1987 → 12/1987		SK-1010	BTK	
1.7, 1.7 i	10/86-03/95	F2N 740, F2N 742, F3N 702, F3N 722, F3N 716, F3N 717	1721	19x125; 01/1988 →		SK-1011	BTK	
1.6 D	04/85-12/90	F8M 730	1595	02/1988 →		0-N173	TB [TE]	
1.6 D	04/85-12/90	F8M 730	1595	02/1988 →		0-N854	TB [DG]	
1.6 D	08/85-12/96	F8M 720, F8M 730	1596	02/1988 →		0-N173	TB [TE]	
1.6 D	08/85-12/96	F8M 720, F8M 730	1596	02/1988 →		0-N854	TB [DG]	
1.6 D	08/85-12/96	F8M 720, F8M 730	1596	→ 01/1988		0-N883	TB [TE]	
1.6 D	08/85-12/96	F8M 720, F8M 730	1596	→ 01/1988		0-N887	TB [DG]	
1.7	10/86-03/95	F3N 716, F3N 717	1721	:C016385→		0-N173	TB [TE]	
1.7	10/86-03/95	F3N 716, F3N 717	1721	:C016386→		0-N854	TB [DG]	
1.7	10/86-03/95	F3N 716, F3N 717	1721	:→C016385		0-N856	TB [TE]	
1.7	10/86-03/95	F3N 716, F3N 717	1721	:→C016385		0-N887	TB [DG]	
1.7, 1.7 i	10/86-03/95	F2N 740, F2N 742, F3N 702, F3N 722	1721	02/1988 →		0-N173	TB [TE]	
1.7, 1.7 i	10/86-03/95	F2N 740, F2N 742, F3N 702, F3N 722	1721	02/1988 →		0-N854	TB [DG]	
1.7, 1.7 i	10/86-03/95	F2N 740, F2N 742, F3N 702, F3N 722	1721	→ 01/1988		0-N856	TB [TE]	
1.7, 1.7 i	10/86-03/95	F2N 740, F2N 742, F3N 702, F3N 722	1721	→ 01/1988		0-N887	TB [DG]	
1.6 D	08/85-12/96	F8M 720, F8M 730	1596			0-N141	VB [DG]	
1.7	10/86-03/95	F3N 716, F3N 717	1721	02/1991 →		0-N138	VB [DG]	
1.7	10/86-03/95	F3N 716, F3N 717	1721	→ 01/1991; mit Anbaumaterial, mit Zubehör		0-N1753	VB [DG]	
1.7	06/87-03/95	F2N 740, F2N 742	1721	02/1992 →		0-N138	VB [DG]	
1.7	06/87-03/95	F2N 740, F2N 742	1721	→ 01/1992; mit Anbaumaterial, mit Zubehör		0-N1753	VB [DG]	
1.7 i	10/86-08/91	F3N 702, F3N 722	1721	mit Anbaumaterial, mit Zubehör		0-N1753	VB [DG]	
SUPER 5 Kasten (S40_)								
1.6 D	10/84-12/96	F8M 720	1595	25.4x153; 02/1988 →		SK-1012	BTK	
1.6 D	10/84-12/96	F8M 720	1595	25.4x153		SK-1015	BTK	
1.6 D	10/84-12/96	F8M 720	1595	02/1988 →		0-N173	TB [TE]	
1.6 D	10/84-12/96	F8M 720	1595	02/1988 →		0-N854	TB [DG]	
1.6 D	10/84-12/96	F8M 720	1595			0-N141	VB [DG]	
THALIA I (LB0/1/2_)								
1.2 16V	04/02-	D4F 706, D4F 712	1149	23.4x95; 11/2003 →		SK-1486	BTK	
1.2 16V	04/02-	D4F 706, D4F 712	1149	23.4x95		SK-1486AQ1	BTKW	
1.4	08/00-	K7J 700	1390	17x96; 06/2005 → 11/2009		SK-1338	BTK	
1.4 16V	08/00-	K4J 712	1390	27x132; mit Zubehör		SK-1088	BTK	
1.4 16V	08/00-	K4J 712	1390	27x132; mit Zubehör		SK-1088AQ1	BTKW	
1.5 dCi	06/01-	K9K 702	1461	27x123; 02/2003 →; mit Zubehör		SK-1487	BTK	
1.5 dCi	06/01-10/03	K9K 700, K9K 700, K9K 714, K9K 702, K9K 740	1461	27x123; mit Zubehör		SK-1487AQ1	BTKW	
1.5 dCi	06/01-	K9K 700, K9K 700, K9K 714, K9K 702	1461	27x123; 04/2004 →; mit Zubehör		SK-1487AQ2	BTKW	
1.5 dCi	04/02-	K9K 700	1461	27x123; → 08/2003; mit Zubehör		SK-1487	BTK	
1.5 dCi	02/03-	K9K 700	1461	27x123; 01/2009 →; mit Zubehör		SK-1487	BTK	
1.5 dCi	06/05-	K9K 740	1461	27x123; → 10/2008; mit Zubehör		SK-1487	BTK	
1.5 dCi	06/05-	K9K 740	1461	27x123; mit Zubehör		SK-1487AQ2	BTKW	
1.9 D	02/98-05/01	F8Q 630	1870	25.4x151; beinhaltete Rollen: 3; mit Zahnrad		SK-1108	BTK	
1.9 D	02/98-05/01	F8Q 630	1870	25.4x151; beinhaltete Rollen: 2		SK-1108S	BTK	

CM³

Art. Nr.



ohne Halter

THALIA I (LB0/1/2_)

1.2	02/98-10/03	D7F 744, D7F 746	1149		0-N863	TB [TE]	
1.2 16V	04/02-	D4F 706, D4F 712	1149		0-N1112	TB [TE]	
1.4	08/00-	K7J 700	1390		0-N145	TB [TE]	
1.4 16V	08/00-	K4J 712	1390		0-N198	TB [TE]	
1.4 16V	08/00-	K4J 712	1390		0-N262	TB [DG]	
1.5 dCi	06/01-10/03	K9K 700, K9K 700, K9K 714, K9K 702, K9K 740	1461		0-N1111	TB [TE]	
1.6	03/98-	K7M 746	1598		0-N145	TB [TE]	
1.6 16V	04/02-	K4M 740	1598		0-N198	TB [TE]	
1.6 16V	04/02-	K4M 740	1598		0-N262	TB [DG]	
1.9 D	02/98-05/01	F8Q 630	1870		0-N147	TB [DG]	
1.9 D	02/98-05/01	F8Q 630	1870		0-N173	TB [TE]	
1.9 D	02/98-05/01	F8Q 630	1870		0-N881	TB [DG]	
2.0	09/01-	F4R 738	1998		0-N1259	TB [DG]	
2.0	09/01-	F4R 738	1998		0-N1365	TB [DG]	
2.0	09/01-	F4R 738	1998		0-N200	TB [TE]	
3.0 V6 Turbo Sport	04/00-09/01	L7X 732, L7X 762	2946		0-N1056	TB [TE]	
3.0 V6 Turbo Sport	04/00-09/01	L7X 732, L7X 762	2946		0-N170	TB [DG]	
3.0 V6 Turbo Sport	04/00-09/01	L7X 732, L7X 762	2946		0-N171	TB [DG]	
1.2	02/98-10/03	D7F 744, D7F 746	1149	→ 04/2000	0-N1589	VB [TE]	
1.2	02/98-10/03	D7F 744, D7F 746	1149	→ 04/2000; ⚠, für Fahrzeuge mit Servolenkung	0-N1736	VB [DG]	
1.2	02/98-10/03	D7F 744, D7F 746	1149	04/2000 →	0-N2222	VB [TE]	
1.2 16V	04/02-	D4F 706, D4F 712	1149	⚠, für Fahrzeuge mit Servolenkung	0-N1592	VB [DG]	
1.2 16V	04/02-	D4F 706, D4F 712	1149	⚠, für Fahrzeuge ohne Servolenkung	0-N2222	VB [TE]	
1.4, 1.4 16V	08/00-	K4J 712, K7J 700	1390		0-N1307	VB [DG]	
1.4, 1.4 16V	08/00-	K4J 712, K7J 700	1390	⚠	0-N1314	VB [TE]	
1.4, 1.4 16V	08/00-	K4J 712, K7J 700	1390	⚠	0-N1663	VB [BT]	S
1.5 dCi	06/01-	K9K 700, K9K 700, K9K 714, K9K 702	1461	→ 09/2005; ⚠	0-N1474	VB [BT]	
1.5 dCi	06/01-10/03	K9K 702	1461	⚠	0-N1474	VB [BT]	
1.5 dCi	06/01-10/03	K9K 702	1461	⚠	0-N1476	VB [BT]	S
1.5 dCi	06/01-	K9K 700, K9K 700, K9K 714, K9K 702	1461	01/2005 →; ⚠	0-N1664	VB [BT]	S
1.5 dCi	06/01-	K9K 700, K9K 700, K9K 714, K9K 702, K9K 740	1461	→ 12/2007; Rippenanzahl: 6; ⚠	0-N1898	VB [BT]	S
1.5 dCi	04/02-	K9K 700, K9K 700, K9K 714	1461	→ 01/2005; ⚠	0-N1476	VB [BT]	S
1.5 dCi	04/02-	K9K 700, K9K 700, K9K 714	1461	09/2005 →; ⚠	0-N1664	VB [BT]	S
1.5 dCi	06/05-	K9K 740	1461		0-N1664	VB [BT]	S
1.6, 1.6 16V	03/98-	K4M 740, K7M 746	1598	⚠	0-N1314	VB [TE]	
1.6, 1.6 16V	03/98-	K4M 740, K7M 746	1598	⚠	0-N1663	VB [BT]	S
2.0	09/01-	F4R 738	1998	⚠	0-N1729	VB [DG]	
3.0 V6 Turbo Sport	04/00-09/01	L7X 732, L7X 762	2946		0-N1473	VB [BT]	S

THALIA II (LU1/2_)

1.2 16V	09/08-	D4F728	1149	23.4x95	SK-1486	BTK	
1.2 16V	09/08-	D4F 728	1149	23.4x95	SK-1486AQ1	BTKW	
1.5 dCi	09/08-	K9K 700, K9K 718, K9K 740	1461	27x123; mit Zubehör	SK-1487	BTK	
1.5 dCi	09/08-	K9K 700, K9K 718, K9K 740	1461	27x123; mit Zubehör	SK-1487AQ2	BTKW	
1.5 dCi	11/12-06/14	K9K 612	1461	27x119	SK-1730	BTK	
1.5 dCi	11/12-06/14	K9K 612	1461	27x119	SK-1730AQ1	BTKW	
1.6 16V	09/08-	K4M 743	1598	27x132; mit Zubehör	SK-1088	BTK	
1.6 16V	09/08-	K4M 743	1598	27x132; mit Zubehör	SK-1088AQ1	BTKW	
1.5 dCi	09/08-	K9K 700, K9K 718, K9K 740	1461		0-N1111	TB [TE]	
1.6 16V	09/08-	K4M 743	1598		0-N198	TB [TE]	
1.6 16V	09/08-	K4M 743	1598		0-N262	TB [DG]	
1.2 16V	09/08-	D4F 728	1149	⚠, für Fahrzeuge ohne Servolenkung	0-N2222	VB [TE]	
1.5 dCi	09/08-	K9K 718, K9K 740	1461		0-N1664	VB [BT]	S
1.6 16V	09/08-	K4M 743	1598		0-N1307	VB [DG]	
1.6 16V	09/08-	K4M 743	1598	⚠	0-N1314	VB [TE]	
1.6 16V	09/08-	K4M 743	1598	⚠	0-N1663	VB [BT]	S
1.6 16V	09/08-	K4M 743	1598	Rippenanzahl: 6; ⚠	0-N1898	VB [BT]	S

THALIA III

1.5 dCi	12/13-	K9K 612	1461	27x119	SK-1730	BTK	
1.5 dCi	12/13-	K9K 612	1461	27x119	SK-1730AQ1	BTKW	

TRAFIC Bus (T5, T6, T7)

1.7	06/86-04/89	F1N 724	1721	19.05x124; → 12/1987	SK-1010	BTK	
1.7	06/86-04/89	F1N 724	1721	19x125; 01/1988 →; Baumuster: T1000	SK-1011	BTK	

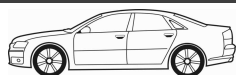

CM³



Art. Nr.



ohne Halter

TRAFIC Bus (T5, T6, T7)							
1.7	06/86-04/89	F1N 724	1721	19x125; Baumuster: T1200	SK-1011	BTK	
2.0	06/86-04/89	J5R 716, J5R 722, J5R 726	1995	19x116	SK-1091	BTK	
2.1 D	03/80-04/89	852 750	2068	25x148; 07/1980 →	SK-1014	BTK	
2.1 D	03/80-04/89	852 750	2068	25x148; 07/1980 →	SK-1063	BTK	
2.1 D 4x4	05/85-02/89	852 750	2068	25x148	SK-1014	BTK	
2.1 D 4x4	05/85-02/89	852 750	2068	25x148	SK-1063	BTK	
1.7	06/86-04/89	F1N 724	1721	02/1988 →	0-N173	TB [TE]	
1.7	06/86-04/89	F1N 724	1721	02/1988 →	0-N854	TB [DG]	
1.7	06/86-04/89	F1N 724	1721	→ 01/1988	0-N856	TB [TE]	
1.7	06/86-04/89	F1N 724	1721	→ 01/1988	0-N887	TB [DG]	
2.0, 2.0 4x4	06/86-04/89	J5R 716, J5R 722, J5R 726	1995		0-N882	TB [TE]	
2.1 D	03/80-04/89	852 750	2068		0-N857	TB [DG]	
2.1 D	03/80-04/89	852 750	2068	mit Anbaumaterial	0-N913	TB [TE]	
TRAFIC Kasten (T1, T3, T4)							
1.7	06/86-04/89	F1N 724	1721	19.05x124; → 12/1987	SK-1010	BTK	
1.7	06/86-04/89	F1N 724	1721	19x125; 01/1988 →; Baumuster: T1000	SK-1011	BTK	
2.0	05/85-04/89	J5R 716, J5R 716, J5R 722, J5R 726	1995	19x116	SK-1091	BTK	
2.1 D, 2.1 D 4x4	09/80-04/89	852 750	2068	25x148	SK-1014	BTK	
2.1 D, 2.1 D 4x4	09/80-04/89	852 750	2068	25x148	SK-1063	BTK	
1.7	06/86-04/89	F1N 724	1721	02/1988 →	0-N173	TB [TE]	
1.7	06/86-04/89	F1N 724	1721	02/1988 →	0-N854	TB [DG]	
1.7	06/86-04/89	F1N 724	1721	→ 01/1988	0-N856	TB [TE]	
1.7	06/86-04/89	F1N 724	1721	→ 01/1988	0-N887	TB [DG]	
2.0, 2.0 4x4	06/86-04/89	J5R 716, J5R 722, J5R 726	1995		0-N882	TB [TE]	
2.1 D, 2.1 D 4x4	09/80-04/89	852 750	2068		0-N857	TB [DG]	
2.1 D, 2.1 D 4x4	09/80-04/89	852 750	2068	mit Anbaumaterial	0-N913	TB [TE]	
TRAFIC Pritsche/Fahrgestell (P6)							
1.7	06/86-04/89	F1N 722	1721	19.05x124; → 12/1987	SK-1010	BTK	
1.7	06/86-04/89	F1N 722	1721	19x125; 01/1988 →; Baumuster: T1000	SK-1011	BTK	
2.0	03/80-04/89	J5R 726	1995	19x116; 07/1980 →	SK-1091	BTK	
2.1 D	03/80-04/89	852 720	2068	25x148; 10/1980 → 03/1989	SK-1014	BTK	
2.1 D	03/80-04/89	852 720	2068	25x148; 03/1989 →	SK-1063	BTK	
2.1 D, 2.1 D 4x4	07/80-02/89	852 750, J8S 750	2068	25x148	SK-1014	BTK	
2.1 D, 2.1 D 4x4	07/80-02/89	852 750, J8S 750	2068	25x148	SK-1063	BTK	
2.5 D	03/80-04/89	8140.61.240, S8U 720, S8U 722	2445	30x152; 10/1980 →	SK-1657	BTK	
1.7	06/86-04/89	F1N 722	1721	02/1988 →	0-N173	TB [TE]	
1.7	06/86-04/89	F1N 722	1721	02/1988 →	0-N854	TB [DG]	
1.7	06/86-04/89	F1N 722	1721	→ 01/1988	0-N856	TB [TE]	
1.7	06/86-04/89	F1N 722	1721	→ 01/1988	0-N887	TB [DG]	
2.0	03/80-04/89	829 720, 829 721, J5R 726	1995		0-N882	TB [TE]	
2.1 D	03/80-04/89	852 720	2068		0-N857	TB [DG]	
2.1 D	03/80-04/89	852 720	2068	mit Anbaumaterial	0-N913	TB [TE]	
2.5 D	03/80-04/89	8140.61.240, S8U 720, S8U 722	2445		0-N1617	TB [BT]	
2.5 D	03/80-04/89	8140.61.240, S8U 720, S8U 722	2445		0-N816	TB [DG]	
2.5 D	03/80-04/89	8140.61.240, S8U 720, S8U 722	2445		0-N821	TB [DG]	
TRAFIC Bus (TXW)							
1.7	08/92-08/94	F1N 724	1721	19x125; Baumuster: T1100	SK-1011	BTK	
1.9 D	06/97-03/01	F8Q 606	1870	25.4x153	SK-1083	BTK	
1.9 D	06/97-03/01	F8Q 606	1870	25.4x153	SK-1107	BTK	
2.1 D	06/94-10/97	J8S 620, J8S 758	2068	25x148; 09/1994 →	SK-1014	BTK	
2.1 D	06/94-10/97	J8S 758	2068	25x148	SK-1063	BTK	
2.2	05/89-10/97	J7T 600, J7T 780	2165	19x118; Baumuster: T1100	SK-1092	BTK	
2.2 4x4	05/89-06/94	J7T 780	2165	19x118; 07/1991 →	SK-1092	BTK	
2.2 4x4	06/94-10/97	J7T 600	2165	19x118	SK-1092	BTK	
2.5 D	05/89-03/01	8140.67.2500, 8140.67.2550, 8140.67.2580, S8U 750, S8U 752, S8U 758	2499	30x152; → 09/1990	SK-1657	BTK	
2.5 D, 2.5 D 4x4	05/89-03/01	8140.67.2500, 8140.67.2550, 8140.67.2580, S8U 750, S8U 752, S8U 758	2499	30x152; :1307401→	SK-1035	BTK	
1.7	08/92-08/94	F1N 724	1721		0-N173	TB [TE]	
1.7	08/92-08/94	F1N 724	1721		0-N854	TB [DG]	
1.9 D	06/97-03/01	F8Q 606	1870		0-N147	TB [DG]	
1.9 D	06/97-03/01	F8Q 606	1870		0-N173	TB [TE]	
1.9 D	06/97-03/01	F8Q 606	1870		0-N854	TB [DG]	
2.0	05/89-08/90	J5R 726	1995		0-N882	TB [TE]	
2.1 D	05/89-10/97	852 720, 852 750, J8S 620, J8S 758	2068		0-N857	TB [DG]	



CM³



Art. Nr.



TRAFIC Bus (TXW)							
2.1 D	05/89-10/97	852 720, 852 750, J8S 620, J8S 758	2068	mit Anbaumaterial		0-N913	TB [TE]
2.2, 2.2 4x4	05/89-10/97	J7T 600, J7T 780	2165			0-N882	TB [TE]
2.5 D, 2.5 D 4x4	05/89-03/01	8140.67.2500, 8140.67.2550, 8140.67.2580, S8U 750, S8U 752, S8U 758	2499			0-N1617	TB [BT]
2.5 D, 2.5 D 4x4	05/89-03/01	8140.67.2500, 8140.67.2550, 8140.67.2580, S8U 750, S8U 752, S8U 758	2499			0-N816	TB [DG]
2.5 D, 2.5 D 4x4	05/89-03/01	8140.67.2500, 8140.67.2550, 8140.67.2580, S8U 750, S8U 752, S8U 758	2499			0-N821	TB [DG]

TRAFIC Kasten (TXX)							
1.7	03/89-08/94	F1N 724	1721	19x125		SK-1011	BTK
1.7	08/92-08/94	F1N 720	1721	19x125; Baumuster: T1100		SK-1011	BTK
1.9 D	06/97-03/01	F8Q 606	1870	25.4x153		SK-1083	BTK
1.9 D	06/97-03/01	F8Q 606	1870	25.4x153		SK-1107	BTK
2.1 D	05/89-06/94	852 750	2068	25x148		SK-1014	BTK
2.1 D	05/89-06/94	852 750	2068	25x148		SK-1063	BTK
2.1 D	06/94-10/97	J8S 620, J8S 758	2068	25x148; 09/1994 →		SK-1014	BTK
2.1 D	06/94-10/97	J8S 758	2068	25x148		SK-1063	BTK
2.2	05/89-06/94	J7T 780	2165	19x118; Baumuster: T1100		SK-1092	BTK
2.2	06/94-10/97	J7T 600	2165	19x118; Baumuster: T1100, T1400, T900		SK-1092	BTK
2.2 4x4	05/89-06/94	J7T 780	2165	19x118; 07/1991 →		SK-1092	BTK
2.2 4x4	06/94-10/97	J7T 600	2165	19x118		SK-1092	BTK
2.5 D, 2.5 D 4x4	05/89-03/01	8140.67.2500, 8140.67.2550, 8140.67.2580, S8U 750, S8U 752, S8U 758, 8140.67.2500, 8140.67.2580, S8U 750, S8U 752	2499	30x152; :1307401→		SK-1035	BTK
2.5 D, 2.5 D 4x4	05/89-03/01	8140.67.2500, 8140.67.2550, 8140.67.2580, S8U 750, S8U 752, S8U 758, 8140.67.2500, 8140.67.2580, S8U 750, S8U 752	2499	30x152; → 09/1990		SK-1657	BTK
1.7	08/92-08/94	F1N 720	1721			0-N173	TB [TE]
1.7	08/92-08/94	F1N 720	1721			0-N854	TB [DG]
1.9 D	06/97-03/01	F8Q 606	1870			0-N147	TB [DG]
1.9 D	06/97-03/01	F8Q 606	1870			0-N173	TB [TE]
1.9 D	06/97-03/01	F8Q 606	1870			0-N854	TB [DG]
2.0	05/89-08/90	J5R 716	1995			0-N882	TB [TE]
2.1 D	05/89-10/97	852 750, J8S 620, J8S 758	2068			0-N857	TB [DG]
2.1 D	05/89-10/97	852 750, J8S 620, J8S 758	2068	mit Anbaumaterial		0-N913	TB [TE]
2.2, 2.2 4x4	05/89-10/97	J7T 600, J7T 780	2165			0-N882	TB [TE]
2.5 D, 2.5 D 4x4	05/89-03/01	8140.67.2500, 8140.67.2550, 8140.67.2580, S8U 750, S8U 752, S8U 758, 8140.67.2500, 8140.67.2580, S8U 750, S8U 752	2499			0-N1617	TB [BT]
2.5 D, 2.5 D 4x4	05/89-03/01	8140.67.2500, 8140.67.2550, 8140.67.2580, S8U 750, S8U 752, S8U 758, 8140.67.2500, 8140.67.2580, S8U 750, S8U 752	2499			0-N816	TB [DG]
2.5 D, 2.5 D 4x4	05/89-03/01	8140.67.2500, 8140.67.2550, 8140.67.2580, S8U 750, S8U 752, S8U 758, 8140.67.2500, 8140.67.2580, S8U 750, S8U 752	2499			0-N821	TB [DG]

TRAFIC Pritsche/Fahrgestell (PXX)							
1.7	05/89-08/94	F1N 722	1721	19x125		SK-1011	BTK
2.0 [RWD]	05/89-10/97	J5R 726	1995	19x116		SK-1091	BTK
2.1 D [RWD]	06/94-10/97	J8S 620, J8S 758	2068	25x148; 09/1994 →		SK-1014	BTK
2.1 D [RWD]	06/94-10/97	J8S 620	2068	25x148		SK-1063	BTK
2.1 D, 2.1 D [RWD]	05/89-04/98	852 720, J8S 620	2068	25x148		SK-1014	BTK
2.1 D, 2.1 D [RWD]	05/89-04/98	852 720, J8S 620	2068	25x148		SK-1063	BTK
2.2	05/89-06/94	J7T 780	2165	19x118; 07/1991 →		SK-1092	BTK
2.2	09/94-04/98	J7T 600	2165	19x118; Baumuster: T1400		SK-1092	BTK
2.2 4x4	09/94-04/98	J7T 600	2165	19x118; → 10/1997		SK-1092	BTK
2.5 D	05/89-03/01	8140.61.240, S8U 720, S8U 722	2445	30x152; :1307401→		SK-1035	BTK
2.5 D	05/89-03/01	8140.61.240, S8U 720, S8U 722	2445	30x152		SK-1657	BTK
2.5 D, 2.5 D 4x4	03/89-03/01	S8U 750, S8U 758, S8U 758, S8U 780	2499	30x152		SK-1035	BTK
2.5 D, 2.5 D 4x4	03/89-08/94	S8U 750	2499	30x152; → 09/1990		SK-1657	BTK
1.7	05/89-08/94	F1N 722	1721			0-N173	TB [TE]
1.7	05/89-08/94	F1N 722	1721			0-N854	TB [DG]
2.0 [RWD]	05/89-10/97	J5R 726	1995			0-N882	TB [TE]
2.1 D [RWD]	05/89-10/97	852 720, J8S 620, J8S 758	2068			0-N857	TB [DG]
2.1 D [RWD]	05/89-10/97	852 720, J8S 620, J8S 758	2068	mit Anbaumaterial		0-N913	TB [TE]

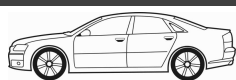

CM³



Art. Nr.



ohne Halter

TRAFIC Pritsche/Fahrgestell (PXX)

2.2, 2.2 4x4	09/94-04/98	J7T 600	2165		0-N882	TB [TE]	
2.5 D	05/89-03/01	8140.61.240, S8U 720, S8U 722	2445		0-N1617	TB [BT]	
2.5 D	05/89-03/01	8140.61.240, S8U 720, S8U 722	2445		0-N816	TB [DG]	
2.5 D	05/89-03/01	8140.61.240, S8U 720, S8U 722	2445		0-N821	TB [DG]	
2.5 D, 2.5 D 4x4	09/94-03/01	S8U 758, S8U 758, S8U 780	2499		0-N816	TB [DG]	
2.5 D, 2.5 D 4x4	09/94-03/01	S8U 758, S8U 758, S8U 780	2499		0-N821	TB [DG]	

TRAFIC II Bus (JL)

1.9 dCi 80	03/01-	F9Q 762	1870	26x132; 08/2003 →	SK-1493	BTK	
1.9 dCi, 1.9 dCi 100	03/01-07/03	F9Q 760, F9Q 762	1870	26x132	SK-1493	BTK	
1.9 dCi, 1.9 dCi 100, 1.9 dCi 80	03/01-07/03	F9Q 760, F9Q 762	1870	26x132	SK-1493AQ1	BTKW	
1.9 dCi, 1.9 dCi 100, 1.9 dCi 80	03/01-07/03	F9Q 760, F9Q 762	1870	26x132	SK-1493AQ2	BTKW	
2.5 dCi 115, 2.5 dCi 135, 2.5 dCi 145	05/03-	G9U 630, G9U 730	2464	25x89; mit Zubehör	SK-1489	BTK	
2.5 DTi	03/03-07/03	G9U 730	2463	25x89; mit Zubehör	SK-1489	BTK	
1.9 dCi, 1.9 dCi 100, 1.9 dCi 80	03/01-07/03	F9Q 760, F9Q 762	1870	mit Grundträger	0-N1173	TB [BT]	
2.0	03/01-	F4R 720, F4R 722	1998	04/2001 →	0-N1365	TB [DG]	
2.0	03/01-	F4R 720, F4R 722	1998	→ 04/2001	0-N262	TB [DG]	
2.0 16V	08/06-	F4R 820	1998		0-N1365	TB [DG]	
2.5 dCi 115, 2.5 dCi 135, 2.5 dCi 145	05/03-	G9U 630, G9U 730	2464		0-N1269	TB [TE]	
2.5 dCi 115, 2.5 dCi 135, 2.5 dCi 145	05/03-	G9U 630, G9U 730	2464		0-N1270	TB [DG]	
2.5 DTi	03/03-07/03	G9U 730	2463		0-N1269	TB [TE]	
2.5 DTi	03/03-07/03	G9U 730	2463		0-N1270	TB [DG]	
1.9 dCi 100, 1.9 dCi 80	03/01-	F9Q 760, F9Q 762	1870	→ 03/2002	0-N1307	VB [DG]	
1.9 dCi 100, 1.9 dCi 80	03/01-	F9Q 760, F9Q 762	1870	☼	0-N1802	VB [BT]	S
1.9 dCi, 1.9 dCi 100, 1.9 dCi 80	03/01-07/03	F9Q 760, F9Q 762	1870	03/2002 →; ☼	0-N1409	VB [DG]	
1.9 dCi, 1.9 dCi 100, 1.9 dCi 80	03/01-07/03	F9Q 760, F9Q 762	1870	☼	0-N1611	VB [BT]	S
2.0	03/01-	F4R 720, F4R 722	1998	→ 02/2009; ☼	0-N1802	VB [BT]	S
2.0, 2.0 16V	03/01-	F4R 720, F4R 722, F4R 820	1998	☼	0-N1409	VB [DG]	
2.0, 2.0 16V	03/01-	F4R 720, F4R 722, F4R 820	1998	☼	0-N1611	VB [BT]	S
2.0 16V	08/06-	F4R 820	1998	☼	0-N1802	VB [BT]	S
2.0 dCi 115, 2.0 dCi 90	08/06-	M9R 630, M9R 692, M9R 780, M9R 782, M9R 786, M9R 782	1995		0-N1739	VB [DG]	
2.0 dCi 115, 2.0 dCi 90	08/06-	M9R 630, M9R 692, M9R 780, M9R 782, M9R 786, M9R 782	1995		0-N2039	VB [BT]	S
2.5 dCi 115	02/08-	G9U 630	2464	→ 09/2010; für Fahrzeuge mit Nebenantrieb, ☼	0-N1739	VB [DG]	
2.5 dCi 115, 2.5 dCi 135, 2.5 dCi 145	05/03-	G9U 630, G9U 730	2464		0-N1409	VB [DG]	
2.5 dCi 115, 2.5 dCi 135, 2.5 dCi 145	05/03-	G9U 630, G9U 730	2464		0-N1731	VB [BT]	S
2.5 dCi 115, 2.5 dCi 135, 2.5 dCi 145	05/03-	G9U 630, G9U 730	2464	09/2010 →; ☼	0-N1739	VB [DG]	
2.5 dCi 115, 2.5 dCi 135, 2.5 dCi 145	05/03-	G9U 630, G9U 730	2464	☼, für Fahrzeuge ohne Nebenantrieb	0-N1875	VB [BT]	S
2.5 dCi 135, 2.5 dCi 145	05/03-	G9U 630, G9U 730	2464	09/2010 →; für Fahrzeuge mit Nebenantrieb, ☼	0-N1739	VB [DG]	
2.5 DTi	03/03-07/03	G9U 730	2463		0-N1409	VB [DG]	
2.5 DTi	03/03-07/03	G9U 730	2463		0-N1731	VB [BT]	S

TRAFIC II Kasten (FL)

1.9 dCi 80	03/01-	F9Q 762	1870	26x132	SK-1493	BTK	
1.9 dCi 80	03/01-	F9Q 760, F9Q 762	1870	26x132	SK-1493AQ1	BTKW	
1.9 dCi 80	03/01-	F9Q 760, F9Q 762	1870	26x132	SK-1493AQ2	BTKW	
1.9 dCi, 1.9 dCi 100	03/01-07/03	F9Q 760, F9Q 762	1870	26x132	SK-1493	BTK	
1.9 dCi, 1.9 dCi 100	03/01-07/03	F9Q 760, F9Q 762	1870	26x132	SK-1493AQ1	BTKW	
1.9 dCi, 1.9 dCi 100	03/01-07/03	F9Q 760, F9Q 762	1870	26x132	SK-1493AQ2	BTKW	
2.5 dCi 135, 2.5 dCi 145	05/03-	G9U 630, G9U 730	2464	25x89; mit Zubehör	SK-1489	BTK	
2.5 DTi	03/03-07/03	G9U 730	2463	25x89; mit Zubehör	SK-1489	BTK	
1.9 dCi, 1.9 dCi 100, 1.9 dCi 80	03/01-07/03	F9Q 760, F9Q 760, F9Q 762, F9Q 762	1870	mit Grundträger	0-N1173	TB [BT]	
2.0	03/01-	F4R 720, F4R 722	1998	04/2001 →	0-N1365	TB [DG]	
2.0	03/01-	F4R 720, F4R 722	1998	→ 04/2001	0-N262	TB [DG]	
2.0 16V	08/06-	F4R 820	1998		0-N1365	TB [DG]	
2.5 dCi 135, 2.5 dCi 145	05/03-	G9U 630, G9U 730	2464		0-N1269	TB [TE]	
2.5 dCi 135, 2.5 dCi 145	05/03-	G9U 630, G9U 730	2464		0-N1270	TB [DG]	
2.5 DTi	03/03-07/03	G9U 730	2463		0-N1269	TB [TE]	
2.5 DTi	03/03-07/03	G9U 730	2463		0-N1270	TB [DG]	
1.9 dCi 100, 1.9 dCi 80	03/01-	F9Q 760, F9Q 760, F9Q 762	1870	→ 03/2002	0-N1307	VB [DG]	
1.9 dCi 100, 1.9 dCi 80	03/01-	F9Q 760, F9Q 760, F9Q 762	1870	☼	0-N1802	VB [BT]	S
1.9 dCi, 1.9 dCi 100, 1.9 dCi 80	03/01-07/03	F9Q 760, F9Q 760, F9Q 762, F9Q 762	1870	03/2002 →; ☼	0-N1409	VB [DG]	
1.9 dCi, 1.9 dCi 100, 1.9 dCi 80	03/01-07/03	F9Q 760, F9Q 760, F9Q 762, F9Q 762	1870	☼	0-N1611	VB [BT]	S
2.0, 2.0 16V	03/01-	F4R 720, F4R 722, F4R 820	1998	☼	0-N1409	VB [DG]	



CM³



Art. Nr.



TRAFIC II Kasten (FL)								
2.0, 2.0 16V	03/01-	F4R 720, F4R 722, F4R 820	1998	☼		0-N1611	VB [BT]	S
2.0, 2.0 16V	03/01-	F4R 720, F4R 722, F4R 820	1998	☼		0-N1802	VB [BT]	S
2.0 dCi 115, 2.0 dCi 90	08/06-	M9R 630, M9R 780, M9R 782, M9R 692, M9R 780, M9R 782, M9R 786	1995			0-N1739	VB [DG]	
2.0 dCi 115, 2.0 dCi 90	08/06-	M9R 630, M9R 780, M9R 782, M9R 692, M9R 780, M9R 782, M9R 786	1995			0-N2039	VB [BT]	S
2.5 dCi 135, 2.5 dCi 145	05/03-	G9U 630, G9U 730	2464			0-N1409	VB [DG]	
2.5 dCi 135, 2.5 dCi 145	05/03-	G9U 630, G9U 730	2464			0-N1731	VB [BT]	S
2.5 dCi 135, 2.5 dCi 145	05/03-	G9U 630, G9U 730	2464	☼	09/2010 →; für Fahrzeuge mit Nebenantrieb,	0-N1739	VB [DG]	
2.5 dCi 135, 2.5 dCi 145	05/03-	G9U 630, G9U 730	2464	☼	09/2010 →; ☼	0-N1739	VB [DG]	
2.5 dCi 135, 2.5 dCi 145	05/03-	G9U 630, G9U 730	2464	☼	☼, für Fahrzeuge ohne Nebenantrieb	0-N1875	VB [BT]	S
2.5 DTi	03/03-07/03	G9U 730	2463			0-N1409	VB [DG]	
2.5 DTi	03/03-07/03	G9U 730	2463			0-N1731	VB [BT]	S

TRAFIC II Pritsche/Fahrgestell (EL)								
1.9 dCi	09/01-07/03	F9Q 762	1870		26x132	SK-1493	BTK	
1.9 dCi 100	03/01-	F9Q 760	1870		26x132; 09/2001 →	SK-1493	BTK	
1.9 dCi 80	03/01-	F9Q 762	1870		26x132; 08/2003 →	SK-1493	BTK	
1.9 dCi, 1.9 dCi 100, 1.9 dCi 80	03/01-07/03	F9Q 760, F9Q 762	1870		26x132	SK-1493AQ1	BTKW	
1.9 dCi, 1.9 dCi 100, 1.9 dCi 80	03/01-07/03	F9Q 760, F9Q 762	1870		26x132	SK-1493AQ2	BTKW	
2.5 dCi	08/07-	G9U 630	2463		25x89; mit Zubehör	SK-1489	BTK	
2.5 dCi 135	03/01-	G9U 730	2463		25x89; 03/2003 →; mit Zubehör	SK-1489	BTK	
2.5 dCi 145	08/06-	G9U 630	2464		25x89; mit Zubehör	SK-1489	BTK	
1.9 dCi, 1.9 dCi 100, 1.9 dCi 80	03/01-07/03	F9Q 760, F9Q 762	1870		mit Grundträger	0-N1173	TB [BT]	
2.0	03/01-	F4R 720	1998		04/2001 →	0-N1365	TB [DG]	
2.0	03/01-	F4R 720	1998		→ 04/2001	0-N262	TB [DG]	
2.5 dCi 145	08/06-	G9U 630	2464			0-N1269	TB [TE]	
2.5 dCi 145	08/06-	G9U 630	2464			0-N1270	TB [DG]	
2.5 dCi, 2.5 dCi 135	03/01-	G9U 630, G9U 730	2463			0-N1269	TB [TE]	
2.5 dCi, 2.5 dCi 135	03/01-	G9U 630, G9U 730	2463			0-N1270	TB [DG]	
1.9 dCi 100, 1.9 dCi 80	03/01-	F9Q 760, F9Q 762	1870		→ 03/2002	0-N1307	VB [DG]	
1.9 dCi 100, 1.9 dCi 80	03/01-	F9Q 760, F9Q 762	1870		☼	0-N1802	VB [BT]	S
1.9 dCi, 1.9 dCi 100, 1.9 dCi 80	03/01-07/03	F9Q 760, F9Q 762	1870		03/2002 →; ☼	0-N1409	VB [DG]	
1.9 dCi, 1.9 dCi 100, 1.9 dCi 80	03/01-07/03	F9Q 760, F9Q 762	1870		☼	0-N1611	VB [BT]	S
2.0	03/01-	F4R 720	1998		☼	0-N1409	VB [DG]	
2.0	03/01-	F4R 720	1998		☼	0-N1611	VB [BT]	S
2.0	03/01-	F4R 720	1998		☼	0-N1802	VB [BT]	S
2.0 dCi 115, 2.0 dCi 90	08/06-	M9R 780, M9R 782, M9R 780, M9R 782, M9R 786	1995			0-N1739	VB [DG]	
2.0 dCi 115, 2.0 dCi 90	08/06-	M9R 780, M9R 782, M9R 780, M9R 782, M9R 786	1995			0-N2039	VB [BT]	S
2.5 dCi 135	03/01-	G9U 730	2463		☼, für Fahrzeuge ohne Nebenantrieb	0-N1875	VB [BT]	S
2.5 dCi 145	08/06-	G9U 630	2464			0-N1409	VB [DG]	
2.5 dCi 145	08/06-	G9U 630	2464			0-N1731	VB [BT]	S
2.5 dCi 145	08/06-	G9U 630	2464	☼	09/2010 →; für Fahrzeuge mit Nebenantrieb,	0-N1739	VB [DG]	
2.5 dCi 145	08/06-	G9U 630	2464	☼	09/2010 →; ☼	0-N1739	VB [DG]	
2.5 dCi 145	08/06-	G9U 630	2464	☼	☼, für Fahrzeuge ohne Nebenantrieb	0-N1875	VB [BT]	S
2.5 dCi, 2.5 dCi 135	03/01-	G9U 630, G9U 730	2463			0-N1409	VB [DG]	
2.5 dCi, 2.5 dCi 135	03/01-	G9U 630, G9U 730	2463			0-N1731	VB [BT]	S
2.5 dCi, 2.5 dCi 135	03/01-	G9U 630, G9U 730	2463	☼	09/2010 →; für Fahrzeuge mit Nebenantrieb,	0-N1739	VB [DG]	
2.5 dCi, 2.5 dCi 135	03/01-	G9U 630, G9U 730	2463	☼	09/2010 →; ☼	0-N1739	VB [DG]	

TWINGO I (C06_)								
1.2	05/96-	D7F700, D7F701	1149		17x87; Baumuster: C066	SK-1081	BTK	
1.2	05/96-08/00	D7F 700, D7F 701, D7F 702, D7F 703, D7F 704	1149		17x87	SK-1081	BTK	
1.2	05/96-	D7F 700, D7F 701, D7F 700, D7F 701, D7F 702, D7F 703, D7F 704	1149		17x87	SK-1081AQ2	BTKW	
1.2	05/96-	D7F 700, D7F 701, D7F 700, D7F 701, D7F 702, D7F 703, D7F 704	1149		23.4x95; 05/2002 →	SK-1486	BTK	
1.2	05/96-	D7F 700, D7F 701, D7F 700, D7F 701, D7F 702, D7F 703, D7F 704	1149		23.4x95; 05/2002 →	SK-1486AQ1	BTKW	
1.2 16V	01/01-	D4F702	1149		23.4x95; Baumuster: C06C	SK-1486	BTK	
1.2 16V	01/01-	D4F 702	1149		23.4x95	SK-1486AQ1	BTKW	
1.2 16V	08/04-06/07	D4F 708	1149		17x87; Baumuster: C06Y	SK-1081	BTK	
1.2 16V	08/04-06/07	D4F 708	1149		23.4x95	SK-1486	BTK	



CM³



Art. Nr.



ohne Halter

TWINGO I (C06_)							
1.2	05/96-08/00	D7F 700, D7F 701, D7F 700, D7F 701, D7F 702, D7F 703, D7F 704, D7F 702, D7F 703, D7F 704	1149			0-N863	TB [TE]
1.2 16V	01/01-06/07	D4F 702, D4F 708	1149			0-N1112	TB [TE]
1.2	03/93-10/96	C3G 700, C3G 702	1239	☼		0-N135	VB [TE]
1.2	03/93-10/96	C3G 700, C3G 702	1239	☼		0-N2343	VB [DG]
1.2	05/96-	D7F 700, D7F 701, D7F 700, D7F 701, D7F 702, D7F 703, D7F 704	1149		→ 04/2000; ☼	0-N1589	VB [TE]
1.2	05/96-	D7F 700, D7F 701, D7F 700, D7F 701, D7F 702, D7F 703, D7F 704	1149		04/2000 →; ☼, für Fahrzeuge mit Servolenkung	0-N1592	VB [DG]
1.2	05/96-	D7F 700, D7F 701, D7F 700, D7F 701, D7F 702, D7F 703, D7F 704	1149		→ 04/2000; ☼	0-N1736	VB [DG]
1.2	05/96-	D7F 700, D7F 701, D7F 700, D7F 701, D7F 702, D7F 703, D7F 704	1149		04/2000 →; ☼	0-N2222	VB [TE]
1.2	09/98-08/00	D7F 702	1149		→ 04/2000; ☼	0-N1589	VB [TE]
1.2	09/98-08/00	D7F 702	1149		→ 04/2000; ☼	0-N1736	VB [DG]
1.2	09/98-08/00	D7F 702	1149		04/2000 →; ☼	0-N2222	VB [TE]
1.2	09/98-08/00	D7F 703, D7F 704	1149		☼	0-N2222	VB [TE]
1.2 16V	01/01-06/07	D4F 702, D4F 708	1149		☼	0-N2222	VB [TE]
1.2 16V	08/04-06/07	D4F 708	1149		☼, für Fahrzeuge mit Servolenkung	0-N1592	VB [DG]
1.2	03/93-10/96	C3G 700, C3G 702	1239		☼	0-N134	FB [TE]

TWINGO I Kasten (S06_)							
1.2	05/96-	D7F 700, D7F 702	1149	17x87		SK-1081	BTK
1.2	05/96-	D7F 700, D7F 701, D7F 702, D7F 703, D7F 704, D7F 706	1149	17x87		SK-1081AQ2	BTKW
1.2	05/96-	D7F 700, D7F 701, D7F 702, D7F 703, D7F 704, D7F 706	1149	23.4x95; 05/2002 →		SK-1486	BTK
1.2	05/96-	D7F 700, D7F 701, D7F 702, D7F 703, D7F 704, D7F 706	1149	23.4x95; 05/2002 →		SK-1486AQ1	BTKW
1.2	05/96-	D7F 700, D7F 701, D7F 702, D7F 703, D7F 704, D7F 706	1149			0-N863	TB [TE]
1.2	03/93-05/96	C3G 700, C3G 702	1239	☼		0-N2343	VB [DG]
1.2	05/96-	D7F 700, D7F 701, D7F 702, D7F 703, D7F 704, D7F 706	1149		→ 04/2000; ☼	0-N1589	VB [TE]
1.2	05/96-	D7F 700, D7F 701, D7F 702, D7F 703, D7F 704, D7F 706	1149		→ 04/2000; ☼	0-N1736	VB [DG]
1.2	05/96-	D7F 700, D7F 701, D7F 702, D7F 703, D7F 704, D7F 706	1149		04/2000 →; ☼	0-N2222	VB [TE]

TWINGO II (CN0_)							
1.2	03/07-	D7F 800	1149	17x87		SK-1081	BTK
1.2	03/07-	D7F 800	1149	17x87		SK-1081AQ3	BTKW
1.2 16V	03/07-	D4F 772	1149	23.4x95; 04/2008 →		SK-1486	BTK
1.2 16V	03/07-	D4F 772	1149	23.4x95; 04/2008 →		SK-1486AQ1	BTKW
1.2 16V, 1.2 TCe 100	03/07-	D4F 764, D4F 770, D4F 772, D4F 780, D4F 782	1149	23.4x95		SK-1486	BTK
1.2 16V, 1.2 TCe 100, 1.2 Turbo	03/07-	D4F 764, D4F 770, D4F 772, D4F 780, D4F 782	1149	23.4x95		SK-1486AQ1	BTKW
1.2 Turbo	03/07-	D4F 780, D4F 782	1149	23.4x95; 08/2007 →		SK-1486	BTK
1.5 dCi	03/07-	K9K 718, K9K 740	1461	27x123; mit Zubehör		SK-1487AQ2	BTKW
1.5 dCi, 1.5 dCi 75, 1.5 dCi 90	03/07-	K9K 718, K9K 740, K9K 820, K9K 820, K9K 830	1461	27x123; mit Zubehör		SK-1487	BTK
1.5 dCi 75, 1.5 dCi 90	10/10-	K9K 820, K9K 820, K9K 830	1461	27x123; mit Zubehör		SK-1487AQ3	BTKW
1.6 RS	05/08-	K4M 854	1598	27x132		SK-1630	BTK
1.2	03/07-	D7F 800	1149			0-N863	TB [TE]
1.2 16V, 1.2 Turbo	03/07-	D4F 772, D4F 780, D4F 782	1149			0-N1112	TB [TE]
1.5 dCi, 1.5 dCi 75, 1.5 dCi 90	03/07-	K9K 718, K9K 740, K9K 820, K9K 820, K9K 830	1461			0-N1111	TB [TE]
1.6 RS	05/08-	K4M 854	1598	→ 09/2009		0-N262	TB [DG]
1.2, 1.2 16V, 1.2 Turbo	03/07-	D4F 772, D4F 780, D4F 782, D7F 800	1149			0-N1743	VB [DG]
1.5 dCi	03/07-	K9K 740	1461	→ 12/2007; Rippenanzahl: 6; ☼		0-N1898	VB [BT] S
1.5 dCi	03/07-	K9K 740	1461	12/2007 →; ☼		0-N2253	VB [DG]
1.5 dCi, 1.5 dCi 75, 1.5 dCi 90	03/07-	K9K 718, K9K 740, K9K 820, K9K 820, K9K 830	1461			0-N1664	VB [BT] S
1.5 dCi 75	10/10-	K9K 820	1461	☼		0-N2253	VB [DG]
1.6 RS	05/08-	K4M 854	1598			0-N1664	VB [BT] S
1.6 RS	05/08-	K4M 854	1598	☼		0-N2253	VB [DG]

VEL SATIS (BJ0_)							
2.0 16 V Turbo	04/04-	F4R 766, F4R 767	1998	27x126; Baumuster: BJ0W		SK-1624	BTK
2.0 16 V Turbo, 2.0 16V Turbo	06/02-	F4R 762, F4R 763, F4R 766, F4R 767	1998	27x126		SK-1624AQ1	BTKW



CM³



Art. Nr.



ohne Halter

VEL SATIS (BJ0_)

2.0 16V Turbo	06/02-	F4R 762, F4R 763	1998	27x126; Baumuster: BJ0K, BJ0P	SK-1624	BTK
2.0 Turbo	04/05-	F4R 867	1998	27x126	SK-1624	BTK
2.2 dCi	06/02-	G9T 600, G9T 702, G9T 703	2188	25x89; mit Zubehör	SK-1489	BTK
2.2 dCi	09/04-	G9T 600, G9T 606, G9T 607, G9T 700, G9T 702	2188	25x89; → 08/2009; mit Zubehör	SK-1489	BTK
3.0 dCi	06/02-	P9X 701, P9X 715	2958	25x116	SK-1611	BTK
2.0 16 V Turbo, 2.0 16V Turbo , 2.0 Turbo	06/02-	F4R 762, F4R 763, F4R 766, F4R 767, F4R 867	1998		0-N1365	TB [DG]
2.0 16 V Turbo, 2.0 16V Turbo , 2.0 Turbo	06/02-	F4R 762, F4R 763, F4R 766, F4R 767, F4R 867	1998		0-N200	TB [TE]
2.2 dCi	06/02-	G9T 600, G9T 600, G9T 606, G9T 607, G9T 700, G9T 702, G9T 702, G9T 703	2188		0-N1269	TB [TE]
2.2 dCi	06/02-	G9T 600, G9T 600, G9T 606, G9T 607, G9T 700, G9T 702, G9T 702, G9T 703	2188		0-N1270	TB [DG]
3.0 dCi	06/02-	P9X 701, P9X 715	2958		0-N1353	TB [TE]
3.0 dCi	06/02-	P9X 701, P9X 715	2958		0-N1354	TB [DG]
3.0 dCi	06/02-	P9X 701, P9X 715	2958		0-N1355	TB [DG]
2.0 16 V Turbo, 2.0 16V Turbo , 2.0 Turbo	06/02-	F4R 762, F4R 763, F4R 766, F4R 767, F4R 867	1998	✳	0-N1409	VB [DG]
2.0 16 V Turbo, 2.0 16V Turbo , 2.0 Turbo	06/02-	F4R 762, F4R 763, F4R 766, F4R 767, F4R 867	1998	✳	0-N1611	VB [BT] S
2.0 dCi	08/05-	M9R 760, M9R 760, M9R 762, M9R 763	1995		0-N1739	VB [DG]
2.0 dCi	08/05-	M9R 760, M9R 760, M9R 762, M9R 763	1995		0-N2039	VB [BT] S
2.2 dCi	06/02-	G9T 600, G9T 600, G9T 606, G9T 607, G9T 700, G9T 702, G9T 702, G9T 703	2188		0-N1409	VB [DG]
2.2 dCi	06/02-	G9T 600, G9T 600, G9T 606, G9T 607, G9T 700, G9T 702, G9T 702, G9T 703	2188		0-N1731	VB [BT] S
3.0 dCi	06/02-	P9X 701	2958	Rippenanzahl: 6	0-N1461	VB [DG]
3.0 dCi	06/02-	P9X 701	2958		0-N1633	VB [DG]
3.0 dCi	06/02-	P9X 701	2958		0-N1717	VB [BT] S
3.0 dCi	06/06-	P9X 715	2958		0-N2045	VB [BT] S
3.0 dCi	06/06-	P9X 715	2958		0-N2177	VB [DG]
3.0 dCi	06/06-	P9X 715	2958	Rippenanzahl: 7	0-N2178	VB [DG]

WIND (E4M_)

1.2 , 1.2 TCe 100	07/10-	D4F 780, D4F 782	1149	23.4x95	SK-1486	BTK
1.2 , 1.2 TCe 100	07/10-	D4F 780, D4F 782	1149	23.4x95	SK-1486AQ1	BTKW
1.6	07/10-	K4M 854	1598	27x132	SK-1630	BTK
1.6	07/10-	K4M 854	1598		0-N1368	TB [TE]
1.6	07/10-	K4M 854	1598	→ 10/2011	0-N262	TB [DG]
1.6	07/10-	K4M 854	1598	✳	0-N2253	VB [DG]

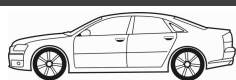

CM³



Art. Nr.



B Kasten/Kombi							
70	01/83-12/90	8140.61.235	2445	30x152	SK-1657	BTK	
90	04/86-09/90	8140.21.235 IDS	2445	30x153	SK-1045	BTK	
B Pritsche/Fahrgestell							
70	01/83-12/90	8140.61.235	2445	30x152; ohne Spanndämpfer, Spannrolle	SK-1657	BTK	
MASCOTT Kasten/Kombi							
110.35, 110.50, 110.55	01/99-06/04	8140.43.C.2586	2800	30x152	SK-1035	BTK	
110.35, 110.50, 110.55	01/99-06/04	8140.43.B.3586, 8140.43.B.3588, 8140.43.C.2586	2800	Abgasnorm: Euro 2; mit Spanndämpfer, Spannrolle	SK-1681	BTK	
110.35, 110.50, 110.55, 90.35	01/99-06/04	8140.43.B.3586, 8140.43.B.3588, 8140.43.C.2586, 8140.63.2585	2800	30x154	SK-1153	BTK	
130.35, 130.55	01/99-06/04	8140.43.S.2585	2800	30x152	SK-1035	BTK	
140.35, 140.55, 90.35	01/99-06/04	8140.63.2585, 8140-43 k	2800	30x152	SK-1035	BTK	
110.35, 110.50, 110.55	01/99-06/04	8140.43.C.2586	2800		0-N816	TB [DG]	
110.35, 110.50, 110.55	01/99-06/04	8140.43.C.2586	2800		0-N821	TB [DG]	
110.35, 110.50, 110.55, 130.35, 130.55, 140.35, 140.55, 90.35	01/99-06/04	8140.43.B.3586, 8140.43.B.3588, 8140.43.C.2586, 8140.43.S.2585, 8140.43.S.3585, 8140.63.2585, 8140-43 k	2800		0-N1617	TB [BT]	
130.35, 130.55	01/99-06/04	8140.43.S.2585	2800		0-N816	TB [DG]	
130.35, 130.55	01/99-06/04	8140.43.S.2585	2800		0-N821	TB [DG]	
140.35, 140.55, 90.35	01/99-06/04	8140.63.2585, 8140-43 k	2800		0-N816	TB [DG]	
140.35, 140.55, 90.35	01/99-06/04	8140.63.2585, 8140-43 k	2800		0-N821	TB [DG]	
150.35, 150.55, 150.65	10/01-06/04	8140.43N.3585	2798		0-N1617	TB [BT]	
150.35, 150.55, 150.65	10/01-06/04	8140.43N.3585	2798		0-N816	TB [DG]	
150.35, 150.55, 150.65	10/01-06/04	8140.43N.3585	2798		0-N821	TB [DG]	
110.35, 110.50, 110.55	01/99-06/04	8140.43.C.2586	2800		0-N144	VB [DG]	
110.35, 110.50, 110.55	01/99-06/04	8140.43.C.2586	2800		0-N1480S	VB [TE]	
130.35, 130.55	01/99-06/04	8140.43.S.2585	2800		0-N1480S	VB [TE]	
130.35, 130.55, 140.35, 140.55, 90.35	01/99-06/04	8140.43.S.2585, 8140.43.S.3585, 8140.63.2585, 8140-43 k	2800		0-N144	VB [DG]	
140.35, 140.55, 90.35	01/99-06/04	8140.63.2585, 8140-43 k	2800		0-N1480S	VB [TE]	
150.35, 150.55, 150.65	10/01-06/04	8140.43N.3585	2798		0-N144	VB [DG]	
150.35, 150.55, 150.65	10/01-06/04	8140.43N.3585	2798		0-N1480S	VB [TE]	
MASCOTT Kipper							
110, 90	01/00-06/04	8140.43.C.2586	2800	30x152	SK-1035	BTK	
110, 90	01/00-06/04	8140.43.B.3586, 8140.43.B.3588, 8140.43.C.2586	2800		0-N1617	TB [BT]	
110, 90	01/00-06/04	8140.43.C.2586	2800		0-N816	TB [DG]	
110, 90	01/00-06/04	8140.43.C.2586	2800		0-N821	TB [DG]	
110, 90	01/00-06/04	8140.43.C.2586	2800		0-N144	VB [DG]	
110, 90	01/00-06/04	8140.43.C.2586	2800		0-N1480S	VB [TE]	
MASCOTT Pritsche/Fahrgestell							
110	01/99-06/04	8140.43.C.2586	2800	30x152	SK-1035	BTK	
110	01/99-06/04	8140.43.B.3586, 8140.43.B.3588, 8140.43.C.2586	2800	Abgasnorm: Euro 2; mit Spanndämpfer, Spannrolle	SK-1681	BTK	
110, 90	01/99-06/04	8140.43.B.3586, 8140.43.B.3588, 8140.43.C.2586, 8140.63.2585	2800	30x154	SK-1153	BTK	
130	01/99-06/04	8140.43.S.2585	2800	30x152	SK-1035	BTK	
140, 90	01/99-06/04	8140.63.2585, 8140-43 k	2800	30x152	SK-1035	BTK	
110	01/99-06/04	8140.43.C.2586	2800		0-N816	TB [DG]	
110	01/99-06/04	8140.43.C.2586	2800		0-N821	TB [DG]	
110, 130, 140, 90	01/99-06/04	8140.43.B.3586, 8140.43.B.3588, 8140.43.C.2586, 8140.43.S.2585, 8140.43.S.3585, 8140.63.2585, 8140-43 k	2800		0-N1617	TB [BT]	
130	01/99-06/04	8140.43.S.2585	2800		0-N816	TB [DG]	
130	01/99-06/04	8140.43.S.2585	2800		0-N821	TB [DG]	
140, 90	01/99-06/04	8140.63.2585, 8140-43 k	2800		0-N816	TB [DG]	
140, 90	01/99-06/04	8140.63.2585, 8140-43 k	2800		0-N821	TB [DG]	
150.35	10/01-06/04	8140.43N.3585	2798		0-N1617	TB [BT]	
150.35	10/01-06/04	8140.43N.3585	2798		0-N816	TB [DG]	
150.35	10/01-06/04	8140.43N.3585	2798		0-N821	TB [DG]	
110	01/99-06/04	8140.43.C.2586	2800		0-N144	VB [DG]	
110	01/99-06/04	8140.43.C.2586	2800		0-N1480S	VB [TE]	
130	01/99-06/04	8140.43.S.2585	2800		0-N1480S	VB [TE]	
130, 140, 90	01/99-06/04	8140.43.S.2585, 8140.43.S.3585, 8140.63.2585, 8140-43 k	2800		0-N144	VB [DG]	
140, 90	01/99-06/04	8140.63.2585, 8140-43 k	2800		0-N1480S	VB [TE]	
150.35	10/01-06/04	8140.43N.3585	2798		0-N144	VB [DG]	



OPTIMAL®

RENAULT TRUCKS

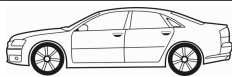

CM³



Art. Nr.



ohne Halter

MASCOTT Pritsche/Fahrgestell

150.35	10/01-06/04	8140.43N.3585	2798			0-N1480S	VB [TE]	
--------	-------------	---------------	------	--	--	-----------------	---------	--

MESSENGER Kasten/Kombi

B 110.45 4x4	09/96-06/99	8140.23.2565	2800	Antriebsart: Heckantrieb; mit Spanndämpfer, Spannrolle		SK-1681	BTK	
B 120.35, B 120.55	09/96-06/99	8140.43.2585	2800	mit Spanndämpfer, Spannrolle		SK-1681	BTK	
B 120.55	01/94-09/96	8140.47.2585	2500	07/1996 →; mit Spanndämpfer, Spannrolle		SK-1681	BTK	

MESSENGER Kipper

B 120.35, B 120.55, B 120.65	09/96-06/99	8140.43.2585	2800	mit Spanndämpfer, Spannrolle		SK-1681	BTK	
------------------------------	-------------	--------------	------	------------------------------	--	----------------	-----	--

MESSENGER Pritsche/Fahrgestell

B 110.45 4x4	09/96-06/99	8140.23.2565	2800	Antriebsart: Heckantrieb; mit Spanndämpfer, Spannrolle		SK-1681	BTK	
B 120.35	10/91-07/96	8140.47.2530 IDR, 8140.47.2590	2499	07/1996 →; mit Spanndämpfer, Spannrolle		SK-1681	BTK	
B 120.35, B 120.55, B 120.65	09/96-06/99	8140.43.2585	2800	mit Spanndämpfer, Spannrolle		SK-1681	BTK	
B 120.55, B 120.65	01/94-09/96	8140.47.2585	2500	07/1996 →; mit Spanndämpfer, Spannrolle		SK-1681	BTK	

MESSENGER Sattelschlepper

B 120.55T	01/94-09/96	8140.47.2585	2500	07/1996 →; mit Spanndämpfer, Spannrolle		SK-1681	BTK	
B 120.55T	09/96-06/99	8140.43.2585	2800	mit Spanndämpfer, Spannrolle		SK-1681	BTK	



CM³



Art. Nr.



ohne Halter

750					
2.5	01/07-	25K4F	2497	0-N1742	VB [BT] S



OPTIMAL®

ROLLS-ROYCE



CM³



Art. Nr.



ohne Halter

PHANTOM

6.75	08/02-	N73 B68 A	6749		0-N1507	VB [BT]	S
------	--------	-----------	------	--	----------------	---------	----------

PHANTOM Coupe

6.75 V12	01/07-	N73 B68 A	6749		0-N1507	VB [BT]	S
----------	--------	-----------	------	--	----------------	---------	----------

PHANTOM DROPHEAD COUPE

6.75 V12	03/06-	N73 B68 A	6749		0-N1507	VB [BT]	S
----------	--------	-----------	------	--	----------------	---------	----------



CM³



Art. Nr.



25 (RF)							
1.1	09/99-06/01	11 K4F	1120	26x145	SK-1504	BTK	
1.1 16V	01/04-05/05	11 K4F	1119	26x145	SK-1504	BTK	
1.4 16V	10/99-05/05	14 K4F, 14 K4M	1396	23x143; mit Zubehör; Spannrollenbetätigung: manuell	SK-1067	BTK	
1.4 16V	10/99-05/05	14 K4F, 14 K4M	1396	26x145	SK-1504	BTK	
1.6 16V	10/99-05/05	16 K4F	1588	23x143; mit Zubehör; Spannrollenbetätigung: manuell	SK-1067	BTK	
1.6 16V	10/99-05/05	16 K4F	1588	26x145	SK-1504	BTK	
1.8 16V	10/99-05/05	18 K4F	1796	23x143; mit Zubehör; Spannrollenbetätigung: manuell	SK-1067	BTK	
1.8 16V	10/99-05/05	18 K4F	1796	26x145	SK-1504	BTK	
1.8 16V	02/00-05/05	18 K4K	1796	26x143	SK-1507	BTK	
1.8 16V	02/00-05/05	18 K4K	1796	26x143	SK-1706	BTK	
2.0 iDT	10/99-05/05	20 T2N	1994	28x112; 22x78; ch.→YD471564; mit Zubehör	SK-1102	BTK	
2.0 iDT	10/99-05/05	20T2N26	1994	30x112; 24x78; ch.YD471565→; :→5048;	SK-1501	BTK	
2.0 iDT	10/99-05/05	20T2N25	1994	30x112; 24x78; ch.YD471565→; :→8367;	SK-1501	BTK	
2.0 iDT	10/99-05/05	20T2N26	1994	30x112; 24x78; ch.YD471565→; :5049→;	SK-1552	BTK	
2.0 iDT	10/99-05/05	20T2N25	1994	30x112; 24x78; ch.YD471565→; :8368→;	SK-1552	BTK	
2.0 iDT	01/02-12/04	20 T2N	1994	30x112; 24x78; :→5048;	SK-1501	BTK	
2.0 iDT	01/02-12/04	20 T2N	1994	30x112; 24x78; :→8367;	SK-1501	BTK	
2.0 iDT	01/02-12/04	20 T2N	1994	30x112; 24x78; :5049→;	SK-1552	BTK	
2.0 iDT	01/02-12/04	20 T2N	1994	30x112; 24x78; :8368→;	SK-1552	BTK	
1.1 16V	01/04-05/05	11 K4F	1119		0-N1272	TB [TE]	
1.4 16V	10/99-05/05	14 K4F, 14 K4M	1396		0-N1272	TB [TE]	
1.4 16V	10/99-05/05	14 K4F, 14 K4M	1396		0-N894	TB [TE]	
1.6 16V	10/99-05/05	16 K4F	1588		0-N1272	TB [TE]	
1.6 16V	10/99-05/05	16 K4F	1588		0-N894	TB [TE]	
1.8 16V	10/99-05/05	18 K4F	1796		0-N1272	TB [TE]	
1.8 16V	10/99-05/05	18 K4F, 18 K4K	1796		0-N894	TB [TE]	
2.0 iDT	10/99-05/05	20 T2N	1994	ch.471565→	0-N1120	TB [TE]	
2.0 iDT	10/99-05/05	20 T2N	1994	ch.471565→; :→5048;	0-N1121	TB [TE]	
2.0 iDT	10/99-05/05	20 T2N	1994	ch.471565→; :→8367;	0-N1121	TB [TE]	
2.0 iDT	10/99-05/05	20 T2N	1994	ch.471565→	0-N1122	TB [DG]	
2.0 iDT	10/99-05/05	20 T2N	1994	ch.→471564	0-N1273	TB [TE]	
2.0 iDT	10/99-05/05	20 T2N	1994	:5049→	0-N1273	TB [TE]	
2.0 iDT	10/99-05/05	20 T2N	1994	:8368→	0-N1273	TB [TE]	
2.0 iDT	10/99-05/05	20 T2N	1994	ch.→471564	0-N236	TB [TE]	
2.0 iDT	10/99-05/05	20 T2N	1994	ch.→471564	0-N237	TB [DG]	
1.1	09/99-05/05	11 K4F	1120		0-N1643	VB [BT]	S
1.1 16V	01/04-05/05	11 K4F	1119	manuell	0-N1412	VB [TE]	
1.1 16V	01/04-05/05	11 K4F	1119		0-N1584	VB [TE]	
1.1 16V	01/04-05/05	11 K4F	1119		0-N1643	VB [BT]	S
1.4 16V	10/99-05/05	14 K4F, 14 K4M	1396	manuell	0-N1412	VB [TE]	
1.4 16V	10/99-05/05	14 K4F, 14 K4M	1396		0-N1584	VB [TE]	
1.4 16V	10/99-05/05	14 K4F, 14 K4M	1396		0-N1643	VB [BT]	S
1.6 16V	10/99-05/05	16 K4F	1588	manuell	0-N1412	VB [TE]	
1.6 16V	10/99-05/05	16 K4F	1588		0-N1584	VB [TE]	
1.6 16V	10/99-05/05	16 K4F	1588		0-N1643	VB [BT]	S
1.8 16V	10/99-05/05	18 K4F, 18 K4K	1796	manuell	0-N1412	VB [TE]	
1.8 16V	10/99-05/05	18 K4F, 18 K4K	1796		0-N1584	VB [TE]	
1.8 16V	10/99-05/05	18 K4F, 18 K4K	1796		0-N1643	VB [BT]	S
2.0 iDT	10/99-05/05	20 T2N	1994		0-N1535	VB [BT]	S
45 (RT)							
1.4	02/00-05/05	14 K4F	1396	23x143; mit Zubehör; Spannrollenbetätigung: manuell	SK-1067	BTK	
1.4	02/00-05/05	14 K4F	1396	26x145	SK-1504	BTK	
1.6	02/00-05/05	16 K4F	1588	23x143; mit Zubehör; Spannrollenbetätigung: manuell	SK-1067	BTK	
1.6	02/00-05/05	16 K4F	1588	26x145	SK-1504	BTK	
1.8	02/00-05/05	18 K4F	1796	26x145	SK-1504	BTK	
2.0 iDT	02/00-05/05	20 T2N	1994	30x112; 24x78; :→1011;	SK-1501	BTK	
2.0 iDT	02/00-05/05	20 T2N	1994	30x112; 24x78; :→9369;	SK-1501	BTK	
2.0 iDT	02/00-05/05	20 T2N	1994	30x112; 24x78; :1012→;	SK-1552	BTK	

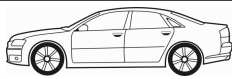

CM³



Art. Nr.



45 (RT)							
2.0 iDT	02/00-05/05	20 T2N	1994	30x112; 24x78; :9370→;	SK-1552	BTK	
2.0 V6	02/00-05/05	20 K4F	1997	22x58; 28x176; ohne Spanndämpfer, Spannrolle	SK-1502	BTK	
1.4	02/00-05/05	14 K4F	1396		0-N1272	TB [TE]	
1.4	02/00-05/05	14 K4F	1396		0-N894	TB [TE]	
1.6	02/00-05/05	16 K4F	1588		0-N1272	TB [TE]	
1.6	02/00-05/05	16 K4F	1588		0-N894	TB [TE]	
1.8	02/00-05/05	18 K4F	1796		0-N1272	TB [TE]	
2.0 iDT	02/00-05/05	20 T2N	1994	ch.471064→	0-N1120	TB [TE]	
2.0 iDT	02/00-05/05	20 T2N	1994	ch.471064→; :→1011;	0-N1121	TB [TE]	
2.0 iDT	02/00-05/05	20 T2N	1994	ch.471064→; :→9369;	0-N1121	TB [TE]	
2.0 iDT	02/00-05/05	20 T2N	1994	ch.471064→	0-N1122	TB [DG]	
2.0 iDT	02/00-05/05	20 T2N	1994	ch.→471063	0-N1273	TB [TE]	
2.0 iDT	02/00-05/05	20 T2N	1994	:1012→	0-N1273	TB [TE]	
2.0 iDT	02/00-05/05	20 T2N	1994	:9370→	0-N1273	TB [TE]	
2.0 iDT	02/00-05/05	20 T2N	1994	ch.→471063	0-N236	TB [TE]	
2.0 iDT	02/00-05/05	20 T2N	1994	ch.→471063	0-N237	TB [DG]	
2.0 V6	02/00-05/05	20 K4F	1997		0-N1248	TB [DG]	
2.0 V6	02/00-05/05	20 K4F	1997		0-N1261	TB [TE]	
1.4	02/00-05/05	14 K4F	1396	manuell	0-N1412	VB [TE]	
1.4	02/00-05/05	14 K4F	1396	ch.→YD471063	0-N1584	VB [TE]	
1.4	02/00-05/05	14 K4F	1396		0-N1643	VB [BT]	S
1.4	02/00-05/05	14 K4F	1396	ch.YD471064→;	0-N1659	VB [BT]	S
1.6	02/00-05/05	16 K4F	1588	manuell	0-N1412	VB [TE]	
1.6	02/00-05/05	16 K4F	1588	ch.→YD471063	0-N1584	VB [TE]	
1.6	02/00-05/05	16 K4F	1588		0-N1643	VB [BT]	S
1.6	02/00-05/05	16 K4F	1588	ch.YD471064→;	0-N1659	VB [BT]	S
1.8	02/00-05/05	18 K4F	1796	manuell	0-N1412	VB [TE]	
1.8	02/00-05/05	18 K4F	1796	ch.→YD471063	0-N1584	VB [TE]	
1.8	02/00-05/05	18 K4F	1796		0-N1643	VB [BT]	S
1.8	02/00-05/05	18 K4F	1796	ch.YD471064→;	0-N1659	VB [BT]	S
2.0 iDT	02/00-05/05	20 T2N	1994		0-N1535	VB [BT]	S
2.0 V6	02/00-05/05	20 K4F	1997		0-N1735	VB [DG]	
2.0 V6	02/00-05/05	20 K4F	1997	ch.YD471064→	0-N1742	VB [BT]	S
45 Stufenheck (RT)							
1.4	02/00-05/05	14 K4F	1396	23x143; mit Zubehör; Spannrollenbetätigung; manuell	SK-1067	BTK	
1.4	02/00-05/05	14 K4F	1396	26x145	SK-1504	BTK	
1.6	02/00-05/05	16 K4F	1588	23x143; mit Zubehör; Spannrollenbetätigung; manuell	SK-1067	BTK	
1.6	02/00-05/05	16 K4F	1588	26x145	SK-1504	BTK	
1.8	02/00-05/05	18 K4F	1796	26x145	SK-1504	BTK	
2.0 iDT	02/00-05/05	20 T2N	1994	30x112; 24x78; :→1011;	SK-1501	BTK	
2.0 iDT	02/00-05/05	20 T2N	1994	30x112; 24x78; :→9369;	SK-1501	BTK	
2.0 iDT	02/00-05/05	20 T2N	1994	30x112; 24x78; :1012→;	SK-1552	BTK	
2.0 iDT	02/00-05/05	20 T2N	1994	30x112; 24x78; :9370→;	SK-1552	BTK	
2.0 V6	02/00-05/05	20 K4F	1997	22x58; 28x176; ohne Spanndämpfer, Spannrolle	SK-1502	BTK	
1.4	02/00-05/05	14 K4F	1396		0-N1272	TB [TE]	
1.4	02/00-05/05	14 K4F	1396		0-N894	TB [TE]	
1.6	02/00-05/05	16 K4F	1588		0-N1272	TB [TE]	
1.6	02/00-05/05	16 K4F	1588		0-N894	TB [TE]	
1.8	02/00-05/05	18 K4F	1796		0-N1272	TB [TE]	
2.0 iDT	02/00-05/05	20 T2N	1994	ch.471064→	0-N1120	TB [TE]	
2.0 iDT	02/00-05/05	20 T2N	1994	ch.471064→; :→1011;	0-N1121	TB [TE]	
2.0 iDT	02/00-05/05	20 T2N	1994	ch.471064→; :→9369;	0-N1121	TB [TE]	
2.0 iDT	02/00-05/05	20 T2N	1994	ch.471064→	0-N1122	TB [DG]	
2.0 iDT	02/00-05/05	20 T2N	1994	ch.→471063	0-N1273	TB [TE]	
2.0 iDT	02/00-05/05	20 T2N	1994	:1012→	0-N1273	TB [TE]	
2.0 iDT	02/00-05/05	20 T2N	1994	:9370→	0-N1273	TB [TE]	
2.0 iDT	02/00-05/05	20 T2N	1994	ch.→471063	0-N236	TB [TE]	
2.0 iDT	02/00-05/05	20 T2N	1994	ch.→471063	0-N237	TB [DG]	
2.0 iDT	01/04-05/05	20 T2N	1994	:1012→;	0-N1273	TB [TE]	
2.0 iDT	01/04-05/05	20 T2N	1994	:9370→;	0-N1273	TB [TE]	
2.0 V6	02/00-05/05	20 K4F	1997		0-N1248	TB [DG]	
2.0 V6	02/00-05/05	20 K4F	1997		0-N1261	TB [TE]	

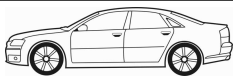

CM³



Art. Nr.



45 Stufenheck (RT)

1.4	02/00-05/05	14 K4F	1396	manuell	0-N1412	VB [TE]	
1.4	02/00-05/05	14 K4F	1396	ch.→YD471063	0-N1584	VB [TE]	
1.4	02/00-05/05	14 K4F	1396		0-N1643	VB [BT]	S
1.4	02/00-05/05	14 K4F	1396	ch.YD471064→; ⚡	0-N1659	VB [BT]	S
1.6	02/00-05/05	16 K4F	1588	manuell	0-N1412	VB [TE]	
1.6	02/00-05/05	16 K4F	1588	ch.→YD471063	0-N1584	VB [TE]	
1.6	02/00-05/05	16 K4F	1588		0-N1643	VB [BT]	S
1.6	02/00-05/05	16 K4F	1588	ch.YD471064→; ⚡	0-N1659	VB [BT]	S
1.8	02/00-05/05	18 K4F	1796	manuell	0-N1412	VB [TE]	
1.8	02/00-05/05	18 K4F	1796	ch.→YD471063	0-N1584	VB [TE]	
1.8	02/00-05/05	18 K4F	1796		0-N1643	VB [BT]	S
1.8	02/00-05/05	18 K4F	1796	ch.YD471064→; ⚡	0-N1659	VB [BT]	S
2.0 iDT	02/00-05/05	20 T2N	1994		0-N1535	VB [BT]	S
2.0 V6	02/00-05/05	20 K4F	1997		0-N1735	VB [DG]	
2.0 V6	02/00-05/05	20 K4F	1997	ch.YD471064→	0-N1742	VB [BT]	S

75 (RJ)

1.8, 1.8 Turbo	02/99-05/05	18 K4G, K 1.8	1796	26x145	SK-1504	BTK	
2.0 V6	02/99-05/05	20 K4F	1997	22x58; 28x176; 04/1999 →; ohne Spanndämpfer, Spannrolle	SK-1502	BTK	
2.5 V6	02/99-05/05	25 K4F, KV 6	2497	22x58; 28x176; ohne Spanndämpfer, Spannrolle	SK-1502	BTK	
1.8, 1.8 Turbo	02/99-05/05	18 K4G, K 1.8	1796		0-N1272	TB [TE]	
2.0 V6	02/99-05/05	20 K4F	1997		0-N1248	TB [DG]	
2.0 V6	02/99-05/05	20 K4F	1997		0-N1261	TB [TE]	
2.5 V6	02/99-05/05	25 K4F, KV 6	2497		0-N1248	TB [DG]	
2.5 V6	02/99-05/05	25 K4F, KV 6	2497		0-N1261	TB [TE]	
1.8, 1.8 Turbo	02/99-05/05	18 K4G, K 1.8	1796		0-N1643	VB [BT]	S
1.8, 1.8 Turbo	02/99-05/05	18 K4G, K 1.8	1796	⚡	0-N1659	VB [BT]	S
2.0 CDT	02/99-05/05	M 47 R	1950		0-N1396	VB [DG]	
2.0 CDT	02/99-05/05	M 47 R	1950	⚡	0-N1514	VB [BT]	S
2.0 CDTi	02/03-05/05	204D2	1951	⚡	0-N1514	VB [BT]	S
2.0 V6	02/99-05/05	20 K4F	1997	⚡	0-N1735	VB [DG]	
2.0 V6	02/99-05/05	20 K4F	1997		0-N1742	VB [BT]	S
2.5 V6	02/99-05/05	25 K4F, KV 6	2497	⚡	0-N1735	VB [DG]	
2.5 V6	02/99-05/05	25 K4F, KV 6	2497		0-N1742	VB [BT]	S

75 Tourer (RJ)

1.8, 1.8 Turbo	08/01-05/05	18 K4G, K 1.8	1796	26x145	SK-1504	BTK	
2.0 V6	08/01-05/05	20 K4F	1997	22x58; 28x176; ohne Spanndämpfer, Spannrolle	SK-1502	BTK	
2.5 V6	08/01-05/05	KV 6	2497	22x58; 28x176; ohne Spanndämpfer, Spannrolle	SK-1502	BTK	
1.8, 1.8 Turbo	08/01-05/05	18 K4G, K 1.8	1796		0-N1272	TB [TE]	
2.0 V6	08/01-05/05	20 K4F	1997		0-N1248	TB [DG]	
2.0 V6	08/01-05/05	20 K4F	1997		0-N1261	TB [TE]	
2.5 V6	08/01-05/05	KV 6	2497		0-N1248	TB [DG]	
2.5 V6	08/01-05/05	KV 6	2497		0-N1261	TB [TE]	
1.8, 1.8 Turbo	08/01-05/05	18 K4G, K 1.8	1796		0-N1643	VB [BT]	S
1.8, 1.8 Turbo	08/01-05/05	18 K4G, K 1.8	1796	⚡	0-N1659	VB [BT]	S
2.0 CDT	08/01-05/05	M 47 R	1950		0-N1396	VB [DG]	
2.0 CDT	08/01-05/05	M 47 R	1950	⚡	0-N1514	VB [BT]	S
2.0 CDTi	02/03-05/05	204D2	1951	⚡	0-N1514	VB [BT]	S
2.0 V6	08/01-05/05	20 K4F	1997	⚡	0-N1735	VB [DG]	
2.0 V6	08/01-05/05	20 K4F	1997		0-N1742	VB [BT]	S
2.5 V6	08/01-05/05	KV 6	2497	⚡	0-N1735	VB [DG]	
2.5 V6	08/01-05/05	KV 6	2497		0-N1742	VB [BT]	S

100 / METRO (XP)

114 D	10/92-12/94	TUD 3	1361	25x143	SK-1005	BTK	
114 GSi, 114 GTi 16V	08/91-12/98	14 K4F	1396	23x143; mit Zubehör	SK-1067	BTK	
114 GTi 16V	03/90-08/91	14 K4C	1396	23x143; mit Zubehör	SK-1067	BTK	
114 GTi/GT 16V KAT	03/90-12/98	14 K4D	1396	23x143; mit Zubehör	SK-1067	BTK	
115 D	12/94-12/98	TUD 5	1527	25.4x136	SK-1040	BTK	
115 D	12/94-12/98	TUD 5	1527	25.4x136	SK-1040AQ1	BTKW	
114 D	10/92-12/94	TUD 3	1361		0-N861	TB [TE]	
114 D	10/92-12/94	TUD 3	1361		0-N862	TB [DG]	



CM³



Art. Nr.



100 / METRO (XP)							
114 GSi, 114 GTi 16V, 114 GTi/GT 16V KAT	03/90-12/98	14 K4C, 14 K4D, 14 K4F	1396			0-N894	TB [TE]
115 D	12/94-12/98	TUD 5	1527			0-N861	TB [TE]
115 D	12/94-12/98	TUD 5	1527			0-N862	TB [DG]
100 Cabriolet (XP)							
114	03/97-10/98	14 K4F	1396	23x143; mit Zubehör		SK-1067	BTK
114	03/97-10/98	14 K4F	1396			0-N894	TB [TE]
200 Coupe (XW)							
216	10/92-06/99	D 16 A8	1590	24x124		SK-1213	BTK
220 GSi, 220 Turbo	10/92-06/99	20 T4G, 20 T4H	1994	22x132		SK-1500	BTK
216	10/92-06/99	D 16 A8	1590			0-N927	TB [TE]
220 GSi, 220 Turbo	10/92-06/99	20 T4G, 20 T4H	1994			0-N1243	TB [TE]
216	10/92-06/99	D 16 A8	1590			0-N1643	VB [BT]
220 GSi, 220 Turbo	10/92-06/99	20 T4G, 20 T4H	1994			0-N1584	VB [TE]
220 GSi, 220 Turbo	10/92-06/99	20 T4G, 20 T4H	1994			0-N1643	VB [BT]
200 Hatchback (XW)							
214 GSi/Si	01/90-10/95	14 K4C, 14 K4F	1396	23x143; mit Zubehör		SK-1067	BTK
214 Si/Gsi	10/89-10/95	14 K4D	1396	23x143; mit Zubehör		SK-1067	BTK
216 GSi	10/89-10/95	D 16 A7, D 16 Z2	1590	24x107		SK-1211	BTK
216 GTi	09/90-10/95	D 16 A8, D 16 A9	1590	24x124		SK-1213	BTK
218 D	09/91-10/95	XUD9	1905	25.39x136; → 10/1992		SK-1007	BTK
218 D	09/91-10/95	XUD9	1905	25.4x136; 10/1992 →		SK-1022	BTK
218 TD	09/91-10/95	XUD 7TE	1769	25.39x136; → 10/1992		SK-1007	BTK
218 TD	09/91-10/95	XUD 7TE	1769	25.4x136; : → 10CV2L4016154		SK-1007AQ1	BTKW
218 TD	09/91-10/95	XUD 7TE	1769	25.4x136; 10/1992 →		SK-1022	BTK
220 GTi, 220 Turbo	09/91-10/95	20 M4F, 20 T4G, 20 T4H	1994	22x132		SK-1500	BTK
214 GSi/Si, 214 Si/Gsi	10/89-10/95	14 K4C, 14 K4C, 14 K4D, 14 K4F	1396			0-N894	TB [TE]
216 GSi, 216 GTi	10/89-10/95	D 16 A8, D 16 Z2	1590			0-N927	TB [TE]
218 D	09/91-10/95	XUD9	1905	→ 10/1992		0-N813	TB [TE]
218 D	09/91-10/95	XUD9	1905	→ 10/1992		0-N814	TB [DG]
218 D	09/91-10/95	XUD9	1905	11/1992 →		0-N900	TB [DG]
218 D	09/91-10/95	XUD9	1905	11/1992 →		0-N901	TB [TE]
218 TD	09/91-10/95	XUD 7TE	1769	→ 10/1992		0-N813	TB [TE]
218 TD	09/91-10/95	XUD 7TE	1769	→ 10/1992		0-N814	TB [DG]
218 TD	09/91-10/95	XUD 7TE	1769	11/1992 →		0-N900	TB [DG]
218 TD	09/91-10/95	XUD 7TE	1769	11/1992 →		0-N901	TB [TE]
220 GTi	09/91-10/95	20 M4F	1994	10/1992 →		0-N1243	TB [TE]
220 GTi	09/91-10/95	20 M4F	1994	→ 10/1992		0-N897	TB [TE]
220 GTi, 220 Turbo	01/93-10/95	20 T4G, 20 T4H	1994			0-N1243	TB [TE]
214, 214 GSi/Si, 214 Si/Gsi	10/89-10/95	14 K2A, 14 K2D, 14 K4C, 14 K4C, 14 K4D, 14 K4F	1396			0-N1412	VB [TE]
214, 214 GSi/Si, 214 Si/Gsi	10/89-10/95	14 K2A, 14 K2D, 14 K4C, 14 K4C, 14 K4D, 14 K4F	1396			0-N1584	VB [TE]
220 GTi, 220 Turbo	09/91-10/95	20 M4F, 20 T4G, 20 T4H	1994			0-N1584	VB [TE]
200 (XH)							
213 S	09/85-09/89	EV 2	1342			0-N926	TB [TE]
200 (RF)							
214 Si	11/95-03/00	14 K4F	1396	23x143; mit Zubehör; Spannrollenbetätigung: manuell		SK-1067	BTK
214 Si	11/95-03/00	14 K4F	1396	26x145		SK-1504	BTK
216 Si	11/95-03/00	16 K4F	1588	23x143; mit Zubehör; Spannrollenbetätigung: manuell		SK-1067	BTK
216 Si	11/95-03/00	16 K4F	1588	26x145		SK-1504	BTK
218 K Vi	11/95-03/00	18 K4K	1796	26x143		SK-1507	BTK
218 K Vi	11/95-03/00	18 K4K	1796	26x143; 03/1996 → 06/1999		SK-1706	BTK
218 K Vi	11/95-03/00	18 K4K	1796	26x143		SK-1706AQ1	BTKW
218 Si	08/99-03/00	18 K4F	1796	26x145		SK-1504	BTK
220 D/SD, 220 SDi	11/95-03/00	20 T2N, 20 T2R	1994	28x112; 22x78; mit Zubehör		SK-1102	BTK
214 Si	11/95-03/00	14 K4F	1396			0-N1272	TB [TE]
214 Si	11/95-03/00	14 K4F	1396			0-N894	TB [TE]
216 Si	11/95-03/00	16 K4F	1588			0-N1272	TB [TE]
216 Si	11/95-03/00	16 K4F	1588			0-N894	TB [TE]
218 K Vi	11/95-03/00	18 K4K	1796			0-N894	TB [TE]
218 Si	08/99-03/00	18 K4F	1796			0-N1272	TB [TE]
218 Si	08/99-03/00	18 K4F	1796	Spannrollenbetätigung: manuell		0-N894	TB [TE]

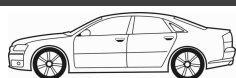

CM³



Art. Nr.



ohne Halter

200 (RF)							
220 D/SD, 220 SDi	11/95-03/00	20 T2N, 20 T2R	1994	ch.471565→	0-N1120	TB [TE]	
220 D/SD, 220 SDi	11/95-03/00	20 T2N, 20 T2R	1994	ch.471565→; :→5048;	0-N1121	TB [TE]	
220 D/SD, 220 SDi	11/95-03/00	20 T2N, 20 T2R	1994	ch.471565→; :→8367;	0-N1121	TB [TE]	
220 D/SD, 220 SDi	11/95-03/00	20 T2N, 20 T2R	1994	ch.471565→	0-N1122	TB [DG]	
220 D/SD, 220 SDi	11/95-03/00	20 T2N, 20 T2R	1994	ch.→471564	0-N1273	TB [TE]	
220 D/SD, 220 SDi	11/95-03/00	20 T2N, 20 T2R	1994	:5049→	0-N1273	TB [TE]	
220 D/SD, 220 SDi	11/95-03/00	20 T2N, 20 T2R	1994	:8368→	0-N1273	TB [TE]	
220 D/SD, 220 SDi	11/95-03/00	20 T2N, 20 T2R	1994	ch.→471564	0-N236	TB [TE]	
220 D/SD, 220 SDi	11/95-03/00	20 T2N, 20 T2R	1994	ch.→471564	0-N237	TB [DG]	
211	01/98-03/00	11 K2D	1119	manuell	0-N1412	VB [TE]	
211	01/98-03/00	11 K2D	1119		0-N1584	VB [TE]	
211	01/98-03/00	11 K2D	1119		0-N1643	VB [BT]	S
214 i, 214 Si	11/95-03/00	14 K2F, 14 K4F	1396	manuell	0-N1412	VB [TE]	
214 i, 214 Si	11/95-03/00	14 K2F, 14 K4F	1396		0-N1584	VB [TE]	
214 i, 214 Si	11/95-03/00	14 K2F, 14 K4F	1396		0-N1643	VB [BT]	S
216 Si	11/95-03/00	16 K4F	1588	manuell	0-N1412	VB [TE]	
216 Si	11/95-03/00	16 K4F	1588		0-N1584	VB [TE]	
216 Si	11/95-03/00	16 K4F	1588		0-N1643	VB [BT]	S
218 K Vi	11/95-03/00	18 K4K	1796	manuell	0-N1412	VB [TE]	
218 K Vi	11/95-03/00	18 K4K	1796		0-N1584	VB [TE]	
218 K Vi	11/95-03/00	18 K4K	1796		0-N1643	VB [BT]	S
218 Si	08/99-03/00	18 K4F	1796	Spannrollenbetätigung: manuell	0-N1412	VB [TE]	
218 Si	08/99-03/00	18 K4F	1796	ch.→YD471564	0-N1584	VB [TE]	
220 D/SD, 220 SDi	11/95-03/00	20 T2N, 20 T2R	1994		0-N1535	VB [BT]	S
400 (RT)							
414 Si	05/95-03/00	14 K4F	1396	23x143; mit Zubehör; Spannrollenbetätigung: manuell	SK-1067	BTK	
414 Si	05/95-03/00	14 K4F	1396	26x145	SK-1504	BTK	
416 Si	05/95-03/00	16 K4F	1588	23x143; mit Zubehör; Spannrollenbetätigung: manuell	SK-1067	BTK	
416 Si	05/95-03/00	D 16 Y2	1590	24x107; → 06/1999; :→D16Y3E299999	SK-1211	BTK	
416 Si	05/95-03/00	D 16 Y2	1590	26x145	SK-1504	BTK	
416 Si	05/95-03/00	16 K4F	1588	26x145	SK-1504	BTK	
420 D, 420 Di	05/95-03/00	20 T2N, 20 T2R	1994	28x112; 22x78; mit Zubehör	SK-1102	BTK	
420 Si Lux	12/95-03/00	20 T4H	1994	22x132	SK-1500	BTK	
414 Si	05/95-03/00	14 K4F	1396		0-N1272	TB [TE]	
414 Si	05/95-03/00	14 K4F	1396		0-N894	TB [TE]	
416 Si	05/95-03/00	16 K4F	1588		0-N1272	TB [TE]	
416 Si	05/95-03/00	16 K4F	1588		0-N894	TB [TE]	
416 Si	05/95-03/00	D 16 Y2	1590		0-N927	TB [TE]	
416 Si	05/95-03/00	D 16 Y2	1590		0-N978	TB [TE]	
420 D, 420 Di	05/95-03/00	20 T2N, 20 T2R	1994	ch.471064→	0-N1120	TB [TE]	
420 D, 420 Di	05/95-03/00	20 T2N, 20 T2R	1994	ch.471064→; :→1011;	0-N1121	TB [TE]	
420 D, 420 Di	05/95-03/00	20 T2N, 20 T2R	1994	ch.471064→; :→9369;	0-N1121	TB [TE]	
420 D, 420 Di	05/95-03/00	20 T2N, 20 T2R	1994	ch.471064→	0-N1122	TB [DG]	
420 D, 420 Di	05/95-03/00	20 T2N, 20 T2R	1994	ch.→471063	0-N1273	TB [TE]	
420 D, 420 Di	05/95-03/00	20 T2N, 20 T2R	1994	:1012→	0-N1273	TB [TE]	
420 D, 420 Di	05/95-03/00	20 T2N, 20 T2R	1994	:9370→	0-N1273	TB [TE]	
420 D, 420 Di	05/95-03/00	20 T2N, 20 T2R	1994	ch.→471063	0-N236	TB [TE]	
420 D, 420 Di	05/95-03/00	20 T2N, 20 T2R	1994	ch.→471063	0-N237	TB [DG]	
420 Si Lux	12/95-03/00	20 T4H	1994		0-N1243	TB [TE]	
414	03/96-12/99	14 K2F	1396	Spannrollenbetätigung: manuell	0-N1412	VB [TE]	
414	03/96-12/99	14 K2F	1396		0-N1584	VB [TE]	
414 Si	05/95-03/00	14 K4F	1396	manuell	0-N1412	VB [TE]	
414 Si	05/95-03/00	14 K4F	1396	ch.→YD471063	0-N1584	VB [TE]	
414 Si	05/95-03/00	14 K4F	1396		0-N1643	VB [BT]	S
414 Si	05/95-03/00	14 K4F	1396	ch.YD471064→;	0-N1659	VB [BT]	S
416 Si	05/95-03/00	16 K4F	1588	manuell	0-N1412	VB [TE]	
416 Si	05/95-03/00	16 K4F	1588	ch.→YD471063	0-N1584	VB [TE]	
416 Si	05/95-03/00	16 K4F	1588		0-N1643	VB [BT]	S
416 Si	05/95-03/00	16 K4F	1588	ch.YD471064→;	0-N1659	VB [BT]	S
420 D, 420 Di	05/95-03/00	20 T2N, 20 T2R	1994		0-N1535	VB [BT]	S
420 D, 420 Di, 420 Si Lux	05/95-03/00	20 T2N, 20 T2R, 20 T4H	1994		0-N1584	VB [TE]	

CM³

Art. Nr.

**400 Hatchback (RT)**

414 Si	05/95-03/00	14 K4F	1396	23x143; mit Zubehör; Spannrollenbetätigung: manuell	SK-1067	BTK	
414 Si	05/95-03/00	14 K4F	1396	26x145	SK-1504	BTK	
416 Si	05/95-03/00	16 K4F	1588	23x143; mit Zubehör; Spannrollenbetätigung: manuell	SK-1067	BTK	
416 Si	05/95-03/00	16 K4F	1588	26x145	SK-1504	BTK	
416 Si	06/95-03/00	D 16 Y2	1590	24x107; 03/1996 → 06/1999; <small>1996/97 ENGINE</small> → D16Y3E299999	SK-1211	BTK	
416 Si	06/95-03/00	D16B2	1590	24x104	SK-1277	BTK	
416 Si	06/95-03/00	D 16 Y2	1590	26x145	SK-1504	BTK	
420 D, 420 Di	05/95-03/00	20 T2N, 20 T2R	1994	28x112; 22x78; mit Zubehör	SK-1102	BTK	
420 Si Lux	12/95-03/00	20 T4H	1994	22x132	SK-1500	BTK	
414 Si	05/95-03/00	14 K4F	1396		0-N1272	TB [TE]	
414 Si	05/95-03/00	14 K4F	1396		0-N894	TB [TE]	
416 Si	05/95-03/00	16 K4F	1588		0-N1272	TB [TE]	
416 Si	05/95-03/00	16 K4F	1588		0-N894	TB [TE]	
416 Si	06/95-03/00	D 16 Y2	1590		0-N927	TB [TE]	
416 Si	06/95-03/00	D 16 Y2, D16B2	1590		0-N978	TB [TE]	
420 D, 420 Di	05/95-03/00	20 T2N, 20 T2R	1994	ch.471064 →	0-N1120	TB [TE]	
420 D, 420 Di	05/95-03/00	20 T2N, 20 T2R	1994	ch.471064 →; <small>1996/97 ENGINE</small> → 1011; ⚡	0-N1121	TB [TE]	
420 D, 420 Di	05/95-03/00	20 T2N, 20 T2R	1994	ch.471064 →; <small>1996/97 ENGINE</small> → 9369; ⚡	0-N1121	TB [TE]	
420 D, 420 Di	05/95-03/00	20 T2N, 20 T2R	1994	ch.471064 →	0-N1122	TB [DG]	
420 D, 420 Di	05/95-03/00	20 T2N, 20 T2R	1994	ch. → 471063	0-N1273	TB [TE]	
420 D, 420 Di	05/95-03/00	20 T2N, 20 T2R	1994	<small>1996/97 ENGINE</small> : 1012 →	0-N1273	TB [TE]	
420 D, 420 Di	05/95-03/00	20 T2N, 20 T2R	1994	<small>1996/97 ENGINE</small> : 9370 →	0-N1273	TB [TE]	
420 D, 420 Di	05/95-03/00	20 T2N, 20 T2R	1994	ch. → 471063	0-N236	TB [TE]	
420 D, 420 Di	05/95-03/00	20 T2N, 20 T2R	1994	ch. → 471063	0-N237	TB [DG]	
420 Si Lux	12/95-03/00	20 T4H	1994		0-N1243	TB [TE]	
414, 414 Si	05/95-03/00	14 K2F, 14 K4F	1396	manuell	0-N1412	VB [TE]	
414, 414 Si	05/95-03/00	14 K2F, 14 K4F	1396	ch. → YD471063	0-N1584	VB [TE]	
414, 414 Si	05/95-03/00	14 K2F, 14 K4F	1396		0-N1643	VB [BT]	S
414, 414 Si	05/95-03/00	14 K2F, 14 K4F	1396	ch.YD471064 →; ⚡	0-N1659	VB [BT]	S
416 Si	05/95-03/00	16 K4F	1588	manuell	0-N1412	VB [TE]	
416 Si	05/95-03/00	16 K4F	1588	ch. → YD471063	0-N1584	VB [TE]	
416 Si	05/95-03/00	16 K4F	1588		0-N1643	VB [BT]	S
416 Si	05/95-03/00	16 K4F	1588	ch.YD471064 →; ⚡	0-N1659	VB [BT]	S
416 Si	06/95-03/00	D 16 Y2	1590		0-N1412	VB [TE]	
416 Si	06/95-03/00	D 16 Y2	1590		0-N1584	VB [TE]	
416 Si	06/95-03/00	D16B2	1590		0-N2102	VB [DG]	
420 D, 420 Di	05/95-03/00	20 T2N, 20 T2R	1994		0-N1535	VB [BT]	S
420 D, 420 Di, 420 Si Lux	05/95-03/00	20 T2N, 20 T2R, 20 T4H	1994		0-N1584	VB [TE]	

400 (XW)

414 GSI/SI	04/90-04/95	14 K4D	1396	23x143; mit Zubehör	SK-1067	BTK	
414, 414 GSI/SI KAT	01/93-04/95	14 K4C, 14 K4F	1396	23x143; mit Zubehör	SK-1067	BTK	
416 GSI	04/90-04/95	D 16 Z2	1590	24x107	SK-1211	BTK	
416 GSI/GSE, 416 GTI, 416 GTI/GTE	04/90-04/95	D 16 A7, D 16 A8, D 16 A9	1590	24x124	SK-1213	BTK	
418 D	09/91-04/95	XUD9	1905	25.39x136	SK-1007	BTK	
418 D	09/91-04/95	XUD9	1905	25.4x136	SK-1007AQ1	BTKW	
418 D	09/91-04/95	XUD9	1905	25.4x136; 11/1992 →	SK-1022	BTK	
418 TD	09/91-04/95	XUD 7TE	1769	25.39x136; → 10/1992	SK-1007	BTK	
418 TD	09/91-04/95	XUD 7TE	1769	25.4x136	SK-1007AQ1	BTKW	
418 TD	09/91-04/95	XUD 7TE	1769	25.4x136; 10/1992 →	SK-1022	BTK	
420 GSI/SLI/GTI/Vite, 420 GTI/GSI/Vitesse, 420 Turbo	02/92-04/95	20 M4F, 20 T4G, 20 T4H	1994	22x132	SK-1500	BTK	
414, 414 GSI/SI, 414 GSI/SI KAT	04/90-04/95	14 K4C, 14 K4C, 14 K4D, 14 K4F	1396		0-N894	TB [TE]	
416 GSI, 416 GTI	04/90-04/95	D 16 A8, D 16 Z2	1590		0-N927	TB [TE]	
418 D	09/91-04/95	XUD9	1905	→ 10/1992	0-N813	TB [TE]	
418 D	09/91-04/95	XUD9	1905	→ 10/1992	0-N814	TB [DG]	
418 D	09/91-04/95	XUD9	1905	11/1992 →	0-N900	TB [DG]	
418 D	09/91-04/95	XUD9	1905	11/1992 →	0-N901	TB [TE]	
418 TD	09/91-04/95	XUD 7TE	1769	→ 10/1992	0-N813	TB [TE]	
418 TD	09/91-04/95	XUD 7TE	1769	→ 10/1992	0-N814	TB [DG]	
418 TD	09/91-04/95	XUD 7TE	1769	11/1992 →	0-N900	TB [DG]	
418 TD	09/91-04/95	XUD 7TE	1769	11/1992 →	0-N901	TB [TE]	
420 GSI/SLI/GTI/Vite, 420 Turbo	01/93-04/95	20 T4G, 20 T4H	1994		0-N1243	TB [TE]	
420 GTI/GSI/Vitesse	02/92-04/95	20 M4F	1994	10/1992 →	0-N1243	TB [TE]	



CM³



Art. Nr.



ohne Halter

400 (XW)							
420 GTI/GSI/Vitesse	02/92-04/95	20 M4F	1994	→ 10/1992		0-N897	TB [TE]
414 GSI/SI, 414 GSI/SI KAT	04/90-04/95	14 K4C, 14 K4D, 14 K4F	1396			0-N1412	VB [TE]
414 GSI/SI, 414 GSI/SI KAT	04/90-04/95	14 K4C, 14 K4D, 14 K4F	1396			0-N1584	VB [TE]
420 GSI/SLI/GTI/Vite, 420 GTI/GSI/Vitesse, 420 Turbo	02/92-04/95	20 M4F, 20 T4G, 20 T4H	1994			0-N1584	VB [TE]
400 Tourer (XW)							
1.6 i	05/94-11/98	D 16 Z2	1590	23x143; mit Zubehör		SK-1067	BTK
1.6 i	05/94-11/98	D 16 A8, D 16 Z2	1590	24x107; 10/1994 →		SK-1211	BTK
1.6 i	05/94-11/98	D 16 A8	1590	24x124		SK-1213	BTK
1.8 i	06/96-11/98	18 K4K	1796	26x143		SK-1507	BTK
1.8 i	06/96-11/98	18 K4K	1796	26x143		SK-1706	BTK
1.8 i	06/96-11/98	18 K4K	1796	26x143		SK-1706AQ1	BTKW
1.8 TD	09/93-11/98	XUD 7TE	1769	25.4x136		SK-1022	BTK
2.0 i	05/94-11/98	20 T4H	1994	22x132		SK-1500	BTK
1.6 i	05/94-11/98	D 16 A8, D 16 Z2	1590			0-N927	TB [TE]
1.8 i	06/96-11/98	18 K4K	1796			0-N894	TB [TE]
1.8 TD	09/93-11/98	XUD 7TE	1769			0-N900	TB [DG]
1.8 TD	09/93-11/98	XUD 7TE	1769			0-N901	TB [TE]
2.0 i	05/94-11/98	20 T4H	1994			0-N1243	TB [TE]
1.6 i	05/94-11/98	D 16 A8, D 16 Z2	1590			0-N1643	VB [BT] S
1.8 i	06/96-11/98	18 K4K	1796			0-N1412	VB [TE]
1.8 i	06/96-11/98	18 K4K	1796			0-N1584	VB [TE]
1.8 i	06/96-11/98	18 K4K	1796			0-N1643	VB [BT] S
2.0 i	05/94-11/98	20 T4H	1994			0-N1584	VB [TE]
600 (RH)							
618 i/Si	03/96-02/99	F 18 A3	1850	24x113; 16x70		SK-1220	BTK
620 i, 620 Si	08/93-02/99	F 20 Z1, F 20 Z2	1997	24x113; 16x70		SK-1220	BTK
620 Sdi	12/94-02/99	20 T2N	1994	28x112; 22x78; mit Zubehör		SK-1102	BTK
620 Ti Vitesse	07/94-02/99	20 T4G	1994	22x132		SK-1500	BTK
623 Si	08/93-02/99	H 23 A3	2259	16x70; 24x127		SK-1218	BTK
618 i/Si	03/96-02/99	F 18 A3	1850			0-N178	TB [TE]
618 i/Si	03/96-02/99	F 18 A3	1850			0-N905	TB [TE]
620 i, 620 Si	08/93-02/99	F 20 Z1, F 20 Z2	1997			0-N178	TB [TE]
620 i, 620 Si	08/93-02/99	F 20 Z1, F 20 Z2	1997			0-N905	TB [TE]
620 Sdi	12/94-02/99	20 T2N	1994			0-N1273	TB [TE]
620 Sdi	12/94-02/99	20 T2N	1994			0-N236	TB [TE]
620 Sdi	12/94-02/99	20 T2N	1994			0-N237	TB [DG]
620 Ti Vitesse	07/94-02/99	20 T4G	1994			0-N1243	TB [TE]
623 Si	08/93-02/99	H 23 A3	2259			0-N178	TB [TE]
623 Si	08/93-02/99	H 23 A3	2259			0-N905	TB [TE]
620 Sdi	12/94-02/99	20 T2N	1994	ch.BM246797→		0-N1535	VB [BT] S
620 Ti Vitesse	07/94-02/99	20 T4G	1994			0-N1584	VB [TE]
800 (XS)							
820 I/SI	01/92-02/99	20 T4H	1996	22x132		SK-1500	BTK
825 Si Lux	04/96-02/99	25 K4F	2497	22x58; 28x176; ohne Spanndämpfer, Spannrolle		SK-1502	BTK
825 Si/Sterling	10/86-12/91	C 25 A1, C 25 A2	2494	28x192		SK-1217	BTK
827 Si/Sterling	02/88-02/99	C 27 A1, C 27 A2	2675	28x192		SK-1217	BTK
820 16 V I/SI, 820 SI	10/86-12/91	20 HD, 20 HD M 16	1994	ch.→297485		0-N897	TB [TE]
820 I/SI	01/92-02/99	20 T4H	1996			0-N1243	TB [TE]
825 Si Lux	04/96-02/99	25 K4F	2497			0-N1248	TB [DG]
825 Si Lux	04/96-02/99	25 K4F	2497			0-N1261	TB [TE]
825 Si/Sterling	10/86-12/91	C 25 A1, C 25 A2	2494			0-N928	TB [TE]
827 Si/Sterling	02/88-02/99	C 27 A1, C 27 A2	2675			0-N928	TB [TE]
825 D/SD	01/90-02/99	425 SL1RR, 492 4 SHIRG	2500			0-N1540	VB [DG]
825 Si Lux	04/96-02/99	25 K4F	2497	☼		0-N1735	VB [DG]
825 Si Lux	04/96-02/99	25 K4F	2497	ch.230967→		0-N1742	VB [BT] S
800 Hatchback (XS)							
2.5 Sterling	10/88-10/91	C 25 A2	2494	28x192		SK-1217	BTK
2.5, 2.5 Si	02/96-10/98	25 K4F	2497	22x58; 28x176; ohne Spanndämpfer, Spannrolle		SK-1502	BTK
820 I/SI	01/93-02/99	20 T4H	1996	22x132		SK-1500	BTK
827 24V I/SI, 827 Vitesse, 827 Vitesse/SLI	10/88-02/99	C 27 A1, C 27 A2	2675	28x192		SK-1217	BTK
2.5, 2.5 Si	02/96-10/98	25 K4F	2497			0-N1261	TB [TE]



OPTIMAL®

ROVER



CM³



Art. Nr.



ohne Halter

800 Hatchback (XS)

820 I/SI	01/93-02/99	20 T4H	1996		0-N1243	TB [TE]	
820 i/Si, 820 SI	10/88-12/91	20 HD, 20 HD M 16	1994	ch.→297485	0-N897	TB [TE]	
827 24V I/SI, 827 Vitesse, 827 Vitesse/SLI	10/88-02/99	C 27 A1, C 27 A2	2675		0-N928	TB [TE]	
2.5, 2.5 Si	02/96-10/98	25 K4F	2497	✳	0-N1735	VB [DG]	
2.5, 2.5 Si	02/96-10/98	25 K4F	2497	ch.230967→	0-N1742	VB [BT]	S
825 D/SD	01/92-02/99	425 SL1RR, 492 4 SHIRG	2500		0-N1540	VB [DG]	

800 Coupe

825 Si	04/96-02/99	25 K4F	2497	22x58; 28x176; ohne Spanndämpfer, Spannrolle	SK-1502	BTK	
827 24V	08/92-02/99	C 27 A1	2675	28x192	SK-1217	BTK	
825 Si	04/96-02/99	25 K4F	2497		0-N1248	TB [DG]	
825 Si	04/96-02/99	25 K4F	2497		0-N1261	TB [TE]	
827 24V	08/92-02/99	C 27 A1	2675		0-N928	TB [TE]	
825 SD	09/93-02/99	425 SL1RR, 492 4 SHIRG	2500		0-N1540	VB [DG]	
825 Si	04/96-02/99	25 K4F	2497	✳	0-N1735	VB [DG]	
825 Si	04/96-02/99	25 K4F	2497	ch.230967→	0-N1742	VB [BT]	S

CABRIOLET (XW)

214 1.4	01/92-11/99	14 K4D	1396	23x143; 10/1992 →; mit Zubehör	SK-1067	BTK	
214 1.4, 214 1.4i 16V	04/90-11/99	14 K4C, 14 K4F	1396	23x143; mit Zubehör	SK-1067	BTK	
216 1.6i	01/92-11/99	D 16 A8	1590	24x124	SK-1213	BTK	
216 1.6i 16V	01/96-11/99	16 K4F	1588	23x143; mit Zubehör; Spannrollenbetätigung: manuell	SK-1067	BTK	
216 1.6i 16V	01/96-11/99	16 K4F	1588	26x145	SK-1504	BTK	
214 1.4, 214 1.4i 16V	04/90-11/99	14 K4C, 14 K4C, 14 K4D, 14 K4F	1396		0-N894	TB [TE]	
216 1.6i	01/92-11/99	D 16 A8	1590		0-N927	TB [TE]	
216 1.6i 16V	01/96-11/99	16 K4F	1588		0-N894	TB [TE]	
214 1.4, 214 1.4i 16V	04/90-11/99	14 K4C, 14 K4C, 14 K4D, 14 K4F	1396		0-N1412	VB [TE]	
214 1.4, 214 1.4i 16V	04/90-11/99	14 K4C, 14 K4C, 14 K4D, 14 K4F	1396		0-N1584	VB [TE]	
216 1.6i 16V	01/96-11/99	16 K4F	1588		0-N1412	VB [TE]	
216 1.6i 16V	01/96-11/99	16 K4F	1588		0-N1584	VB [TE]	

COUPE

1.6 16 V	03/96-11/99	16 K4F	1588	23x143; mit Zubehör; Spannrollenbetätigung: manuell	SK-1067	BTK	
1.6 16 V	03/96-11/99	16 K4F	1588	26x145	SK-1504	BTK	
1.8 16 V	03/96-11/99	18 K4K	1795	26x143	SK-1507	BTK	
1.8 16 V	03/96-11/99	18 K4K	1795	26x143; → 06/1999	SK-1706	BTK	
1.8 16 V	03/96-11/99	18 K4K	1795	26x143	SK-1706AQ1	BTKW	
1.6 16 V	03/96-11/99	16 K4F	1588		0-N894	TB [TE]	
1.8 16 V	03/96-11/99	18 K4K	1795		0-N894	TB [TE]	
1.6 16 V	03/96-11/99	16 K4F	1588		0-N1412	VB [TE]	
1.6 16 V	03/96-11/99	16 K4F	1588		0-N1584	VB [TE]	
1.8 16 V	03/96-11/99	18 K4K	1795		0-N1412	VB [TE]	
1.8 16 V	03/96-11/99	18 K4K	1795		0-N1584	VB [TE]	

MONTEGO

2.0 GTi	10/88-10/91	20 H	1994	17x104	SK-1176	BTK	
2.0 i KAT	12/90-10/94	20 H	1996	17x104	SK-1176	BTK	
2.0 D Turbo	10/88-10/95	BB	1996		0-N898	TB [TE]	
2.0 D Turbo	10/88-10/95	BB	1996		0-N899	TB [DG]	
2.0 i KAT	12/90-10/94	20 H	1996		0-N897	TB [TE]	

MONTEGO Estate (XE)

2.0 GTi	10/88-10/91	20 H	1994	17x104	SK-1176	BTK	
2.0 GTi/LXi	12/90-12/93	20 H	1996	17x104	SK-1176	BTK	
2.0 GTi/LXi	12/90-12/93	20 H	1996		0-N897	TB [TE]	
2.0 Turbo-D	01/93-12/93	BB	1996		0-N898	TB [TE]	
2.0 Turbo-D	01/93-12/93	BB	1996		0-N899	TB [DG]	

STREETWISE

1.4	08/03-05/05	14 K4F, 14 K4M	1396	23x143; mit Zubehör; Spannrollenbetätigung: manuell	SK-1067	BTK	
1.4	08/03-05/05	14 K4F, 14 K4M	1396	26x145	SK-1504	BTK	
1.6	01/04-05/05	16 K4F	1588	23x143; 10/2004 →; mit Zubehör; Spannrollenbetätigung: manuell	SK-1067	BTK	
1.6	01/04-05/05	16 K4F	1588	26x145; 10/2004 →	SK-1504	BTK	
1.8	08/03-05/05	18 K4F	1796	26x145	SK-1504	BTK	
2.0 TD	08/03-05/05	20 T2N	1994	30x112; 24x78; : → 1011; ✳	SK-1501	BTK	



CM³



Art. Nr.



STREETWISE

2.0 TD	08/03-05/05	20 T2N	1994	30x112; 24x78; :→9369;	SK-1501	BTK	
2.0 TD	08/03-05/05	20 T2N	1994	30x112; 24x78; :1012→;	SK-1552	BTK	
2.0 TD	08/03-05/05	20 T2N	1994	30x112; 24x78; :9370→;	SK-1552	BTK	
1.4	08/03-05/05	14 K4F, 14 K4M	1396		0-N1272	TB [TE]	
1.4	08/03-05/05	14 K4F, 14 K4M	1396		0-N894	TB [TE]	
1.6	01/04-05/05	16 K4F	1588		0-N894	TB [TE]	
1.8	08/03-05/05	18 K4F	1796		0-N1272	TB [TE]	
2.0 TD	08/03-05/05	20 T2N	1994	ch.471565→	0-N1120	TB [TE]	
2.0 TD	08/03-05/05	20 T2N	1994	ch.471565→; :→5048;	0-N1121	TB [TE]	
2.0 TD	08/03-05/05	20 T2N	1994	ch.471565→; :→8367;	0-N1121	TB [TE]	
2.0 TD	08/03-05/05	20 T2N	1994	ch.471565→	0-N1122	TB [DG]	
2.0 TD	08/03-05/05	20 T2N	1994	ch.→471564	0-N1273	TB [TE]	
2.0 TD	08/03-05/05	20 T2N	1994	:5049→	0-N1273	TB [TE]	
2.0 TD	08/03-05/05	20 T2N	1994	:8368→	0-N1273	TB [TE]	
2.0 TD	08/03-05/05	20 T2N	1994	ch.→471564	0-N236	TB [TE]	
2.0 TD	08/03-05/05	20 T2N	1994	ch.→471564	0-N237	TB [DG]	
1.4	08/03-05/05	14 K4F	1396		0-N1412	VB [TE]	
1.4	08/03-05/05	14 K4M	1396	manuell	0-N1412	VB [TE]	
1.4	08/03-05/05	14 K4F	1396		0-N1584	VB [TE]	
1.4	08/03-05/05	14 K4M	1396	ch.→YD471063	0-N1584	VB [TE]	
1.4	08/03-05/05	14 K4M	1396		0-N1643	VB [BT]	S
1.4	08/03-05/05	14 K4F, 14 K4M	1396	ch.YD471064→;	0-N1659	VB [BT]	S
1.6	01/04-05/05	16 K4F	1588		0-N1643	VB [BT]	S
1.8	08/03-05/05	18 K4F	1796	manuell	0-N1412	VB [TE]	
1.8	08/03-05/05	18 K4F	1796	ch.→YD471063	0-N1584	VB [TE]	
1.8	08/03-05/05	18 K4F	1796		0-N1643	VB [BT]	S
2.0 TD	08/03-05/05	20 T2N	1994		0-N1535	VB [BT]	S

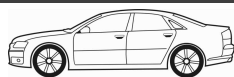
CM³

Art. Nr.

**900 II**

2.5 -24 V6	07/93-02/98	B258I	2498	30x225; mit Zubehör	SK-1508	BTK	
2.5 -24 V6	07/93-02/98	B258I	2498		0-N956	TB [TE]	
2.5 -24 V6	07/93-02/98	B258I	2498		0-N957	TB [DG]	
2.0 -16 Turbo, 2.0 i	07/93-02/98	B204I, B204L	1985	Rippenanzahl: 6	0-N1430	VB [DG]	
2.0 -16 Turbo, 2.0 i	07/93-02/98	B204I, B204L	1985	ch.→V088652	0-N1544	VB [DG]	
2.0 -16 Turbo, 2.0 i	07/93-02/98	B204I, B204L, B206I	1985		0-N2029	VB [BT]	S
2.3 -16	07/93-02/98	B234I	2290	Rippenanzahl: 6	0-N1430	VB [DG]	
2.3 -16	07/93-02/98	B234I	2290	ch.→V088652	0-N1544	VB [DG]	
2.3 -16	07/93-02/98	B234I	2290		0-N2029	VB [BT]	S
2.5 -24 V6	07/93-02/98	B258I	2498	Rippenanzahl: 6	0-N1438	VB [BT]	S
2.5 -24 V6	07/93-02/98	B258I	2498	☼	0-N1603	VB [DG]	

900 II Cabriolet

2.5 -24 V6	12/93-02/98	B258I	2498	30x225; mit Zubehör	SK-1508	BTK	
2.5 -24 V6	12/93-02/98	B258I	2498		0-N956	TB [TE]	
2.5 -24 V6	12/93-02/98	B258I	2498		0-N957	TB [DG]	
2.0 -16 Turbo, 2.0 i	12/93-02/98	B204I, B204L	1985	Rippenanzahl: 6	0-N1430	VB [DG]	
2.0 -16 Turbo, 2.0 i	12/93-02/98	B204I, B204L	1985	ch.→V088652	0-N1544	VB [DG]	
2.0 -16 Turbo, 2.0 i	12/93-02/98	B204I, B204L	1985		0-N2029	VB [BT]	S
2.3 -16	12/93-02/98	B234I	2290	Rippenanzahl: 6	0-N1430	VB [DG]	
2.3 -16	12/93-02/98	B234I	2290	ch.→V088652	0-N1544	VB [DG]	
2.3 -16	12/93-02/98	B234I	2290		0-N2029	VB [BT]	S
2.5 -24 V6	12/93-02/98	B258I	2498	Rippenanzahl: 6	0-N1438	VB [BT]	S
2.5 -24 V6	12/93-02/98	B258I	2498	☼	0-N1603	VB [DG]	

900 II Coupe

2.5 -24 V6	12/93-02/98	B258I	2498	30x225; mit Zubehör	SK-1508	BTK	
2.5 -24 V6	12/93-02/98	B258I	2498		0-N956	TB [TE]	
2.5 -24 V6	12/93-02/98	B258I	2498		0-N957	TB [DG]	
2.0 -16 Turbo, 2.0 i	12/93-02/98	B204I, B204L, B206I	1985	Rippenanzahl: 6	0-N1430	VB [DG]	
2.0 -16 Turbo, 2.0 i	12/93-02/98	B204I, B204L, B206I	1985	ch.→V088652	0-N1544	VB [DG]	
2.0 -16 Turbo, 2.0 i	12/93-02/98	B204I, B204L, B206I	1985		0-N2029	VB [BT]	S
2.3 -16	12/93-02/98	B234I	2290	Rippenanzahl: 6	0-N1430	VB [DG]	
2.3 -16	12/93-02/98	B234I	2290	ch.→V088652	0-N1544	VB [DG]	
2.3 -16	12/93-02/98	B234I	2290		0-N2029	VB [BT]	S
2.5 -24 V6	12/93-02/98	B258I	2498	Rippenanzahl: 6	0-N1438	VB [BT]	S
2.5 -24 V6	12/93-02/98	B258I	2498	☼	0-N1603	VB [DG]	

9000

3.0 -24 V6 CD/CDE	07/94-12/98	B308I	2962	30x225; mit Zubehör	SK-1508	BTK	
3.0 -24 V6 CD/CDE	07/94-12/98	B308I	2962		0-N956	TB [TE]	
3.0 -24 V6 CD/CDE	07/94-12/98	B308I	2962		0-N957	TB [DG]	
2.0 -16 CD, 2.0 -16 Turbo CD	09/92-12/98	B202I, B204I, B202S, B204E, B202S, B204E, B204S	1985		0-N1604	VB [TE]	
2.0 -16, 2.0 -16 Turbo, 2.0 -16 Turbo CD, 2.0 Carlsson, 2.0 T16	04/85-12/98	B202I, B202L, B202XL, B204L	1985	Generator-Ladestrom [A]: 115	0-N1544	VB [DG]	
2.0, 2.0 -16 CD, 2.0 -16 Turbo CD	10/88-12/98	B202I, B202I, B204I, B202S, B204E, B202S, B204E, B204S	1985		0-N1544	VB [DG]	
2.0, 2.0 -16 CD, 2.0 -16 Turbo CD	10/88-12/98	B202I, B202I, B204I, B202S, B204E, B202S, B204E, B204S	1985		0-N2180	VB [BT]	
2.0, 2.0 -16 CD, 2.0 -16 Turbo CD	10/88-12/98	B202I, B202I, B204I, B202S, B204E, B202S, B204E, B204S	1985		0-N2181	VB [VD]	
2.3 -16 CD, 2.3 -16 CD Turbo, 2.3 -16 CDE, 2.3 -16 CDE Eco-Power, 2.3 -16 Turbo	08/89-12/98	B234E, B234I, B234L	2290		0-N1604	VB [TE]	
2.3, 2.3 -16 CD, 2.3 -16 CD Turbo, 2.3 -16 CDE, 2.3 -16 CDE Eco-Power, 2.3 -16 Turbo	08/89-12/98	B234E, B234I, B234L, B234R	2290		0-N1544	VB [DG]	
2.3, 2.3 -16 CD, 2.3 -16 CD Turbo, 2.3 -16 CDE, 2.3 -16 CDE Eco-Power, 2.3 -16 Turbo	08/89-12/98	B234E, B234I, B234L, B234R	2290		0-N2180	VB [BT]	
2.3, 2.3 -16 CD, 2.3 -16 CD Turbo, 2.3 -16 CDE, 2.3 -16 CDE Eco-Power, 2.3 -16 Turbo	08/89-12/98	B234E, B234I, B234L, B234R	2290		0-N2181	VB [VD]	
3.0 -24 V6 CD/CDE	07/94-12/98	B308I	2962	Rippenanzahl: 6	0-N1438	VB [BT]	S
3.0 -24 V6 CD/CDE	07/94-12/98	B308I	2962	☼	0-N1603	VB [DG]	

9000 Schrägheck

3.0 -24 V6 CS/CSE	07/94-12/98	B308I	2962	30x225; mit Zubehör	SK-1508	BTK	
3.0 -24 V6 CS/CSE	07/94-12/98	B308I	2962		0-N956	TB [TE]	
3.0 -24 V6 CS/CSE	07/94-12/98	B308I	2962		0-N957	TB [DG]	

CM³

Art. Nr.



9000 Schrägheck							
2.0 -16 CS, 2.0 -16 ND Turbo	09/93-12/98	B202S, B204E, B204S, B204I	1985			0-N1544	VB [DG]
2.0 -16 CS, 2.0 -16 ND Turbo	09/93-12/98	B202S, B204E, B204S, B204I	1985			0-N1604	VB [TE]
2.0 -16 CS, 2.0 -16 ND Turbo	09/93-12/98	B202S, B204E, B204S, B204I	1985			0-N2180	VB [BT]
2.0 -16 CS, 2.0 -16 ND Turbo	09/93-12/98	B202S, B204E, B204S, B204I	1985			0-N2181	VB [VD]
2.0, 2.0 -16, 2.0 -16 CS, 2.0 -16 Turbo, 2.0 -16 Turbo CS, 2.0 16v, 2.0 T16	09/84-12/98	B202, B202I, B202L, B202L, B202XL, B202XI, B202XL	1985	Generator-Ladestrom [A]: 115		0-N1544	VB [DG]
2.3 -16 Aero CS, 2.3 -16 CS, 2.3 -16 CSE, 2.3 -16 CSE Eco Power, 2.3 -16 Turbo, 2.3 -16 Turbo CSE	09/89-12/98	B234E, B234I, B234L, B234R	2290			0-N1604	VB [TE]
2.3, 2.3 -16 Aero CS, 2.3 -16 CS, 2.3 -16 CSE, 2.3 -16 CSE Eco Power, 2.3 -16 Turbo, 2.3 -16 Turbo CSE	09/89-12/98	B234E, B234I, B234L, B234R	2290			0-N1544	VB [DG]
2.3, 2.3 -16 Aero CS, 2.3 -16 CS, 2.3 -16 CSE, 2.3 -16 CSE Eco Power, 2.3 -16 Turbo, 2.3 -16 Turbo CSE	09/89-12/98	B234E, B234I, B234L, B234R	2290			0-N2180	VB [BT]
2.3, 2.3 -16 Aero CS, 2.3 -16 CS, 2.3 -16 CSE, 2.3 -16 CSE Eco Power, 2.3 -16 Turbo, 2.3 -16 Turbo CSE	09/89-12/98	B234E, B234I, B234L, B234R	2290			0-N2181	VB [VD]
3.0 -24 V6 CS/CSE	07/94-12/98	B308I	2962	Rippenanzahl: 6		0-N1438	VB [BT] S
3.0 -24 V6 CS/CSE	07/94-12/98	B308I	2962	☼		0-N1603	VB [DG]
9-3 (YS3D)							
2.0 i, 2.0 SE Turbo, 2.0 Turbo	02/98-09/02	B204E, B204I, B204L, B205E, B205L, B204R, B205E, B205R	1985			0-N1410	VB [BT] S
2.0 i, 2.0 SE Turbo, 2.0 Turbo	02/98-09/02	B204E, B204I, B204L, B205E, B205L, B204R, B205E, B205R	1985	ch.X2028401, X7022779→; Rippenanzahl: 6		0-N1429	VB [DG]
2.0 i, 2.0 SE Turbo, 2.0 Turbo	02/98-09/02	B204E, B204I, B204L, B205E, B205L, B204R, B205E, B205R	1985	ch.→X2028400, X7022778; Rippenanzahl: 6		0-N1430	VB [DG]
2.2 TiD	02/98-09/02	D223L, D223L, X 22 DTH	2171			0-N1485	VB [BT] S
2.2 TiD	02/98-09/02	D223L, D223L, X 22 DTH	2171	☼		0-N2022	VB [BT] S
2.2 TiD	02/98-09/02	D223L, D223L, X 22 DTH	2171			0-N2169	VB [VD]
2.3 i, 2.3 Turbo	02/98-09/02	B234I, B235R	2290	ch.X2028401, X7022779→; Rippenanzahl: 6		0-N1429	VB [DG]
2.3 i, 2.3 Turbo	02/98-09/02	B234I, B235R	2290	ch.→X2028400, X7022778; Rippenanzahl: 6		0-N1430	VB [DG]
2.3, 2.3 i, 2.3 Turbo	02/98-09/02	B234I, B235R	2290			0-N1410	VB [BT] S
9-3 (YS3F)							
1.8 i	01/04-	Z 18 XE	1796	20x162; mit Zubehör		SK-1355	BTK
1.8 i	01/04-	Z 18 XE	1796	20x162; mit Zubehör		SK-1355AQ1	BTKW
1.9 TiD	09/04-	Z 19 DT	1910	24x190; → 07/2012		SK-1696	BTK
1.9 TiD	09/04-	Z 19 DT	1910	24x190		SK-1696AQ1	BTKW
1.9 TiD, 1.9 TTiD	09/04-	A 19 DTR, A 19 DTR, Z 19 DTR, Z 19 DTH	1910	24x199		SK-1586	BTK
1.9 TiD, 1.9 TTiD	09/04-	A 19 DTR, A 19 DTR, Z 19 DTR, Z 19 DTH	1910	24x199		SK-1586AQ1	BTKW
1.8 i	01/04-	Z 18 XE	1796			0-N1102	TB [TE]
1.8 i	01/04-	Z 18 XE	1796	†; mit Anbaumaterial		0-N300	TB [DG]
1.8 i	01/04-	Z 18 XE	1796			0-N953	TB [DG]
1.9 TiD, 1.9 TTiD	09/04-	A 19 DTR, A 19 DTR, Z 19 DTR, Z 19 DT, Z 19 DTH	1910			0-N115	TB [TE]
1.9 TiD, 1.9 TTiD	09/04-	A 19 DTR, A 19 DTR, Z 19 DTR, Z 19 DT, Z 19 DTH	1910			0-N2149	TB [DG]
1.8t, 1.8t BioPower, 2.0 t, 2.0 t Bio Power, 2.0 t BioPower, 2.0 t BioPower XWD, 2.0 t XWD, 2.0 Turbo XWD	09/02-	B207E, B207G, B207H, B207L, B207M, B207R	1998			0-N1588	VB [BT] S
1.8 i	01/04-	Z 18 XE	1796			0-N1466	VB [BT] S
1.9 TiD, 1.9 TTiD	09/04-	A 19 DTR, Z 19 DTR, Z 19 DT, Z 19 DTH	1910			0-N1503	VB [BT] S
1.9 TiD, 1.9 TTiD	09/04-	A 19 DTR, A 19 DTR, Z 19 DTR, Z 19 DT, Z 19 DTH	1910	☼		0-N1522	VB [DG]
1.9 TiD, 1.9 TTiD	09/04-	A 19 DTR, A 19 DTR, Z 19 DTR, Z 19 DT, Z 19 DTH	1910	Rippenanzahl: 6		0-N1667	VB [DG]
2.0 t, 2.0 t Bio Power, 2.0 t BioPower XWD, 2.0 t XWD	01/08-	A 20 NFT	1998			0-N2299	VB [BT] S
2.0 t, 2.0 t BioPower XWD, 2.0 t XWD	01/08-	A 20 NFT	1998			0-N2283	VB [DG]
2.2 TiD	09/02-	D223L	2171			0-N1485	VB [BT] S
2.2 TiD	09/02-	D223L	2171			0-N2169	VB [VD]
2.8 Turbo V6, 2.8 Turbo V6 XWD	03/05-	B284L, B284R, LP9	2792			0-N2194	VB [BT] S
2.8 Turbo V6, 2.8 Turbo V6 XWD	03/05-	B284L, B284R, LP9	2792			0-N2340	VB [DG]
9-3 Cabriolet (YS3D)							
2.0 i, 2.0 SE Turbo, 2.0 Turbo	02/98-08/03	B204E, B204I, B204L, B205E, B205L, B204R, B205E, B205R	1985			0-N1410	VB [BT] S
2.0 i, 2.0 SE Turbo, 2.0 Turbo	02/98-08/03	B204E, B204I, B204L, B205E, B205L, B204R, B205E, B205R	1985	ch.X2028401, X7022779→; Rippenanzahl: 6		0-N1429	VB [DG]
2.0 i, 2.0 SE Turbo, 2.0 Turbo	02/98-08/03	B204E, B204I, B204L, B205E, B205L, B204R, B205E, B205R	1985	ch.→X2028400, X7022778; Rippenanzahl: 6		0-N1430	VB [DG]

CM³

Art. Nr.

**9-3 Cabriolet (YS3D)**

2.3 i, 2.3 Turbo	02/98-08/03	B234i, B235R	2290	ch.X2028401, X7022779→; Rippenanzahl: 6	0-N1429	VB [DG]	
2.3 i, 2.3 Turbo	02/98-08/03	B234i, B235R	2290	ch.→X2028400, X7022778; Rippenanzahl: 6	0-N1430	VB [DG]	
2.3, 2.3 i, 2.3 Turbo	02/98-08/03	B234i, B235R	2290		0-N1410	VB [BT]	S

9-3 Cabriolet (YS3F)

1.9 TiD, 1.9 TTiD	01/06-	A 19 DTR, A 19 DTR, Z 19 DTR, Z 19 DTH	1910	24x199	SK-1586	BTK	
1.9 TiD, 1.9 TTiD	01/06-	A 19 DTR, Z 19 DTR, Z 19 DTH	1910	24x199	SK-1586AQ1	BTKW	
1.9 TiD, 1.9 TTiD	09/04-	A 19 DTR, A 19 DTR, Z 19 DTR, Z 19 DT, Z 19 DTH	1910		0-N2149	TB [DG]	
1.9 TiD, 1.9 TTiD	01/06-	A 19 DTR, A 19 DTR, Z 19 DTR, Z 19 DTH	1910		0-N115	TB [TE]	
1.8t, 1.8t BioPower, 2.0 t, 2.0 t BioPower	08/03-	B207E, B207G, B207H, B207L, B207M, B207R	1998		0-N1588	VB [BT]	S
1.8 i	01/04-	Z 18 XE	1796		0-N1466	VB [BT]	S
1.9 TiD, 1.9 TTiD	01/06-	A 19 DTR, Z 19 DTR, Z 19 DTH	1910		0-N1503	VB [BT]	S
1.9 TiD, 1.9 TTiD	01/06-	A 19 DTR, A 19 DTR, Z 19 DTR, Z 19 DTH	1910	✳	0-N1522	VB [DG]	
1.9 TiD, 1.9 TTiD	01/06-	A 19 DTR, A 19 DTR, Z 19 DTR, Z 19 DTH	1910	Rippenanzahl: 6	0-N1667	VB [DG]	
2.0 t, 2.0 t BioPower	01/11-	A 20 NFT	1998		0-N2283	VB [DG]	
2.0 t, 2.0 t BioPower	01/11-	A 20 NFT	1998		0-N2299	VB [BT]	S
2.8 Turbo V6	02/06-	B284L, B284R, LP9	2792		0-N2194	VB [BT]	S
2.8 Turbo V6	02/06-	B284L, B284R, LP9	2792		0-N2340	VB [DG]	

9-3 Kombi (YS3F)

1.8 i	03/05-	Z 18 XE	1796	20x162; mit Zubehör	SK-1355	BTK	
1.8 i	03/05-	Z 18 XE	1796	20x162; → 03/2009; mit Zubehör	SK-1355AQ1	BTKW	
1.9 TiD	03/05-	Z 19 DT	1910	24x190; → 07/2012	SK-1696	BTK	
1.9 TiD	03/05-	Z 19 DT	1910	24x190	SK-1696AQ1	BTKW	
1.9 TiD, 1.9 TTiD	03/05-	A 19 DTR, Z 19 DTH, Z 19 DTR	1910	24x199	SK-1586	BTK	
1.9 TiD, 1.9 TTiD	03/05-	A 19 DTR, Z 19 DTH, Z 19 DTR	1910	24x199	SK-1586AQ1	BTKW	
1.8 i	03/05-	Z 18 XE	1796		0-N102	TB [TE]	
1.8 i	03/05-	Z 18 XE	1796	†; mit Anbaumaterial	0-N300	TB [DG]	
1.8 i	03/05-	Z 18 XE	1796		0-N953	TB [DG]	
1.9 TiD, 1.9 TTiD	03/05-	A 19 DTR, Z 19 DT, Z 19 DTH, Z 19 DTR	1910		0-N115	TB [TE]	
1.9 TiD, 1.9 TTiD	03/05-	A 19 DTR, Z 19 DT, Z 19 DTH, Z 19 DTR	1910		0-N2149	TB [DG]	
1.8 i	03/05-	Z 18 XE	1796		0-N1466	VB [BT]	S
1.8 t, 2.0 T, 2.0 T Bio Power, 2.0 T Bio Power XWD, 2.0 t BioPower, 2.0 t BioPower XWD, 2.0 t XWD	03/05-	B207E, B207G, B207H, B207L, B207M, B207R	1998		0-N1588	VB [BT]	S
1.9 TiD, 1.9 TTiD	03/05-	Z 19 DT, Z 19 DTH, Z 19 DTR	1910		0-N1503	VB [BT]	S
1.9 TiD, 1.9 TTiD	03/05-	A 19 DTR, Z 19 DT, Z 19 DTH, Z 19 DTR	1910	✳	0-N1522	VB [DG]	
1.9 TiD, 1.9 TTiD	03/05-	A 19 DTR, Z 19 DT, Z 19 DTH, Z 19 DTR	1910	Rippenanzahl: 6	0-N1667	VB [DG]	
2.0 t, 2.0 t BioPower, 2.0 t BioPower XWD, 2.0 t XWD	01/11-	A 20 NFT	1998		0-N2283	VB [DG]	
2.0 t, 2.0 t BioPower, 2.0 t BioPower XWD, 2.0 t XWD	01/11-	A 20 NFT	1998		0-N2299	VB [BT]	S
2.8 Turbo V6, 2.8 Turbo V6 XWD	03/05-	B284L, B284R, LP9	2792		0-N2194	VB [BT]	S
2.8 Turbo V6, 2.8 Turbo V6 XWD	03/05-	B284L, B284R, LP9	2792		0-N2340	VB [DG]	

9-3X

1.9 TTiD	02/09-	A 19 DTR, Z 19 DTR	1910	24x199	SK-1586	BTK	
1.9 TTiD	02/09-	A 19 DTR, Z 19 DTR	1910	24x199	SK-1586AQ1	BTKW	
1.9 TTiD	02/09-	A 19 DTR, Z 19 DTR	1910		0-N115	TB [TE]	
1.9 TTiD	02/09-	A 19 DTR, Z 19 DTR	1910		0-N2149	TB [DG]	
1.9 TTiD	02/09-	A 19 DTR, Z 19 DTR	1910		0-N1503	VB [BT]	S
1.9 TTiD	02/09-	A 19 DTR, Z 19 DTR	1910	✳	0-N1522	VB [DG]	
1.9 TTiD	02/09-	A 19 DTR, Z 19 DTR	1910	Rippenanzahl: 6	0-N1667	VB [DG]	
2.0 T BioPower XWD	01/11-	A 20 NFT	1998		0-N2283	VB [DG]	
2.0 T BioPower XWD	01/11-	A 20 NFT	1998		0-N2299	VB [BT]	S
2.0 T BioPower XWD, 2.0 T XWD	02/09-	B207R	1998		0-N1588	VB [BT]	S

9-5 (YS3E)

1.9 TiD	01/06-12/09	Z 19 DTH	1910	24x199	SK-1586	BTK	
1.9 TiD	01/06-12/09	Z 19 DTH	1910	24x199	SK-1586AQ1	BTKW	
3.0 TiD	07/01-12/09	D308L	2958	25x116	SK-1611	BTK	
1.9 TiD	01/06-12/09	Z 19 DTH	1910		0-N115	TB [TE]	
1.9 TiD	01/06-12/09	Z 19 DTH	1910		0-N2149	TB [DG]	
3.0 TiD	07/01-12/09	D308L	2958		0-N1353	TB [TE]	
3.0 TiD	07/01-12/09	D308L	2958		0-N1354	TB [DG]	
3.0 TiD	07/01-12/09	D308L	2958		0-N1355	TB [DG]	
3.0 V6t	01/98-12/09	B308E	2962	EMM : →300418	0-N956	TB [TE]	

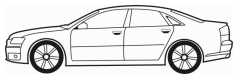
CM³

Art. Nr.

**9-5 (YS3E)**

3.0 V6t	01/98-12/09	B308E	2962	: →300418	0-N957	TB [DG]	
1.9 TiD	01/06-12/09	Z 19 DTH	1910		0-N1503	VB [BT]	S
1.9 TiD	01/06-12/09	Z 19 DTH	1910		0-N1522	VB [DG]	
1.9 TiD	01/06-12/09	Z 19 DTH	1910	Rippenanzahl: 6	0-N1667	VB [DG]	
2.0 t	09/97-12/09	B205E	1985		0-N1410	VB [BT]	S
2.0, 2.0 t, 2.0 t BioPower, 2.0 Turbo SE	09/97-12/09	B205E, B205F, B205L	1985		0-N1544	VB [DG]	
2.0, 2.0 T, 2.0 Turbo SE	09/97-12/09	B205E, B205F, B205L	1985	ch.X3022044 →; Rippenanzahl: 6	0-N1429	VB [DG]	
2.0, 2.0 T, 2.0 Turbo SE	09/97-12/09	B205E, B205F, B205L	1985	ch. →X3022043; Rippenanzahl: 6	0-N1430	VB [DG]	
2.2 TiD	03/02-12/09	D223L	2171		0-N1485	VB [BT]	S
2.2 TiD	03/02-12/09	D223L	2171		0-N2169	VB [VD]	
2.3 t, 2.3 Turbo	09/97-12/09	B235E, B235L, B235R	2290		0-N1410	VB [BT]	S
2.3 t, 2.3 Turbo	09/97-12/09	B235E, B235R	2290	ch.X3022044 →; Rippenanzahl: 6	0-N1429	VB [DG]	
2.3 t, 2.3 Turbo	09/97-12/09	B235E, B235R	2290	ch. →X3022043; Rippenanzahl: 6	0-N1430	VB [DG]	
2.3 t, 2.3 Turbo	01/01-12/09	B235E, B235L, B235R	2290	Rippenanzahl: 6	0-N1429	VB [DG]	
2.3, 2.3 t, 2.3 t BioPower, 2.3 Turbo	09/97-12/09	B235E, B235L, B235R	2290		0-N1544	VB [DG]	
3.0 TiD	07/01-12/09	D308L	2958	Rippenanzahl: 6	0-N1461	VB [DG]	
3.0 TiD	07/01-12/09	D308L	2958		0-N1633	VB [DG]	
3.0 TiD	07/01-12/09	D308L	2958		0-N1717	VB [BT]	S
3.0 TiD	07/01-12/09	D308L	2958		0-N1730	VB [DG]	
3.0 V6t	01/98-12/09	B308E	2962	Rippenanzahl: 6	0-N1438	VB [BT]	S

9-5 Kombi (YS3E)

1.9 TiD	01/06-12/09	Z 19 DTH, Z 19 DTR	1910	24x199	SK-1586	BTK	
1.9 TiD	01/06-12/09	Z 19 DTH, Z 19 DTR	1910	24x199	SK-1586AQ1	BTKW	
3.0 TiD	07/01-12/09	D308L	2958	25x116	SK-1611	BTK	
1.9 TiD	01/06-12/09	Z 19 DTH, Z 19 DTR	1910		0-N115	TB [TE]	
1.9 TiD	01/06-12/09	Z 19 DTH, Z 19 DTR	1910		0-N2149	TB [DG]	
3.0 TiD	07/01-12/09	D308L	2958		0-N1353	TB [TE]	
3.0 TiD	07/01-12/09	D308L	2958		0-N1354	TB [DG]	
3.0 TiD	07/01-12/09	D308L	2958		0-N1355	TB [DG]	
3.0 V6t	10/98-12/09	B308E	2962	: →300418	0-N956	TB [TE]	
3.0 V6t	10/98-12/09	B308E	2962	: →300418	0-N957	TB [DG]	
1.9 TiD	01/06-12/09	Z 19 DTH, Z 19 DTR	1910		0-N1503	VB [BT]	S
1.9 TiD	01/06-12/09	Z 19 DTH, Z 19 DTR	1910		0-N1522	VB [DG]	
1.9 TiD	01/06-12/09	Z 19 DTH, Z 19 DTR	1910	Rippenanzahl: 6	0-N1667	VB [DG]	
2.0 t	10/98-12/09	B204R, B205E	1985		0-N1410	VB [BT]	S
2.0, 2.0 t	10/98-12/09	B205E, B205F, B205L	1985	ch.X3022044 →; Rippenanzahl: 6	0-N1429	VB [DG]	
2.0, 2.0 t	10/98-12/09	B204R, B205E, B205F, B205L	1985	ch. →X3022043; Rippenanzahl: 6	0-N1430	VB [DG]	
2.0, 2.0 t, 2.0 t BioPower	10/98-12/09	B204R, B205E, B205F, B205L	1985		0-N1544	VB [DG]	
2.2 TiD	03/02-12/09	D223L	2171		0-N1485	VB [BT]	S
2.2 TiD	03/02-12/09	D223L	2171		0-N2169	VB [VD]	
2.3 t, 2.3 t BioPower, 2.3 Turbo	10/98-12/09	B235E, B235R	2290	ch.X3022044 →; Rippenanzahl: 6	0-N1429	VB [DG]	
2.3 t, 2.3 t BioPower, 2.3 Turbo	10/98-12/09	B235E, B235R	2290	ch. →X3022043; Rippenanzahl: 6	0-N1430	VB [DG]	
2.3 t, 2.3 Turbo	10/98-12/09	B235E, B235L, B235R	2290		0-N1410	VB [BT]	S
2.3 t, 2.3 Turbo	01/01-12/09	B235E, B235L, B235R	2290	Rippenanzahl: 6	0-N1429	VB [DG]	
2.3, 2.3 t, 2.3 t BioPower, 2.3 Turbo	10/98-12/09	B235E, B235L, B235R	2290		0-N1544	VB [DG]	
3.0 TiD	07/01-12/09	D308L	2958	Rippenanzahl: 6	0-N1461	VB [DG]	
3.0 TiD	07/01-12/09	D308L	2958		0-N1633	VB [DG]	
3.0 TiD	07/01-12/09	D308L	2958		0-N1717	VB [BT]	S
3.0 TiD	07/01-12/09	D308L	2958		0-N1730	VB [DG]	
3.0 V6t	10/98-12/09	B308E	2962	Rippenanzahl: 6	0-N1438	VB [BT]	S

9-5 (YS3G)

1.6 T	05/10-01/12	A 16 LET	1598	24x146	SK-1607	BTK	
2.0 TiD	05/10-01/12	A 20 DTH	1956	24x199	SK-1586	BTK	
2.0 TiD	05/10-01/12	A 20 DTH	1956	24x199	SK-1586AQ1	BTKW	
1.6 T	05/10-01/12	A 16 LET	1598		0-N1347	TB [TE]	
1.6 T	05/10-01/12	A 16 LET	1598		0-N1348	TB [DG]	
2.0 TiD, 2.0 T TiD, 2.0 T TiD XWD	05/10-01/12	A 20 DTH, A 20 DTR	1956		0-N2149	TB [DG]	
2.0 T TiD, 2.0 T TiD XWD	05/10-01/12	A 20 DTR	1956		0-N2236	TB [DG]	
1.6 T	05/10-01/12	A 16 LET	1598		0-N1799	VB [BT]	S
2.0 T, 2.0 T BioPower, 2.0 T BioPower XWD, 2.0 T XWD	05/10-01/12	A 20 NFT, A 20 NHT	1998		0-N2283	VB [DG]	
2.0 T, 2.0 T BioPower, 2.0 T BioPower XWD, 2.0 T XWD	05/10-01/12	A 20 NFT, A 20 NHT	1998		0-N2299	VB [BT]	S
2.0 TiD, 2.0 T TiD, 2.0 T TiD XWD	05/10-01/12	A 20 DTH, A 20 DTR	1956		0-N1649	VB [DG]	
2.0 TiD, 2.0 T TiD, 2.0 T TiD XWD	05/10-01/12	A 20 DTH, A 20 DTR	1956		0-N2087	VB [BT]	S



CM³



Art. Nr.



ohne Halter

9-5 (YS3G)

2.0 TiD, 2.0 TTiD, 2.0 TTiD XWD	05/10-01/12	A 20 DTH, A 20 DTR	1956		0-N2221	VB [DG]	
2.0 TiD, 2.0 TTiD, 2.0 TTiD XWD	05/10-01/12	A 20 DTH, A 20 DTR	1956	für Fahrzeuge mit elektrischer Servolenkung	0-N2254	VB [DG]	
2.8 T V6 XWD	05/10-01/12	A 28 NER	2792		0-N2194	VB [BT]	S

9-7X

4.2	12/05-	LL8	4160		0-N1685	VB [DG]	
-----	--------	-----	------	--	----------------	---------	--

99 [USA] Stufenheck

3.5 Flexfuel 4WD	01/74-12/74		1985		0-N185	TB [TE]	
------------------	-------------	--	------	--	---------------	---------	--



CM³



Art. Nr.



ohne Halter

PS10/ANIBAL

2.8 D 4x4	03/03-	8140.43P	2800	30x152	SK-1035	BTK	
2.8 D 4x4	03/03-	8140.43P	2798	30x154; für OE: 99456477	SK-1153	BTK	
2.8 D 4x4	03/03-	8140.43P	2798	mit Spanndämpfer, Spannrolle	SK-1681	BTK	
2.8 D, 2.8 D 4x4	12/02-	8140.43P	2798	30x152	SK-1035	BTK	

PS10/ANIBAL Pick-up

2.8 TD	12/02-	8140.43C	2798	30x154; 03/2003 →; für OE: 99456477	SK-1153	BTK	
2.8 TD	12/02-	8140.43C	2798	mit Spanndämpfer, Spannrolle	SK-1681	BTK	

SAMURAI

1.3 4x4	10/91-12/94	G13BA	1298	19.05x89; → 12/1991	SK-1248	BTK	
---------	-------------	-------	------	---------------------	----------------	-----	--



CM³



Art. Nr.



131							
2.4 Diesel	06/78-12/86	8144.61	2445			0-N1617	TB [BT]
2.4 Diesel	06/78-12/86	8144.61	2445			0-N816	TB [DG]
2.4 Diesel	06/78-12/86	8144.61	2445			0-N821	TB [DG]
ALHAMBRA (7V8, 7V9)							
1.8 T 20V	10/97-03/10	AJH	1781	23x150; 05/1998 →; mit Spanndämpfer, Spannrolle		SK-1337	BTK
1.8 T 20V	10/97-03/10	AJH	1781	23x150; 05/1998 →; mit Spanndämpfer, Spannrolle		SK-1337AQ1	BTKW
1.8 T 20V	10/97-03/10	AWC	1781	23x150; 05/1998 →		SK-1660	BTK
1.8 T 20V	10/97-03/10	AWC	1781	23x150; 05/1998 →		SK-1660AQ1	BTKW
1.8 T 20V	10/97-03/10	AJH	1781	23x150; 05/1998 →		SK-1709	BTK
1.8 T 20V	10/97-03/10	AWC	1781	23x150; 05/1998 →		SK-1710	BTK
1.9 TDI	04/96-03/10	ANU	1896	30x120; 12/2002 →; mit Zubehör		SK-1372	BTK
1.9 TDI	04/96-03/10	ANU	1896	30x120; 07/2002 →		SK-1372AQ2	BTKW
1.9 TDI	04/96-03/10	ANU	1896	30x120; 07/2002 →; Baumuster: Van		SK-1372AQ2	BTKW
1.9 TDI	04/96-03/10	1Z, AHU, ANU, AFN, AVG	1896	25.4x137; mit Zubehör		SK-1425	BTK
1.9 TDI	04/96-03/10	1Z, AHU, ANU	1896	30x120; → 07/2002; mit Zubehör		SK-1582	BTK
1.9 TDI	04/96-03/10	ANU	1896	30x120; → 07/2002; ohne Spanndämpfer, Spannrolle; mit Zubehör		SK-1582AQ1	BTKW
1.9 TDI	04/96-03/10	ANU	1896	30x120; → 07/2002; ohne Spanndämpfer, Spannrolle; mit Zubehör; Baumuster: Van		SK-1582AQ1	BTKW
1.9 TDI	04/96-03/10	1Z, AHU, ANU	1896	30x120; → 07/2002; mit Spanndämpfer, Spannrolle; mit Zubehör		SK-1583	BTK
1.9 TDI	04/96-03/10	ANU	1896	30x120; → 07/2002; mit Spanndämpfer, Spannrolle; mit Zubehör		SK-1583AQ1	BTKW
1.9 TDI	04/96-03/10	ANU	1896	30x120; → 07/2002; mit Spanndämpfer, Spannrolle; mit Zubehör; Baumuster: Van		SK-1583AQ1	BTKW
1.9 TDI	06/00-03/10	BVK	1896	30x120		SK-1372AQ2	BTKW
1.9 TDI	06/00-03/10	AUY	1896	30x120; 07/2002 →		SK-1372AQ2	BTKW
1.9 TDI	06/00-03/10	AUY	1896	30x120; → 07/2002; mit Zubehör		SK-1582	BTK
1.9 TDI	06/00-03/10	AUY	1896	30x120; → 07/2002; ohne Spanndämpfer, Spannrolle; mit Zubehör		SK-1582AQ1	BTKW
1.9 TDI	06/00-03/10	AUY	1896	30x120; → 07/2002; mit Spanndämpfer, Spannrolle; mit Zubehör		SK-1583	BTK
1.9 TDI	06/00-03/10	AUY	1896	30x120; → 07/2002; mit Spanndämpfer, Spannrolle; mit Zubehör		SK-1583AQ1	BTKW
1.9 TDI	11/02-11/08	ASZ	1896	30x120; Baumuster: Van		SK-1372AQ1	BTKW
1.9 TDI	05/05-05/07	BTB, BTB	1896	30x120		SK-1372AQ1	BTKW
1.9 TDI 4motion	06/00-03/10	AUY, BVK	1896	30x120; 07/2002 →		SK-1372AQ2	BTKW
1.9 TDI 4motion	06/00-03/10	AUY	1896	30x120; → 07/2002; mit Zubehör; Baumuster: 7V8, 7V9		SK-1582	BTK
1.9 TDI 4motion	06/00-03/10	AUY	1896	30x120; 06/2002 → 07/2002; mit Zubehör		SK-1582	BTK
1.9 TDI 4motion	06/00-03/10	AUY, BVK	1896	30x120; → 07/2002; ohne Spanndämpfer, Spannrolle; mit Zubehör		SK-1582AQ1	BTKW
1.9 TDI 4motion	06/00-03/10	AUY	1896	30x120; → 07/2002; mit Spanndämpfer, Spannrolle; mit Zubehör; Baumuster: 7V8, 7V9		SK-1583	BTK
1.9 TDI 4motion	06/00-03/10	AUY	1896	30x120; 06/2002 → 07/2002; mit Spanndämpfer, Spannrolle; mit Zubehör		SK-1583	BTK
1.9 TDI 4motion	06/00-03/10	AUY, BVK	1896	30x120; → 07/2002; mit Spanndämpfer, Spannrolle; mit Zubehör		SK-1583AQ1	BTKW
1.9 TDI, 1.9 TDI 4motion	06/00-03/10	AUY, BVK	1896	30x120; ch.→2003→; mit Zubehör		SK-1372	BTK
1.9 TDI, 1.9 TDI 4motion	06/00-03/10	AUY, BVK	1896	30x120; 07/2002 →; Baumuster: Van		SK-1372AQ2	BTKW
1.9 TDI, 1.9 TDI 4motion	06/00-03/10	AUY, BVK	1896	30x120; → 07/2002; ohne Spanndämpfer, Spannrolle; mit Zubehör; Baumuster: Van		SK-1582AQ1	BTKW
1.9 TDI, 1.9 TDI 4motion	06/00-03/10	AUY, BVK	1896	30x120; → 07/2002; mit Spanndämpfer, Spannrolle; mit Zubehör; Baumuster: Van		SK-1583AQ1	BTKW
1.9 TDI, 1.9 Tdi 4x4	11/02-11/08	ASZ, BTB, BTB	1896	30x120; mit Zubehör		SK-1372	BTK
2.0 i	04/96-03/10	ADY, ATM	1984	23x138		SK-1109	BTK
2.0 i	04/96-03/10	ATM	1984	23x138		SK-1109AQ2	BTKW
2.0 i	04/96-03/10	ADY, ATM	1984	18x124; mit Zubehör		SK-1120	BTK
2.0 TDI	11/05-03/10	BRT	1968	30x120; mit Zubehör		SK-1372	BTK
2.0 TDI	11/05-03/10	BRT	1968	30x120		SK-1372AQ2	BTKW
1.8 T 20V	10/97-03/10	AWC	1781	05/1998 →		0-N1042	TB [TE]
1.8 T 20V	10/97-03/10	AJH, AWC	1781			0-N1237	TB [BT]
1.8 T 20V	10/97-03/10	AJH, AWC	1781			0-N1316	TB [DG]
1.8 T 20V	10/97-03/10	AJH	1781	05/1998 →		0-N1654	TB [TE]
1.9 TDI	04/96-03/10	1Z, AHU	1896			0-N104	TB [TE]
1.9 TDI	04/96-03/10	ANU	1896	12/2002 →		0-N1045	TB [TE]
1.9 TDI	04/96-03/10	ANU	1896	12/2002 →		0-N1046	TB [DG]

CM³

Art. Nr.

**ALHAMBRA (7V8, 7V9)**

1.9 TDI	04/96-03/10	ANU	1896	→ 11/2002	0-N1048	TB [TE]	
1.9 TDI	04/96-03/10	ANU	1896	→ 11/2002	0-N1268	TB [DG]	
1.9 TDI	04/96-03/10	ANU	1896		0-N1274	TB [BT]	
1.9 TDI	04/96-03/10	1Z, AHU	1896		0-N128	TB [DG]	
1.9 TDI	08/96-06/00	AFN, AVG	1896		0-N104	TB [TE]	
1.9 TDI	08/96-06/00	AFN, AVG	1896		0-N128	TB [DG]	
1.9 TDI	11/02-11/08	ASZ, BTB, BTB	1896		0-N1045	TB [TE]	
1.9 TDI, 1.9 TDI 4motion	06/00-03/10	AUY, BVK	1896	12/2002 →	0-N1045	TB [TE]	
1.9 TDI, 1.9 TDI 4motion	06/00-03/10	AUY, BVK	1896	12/2002 →	0-N1046	TB [DG]	
1.9 TDI, 1.9 TDI 4motion	06/00-03/10	AUY, BVK	1896	→ 11/2002	0-N1048	TB [TE]	
1.9 TDI, 1.9 TDI 4motion	06/00-03/10	AUY, BVK	1896	→ 11/2002	0-N1268	TB [DG]	
1.9 TDI, 1.9 TDI 4motion	06/00-03/10	AUY, BVK	1896	→ 11/2002	0-N1274	TB [BT]	
1.9 TDI, 1.9 Tdi 4x4	11/02-11/08	ASZ, BTB, BTB	1896		0-N1046	TB [DG]	
2.0 i	04/96-03/10	ATM	1984		0-N157	TB [TE]	
2.0 i	04/96-03/10	ADY	1984		0-N805	TB [TE]	
2.0 TDI	11/05-03/10	BRT	1968		0-N1045	TB [TE]	
2.0 TDI	11/05-03/10	BRT	1968		0-N1046	TB [DG]	
1.9 TDI	04/96-03/10	1Z, AHU	1896		0-N1417	VB [TE]	
1.9 TDI	04/96-03/10	ANU	1896		0-N1494	VB [BT]	S
1.9 TDI	04/96-03/10	1Z, AHU	1896		0-N1609	VB [BT]	
1.9 TDI	08/96-06/00	AFN, AVG	1896		0-N1417	VB [TE]	
1.9 TDI	08/96-06/00	AFN, AVG	1896		0-N1609	VB [BT]	
1.9 TDI, 1.9 TDI 4motion	06/00-03/10	ASZ, AUY, BVK, BTB, BTB	1896		0-N1494	VB [BT]	S
2.0 i	04/96-03/10	ADY	1984		0-N1417	VB [TE]	
2.0 i	04/96-03/10	ADY	1984		0-N1660	VB [BT]	
2.0 TDI	11/05-03/10	BRT	1968		0-N1531	VB [BT]	S
2.8 V6, 2.8 V6 4motion	06/00-03/10	AUE, AYL	2792	Rippenanzahl: 6	0-N1496S	VB [TE]	

ALHAMBRA (710, 711)

2.0 TDI	06/10-05/11	CFFA, CFFB, CFGB	1968	25x160; → 11/2010	SK-1695	BTK	
2.0 TDI	06/10-05/11	CFFA, CFFB, CFGB	1968	25x160; → 11/2010	SK-1695AQ1	BTKW	
2.0 TDI	06/10-05/11	CFFA, CFFB, CFGB	1968	25x160; 12/2010 →	SK-1727	BTK	
2.0 TDI	06/10-05/11	CFFA, CFFB, CFGB	1968	25x160; → 11/2010	SK-1727AQ2	BTKW	
2.0 TDI, 2.0 TDI Allrad	05/11-	CFFB, CFFE, CFGB	1968	25x160	SK-1727	BTK	
2.0 TDI, 2.0 TDI Allrad	05/11-	CFFB, CFFE	1968	25x160	SK-1727AQ2	BTKW	
2.0 TDI, 2.0 TDI Allrad	06/10-05/11	CFFA, CFFB, CFFE, CFGB	1968		0-N131	TB [DG]	
2.0 TDI, 2.0 TDI Allrad	06/10-05/11	CFFA, CFFB, CFFE, CFGB	1968		0-N2061	TB [TE]	
2.0 TDI, 2.0 TDI Allrad	06/10-05/11	CFFA, CFFB, CFFE, CFGB	1968		0-N2200	TB [DG]	
1.4 TSI	06/10-	CAVA, CNWB, CTHA	1390		0-N2050	VB [DG]	
1.4 TSI	06/10-	CAVA, CNWB, CTHA	1390		0-N2091	VB [BT]	S
1.4 TSI	06/10-	CAVA, CNWB, CTHA	1390		0-N2092	VB [BT]	S
1.4 TSI	06/10-	CAVA, CNWB, CTHA	1390		0-N2111	VB [BT]	S
1.4 TSI	06/10-	CAVA, CNWB, CTHA	1390	Rippenanzahl: 6	0-N2133	VB [DG]	
2.0 TDI, 2.0 TDI Allrad	06/10-05/11	CFFA, CFFB, CFFE, CFGB, CFGB	1968		0-N1534	VB [BT]	S
2.0 TSI	11/10-	CCZA	1984		0-N1832	VB [BT]	S

ALTEA (5P1)

1.4 16V	05/06-	BXW, CGGB	1390	20x130; 17x58; beinhaltetete Rollen: 4	SK-1511	BTK	
1.4 16V	05/06-	BXW, CGGB	1390	20x130; 17x58; beinhaltetete Rollen: 4	SK-1511AQ1	BTKW	
1.6	03/04-	BGU, BSE, BSF, CCSA	1595	23x138; Baumuster: 5P1	SK-1109	BTK	
1.6	03/04-	BGU	1595	23x138	SK-1109AQ1	BTKW	
1.6 LPG	09/09-	CHGA	1595	23x138; Baumuster: 5P1	SK-1109	BTK	
1.6 LPG	09/09-	CHGA	1595	23x138	SK-1109AQ1	BTKW	
1.6 TDI	10/09-	CAYB, CAYC	1598	25x160	SK-1695	BTK	
1.6 TDI	10/09-	CAYB, CAYC	1598	25x160; → 12/2010	SK-1695AQ1	BTKW	
1.6 TDI	10/09-	CAYC	1598	25x160; → 2010	SK-1727AQ1	BTKW	
1.6 TDI	10/09-	CAYC	1598	25x160; → 11/2010; 2011→	SK-1727AQ2	BTKW	
1.6 TDI	11/10-	CAYC	1598	25x160; → 11/2010	SK-1727AQ2	BTKW	
1.9 TDI	04/04-	BJB, BKC, BLS, BXE, BXF	1896	30x120; mit Zubehör	SK-1372	BTK	
1.9 TDI	04/04-	BJB, BKC, BLS, BXE, BXF	1896	30x120	SK-1372AQ1	BTKW	
2.0 FSI	05/04-03/09	BLR, BLY, BVY, BVZ	1984	23x148	SK-1724AQ2	BTKW	
2.0 FSI, 2.0 TFSI	05/04-05/09	BLR, BLY, BVY, BVZ, BWA	1984	23x148	SK-1724	BTK	
2.0 TDI	03/04-05/09	AZV	1968	30x141; ch.→5P-7-032500; mit Zubehör	SK-1595	BTK	
2.0 TDI	03/04-05/09	AZV	1968	30x141; ch.→5P-7-032500; mit Zubehör	SK-1595AQ1	BTKW	
2.0 TDI	03/04-05/09	AZV	1968	30x141; ch.5P-7-032501→; mit Zubehör	SK-1668	BTK	
2.0 TDI	03/04-05/09	AZV	1968	30x141; ch.5P-7-032501→	SK-1668AQ1	BTKW	



CM³



Art. Nr.



ALTEA (5P1)

2.0 TDI	11/05-	BMM	1968	30x120; mit Zubehör	SK-1372	BTK	
2.0 TDI	11/05-	BMM	1968	30x120	SK-1372AQ2	BTKW	
2.0 TDI	03/06-	BMN	1968	30x141; mit Zubehör	SK-1668	BTK	
2.0 TDI	03/06-	BMN	1968	30x141	SK-1668AQ1	BTKW	
2.0 TDI	03/06-	CEGA	1968	30x160	SK-1694	BTK	
2.0 TDI	03/06-	CEGA	1968	30x160	SK-1694AQ2	BTKW	
2.0 TDI	03/06-	BMN, CEGA	1968	25x160; → 11/2010	SK-1695	BTK	
2.0 TDI 16V	03/04-	BKD	1968	30x141; ch.→5P-7-032500; mit Zubehör	SK-1595	BTK	
2.0 TDI 16V	03/04-	BKD	1968	30x141; ch.→5P-7-032500; mit Zubehör	SK-1595AQ1	BTKW	
2.0 TDI 16V	03/04-	BKD	1968	30x141; ch.5P-7-032501→; mit Zubehör	SK-1668	BTK	
2.0 TDI 16V	03/04-	BKD	1968	30x141; ch.5P-7-032501→	SK-1668AQ1	BTKW	
2.0 TDI 16V	03/04-	CFHC	1968	25x160; → 11/2010	SK-1695	BTK	
2.0 TDI 16V	03/04-	CFHC	1968	25x160; → 11/2010	SK-1695AQ1	BTKW	
2.0 TDI 16V	03/04-	CFHC	1968	25x160; 12/2010 →	SK-1727	BTK	
2.0 TDI 16V	03/04-	CFHC	1968	25x160; → 11/2010	SK-1727AQ2	BTKW	
2.0 TFSI	04/06-05/09	BWA	1984	23x148	SK-1724AQ1	BTKW	
1.4 16V	05/06-	BXW, CGGB	1390		0-N1262	TB [DG]	
1.4 16V	05/06-	BXW, CGGB	1390		0-N1263	TB [TE]	
1.4 16V	05/06-	BXW, CGGB	1390		0-N158	TB [TE]	
1.4 16V	05/06-	BXW, CGGB	1390		0-N164	TB [DG]	
1.6 TDI	10/09-	CAYB, CAYC	1598		0-N131	TB [DG]	
1.6 TDI	10/09-	CAYB, CAYC	1598		0-N2025	TB [DG]	
1.6 TDI	10/09-	CAYB, CAYC	1598		0-N2061	TB [TE]	
1.6 TDI	10/09-	CAYB, CAYC	1598		0-N2200	TB [DG]	
1.6, 1.6 LPG	03/04-	BGU, BSE, BSF, CCSA, CMXA, CHGA	1595		0-N157	TB [TE]	
1.9 TDI	04/04-	BJB, BKC, BLS, BXE, BXF	1896		0-N1045	TB [TE]	
1.9 TDI	04/04-	BJB, BKC, BLS, BXE, BXF	1896		0-N1046	TB [DG]	
2.0 FSI, 2.0 TFSI	05/04-05/09	BLR, BLY, BVY, BVZ, BWA	1984		0-N1316	TB [DG]	
2.0 FSI, 2.0 TFSI	05/04-05/09	BLR, BLY, BVY, BVZ, BWA	1984		0-N1346	TB [DG]	
2.0 FSI, 2.0 TFSI	05/04-05/09	BLR, BLY, BVY, BVZ, BWA	1984		0-N2208	TB [TE]	
2.0 TDI	03/04-05/09	AZV, BMM	1968		0-N1046	TB [DG]	
2.0 TDI	03/04-05/09	AZV	1968		0-N1335	TB [TE]	
2.0 TDI	03/04-05/09	AZV	1968	ch.→5P-7-032500	0-N1336	TB [DG]	
2.0 TDI	03/04-05/09	AZV	1968	ch.5P-7-032501→	0-N1575	TB [DG]	
2.0 TDI	11/05-	BMM	1968		0-N1045	TB [TE]	
2.0 TDI	03/06-	BMN, CEGA	1968		0-N1046	TB [DG]	
2.0 TDI	03/06-	CEGA	1968		0-N1268	TB [DG]	
2.0 TDI	03/06-	BMN	1968		0-N1335	TB [TE]	
2.0 TDI	03/06-	CEGA	1968		0-N1336	TB [DG]	
2.0 TDI	03/06-	BMN	1968		0-N1575	TB [DG]	
2.0 TDI	03/06-	CEGA	1968		0-N1905	TB [BT]	
2.0 TDI	03/06-	BMN, CEGA	1968		0-N2025	TB [DG]	
2.0 TDI 16V	03/04-	BKD, CBDB	1968		0-N1046	TB [DG]	
2.0 TDI 16V	03/04-	CFHC	1968	→ 11/2010	0-N1046	TB [DG]	
2.0 TDI 16V	03/04-	CBDB	1968		0-N1268	TB [DG]	
2.0 TDI 16V	03/04-	CFHC	1968		0-N131	TB [DG]	
2.0 TDI 16V	03/04-	BKD	1968		0-N1335	TB [TE]	
2.0 TDI 16V	03/04-	CBDB	1968		0-N1336	TB [DG]	
2.0 TDI 16V	03/04-	BKD	1968	ch.→5P-7-032500	0-N1336	TB [DG]	
2.0 TDI 16V	03/04-	BKD	1968	ch.5P-7-032501→	0-N1575	TB [DG]	
2.0 TDI 16V	03/04-	CBDB	1968		0-N1905	TB [BT]	
2.0 TDI 16V	03/04-	CFHC	1968		0-N2025	TB [DG]	
2.0 TDI 16V	03/04-	CFHC	1968		0-N2061	TB [TE]	
2.0 TDI 16V	03/04-	CFHC	1968	12/2010 →	0-N2200	TB [DG]	
1.2 TSI	04/10-	CBZB	1197	⊛	0-N1733	VB [BT]	S
1.2 TSI	04/10-	CBZB	1197	⊛	0-N2121	VB [DG]	
1.4 16V	05/06-	BXW, CGGB	1390	⊛	0-N1445	VB [BT]	S
1.4 TSI	11/07-	CAXC	1390	⊛ ⊛	0-N1454	VB [DG]	
1.4 TSI	11/07-	CAXC	1390	⊛	0-N1525	VB [BT]	S
1.4 TSI	11/07-	CAXC	1390	⊛	0-N1733	VB [BT]	S
1.6 TDI	10/09-	CAYB, CAYC	1598		0-N1534	VB [BT]	S
1.8 TFSI	01/07-	BYT, BZB, CDA	1798		0-N1832	VB [BT]	S
1.9 TDI	04/04-	BJB, BKC, BLS	1896	ch.→5P-5-165000	0-N1530	VB [BT]	S
1.9 TDI	04/04-	BXE	1896		0-N1531	VB [BT]	S
1.9 TDI	04/04-	BJB, BKC, BLS	1896	ch.5P-6-000001→	0-N1531	VB [BT]	S

CM³

Art. Nr.



ALTEA (5P1)							
1.9 TDI	08/09-	BXF	1896			0-N1531	VB [BT] S
2.0 TDI	03/04-05/09	AZV	1968			0-N1530	VB [BT] S
2.0 TDI	11/05-	BMM	1968	ch.→5P-5-165000		0-N1530	VB [BT] S
2.0 TDI	11/05-	BMM	1968	ch.5P-6-000001→		0-N1531	VB [BT] S
2.0 TDI	03/06-	BMN	1968			0-N1530	VB [BT] S
2.0 TDI 16V	03/04-	BKD	1968			0-N1530	VB [BT] S
2.0 TDI, 2.0 TDI 16V	03/04-	CEGA	1968			0-N1534	VB [BT] S
2.0 TFSI	04/06-05/09	BWA	1984			0-N1656	VB [BT] S
ALTEA XL (5P5, 5P8)							
1.4 16V	10/06-	BXW, CGGB	1390	20x130; 17x58; beinhaltete Rollen: 4		SK-1511	BTK
1.4 16V	10/06-	BXW, CGGB	1390	20x130; 17x58; beinhaltete Rollen: 4		SK-1511AQ1	BTKW
1.6	10/06-	BSE, BSF, CCSA, CMXA	1595	23x138; Baumuster: 5P5, 5P8		SK-1109	BTK
1.6 LPG	09/09-	CHGA	1595	23x138		SK-1109	BTK
1.6 Multifuel	10/06-	CCSA	1595	23x138; Baumuster: 5P5, 5P8		SK-1109	BTK
1.6 TDI	10/09-	CAYB, CAYC	1598	25x160		SK-1695	BTK
1.6 TDI	10/09-	CAYC	1598	25x160; → 11/2010		SK-1695AQ1	BTKW
1.6 TDI	10/09-	CAYC	1598	25x160; → 12/2010; Baumuster: Freetrack		SK-1695AQ1	BTKW
1.6 TDI	10/09-	CAYC	1598	25x160; →2010		SK-1727AQ1	BTKW
1.6 TDI	10/09-	CAYC	1598	25x160; → 11/2010; 2011→		SK-1727AQ2	BTKW
1.6 TDI	11/10-	CAYB	1598	25x160; → 12/2010		SK-1695AQ1	BTKW
1.6 TDI	11/10-	CAYC	1598	25x160; → 11/2010		SK-1727AQ2	BTKW
1.6, 1.6 LPG, 1.6 Multifuel	10/06-	BSE, BSF, CCSA, CMXA, CCSA, CHGA	1595	23x138		SK-1109AQ1	BTKW
1.9 TDI	10/06-	BKC	1896	30x120; mit Zubehör		SK-1372	BTK
1.9 TDI	10/06-	BKC, BLS, BXE, BXF	1896	30x120		SK-1372AQ1	BTKW
1.9 TDI	08/09-	BXF	1896	30x120; mit Zubehör		SK-1372	BTK
2.0 FSI	10/06-03/09	BVY, BVZ	1984	23x148		SK-1724AQ2	BTKW
2.0 FSI, 2.0 TFSI	10/06-05/09	BVY, BVZ, BWA	1984	23x148		SK-1724	BTK
2.0 TDI	11/06-03/09	AZV	1968	30x141; ch.→5P-7-032500; mit Zubehör		SK-1595	BTK
2.0 TDI	11/06-03/09	AZV	1968	30x141; ch.→5P-7-032500; mit Zubehör		SK-1595AQ1	BTKW
2.0 TDI	11/06-03/09	AZV	1968	30x141; ch.5P-7-032501→; mit Zubehör		SK-1668	BTK
2.0 TDI	11/06-03/09	AZV	1968	30x141; ch.5P-7-032501→		SK-1668AQ1	BTKW
2.0 TDI	06/07-	BMN	1968	30x141; mit Zubehör		SK-1668	BTK
2.0 TDI	06/07-	BMN	1968	30x141		SK-1668AQ1	BTKW
2.0 TDI	06/07-	CEGA	1968	30x160; → 05/2010		SK-1694	BTK
2.0 TDI	06/07-	BMN, CEGA	1968	30x160; 05/2009 → 10/2010		SK-1694	BTK
2.0 TDI 16V	10/06-	BKD	1968	30x141; ch.→5P-7-032500; mit Zubehör		SK-1595	BTK
2.0 TDI 16V	10/06-	BKD	1968	30x141; ch.5P-7-032501→; mit Zubehör		SK-1668	BTK
2.0 TDI 16V	10/06-	BKD	1968	30x141		SK-1668AQ1	BTKW
2.0 TDI 16V	10/06-	BKD, CFHC	1968	25x160; 09/2010 → 11/2010		SK-1695	BTK
2.0 TDI 16V	10/06-	CFHC	1968	25x160; → 11/2010		SK-1695AQ1	BTKW
2.0 TDI 16V	10/06-	CFHC	1968	25x160; 12/2010 →		SK-1727	BTK
2.0 TDI 16V 4x4	10/10-	CFHC	1968	25x160; → 11/2010		SK-1695	BTK
2.0 TDI 16V 4x4	10/10-	CFHC	1968	25x160; → 11/2010		SK-1695AQ1	BTKW
2.0 TDI 16V 4x4	10/10-	CFHC	1968	25x160; → 11/2010; Baumuster: Freetrack		SK-1695AQ1	BTKW
2.0 TDI 16V 4x4	10/10-	CFHC	1968	25x160; 12/2010 →		SK-1727	BTK
2.0 TDI 16V, 2.0 TDI 16V 4x4	10/06-	CFHC	1968	25x160; → 11/2010		SK-1727AQ2	BTKW
2.0 TDI 4x4	06/07-	BMN	1968	30x141; 05/2008 →; mit Zubehör		SK-1668	BTK
2.0 TDI 4x4	06/07-	BMN	1968	30x141; Baumuster: Freetrack		SK-1668AQ1	BTKW
2.0 TDI 4x4	06/07-	CEGA	1968	30x160; 05/2008 →		SK-1694	BTK
2.0 TDI 4x4	06/07-	CFJA	1968	25x160; 05/2008 → 11/2010		SK-1695	BTK
2.0 TDI 4x4	06/07-	CFJA	1968	25x160; → 11/2010; Baumuster: Freetrack		SK-1695AQ1	BTKW
2.0 TDI 4x4	06/07-	CFJA	1968	25x160; 12/2010 →		SK-1727	BTK
2.0 TDI 4x4	06/07-	CFJA	1968	25x160; → 11/2010		SK-1727AQ2	BTKW
2.0 TDI, 2.0 TDI 4x4	10/06-	BMM	1968	30x120; mit Zubehör		SK-1372	BTK
2.0 TDI, 2.0 TDI 4x4	10/06-	BMM	1968	30x120; Baumuster: Freetrack		SK-1372AQ2	BTKW
2.0 TDI, 2.0 TDI 4x4	06/07-	CEGA	1968	30x160		SK-1694AQ2	BTKW
2.0 TFSI	10/06-05/09	BWA	1984	23x148		SK-1724AQ1	BTKW
2.0 TFSI 4x4	06/07-05/09	BWA	1984	23x148; Baumuster: Freetrack		SK-1724	BTK
2.0 TFSI 4x4	06/07-05/09	BWA	1984	23x148; Baumuster: Freetrack		SK-1724AQ1	BTKW
1.4 16V	10/06-	BXW, CGGB	1390			0-N1262	TB [DG]
1.4 16V	10/06-	BXW, CGGB	1390			0-N1263	TB [TE]
1.4 16V	10/06-	BXW, CGGB	1390			0-N158	TB [TE]
1.4 16V	10/06-	BXW, CGGB	1390			0-N164	TB [DG]
1.6 TDI	10/09-	CAYB, CAYC	1598			0-N131	TB [DG]
1.6 TDI	10/09-	CAYB, CAYC	1598			0-N2025	TB [DG]



CM³



Art. Nr.



ALTEA XL (5P5, 5P8)

1.6 TDI	10/09-	CAYB, CAYC	1598		0-N2061	TB [TE]	
1.6 TDI	10/09-	CAYB, CAYC	1598		0-N2200	TB [DG]	
1.6, 1.6 LPG, 1.6 Multifuel	10/06-	BSE, BSF, CCSA, CMXA, CCSA, CHGA	1595		0-N157	TB [TE]	
1.9 TDI	10/06-	BKC, BLS, BXE, BXF	1896		0-N1045	TB [TE]	
1.9 TDI	10/06-	BKC, BLS, BXE, BXF	1896		0-N1046	TB [DG]	
2.0 FSI, 2.0 TFSI 4x4	10/06-05/09	BVY, BVZ, BWA	1984		0-N1316	TB [DG]	
2.0 FSI, 2.0 TFSI 4x4	10/06-05/09	BVY, BVZ, BWA	1984		0-N1346	TB [DG]	
2.0 FSI, 2.0 TFSI 4x4	10/06-05/09	BVY, BVZ, BWA	1984		0-N2208	TB [TE]	
2.0 TDI	11/06-03/09	AZV, BMN, CEGA	1968		0-N1335	TB [TE]	
2.0 TDI	11/06-03/09	AZV	1968	ch.→5P-7-032500	0-N1336	TB [DG]	
2.0 TDI	11/06-03/09	AZV	1968	ch.5P-7-032501→	0-N1575	TB [DG]	
2.0 TDI 16V	10/06-	BKD, CBDB	1968		0-N1046	TB [DG]	
2.0 TDI 16V	10/06-	CFHC	1968	→ 11/2010	0-N1046	TB [DG]	
2.0 TDI 16V	10/06-	CFHC	1968		0-N131	TB [DG]	
2.0 TDI 16V	10/06-	BKD	1968		0-N1335	TB [TE]	
2.0 TDI 16V	10/06-	BKD	1968	ch.→5P-7-032500	0-N1336	TB [DG]	
2.0 TDI 16V	10/06-	BKD	1968	ch.5P-7-032501→	0-N1575	TB [DG]	
2.0 TDI 16V	10/06-	CBDB	1968		0-N1905	TB [BT]	
2.0 TDI 16V	10/06-	CFHC	1968		0-N2025	TB [DG]	
2.0 TDI 16V	10/06-	CFHC	1968		0-N2061	TB [TE]	
2.0 TDI 16V	10/06-	CFHC	1968	12/2010 →	0-N2200	TB [DG]	
2.0 TDI 16V 4x4	10/10-	CFHC	1968		0-N131	TB [DG]	
2.0 TDI 4x4	06/07-	CFJA	1968	→ 11/2010	0-N1046	TB [DG]	
2.0 TDI 4x4	06/07-	CFJA	1968		0-N131	TB [DG]	
2.0 TDI 4x4	06/07-	BMN	1968		0-N1335	TB [TE]	
2.0 TDI 4x4	06/07-	CFJA	1968		0-N2025	TB [DG]	
2.0 TDI 4x4	06/07-	CFJA	1968		0-N2061	TB [TE]	
2.0 TDI 4x4	06/07-	CFJA	1968	12/2010 →	0-N2200	TB [DG]	
2.0 TDI, 2.0 TDI 4x4	10/06-	BMM	1968		0-N1045	TB [TE]	
2.0 TDI, 2.0 TDI 4x4	10/06-03/09	AZV, BMM	1968		0-N1046	TB [DG]	
2.0 TDI, 2.0 TDI 4x4	06/07-	BMN, CEGA	1968		0-N1046	TB [DG]	
2.0 TDI, 2.0 TDI 4x4	06/07-	CEGA	1968		0-N1268	TB [DG]	
2.0 TDI, 2.0 TDI 4x4	06/07-	CEGA	1968		0-N1336	TB [DG]	
2.0 TDI, 2.0 TDI 4x4	06/07-	BMN	1968		0-N1575	TB [DG]	
2.0 TDI, 2.0 TDI 4x4	06/07-	CEGA	1968		0-N1905	TB [BT]	
1.2 TSI	04/10-	CBZB	1197	⊛	0-N1733	VB [BT]	S
1.2 TSI	04/10-	CBZB	1197	⊛	0-N2121	VB [DG]	
1.4 16V	10/06-	BXW, CGGB	1390	⊛	0-N1445	VB [BT]	S
1.4 TSI	11/07-	CAXC	1390	⊛; ⊛	0-N1454	VB [DG]	
1.4 TSI	11/07-	CAXC	1390	⊛	0-N1525	VB [BT]	S
1.4 TSI	11/07-	CAXC	1390	⊛	0-N1733	VB [BT]	S
1.6 TDI	10/09-	CAYB, CAYC	1598		0-N1534	VB [BT]	S
1.8 TFSI	01/07-	BYT, BZB, CDAA	1798		0-N1832	VB [BT]	S
1.9 TDI	10/06-	BKC, BLS	1896	ch.→5P-5-165000	0-N1530	VB [BT]	S
1.9 TDI	10/06-	BXE	1896		0-N1531	VB [BT]	S
1.9 TDI	10/06-	BKC, BLS	1896	ch.5P-6-000001→	0-N1531	VB [BT]	S
1.9 TDI	08/09-	BXF	1896		0-N1531	VB [BT]	S
2.0 TDI 16V	10/06-	BKD	1968		0-N1530	VB [BT]	S
2.0 TDI 16V 4x4	10/10-	CFHC	1968		0-N1534	VB [BT]	S
2.0 TDI 4x4	06/07-	CEGA, CFJA	1968		0-N1534	VB [BT]	S
2.0 TDI, 2.0 TDI 16V, 2.0 TDI 4x4	10/06-	CEGA	1968		0-N1534	VB [BT]	S
2.0 TDI, 2.0 TDI 4x4	10/06-	BMM	1968	ch.→5P-5-165000	0-N1530	VB [BT]	S
2.0 TDI, 2.0 TDI 4x4	10/06-	BMM	1968	ch.5P-6-000001→	0-N1531	VB [BT]	S
2.0 TDI, 2.0 TDI 4x4	06/07-	BMN	1968		0-N1530	VB [BT]	S
2.0 TFSI 4x4	06/07-05/09	BWA	1984		0-N1656	VB [BT]	S
2.0 TFSI 4x4	05/09-	CCZB	1984		0-N1832	VB [BT]	S

AROSA (6H)

1.0	05/97-06/04	AER, ALD, ALL, ANV, AUC	999	19x135; ch.→6H-Y-014000; mit Zubehör	SK-1131	BTK	
1.0	05/97-06/04	AER, ALD, ALL, ANV, AUC	999	19x135; ch.→6H-Y-014000; mit Zubehör	SK-1131AQ2	BTKW	
1.0	05/97-06/04	AER, ALD, ALL, ANV, AUC	999	19x135; ch.6H-Y-014001→; mit Zubehör	SK-1592	BTK	
1.0	05/97-06/04	ALD, ANV, AUC	999	19x135; ch.6H-Y-014001→; mit Zubehör	SK-1592AQ1	BTKW	
1.4	05/97-06/04	AEX, AKK, AKV, ANW, APQ, AUD	1390	19x135; ch.→6H-Y-014000; mit Zubehör	SK-1131	BTK	
1.4	05/97-06/04	AEX, AKV, APQ	1390	19x135; mit Zubehör	SK-1131AQ1	BTKW	
1.4	05/97-06/04	AKK, ANW, AUD	1390	19x135; ch.→6H-Y-014000; mit Zubehör	SK-1131AQ2	BTKW	
1.4	05/97-06/04	AKK, ANW, AUD	1390	19x135; ch.6H-Y-014001→; mit Zubehör	SK-1592	BTK	

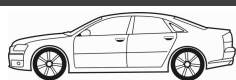
CM³

Art. Nr.



ohne Halter

AROSA (6H)							
1.4	05/97-06/04	AKK, ANW, AUD	1390	19x135; ch.6H-Y-014001→; mit Zubehör	SK-1592AQ1	BTKW	
1.4 16V	01/00-06/04	AFK, AQQ, AUB	1390	20x130; 17x58; beinhaltetete Rollen: 4	SK-1511	BTK	
1.4 16V	01/00-06/04	AFK, AQQ, AUB	1390	20x130; 17x58; beinhaltetete Rollen: 4	SK-1511AQ1	BTKW	
1.4 TDI	01/00-06/04	AMF	1422	30x120; ch.6H-2-023001→; mit Zubehör	SK-1372	BTK	
1.4 TDI	01/00-06/04	AMF	1422	30x120; ch.6H-2-023001→; 6H-3-000001	SK-1372AQ1	BTKW	
1.4 TDI	01/00-06/04	AMF	1422	30x120; :→AMF011494; mit Spanndämpfer, Spannrolle; mit Zubehör; Baumuster: 6H	SK-1378	BTK	
1.4 TDI	01/00-06/04	AMF	1422	30x120; :→AMF011494; ohne Spanndämpfer, Spannrolle; mit Zubehör; Baumuster: 6H	SK-1388	BTK	
1.4 TDI	01/00-06/04	AMF	1422	30x120; ch.→6H-2-023000; :AMF011495→; mit Zubehör; Baumuster: 6H	SK-1582	BTK	
1.4 TDI	01/00-06/04	AMF	1422	30x120; ch.→6H-2-023000; :AMF011495→; ohne Spanndämpfer, Spannrolle; mit Zubehör	SK-1582AQ2	BTKW	
1.4 TDI	01/00-06/04	AMF	1422	30x120; ch.→6H-2-023000; :AMF011495→; mit Spanndämpfer, Spannrolle; mit Zubehör; Baumuster: 6H	SK-1583	BTK	
1.4 TDI	01/00-06/04	AMF	1422	30x120; ch.→6H-2-023000; :AMF011495→; mit Spanndämpfer, Spannrolle; mit Zubehör	SK-1583AQ2	BTKW	
1.7 SDI	08/97-06/04	AKU	1716	23x137; mit Zubehör	SK-1106	BTK	
1.0	05/97-06/04	AER, ALL	999		0-N106	TB [TE]	
1.0	05/97-06/04	ALD, ANV, AUC	999	ch.→6H-Y-014000	0-N106	TB [TE]	
1.0	05/97-06/04	ALD, ANV, AUC	999	ch.6H-Y-014001→	0-N1331	TB [TE]	
1.4	05/97-06/04	AEX, AKV, APQ	1390		0-N106	TB [TE]	
1.4	05/97-06/04	AKK, ANW, AUD	1390	ch.→6H-Y-014000	0-N106	TB [TE]	
1.4	05/97-06/04	AKK, ANW, AUD	1390	ch.6H-Y-014001→	0-N1331	TB [TE]	
1.4 16V	01/00-06/04	AFK, AQQ, AUB	1390		0-N1262	TB [DG]	
1.4 16V	01/00-06/04	AFK, AQQ, AUB	1390		0-N1263	TB [TE]	
1.4 16V	01/00-06/04	AFK, AQQ, AUB	1390		0-N158	TB [TE]	
1.4 16V	01/00-06/04	AFK, AQQ, AUB	1390		0-N164	TB [DG]	
1.4 TDI	01/00-06/04	AMF	1422	ch.6H-2-023001→	0-N1045	TB [TE]	
1.4 TDI	01/00-06/04	AMF	1422	ch.6H-2-023001→	0-N1046	TB [DG]	
1.4 TDI	01/00-06/04	AMF	1422	ch.→6H-2-023000; :011495→	0-N1048	TB [TE]	
1.4 TDI	01/00-06/04	AMF	1422	:→011494	0-N1049	TB [BT]	
1.4 TDI	01/00-06/04	AMF	1422	:→011494; mit Anbaumaterial	0-N1265	TB [TE]	
1.4 TDI	01/00-06/04	AMF	1422	ch.→6H-2-023000	0-N1268	TB [DG]	
1.4 TDI	01/00-06/04	AMF	1422	ch.→6H-2-023000; :011495→	0-N1274	TB [BT]	
1.7 SDI	08/97-06/04	AKU	1716		0-N111	TB [TE]	
1.7 SDI	08/97-06/04	AKU	1716		0-N128	TB [DG]	
1.0	05/97-06/04	AER, ALD, ALL, ANV, AUC	999	☼	0-N1445	VB [BT]	S
1.0	05/97-06/04	AHT	999		0-N2065	VB [TE]	S
1.0	05/97-06/04	AHT	999		0-N2066	VB [BT]	
1.0	10/98-01/01	AHT	997		0-N1675	VB [TE]	
1.0	10/98-01/01	AHT	997		0-N2065	VB [TE]	S
1.0	10/98-01/01	AHT	997	☼ für Fahrzeuge mit Servolenkung	0-N2066	VB [BT]	
1.4, 1.4 16V	05/97-06/04	AEX, AKK, AKV, ANW, APQ, AUD, AFK, AQQ, AUB	1390	☼	0-N1445	VB [BT]	S
1.7 SDI	08/97-06/04	AKU	1716		0-N1675	VB [TE]	
1.7 SDI	08/97-06/04	AKU	1716		0-N1920	VB [BT]	
1.7 SDI	08/97-06/04	AKU	1716	für Artikelnummer:0-N1920	0-N1925	VB [BT]	
CORDOBA (6K1, 6K2)							
1.0 CL	02/93-06/96	AAU	1043	19x128	R-1190AQ1	BTKW	
1.0 i	09/96-06/99	ALD	999	19x135; 07/1997 →; :→ALD037797; mit Zubehör	SK-1131	BTK	
1.0 i	09/96-06/99	AER	999	19x135; 06/1997 →; mit Zubehör	SK-1131AQ2	BTKW	
1.4	12/97-04/99	ANX	1390	19x135; mit Zubehör; Baumuster: 6K2	SK-1131	BTK	
1.4	12/97-04/99	ANX	1390	19x135; mit Zubehör	SK-1131AQ1	BTKW	
1.4 i	06/94-06/99	ABD	1390	19x128	R-1190AQ1	BTKW	
1.4 i	06/94-06/99	AEX, AKV, APQ	1390	19x135; :→AKK127806; mit Zubehör	SK-1131	BTK	
1.4 i	06/94-06/99	AEX, AKV, APQ	1390	19x135; mit Zubehör	SK-1131AQ1	BTKW	
1.4 i	06/94-06/99	ABD, AEX, AKV, APQ	1390	19x135; :→AKK127806; mit Zubehör	SK-1131AQ2	BTKW	
1.4 i	06/94-06/99	ABD, AEX, AKV, APQ	1390	19x135; ch.6K-X-400000→; mit Zubehör	SK-1592	BTK	
1.4 i	06/94-06/99	ABD, AEX, AKV, APQ	1390	19x135; :AKK127807→; mit Zubehör	SK-1592	BTK	
1.4 i 16V	09/96-06/99	AFH	1390	20x130; 17x58; 06/1997 →; beinhaltetete Rollen: 4	SK-1511	BTK	



CM³



Art. Nr.



CORDOBA (6K1, 6K2)

1.4 i 16V	09/96-06/99	AFH	1390	20x130; 17x58; beinhaltete Rollen: 4	SK-1511AQ1	BTKW
1.4 i 16V	09/96-06/99	AFH	1390	25x149; 06/1997 →	SK-1635	BTK
1.4 i 16V	09/96-06/99	AFH	1390	25x149	SK-1635AQ1	BTKW
1.6 i	02/93-06/99	ABU	1598	19x133	R-1257AQ1	BTKW
1.6 i	02/93-06/99	AEE, ALM	1598	19x137; mit Zubehör	SK-1074	BTK
1.6 i	02/93-06/99	ALM	1598	19x137	SK-1074AQ1	BTKW
1.6 i	05/94-06/99	1F	1595	18x121; 09/1994 →; mit Zubehör	SK-1026	BTK
1.6 i	07/96-10/99	AFT	1595	18x121; mit Zubehör	SK-1090	BTK
1.6 i	07/96-10/99	AFT, AKL, APF, AUR	1595	23x138; Baumuster: 6K2	SK-1109	BTK
1.6 i	07/96-10/99	AKL, APF, AUR	1595	23x138	SK-1109AQ1	BTKW
1.8 i	02/93-06/99	ABS, ACC, ADZ	1781	18x121; 10/1993 →; mit Zubehör	SK-1026	BTK
1.8 i 16V	10/93-08/96	ADL	1781	25x147; 02/1994 →	SK-1047	BTK
1.8 i 16V	10/93-08/96	ADL	1781	25x147; 02/1994 →	SK-1124	BTK
1.9 D	02/93-08/96	1Y	1896	25.4x137; → 07/1994; → 1Y378364; mit Zubehör	SK-1029	BTK
1.9 D	02/93-08/96	1Y	1896	25x141; → AGP229903, AQM004132; mit Zubehör	SK-1110	BTK
1.9 D	02/93-08/96	1Y	1896	25x141; : AGP229904, AQM004133 →; : → AGP595000, AQM045000; mit Zubehör	SK-1111	BTK
1.9 D	02/93-08/96	1Y	1896	25x141; 09/1993 →; : AGP229904, AQM004133 →; : → AGP595000, AQM045000; mit Zubehör	SK-1111AQ1	BTKW
1.9 D	02/93-08/96	1Y	1896	25.4x137; 07/1994 →; : 378365 →; mit Zubehör	SK-1122	BTK
1.9 D	02/93-08/96	1Y	1896	25x141; : AGP595001, AQM045001 →; mit Zubehör	SK-1258	BTK
1.9 D	02/93-08/96	1Y	1896	25x141; : AGP595001, AQM045001 →; mit Zubehör	SK-1258AQ1	BTKW
1.9 D	02/93-08/96	1Y	1896	25x141; : → AGP229903, AQM004132	SK-1259	BTK
1.9 D, 1.9 SDI	01/96-06/99	1Y, AEY	1896	25.4x137; : 378365 →; mit Zubehör	SK-1122	BTK
1.9 D, 1.9 SDI	01/96-06/99	1Y, AEY	1896	25.4x137; mit Zubehör	SK-1425	BTK
1.9 TD	02/93-08/96	AAZ	1896	25.4x137; : → 552765; mit Zubehör	SK-1029	BTK
1.9 TD	02/93-08/96	AAZ	1896	25.4x137; : AAZ552766 →; mit Zubehör	SK-1122	BTK
1.9 TDI	08/96-06/99	1Z, AHU	1896	25x137; mit Zubehör	SK-1098	BTK
1.9 TDI	08/96-06/99	1Z, AHU	1896	25x141; : → AGR565000; mit Zubehör	SK-1111	BTK
1.9 TDI	08/96-06/99	1Z, AHU	1896	25x141; : → ALH500000; mit Zubehör	SK-1111	BTK
1.9 TDI	08/96-06/99	1Z, AHU	1896	25x141; 05/1999 →; : → AGR565000; mit Zubehör	SK-1111AQ1	BTKW
1.9 TDI	08/96-06/99	1Z, AHU	1896	25x141; : AGR565001, ALH500001 →; mit Zubehör	SK-1258	BTK
1.9 TDI	08/96-06/99	1Z, AHU	1896	25x141; 05/1999 →; : AGR565001 →; mit Zubehör	SK-1258AQ1	BTKW
1.9 TDI	03/97-06/99	AFN	1896	25x137; mit Zubehör	SK-1098	BTK
1.9 TDI	03/97-06/99	AFN	1896	25x141; : → ASV150000; mit Zubehör	SK-1111	BTK
1.9 TDI	03/97-06/99	AFN	1896	25x141; : → ASV150000; mit Zubehör	SK-1111AQ1	BTKW
1.9 TDI	03/97-06/99	AFN	1896	25x141; : ASV150001 →; mit Zubehör	SK-1258	BTK
1.9 TDI	03/97-06/99	ASV	1896	25x141; : ASV150001 →; mit Zubehör	SK-1258AQ1	BTKW
2.0 i	02/93-06/99	2E, AGG	1984	18x124; 10/1993 →; mit Zubehör	SK-1120	BTK
2.0 i 16V	08/96-06/99	ABF	1984	25x151	SK-1104	BTK
1.0 i	09/96-06/99	AER	999		0-N106	TB [TE]
1.4 i	06/94-06/99	AEX, AKV, ANX, APQ	1390		0-N106	TB [TE]
1.4 i 16V	09/96-06/99	AFH	1390		0-N1258	TB [TE]
1.4 i 16V	09/96-06/99	AFH	1390		0-N165	TB [DG]
1.6 i	02/93-06/99	AEE, ALM	1598		0-N106	TB [TE]
1.6 i	05/94-10/99	1F, AFT, AKL	1595		0-N805	TB [TE]
1.8 i	02/93-06/99	ABS, ACC, ADZ	1781		0-N805	TB [TE]
1.8 i 16V	10/93-08/96	ADL	1781		0-N129	TB [TE]
1.9 D, 1.9 SDI, 1.9 TD	02/93-06/99	1Y, AAZ, AEY	1896	: 552766 →	0-N104	TB [TE]
1.9 D, 1.9 SDI, 1.9 TD	02/93-06/99	1Y, AAZ, AEY	1896	: → 552765	0-N806	TB [TE]
1.9 SDI, 1.9 TDI	08/96-06/99	1Z, AHU, AEY, AFN	1896		0-N128	TB [DG]
1.9 TDI	08/96-06/99	1Z, AHU, AFN	1896		0-N104	TB [TE]
2.0 i	02/93-06/99	2E, AGG	1984		0-N805	TB [TE]
2.0 i 16V	08/96-06/99	ABF	1984		0-N129	TB [TE]
1.0 i	09/96-06/99	AER	999	für Fahrzeuge mit Servolenkung	0-N1445	VB [BT] S
1.0 i	09/96-06/99	AER	999		0-N1459	VB [BT] S
1.4 i	06/94-06/99	ABD	1390	ch.6K-ZR-195001, 6K-ZR-757001 →; für Fahrzeuge mit Servolenkung	0-N1445	VB [BT] S
1.4 i	06/94-06/99	AEX, AKV, ANX, APQ	1390	für Fahrzeuge mit Servolenkung	0-N1445	VB [BT] S

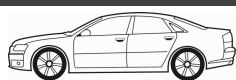
CM³

Art. Nr.



CORDOBA (6K1, 6K2)							
1.4 i	06/94-06/99	ABD	1390	ch.→6K-ZR-195000, 6K-ZR-757000; für Fahrzeuge mit Servolenkung	0-N1459	VB [BT]	S
1.4 i	06/94-06/99	ABD	1390	☼, für Fahrzeuge mit Servolenkung	0-N1459	VB [BT]	S
1.4 i	06/94-06/99	AEX, AKV, ANX, APQ	1390	☼, für Fahrzeuge mit Servolenkung	0-N1459	VB [BT]	S
1.4 i 16V	09/96-06/99	AFH	1390	für Fahrzeuge mit Servolenkung	0-N1445	VB [BT]	S
1.4 i 16V	09/96-06/99	AFH	1390	☼	0-N1459	VB [BT]	S
1.6 i	02/93-06/99	AEE, ALM	1598		0-N1445	VB [BT]	S
1.6 i	02/93-06/99	ABU	1598		0-N1459	VB [BT]	S
1.6 i	02/93-06/99	AEE, ALM	1598	☼	0-N1459	VB [BT]	S
1.6 i	05/94-10/99	1F, AFT, AKL	1595		0-N1417	VB [TE]	
1.6 i	05/94-10/99	1F, AFT, AKL	1595		0-N1660	VB [BT]	
1.8 i, 1.8 i 16V	02/93-06/99	ABS, ACC, ADZ, ADL	1781		0-N1417	VB [TE]	
1.8 i, 1.8 i 16V	02/93-06/99	ABS, ACC, ADZ, ADL	1781		0-N1660	VB [BT]	
1.9 D, 1.9 SDI, 1.9 TD, 1.9 TDI	02/93-06/99	1Y, 1Z, AHU, AAZ, AEY, AFN	1896		0-N1417	VB [TE]	
1.9 D, 1.9 SDI, 1.9 TD, 1.9 TDI	02/93-06/99	1Y, 1Z, AHU, AAZ, AEY, AFN	1896		0-N1609	VB [BT]	
2.0 i, 2.0 i 16V	02/93-06/99	2E, AGG, ABF	1984		0-N1417	VB [TE]	
2.0 i, 2.0 i 16V	02/93-06/99	2E, AGG, ABF	1984		0-N1660	VB [BT]	
CORDOBA Vario (6K5)							
1.4 i	09/96-06/99	AEX, AKV, APQ	1390	19x135; 05/1997 →; :→AKK127806; mit Zubehör	SK-1131	BTK	
1.4 i	09/96-06/99	AEX, AKV, APQ	1390	19x135; 05/1997 →; mit Zubehör	SK-1131AQ1	BTKW	
1.4 i	09/96-06/99	AEX, AKV, APQ	1390	19x135; 05/1997 →; :→AKK127806; mit Zubehör	SK-1131AQ2	BTKW	
1.4 i	09/96-06/99	AEX, AKV, APQ	1390	19x135; 05/1997 →; :AKK127807→; mit Zubehör	SK-1592	BTK	
1.4 i	09/96-06/99	AEX, AKV, APQ	1390	19x135; ch.6K-X-400000→; 05/1997 →; mit Zubehör	SK-1592	BTK	
1.6 i	09/96-06/99	AEE, ALM	1598	19x137; 05/1997 →; mit Zubehör; Baumuster: 6K5	SK-1074	BTK	
1.6 i	09/96-06/99	ALM	1598	19x137	SK-1074AQ1	BTKW	
1.6 i	09/96-06/99	AFT	1595	18x121; 05/1997 →; mit Zubehör	SK-1090	BTK	
1.6 i	09/96-06/99	AFT, APF, AUR	1595	23x138; 05/1997 →; Baumuster: 6K5	SK-1109	BTK	
1.6 i	09/96-06/99	APF, AUR	1595	23x138; 04/1997 →	SK-1109AQ1	BTKW	
1.6 i	05/97-06/99	1F	1595	18x121; mit Zubehör	SK-1026	BTK	
1.9 SDI	09/96-06/99	AEY	1896	25.4x137; 06/1997 →; :378365→; mit Zubehör	SK-1122	BTK	
1.9 SDI	09/96-06/99	AEY	1896	25.4x137; 05/1997 →; mit Zubehör	SK-1425	BTK	
1.9 TDI	08/96-06/99	AHU	1896	25x137; 05/1997 →; mit Zubehör	SK-1098	BTK	
1.9 TDI	08/96-06/99	1Z, AHU	1896	25x141; 05/1997 →; :→AGR565000; mit Zubehör	SK-1111	BTK	
1.9 TDI	08/96-06/99	1Z, AHU	1896	25x141; :→ALH500000; mit Zubehör	SK-1111	BTK	
1.9 TDI	08/96-06/99	1Z, AHU	1896	25x141; 06/1997 →; :→AGR565000; mit Zubehör	SK-1111AQ1	BTKW	
1.9 TDI	08/96-06/99	1Z, AHU	1896	25x141; 06/1997 →; :→ALH500000; mit Zubehör	SK-1111AQ1	BTKW	
1.9 TDI	08/96-06/99	1Z, AHU	1896	25x141; 05/1997 →; :AGR565001→; mit Zubehör	SK-1258	BTK	
1.9 TDI	08/96-06/99	1Z, AHU	1896	25x141; 05/1997 →; :ALH500001→; mit Zubehör	SK-1258	BTK	
1.9 TDI	08/96-06/99	AGR	1896	25x141; :AGR565001→; mit Zubehör	SK-1258AQ1	BTKW	
1.9 TDI	08/96-06/99	ALH	1896	25x141; :ALH500001→; mit Zubehör	SK-1258AQ1	BTKW	
1.9 TDI	07/97-06/99	AFN, AGR, ALH, ASK, ASV	1896	25x137; mit Zubehör	SK-1098	BTK	
1.9 TDI	07/97-06/99	AFN	1896	25x141; :→ASV150000; mit Zubehör	SK-1111	BTK	
1.9 TDI	07/97-06/99	AFN	1896	25x141; 02/1998 →; :→ASV150000; mit Zubehör	SK-1111AQ1	BTKW	
1.9 TDI	07/97-06/99	AFN	1896	25x141; :ASV150001→; mit Zubehör	SK-1258	BTK	
1.9 TDI	07/97-06/99	ASV	1896	25x141; :ASV150001→; mit Zubehör	SK-1258AQ1	BTKW	
1.4 i	09/96-06/99	AEX, AKV, APQ	1390		0-N106	TB [TE]	
1.6 i	09/96-06/99	1F, AFT	1595		0-N805	TB [TE]	
1.6, 1.6 i	09/96-06/99	ABU, ALM, AEE, ALM	1598		0-N106	TB [TE]	
1.9 SDI	09/96-06/99	AEY	1896	:552766→	0-N104	TB [TE]	
1.9 SDI	09/96-06/99	AEY	1896	:→552765	0-N806	TB [TE]	
1.9 SDI, 1.9 TDI	08/96-06/99	1Z, AHU, AEY, AFN	1896		0-N128	TB [DG]	
1.9 TDI	08/96-06/99	1Z, AHU, AFN	1896		0-N104	TB [TE]	
1.4, 1.4 16V, 1.4 i	09/96-06/99	AEX, AKV, APQ, AKK, ANW, AUD, APE, AUA	1390	für Fahrzeuge mit Servolenkung	0-N1445	VB [BT]	S
1.4, 1.4 i	09/96-06/99	AEX, AKV, APQ, AKK, ANW, AUD	1390	☼	0-N1459	VB [BT]	S
1.6 i	09/96-06/99	1F, AFT	1595		0-N1417	VB [TE]	
1.6 i	09/96-06/99	1F, AFT	1595		0-N1660	VB [BT]	



CM³



Art. Nr.



CORDOBA Vario (6K5)

1.6, 1.6 i	09/96-06/99	ABU, ALM, AEE, ALM	1598	für Fahrzeuge mit Servolenkung	0-N1445	VB [BT]	S
1.6, 1.6 i	09/96-06/99	ABU, ALM, AEE, ALM	1598	☼	0-N1459	VB [BT]	S
1.9 SDI, 1.9 TDI	08/96-06/99	1Z, AHU, AEY, AFN	1896		0-N1417	VB [TE]	
1.9 SDI, 1.9 TDI	08/96-06/99	1Z, AHU, AEY, AFN	1896		0-N1609	VB [BT]	

CORDOBA (6K2)

1.0	06/99-10/02	ALD, ANV	999	19x135; :→ALD037797; mit Zubehör	SK-1131	BTK	
1.0	06/99-10/02	ALD, ANV, AUC	999	19x135; mit Zubehör	SK-1131AQ2	BTKW	
1.0	06/99-10/02	AUC	999	19x135; mit Zubehör	SK-1592	BTK	
1.4	06/99-10/02	AKK, ANW, AUD	1390	19x128	R-1190AQ1	BTKW	
1.4	06/99-10/02	AKK	1390	19x135; :→AKK127806; mit Zubehör	SK-1131	BTK	
1.4	06/99-10/02	AKK, ANW, AUD	1390	19x135; mit Zubehör	SK-1131AQ1	BTKW	
1.4	06/99-10/02	AKK	1390	19x135; :→AKK127806; mit Zubehör	SK-1131AQ2	BTKW	
1.4	06/99-10/02	ANW, AUD	1390	19x135; ch.6K-X-400000→; mit Zubehör	SK-1592	BTK	
1.4	06/99-10/02	AKK	1390	19x135; :AKK127807→; mit Zubehör	SK-1592	BTK	
1.4	06/99-10/02	AKK, ANW, AUD	1390	19x135; :128807→; mit Zubehör	SK-1592AQ1	BTKW	
1.4 16V	02/00-10/02	APE, AUA, AQQ, AUB	1390	20x130; 17x58; beinhalten Rollen: 4	SK-1511	BTK	
1.4 16V	02/00-10/02	APE, AUA, AQQ, AUB	1390	20x130; 17x58; beinhalten Rollen: 4	SK-1511AQ1	BTKW	
1.4 16V	02/00-10/02	AQQ, AUB	1390	25x149	SK-1635	BTK	
1.4 16V	02/00-10/02	AQQ, AUB	1390	25x149	SK-1635AQ1	BTKW	
1.6	06/99-10/02	ALM	1598	19x133	R-1257AQ1	BTKW	
1.6	06/99-10/02	ALM	1598	19x137; mit Zubehör, Baumuster: 6K2	SK-1074	BTK	
1.6	06/99-10/02	ALM	1598	19x137	SK-1074AQ1	BTKW	
1.6	06/99-10/02	AFT	1595	18x121; mit Zubehör	SK-1090	BTK	
1.6	06/99-10/02	AEH, AFT, AKL, AUR	1595	23x138; Baumuster: 6K2	SK-1109	BTK	
1.6	06/99-10/02	AEH, AKL, APF, AUR	1595	23x138	SK-1109AQ1	BTKW	
1.8 T 20V Cupra	07/00-10/02	AQX, AYP	1781	23x150	SK-1660	BTK	
1.8 T 20V Cupra	07/00-10/02	AQX, AYP	1781	23x150	SK-1660AQ1	BTKW	
1.8 T 20V Cupra	07/00-10/02	AQX, AYP	1781	23x150	SK-1710	BTK	
1.9 SDI	06/99-10/02	AGP, AQM	1896	25x141; :→AGP229903, AQM004132; mit Zubehör	SK-1110	BTK	
1.9 SDI	06/99-10/02	AGP, AQM	1896	25x141; :AGP229904, AQM004133→; :→AGP595000, AQM045000; mit Zubehör	SK-1111	BTK	
1.9 SDI	06/99-10/02	AGP	1896	25x141; :AGP229904→; :→AGP595000; mit Zubehör	SK-1111AQ1	BTKW	
1.9 SDI	06/99-10/02	AQM	1896	25x141; :AQM004133→; :→AQM045000; mit Zubehör	SK-1111AQ1	BTKW	
1.9 SDI	06/99-10/02	AGP, AQM	1896	25.4x137; :378365→; mit Zubehör	SK-1122	BTK	
1.9 SDI	06/99-10/02	AGP, AQM	1896	25x141; :AGP595001, AQM045001→; mit Zubehör	SK-1258	BTK	
1.9 SDI	06/99-10/02	AGP	1896	25x141; :AGP595001→; mit Zubehör	SK-1258AQ1	BTKW	
1.9 SDI	06/99-10/02	AQM	1896	25x141; :AQM045001→; mit Zubehör	SK-1258AQ1	BTKW	
1.9 SDI	06/99-10/02	AGP, AQM	1896	25x141; :→AGP229903, AQM004132	SK-1259	BTK	
1.9 TDI	06/99-10/02	AHU	1896	25x137; mit Zubehör	SK-1098	BTK	
1.9 TDI	06/99-10/02	ASK, ASV	1896	25x137; mit Zubehör	SK-1098	BTK	
1.9 TDI	06/99-10/02	AGR	1896	25x141; :→AGR565000; mit Zubehör	SK-1111	BTK	
1.9 TDI	06/99-10/02	ALH	1896	25x141; :→ALH500000; mit Zubehör	SK-1111	BTK	
1.9 TDI	06/99-10/02	ASK, ASV	1896	25x141; :→ASV150000; mit Zubehör	SK-1111	BTK	
1.9 TDI	06/99-10/02	AGR, AHU, ALH	1896	25x141; :→ALH500000; mit Zubehör	SK-1111AQ1	BTKW	
1.9 TDI	06/99-10/02	ASK, ASV	1896	25x141; :→ASV150000; mit Zubehör	SK-1111AQ1	BTKW	
1.9 TDI	06/99-10/02	AGR, ALH	1896	25x141; :AGR565001, ALH500001→; mit Zubehör	SK-1258	BTK	
1.9 TDI	06/99-10/02	ASK, ASV	1896	25x141; :ASV150001→; mit Zubehör	SK-1258	BTK	
1.9 TDI	06/99-10/02	AGR, AHU, ALH	1896	25x141; :ALH500001→; mit Zubehör	SK-1258AQ1	BTKW	
1.9 TDI	06/99-10/02	ASK, ASV	1896	25x141; :ASV150001→; mit Zubehör	SK-1258AQ1	BTKW	
1.0	06/99-10/02	ANV	999		0-N106	TB [TE]	
1.0	06/99-10/02	ALD	999	:→037979	0-N106	TB [TE]	
1.0	06/99-10/02	AUC	999		0-N1331	TB [TE]	
1.0	06/99-10/02	ALD	999	:037980→	0-N1331	TB [TE]	
1.4	06/99-10/02	AKK	1390	:→127806	0-N106	TB [TE]	
1.4	06/99-10/02	ANW, AUD	1390		0-N1331	TB [TE]	
1.4	06/99-10/02	AKK	1390	:127807→	0-N1331	TB [TE]	
1.4 16V	02/00-10/02	APE, AUA, AQQ, AUB	1390		0-N1262	TB [DG]	
1.4 16V	02/00-10/02	APE, AUA, AQQ, AUB	1390		0-N1263	TB [TE]	
1.4 16V	02/00-10/02	APE, AUA, AQQ, AUB	1390		0-N158	TB [TE]	
1.4 16V	02/00-10/02	APE, AUA, AQQ, AUB	1390		0-N164	TB [DG]	
1.6	06/99-10/02	ALM	1598		0-N106	TB [TE]	

CM³

Art. Nr.



ohne Halter

CORDOBA (6K2)							
1.6	06/99-10/02	AEH, AKL, APF, AUR	1595			0-N157	TB [TE]
1.8 T 20V Cupra	07/00-10/02	AQX, AYP	1781			0-N1042	TB [TE]
1.8 T 20V Cupra	07/00-10/02	AQX, AYP	1781			0-N1237	TB [BT]
1.8 T 20V Cupra	07/00-10/02	AQX, AYP	1781			0-N1316	TB [DG]
1.9 SDI	06/99-10/02	AQM	1896	:→004131		0-N107	TB [TE]
1.9 SDI	06/99-10/02	AGP	1896	:→229902		0-N107	TB [TE]
1.9 SDI	06/99-10/02	AQM	1896	:004059→		0-N107	TB [TE]
1.9 SDI	06/99-10/02	AGP	1896	:229903→		0-N107	TB [TE]
1.9 SDI	06/99-10/02	AQM	1896	:004059→		0-N167	TB [DG]
1.9 SDI	06/99-10/02	AGP	1896	:229903→		0-N167	TB [DG]
1.9 SDI, 1.9 TDI	06/99-10/02	AGP, AQM, AGR, AHU, ALH, ASK, ASV	1896			0-N131	TB [DG]
1.9 SDI, 1.9 TDI	06/99-10/02	AGP, AQM, AGR, AHU, ALH, ASK, ASV	1896			0-N166	TB [DG]
1.9 TDI	06/99-10/02	AGR, ALH	1896			0-N107	TB [TE]
1.9 TDI	06/99-10/02	ASV	1896			0-N107	TB [TE]
1.9 TDI	06/99-10/02	AGR, AHU, ALH, ASK, ASV	1896			0-N167	TB [DG]
1.0	06/99-10/02	ALD, ANV, AUC	999	für Fahrzeuge mit Servolenkung		0-N1445	VB [BT] S
1.0	06/99-10/02	ALD, ANV, AUC	999			0-N1459	VB [BT] S
1.4 16V	05/00-10/02	APE, AUA	1390	, für Fahrzeuge mit Servolenkung		0-N1459	VB [BT] S
1.4, 1.4 16V	06/99-10/02	AKK, ANW, AUD, APE, AUA, AQQ, AUB	1390	für Fahrzeuge mit Servolenkung		0-N1445	VB [BT] S
1.4, 1.4 16V	06/99-10/02	AKK, ANW, AUD, AQQ, AUB	1390			0-N1459	VB [BT] S
1.6	06/99-10/02	ALM	1598	für Fahrzeuge mit Servolenkung		0-N1445	VB [BT] S
1.6	06/99-10/02	ALM	1598			0-N1459	VB [BT] S
1.9 SDI	06/99-10/02	AGP, AQM	1896			0-N1606	VB [BT] S
1.9 SDI, 1.9 TDI	06/99-10/02	AGP, AQM, AGR, AHU, ALH, ASK, ASV	1896			0-N174	VB [DG]
1.9 TDI	06/99-10/02	AGR, AHU, ALH, ASK, ASV	1896			0-N1538	VB [BT] S
CORDOBA Vario (6K5)							
1.4	06/99-12/02	AKK	1390	19x135; :→AKK127806; mit Zubehör		SK-1131	BTK
1.4	06/99-12/02	AKK, ANW, AUD	1390	19x135; mit Zubehör		SK-1131AQ1	BTKW
1.4	06/99-12/02	AKK	1390	19x135; :→AKK127806; mit Zubehör		SK-1131AQ2	BTKW
1.4	06/99-12/02	ANW, AUD	1390	19x135; ch.6K-X-400000→; mit Zubehör		SK-1592	BTK
1.4	06/99-12/02	AKK	1390	19x135; :AKK127807→; mit Zubehör		SK-1592	BTK
1.4	06/99-12/02	AKK, ANW, AUD	1390	19x135; :128807→; mit Zubehör		SK-1592AQ1	BTKW
1.4 16V	06/99-12/02	APE, AUA	1390	20x130; 17x58; beinhaltetete Rollen: 4		SK-1511	BTK
1.4 16V	06/99-12/02	APE, AUA	1390	20x130; 17x58; beinhaltetete Rollen: 4		SK-1511AQ1	BTKW
1.6	06/99-12/02	AEE, ALM	1598	19x137; mit Zubehör; Baumuster: 6K5		SK-1074	BTK
1.6	06/99-12/02	ABU, ALM	1598	19x137		SK-1074AQ1	BTKW
1.6	06/99-12/02	AFT	1595	18x121; mit Zubehör		SK-1090	BTK
1.6	06/99-12/02	AEH, AFT, APF, AUR	1595	23x138; Baumuster: 6K5		SK-1109	BTK
1.6	06/99-12/02	AEH, AKL	1595	23x138		SK-1109AQ1	BTKW
1.9 SDI	06/99-12/02	AGP, AQM	1896	25x141; :→AGP229903, AQM004132; mit Zubehör		SK-1110	BTK
1.9 SDI	06/99-12/02	AGP, AQM	1896	25x141; :AGP229904, AQM004133→; :→AGP595000, AQM045000; mit Zubehör		SK-1111	BTK
1.9 SDI	06/99-12/02	AGP	1896	25x141; :AGP229904→; :→AGP595000; mit Zubehör		SK-1111AQ1	BTKW
1.9 SDI	06/99-12/02	AQM	1896	25x141; :AQM004133→; :→AQM045000; mit Zubehör		SK-1111AQ1	BTKW
1.9 SDI	06/99-12/02	AGP, AQM	1896	25x141; :AGP595001, AQM045001→; mit Zubehör		SK-1258	BTK
1.9 SDI	06/99-12/02	AGP	1896	25x141; :AGP595001→; mit Zubehör		SK-1258AQ1	BTKW
1.9 SDI	06/99-12/02	AQM	1896	25x141; :AQM045001→; mit Zubehör		SK-1258AQ1	BTKW
1.9 SDI	06/99-12/02	AGP, AQM	1896	25x141; :→AGP229903, AQM004132		SK-1259	BTK
1.9 TDI	06/99-12/02	AFN, AGR, ALH, ASK, ASV	1896	25x137; mit Zubehör		SK-1098	BTK
1.9 TDI	06/99-12/02	AGR	1896	25x141; :→AGR565000; mit Zubehör		SK-1111	BTK
1.9 TDI	06/99-12/02	ALH	1896	25x141; :→ALH500000; mit Zubehör		SK-1111	BTK
1.9 TDI	06/99-12/02	ASV	1896	25x141; :→ASV150000; mit Zubehör		SK-1111	BTK
1.9 TDI	06/99-12/02	AGR, ALH	1896	25x141; :→ALH500000; mit Zubehör		SK-1111AQ1	BTKW
1.9 TDI	06/99-12/02	ASK, ASV	1896	25x141; :→ASV150000; mit Zubehör		SK-1111AQ1	BTKW
1.9 TDI	06/99-12/02	AGR, ALH	1896	25x141; :AGR565001, ALH500001→; mit Zubehör		SK-1258	BTK
1.9 TDI	06/99-12/02	ASV	1896	25x141; :ASV150001→; mit Zubehör		SK-1258	BTK
1.9 TDI	06/99-12/02	AGR, ALH	1896	25x141; :ALH500001→; mit Zubehör		SK-1258AQ1	BTKW
1.9 TDI	06/99-12/02	ASK, ASV	1896	25x141; :ASV150001→; mit Zubehör		SK-1258AQ1	BTKW
1.4	06/99-12/02	AKK	1390	:→127806		0-N106	TB [TE]
1.4	06/99-12/02	ANW, AUD	1390			0-N1331	TB [TE]
1.4	06/99-12/02	AKK	1390	:127807→		0-N1331	TB [TE]



CM³



Art. Nr.



CORDOBA Vario (6K5)

1.4 16V	06/99-12/02	APE, AUA	1390			0-N1262	TB [DG]	
1.4 16V	06/99-12/02	APE, AUA	1390			0-N1263	TB [TE]	
1.4 16V	06/99-12/02	APE, AUA	1390			0-N158	TB [TE]	
1.4 16V	06/99-12/02	APE, AUA	1390			0-N164	TB [DG]	
1.6	06/99-12/02	AEH, AKL, APF, AUR	1595			0-N157	TB [TE]	
1.6, 1.6 i	06/99-12/02	ABU, ALM, AEE, ALM	1598			0-N106	TB [TE]	
1.9 SDI	06/99-12/02	AQM	1896	ENGINE: →004131		0-N107	TB [TE]	
1.9 SDI	06/99-12/02	AGP	1896	ENGINE: →229902		0-N107	TB [TE]	
1.9 SDI	06/99-12/02	AQM	1896	ENGINE: :004059 →		0-N107	TB [TE]	
1.9 SDI	06/99-12/02	AGP	1896	ENGINE: :229903 →		0-N107	TB [TE]	
1.9 SDI	06/99-12/02	AQM	1896	ENGINE: :004059 →		0-N167	TB [DG]	
1.9 SDI	06/99-12/02	AGP	1896	ENGINE: :229903 →		0-N167	TB [DG]	
1.9 SDI, 1.9 TDI	06/99-12/02	AGP, AQM, AGR, ALH, ASK, ASV	1896			0-N131	TB [DG]	
1.9 SDI, 1.9 TDI	06/99-12/02	AGP, AQM, AGR, ALH, ASK, ASV	1896			0-N166	TB [DG]	
1.9 TDI	06/99-12/02	AGR, ALH	1896			0-N107	TB [TE]	
1.9 TDI	06/99-12/02	ASV	1896			0-N107	TB [TE]	
1.9 TDI	06/99-12/02	AGR, ALH, ASK, ASV	1896			0-N167	TB [DG]	
1.4 16V	06/99-12/02	APE, AUA	1390	☼, für Fahrzeuge mit Servolenkung		0-N1459	VB [BT]	S
1.4, 1.4 16V, 1.4 i	06/99-12/02	AEX, AKV, APQ, AKK, ANW, AUD, APE, AUA	1390	für Fahrzeuge mit Servolenkung		0-N1445	VB [BT]	S
1.4, 1.4 i	06/99-12/02	AEX, AKV, APQ, AKK, ANW, AUD	1390	☼		0-N1459	VB [BT]	S
1.6, 1.6 i	06/99-12/02	ABU, ALM, AEE, ALM	1598	für Fahrzeuge mit Servolenkung		0-N1445	VB [BT]	S
1.6, 1.6 i	06/99-12/02	ABU, ALM, AEE, ALM	1598	☼		0-N1459	VB [BT]	S
1.9 SDI	06/99-12/02	AGP, AQM	1896			0-N1606	VB [BT]	S
1.9 SDI, 1.9 TDI	06/99-12/02	AGP, AQM, AGR, ALH, ASK, ASV	1896			0-N174	VB [DG]	
1.9 TDI	06/99-12/02	AGR, ALH, ASK, ASV	1896			0-N1538	VB [BT]	S

CORDOBA (6L2)

1.4 16V	09/02-11/09	AUB, BBZ, BBY, BKY, BXW	1390	20x130; 17x58; beinhalten Rollen: 4		SK-1511	BTK	
1.4 16V	09/02-11/09	AUB, BBZ, BBY, BKY, BXW	1390	20x130; 17x58; beinhalten Rollen: 4		SK-1511AQ1	BTKW	
1.4 TDI	10/02-11/09	AMF, BMS, BNV, BNM	1422	30x120; mit Zubehör		SK-1372	BTK	
1.4 TDI	10/02-11/09	AMF, BMS, BNV, BNM	1422	30x120		SK-1372AQ1	BTKW	
1.6	04/03-11/09	BAH	1598	19x135; mit Zubehör		SK-1592	BTK	
1.9 SDI	09/02-11/09	ASY	1896	25x141; → 07/2005		SK-1259	BTK	
1.9 SDI	09/02-11/09	ASY	1896	25x141		SK-1259AQ1	BTKW	
1.9 TDI	09/02-11/09	ASZ, BLT, ATD, AXR, BMT	1896	30x120; mit Zubehör		SK-1372	BTK	
1.9 TDI	09/02-11/09	ASZ, BLT, ATD, AXR, BMT	1896	30x120		SK-1372AQ1	BTKW	
2.0	09/02-11/09	AZL, BBX	1984	23x138; Baumuster: 6L2		SK-1109	BTK	
2.0	09/02-11/09	AZL, BBX	1984	23x138		SK-1109AQ2	BTKW	
1.4 16V	09/02-11/09	AUB, BBZ, BBY, BKY, BXW	1390			0-N1262	TB [DG]	
1.4 16V	09/02-11/09	AUB, BBZ, BBY, BKY, BXW	1390			0-N1263	TB [TE]	
1.4 16V	09/02-11/09	AUB, BBZ, BBY, BKY, BXW	1390			0-N158	TB [TE]	
1.4 16V	09/02-11/09	AUB, BBZ, BBY, BKY, BXW	1390			0-N164	TB [DG]	
1.4 TDI	10/02-11/09	AMF, BMS, BNV, BNM	1422			0-N1045	TB [TE]	
1.4 TDI	10/02-11/09	AMF, BMS, BNV, BNM	1422			0-N1046	TB [DG]	
1.6	04/03-11/09	BAH	1598			0-N1331	TB [TE]	
1.9 SDI	09/02-11/09	ASY	1896	→ 09/2009		0-N107	TB [TE]	
1.9 SDI	09/02-11/09	ASY	1896			0-N131	TB [DG]	
1.9 SDI	09/02-11/09	ASY	1896			0-N166	TB [DG]	
1.9 TDI	09/02-11/09	ASZ, BLT, ATD, AXR, BMT	1896			0-N1045	TB [TE]	
1.9 TDI	09/02-11/09	ASZ, BLT, ATD, AXR, BMT	1896			0-N1046	TB [DG]	
2.0	09/02-11/09	AZL, BBX	1984			0-N157	TB [TE]	
1.2, 1.2 12V	10/02-11/09	AZQ, BME, BXV	1198			0-N1908	VB [BT]	S
1.2, 1.2 12V	10/02-11/09	AZQ, BME, BXV	1198	☼		0-N1909	VB [DG]	
1.4 16V	09/02-11/09	AUB, BBZ, BBY, BKY	1390	☼		0-N1445	VB [BT]	S
1.4 TDI	10/02-11/09	AMF, BNM	1422			0-N1704	VB [BT]	S
1.4 TDI	06/05-11/09	CEGA, CFJA	1422			0-N1534	VB [BT]	S
1.4 TDI	06/05-11/09	BNV	1422			0-N1704	VB [BT]	S
1.6	04/03-11/09	BAH	1598	☼		0-N1445	VB [BT]	S
1.6 16V	11/06-11/09	BTS	1598	☼; ☼		0-N1454	VB [DG]	
1.6 16V	11/06-11/09	BTS	1598	☼		0-N1525	VB [BT]	S
1.6 16V	11/06-11/09	BTS	1598	☼		0-N1733	VB [BT]	S
1.9 SDI, 1.9 TDI	09/02-11/09	CEGA	1896			0-N1534	VB [BT]	S
1.9 SDI, 1.9 TDI	09/02-11/09	ASY, ASZ, BLT	1896			0-N1536	VB [BT]	S
1.9 TDI	09/02-11/09	ATD, AXR	1896			0-N1536	VB [BT]	S

CM³

Art. Nr.

**EXEO (3R2)**

1.6	03/09-09/10	ALZ	1595	23x138	SK-1109	BTK	
1.6	03/09-09/10	ALZ	1595	23x138	SK-1109AQ1	BTKW	
1.8 T	12/08-05/10	CFMA	1781	23x150; ohne Spanndämpfer, Spannrolle; mit Zubehör	SK-1640AQ2	BTKW	
1.8 T	12/08-05/10	CFMA	1781	23x150; mit Zubehör	SK-1726	BTK	
1.8 T	12/08-05/10	CFMA	1781	23x150; mit Zubehör	SK-1726AQ1	BTKW	
2.0 TDI	12/08-	CAGA	1968	30x160	SK-1694	BTK	
2.0 TDI	12/08-	CAGC	1968	30x160	SK-1694	BTK	
2.0 TDI	12/08-	CAGA	1968	30x160	SK-1694AQ1	BTKW	
2.0 TDI	12/08-	CAGB, CAGC	1968	30x160	SK-1694AQ1	BTKW	
2.0 TDI	12/08-	CJCA	1968	25x160	SK-1695AQ1	BTKW	
2.0 TDI	02/09-	CAHA	1968	30x160	SK-1694	BTK	
2.0 TDI	02/09-	CAHA	1968	30x160	SK-1694AQ2	BTKW	
2.0 TDI	02/09-	CGLB	1968	25x160	SK-1695AQ1	BTKW	
2.0 TFSI	03/09-	BWE	1984	23x148	SK-1724	BTK	
2.0 TFSI	03/09-	BWE	1984	23x148	SK-1724AQ1	BTKW	
1.6	03/09-09/10	ALZ	1595		0-N157	TB [TE]	
1.8 T	12/08-05/10	CFMA	1781		0-N1050	TB [TE]	
1.8 T	12/08-05/10	CFMA	1781		0-N1051	TB [BT]	S
1.8 T	12/08-05/10	CFMA	1781		0-N1316	TB [DG]	
2.0 TDI	12/08-	CAGA, CJCA, CAGC, CJCC, CAHA, CGLB	1968		0-N1046	TB [DG]	
2.0 TDI	12/08-	CAGA, CJCA, CAGC, CJCC, CAHA, CGLB	1968		0-N1268	TB [DG]	
2.0 TDI	12/08-	CJCA	1968		0-N131	TB [DG]	
2.0 TDI	12/08-	CJCC	1968		0-N131	TB [DG]	
2.0 TDI	12/08-	CAGA, CJCA, CAGC, CJCC, CAHA, CGLB	1968		0-N1336	TB [DG]	
2.0 TDI	12/08-	CAGA, CJCA, CAGC, CJCC, CAHA, CGLB	1968		0-N1905	TB [BT]	
2.0 TDI	02/09-	CGLB	1968		0-N131	TB [DG]	
2.0 TFSI	03/09-	BWE	1984		0-N1316	TB [DG]	
2.0 TFSI	03/09-	BWE	1984		0-N1346	TB [DG]	
2.0 TFSI	03/09-	BWE	1984		0-N2208	TB [TE]	
1.6	03/09-09/10	ALZ	1595		0-N1662	VB [DG]	
1.6	03/09-09/10	ALZ	1595		0-N1671	VB [BT]	S
1.8 T	12/08-05/10	CFMA	1781		0-N1662	VB [DG]	
1.8 T	12/08-05/10	CFMA	1781		0-N1671	VB [BT]	S
1.8 TSI	05/10-	CDHA, CDHB	1798		0-N2026	VB [TE]	S
1.8 TSI	05/10-	CDHA, CDHB	1798		0-N2027	VB [DG]	
2.0 TDI	12/08-	CAGA, CJCA, CAGC, CJCC, CAHA, CGLB	1968		0-N1534	VB [BT]	S
2.0 TDI	12/08-	CAGA	1968		0-N1738	VB [DG]	
2.0 TDI	12/08-	CAGC, CJCC, CAHA, CGLB	1968		0-N1738	VB [DG]	
2.0 TFSI	03/09-	BWE	1984		0-N1662	VB [DG]	
2.0 TFSI	03/09-	BWE	1984		0-N1671	VB [BT]	S
2.0 TFSI	05/10-	CDND	1984		0-N2026	VB [TE]	S
2.0 TFSI	05/10-	CDND	1984		0-N2027	VB [DG]	

EXEO ST (3R5)

1.6	06/09-09/10	ALZ	1595	23x138	SK-1109	BTK	
1.6	06/09-09/10	ALZ	1595	23x138	SK-1109AQ1	BTKW	
1.8 T	06/09-05/10	CFMA	1781	23x150; ohne Spanndämpfer, Spannrolle; mit Zubehör	SK-1640AQ2	BTKW	
1.8 T	06/09-05/10	CFMA	1781	23x150; mit Zubehör	SK-1726	BTK	
1.8 T	06/09-05/10	CFMA	1781	23x150; mit Zubehör	SK-1726AQ1	BTKW	
2.0 TDI	05/09-	CAGA	1968	30x160	SK-1694	BTK	
2.0 TDI	05/09-	CAHA	1968	30x160	SK-1694	BTK	
2.0 TDI	05/09-	CAGA	1968	30x160	SK-1694AQ1	BTKW	
2.0 TDI	05/09-	CAHA	1968	30x160	SK-1694AQ2	BTKW	
2.0 TDI	05/09-	CGLB	1968	25x160	SK-1695AQ1	BTKW	
2.0 TDI	05/09-	CJCA	1968	25x160	SK-1695AQ1	BTKW	
2.0 TDI	07/09-	CAGC	1968	30x160; 09/2009 →	SK-1694	BTK	
2.0 TDI	07/09-	CAGB, CAGC	1968	30x160	SK-1694AQ1	BTKW	
2.0 TFSI	06/09-	BWE	1984	23x148	SK-1724	BTK	
2.0 TFSI	06/09-	BWE	1984	23x148	SK-1724AQ1	BTKW	
1.6	06/09-09/10	ALZ	1595		0-N157	TB [TE]	
1.8 T	06/09-05/10	CFMA	1781		0-N1050	TB [TE]	
1.8 T	06/09-05/10	CFMA	1781		0-N1051	TB [BT]	S
1.8 T	06/09-05/10	CFMA	1781		0-N1316	TB [DG]	
2.0 TDI	05/09-	CAGA, CJCA, CAGC, CJCC, CAHA, CGLB	1968		0-N1046	TB [DG]	



CM³



Art. Nr.



EXEO ST (3R5)

2.0 TDI	05/09-	CAGA, CJCA, CAGC, CJCC, CAHA, CGLB	1968		0-N1268	TB [DG]	
2.0 TDI	05/09-	CGLB	1968		0-N131	TB [DG]	
2.0 TDI	05/09-	CJCA	1968		0-N131	TB [DG]	
2.0 TDI	05/09-	CAGA, CJCA, CAGC, CJCC, CAHA, CGLB	1968		0-N1336	TB [DG]	
2.0 TDI	05/09-	CAGA, CJCA, CAGC, CJCC, CAHA, CGLB	1968		0-N1905	TB [BT]	
2.0 TDI	07/09-	CJCC	1968		0-N131	TB [DG]	
2.0 TFSI	06/09-	BWE	1984		0-N1316	TB [DG]	
2.0 TFSI	06/09-	BWE	1984		0-N1346	TB [DG]	
2.0 TFSI	06/09-	BWE	1984		0-N2208	TB [TE]	
1.6	06/09-09/10	ALZ	1595		0-N1662	VB [DG]	
1.6	06/09-09/10	ALZ	1595		0-N1671	VB [BT]	S
1.8 T	06/09-05/10	CFMA	1781		0-N1662	VB [DG]	
1.8 T	06/09-05/10	CFMA	1781		0-N1671	VB [BT]	S
1.8 TSI	05/10-	CDHA, CDHB	1798		0-N2026	VB [TE]	S
1.8 TSI	05/10-	CDHA, CDHB	1798		0-N2027	VB [DG]	
2.0 TDI	05/09-	CAGA, CJCA, CAGC, CJCC, CAHA, CGLB	1968		0-N1534	VB [BT]	S
2.0 TDI	05/09-	CAGA	1968		0-N1738	VB [DG]	
2.0 TDI	05/09-	CAGC, CJCC, CAHA, CGLB	1968		0-N1738	VB [DG]	
2.0 TFSI	06/09-	BWE	1984		0-N1662	VB [DG]	
2.0 TFSI	06/09-	BWE	1984		0-N1671	VB [BT]	S
2.0 TFSI	05/10-	CDND	1984		0-N2026	VB [TE]	S
2.0 TFSI	05/10-	CDND	1984		0-N2027	VB [DG]	

IBIZA I (021A)

1.2, 1.2i	11/84-12/93	021 A 1000, 021 C.1000	1193	19.05x112	SK-1024	BTK	
1.5, 1.5i	11/84-05/93	021 A 2000, 021 B.2000	1461	19.05x112	SK-1024	BTK	
1.7	01/91-05/93	021 A.3000	1675	19.05x112	SK-1024	BTK	
1.2, 1.2i	11/84-12/93	021 A 1000, 021 C.1000	1193		0-N859	TB [TE]	
1.5, 1.5i, 1.5i KAT	11/84-05/93	021 A 2000, 021 B.2000, 021 C.2000, 021 D.2000	1461		0-N859	TB [TE]	
1.7	01/91-05/93	021 A.3000, 021 B.3000	1675		0-N859	TB [TE]	

IBIZA II (6K1)

1.0	03/93-09/96	AAU	1043	19x128	R-1190AQ1	BTKW	
1.0i	09/96-08/99	ALD	999	19x135; :→ALD037979; mit Zubehör	SK-1131	BTK	
1.0i	09/96-08/99	ALD	999	19x135; :→ALD037979; mit Zubehör	SK-1131AQ2	BTKW	
1.0i	09/96-08/99	AUC	999	19x135; mit Zubehör	SK-1592	BTK	
1.0i	09/96-08/99	ALD	999	19x135; :ALD037980→; mit Zubehör	SK-1592	BTK	
1.3i	03/93-08/99	2G, AAV	1272	19x128	R-1190AQ1	BTKW	
1.4	12/97-04/99	ANX	1390	19x135; mit Zubehör; Baumuster: 6K1	SK-1131	BTK	
1.4	12/97-04/99	ANX	1390	19x135; mit Zubehör	SK-1131AQ1	BTKW	
1.4i	09/93-08/99	ABD	1390	19x128	R-1190AQ1	BTKW	
1.4i	09/93-08/99	AEX, AKV, APQ	1390	19x135; :→AKK127806; mit Zubehör	SK-1131	BTK	
1.4i	09/93-08/99	AEX, AKV, APQ	1390	19x135; mit Zubehör	SK-1131AQ1	BTKW	
1.4i	09/93-08/99	ABD, AEX, AKV, APQ	1390	19x135; :→AKK127806; mit Zubehör	SK-1131AQ2	BTKW	
1.4i	09/93-08/99	ABD, AEX, AKV, APQ	1390	19x135; :AKK127807→; mit Zubehör	SK-1592	BTK	
1.4i 16V	06/97-08/99	AFH	1390	20x130; 17x58; beinhalten Rollen: 4	SK-1511	BTK	
1.4i 16V	06/97-08/99	AFH	1390	20x130; 17x58; beinhalten Rollen: 4	SK-1511AQ1	BTKW	
1.4i 16V	06/97-08/99	AFH	1390	25x149	SK-1635	BTK	
1.4i 16V	06/97-08/99	AFH	1390	25x149	SK-1635AQ1	BTKW	
1.6i	03/93-08/99	ABU	1598	19x133	R-1257AQ1	BTKW	
1.6i	03/93-08/99	AEE, ALM	1598	19x137; mit Zubehör	SK-1074	BTK	
1.6i	03/93-08/99	ALM	1598	19x137	SK-1074AQ1	BTKW	
1.6i	09/94-06/99	1F	1595	18x121; mit Zubehör	SK-1026	BTK	
1.6i	04/96-08/99	AFT	1595	18x121; mit Zubehör	SK-1090	BTK	
1.6i	04/96-08/99	AFT, AKL, APF, AUR	1595	23x138; Baumuster: 6K1	SK-1109	BTK	
1.6i	04/96-08/99	AKL, APF, AUR	1595	23x138	SK-1109AQ1	BTKW	
1.8i	03/93-08/99	ABS, ACC, ADZ	1781	18x121; mit Zubehör	SK-1026	BTK	
1.8i 16V	11/93-08/96	ADL	1781	25x147; 02/1994 →	SK-1047	BTK	
1.8i 16V	11/93-08/96	ADL	1781	25x147	SK-1124	BTK	
1.9 D	04/93-08/96	1Y, AEY	1896	25.4x137; → 07/1994; :→1Y378364; mit Zubehör	SK-1029	BTK	
1.9 D	04/93-08/96	1Y, AEY	1896	25.4x137; 07/1994 →; :378365→; mit Zubehör	SK-1122	BTK	
1.9 D	10/94-08/96	1Y	1896	25.4x137; :→1Y378364; mit Zubehör	SK-1029	BTK	
1.9 D	10/94-08/96	1Y	1896	25x141; :→AGP229903, AQM004132; mit Zubehör	SK-1110	BTK	

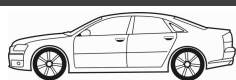
CM³

Art. Nr.



IBIZA II (6K1)							
1.9 D	10/94-08/96	1Y	1896	25x141; :AGP229904, AQM004133→; :→AGP595000, AQM045000; mit Zubehör	SK-1111	BTK	
1.9 D	10/94-08/96	1Y	1896	25.4x137; mit Zubehör	SK-1122	BTK	
1.9 D	10/94-08/96	1Y	1896	25x141; :AGP595001, AQM045001→; mit Zubehör	SK-1258	BTK	
1.9 D	10/94-08/96	1Y	1896	25x141; :AGP595001, AQM045001→; mit Zubehör	SK-1258AQ1	BTKW	
1.9 D	10/94-08/96	1Y	1896	25x141; :→AGP229903, AQM004132	SK-1259	BTK	
1.9 D, 1.9 SDI	04/93-08/99	1Y, AEY, AEY	1896	25.4x137; mit Zubehör	SK-1425	BTK	
1.9 SDI	08/96-08/99	AEY	1896	25.4x137; :378365→; mit Zubehör	SK-1122	BTK	
1.9 TD	03/93-08/96	AAZ	1896	25.4x137; → 07/1994; :→AAZ552765; mit Zubehör	SK-1029	BTK	
1.9 TD	03/93-08/96	AAZ	1896	25.4x137; 07/1994 →; :AAZ552766→; mit Zubehör	SK-1122	BTK	
1.9 TDI	08/96-08/99	1Z, AHU	1896	25x137; mit Zubehör	SK-1098	BTK	
1.9 TDI	08/96-08/99	1Z, AHU	1896	25x141; :→AGR565000, ALH500000; mit Zubehör	SK-1111	BTK	
1.9 TDI	08/96-08/99	1Z, AHU	1896	25x141; :→AGR565000, ALH500000; mit Zubehör	SK-1111AQ1	BTKW	
1.9 TDI	08/96-08/99	1Z, AHU	1896	25x141; :AGR565001, ALH500001→; mit Zubehör	SK-1258	BTK	
1.9 TDI	08/96-08/99	AGR, ALH	1896	25x141; :AGR565001, ALH500001→; mit Zubehör	SK-1258AQ1	BTKW	
1.9 TDI	02/97-08/99	AFN	1896	25x137; 07/1997 →; mit Zubehör	SK-1098	BTK	
1.9 TDI	02/97-08/99	AFN	1896	25x141; 07/1997 →; :→ASV150000; mit Zubehör	SK-1111	BTK	
1.9 TDI	02/97-08/99	AFN	1896	25x141; :→ASV150000; mit Zubehör	SK-1111AQ1	BTKW	
1.9 TDI	02/97-08/99	AFN	1896	25x141; 07/1997 →; :ASV150001→; mit Zubehör	SK-1258	BTK	
1.9 TDI	02/97-08/99	ASV	1896	25x141; :ASV150001→; mit Zubehör	SK-1258AQ1	BTKW	
2.0 i	03/93-08/99	2E, AGG	1984	18x124; mit Zubehör	SK-1120	BTK	
2.0 i 16V	08/96-08/99	ABF	1984	25x151; → 04/1999	SK-1104	BTK	
1.0 i	09/96-08/99	AER	999		0-N106	TB [TE]	
1.4 i	09/93-08/99	AEX, AKV, APQ	1390		0-N106	TB [TE]	
1.4 i 16V	06/97-08/99	AFH	1390		0-N1258	TB [TE]	
1.4 i 16V	06/97-08/99	AFH	1390		0-N165	TB [DG]	
1.6 i	03/93-08/99	ABU, AEE, ALM	1598		0-N106	TB [TE]	
1.6 i	09/94-08/99	1F, AFT	1595		0-N805	TB [TE]	
1.8 i	03/93-08/99	ABS, ACC, ADZ	1781		0-N805	TB [TE]	
1.8 i 16V	11/93-08/96	ADL	1781		0-N129	TB [TE]	
1.9 D	04/93-08/96	1Y, 1Y, AEY	1896	:378365→	0-N104	TB [TE]	
1.9 D	04/93-08/96	1Y, 1Y, AEY	1896	:→378364	0-N806	TB [TE]	
1.9 SDI, 1.9 TDI	08/96-08/99	1Z, AHU, AEY, AFN	1896		0-N104	TB [TE]	
1.9 SDI, 1.9 TDI	08/96-08/99	1Z, AHU, AEY, AFN	1896		0-N128	TB [DG]	
1.9 TD	03/93-08/96	AAZ	1896	:552766→	0-N104	TB [TE]	
1.9 TD	03/93-08/96	AAZ	1896	:→552765	0-N806	TB [TE]	
2.0 i	03/93-08/99	2E, AGG	1984		0-N805	TB [TE]	
2.0 i 16V	08/96-08/99	ABF	1984		0-N129	TB [TE]	
1.0 i	09/96-08/99	AER	999	für Fahrzeuge mit Servolenkung	0-N1445	VB [BT]	S
1.0 i	09/96-08/99	AER	999		0-N1459	VB [BT]	S
1.4 i	09/93-08/99	ABD	1390	ch.6K-ZR-195001, 6K-ZR-757001→; für Fahrzeuge mit Servolenkung	0-N1445	VB [BT]	S
1.4 i	09/93-08/99	AEX, AKV, APQ	1390	für Fahrzeuge mit Servolenkung	0-N1445	VB [BT]	S
1.4 i	09/93-08/99	ABD	1390	ch.→6K-ZR-195000, 6K-ZR-757000; für Fahrzeuge mit Servolenkung	0-N1459	VB [BT]	S
1.4 i	09/93-08/99	AEX, AKV, APQ	1390	, für Fahrzeuge mit Servolenkung	0-N1459	VB [BT]	S
1.4 i 16V	06/97-08/99	AFH	1390		0-N1445	VB [BT]	S
1.4 i 16V	06/97-08/99	AFH	1390		0-N1459	VB [BT]	S
1.6 i	03/93-08/99	AEE, ALM	1598		0-N1445	VB [BT]	S
1.6 i	03/93-08/99	ABU	1598		0-N1459	VB [BT]	S
1.6 i	03/93-08/99	AEE, ALM	1598		0-N1459	VB [BT]	S
1.6 i	09/94-08/99	1F, AFT	1595		0-N1417	VB [TE]	
1.6 i	09/94-08/99	1F, AFT	1595		0-N1660	VB [BT]	
1.8 i, 1.8 i 16V	03/93-08/99	ABS, ACC, ADZ, ADL	1781		0-N1417	VB [TE]	
1.8 i, 1.8 i 16V	03/93-08/99	ABS, ACC, ADZ, ADL	1781		0-N1660	VB [BT]	
1.9 D, 1.9 SDI, 1.9 TD, 1.9 TDI	03/93-08/99	1Y, 1Y, AEY, 1Z, AHU, AAZ, AEY, AFN	1896		0-N1417	VB [TE]	
1.9 D, 1.9 SDI, 1.9 TD, 1.9 TDI	03/93-08/99	1Y, 1Y, AEY, 1Z, AHU, AAZ, AEY, AFN	1896		0-N1609	VB [BT]	
2.0 i, 2.0 i 16V	03/93-08/99	2E, AGG, ABF	1984		0-N1417	VB [TE]	



CM³



Art. Nr.

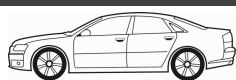

IBIZA II (6K1)							
2.0 i, 2.0 i 16V	03/93-08/99	2E, AGG, ABF	1984			0-N1660	VB [BT]
IBIZA III (6K1)							
1.0	08/99-02/02	ALD, ANV	999	19x135; :→ALD037979; mit Zubehör		SK-1131	BTK
1.0	08/99-02/02	ANV	999	19x135; mit Zubehör		SK-1131AQ2	BTKW
1.0	08/99-02/02	ALD	999	19x135; :→ALD037979; mit Zubehör		SK-1131AQ2	BTKW
1.0	08/99-02/02	AUC	999	19x135; mit Zubehör		SK-1592	BTK
1.0	08/99-02/02	ALD	999	19x135; :ALD037980→; mit Zubehör		SK-1592	BTK
1.0 16V	10/99-02/02	AST, AVZ	999	25x149; 05/2000 →		SK-1635	BTK
1.0 16V	10/99-02/02	AST, AVZ	999	25x149		SK-1635AQ1	BTKW
1.4	08/99-02/02	AKK, ANW, AUD	1390	19x128		R-1190AQ1	BTKW
1.4	08/99-02/02	AKK	1390	19x135; :→AKK127806; mit Zubehör		SK-1131	BTK
1.4	08/99-02/02	AKK, ANW, AUD	1390	19x135; mit Zubehör		SK-1131AQ1	BTKW
1.4	08/99-02/02	AKK	1390	19x135; :→AKK127806; mit Zubehör		SK-1131AQ2	BTKW
1.4	08/99-02/02	ANW, AUD	1390	19x135; mit Zubehör		SK-1592	BTK
1.4	08/99-02/02	AKK	1390	19x135; :AKK127807→; mit Zubehör		SK-1592	BTK
1.4	08/99-02/02	AKK, ANW, AUD	1390	19x135; :128807→; mit Zubehör		SK-1592AQ1	BTKW
1.4 16V	08/99-02/02	APE, AUA, AQQ, AUB	1390	20x130; 17x58; beinhalten Rollen: 4		SK-1511	BTK
1.4 16V	08/99-02/02	APE, AUA, AQQ, AUB	1390	20x130; 17x58; beinhalten Rollen: 4		SK-1511AQ1	BTKW
1.4 16V	08/99-02/02	AQQ, AUB	1390	25x149		SK-1635	BTK
1.4 16V	08/99-02/02	AQQ, AUB	1390	25x149		SK-1635AQ1	BTKW
1.6	08/99-02/02	ALM	1598	19x133		R-1257AQ1	BTKW
1.6	08/99-02/02	AEE, ALM	1598	19x137; mit Zubehör		SK-1074	BTK
1.6	08/99-02/02	ALM	1598	19x137		SK-1074AQ1	BTKW
1.6	08/99-02/02	AFT	1595	18x121; mit Zubehör		SK-1090	BTK
1.6	08/99-02/02	AEH, AFT, AKL, APF, AUR	1595	23x138; Baumuster: 6K1		SK-1109	BTK
1.6	08/99-02/02	AEH, AKL, APF, AUR	1595	23x138		SK-1109AQ1	BTKW
1.8 T 20V Cupra	07/00-02/02	AQX, AYP	1781	23x150		SK-1660	BTK
1.8 T 20V Cupra	07/00-02/02	AQX, AYP	1781	23x150		SK-1660AQ1	BTKW
1.8 T 20V Cupra	07/00-02/02	AQX, AYP	1781	23x150		SK-1710	BTK
1.9 SDI	08/99-02/02	AGP, AQM	1896	25.4x137; :→1Y378364; mit Zubehör		SK-1029	BTK
1.9 SDI	08/99-02/02	AGP, AQM	1896	25x141; :→AGP229903, AQM004132; mit Zubehör		SK-1110	BTK
1.9 SDI	08/99-02/02	AGP, AQM	1896	25x141; :AGP229904, AQM004133→; :→AGP595000, AQM045000; mit Zubehör		SK-1111	BTK
1.9 SDI	08/99-02/02	AGP	1896	25x141; :AGP229904→; :→AGP595000; mit Zubehör		SK-1111AQ1	BTKW
1.9 SDI	08/99-02/02	AQM	1896	25x141; :AQM004133→; :→AQM045000; mit Zubehör		SK-1111AQ1	BTKW
1.9 SDI	08/99-02/02	AGP, AQM	1896	25.4x137; :378365→; mit Zubehör		SK-1122	BTK
1.9 SDI	08/99-02/02	AGP, AQM	1896	25x141; :AGP595001, AQM045001→; mit Zubehör		SK-1258	BTK
1.9 SDI	08/99-02/02	AGP	1896	25x141; :AGP595001→; mit Zubehör		SK-1258AQ1	BTKW
1.9 SDI	08/99-02/02	AQM	1896	25x141; :AQM045001→; mit Zubehör		SK-1258AQ1	BTKW
1.9 SDI	08/99-02/02	AGP, AQM	1896	25x141; :→AGP229903, AQM004132		SK-1259	BTK
1.9 TDI	08/99-02/02	AGR, ALH, ASK, ASV	1896	25x137; mit Zubehör		SK-1098	BTK
1.9 TDI	08/99-02/02	AGR, ALH	1896	25x141; :→AGR565000, ALH500000; mit Zubehör		SK-1111	BTK
1.9 TDI	08/99-02/02	ASV	1896	25x141; :→ASV150000; mit Zubehör		SK-1111	BTK
1.9 TDI	08/99-02/02	AGR, ALH	1896	25x141; :→ALH500000; mit Zubehör		SK-1111AQ1	BTKW
1.9 TDI	08/99-02/02	ASK, ASV	1896	25x141; :→ASV150000; mit Zubehör		SK-1111AQ1	BTKW
1.9 TDI	08/99-02/02	AGR, ALH	1896	25x141; :AGR565001, ALH500001→; mit Zubehör		SK-1258	BTK
1.9 TDI	08/99-02/02	ASV	1896	25x141; :ASV150001→; mit Zubehör		SK-1258	BTK
1.9 TDI	08/99-02/02	AGR, ALH	1896	25x141; :AGR565001, ALH500001→; mit Zubehör		SK-1258AQ1	BTKW
1.9 TDI	08/99-02/02	ASK, ASV	1896	25x141; :ASV150001→; mit Zubehör		SK-1258AQ1	BTKW
1.0	08/99-02/02	ANV	999			0-N106	TB [TE]
1.0	08/99-02/02	ALD	999	:→037979		0-N106	TB [TE]
1.0	08/99-02/02	AUC	999			0-N1331	TB [TE]
1.0	08/99-02/02	ALD	999	:037980→		0-N1331	TB [TE]
1.0 16V	10/99-02/02	AST, AVZ	999			0-N1258	TB [TE]
1.0 16V	10/99-02/02	AST, AVZ	999			0-N165	TB [DG]
1.4	08/99-02/02	AKK	1390	:→127806		0-N106	TB [TE]
1.4	08/99-02/02	ANW, AUD	1390			0-N1331	TB [TE]
1.4	08/99-02/02	AKK	1390	:127807→		0-N1331	TB [TE]
1.4 16V	08/99-02/02	APE, AUA, AQQ, AUB	1390			0-N1262	TB [DG]

CM³

Art. Nr.

**IBIZA III (6K1)**

1.4 16V	08/99-02/02	APE, AUA, AQQ, AUB	1390		0-N1263	TB [TE]	
1.4 16V	08/99-02/02	APE, AUA, AQQ, AUB	1390		0-N158	TB [TE]	
1.4 16V	08/99-02/02	APE, AUA, AQQ, AUB	1390		0-N164	TB [DG]	
1.6	08/99-02/02	ALM	1598		0-N106	TB [TE]	
1.6	08/99-02/02	AEH, AKL, APF, AUR	1595		0-N157	TB [TE]	
1.8 T 20V Cupra	07/00-02/02	AQX, AYP	1781		0-N1042	TB [TE]	
1.8 T 20V Cupra	07/00-02/02	AQX, AYP	1781		0-N1237	TB [BT]	
1.8 T 20V Cupra	07/00-02/02	AQX, AYP	1781		0-N1316	TB [DG]	
1.9 SDI	08/99-02/02	AQM	1896	:→004131	0-N107	TB [TE]	
1.9 SDI	08/99-02/02	AGP	1896	:→229902	0-N107	TB [TE]	
1.9 SDI	08/99-02/02	AQM	1896	:004059→	0-N107	TB [TE]	
1.9 SDI	08/99-02/02	AGP	1896	:229903→	0-N107	TB [TE]	
1.9 SDI	08/99-02/02	AQM	1896	:004059→	0-N167	TB [DG]	
1.9 SDI	08/99-02/02	AGP	1896	:229003→	0-N167	TB [DG]	
1.9 SDI, 1.9 TDI	08/99-02/02	AGP, AQM, AGR, ALH, ASK, ASV	1896		0-N131	TB [DG]	
1.9 SDI, 1.9 TDI	08/99-02/02	AGP, AQM, AGR, ALH, ASK, ASV	1896		0-N166	TB [DG]	
1.9 TDI	08/99-02/02	AGR, ALH	1896		0-N107	TB [TE]	
1.9 TDI	08/99-02/02	ASV	1896		0-N107	TB [TE]	
1.9 TDI	08/99-02/02	AGR, ALH, ASK, ASV	1896		0-N167	TB [DG]	
1.0, 1.0 16V	08/99-02/02	ALD, ANV, AUC, AST, AVZ	999	für Fahrzeuge mit Servolenkung	0-N1445	VB [BT]	S
1.0, 1.0 16V	08/99-02/02	ALD, ANV, AUC, AST, AVZ	999		0-N1459	VB [BT]	S
1.4 16V	05/00-02/02	APE, AUA	1390	für Fahrzeuge mit Servolenkung	0-N1459	VB [BT]	S
1.4, 1.4 16V	08/99-02/02	AKK, ANW, AUD, APE, AUA, AQQ, AUB	1390	für Fahrzeuge mit Servolenkung	0-N1445	VB [BT]	S
1.4, 1.4 16V	08/99-02/02	AKK, ANW, AUD, AQQ, AUB	1390		0-N1459	VB [BT]	S
1.6	08/99-02/02	ALM	1598		0-N1445	VB [BT]	S
1.6	08/99-02/02	ALM	1598		0-N1459	VB [BT]	S
1.9 SDI	08/99-02/02	AGP, AQM	1896		0-N1606	VB [BT]	S
1.9 SDI, 1.9 TDI	08/99-02/02	AGP, AQM, AGR, ALH, ASK, ASV	1896		0-N174	VB [DG]	
1.9 TDI	08/99-02/02	AGR, ALH	1896		0-N1538	VB [BT]	S

IBIZA IV (6L1)

1.4 16V	02/02-11/09	AUB, BBZ, BBY, BKY, BXW	1390	20x130; 17x58; beinhalten Rollen: 4	SK-1511	BTK	
1.4 16V	02/02-11/09	AUB, BBZ, BBY, BKY, BXW	1390	20x130; 17x58; beinhalten Rollen: 4	SK-1511AQ1	BTKW	
1.4 TDI	05/02-11/09	AMF, BMS, BNV, BNM	1422	30x120; mit Zubehör	SK-1372	BTK	
1.4 TDI	05/02-11/09	AMF, BMS, BNV, BNM	1422	30x120	SK-1372AQ1	BTKW	
1.6	02/03-11/09	BAH	1598	19x135; mit Zubehör	SK-1592	BTK	
1.8 T Cupra R, 1.8 T FR	12/03-05/08	BBU, BLZ, BJX, BKV	1781	23x150	SK-1661	BTK	
1.9 SDI	02/02-12/05	ASY	1896	25x141	SK-1259	BTK	
1.9 SDI	02/02-12/05	ASY	1896	25x141	SK-1259AQ1	BTKW	
1.9 TDI	02/02-11/09	ASZ, BLT, ATD, AXR, BMT	1896	30x120	SK-1372AQ1	BTKW	
1.9 TDI Cupra R	03/04-02/08	BPX, BUK	1896	30x120	SK-1372AQ3	BTKW	
1.9 TDI, 1.9 TDI Cupra R	02/02-11/09	ASZ, BLT, ATD, AXR, BMT, BPX, BUK	1896	30x120; mit Zubehör	SK-1372	BTK	
2.0	04/02-11/09	AZL, BBX	1984	23x138; Baumuster: 6L1	SK-1109	BTK	
2.0	04/02-11/09	AZL, BBX	1984	23x138	SK-1109AQ2	BTKW	
1.4 16V	02/02-11/09	AUB, BBZ, BBY, BKY, BXW	1390		0-N1262	TB [DG]	
1.4 16V	02/02-11/09	AUB, BBZ, BBY, BKY, BXW	1390		0-N1263	TB [TE]	
1.4 16V	02/02-11/09	AUB, BBZ, BBY, BKY, BXW	1390		0-N158	TB [TE]	
1.4 16V	02/02-11/09	AUB, BBZ, BBY, BKY, BXW	1390		0-N164	TB [DG]	
1.4 TDI	05/02-11/09	AMF, BMS, BNV, BNM	1422		0-N1045	TB [TE]	
1.4 TDI	05/02-11/09	AMF, BMS, BNV, BNM	1422		0-N1046	TB [DG]	
1.6	02/03-11/09	BAH	1598		0-N1331	TB [TE]	
1.8 T Cupra R, 1.8 T FR	12/03-05/08	BBU, BLZ, BJX, BKV	1781		0-N1316	TB [DG]	
1.8 T Cupra R, 1.8 T FR	12/03-05/08	BBU, BLZ, BJX, BKV	1781		0-N1566	TB [TE]	
1.8 T Cupra R, 1.8 T FR	12/03-05/08	BBU, BLZ, BJX, BKV	1781		0-N1567	TB [BT]	
1.9 SDI	02/02-12/05	ASY	1896		0-N107	TB [TE]	
1.9 SDI	02/02-12/05	ASY	1896		0-N131	TB [DG]	
1.9 SDI	02/02-12/05	ASY	1896		0-N166	TB [DG]	
1.9 TDI, 1.9 TDI Cupra R	02/02-11/09	ASZ, BLT, ATD, AXR, BMT, BPX, BUK	1896		0-N1045	TB [TE]	
1.9 TDI, 1.9 TDI Cupra R	02/02-11/09	ASZ, BLT, ATD, AXR, BMT, BPX, BUK	1896		0-N1046	TB [DG]	
2.0	04/02-11/09	AZL, BBX	1984		0-N157	TB [TE]	
1.2, 1.2 12V	02/02-11/09	AZQ, BME, BBM, BXV	1198		0-N1908	VB [BT]	S
1.2, 1.2 12V	02/02-11/09	AZQ, BME, BBM, BXV	1198		0-N1909	VB [DG]	
1.4 16V	02/02-11/09	AUB, BBZ, BBY, BKY, BXW	1390		0-N1445	VB [BT]	S
1.4 TDI	05/02-11/09	AMF, BNM	1422		0-N1704	VB [BT]	S
1.4 TDI	06/05-11/09	CEGA, CFJA	1422		0-N1534	VB [BT]	S
1.4 TDI	06/05-11/09	BNV	1422		0-N1704	VB [BT]	S



CM³



Art. Nr.



IBIZA IV (6L1)

1.6	02/03-11/09	BAH	1598	☼	0-N1445	VB [BT]	S
1.6 16V	11/06-11/09	BTS	1598	☼; ☼	0-N1454	VB [DG]	
1.6 16V	11/06-11/09	BTS	1598	☼	0-N1525	VB [BT]	S
1.6 16V	11/06-11/09	BTS	1598	☼	0-N1733	VB [BT]	S
1.9 SDI, 1.9 TDI, 1.9 TDI Cupra R	02/02-11/09	CEGA	1896		0-N1534	VB [BT]	S
1.9 SDI, 1.9 TDI, 1.9 TDI Cupra R	02/02-11/09	ASY, ASZ, BLT, ATD, AXR, BMT, BPX, BUK	1896		0-N1536	VB [BT]	S

IBIZA V (6J5, 6P1)

1.2 TDI	05/10-	CFWA	1199	25x160; → 11/2010	SK-1695	BTK	
1.2 TDI	05/10-	CFWA	1199	25x160; → 11/2010	SK-1695AQ1	BTKW	
1.2 TDI	05/10-	CFWA	1199	25x160; 12/2010 →	SK-1727	BTK	
1.2 TDI	05/10-	CFWA	1199	25x160; → 11/2010	SK-1727AQ2	BTKW	
1.4	03/08-	BXW, CGGB	1390	20x130; 17x58; beinhaltetete Rollen: 4	SK-1511	BTK	
1.4	03/08-	BXW, CGGB	1390	20x130; 17x58; beinhaltetete Rollen: 4	SK-1511AQ1	BTKW	
1.4 TDI	07/08-06/10	BMS	1422	30x120; mit Zubehör	SK-1372	BTK	
1.4 TDI	07/08-06/10	BMS	1422	30x120	SK-1372AQ1	BTKW	
1.6 TDI	05/09-06/10	CAYA, CAYB, CAYC, CLNA	1598	25x160	SK-1695	BTK	
1.6 TDI	05/09-	CAYB, CAYC, CLNA	1598	25x160; → 11/2010	SK-1695AQ1	BTKW	
1.6 TDI	05/09-	CAYC	1598	25x160; → 11/2010	SK-1727AQ1	BTKW	
1.6 TDI	05/09-	CAYC, CLNA	1598	25x160; → 11/2010	SK-1727AQ1	BTKW	
1.6 TDI	05/09-	CAYC	1598	25x160; 2012→	SK-1727AQ2	BTKW	
1.6 TDI	05/09-	CAYC, CLNA	1598	25x160; 2012→	SK-1727AQ2	BTKW	
1.6 TDI	05/10-06/10	CAYC, CLNA	1598	25x160	SK-1727AQ2	BTKW	
1.9 TDI	03/08-06/10	BLS, BXJ	1896	30x120; mit Zubehör	SK-1372	BTK	
1.9 TDI	03/08-06/10	BLS	1896	30x120	SK-1372AQ1	BTKW	
2.0	10/08-	CEKA	1984	23x138	SK-1109	BTK	
2.0	10/08-	CEKA	1984	23x138	SK-1109AQ2	BTKW	
2.0 TDI	01/10-	CFHD	1968	25x160	SK-1695	BTK	
2.0 TDI	01/10-	CFHD	1968	25x160; → 11/2010	SK-1695AQ1	BTKW	
2.0 TDI	01/10-	CFHD	1968	25x160; → 11/2010	SK-1727AQ1	BTKW	
2.0 TDI	01/10-	CFHD	1968	25x160; 2012→	SK-1727AQ2	BTKW	
1.2 TDI	05/10-	CFWA	1199		0-N131	TB [DG]	
1.2 TDI	05/10-	CFWA	1199		0-N2025	TB [DG]	
1.2 TDI	05/10-	CFWA	1199		0-N2061	TB [TE]	
1.2 TDI	05/10-	CFWA	1199		0-N2200	TB [DG]	
1.4	03/08-	BXW, CGGB	1390		0-N1262	TB [DG]	
1.4	03/08-	BXW, CGGB	1390		0-N1263	TB [TE]	
1.4	03/08-	BXW, CGGB	1390		0-N158	TB [TE]	
1.4	03/08-	BXW, CGGB	1390		0-N164	TB [DG]	
1.4 TDI	07/08-06/10	BMS	1422		0-N1045	TB [TE]	
1.4 TDI	07/08-06/10	BMS	1422		0-N1046	TB [DG]	
1.4 TSI	10/13-	CPTA	1395		0-N2313	TB [TE]	
1.6 TDI	05/09-06/10	CAYA, CAYB, CAYC, CLNA	1598		0-N131	TB [DG]	
1.6 TDI	05/09-	CAYB	1598		0-N2025	TB [DG]	
1.6 TDI	05/09-	CAYC, CLNA	1598		0-N2025	TB [DG]	
1.6 TDI	05/09-	CAYB, CAYC, CLNA	1598		0-N2061	TB [TE]	
1.6 TDI	05/09-06/10	CAYA, CAYB, CAYC, CLNA	1598		0-N2200	TB [DG]	
1.9 TDI	03/08-06/10	BLS, BXJ	1896		0-N1045	TB [TE]	
1.9 TDI	03/08-06/10	BLS, BXJ	1896		0-N1046	TB [DG]	
2.0	10/08-	CEKA	1984		0-N157	TB [TE]	
2.0 TDI	01/10-	CFHD	1968		0-N131	TB [DG]	
2.0 TDI	01/10-	CFHD	1968		0-N2025	TB [DG]	
2.0 TDI	01/10-	CFHD	1968		0-N2061	TB [TE]	
2.0 TDI	01/10-	CFHD	1968		0-N2200	TB [DG]	
1.2	03/08-	BZG, CGPA, CJLB, CGPB	1198		0-N1908	VB [BT]	S
1.2	03/08-	BZG, CGPA, CJLB	1198	→ 09/2009; ☼	0-N1909	VB [DG]	
1.2	07/09-	CGPB	1198	☼	0-N1909	VB [DG]	
1.2 TDI	05/10-	CFWA	1199		0-N1534	VB [BT]	S
1.2 TSI	09/10-	CBZA, CBZB	1197	☼	0-N1733	VB [BT]	S
1.2 TSI	09/10-	CBZB	1197	☼	0-N2121	VB [DG]	
1.4	03/08-	BXW, CGGB	1390	☼	0-N1445	VB [BT]	S
1.4 TDI	07/08-06/10	CEGA	1422		0-N1534	VB [BT]	S
1.4 TSI	06/09-	CAVF, CNUB, CTHF, CTJB	1390	☼	0-N2050	VB [DG]	
1.4 TSI	06/09-	CAVF, CNUB, CTHF, CTJB	1390	☼	0-N2091	VB [BT]	S
1.4 TSI	06/09-	CAVF, CNUB, CTHF, CTJB	1390		0-N2092	VB [BT]	S
1.4 TSI	06/09-	CAVF, CNUB, CTHF, CTJB	1390	☼	0-N2111	VB [BT]	S

CM³

Art. Nr.

**IBIZA V (6J5, 6P1)**

1.4 TSI	06/09-	CAVF, CNUB, CTHF, CTJB	1390	Rippenanzahl: 6	0-N2133	VB [DG]	
1.6	05/08-	BTS	1598	†; *	0-N1454	VB [DG]	
1.6	05/08-	BTS	1598	*	0-N1525	VB [BT]	S
1.6 TDI	05/09-06/10	CAYA, CAYB, CAYC, CLNA	1598		0-N1534	VB [BT]	S
1.6, 1.6 LPG	05/08-	BTS, CNKA	1598	*	0-N1733	VB [BT]	S
1.9 TDI	03/08-06/10	BLS, BXJ	1896		0-N1531	VB [BT]	S
1.9 TDI	03/08-06/10	BLS, BXJ	1896		0-N1534	VB [BT]	S
2.0 TDI	01/10-	CFHD	1968		0-N1534	VB [BT]	S

IBIZA V SPORTCOUPE (6J1, 6P5)

1.2 TDI	05/10-	CFWA	1199	25x160; → 11/2010	SK-1695	BTK	
1.2 TDI	05/10-	CFWA	1199	25x160; → 11/2010	SK-1695AQ1	BTKW	
1.2 TDI	05/10-	CFWA	1199	25x160; 12/2010 →	SK-1727	BTK	
1.2 TDI	05/10-	CFWA	1199	25x160; → 11/2010	SK-1727AQ2	BTKW	
1.4	07/08-	BXW, CGGB	1390	20x130; 17x58; beinhalten Rollen: 4	SK-1511	BTK	
1.4	07/08-	BXW, CGGB	1390	20x130; 17x58; beinhalten Rollen: 4	SK-1511AQ1	BTKW	
1.4 TDI	07/08-06/10	BMS	1422	30x120; mit Zubehör	SK-1372	BTK	
1.4 TDI	07/08-06/10	BMS	1422	30x120	SK-1372AQ1	BTKW	
1.6 TDI	05/09-06/10	CAYA, CAYB, CAYC, CLNA	1598	25x160	SK-1695	BTK	
1.6 TDI	05/09-	CAYB, CAYC, CLNA	1598	25x160; → 11/2010	SK-1695AQ1	BTKW	
1.6 TDI	05/09-	CAYC	1598	25x160; → 11/2010	SK-1727AQ1	BTKW	
1.6 TDI	05/09-	CAYC, CLNA	1598	25x160; → 11/2010	SK-1727AQ1	BTKW	
1.6 TDI	05/09-	CAYC	1598	25x160; 2012→	SK-1727AQ2	BTKW	
1.6 TDI	05/09-	CAYC, CLNA	1598	25x160; 2012→	SK-1727AQ2	BTKW	
1.6 TDI	05/10-06/10	CAYC, CLNA	1598	25x160	SK-1727AQ2	BTKW	
1.9 TDI	07/08-06/10	BLS, BXJ	1896	30x120; mit Zubehör	SK-1372	BTK	
1.9 TDI	07/08-06/10	BLS	1896	30x120	SK-1372AQ1	BTKW	
2.0	10/08-	CEKA	1984	23x138	SK-1109	BTK	
2.0	10/08-	CEKA	1984	23x138	SK-1109AQ2	BTKW	
2.0 TDI	01/10-	CFHD	1968	25x160	SK-1695	BTK	
2.0 TDI	01/10-	CFHD	1968	25x160; → 11/2010	SK-1695AQ1	BTKW	
2.0 TDI	01/10-	CFHD	1968	25x160; → 11/2010	SK-1727AQ1	BTKW	
2.0 TDI	01/10-	CFHD	1968	25x160; 2012→	SK-1727AQ2	BTKW	
1.2 TDI	05/10-	CFWA	1199		0-N131	TB [DG]	
1.2 TDI	05/10-	CFWA	1199		0-N2025	TB [DG]	
1.2 TDI	05/10-	CFWA	1199		0-N2061	TB [TE]	
1.2 TDI	05/10-	CFWA	1199		0-N2200	TB [DG]	
1.4	07/08-	BXW, CGGB	1390		0-N1262	TB [DG]	
1.4	07/08-	BXW, CGGB	1390		0-N1263	TB [TE]	
1.4	07/08-	BXW, CGGB	1390		0-N158	TB [TE]	
1.4	07/08-	BXW, CGGB	1390		0-N164	TB [DG]	
1.4 TDI	07/08-06/10	BMS	1422		0-N1045	TB [TE]	
1.4 TDI	07/08-06/10	BMS	1422		0-N1046	TB [DG]	
1.4 TSI	10/13-	CPTA	1395		0-N2313	TB [TE]	
1.6 TDI	05/09-06/10	CAYA, CAYB, CAYC, CLNA	1598		0-N131	TB [DG]	
1.6 TDI	05/09-	CAYB	1598		0-N2025	TB [DG]	
1.6 TDI	05/09-	CAYC, CLNA	1598		0-N2025	TB [DG]	
1.6 TDI	05/09-	CAYB, CAYC, CLNA	1598		0-N2061	TB [TE]	
1.6 TDI	05/09-06/10	CAYA, CAYB, CAYC, CLNA	1598		0-N2200	TB [DG]	
1.9 TDI	07/08-06/10	BLS, BXJ	1896		0-N1045	TB [TE]	
1.9 TDI	07/08-06/10	BLS, BXJ	1896		0-N1046	TB [DG]	
2.0	10/08-	CEKA	1984		0-N157	TB [TE]	
2.0 TDI	01/10-	CFHD	1968		0-N131	TB [DG]	
2.0 TDI	01/10-	CFHD	1968		0-N2025	TB [DG]	
2.0 TDI	01/10-	CFHD	1968		0-N2061	TB [TE]	
2.0 TDI	01/10-	CFHD	1968		0-N2200	TB [DG]	
1.2	07/08-	BZG, CGPA, CJLB, CGPB	1198		0-N1908	VB [BT]	S
1.2	07/08-	BZG, CGPA, CJLB, CGPB	1198	*	0-N1909	VB [DG]	
1.2 TDI	05/10-	CFWA	1199		0-N1534	VB [BT]	S
1.2 TSI	09/10-	CBZA, CBZB	1197	*	0-N1733	VB [BT]	S
1.2 TSI	09/10-	CBZB	1197	*	0-N2121	VB [DG]	
1.4	07/08-	BXW, CGGB	1390	*	0-N1445	VB [BT]	S
1.4 TDI	07/08-06/10	CEGA	1422		0-N1534	VB [BT]	S
1.4 TSI, 1.4 TSI Cupra	06/09-	CAVE, CTHE, CTJC, CAVF, CNUB, CTHF, CTJB	1390	†	0-N2050	VB [DG]	

CM³

Art. Nr.

**IBIZA V SPORTCOUPE (6J1, 6P5)**

1.4 TSI, 1.4 TSI Cupra	06/09-	CAVE, CTHE, CTJC, CAVF, CNUB, CTHF, CTJB	1390	☼	0-N2091	VB [BT]	S
1.4 TSI, 1.4 TSI Cupra	06/09-	CAVE, CTHE, CTJC, CAVF, CNUB, CTHF, CTJB	1390		0-N2092	VB [BT]	S
1.4 TSI, 1.4 TSI Cupra	06/09-	CAVE, CTHE, CTJC, CAVF, CNUB, CTHF, CTJB	1390	☼	0-N2111	VB [BT]	S
1.4 TSI, 1.4 TSI Cupra	06/09-	CAVE, CTHE, CTJC, CAVF, CNUB, CTHF, CTJB	1390	Rippenanzahl: 6	0-N2133	VB [DG]	
1.6	07/08-	BTS	1598	☼; ☼	0-N1454	VB [DG]	
1.6	07/08-	BTS	1598	☼	0-N1525	VB [BT]	S
1.6 TDI	05/09-06/10	CAYA, CAYB, CAYC, CLNA	1598		0-N1534	VB [BT]	S
1.6, 1.6 LPG	07/08-	BTS, CNKA	1598	☼	0-N1733	VB [BT]	S
1.9 TDI	07/08-06/10	BLS, BXJ	1896		0-N1531	VB [BT]	S
1.9 TDI	07/08-06/10	BLS, BXJ	1896		0-N1534	VB [BT]	S
2.0 TDI	01/10-	CFHD	1968		0-N1534	VB [BT]	S

IBIZA V ST (6J8, 6P8)

1.2 TDI	04/10-	CFWA	1199	25x160; → 11/2010	SK-1695	BTK	
1.2 TDI	04/10-	CFWA	1199	25x160; → 11/2010	SK-1695AQ1	BTKW	
1.2 TDI	04/10-	CFWA	1199	25x160; 12/2010 →	SK-1727	BTK	
1.2 TDI	04/10-	CFWA	1199	25x160; → 11/2010	SK-1727AQ2	BTKW	
1.4	03/10-	CGGB	1390	20x130; 17x58; beinhaltetete Rollen: 4	SK-1511	BTK	
1.4	03/10-	CGGB	1390	20x130; 17x58; beinhaltetete Rollen: 4	SK-1511AQ1	BTKW	
1.6 TDI	03/10-	CAYB	1598	25x160	SK-1695	BTK	
1.6 TDI	03/10-	CAYC	1598	25x160	SK-1695	BTK	
1.6 TDI	03/10-	CAYB, CAYC, CLNA	1598	25x160; → 11/2010	SK-1695AQ1	BTKW	
1.6 TDI	03/10-	CAYC	1598	25x160; → 11/2010	SK-1727AQ1	BTKW	
1.6 TDI	03/10-	CAYC, CLNA	1598	25x160; → 11/2010	SK-1727AQ1	BTKW	
1.6 TDI	03/10-	CAYC	1598	25x160; 2012 →	SK-1727AQ2	BTKW	
1.6 TDI	03/10-	CAYC, CLNA	1598	25x160; 2012 →	SK-1727AQ2	BTKW	
1.2 TDI	04/10-	CFWA	1199		0-N131	TB [DG]	
1.2 TDI	04/10-	CFWA	1199		0-N2025	TB [DG]	
1.2 TDI	04/10-	CFWA	1199		0-N2061	TB [TE]	
1.2 TDI	04/10-	CFWA	1199		0-N2200	TB [DG]	
1.4	03/10-	CGGB	1390		0-N1262	TB [DG]	
1.4	03/10-	CGGB	1390		0-N1263	TB [TE]	
1.4	03/10-	CGGB	1390		0-N158	TB [TE]	
1.4	03/10-	CGGB	1390		0-N164	TB [DG]	
1.4 TSI	10/13-	CPTA	1395		0-N2313	TB [TE]	
1.6 TDI	03/10-	CAYB, CAYC, CLNA	1598		0-N131	TB [DG]	
1.6 TDI	03/10-	CAYC, CLNA	1598		0-N2025	TB [DG]	
1.6 TDI	03/10-	CAYB	1598	ch.6J-9-000001 →	0-N2025	TB [DG]	
1.6 TDI	03/10-	CAYB, CAYC, CLNA	1598		0-N2061	TB [TE]	
1.6 TDI	03/10-	CAYB, CAYC, CLNA	1598		0-N2200	TB [DG]	
1.2	05/10-	BZG, CGPA, CJLB, CGPB	1198		0-N1908	VB [BT]	S
1.2	05/10-	BZG, CGPA, CJLB, CGPB	1198	☼	0-N1909	VB [DG]	
1.2 TDI	04/10-	CFWA	1199		0-N1534	VB [BT]	S
1.2 TSI	09/10-	CBZA, CBZB	1197	☼	0-N1733	VB [BT]	S
1.2 TSI	09/10-	CBZB	1197	☼	0-N2121	VB [DG]	
1.4	03/10-	CGGB	1390	☼	0-N1445	VB [BT]	S
1.6 TDI	03/10-	CAYB, CAYC, CLNA	1598		0-N1534	VB [BT]	S

INCA (6K9)

1.4 16V	04/00-06/03	AUA	1390	20x130; 17x58; beinhaltetete Rollen: 4	SK-1511	BTK	
1.4 16V	04/00-06/03	AUA	1390	20x130; 17x58; beinhaltetete Rollen: 4	SK-1511AQ1	BTKW	
1.4 i	11/95-06/03	AEX, AKV, APQ	1390	19x135; mit Zubehör	SK-1131	BTK	
1.4 i	11/95-06/03	AEX, AKV, APQ	1390	19x135; mit Zubehör	SK-1131AQ1	BTKW	
1.4 i	11/95-06/03	AUD	1390	19x135; mit Zubehör	SK-1592	BTK	
1.4 i	11/95-06/03	AUD	1390	19x135; mit Zubehör	SK-1592AQ1	BTKW	
1.6 i	11/95-05/98	1F	1595	18x121; mit Zubehör	SK-1026	BTK	
1.6 i	06/97-09/00	AEE	1598	19x137; mit Zubehör; Baumuster: 6K9	SK-1074	BTK	
1.6 i	06/97-09/00	ALM	1598	19x137	SK-1074AQ1	BTKW	
1.7 D	09/96-06/03	AHB	1716	25.4x137; mit Zubehör	SK-1425	BTK	
1.9 D	11/95-06/03	1Y	1896	25.4x137; (☼): → 705902; mit Zubehör	SK-1029	BTK	
1.9 D	11/95-06/03	1Y	1896	25x141; (☼): → AYQ005517; mit Zubehör	SK-1111	BTK	
1.9 D	11/95-06/03	1Y	1896	25x141; (☼): → AYQ005517; mit Zubehör	SK-1111AQ1	BTKW	
1.9 D	11/95-06/03	1Y	1896	25x141; (☼): AYQ005518 →; mit Zubehör	SK-1258	BTK	

CM³

Art. Nr.



INCA (6K9)							
1.9 D	11/95-06/03	AYQ	1896	25x141; :AYQ005518→; mit Zubehör	SK-1258AQ1	BTKW	
1.9 D	11/95-06/03	1Y	1896	25.4x137; mit Zubehör	SK-1425	BTK	
1.9 D, 1.9 SDI	11/95-06/03	1Y, 1Y, AEY, AYQ	1896	25.4x137; mit Zubehör	SK-1122	BTK	
1.9 SDI	11/95-06/03	AYQ	1896	25x141; :→AYQ005517; mit Zubehör	SK-1111	BTK	
1.9 SDI	11/95-06/03	AYQ	1896	25x141; :→AYQ005517; mit Zubehör	SK-1111AQ1	BTKW	
1.9 SDI	11/95-06/03	AYQ	1896	25x141; :AYQ005518→; mit Zubehör	SK-1258	BTK	
1.9 SDI	11/95-06/03	AQY	1896	25x141; 09/2000 →; :AQY005518→; mit Zubehör	SK-1258AQ1	BTKW	
1.9 SDI	11/95-06/03	AEY	1896	25.4x137; mit Zubehör	SK-1425	BTK	
1.9 TDI	09/96-06/03	AHU, ALE	1896	25x137; mit Zubehör	SK-1098	BTK	
1.9 TDI	09/96-06/03	ALH	1896	25x141; → 09/2001; :→500000; mit Zubehör	SK-1111	BTK	
1.9 TDI	09/96-06/03	ALH	1896	25x141; mit Zubehör	SK-1258	BTK	
1.4 16V	04/00-06/03	AUA	1390		0-N1262	TB [DG]	
1.4 16V	04/00-06/03	AUA	1390		0-N1263	TB [TE]	
1.4 16V	04/00-06/03	AUA	1390		0-N158	TB [TE]	
1.4 16V	04/00-06/03	AUA	1390		0-N164	TB [DG]	
1.4 i	11/95-06/03	AEX, AKV, APQ	1390		0-N106	TB [TE]	
1.4 i	11/95-06/03	AUD	1390		0-N1331	TB [TE]	
1.6 i	11/95-05/98	1F	1595		0-N805	TB [TE]	
1.6 i	06/97-09/00	AEE, ALM	1598		0-N106	TB [TE]	
1.7 D	09/96-06/03	AHB	1716		0-N104	TB [TE]	
1.7 D	09/96-06/03	AHB	1716		0-N128	TB [DG]	
1.9 D	11/95-06/03	1Y	1896		0-N104	TB [TE]	
1.9 D	11/95-06/03	1Y	1896		0-N128	TB [DG]	
1.9 SDI	11/95-06/03	AEY	1896		0-N104	TB [TE]	
1.9 SDI	11/95-06/03	AYQ	1896	09/2000 →	0-N107	TB [TE]	
1.9 SDI	11/95-06/03	AEY	1896		0-N128	TB [DG]	
1.9 SDI	11/95-06/03	AYQ	1896		0-N131	TB [DG]	
1.9 SDI	11/95-06/03	AYQ	1896		0-N166	TB [DG]	
1.9 SDI	11/95-06/03	AYQ	1896		0-N167	TB [DG]	
1.9 TDI	09/96-06/03	ALH	1896		0-N107	TB [TE]	
1.9 TDI	09/96-06/03	ALH	1896		0-N131	TB [DG]	
1.9 TDI	09/96-06/03	ALH	1896		0-N166	TB [DG]	
1.9 TDI	09/96-06/03	ALH	1896		0-N167	TB [DG]	
1.4 16V	04/00-06/03	AUA	1390	, für Fahrzeuge mit Servolenkung	0-N1459	VB [BT]	S
1.4 16V, 1.4 i	11/95-06/03	AEX, AKV, APQ, AUD, AUA	1390	für Fahrzeuge mit Servolenkung	0-N1445	VB [BT]	S
1.4 i	11/95-06/03	AEX, AKV, APQ, AUD	1390		0-N1459	VB [BT]	S
1.6 i	11/95-05/98	1F	1595		0-N1417	VB [TE]	
1.6 i	11/95-05/98	1F	1595		0-N1660	VB [BT]	
1.6 i	06/97-09/00	AEE, ALM	1598	für Fahrzeuge mit Servolenkung	0-N1445	VB [BT]	S
1.6 i	06/97-09/00	AEE, ALM	1598	, für Fahrzeuge mit Servolenkung	0-N1459	VB [BT]	S
1.7 D	09/96-06/03	AHB	1716		0-N1417	VB [TE]	
1.7 D	09/96-06/03	AHB	1716		0-N1609	VB [BT]	
1.9 D	11/95-06/03	1Y	1896		0-N1417	VB [TE]	
1.9 D	11/95-06/03	1Y	1896		0-N1609	VB [BT]	
1.9 SDI	11/95-06/03	AEY	1896		0-N1417	VB [TE]	
1.9 SDI	11/95-06/03	AYQ	1896		0-N1606	VB [BT]	S
1.9 SDI	11/95-06/03	AEY	1896		0-N1609	VB [BT]	
1.9 SDI	11/95-06/03	AYQ	1896		0-N174	VB [DG]	
1.9 TDI	09/96-06/03	ALH	1896		0-N1538	VB [BT]	S
1.9 TDI	09/96-06/03	ALH	1896		0-N174	VB [DG]	
LEON (1M1)							
1.4 16V	11/99-06/06	APE, AXP, BCA	1390	20x130; 17x58; beinhalten Rollen: 4	SK-1511	BTK	
1.4 16V	11/99-06/06	AHW	1390	20x130; 17x58; :160001→; beinhalten Rollen: 4	SK-1511	BTK	
1.4 16V	11/99-06/06	APE, AXP, BCA	1390	20x130; 17x58; beinhalten Rollen: 4	SK-1511AQ1	BTKW	
1.4 16V	11/99-06/06	AHW	1390	20x130; 17x58; :AHW160001→; beinhalten Rollen: 4	SK-1511AQ1	BTKW	
1.4 16V	11/99-06/06	AHW	1390	20x130; 17x58; → 07/2005; :→AHW160000	SK-1585	BTK	
1.4 16V	11/99-06/06	AHW	1390	20x130; 17x58; :→160000	SK-1585AQ1	BTKW	
1.6	11/99-06/06	AEH, AKL	1595	23x138; Baumuster: 1M1	SK-1109	BTK	
1.6	11/99-06/06	AEH, AKL, APF, BFQ, BGU	1595	23x138	SK-1109AQ1	BTKW	
1.6	10/05-06/06	BFQ	1595	23x138; Baumuster: 1M1	SK-1109	BTK	
1.6 16 V	09/00-06/06	ATN, AUS, AZD, BCB	1598	20x130; 17x58; beinhalten Rollen: 4	SK-1511	BTK	



CM³



Art. Nr.



LEON (1M1)								
1.6 16 V	09/00-06/06	ATN, AUS, AZD, BCB	1598	20x130; 17x58; beinhaltete Rollen: 4	SK-1511AQ2	BTKW		
1.8 20V T 4	11/99-06/06	AJQ, ARY	1781	23x150; ch.→1M-YB088000, 1M-YR016500; 03/2000 →; mit Spanndämpfer, Spannrolle	SK-1337	BTK		
1.8 20V T 4	11/99-06/06	AJQ, ARY	1781	23x150; ch.→1M-YB088000, 1M-YR016500; 03/2000 →; mit Spanndämpfer, Spannrolle	SK-1337AQ1	BTKW		
1.8 20V T 4	11/99-06/06	AJQ, ARY	1781	23x150; ch.1M-YB088001, 1M-YR016501→; 03/2000 →	SK-1660	BTK		
1.8 20V T 4	11/99-06/06	AJQ, ARY	1781	23x150; ch.1M-YB088001, 1M-YR016501→; 03/2000 →	SK-1660AQ1	BTKW		
1.8 20V T 4	11/99-06/06	AJQ, ARY	1781	23x150; ch.→1M-YB088000, 1M-YR016500; 03/2000 →	SK-1709	BTK		
1.8 20V T 4	11/99-06/06	AJQ, ARY	1781	23x150; ch.1M-YB088001, 1M-YR016501→; 03/2000 →	SK-1710	BTK		
1.8 20V, 1.8 20V T	11/99-06/06	AGN, APG, APP, AUQ	1781	23x150; ch.→1M-YB088000, 1M-YR016500; mit Spanndämpfer, Spannrolle	SK-1337	BTK		
1.8 20V, 1.8 20V T	11/99-06/06	AGN, APG, APP, AUQ	1781	23x150; ch.→1M-YB088000, 1M-YR016500; mit Spanndämpfer, Spannrolle	SK-1337AQ1	BTKW		
1.8 20V, 1.8 20V T	11/99-06/06	AGN, APG, APP, AUQ	1781	23x150; ch.1M-YB088001, 1M-YR016501→	SK-1660	BTK		
1.8 20V, 1.8 20V T	11/99-06/06	AGN, APG, APP, AUQ	1781	23x150; ch.1M-YB088001, 1M-YR016501→	SK-1660AQ1	BTKW		
1.8 20V, 1.8 20V T	11/99-06/06	AGN, APG, APP, AUQ	1781	23x150; ch.→1M-YB088000, 1M-YR016500	SK-1709	BTK		
1.8 20V, 1.8 20V T	11/99-06/06	AGN, APG, APP, AUQ	1781	23x150; ch.1M-YB088001, 1M-YR016501→	SK-1710	BTK		
1.8 T Cupra R	02/02-06/06	AMK	1781	23x150; 05/2002 →	SK-1660	BTK		
1.8 T Cupra R	02/02-06/06	AMK	1781	23x150; ch.1M-YB088001, 1M-YR016501→; 05/2002 →	SK-1660AQ1	BTKW		
1.8 T Cupra R	02/02-06/06	AMK	1781	23x150; 05/2002 →	SK-1710	BTK		
1.8 T Cupra R	07/03-06/06	BAM	1781	23x150	SK-1660	BTK		
1.8 T Cupra R	07/03-06/06	BAM	1781	23x150	SK-1660AQ1	BTKW		
1.8 T Cupra R	07/03-06/06	BAM	1781	23x150	SK-1710	BTK		
1.9 SDI	11/99-06/06	AQM	1896	25x141; 06/2000 →; →AQM030000; mit Zubehör	SK-1110	BTK		
1.9 SDI	11/99-06/06	AQM	1896	25x141; 06/2000 →; →AQM030001→; →AQM045000; mit Zubehör	SK-1111	BTK		
1.9 SDI	11/99-06/06	AQM	1896	25x141; →AQM030001→; →AQM045000; mit Zubehör	SK-1111AQ1	BTKW		
1.9 SDI	11/99-06/06	AQM	1896	25x141; 06/2000 →; →AQM045001→; mit Zubehör	SK-1258	BTK		
1.9 SDI	11/99-06/06	AQM	1896	25x141; →AQM045001→; mit Zubehör	SK-1258AQ1	BTKW		
1.9 SDI	11/99-06/06	AQM	1896	25x141; →AQM030000	SK-1259	BTK		
1.9 TDI	11/99-06/06	AGR	1896	25x141; →AGR565000; mit Zubehör	SK-1111	BTK		
1.9 TDI	11/99-06/06	AHF	1896	25x141; →AHF006065; mit Zubehör	SK-1111	BTK		
1.9 TDI	11/99-06/06	ALH	1896	25x141; →ALH500000; mit Zubehör	SK-1111	BTK		
1.9 TDI	11/99-06/06	ASV	1896	25x141; →ASV150000; mit Zubehör	SK-1111	BTK		
1.9 TDI	11/99-06/06	ALH	1896	25x141; 05/2000 →; →ALH500000; mit Zubehör	SK-1111AQ1	BTKW		
1.9 TDI	11/99-06/06	AGR	1896	25x141; →AGR565000; mit Zubehör	SK-1111AQ1	BTKW		
1.9 TDI	11/99-06/06	AHF	1896	25x141; →AHF595000; mit Zubehör	SK-1111AQ1	BTKW		
1.9 TDI	11/99-06/06	ASV	1896	25x141; →ASV150000; mit Zubehör	SK-1111AQ1	BTKW		
1.9 TDI	11/99-06/06	AGR, ALH	1896	25x141; →AGR565001, ALH500001→; mit Zubehör	SK-1258	BTK		
1.9 TDI	11/99-06/06	AHF, ASV	1896	25x141; →AHF595001, ASV150001→; mit Zubehör	SK-1258	BTK		
1.9 TDI	11/99-06/06	ALH	1896	25x141; 05/2000 →; →ALH500001→; mit Zubehör	SK-1258AQ1	BTKW		
1.9 TDI	11/99-06/06	AGR	1896	25x141; →AGR565001→; mit Zubehör	SK-1258AQ1	BTKW		
1.9 TDI	11/99-06/06	AHF	1896	25x141; →AHF595001→; mit Zubehör	SK-1258AQ1	BTKW		
1.9 TDI	11/99-06/06	ASV	1896	25x141; →ASV150001→; mit Zubehör	SK-1258AQ1	BTKW		
1.9 TDI	09/00-06/06	ARL	1896	30x120; ch.1M-2R-101781→; 04/2002 →	SK-1372AQ3	BTKW		
1.9 TDI	09/00-06/06	ARL	1896	30x120; ch.→1M-2R101780; → 03/2002; mit Zubehör; Baumuster: 1M1	SK-1582	BTK		
1.9 TDI	09/00-06/06	ARL	1896	30x120; ch.→1M-2R101780; → 03/2002; mit Spanndämpfer, Spannrolle; mit Zubehör; Baumuster: 1M1	SK-1583	BTK		
1.9 TDI	05/03-06/06	ASZ	1896	30x120; ch.1M-2R-101781→	SK-1372AQ2	BTKW		
1.9 TDI	05/03-06/06	ASZ	1896	30x120; ch.→1M-2R101780; mit Spanndämpfer, Spannrolle; mit Zubehör; Spannrollenbetätigung: hydraulisch	SK-1583	BTK		
1.9 TDI	05/03-06/06	ASZ	1896	30x120; ch.→1M2R101780; mit Spanndämpfer, Spannrolle; mit Zubehör	SK-1583AQ1	BTKW		
1.9 TDI	10/05-06/06	AXR	1896	30x120	SK-1372AQ2	BTKW		
1.9 TDI Syncro	05/02-06/06	ARL	1896	30x120; ch.1M-2R-101781→	SK-1372AQ3	BTKW		

CM³

Art. Nr.

**LEON (1M1)**

1.9 TDI Syncro	05/02-06/06	ARL	1896	30x120; ch.→1M-2R120000; mit Zubehör	SK-1582	BTK	
1.9 TDI Syncro	05/02-06/06	ARL	1896	30x120; ch.→1M-2R120000; mit Spanndämpfer, Spannrolle; mit Zubehör	SK-1583	BTK	
1.9 TDI, 1.9 TDI Syncro	09/00-06/06	ARL, ASZ, AXR	1896	30x120; mit Zubehör	SK-1372	BTK	
1.4 16V	11/99-06/06	AHW, APE, AUA, AXP, BCA	1390		0-N1262	TB [DG]	
1.4 16V	11/99-06/06	APE, AXP, BCA	1390		0-N1263	TB [TE]	
1.4 16V	11/99-06/06	AHW	1390	:160001→	0-N1263	TB [TE]	
1.4 16V	11/99-06/06	AHW, APE, AUA, AXP, BCA	1390		0-N158	TB [TE]	
1.4 16V	11/99-06/06	AHW	1390	:→160000	0-N159	TB [TE]	
1.4 16V	11/99-06/06	AHW, APE, AUA, AXP, BCA	1390		0-N164	TB [DG]	
1.6	11/99-06/06	AEH, AKL, APF, BFQ, BGU	1595		0-N157	TB [TE]	
1.6 16 V	09/00-06/06	ATN, AUS, AZD, BCB	1598		0-N1262	TB [DG]	
1.6 16 V	09/00-06/06	ATN, AUS, AZD, BCB	1598		0-N1263	TB [TE]	
1.6 16 V	09/00-06/06	ATN, AUS, AZD, BCB	1598		0-N158	TB [TE]	
1.6 16 V	09/00-06/06	ATN, AUS, AZD, BCB	1598		0-N164	TB [DG]	
1.8 20V T 4	11/99-06/06	AJQ, ARY	1781	ch.1M-YB088001, 1M-YR016501→; 03/2000 →	0-N1042	TB [TE]	
1.8 20V T 4	11/99-06/06	AJQ, ARY	1781	ch.→1M-YB088000, 1M-YR016500; 03/2000 →	0-N1654	TB [TE]	
1.8 20V, 1.8 20V T	11/99-06/06	AGN, APG, APP, AUQ	1781	ch.1M-YB088001, 1M-YR016501→	0-N1042	TB [TE]	
1.8 20V, 1.8 20V T	11/99-06/06	AGN, APG, APP, AUQ	1781	ch.→1M-YB088000, 1M-YR016500	0-N1654	TB [TE]	
1.8 20V, 1.8 20V T, 1.8 20V T 4, 1.8 T Cupra R	11/99-06/06	AGN, APG, AJQ, ARY, AMK, APP, AUQ	1781		0-N1237	TB [BT]	
1.8 20V, 1.8 20V T, 1.8 20V T 4, 1.8 T Cupra R	11/99-06/06	AGN, APG, AJQ, ARY, AMK, APP, AUQ, BAM	1781		0-N1316	TB [DG]	
1.8 T Cupra R	02/02-06/06	AMK	1781	ch.1M-YB088001, 1M-YR016501→; 05/2002 →	0-N1042	TB [TE]	
1.8 T Cupra R	07/03-06/06	BAM	1781		0-N1042	TB [TE]	
1.8 T Cupra R	07/03-06/06	BAM	1781		0-N1237	TB [BT]	
1.9 SDI	11/99-06/06	AQM	1896	:→029999	0-N107	TB [TE]	
1.9 SDI	11/99-06/06	AQM	1896	:030000→	0-N107	TB [TE]	
1.9 SDI	11/99-06/06	AQM	1896	:030001→	0-N167	TB [DG]	
1.9 SDI, 1.9 TDI	11/99-06/06	AGR, ALH, AHF, ASV, AQM	1896		0-N131	TB [DG]	
1.9 SDI, 1.9 TDI	11/99-06/06	AGR, ALH, AHF, ASV, AQM	1896		0-N166	TB [DG]	
1.9 TDI	11/99-06/06	AGR, ALH	1896		0-N107	TB [TE]	
1.9 TDI	11/99-06/06	AHF, ASV	1896		0-N107	TB [TE]	
1.9 TDI	11/99-06/06	AGR, ALH, AHF, ASV	1896		0-N167	TB [DG]	
1.9 TDI	05/03-06/06	ASZ, AXR	1896		0-N1045	TB [TE]	
1.9 TDI	05/03-06/06	ASZ, AXR	1896		0-N1046	TB [DG]	
1.9 TDI, 1.9 TDI Syncro	09/00-06/06	ARL	1896	ch.1M-2R120001→	0-N1045	TB [TE]	
1.9 TDI, 1.9 TDI Syncro	09/00-06/06	ARL	1896	ch.1M-2R120001→	0-N1046	TB [DG]	
1.9 TDI, 1.9 TDI Syncro	09/00-06/06	ARL	1896	ch.→1M-2R120000	0-N1048	TB [TE]	
1.9 TDI, 1.9 TDI Syncro	09/00-06/06	ARL	1896	ch.→1M-2R120000	0-N1268	TB [DG]	
1.9 TDI, 1.9 TDI Syncro	09/00-06/06	ARL	1896	ch.→1M-2R120000	0-N1274	TB [BT]	
1.4 16V	11/99-06/06	AXP, BCA	1390	☼	0-N1310	VB [DG]	
1.4 16V	11/99-06/06	AHW, APE, AUA, AXP, BCA	1390	für Fahrzeuge mit Servolenkung	0-N1445	VB [BT]	S
1.4 16V	11/99-06/06	AHW, APE, AUA, AXP, BCA	1390	☼, für Fahrzeuge mit Servolenkung	0-N1539	VB [BT]	S
1.6 16 V	09/00-06/06	ATN, AUS, AZD, BCB	1598	☼	0-N1310	VB [DG]	
1.6 16 V	09/00-06/06	ATN, AUS, AZD, BCB	1598		0-N1445	VB [BT]	S
1.6 16 V	09/00-06/06	ATN, AUS, AZD, BCB	1598	☼	0-N1539	VB [BT]	S
1.9 SDI	11/99-06/06	AQM	1896		0-N1606	VB [BT]	S
1.9 SDI, 1.9 TDI	11/99-06/06	AGR, ALH, AHF, ASV, AQM	1896		0-N174	VB [DG]	
1.9 TDI	11/99-06/06	AGR, ALH, AHF, ASV	1896		0-N1538	VB [BT]	S
1.9 TDI, 1.9 TDI Syncro	09/00-06/06	ARL, ASZ, AXR	1896		0-N1494	VB [BT]	S
2.8 Cupra 4	02/01-06/06	AUE	2792	Rippenanzahl: 6	0-N1496S	VB [TE]	
2.8 Cupra 4	02/01-06/06	AUE	2792	Rippenanzahl: 7; ☼	0-N1657	VB [BT]	S

LEON (1P1)

1.4 16V	06/06-12/12	BXW, CGGB	1390	20x130; 17x58; beinhalten Rollen: 4	SK-1511	BTK	
1.4 16V	06/06-12/12	BXW, CGGB	1390	20x130; 17x58; beinhalten Rollen: 4	SK-1511AQ1	BTKW	
1.6	07/05-12/12	BSE, BSF, CCSA, CMXA	1595	23x138; Baumuster: 1P1	SK-1109	BTK	
1.6 LPG, 1.6 MultiFuel	12/09-12/12	BSE, CMXA, CHGA	1595	23x138	SK-1109	BTK	
1.6 TDI	02/10-12/12	CAYB, CAYC	1598	25x160	SK-1695	BTK	
1.6 TDI	02/10-12/12	CAYB, CAYC	1598	25x160; → 11/2010	SK-1695AQ1	BTKW	
1.6 TDI	02/10-12/12	CAYC	1598	25x160; → 11/2010	SK-1727AQ2	BTKW	
1.6, 1.6 LPG, 1.6 MultiFuel	07/05-12/12	BSE, BSF, CCSA, CMXA, BSE, CMXA, CHGA	1595	23x138	SK-1109AQ1	BTKW	
1.9 TDI	07/05-12/10	BKC, BLS, BXE, BXF	1896	30x120; mit Zubehör	SK-1372	BTK	



CM³



Art. Nr.



LEON (1P1)

1.9 TDI	07/05-12/10	BKC, BLS, BXE, BXF	1896	30x120	SK-1372AQ1	BTKW
1.9 TDi	10/05-12/12	ASV	1896	25x141; →595000; mit Zubehör	SK-1111	BTK
1.9 TDi	10/05-12/12	ASV	1896	25x141; mit Zubehör	SK-1258	BTK
2.0 Cupra R, 2.0 FSI, 2.0 TFSI	05/05-12/12	BLR, BLY, BVY, BVZ, BWA, BWA1, BWJ, CDLD, CDLA	1984	23x148	SK-1724	BTK
2.0 Cupra R, 2.0 TFSI	05/05-12/12	BWA, BWA1, BWJ, CDLD, CDLA	1984	23x148	SK-1724AQ1	BTKW
2.0 FSI	07/05-05/10	BLR, BLY, BVY, BVZ	1984	23x148	SK-1724AQ2	BTKW
2.0 TDI	07/05-05/10	AZV	1968	30x141; ch.→1P7000000; mit Zubehör	SK-1595AQ1	BTKW
2.0 TDI	07/05-05/10	AZV	1968	30x141; ch.1P-7-000001→; mit Zubehör	SK-1668	BTK
2.0 TDI	07/05-05/10	AZV	1968	30x141; ch.1P-7-000001→	SK-1668AQ1	BTKW
2.0 TDI	10/05-10/10	BMM	1968	30x120; mit Zubehör	SK-1372	BTK
2.0 TDI	10/05-10/10	BMM	1968	30x120	SK-1372AQ2	BTKW
2.0 TDI	05/06-12/12	BMN	1968	30x141; mit Zubehör	SK-1668	BTK
2.0 TDI	05/06-12/12	BMN	1968	30x141	SK-1668AQ1	BTKW
2.0 TDI	05/06-12/12	CEGA	1968	30x160	SK-1694	BTK
2.0 TDI	05/06-12/12	CEGA	1968	30x160	SK-1694AQ2	BTKW
2.0 TDI	05/06-12/12	CFJA	1968	25x160; → 11/2010	SK-1695	BTK
2.0 TDI	05/06-12/12	CFJA	1968	25x160; → 11/2010	SK-1695AQ1	BTKW
2.0 TDI	05/06-12/12	CFJA	1968	25x160; 12/2010 →	SK-1727	BTK
2.0 TDI	05/06-12/12	CFJA	1968	25x160; → 11/2010	SK-1727AQ2	BTKW
2.0 TDI 16V	07/05-12/12	BKD	1968	30x141; ch.→1P7000000; mit Zubehör	SK-1595AQ1	BTKW
2.0 TDI 16V	07/05-12/12	BKD	1968	30x141; ch.1P-7-000001→; mit Zubehör	SK-1668	BTK
2.0 TDI 16V	07/05-12/12	BKD	1968	30x141; ch.1P-7-000001→	SK-1668AQ1	BTKW
2.0 TDI 16V	07/05-12/12	CFHC, CLCB	1968	25x160; → 11/2010	SK-1695	BTK
2.0 TDI 16V	07/05-12/12	CFHC, CLCB	1968	25x160; → 11/2010	SK-1695AQ1	BTKW
2.0 TDI 16V	07/05-12/12	CFHC, CLCB	1968	25x160; 12/2010 →	SK-1727	BTK
2.0 TDI 16V	07/05-12/12	CFHC, CLCB	1968	25x160; → 11/2010	SK-1727AQ2	BTKW
2.0 TDI, 2.0 TDI 16V	07/05-12/12	AZV, BKD, CFHC, CLCB	1968	30x141; ch.→1P-7-000000; mit Zubehör	SK-1595	BTK
1.4 16V	06/06-12/12	BXW, CGGB	1390		0-N1262	TB [DG]
1.4 16V	06/06-12/12	BXW, CGGB	1390		0-N1263	TB [TE]
1.4 16V	06/06-12/12	BXW, CGGB	1390		0-N158	TB [TE]
1.4 16V	06/06-12/12	BXW, CGGB	1390		0-N164	TB [DG]
1.6 TDI	02/10-12/12	CAYB, CAYC	1598		0-N131	TB [DG]
1.6 TDI	02/10-12/12	CAYB, CAYC	1598		0-N2025	TB [DG]
1.6 TDI	02/10-12/12	CAYB, CAYC	1598		0-N2061	TB [TE]
1.6 TDI	02/10-12/12	CAYB, CAYC	1598		0-N2200	TB [DG]
1.6, 1.6 LPG, 1.6 MultiFuel	07/05-12/12	BSE, BSF, CCSA, CMXA, BSE, CMXA, CHGA	1595		0-N157	TB [TE]
1.9 TDI	07/05-12/10	BKC, BLS, BXE, BXF	1896		0-N1045	TB [TE]
1.9 TDI	07/05-12/10	BKC, BLS, BXE, BXF	1896		0-N1046	TB [DG]
1.9 TDi	10/05-12/12	ASV	1896		0-N107	TB [TE]
1.9 TDi	10/05-12/12	ASV	1896		0-N131	TB [DG]
1.9 TDi	10/05-12/12	ASV	1896		0-N166	TB [DG]
1.9 TDi	10/05-12/12	ASV	1896		0-N167	TB [DG]
2.0 Cupra R, 2.0 FSI, 2.0 TFSI	05/05-12/12	BLR, BLY, BVY, BVZ, BWA, BWA1, BWJ, CDLD, CDLA	1984		0-N1316	TB [DG]
2.0 Cupra R, 2.0 FSI, 2.0 TFSI	05/05-12/12	BLR, BLY, BVY, BVZ, BWA, BWA1, BWJ, CDLD, CDLA	1984		0-N1346	TB [DG]
2.0 Cupra R, 2.0 FSI, 2.0 TFSI	05/05-12/12	BLR, BLY, BVY, BVZ, BWA, BWA1, BWJ, CDLD, CDLA	1984		0-N2208	TB [TE]
2.0 TDI	07/05-10/10	AZV, BMM	1968		0-N1046	TB [DG]
2.0 TDI	07/05-05/10	AZV	1968		0-N1335	TB [TE]
2.0 TDI	07/05-05/10	AZV	1968	ch.→1P-7-000000	0-N1336	TB [DG]
2.0 TDI	07/05-05/10	AZV	1968	ch.1P-7-000001→	0-N1575	TB [DG]
2.0 TDI	10/05-10/10	BMM	1968		0-N1045	TB [TE]
2.0 TDI	05/06-12/12	BMN, CEGA	1968		0-N1046	TB [DG]
2.0 TDI	05/06-12/12	CFJA	1968	→ 11/2010	0-N1046	TB [DG]
2.0 TDI	05/06-12/12	CEGA	1968		0-N1268	TB [DG]
2.0 TDI	05/06-12/12	CFJA	1968		0-N131	TB [DG]
2.0 TDI	05/06-12/12	BMN	1968		0-N1335	TB [TE]
2.0 TDI	05/06-12/12	CEGA	1968		0-N1336	TB [DG]
2.0 TDI	05/06-12/12	BMN	1968		0-N1575	TB [DG]
2.0 TDI	05/06-12/12	CEGA	1968		0-N1905	TB [BT]
2.0 TDI	05/06-12/12	CFJA	1968		0-N2025	TB [DG]
2.0 TDI	05/06-12/12	CFJA	1968		0-N2061	TB [TE]
2.0 TDI	05/06-12/12	CFJA	1968	12/2010 →	0-N2200	TB [DG]

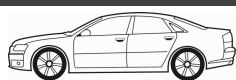
CM³

Art. Nr.



LEON (1P1)							
2.0 TDI 16V	07/05-12/12	BKD	1968		0-N1046	TB [DG]	
2.0 TDI 16V	07/05-12/12	CFHC, CLCB	1968	→ 11/2010	0-N1046	TB [DG]	
2.0 TDI 16V	07/05-12/12	CFHC, CLCB	1968		0-N131	TB [DG]	
2.0 TDI 16V	07/05-12/12	BKD	1968		0-N1335	TB [TE]	
2.0 TDI 16V	07/05-12/12	BKD	1968	ch.→1P-7-000000	0-N1336	TB [DG]	
2.0 TDI 16V	07/05-12/12	BKD	1968	ch.1P-7-000001→	0-N1575	TB [DG]	
2.0 TDI 16V	07/05-12/12	CFHC	1968		0-N2025	TB [DG]	
2.0 TDI 16V	07/05-12/12	CFHC, CLCB	1968		0-N2061	TB [TE]	
2.0 TDI 16V	07/05-12/12	CFHC, CLCB	1968	12/2010 →	0-N2200	TB [DG]	
1.2 TSI	02/10-12/12	CBZB	1197	✳	0-N1733	VB [BT]	S
1.2 TSI	02/10-12/12	CBZB	1197	✳	0-N2121	VB [DG]	
1.4 16V	06/06-12/12	BXW, CGGB	1390		0-N1445	VB [BT]	S
1.4 TSI	11/07-12/12	CAXC	1390	✳; ✳	0-N1454	VB [DG]	
1.4 TSI	11/07-12/12	CAXC	1390	✳	0-N1525	VB [BT]	S
1.4 TSI	11/07-12/12	CAXC	1390	✳	0-N1733	VB [BT]	S
1.6 TDI	02/10-12/12	CAYB, CAYC	1598		0-N1534	VB [BT]	S
1.8 TSI	06/07-12/12	BZB, CDAA	1798		0-N1832	VB [BT]	S
1.9 TDI	07/05-12/10	BKC, BLS, BXE, BXF	1896		0-N1531	VB [BT]	S
1.9 TDi	10/05-12/12	ASV	1896		0-N1538	VB [BT]	S
1.9 TDi	10/05-12/12	ASV	1896		0-N174	VB [DG]	
2.0 Cupra R, 2.0 TFSI	05/05-12/12	BWA, BWA1, CDLA	1984		0-N1656	VB [BT]	S
2.0 TDI	07/05-05/10	AZV	1968		0-N1530	VB [BT]	S
2.0 TDI	10/05-10/10	BMM	1968		0-N1531	VB [BT]	S
2.0 TDI	05/06-12/12	BMN	1968		0-N1530	VB [BT]	S
2.0 TDI	05/06-12/12	CEGA, CFJA	1968		0-N1534	VB [BT]	S
2.0 TDI 16V	07/05-12/12	BKD	1968		0-N1530	VB [BT]	S
2.0 TDI 16V	07/05-12/12	CEGA	1968		0-N1534	VB [BT]	S
2.0 TFSI	11/06-05/11	BWJ	1984		0-N1656	VB [BT]	S
2.0 TFSI	06/09-12/12	CCZB	1984		0-N1832	VB [BT]	S
LEON (5F1)							
1.2 TSI	12/12-	CJZA, CJZB, CYVA, CYVB	1197		0-N2313	TB [TE]	
1.2 TSI	12/12-	CJZA, CJZB, CYVA, CYVB	1197		0-N2381	TB [DG]	
1.4 TGI, 1.4 TSI	09/12-	CHPA, CPTA, CMBA, CXSA, CPWA, CZCA, CZEA	1395		0-N2313	TB [TE]	
1.4 TGI, 1.4 TSI	09/12-	CHPA, CPTA, CMBA, CXSA, CPWA, CZCA, CZEA	1395		0-N2381	TB [DG]	
1.6 TDI	11/12-	CLHA, CLHB, CRKB, CXXB, DBKA	1598		0-N131	TB [DG]	
1.6 TDI	11/12-	CLHA, CLHB, CRKB, CXXB, DBKA	1598		0-N2314	TB [TE]	
2.0 TDI	09/12-	CKFC, CRMB, CRVA, CRVC, CUNA, CUPA	1968		0-N131	TB [DG]	
2.0 TDI	09/12-	CKFC, CRMB, CRVA, CRVC, CUNA, CUPA	1968		0-N2314	TB [TE]	
1.6 TDI	11/12-	CLHA, CLHB	1598		0-N2288	VB [BT]	S
1.6 TDI	09/13-	CRKB, CXXB, DBKA	1598	✳	0-N2288	VB [BT]	S
2.0 TDI	09/12-	CRVA, CRVC, CUNA, CUPA	1968	✳	0-N2288	VB [BT]	S
2.0 TDI	10/12-	CKFC	1968		0-N2288	VB [BT]	S
LEON SC (5F5)							
1.2 TSI	01/13-	CJZA, CJZB, CYVA, CYVB	1197		0-N2313	TB [TE]	
1.2 TSI	01/13-	CJZA, CJZB, CYVA, CYVB	1197		0-N2381	TB [DG]	
1.4 TSI	02/13-	CHPA, CPTA, CMBA, CXSA, CZCA, CZEA	1395		0-N2313	TB [TE]	
1.4 TSI	02/13-	CHPA, CPTA, CMBA, CXSA, CZCA, CZEA	1395		0-N2381	TB [DG]	
1.6 TDI	02/13-	CLHA, CLHB, CRKB, CXXB, DBKA	1598		0-N131	TB [DG]	
1.6 TDI	02/13-	CLHA, CLHB, CRKB, CXXB, DBKA	1598		0-N2314	TB [TE]	
2.0 TDI	02/13-	CKFC, CRMB, CRVA, CRVC, CUNA, CUPA	1968		0-N131	TB [DG]	
2.0 TDI	02/13-	CKFC, CRMB, CRVA, CRVC, CUNA, CUPA	1968		0-N2314	TB [TE]	
1.6 TDI	02/13-	CLHA, CLHB	1598		0-N2288	VB [BT]	S
1.6 TDI	09/13-	CRKB, CXXB, DBKA	1598	✳	0-N2288	VB [BT]	S
2.0 TDI	02/13-	CKFC, CRMB, CRVC, CUNA, CUPA	1968		0-N2288	VB [BT]	S
2.0 TDI	02/13-	CRVA	1968	✳	0-N2288	VB [BT]	S
LEON ST (5F8)							
1.2 TSI	08/13-	CJZA, CJZB, CYVA, CYVB	1197		0-N2313	TB [TE]	
1.2 TSI	08/13-	CJZA, CJZB, CYVA, CYVB	1197		0-N2381	TB [DG]	
1.4 TGI, 1.4 TSI	10/13-	CHPA, CPTA, CMBA, CXSA, CPWA, CZCA, CZEA	1395		0-N2313	TB [TE]	
1.4 TGI, 1.4 TSI	10/13-	CHPA, CPTA, CMBA, CXSA, CPWA, CZCA, CZEA	1395		0-N2381	TB [DG]	
1.6 TDI, 1.6 TDI 4Drive	09/13-	CLHA, CLHB, CRKB, CXXB, DBKA	1598		0-N131	TB [DG]	



CM³



Art. Nr.



LEON ST (5F8)

1.6 TDI, 1.6 TDI 4Drive	09/13-	CLHA, CLHB, CRKB, CXXB, DBKA	1598		0-N2314	TB [TE]	
2.0 TDI, 2.0 TDI 4Drive	08/13-	CKFC, CRBC, CRLB, CRMB, CRBC, CRLB, CRMB, CRVA, CRVC, CUNA, CUPA	1968		0-N131	TB [DG]	
2.0 TDI, 2.0 TDI 4Drive	08/13-	CKFC, CRBC, CRLB, CRMB, CRBC, CRLB, CRMB, CRVA, CRVC, CUNA, CUPA	1968		0-N2314	TB [TE]	
1.6 TDI	09/13-	CRKB, CXXB, DBKA	1598	✳	0-N2288	VB [BT]	S
1.6 TDI, 1.6 TDI 4Drive	10/13-	CLHA, CLHB	1598		0-N2288	VB [BT]	S
2.0 TDI	10/13-	CKFC	1968		0-N2288	VB [BT]	S
2.0 TDI, 2.0 TDI 4Drive	08/13-	CRBC, CRLB, CRMB, CRVA, CRVC, CUNA, CUPA	1968	✳	0-N2288	VB [BT]	S

MALAGA (023A)

1.2, 1.2 i	11/84-12/93	021 A 1000, 021 C.1000	1193	19.05x112	SK-1024	BTK	
1.5, 1.5 i, 1.5 i KAT	05/85-12/93	021 A 2000, 021 A 2000, 021 C.2000, 021 D.2000, 021 B.2000	1461	19.05x112	SK-1024	BTK	
1.2, 1.2 i	05/85-12/93	021 A 1000, 021 C.1000	1193		0-N859	TB [TE]	
1.5, 1.5 i, 1.5 i KAT	05/85-12/93	021 A 2000, 021 A 2000, 021 C.2000, 021 D.2000, 021 B.2000	1461		0-N859	TB [TE]	

Mii (KF1_)

1.0, 1.0 EcoFuel	10/11-	CHYA, CHYB, CPGA	999		0-N2313	TB [TE]	
1.0, 1.0 EcoFuel	10/11-	CHYA, CHYB, CPGA	999		0-N2381	TB [DG]	
1.0, 1.0 EcoFuel	10/11-	CHYA, CHYB, CPGA	999	✳, für Fahrzeuge ohne Start-Stopp-Funktion	0-N2271	VB [TE]	

RONDA (022A)

1.2	10/84-12/86	021 A 1000	1193	19.05x112	SK-1024	BTK	
1.5	09/84-12/86	021 A 2000	1461	19.05x112	SK-1024	BTK	
1.2	08/83-05/85	021A1000	1193		0-N859	TB [TE]	
1.2	10/84-12/86	021 A 1000	1193		0-N859	TB [TE]	
1.5	09/84-12/86	021 A 2000	1461		0-N859	TB [TE]	

TOLEDO I (1L)

1.6 i	05/91-03/99	1F, 1F, ABN, EZ	1595	18x121; mit Zubehör	SK-1026	BTK	
1.6 i	11/96-03/99	AFT	1595	18x121; mit Zubehör	SK-1090	BTK	
1.8 16V	05/91-03/99	KR, PL	1781	25x147	SK-1047	BTK	
1.8 i	05/91-12/96	ABS, ACC, ADZ, RP	1781	18x121; mit Zubehör	SK-1026	BTK	
1.9 D	05/91-03/99	1Y	1896	25.4x137; → 05/1997; :→1Y705902; mit Zubehör	SK-1029	BTK	
1.9 D	05/91-03/99	1Y	1896	25.4x137; 05/1997 →; :705903→; mit Zubehör	SK-1122	BTK	
1.9 TD	05/91-03/99	AAZ	1896	25.4x137; → 04/1997; :→AAZ634078; mit Zubehör	SK-1029	BTK	
1.9 TD	05/91-03/99	AAZ	1896	25.4x137; 05/1997 →; :AAZ634079→; mit Zubehör	SK-1122	BTK	
1.9 TDI	08/95-03/99	1Z, AHU	1896	25.4x137; :→1Z289575, AHU136385; mit Zubehör	SK-1069	BTK	
1.9 TDI	08/95-03/99	1Z, AHU	1896	25x137; :289576, AHU136386→; mit Zubehör	SK-1098	BTK	
1.9 TDI	11/96-03/99	AFN	1896	25.4x137; :→AFN136733; mit Zubehör	SK-1069	BTK	
1.9 TDI	11/96-03/99	AFN	1896	25x137; :AFN136734→; mit Zubehör	SK-1098	BTK	
2.0 i	05/91-03/99	2E, AGG	1984	18x124; mit Zubehör	SK-1120	BTK	
2.0 i 16V	11/93-03/99	ABF	1984	25x151; 03/1994 → 10/1998	SK-1104	BTK	
1.6 i	05/91-03/99	1F, 1F, ABN, EZ, AFT	1595		0-N805	TB [TE]	
1.8 16V, 1.8 GT	05/91-03/99	KR, PL	1781		0-N808	TB [TE]	
1.8 i	05/91-12/96	ABS, ACC, ADZ, RP	1781		0-N805	TB [TE]	
1.9 D	05/91-03/99	1Y	1896	:705903→	0-N104	TB [TE]	
1.9 D	05/91-03/99	1Y	1896	:→705902	0-N806	TB [TE]	
1.9 TD	05/91-03/99	AAZ	1896	:634079→	0-N104	TB [TE]	
1.9 TD	05/91-03/99	AAZ	1896	:→634078	0-N806	TB [TE]	
1.9 TDI	08/95-03/99	AHU	1896	:→136385	0-N103	TB [TE]	
1.9 TDI	08/95-03/99	1Z	1896	:→289576	0-N103	TB [TE]	
1.9 TDI	08/95-03/99	AHU	1896		0-N104	TB [TE]	
1.9 TDI	08/95-03/99	1Z	1896	:289577→	0-N104	TB [TE]	
1.9 TDI	08/95-03/99	1Z, AHU, AFN	1896		0-N128	TB [DG]	
1.9 TDI	11/96-03/99	AFN	1896	:→136733	0-N103	TB [TE]	
1.9 TDI	11/96-03/99	AFN	1896	:136734→	0-N104	TB [TE]	
2.0 i	05/91-03/99	2E, AGG	1984		0-N805	TB [TE]	
2.0 i 16V	11/93-03/99	ABF	1984		0-N129	TB [TE]	
1.6 i	05/91-03/99	1F, 1F, ABN, EZ, AFT	1595		0-N1417	VB [TE]	
1.6 i	05/91-03/99	1F, 1F, ABN, EZ, AFT	1595		0-N1660	VB [BT]	
1.8 i	05/91-12/96	ABS, ACC, ADZ, RP	1781		0-N1417	VB [TE]	

CM³

Art. Nr.



TOLEDO I (1L)

1.8 i	05/91-12/96	ABS, ACC, ADZ, RP	1781		0-N1660	VB [BT]
1.9 D, 1.9 TD, 1.9 TDI	05/91-03/99	1Y, 1Z, AHU, AAZ, AFN	1896		0-N1417	VB [TE]
1.9 D, 1.9 TD, 1.9 TDI	05/91-03/99	1Y, 1Z, AHU, AAZ, AFN	1896		0-N1609	VB [BT]
2.0 i, 2.0 i 16V	05/91-03/99	2E, AGG, ABF	1984		0-N1417	VB [TE]
2.0 i, 2.0 i 16V	05/91-03/99	2E, AGG, ABF	1984		0-N1660	VB [BT]

TOLEDO II (1M2)

1.4 16V	01/00-05/02	APE, AXP, BCA	1390	20x130; 17x58; beinhaltenete Rollen: 4	SK-1511	BTK
1.4 16V	01/00-05/02	AHW	1390	20x130; 17x58; :160001→; beinhaltenete Rollen: 4	SK-1511	BTK
1.4 16V	01/00-05/02	APE, AXP, BCA	1390	20x130; 17x58; beinhaltenete Rollen: 4	SK-1511AQ1	BTKW
1.4 16V	01/00-05/02	AHW	1390	20x130; 17x58; :AHW160001→; beinhaltenete Rollen: 4	SK-1511AQ1	BTKW
1.4 16V	01/00-05/02	AHW	1390	20x130; 17x58; :01/2000 → 05/2002; :→AHW160000	SK-1585	BTK
1.4 16V	01/00-05/02	AHW	1390	20x130; 17x58; :→160000	SK-1585AQ1	BTKW
1.6	10/98-07/04	AEH, AKL	1595	23x138; Baumuster: 1M2	SK-1109	BTK
1.6	10/98-07/04	AEH, AKL, APF	1595	23x138	SK-1109AQ1	BTKW
1.6	08/05-05/06	BFQ	1595	23x138	SK-1109	BTK
1.6 16V	06/00-05/06	AUS, AZD, BCB	1598	20x130; 17x58; beinhaltenete Rollen: 4	SK-1511	BTK
1.6 16V	06/00-05/06	AUS, AZD, BCB	1598	20x130; 17x58; beinhaltenete Rollen: 4	SK-1511AQ2	BTKW
1.8 20V, 1.8 20VT, 1.8 AWD	10/98-10/05	AGN, APG, AJQ, ARY, AMK, APP, AUQ, BAM	1781	23x150; ch.→1M-YB088000, 1M-YR016500; mit Spanndämpfer, Spannrolle	SK-1337	BTK
1.8 20V, 1.8 20VT, 1.8 AWD	10/98-10/05	AGN, APG, AJQ, ARY, AMK, APP, AUQ, BAM	1781	23x150; ch.→1M-YB088000, 1M-YR016500; mit Spanndämpfer, Spannrolle	SK-1337AQ1	BTKW
1.8 20V, 1.8 20VT, 1.8 AWD	10/98-10/05	AGN, APG, AJQ, ARY, AMK, APP, AUQ, BAM	1781	23x150; ch.1M-YB088001, 1M-YR016501→	SK-1660	BTK
1.8 20V, 1.8 20VT, 1.8 AWD	10/98-10/05	AGN, APG, AJQ, ARY, AMK, APP, AUQ, BAM	1781	23x150; ch.1M-YB088001, 1M-YR016501→	SK-1660AQ1	BTKW
1.8 20V, 1.8 20VT, 1.8 AWD	10/98-10/05	AGN, APG, AJQ, ARY, AMK, APP, AUQ, BAM	1781	23x150; ch.→1M-YB088000, 1M-YR016500	SK-1709	BTK
1.8 20V, 1.8 20VT, 1.8 AWD	10/98-10/05	AGN, APG, AJQ, ARY, AMK, APP, AUQ, BAM	1781	23x150; ch.1M-YB088001, 1M-YR016501→	SK-1710	BTK
1.9 SDI	11/99-06/04	AQM	1896	25x141; 06/2000 →; :→AQM030000; mit Zubehör	SK-1110	BTK
1.9 SDI	11/99-06/04	AQM	1896	25x141; 06/2000 →; :AQM030001→; :→AQM045000; mit Zubehör	SK-1111	BTK
1.9 SDI	11/99-06/04	AQM	1896	25x141; :AQM030001→; :→AQM045000; mit Zubehör	SK-1111AQ1	BTKW
1.9 SDI	11/99-06/04	AQM	1896	25x141; 06/2000 →; :AQM045001→; mit Zubehör	SK-1258	BTK
1.9 SDI	11/99-06/04	AQM	1896	25x141; :AQM045001→; mit Zubehör	SK-1258AQ1	BTKW
1.9 SDI	11/99-06/04	AQM	1896	25x141; :→AQM030000	SK-1259	BTK
1.9 TDI	10/98-07/04	AHF, ASV	1896	25x141; :→AHF006065; mit Zubehör	SK-1111	BTK
1.9 TDI	10/98-07/04	AHF	1896	25x141; :→AHF595000; mit Zubehör	SK-1111AQ1	BTKW
1.9 TDI	10/98-07/04	ASV	1896	25x141; :→ASV150000; mit Zubehör	SK-1111AQ1	BTKW
1.9 TDI	10/98-07/04	AHF, ASV	1896	25x141; :AHF595001→; mit Zubehör	SK-1258	BTK
1.9 TDI	10/98-07/04	AHF	1896	25x141; :AHF595001→; mit Zubehör	SK-1258AQ1	BTKW
1.9 TDI	10/98-07/04	ASV	1896	25x141; :ASV150001→; mit Zubehör	SK-1258AQ1	BTKW
1.9 TDI	03/99-07/04	AGR, ALH	1896	25x141; :→AGR565000; mit Zubehör	SK-1111	BTK
1.9 TDI	03/99-07/04	ALH	1896	25x141; 05/2000 →; :→ALH500000; mit Zubehör	SK-1111AQ1	BTKW
1.9 TDI	03/99-07/04	AGR	1896	25x141; :→AGR565000; mit Zubehör	SK-1111AQ1	BTKW
1.9 TDI	03/99-07/04	AGR, ALH	1896	25x141; :AGR565001→; mit Zubehör	SK-1258	BTK
1.9 TDI	03/99-07/04	ALH	1896	25x141; 05/2000 →; :ALH500001→; mit Zubehör	SK-1258AQ1	BTKW
1.9 TDI	03/99-07/04	AGR	1896	25x141; :AGR565001→; mit Zubehör	SK-1258AQ1	BTKW
1.9 TDI	10/00-05/06	ARL, ASZ	1896	30x120; mit Zubehör	SK-1372	BTK
1.9 TDI	10/00-07/04	ARL	1896	30x120; mit Zubehör; Baumuster: 1M2	SK-1582	BTK
1.9 TDI	10/00-07/04	ARL	1896	30x120; mit Spanndämpfer, Spannrolle; mit Zubehör; Baumuster: 1M2	SK-1583	BTK
1.9 TDI	05/03-05/06	ASZ	1896	30x120	SK-1372AQ2	BTKW
1.4 16V	01/00-05/02	AHW, APE, AUA, AXP, BCA	1390		0-N1262	TB [DG]
1.4 16V	01/00-05/02	APE, AUA, AXP, BCA	1390		0-N1263	TB [TE]
1.4 16V	01/00-05/02	AHW	1390	:160001→	0-N1263	TB [TE]
1.4 16V	01/00-05/02	AHW, APE, AUA, AXP, BCA	1390		0-N158	TB [TE]
1.4 16V	01/00-05/02	AHW	1390	:→160000	0-N159	TB [TE]
1.4 16V	01/00-05/02	AHW, APE, AUA, AXP, BCA	1390		0-N164	TB [DG]
1.6	10/98-05/06	AEH, AKL, APF, BFQ	1595		0-N157	TB [TE]
1.6 16V	06/00-05/06	AUS, AZD, BCB	1598		0-N1262	TB [DG]

CM³

Art. Nr.



TOLEDO II (1M2)

1.6 16V	06/00-05/06	AUS, AZD, BCB	1598			0-N1263	TB [TE]	
1.6 16V	06/00-05/06	AUS, AZD, BCB	1598			0-N158	TB [TE]	
1.6 16V	06/00-05/06	AUS, AZD, BCB	1598			0-N164	TB [DG]	
1.8 20V, 1.8 20VT, 1.8 AWD	10/98-10/05	AGN, APG, AJQ, ARY, AMK, APP, AUQ, BAM	1781	ch.1M-YB088001, 1M-YR016501→		0-N1042	TB [TE]	
1.8 20V, 1.8 20VT, 1.8 AWD	10/98-10/05	AGN, APG, AMK, APP, AUQ, BAM	1781			0-N1237	TB [BT]	
1.8 20V, 1.8 20VT, 1.8 AWD	10/98-10/05	AGN, APG, AMK, APP, AUQ, BAM	1781			0-N1316	TB [DG]	
1.8 20V, 1.8 20VT, 1.8 AWD	10/98-10/05	AGN, APG, AJQ, ARY, AMK, APP, AUQ, BAM	1781	ch.→1M-YB088000, 1M-YR016500		0-N1654	TB [TE]	
1.8 20VT	09/00-07/04	APP, AUQ	1781			0-N131	TB [DG]	
1.9 SDI	11/99-06/04	AQM	1896	ENGINE:→029999		0-N107	TB [TE]	
1.9 SDI	11/99-06/04	AQM	1896	ENGINE:030000→		0-N107	TB [TE]	
1.9 SDI	11/99-06/04	AQM	1896	ENGINE:030001→		0-N167	TB [DG]	
1.9 SDI, 1.9 TDI	10/98-07/04	AGR, ALH, AHF, ASV, AQM	1896			0-N131	TB [DG]	
1.9 SDI, 1.9 TDI	10/98-07/04	AGR, ALH, AHF, ASV, AQM	1896			0-N166	TB [DG]	
1.9 TDI	10/98-07/04	AHF, ASV	1896			0-N107	TB [TE]	
1.9 TDI	10/98-07/04	AGR, ALH, AHF, ASV	1896			0-N167	TB [DG]	
1.9 TDI	03/99-07/04	AGR, ALH	1896			0-N107	TB [TE]	
1.9 TDI	10/00-07/04	ARL	1896	ch.1M-2R120001→		0-N1046	TB [DG]	
1.9 TDI	10/00-07/04	ARL	1896	ch.→1M-2R120000		0-N1048	TB [TE]	
1.9 TDI	10/00-07/04	ARL	1896	ch.→1M-2R120000		0-N1268	TB [DG]	
1.9 TDI	10/00-07/04	ARL	1896	ch.→1M-2R120000		0-N1274	TB [BT]	
1.9 TDI	05/03-05/06	ASZ	1896			0-N1045	TB [TE]	
1.9 TDI	05/03-05/06	ASZ	1896			0-N1046	TB [DG]	
1.4 16V	01/00-05/02	AHW, APE, AUA, AXP, BCA	1390	✳		0-N1310	VB [DG]	
1.4 16V	01/00-05/02	AHW, APE, AUA, AXP, BCA	1390	für Fahrzeuge mit Servolenkung		0-N1445	VB [BT]	S
1.4 16V	01/00-05/02	AHW, APE, AUA, AXP, BCA	1390	✳		0-N1539	VB [BT]	S
1.6 16V	06/00-05/06	AZD, BCB	1598	✳		0-N1310	VB [DG]	
1.6 16V	06/00-05/06	AUS, AZD, BCB	1598			0-N1445	VB [BT]	S
1.6 16V	06/00-05/06	AZD, BCB	1598	✳		0-N1539	VB [BT]	S
1.9 SDI	11/99-06/04	AQM	1896			0-N1606	VB [BT]	S
1.9 TDI	10/98-07/04	AGR, ALH, AHF, ASV	1896			0-N1538	VB [BT]	S
1.9 TDI	10/98-07/04	AGR, ALH, AHF, ASV	1896			0-N174	VB [DG]	
1.9 TDI	10/00-07/04	ARL	1896			0-N1494	VB [BT]	S
2.3 V5	10/98-11/00	AGZ	2324	Rippenanzahl: 6		0-N2017	VB [BT]	S
2.3 V5, 2.3 V5 20V	10/98-11/03	AGZ, AQN	2324	Rippenanzahl: 6		0-N1496S	VB [TE]	

TOLEDO III (5P2)

1.4 16V	05/06-05/09	BXW	1390	20x130; 17x58; beinhaltetete Rollen: 4		SK-1511	BTK	
1.4 16V	05/06-05/09	BXW	1390	20x130; 17x58; beinhaltetete Rollen: 4		SK-1511AQ1	BTKW	
1.6	10/04-05/09	BGU, BSE, BSF, CCSA	1595	23x138; Baumuster: 5P2		SK-1109	BTK	
1.6	10/04-05/09	BGU, BSE, BSF, CCSA	1595	23x138		SK-1109AQ1	BTKW	
1.9 TDI	10/04-05/09	BJB, BKC, BLS, BXE	1896	30x120; mit Zubehör		SK-1372	BTK	
1.9 TDI	10/04-05/09	BJB, BKC, BLS, BXE	1896	30x120		SK-1372AQ1	BTKW	
2.0 FSI	10/04-05/09	BLR, BLY, BVY, BVZ	1984	23x148		SK-1724AQ2	BTKW	
2.0 FSI, 2.0 TFSI	10/04-05/09	BLR, BLY, BVY, BVZ, BWA	1984	23x148		SK-1724	BTK	
2.0 TDI	09/04-05/09	AZV	1968	30x141; ch.→5P-7-032500; mit Zubehör		SK-1595	BTK	
2.0 TDI	09/04-05/09	AZV	1968	30x141; ch.→5P-7-032500; mit Zubehör		SK-1595AQ1	BTKW	
2.0 TDI	09/04-05/09	AZV	1968	30x141; ch.5P-7-032501→; mit Zubehör		SK-1668	BTK	
2.0 TDI	09/04-05/09	AZV	1968	30x141; ch.5P-7-032501→		SK-1668AQ1	BTKW	
2.0 TDI	11/05-05/09	BMM	1968	30x120; mit Zubehör		SK-1372	BTK	
2.0 TDI	11/05-05/09	BMM	1968	30x120		SK-1372AQ2	BTKW	
2.0 TDI	01/06-05/09	BMN	1968	30x141; mit Zubehör		SK-1668	BTK	
2.0 TDI	01/06-05/09	BMN	1968	30x141		SK-1668AQ1	BTKW	
2.0 TDI	01/06-05/09	CEGA	1968	30x160		SK-1694	BTK	
2.0 TDI	01/06-05/09	CEGA	1968	30x160		SK-1694AQ2	BTKW	
2.0 TDI 16V	04/04-05/09	BKD	1968	30x141; ch.→5P-6-100000; mit Zubehör		SK-1595	BTK	
2.0 TDI 16V	04/04-05/09	BKD	1968	30x141; ch.→5P-6-100000; mit Zubehör		SK-1595AQ1	BTKW	
2.0 TDI 16V	04/04-05/09	BKD	1968	30x141; ch.5P-6-100001→; mit Zubehör		SK-1668	BTK	
2.0 TDI 16V	04/04-05/09	BKD	1968	30x141; ch.5P-6-100001→		SK-1668AQ1	BTKW	
2.0 TFSI	11/05-05/09	BWA	1984	23x148		SK-1724AQ1	BTKW	
1.6	10/04-05/09	BGU, BSE, BSF, CCSA	1595			0-N157	TB [TE]	
1.9 TDI	10/04-05/09	BJB, BKC, BLS, BXE	1896			0-N1045	TB [TE]	
1.9 TDI	10/04-05/09	BJB, BKC, BLS, BXE	1896			0-N1046	TB [DG]	
2.0 FSI, 2.0 TFSI	10/04-05/09	BLR, BLY, BVY, BVZ, BWA	1984			0-N1316	TB [DG]	
2.0 FSI, 2.0 TFSI	10/04-05/09	BLR, BLY, BVY, BVZ, BWA	1984			0-N1346	TB [DG]	

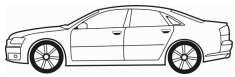
CM³

Art. Nr.

**TOLEDO III (5P2)**

2.0 FSI, 2.0 TFSI	10/04-05/09	BLR, BLY, BVY, BVZ, BWA	1984		0-N2208	TB [TE]	
2.0 TDI	11/05-05/09	BMM	1968		0-N1045	TB [TE]	
2.0 TDI	01/06-05/09	BMN, CEGA	1968		0-N1046	TB [DG]	
2.0 TDI	01/06-05/09	CEGA	1968		0-N1268	TB [DG]	
2.0 TDI	01/06-05/09	BMN	1968		0-N1335	TB [TE]	
2.0 TDI	01/06-05/09	CEGA	1968		0-N1336	TB [DG]	
2.0 TDI	01/06-05/09	BMN	1968		0-N1575	TB [DG]	
2.0 TDI	01/06-05/09	CEGA	1968		0-N1905	TB [BT]	
2.0 TDI, 2.0 TDI 16V	04/04-05/09	AZV, BKD, BMM	1968		0-N1046	TB [DG]	
2.0 TDI, 2.0 TDI 16V	04/04-05/09	AZV, BKD	1968		0-N1335	TB [TE]	
2.0 TDI, 2.0 TDI 16V	04/04-05/09	AZV, BKD	1968	ch.→5P-7-032500	0-N1336	TB [DG]	
2.0 TDI, 2.0 TDI 16V	04/04-05/09	AZV, BKD	1968	ch.5P-7-032501→	0-N1575	TB [DG]	
1.8 TFSI	01/07-05/09	BYT, BZB, CDAA	1798		0-N1832	VB [BT]	S
1.9 TDI	10/04-05/09	BJB, BKC, BLS, BXE	1896		0-N1531	VB [BT]	S
2.0 TDI	11/05-05/09	BMM	1968		0-N1531	VB [BT]	S
2.0 TDI	01/06-05/09	BMN	1968		0-N1530	VB [BT]	S
2.0 TDI	01/06-05/09	BMN, CEGA	1968		0-N1534	VB [BT]	S
2.0 TDI, 2.0 TDI 16V	04/04-05/09	AZV, BKD	1968		0-N1530	VB [BT]	S
2.0 TFSI	11/05-05/09	BWA	1984		0-N1656	VB [BT]	S

TOLEDO IV (KG3)

1.6 TDI	07/12-	CAYB, CAYC, CLNA	1598	25x160	SK-1727	BTK	
1.6 TDI	07/12-	CAYC, CLNA	1598	25x160	SK-1727AQ2	BTKW	
1.6 TDI	06/13-	CAYC	1598	25x160	SK-1727AQ2	BTKW	
1.2	07/12-	CGPC	1198		0-N1908	VB [BT]	S
1.2 TSI	07/12-	CBZA, CBZB	1197	✳	0-N1733	VB [BT]	S
1.4 TSI	07/12-	CAXA	1390	✳	0-N1733	VB [BT]	S
1.6	07/13-	CFNA	1598	✳	0-N1733	VB [BT]	S
1.6 TDI	07/12-	CAYB, CAYC, CLNA	1598	✳	0-N1534	VB [BT]	S

CM³

Art. Nr.



ohne Halter

CITIGO

1.0, 1.0 CNG	10/11-	CHYA, CHYB, CPGA	999		0-N2313	TB [TE]	
1.0, 1.0 CNG	10/11-	CHYA, CHYB, CPGA	999		0-N2381	TB [DG]	
1.0, 1.0 CNG	10/11-	CHYA, CHYB, CPGA	999	✳, für Fahrzeuge ohne Start-Stopp-Funktion	0-N2271	VB [TE]	

FABIA (6Y2)

1.4 16V	12/99-03/08	AUA, BBY, BKY, AUB, BBZ	1390	20x130; 17x58; ch.→6Y-54421759, 6Y-5B050001; beinhaltetete Rollen: 4	SK-1511	BTK	
1.4 16V	12/99-03/08	AUA, BBY, BKY, AUB, BBZ	1390	20x130; 17x58; beinhaltetete Rollen: 4	SK-1511AQ1	BTkW	
1.4 TDI	04/03-03/08	AMF, BNM, BNV	1422	30x120; mit Zubehör	SK-1372	BTK	
1.4 TDI	04/03-03/08	AMF, BNM, BNV	1422	30x120	SK-1372AQ1	BTkW	
1.9 SDI	12/99-03/08	ASY	1896	25x141; :→ASY021000; mit Zubehör	SK-1110	BTK	
1.9 SDI	12/99-03/08	ASY	1896	25x141; Baumuster: 6Y2	SK-1259	BTK	
1.9 SDI	12/99-03/08	ASY	1896	25x141	SK-1259AQ1	BTkW	
1.9 TDI	01/00-03/08	ATD, AXR	1896	30x120; ch.6Y-43893313→; mit Zubehör	SK-1372	BTK	
1.9 TDI	01/00-03/08	AXR	1896	30x120	SK-1372AQ1	BTkW	
1.9 TDI	01/00-03/08	ATD	1896	30x120; ch.6Y-2-407001, 6Y-2X032051→	SK-1372AQ1	BTkW	
1.9 TDI	01/00-03/08	ATD, AXR	1896	30x120; ch.→6Y-2-407000, 6Y-2-X032050; mit Zubehör; Baumuster: 6Y2	SK-1582	BTK	
1.9 TDI	01/00-03/08	ATD	1896	30x120; ch.→6Y-13-207095, 6Y-1X-013283; ohne Spanndämpfer, Spannrolle; mit Zubehör	SK-1582AQ2	BTkW	
1.9 TDI	01/00-03/08	ATD, AXR	1896	30x120; ch.→6Y-2-407000, 6Y-2-X032050; mit Spanndämpfer, Spannrolle; mit Zubehör; Baumuster: 6Y2	SK-1583	BTK	
1.9 TDI	01/00-03/08	ATD	1896	30x120; ch.→6Y-13-207095, 6Y-1X-013283; mit Spanndämpfer, Spannrolle; mit Zubehör	SK-1583AQ2	BTkW	
1.9 TDI RS	06/03-03/08	ASZ, BLT	1896	30x120; ch.6Y-2-412299, 6Y-2X032149→; mit Zubehör	SK-1372	BTK	
1.9 TDI RS	06/03-03/08	ASZ, BLT	1896	30x120	SK-1372AQ1	BTkW	
1.9 TDI RS	06/03-03/08	ASZ, BLT	1896	30x120; ch.→6Y-2-412298, 6Y-2-X032148; mit Zubehör	SK-1582	BTK	
1.9 TDI RS	06/03-03/08	ASZ, BLT	1896	30x120; ch.→6Y-2-412298, 6Y-2-X032148; mit Spanndämpfer, Spannrolle; mit Zubehör	SK-1583	BTK	
2.0	12/99-03/08	AZL	1984	23x138; Baumuster: 6Y2	SK-1109	BTK	
2.0	12/99-03/08	AZL	1984	23x138; für OE: 06A121011T	SK-1109AQ2	BTkW	
1.4 16V	12/99-03/08	AUA, BBY, BKY, AUB, BBZ	1390		0-N1262	TB [DG]	
1.4 16V	12/99-03/08	AUA, BBY, BKY, AUB, BBZ	1390		0-N1263	TB [TE]	
1.4 16V	12/99-03/08	AUA, BBY, BKY, AUB, BBZ	1390		0-N158	TB [TE]	
1.4 16V	12/99-03/08	AUA, BBY	1390		0-N164	TB [DG]	
1.4 16V	12/99-03/08	AUB	1390		0-N164	TB [DG]	
1.4 16V	12/99-03/08	BBZ	1390	ch.→6Y-54421759, 6Y-5B050001	0-N164	TB [DG]	
1.4 16V	12/99-03/08	BKY	1390	ch.→6Y-54421759, 6Y-5B050001	0-N164	TB [DG]	
1.4 TDI	04/03-03/08	AMF, BNM, BNV	1422		0-N1045	TB [TE]	
1.4 TDI	04/03-03/08	AMF, BNM, BNV	1422		0-N1046	TB [DG]	
1.9 SDI	12/99-03/08	ASY	1896	:→021000	0-N107	TB [TE]	
1.9 SDI	12/99-03/08	ASY	1896	:021001→	0-N107	TB [TE]	
1.9 SDI	12/99-03/08	ASY	1896		0-N131	TB [DG]	
1.9 SDI	12/99-03/08	ASY	1896		0-N166	TB [DG]	
1.9 TDI	01/00-03/08	ATD, AXR	1896	ch.6Y-3-740480→	0-N1045	TB [TE]	
1.9 TDI	01/00-03/08	AXR	1896		0-N1046	TB [DG]	
1.9 TDI	01/00-03/08	ATD	1896	ch.6Y-3-740480→	0-N1046	TB [DG]	
1.9 TDI	01/00-03/08	ATD	1896	ch.→6Y-3-740479	0-N1048	TB [TE]	
1.9 TDI	01/00-03/08	ATD	1896	ch.→6Y-3-740479	0-N1268	TB [DG]	
1.9 TDI	01/00-03/08	ATD	1896	ch.→6Y-3-740479	0-N1274	TB [BT]	
1.9 TDI RS	06/03-03/08	ASZ, BLT	1896		0-N1045	TB [TE]	
1.9 TDI RS	06/03-03/08	ASZ, BLT	1896		0-N1046	TB [DG]	
2.0	12/99-03/08	AZL	1984		0-N157	TB [TE]	
1.0	12/99-08/02	AQV, ARV	996		0-N1956	VB [BT]	S
1.0	12/99-08/02	AQV, ARV	996	✳	0-N2066	VB [BT]	
1.0	12/99-08/02	AQV, ARV	996	✳	0-N2067	VB [BT]	
1.2	08/02-03/08	AWY, BMD, AZQ, BME	1198		0-N1908	VB [BT]	S
1.2	08/02-03/08	AWY, BMD, AZQ, BME	1198	✳	0-N1909	VB [DG]	
1.4	08/99-05/03	AME, AQW, ATZ, AZE, AZF	1397		0-N1956	VB [BT]	S
1.4	08/99-05/03	AME, AQW, ATZ, AZE, AZF	1397	✳	0-N2066	VB [BT]	
1.4	08/99-05/03	AME, AQW, ATZ, AZE, AZF	1397	✳	0-N2067	VB [BT]	
1.4 16V	12/99-03/08	AUA, BBY, BKY, AUB, BBZ	1390	✳	0-N1445	VB [BT]	S
1.4 TDI	04/03-03/08	AMF, BNM, BNV	1422		0-N1704	VB [BT]	S
1.9 SDI, 1.9 TDI, 1.9 TDI RS	12/99-03/08	BMS	1896		0-N1534	VB [BT]	S



CM³



Art. Nr.



FABIA (6Y2)								
1.9 SDI, 1.9 TDI, 1.9 TDI RS	12/99-03/08	ASY, ASZ, BLT, ATD, AXR	1896			0-N1536	VB [BT]	S
2.0	12/99-03/08	AZL	1984			0-N1041	VB [BT]	S
FABIA Combi (6Y5)								
1.4 16V	04/00-12/07	AUB, BBZ, BUD	1390	20x130; 17x58; ch.→6Y-54421759, 6Y-5B050001; beinhaltetete Rollen: 4		SK-1511	BTK	
1.4 16V	04/00-12/07	AUA, BBY, BKY, AUB, BBZ, BUD	1390	20x130; 17x58; beinhaltetete Rollen: 4		SK-1511AQ1	BTKW	
1.4 16V	05/00-12/07	AUA, BBY, BKY	1390	20x130; 17x58; → 05/2006; beinhaltetete Rollen: 4		SK-1511	BTK	
1.4 TDI	04/03-12/07	AMF, BNM, BNV	1422	30x120; mit Zubehör		SK-1372	BTK	
1.4 TDI	04/03-12/07	AMF, BNM, BNV	1422	30x120		SK-1372AQ1	BTKW	
1.9 SDI	04/00-12/07	ASY	1896	25x141; :→ASY021000; mit Zubehör		SK-1110	BTK	
1.9 SDI	04/00-12/07	ASY	1896	25x141; Baumuster: 6Y5		SK-1259	BTK	
1.9 SDI	04/00-12/07	ASY	1896	25x141		SK-1259AQ1	BTKW	
1.9 TDI	04/00-12/07	ATD, AXR	1896	30x120; ch.6Y-43893313→; mit Zubehör		SK-1372	BTK	
1.9 TDI	04/00-12/07	AXR	1896	30x120		SK-1372AQ1	BTKW	
1.9 TDI	04/00-12/07	ATD	1896	30x120; ch.6Y-2-407001, 6Y-2X032051→		SK-1372AQ1	BTKW	
1.9 TDI	04/00-12/07	ATD, AXR	1896	30x120; ch.→6Y-2-407000, 6Y-2-X032050; mit Zubehör; Baumuster: 6Y5		SK-1582	BTK	
1.9 TDI	04/00-12/07	ATD	1896	30x120; ch.→6Y-13-207095, 6Y-1X-013283; ohne Spanndämpfer, Spannrolle; mit Zubehör		SK-1582AQ2	BTKW	
1.9 TDI	04/00-12/07	ATD, AXR	1896	30x120; ch.→6Y-2-407000, 6Y-2-X032050; mit Spanndämpfer, Spannrolle; mit Zubehör; Baumuster: 6Y5		SK-1583	BTK	
1.9 TDI	04/00-12/07	ATD	1896	30x120; ch.→6Y-13-207095, 6Y-1X-013283; mit Spanndämpfer, Spannrolle; mit Zubehör		SK-1583AQ2	BTKW	
2.0	04/00-12/07	AZL	1984	23x138; Baumuster: 6Y5		SK-1109	BTK	
2.0	04/00-12/07	AZL	1984	23x138; für OE: 06A121011T		SK-1109AQ2	BTKW	
1.4 16V	04/00-12/07	AUA, BBY, BKY, AUB, BBZ, BUD	1390			0-N1262	TB [DG]	
1.4 16V	04/00-12/07	AUA, BBY, BKY, AUB, BBZ, BUD	1390			0-N1263	TB [TE]	
1.4 16V	04/00-12/07	AUA, BBY, BKY, AUB, BBZ, BUD	1390			0-N158	TB [TE]	
1.4 16V	04/00-12/07	AUB	1390			0-N164	TB [DG]	
1.4 16V	04/00-12/07	BBZ	1390	ch.→6Y-54421759, 6Y-5B050001		0-N164	TB [DG]	
1.4 16V	05/00-12/07	AUA, BBY	1390			0-N164	TB [DG]	
1.4 16V	05/00-12/07	BKY	1390	ch.→6Y-54421759, 6Y-5B050001		0-N164	TB [DG]	
1.4 TDI	04/03-12/07	AMF, BNM, BNV	1422			0-N1045	TB [TE]	
1.4 TDI	04/03-12/07	AMF, BNM, BNV	1422			0-N1046	TB [DG]	
1.9 SDI	04/00-12/07	ASY	1896	:→021000		0-N107	TB [TE]	
1.9 SDI	04/00-12/07	ASY	1896	:021001→		0-N107	TB [TE]	
1.9 SDI	04/00-12/07	ASY	1896			0-N131	TB [DG]	
1.9 SDI	04/00-12/07	ASY	1896			0-N166	TB [DG]	
1.9 TDI	04/00-12/07	AXR	1896			0-N1045	TB [TE]	
1.9 TDI	04/00-12/07	ATD	1896	ch.6Y-3-740480→		0-N1045	TB [TE]	
1.9 TDI	04/00-12/07	AXR	1896			0-N1046	TB [DG]	
1.9 TDI	04/00-12/07	ATD	1896	ch.6Y-3-740480→		0-N1046	TB [DG]	
1.9 TDI	04/00-12/07	ATD	1896	ch.→6Y-3-740479		0-N1048	TB [TE]	
1.9 TDI	04/00-12/07	ATD	1896	ch.→6Y-3-740479		0-N1268	TB [DG]	
1.9 TDI	04/00-12/07	ATD	1896	ch.→6Y-3-740479		0-N1274	TB [BT]	
2.0	04/00-12/07	AZL	1984			0-N157	TB [TE]	
1.0	11/00-08/02	ARV	996			0-N2066	VB [BT]	
1.0	11/00-08/02	ARV	996			0-N2067	VB [BT]	
1.2	07/01-12/07	AWY, BMD, AZQ, BME	1198			0-N1908	VB [BT]	S
1.2	07/01-12/07	AWY, BMD, AZQ, BME	1198			0-N1909	VB [DG]	
1.4	04/00-05/03	AME, AQW, ATZ, AZE, AZF	1397			0-N1956	VB [BT]	S
1.4	04/00-05/03	AME, AQW, ATZ, AZE, AZF	1397			0-N2066	VB [BT]	
1.4	04/00-05/03	AME, AQW, ATZ, AZE, AZF	1397			0-N2067	VB [BT]	
1.4 16V	04/00-12/07	AUA, BBY, BKY, AUB, BBZ, BUD	1390			0-N1445	VB [BT]	S
1.4 TDI	04/03-12/07	AMF, BNM, BNV	1422			0-N1704	VB [BT]	S
1.9 SDI, 1.9 TDI	04/00-12/07	BMS	1896			0-N1534	VB [BT]	S
1.9 SDI, 1.9 TDI	04/00-12/07	ASY, ATD, AXR	1896			0-N1536	VB [BT]	S
2.0	04/00-12/07	AZL	1984			0-N1041	VB [BT]	S
FABIA Praktik								
1.4 TDI	10/05-12/07	BNM	1422	30x120; mit Zubehör		SK-1372	BTK	
1.4 TDI	10/05-12/07	BNM	1422	30x120		SK-1372AQ1	BTKW	
1.9 SDI	07/01-12/07	ASY	1896	25x141; :→ASY021000; mit Zubehör		SK-1110	BTK	
1.9 SDI	07/01-12/07	ASY	1896	25x141; Baumuster: 6Y2, 6Y3, 6Y5		SK-1259	BTK	



CM³



Art. Nr.



FABIA Praktik

1.9 SDI	07/01-12/07	ASY	1896	25x141	SK-1259AQ1	BTkW	
1.4 TDI	10/05-12/07	BNM	1422		0-N1045	TB [TE]	
1.4 TDI	10/05-12/07	BNM	1422		0-N1046	TB [DG]	
1.9 SDI	07/01-12/07	ASY	1896	:→021000	0-N107	TB [TE]	
1.9 SDI	07/01-12/07	ASY	1896	:021001→	0-N107	TB [TE]	
1.9 SDI	07/01-12/07	ASY	1896		0-N131	TB [DG]	
1.9 SDI	07/01-12/07	ASY	1896		0-N166	TB [DG]	
1.2	07/01-12/07	AWY, BMD, AZQ, BME	1198		0-N1908	VB [BT]	S
1.2	07/01-12/07	AWY, BMD, AZQ, BME	1198		0-N1909	VB [DG]	
1.4	07/01-05/03	AME, AQW, ATZ	1397		0-N1956	VB [BT]	S
1.4	07/01-05/03	AME, AQW, ATZ	1397		0-N2066	VB [BT]	
1.4	07/01-05/03	AME, AQW, ATZ	1397		0-N2067	VB [BT]	
1.4 TDI	10/05-12/07	BNM	1422		0-N1704	VB [BT]	S
1.9 SDI	07/01-12/07	BMS	1896		0-N1534	VB [BT]	S
1.9 SDI	07/01-12/07	ASY	1896		0-N1536	VB [BT]	S

FABIA Stufenheck (6Y3)

1.4 16V	10/99-12/07	AUA, BBY, BKY, AUB, BBZ, BUD	1390	20x130; 17x58; ch.→6Y-54421759, 6Y-5B050001; beinhaltetete Rollen: 4	SK-1511	BTK	
1.4 16V	10/99-12/07	AUA, BBY, BKY, AUB, BBZ, BUD	1390	20x130; 17x58; beinhaltetete Rollen: 4	SK-1511AQ1	BTkW	
1.4 TDI	04/03-12/07	AMF, BNM, BNV	1422	30x120; mit Zubehör	SK-1372	BTK	
1.4 TDI	04/03-12/07	AMF, BNM, BNV	1422	30x120	SK-1372AQ1	BTkW	
1.9 SDI	11/99-12/07	ASY	1896	25x141; :→ASY021000; mit Zubehör	SK-1110	BTK	
1.9 SDI	11/99-12/07	ASY	1896	25x141; Baumuster: 6Y3	SK-1259	BTK	
1.9 SDI	11/99-12/07	ASY	1896	25x141	SK-1259AQ1	BTkW	
1.9 TDI	01/00-12/07	ATD, AXR	1896	30x120; ch.6Y-43893313→; mit Zubehör	SK-1372	BTK	
1.9 TDI	01/00-12/07	AXR	1896	30x120	SK-1372AQ1	BTkW	
1.9 TDI	01/00-12/07	ATD	1896	30x120; ch.6Y-2-407001, 6Y-2X032051→	SK-1372AQ1	BTkW	
1.9 TDI	01/00-12/07	ATD, AXR	1896	30x120; ch.→6Y-2-407000, 6Y-2-X032050; mit Zubehör; Baumuster: 6Y3	SK-1582	BTK	
1.9 TDI	01/00-12/07	ATD	1896	30x120; ch.→6Y-13-207095, 6Y-1X-013283; ohne Spanndämpfer, Spannrolle; mit Zubehör	SK-1582AQ2	BTkW	
1.9 TDI	01/00-12/07	ATD, AXR	1896	30x120; ch.→6Y-2-407000, 6Y-2-X032050; mit Spanndämpfer, Spannrolle; mit Zubehör; Baumuster: 6Y3	SK-1583	BTK	
1.9 TDI	01/00-12/07	ATD	1896	30x120; ch.→6Y-13-207095, 6Y-1X-013283; mit Spanndämpfer, Spannrolle; mit Zubehör	SK-1583AQ2	BTkW	
2.0	12/99-12/07	AZL	1984	23x138; Baumuster: 6Y3	SK-1109	BTK	
2.0	12/99-12/07	AZL	1984	23x138; für OE: 06A121011T	SK-1109AQ2	BTkW	
1.4 16V	10/99-12/07	AUA, BBY, BKY, AUB, BBZ, BUD	1390		0-N1262	TB [DG]	
1.4 16V	10/99-12/07	AUA, BBY, BKY, AUB, BBZ, BUD	1390		0-N1263	TB [TE]	
1.4 16V	10/99-12/07	AUA, BBY, BKY, AUB, BBZ, BUD	1390		0-N158	TB [TE]	
1.4 16V	10/99-12/07	AUA, BBY	1390		0-N164	TB [DG]	
1.4 16V	10/99-12/07	BKY	1390	ch.→6Y-54421759, 6Y-5B050001	0-N164	TB [DG]	
1.4 16V	12/99-12/07	AUB	1390		0-N164	TB [DG]	
1.4 16V	12/99-12/07	BBZ	1390	ch.→6Y-54421759, 6Y-5B050001	0-N164	TB [DG]	
1.4 TDI	04/03-12/07	AMF, BNM, BNV	1422		0-N1045	TB [TE]	
1.4 TDI	04/03-12/07	AMF, BNM, BNV	1422		0-N1046	TB [DG]	
1.9 SDI	11/99-12/07	ASY	1896	:→021000	0-N107	TB [TE]	
1.9 SDI	11/99-12/07	ASY	1896	:021001→	0-N107	TB [TE]	
1.9 SDI	11/99-12/07	ASY	1896		0-N131	TB [DG]	
1.9 SDI	11/99-12/07	ASY	1896		0-N166	TB [DG]	
1.9 TDI	01/00-12/07	ATD, AXR	1896	ch.6Y-3-740480→	0-N1045	TB [TE]	
1.9 TDI	01/00-12/07	AXR	1896		0-N1046	TB [DG]	
1.9 TDI	01/00-12/07	ATD	1896	ch.6Y-3-740480→	0-N1046	TB [DG]	
1.9 TDI	01/00-12/07	ATD	1896	ch.→6Y-3-740479	0-N1048	TB [TE]	
1.9 TDI	01/00-12/07	ATD	1896	ch.→6Y-3-740479	0-N1268	TB [DG]	
1.9 TDI	01/00-12/07	ATD	1896	ch.→6Y-3-740479	0-N1274	TB [BT]	
2.0	12/99-12/07	AZL	1984		0-N157	TB [TE]	
1.0	11/00-08/02	AQV, ARV	996		0-N2066	VB [BT]	
1.0	11/00-08/02	AQV, ARV	996		0-N2067	VB [BT]	
1.2	07/01-12/07	AWY, BMD, AZQ, BME	1198		0-N1908	VB [BT]	S
1.2	07/01-12/07	AWY, BMD, AZQ, BME	1198		0-N1909	VB [DG]	
1.4	04/00-05/03	AME, AQW, ATZ, AZE, AZF	1397		0-N1956	VB [BT]	S
1.4	04/00-05/03	AME, AQW, ATZ, AZE, AZF	1397		0-N2066	VB [BT]	
1.4	04/00-05/03	AME, AQW, ATZ, AZE, AZF	1397		0-N2067	VB [BT]	

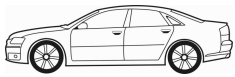

CM³



Art. Nr.



FABIA Stufenheck (6Y3)

1.4 16V	10/99-12/07	AUA, BBY, BKY, AUB, BBZ, BUD	1390	✳	0-N1445	VB [BT]	S
1.4 TDI	04/03-12/07	AMF, BNM, BNV	1422		0-N1704	VB [BT]	S
1.9 SDI, 1.9 TDI	11/99-12/07	BMS	1896		0-N1534	VB [BT]	S
1.9 SDI, 1.9 TDI	11/99-12/07	ASY, ATD, AXR	1896		0-N1536	VB [BT]	S
2.0	12/99-12/07	AZL	1984		0-N1041	VB [BT]	S

FABIA

1.2 TDI	05/10-12/14	CFWA	1199	25x160	SK-1695	BTK	
1.2 TDI	05/10-12/14	CFWA	1199	25x160; → 11/2010	SK-1695AQ1	BTKW	
1.2 TDI	05/10-12/14	CFWA	1199	25x160; → 11/2010	SK-1727AQ2	BTKW	
1.4	01/07-12/14	BXW, CGGB	1390	20x130; 17x58; beinhalten Rollen: 4	SK-1511	BTK	
1.4	01/07-12/14	BXW, CGGB	1390	20x130; 17x58; beinhalten Rollen: 4; Baumuster: Fabia	SK-1511AQ1	BTKW	
1.4	01/07-12/14	BXW, CGGB	1390	20x130; 17x58; beinhalten Rollen: 4; Baumuster: Fabia Scout	SK-1511AQ1	BTKW	
1.4 TDI	01/07-03/10	BMS, BNV, BNM	1422	30x120; mit Zubehör	SK-1372	BTK	
1.4 TDI	01/07-03/10	BMS, BNV, BNM	1422	30x120	SK-1372AQ1	BTKW	
1.6 TDI	03/10-12/14	CAYB, CAYC	1598	25x160	SK-1695	BTK	
1.6 TDI	03/10-12/14	CAYA, CAYB, CAYC	1598	25x160; → 11/2010; Baumuster: Fabia	SK-1695AQ1	BTKW	
1.6 TDI	03/10-12/14	CAYA, CAYB, CAYC	1598	25x160; → 11/2010; Baumuster: Fabia Scout	SK-1695AQ1	BTKW	
1.6 TDI	03/10-12/14	CAYC	1598	25x160; → 11/2010	SK-1727AQ2	BTKW	
1.6 TDI	04/10-12/14	CAYA	1598	25x160; → 11/2010	SK-1695	BTK	
1.6 TDI	04/10-12/14	CAYA	1598	25x160; 12/2010 →	SK-1727	BTK	
1.9 TDI	04/07-03/10	BLS, BSW	1896	30x120; mit Zubehör	SK-1372	BTK	
1.9 TDI	04/07-03/10	BLS, BSW	1896	30x120	SK-1372AQ1	BTKW	
1.2 TDI	05/10-12/14	CFWA	1199		0-N131	TB [DG]	
1.2 TDI	05/10-12/14	CFWA	1199		0-N2025	TB [DG]	
1.2 TDI	05/10-12/14	CFWA	1199		0-N2061	TB [TE]	
1.2 TDI	05/10-12/14	CFWA	1199		0-N2200	TB [DG]	
1.4	01/07-12/14	BXW, CGGB	1390		0-N1262	TB [DG]	
1.4	01/07-12/14	BXW, CGGB	1390		0-N1263	TB [TE]	
1.4	01/07-12/14	BXW, CGGB	1390		0-N158	TB [TE]	
1.4 TDI	01/07-03/10	BMS, BNV, BNM	1422		0-N1045	TB [TE]	
1.4 TDI	01/07-03/10	BMS, BNV, BNM	1422		0-N1046	TB [DG]	
1.6 TDI	03/10-12/14	CAYA, CAYB, CAYC	1598		0-N131	TB [DG]	
1.6 TDI	03/10-12/14	CAYA, CAYB, CAYC	1598		0-N2025	TB [DG]	
1.6 TDI	03/10-12/14	CAYA, CAYB, CAYC	1598		0-N2061	TB [TE]	
1.6 TDI	03/10-12/14	CAYA, CAYB, CAYC	1598		0-N2200	TB [DG]	
1.9 TDI	04/07-03/10	BLS, BSW	1896		0-N1045	TB [TE]	
1.9 TDI	04/07-03/10	BLS, BSW	1896		0-N1046	TB [DG]	
1.2 TDI	05/10-12/14	CFWA	1199		0-N1534	VB [BT]	S
1.2 TSI	03/10-12/14	CBZA	1197		0-N1733	VB [BT]	S
1.2 TSI	03/10-12/14	CBZB	1197	✳	0-N1733	VB [BT]	S
1.2 TSI	03/10-12/14	CBZA, CBZB	1197	✳	0-N2121	VB [DG]	
1.2, 1.2 12V	12/06-12/14	BBM, CHFA, BZG, CEVA, CGPA, CHTA, CGPB	1198		0-N1908	VB [BT]	S
1.2, 1.2 12V	12/06-12/14	BBM, CHFA, BZG, CEVA, CGPA, CHTA, CGPB	1198	✳	0-N1909	VB [DG]	
1.4	01/07-12/14	BXW, CGGB	1390	✳	0-N1445	VB [BT]	S
1.4 TDI	01/07-03/10	BMS	1422		0-N1534	VB [BT]	S
1.4 TDI	01/07-03/10	BNV	1422		0-N1704	VB [BT]	S
1.4 TDI	02/07-03/10	BNM	1422		0-N1704	VB [BT]	S
1.4 TSI	05/10-12/14	CAVE, CTHE	1390	✳	0-N2050	VB [DG]	
1.4 TSI	05/10-12/14	CAVE, CTHE	1390	✳	0-N2091	VB [BT]	S
1.4 TSI	05/10-12/14	CAVE, CTHE	1390		0-N2092	VB [BT]	S
1.4 TSI	05/10-12/14	CAVE, CTHE	1390	✳	0-N2111	VB [BT]	S
1.4 TSI	05/10-12/14	CAVE, CTHE	1390	Rippenanzahl: 6	0-N2133	VB [DG]	
1.6	04/07-12/14	BTS, CFNA	1598	✳; ✳	0-N1454	VB [DG]	
1.6	04/07-12/14	BTS, CFNA	1598	✳	0-N1525	VB [BT]	S
1.6	04/07-12/14	BTS, CFNA	1598	✳	0-N1733	VB [BT]	S
1.6 TDI	03/10-12/14	CAYA, CAYB, CAYC	1598		0-N1534	VB [BT]	S
1.9 TDI	04/07-03/10	BMS	1896		0-N1534	VB [BT]	S
1.9 TDI	04/07-03/10	BLS, BSW	1896		0-N1536	VB [BT]	S

FABIA Combi

1.2 TDI	05/10-12/14	CFWA	1199	25x160	SK-1695	BTK	
1.2 TDI	05/10-12/14	CFWA	1199	25x160; → 11/2010	SK-1695AQ1	BTKW	

CM³

Art. Nr.



FABIA Combi

1.2 TDI	05/10-12/14	CFWA	1199	25x160; → 11/2010	SK-1727AQ2	BTKW	
1.4	10/07-12/14	BXW, CGGB	1390	20x130; 17x58; beinhalten Rollen: 4	SK-1511	BTK	
1.4	10/07-12/14	BXW, CGGB	1390	20x130; 17x58; beinhalten Rollen: 4; Baumuster: Fabia	SK-1511AQ1	BTKW	
1.4	10/07-12/14	BXW, CGGB	1390	20x130; 17x58; beinhalten Rollen: 4; Baumuster: Fabia Scout	SK-1511AQ1	BTKW	
1.4 TDI	10/07-03/10	BMS, BNV, BNM	1422	30x120; mit Zubehör	SK-1372	BTK	
1.4 TDI	10/07-03/10	BMS, BNV, BNM	1422	30x120	SK-1372AQ1	BTKW	
1.6 TDI	03/10-12/14	CAYB, CAYC	1598	25x160	SK-1695	BTK	
1.6 TDI	03/10-12/14	CAYA, CAYB, CAYC	1598	25x160; → 11/2010; Baumuster: Fabia	SK-1695AQ1	BTKW	
1.6 TDI	03/10-12/14	CAYA, CAYB, CAYC	1598	25x160; → 11/2010; Baumuster: Fabia Scout	SK-1695AQ1	BTKW	
1.6 TDI	03/10-12/14	CAYC	1598	25x160; → 11/2010	SK-1727AQ2	BTKW	
1.6 TDI	04/10-12/14	CAYA	1598	25x160; → 11/2010	SK-1695	BTK	
1.6 TDI	04/10-12/14	CAYA	1598	25x160; 12/2010 →	SK-1727	BTK	
1.9 TDI	10/07-03/10	BLS, BSW	1896	30x120; mit Zubehör	SK-1372	BTK	
1.9 TDI	10/07-03/10	BLS, BSW	1896	30x120	SK-1372AQ1	BTKW	
1.2 TDI	05/10-12/14	CFWA	1199		0-N131	TB [DG]	
1.2 TDI	05/10-12/14	CFWA	1199		0-N2025	TB [DG]	
1.2 TDI	05/10-12/14	CFWA	1199		0-N2061	TB [TE]	
1.2 TDI	05/10-12/14	CFWA	1199		0-N2200	TB [DG]	
1.4	10/07-12/14	BXW, CGGB	1390		0-N1262	TB [DG]	
1.4	10/07-12/14	BXW, CGGB	1390		0-N1263	TB [TE]	
1.4	10/07-12/14	BXW, CGGB	1390		0-N158	TB [TE]	
1.4 TDI	10/07-03/10	BMS, BNV, BNM	1422		0-N1045	TB [TE]	
1.4 TDI	10/07-03/10	BMS, BNV, BNM	1422		0-N1046	TB [DG]	
1.6 TDI	03/10-12/14	CAYA, CAYB, CAYC	1598		0-N131	TB [DG]	
1.6 TDI	03/10-12/14	CAYA, CAYB, CAYC	1598		0-N2025	TB [DG]	
1.6 TDI	03/10-12/14	CAYA, CAYB, CAYC	1598		0-N2061	TB [TE]	
1.6 TDI	03/10-12/14	CAYA, CAYB, CAYC	1598		0-N2200	TB [DG]	
1.9 TDI	10/07-03/10	BLS, BSW	1896		0-N1045	TB [TE]	
1.9 TDI	10/07-03/10	BLS, BSW	1896		0-N1046	TB [DG]	
1.2 TDI	05/10-12/14	CFWA	1199		0-N1534	VB [BT]	S
1.2 TSI	03/10-12/14	CBZA, CBZB	1197		0-N1733	VB [BT]	S
1.2 TSI	03/10-12/14	CBZA, CBZB	1197	⊛	0-N2121	VB [DG]	
1.2, 1.2 12V	10/07-12/14	BBM, CHFA, BZG, CEVA, CGPA, CHTA, CGPB	1198		0-N1908	VB [BT]	S
1.2, 1.2 12V	10/07-12/14	BBM, CHFA, BZG, CEVA, CGPA, CHTA, CGPB	1198	⊛	0-N1909	VB [DG]	
1.4	10/07-12/14	BXW, CGGB	1390	⊛	0-N1445	VB [BT]	S
1.4 TDI	10/07-03/10	BMS	1422		0-N1534	VB [BT]	S
1.4 TDI	10/07-03/10	BNM	1422		0-N1704	VB [BT]	S
1.4 TDI	10/07-03/10	BNV	1422		0-N1704	VB [BT]	S
1.4 TSI	05/10-12/14	CAVE, CTHE	1390	⊛	0-N2050	VB [DG]	
1.4 TSI	05/10-12/14	CAVE, CTHE	1390	⊛	0-N2091	VB [BT]	S
1.4 TSI	05/10-12/14	CAVE, CTHE	1390		0-N2092	VB [BT]	S
1.4 TSI	05/10-12/14	CAVE, CTHE	1390	⊛	0-N2111	VB [BT]	S
1.4 TSI	05/10-12/14	CAVE, CTHE	1390	Rippenanzahl: 6	0-N2133	VB [DG]	
1.6	10/07-12/14	BTS, CFNA	1598	⊛; ⊛	0-N1454	VB [DG]	
1.6	10/07-12/14	BTS, CFNA	1598	⊛	0-N1525	VB [BT]	S
1.6	10/07-12/14	BTS, CFNA	1598	⊛	0-N1733	VB [BT]	S
1.6 TDI	03/10-12/14	CAYA, CAYB, CAYC	1598		0-N1534	VB [BT]	S
1.9 TDI	10/07-03/10	BMS	1896		0-N1534	VB [BT]	S
1.9 TDI	10/07-03/10	BLS, BSW	1896		0-N1536	VB [BT]	S

FAVORIT Pick-up (787)

1.3	12/92-06/97	135B	1289	01/1996 →	0-N1301	VB [TE]	
1.3	12/92-06/97	135B	1289	01/1996 →	0-N2064	VB [BT]	

FELICIA I (6U1)

1.6 LX	08/95-03/98	AEE	1598	19x137; mit Zubehör; Baumuster: 6U1	SK-1074	BTK	
1.6 LX	08/95-03/98	ALM	1598	19x137	SK-1074AQ1	BTKW	
1.9 D	10/95-03/98	AEF	1896	23x137; 08/1996 →; mit Zubehör	SK-1512	BTK	
1.6 LX	08/95-03/98	AEE, EA111	1598	02/1997 →	0-N106	TB [TE]	
1.9 D	10/95-03/98	AEF	1896		0-N111	TB [TE]	
1.3	10/94-03/98	135 L, AMJ, 135B, AMG, 136B, AMH	1289		0-N1301	VB [TE]	
1.3	10/94-03/98	135 L, AMJ, 135B, AMG, 136B, AMH	1289		0-N1675	VB [TE]	
1.3	10/94-03/98	135 L, AMJ, 135B, AMG, 136B, AMH	1289		0-N2064	VB [BT]	



CM³



Art. Nr.



ohne Halter

FELICIA I (6U1)							
1.6 LX	08/95-03/98	AEE, EA111	1598	☼	0-N1445	VB [BT]	S
1.9 D	10/95-03/98	AEF	1896		0-N1675	VB [TE]	
1.9 D	10/95-03/98	AEF	1896		0-N1920	VB [BT]	
1.9 D	10/95-03/98	AEF	1896	für Artikelnummer:0-N1920	0-N1925	VB [BT]	
FELICIA I Fun (797)							
1.6	06/97-04/02	AEE	1598	19x137; mit Zubehör	SK-1074	BTK	
1.6	06/97-04/02	ALM	1598	19x137	SK-1074AQ1	BTKW	
1.9 D	06/97-04/02	AEF	1896	23x137; mit Zubehör	SK-1512	BTK	
1.6	06/97-04/02	AEE	1598		0-N106	TB [TE]	
1.9 D	06/97-04/02	AEF	1896		0-N111	TB [TE]	
1.3	06/97-04/02	135B, 135M, AMG, 136B, 136M, AMH	1289		0-N1301	VB [TE]	
1.3	06/97-04/02	135B, 135M, AMG, 136B, 136M, AMH	1289		0-N1675	VB [TE]	
1.3	06/97-04/02	135B, 135M, AMG, 136B, 136M, AMH	1289		0-N2064	VB [BT]	
1.6	06/97-04/02	AEE	1598	☼	0-N1445	VB [BT]	S
1.9 D	06/97-04/02	AEF	1896		0-N1675	VB [TE]	
1.9 D	06/97-04/02	AEF	1896		0-N1920	VB [BT]	
1.9 D	06/97-04/02	AEF	1896	für Artikelnummer:0-N1920	0-N1925	VB [BT]	
FELICIA I Kombi (6U5)							
1.6 GLX	08/95-03/98	AEE	1598	19x137; mit Zubehör	SK-1074	BTK	
1.6 GLX	08/95-03/98	ALM	1598	19x137	SK-1074AQ1	BTKW	
1.9 D	10/95-03/98	AEF	1896	23x137; 08/1996 →; mit Zubehör	SK-1512	BTK	
1.6 GLX	08/95-03/98	AEE	1598	02/1997 →	0-N106	TB [TE]	
1.9 D	10/95-03/98	AEF	1896		0-N111	TB [TE]	
1.3, 1.3 LX, 1.3 LXI	08/95-03/98	135 L, AMJ, 135B, AMG, 136B, AMH	1289		0-N1301	VB [TE]	
1.3, 1.3 LX, 1.3 LXI	08/95-03/98	135 L, AMJ, 135B, AMG, 136B, AMH	1289		0-N1675	VB [TE]	
1.3, 1.3 LX, 1.3 LXI	08/95-03/98	135 L, AMJ, 135B, AMG, 136B, AMH	1289		0-N2064	VB [BT]	
1.6 GLX	08/95-03/98	AEE	1598	☼	0-N1445	VB [BT]	S
1.9 D	10/95-03/98	AEF	1896		0-N1675	VB [TE]	
1.9 D	10/95-03/98	AEF	1896		0-N1920	VB [BT]	
1.9 D	10/95-03/98	AEF	1896	für Artikelnummer:0-N1920	0-N1925	VB [BT]	
FELICIA II (6U1)							
1.6	01/98-06/01	AEE	1598	19x137; mit Zubehör; Baumuster: 6U1	SK-1074	BTK	
1.6	01/98-06/01	ALM	1598	19x137	SK-1074AQ1	BTKW	
1.9 D	01/98-06/01	AEF	1896	23x137; mit Zubehör	SK-1512	BTK	
1.6	01/98-06/01	AEE	1598		0-N106	TB [TE]	
1.9 D	01/98-06/01	AEF	1896		0-N111	TB [TE]	
1.3	01/98-06/01	AMG, AMH, AMJ	1289		0-N1301	VB [TE]	
1.3	01/98-06/01	AMG, AMH, AMJ	1289		0-N1675	VB [TE]	
1.3	01/98-06/01	AMG, AMH, AMJ	1289		0-N2064	VB [BT]	
1.6	01/98-06/01	AEE	1598	☼	0-N1445	VB [BT]	S
1.9 D	01/98-06/01	AEF	1896		0-N1675	VB [TE]	
1.9 D	01/98-06/01	AEF	1896		0-N1920	VB [BT]	
1.9 D	01/98-06/01	AEF	1896	für Artikelnummer:0-N1920	0-N1925	VB [BT]	
FELICIA II Kombi (6U5)							
1.6	01/98-06/01	AEE	1598	19x137; mit Zubehör	SK-1074	BTK	
1.6	01/98-06/01	ALM	1598	19x137	SK-1074AQ1	BTKW	
1.9 D	01/98-06/01	AEF	1896	23x137; mit Zubehör	SK-1512	BTK	
1.6	01/98-06/01	AEE	1598		0-N106	TB [TE]	
1.9 D	01/98-06/01	AEF	1896		0-N111	TB [TE]	
1.3	01/98-06/01	AMH	1289		0-N1301	VB [TE]	
1.3	01/98-06/01	AMH	1289		0-N1675	VB [TE]	
1.3	01/98-06/01	AMH	1289		0-N2064	VB [BT]	
1.6	01/98-06/01	AEE	1598	☼	0-N1445	VB [BT]	S
1.9 D	01/98-06/01	AEF	1896		0-N1675	VB [TE]	
1.9 D	01/98-06/01	AEF	1896		0-N1920	VB [BT]	
1.9 D	01/98-06/01	AEF	1896	für Artikelnummer:0-N1920	0-N1925	VB [BT]	
OCTAVIA (1U2)							
1.4 16V	09/00-12/10	AXP, BCA	1390	20x130; 17x58; beinhaltetete Rollen: 4	SK-1511	BTK	
1.4 16V	09/00-12/10	AXP, BCA	1390	20x130; 17x58; beinhaltetete Rollen: 4	SK-1511AQ1	BTKW	
1.6	09/96-09/04	AEE	1598	19x137; mit Zubehör; Baumuster: 1U2	SK-1074	BTK	
1.6	09/96-09/04	ALM	1598	19x137	SK-1074AQ1	BTKW	
1.6	02/97-12/07	AEH, AKL	1595	23x138; Baumuster: 1U2	SK-1109	BTK	
1.6	02/97-12/07	AEH, AKL	1595	23x138	SK-1109AQ1	BTKW	



CM³



Art. Nr.



OCTAVIA (1U2)

1.6	11/00-12/10	AVU, BFQ	1595	23x138; Baumuster: 1U2	SK-1109	BTK
1.6	11/00-12/10	AVU	1595	23x138	SK-1109AQ1	BTKW
1.8	09/96-07/00	AGN	1781	23x150; ch.→1U-Y-390000; mit Spanndämpfer, Spannrolle	SK-1337	BTK
1.8	09/96-07/00	AGN	1781	23x150; ch.→1U-Y-390000; mit Spanndämpfer, Spannrolle	SK-1337AQ1	BTKW
1.8	09/96-07/00	AGN	1781	23x150; ch.1U-Y-390001→	SK-1660	BTK
1.8	09/96-07/00	AGN	1781	23x150; ch.1U-Y-390001→	SK-1660AQ1	BTKW
1.8	09/96-07/00	AGN	1781	23x150; ch.→1U-Y-390000; 10/1996 →	SK-1709	BTK
1.8	09/96-07/00	AGN	1781	23x150; ch.1U-Y-390001→; 10/1996 →	SK-1710	BTK
1.8 T	08/97-12/10	AGU, ARZ	1781	23x150; ch.→1U-Y-390000; 01/2000 →; mit Spanndämpfer, Spannrolle	SK-1337	BTK
1.8 T	08/97-12/10	ARX, AUM	1781	23x150; 01/2000 →; mit Spanndämpfer, Spannrolle	SK-1337AQ1	BTKW
1.8 T	08/97-12/10	AGU, ARZ	1781	23x150; ch.→1U-Y-390000; 01/2000 →; mit Spanndämpfer, Spannrolle	SK-1337AQ1	BTKW
1.8 T	08/97-12/10	ARX, AUM	1781	23x150; 01/2000 →	SK-1660	BTK
1.8 T	08/97-12/10	AGU, ARZ	1781	23x150; ch.1U-Y-390001→; 01/2000 →	SK-1660	BTK
1.8 T	08/97-12/10	AGU, ARZ	1781	23x150; ch.1U-Y-390001→; 01/2000 →	SK-1660AQ1	BTKW
1.8 T	08/97-12/10	ARX, AUM	1781	23x150; ch.1U-Y-390001→; 01/2000 →	SK-1660AQ1	BTKW
1.8 T	08/97-12/10	AGU, ARZ	1781	23x150; ch.→1U-Y-390000; 01/2000 →	SK-1709	BTK
1.8 T	08/97-12/10	ARX, AUM	1781	23x150; 01/2000 →	SK-1710	BTK
1.8 T	08/97-12/10	AGU, ARZ	1781	23x150; ch.1U-Y-390001→; 01/2000 →	SK-1710	BTK
1.8 T 4x4	05/01-05/06	AGU	1781	23x150; ch.→1U-Y-390000; mit Spanndämpfer, Spannrolle	SK-1337	BTK
1.8 T 4x4, RS 1.8 T	05/01-05/06	ARX, AUQ	1781	23x150	SK-1660	BTK
1.8 T 4x4, RS 1.8 T	05/01-05/06	ARX, AUQ	1781	23x150	SK-1660AQ1	BTKW
1.8 T 4x4, RS 1.8 T	05/01-05/06	ARX, AUQ	1781	23x150	SK-1710	BTK
1.9 SDI	06/97-12/03	AGP, AQM	1896	25x141; :→AGP400000, AQM030000; mit Zubehör	SK-1110	BTK
1.9 SDI	06/97-12/03	AQM	1896	25x141; :AQM030001→; :→AQM045000; mit Zubehör	SK-1111	BTK
1.9 SDI	06/97-12/03	AGP, AQM	1896	25x141; 08/2000 →; :AQM030001→; :→AQM045000; mit Zubehör	SK-1111AQ1	BTKW
1.9 SDI	06/97-12/03	AGP, AQM	1896	25x141; :AGP400001, AQM045001→; mit Zubehör	SK-1258	BTK
1.9 SDI	06/97-12/03	AQM	1896	25x141; 08/2000 →; :AQM045001→; mit Zubehör	SK-1258AQ1	BTKW
1.9 SDI	06/97-12/03	AGP	1896	25x141; :AGP400001→; mit Zubehör	SK-1258AQ1	BTKW
1.9 SDI	06/97-12/03	AGP	1896	25x141; :→AGP400000	SK-1259	BTK
1.9 SDI	06/97-12/03	AQM	1896	25x141; :→AQM030000	SK-1259	BTK
1.9 TDI	09/96-03/10	AGR	1896	25x141; :→AGR044441; mit Zubehör	SK-1110	BTK
1.9 TDI	09/96-03/10	ALH	1896	25x141; :→ALH500000; mit Zubehör	SK-1111	BTK
1.9 TDI	09/96-03/10	AGR	1896	25x141; :AGR044442→; :→AGR565000; mit Zubehör	SK-1111	BTK
1.9 TDI	09/96-03/10	ALH	1896	25x141; :→ALH500000; mit Zubehör	SK-1111AQ1	BTKW
1.9 TDI	09/96-03/10	AGR	1896	25x141; :AGR044442→; :→AGR565000; mit Zubehör	SK-1111AQ1	BTKW
1.9 TDI	09/96-03/10	AGR, ALH	1896	25x141; :AGR565001, ALH500001→; mit Zubehör	SK-1258	BTK
1.9 TDI	09/96-03/10	AGR	1896	25x141; :AGR565001→; mit Zubehör	SK-1258AQ1	BTKW
1.9 TDI	09/96-03/10	ALH	1896	25x141; :ALH500001→; mit Zubehör	SK-1258AQ1	BTKW
1.9 TDI	09/96-03/10	AGR	1896	25x141; :→AGR044441	SK-1259	BTK
1.9 TDI	08/97-01/06	AHF	1896	25x141; :→AHF006065; mit Zubehör	SK-1110	BTK
1.9 TDI	08/97-01/06	ASV	1896	25x141; :→ASV150000; mit Zubehör	SK-1111	BTK
1.9 TDI	08/97-01/06	AHF	1896	25x141; :AHF006066→; :→AHF006065; mit Zubehör	SK-1111	BTK
1.9 TDI	08/97-01/06	ASV	1896	25x141; 08/2000 →; :→ASV150000; mit Zubehör	SK-1111AQ1	BTKW
1.9 TDI	08/97-01/06	AHF	1896	25x141; :AHF006066→; :→AHF595000; mit Zubehör	SK-1111AQ1	BTKW
1.9 TDI	08/97-01/06	AHF, ASV	1896	25x141; :AHF595001, ASV150001→; mit Zubehör	SK-1258	BTK
1.9 TDI	08/97-01/06	ASV	1896	25x141; 08/2000 →; :ASV150001→; mit Zubehör	SK-1258AQ1	BTKW
1.9 TDI	08/97-01/06	AHF	1896	25x141; :AHF595001→; mit Zubehör	SK-1258AQ1	BTKW
1.9 TDI	08/97-01/06	AHF	1896	25x141; :→AHF006065	SK-1259	BTK
1.9 TDI	09/02-12/10	ASZ, AXR	1896	30x120; mit Zubehör	SK-1372	BTK
1.9 TDI	09/02-12/10	ASZ, AXR	1896	30x120	SK-1372AQ2	BTKW
2.0	04/99-05/07	AEG, APK, AQY, AZJ	1984	23x138; Baumuster: 1U2	SK-1109	BTK

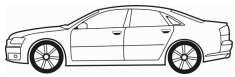

CM³



Art. Nr.



OCTAVIA (1U2)

2.0	04/99-05/07	AEG, APK, AQY, AZH, AZJ	1984	23x138; für OE: 06A121011T	SK-1109AQ2	BTKW	
1.4 16V	09/00-12/10	AXP, BCA	1390		0-N1262	TB [DG]	
1.4 16V	09/00-12/10	AXP, BCA	1390		0-N1263	TB [TE]	
1.4 16V	09/00-12/10	AXP, BCA	1390		0-N158	TB [TE]	
1.4 16V	09/00-12/10	AXP, BCA	1390		0-N164	TB [DG]	
1.6	09/96-09/04	AEE	1598		0-N106	TB [TE]	
1.6	02/97-12/10	AEH, AKL, AVU, BFQ	1595		0-N157	TB [TE]	
1.8	09/96-07/00	AGN	1781	ch.1U-Y-390001→; 10/1996 →	0-N1042	TB [TE]	
1.8	09/96-07/00	AGN	1781	ch.→1U-Y-390000; 10/1996 →	0-N1654	TB [TE]	
1.8 T	08/97-12/10	AGU, ARX, ARZ, AUM	1781	ch.1U-Y-390001→; 01/2000 →	0-N1042	TB [TE]	
1.8 T	08/97-12/10	AGU, ARX, ARZ, AUM	1781	ch.→1U-Y-390000; 01/2000 →	0-N1654	TB [TE]	
1.8 T 4x4, RS 1.8 T	05/01-05/06	ARX, AUQ	1781		0-N1042	TB [TE]	
1.8, 1.8 T, 1.8 T 4x4, RS 1.8 T	09/96-12/10	AGN, AGU, ARX, ARZ, AUM, ARX, AUQ	1781		0-N1237	TB [BT]	
1.8, 1.8 T, 1.8 T 4x4, RS 1.8 T	09/96-12/10	AGN, AGU, ARX, ARZ, AUM, ARX, AUQ	1781		0-N1316	TB [DG]	
1.9 SDI	06/97-12/03	AGP	1896	→ 12/2000; :→399999	0-N107	TB [TE]	
1.9 SDI	06/97-12/03	AGP	1896	→ 12/2000; :400000→	0-N107	TB [TE]	
1.9 SDI	06/97-12/03	AQM	1896	08/2000 → 08/2009	0-N107	TB [TE]	
1.9 SDI	06/97-12/03	AQM	1896		0-N167	TB [DG]	
1.9 SDI	06/97-12/03	AGP	1896	:400001→	0-N167	TB [DG]	
1.9 SDI, 1.9 TDI	09/96-03/10	AGP, AQM, AGR, ALH, AHF, ASV	1896		0-N131	TB [DG]	
1.9 SDI, 1.9 TDI	09/96-03/10	AGP, AQM, AGR, ALH, AHF, ASV	1896		0-N166	TB [DG]	
1.9 TDI	09/96-03/10	AGR	1896	→ 08/2009; :→044441	0-N107	TB [TE]	
1.9 TDI	09/96-03/10	AGR	1896	→ 08/2009; :044442→	0-N107	TB [TE]	
1.9 TDI	09/96-03/10	ALH	1896	08/2000 → 08/2009	0-N107	TB [TE]	
1.9 TDI	09/96-03/10	ALH	1896		0-N167	TB [DG]	
1.9 TDI	09/96-03/10	AGR	1896	:044442→	0-N167	TB [DG]	
1.9 TDI	08/97-01/06	ASV	1896	→ 08/2009	0-N107	TB [TE]	
1.9 TDI	08/97-01/06	AHF	1896	→ 08/2009; :→006065	0-N107	TB [TE]	
1.9 TDI	08/97-01/06	AHF	1896	→ 08/2009; :006066→	0-N107	TB [TE]	
1.9 TDI	08/97-01/06	ASV	1896		0-N167	TB [DG]	
1.9 TDI	08/97-01/06	AHF	1896	:006066→	0-N167	TB [DG]	
1.9 TDI	09/02-12/10	ASZ, AXR	1896		0-N1045	TB [TE]	
1.9 TDI	09/02-12/10	ASZ, AXR	1896		0-N1046	TB [DG]	
2.0	04/99-05/07	AEG, APK, AQY, AZH, AZJ	1984		0-N157	TB [TE]	
1.4	04/99-03/01	AMD	1397		0-N1675	VB [TE]	
1.4	04/99-03/01	AMD	1397		0-N2065	VB [TE]	S
1.4	04/99-03/01	AMD	1397		0-N2066	VB [BT]	
1.4 16V	09/00-12/10	AXP, BCA	1390	für Fahrzeuge mit Servolenkung	0-N1445	VB [BT]	S
1.4 16V	09/00-12/10	AXP, BCA	1390		0-N1539	VB [BT]	S
1.6	09/96-09/04	AEE	1598	für Fahrzeuge mit Servolenkung	0-N1445	VB [BT]	S
1.6	09/96-09/04	AEE	1598		0-N1539	VB [BT]	S
1.6	02/97-12/10	AEH, AKL, AVU, BFQ	1595		0-N1041	VB [BT]	S
1.8 T	08/97-12/10	ARX, ARZ	1781		0-N1041	VB [BT]	S
1.8 T 4x4	05/01-05/06	ARX	1781		0-N1041	VB [BT]	S
1.8, RS 1.8 T	09/96-01/06	AGN, AUQ	1781		0-N1041	VB [BT]	S
1.9 SDI	06/97-12/03	AGP, AQM	1896		0-N1606	VB [BT]	S
1.9 SDI, 1.9 TDI	09/96-03/10	AGP, AQM, AGR, ALH, AHF, ASV	1896		0-N174	VB [DG]	
1.9 TDI	09/96-03/10	ALH	1896		0-N1538	VB [BT]	S
1.9 TDI	09/96-03/10	AGR	1896	ch.1U-W-033908→	0-N1538	VB [BT]	S
1.9 TDI	09/96-03/10	AGR	1896	ch.→1U-W-033907	0-N1606	VB [BT]	S
1.9 TDI	08/97-01/06	AHF, ASV	1896		0-N1538	VB [BT]	S
1.9 TDI	09/02-09/04	ASZ	1896		0-N1494	VB [BT]	S
1.9 TDI	10/05-12/10	AXR	1896		0-N1531	VB [BT]	S
2.0	04/99-05/07	AEG, APK, AQY	1984		0-N1041	VB [BT]	S

OCTAVIA Combi (1U5)

1.4 16V	08/00-12/10	AXP, BCA	1390	20x130; 17x58; beinhaltetete Rollen: 4	SK-1511	BTK	
1.4 16V	08/00-12/10	AXP, BCA	1390	20x130; 17x58; beinhaltetete Rollen: 4	SK-1511AQ1	BTKW	
1.6	07/98-09/04	AEE	1598	19x137; 08/2000 →; mit Zubehör; Baumuster: 1U5	SK-1074	BTK	
1.6	07/98-09/04	ALM	1598	19x137	SK-1074AQ1	BTKW	
1.6	07/98-12/07	AEH, AKL	1595	23x138; Baumuster: 1U5	SK-1109	BTK	
1.6	07/98-12/07	AEH, AKL	1595	23x138	SK-1109AQ1	BTKW	
1.6	09/00-12/10	AVU, BFQ	1595	23x138; Baumuster: 1U5	SK-1109	BTK	
1.6	09/00-12/10	AVU	1595	23x138	SK-1109AQ1	BTKW	



CM³



Art. Nr.



OCTAVIA Combi (1U5)

1.8 20V	07/98-07/00	AGN	1781	23x150; ch.→1U-Y-390000; mit Spanndämpfer, Spannrolle	SK-1337	BTK
1.8 20V	07/98-07/00	AGN	1781	23x150; ch.→1U-Y-390000; mit Spanndämpfer, Spannrolle	SK-1337AQ1	BTKW
1.8 20V	07/98-07/00	AGN	1781	23x150; ch.1U-Y-390001→	SK-1660	BTK
1.8 20V	07/98-07/00	AGN	1781	23x150; ch.1U-Y-390001→	SK-1660AQ1	BTKW
1.8 20V	07/98-07/00	AGN	1781	23x150; ch.→1U-Y-390000	SK-1709	BTK
1.8 20V	07/98-07/00	AGN	1781	23x150; ch.1U-Y-390001→	SK-1710	BTK
1.8 T	07/98-12/10	AGU, ARZ	1781	23x150; ch.→1U-Y-390000; mit Spanndämpfer, Spannrolle	SK-1337	BTK
1.8 T	07/98-12/10	AGU, ARZ	1781	23x150; ch.→1U-Y-390000; mit Spanndämpfer, Spannrolle	SK-1337AQ1	BTKW
1.8 T	07/98-12/10	ARX, AUM	1781	23x150; mit Spanndämpfer, Spannrolle	SK-1337AQ1	BTKW
1.8 T	07/98-12/10	ARX, AUM	1781	23x150	SK-1660	BTK
1.8 T	07/98-12/10	AGU, ARZ	1781	23x150; ch.1U-Y-390001→	SK-1660	BTK
1.8 T	07/98-12/10	AGU, ARZ	1781	23x150; ch.1U-Y-390001→	SK-1660AQ1	BTKW
1.8 T	07/98-12/10	ARX, AUM	1781	23x150; ch.1U-Y-390001→	SK-1660AQ1	BTKW
1.8 T	07/98-12/10	AGU, ARZ	1781	23x150; ch.→1U-Y-390000	SK-1709	BTK
1.8 T	07/98-12/10	ARX, AUM	1781	23x150	SK-1710	BTK
1.8 T	07/98-12/10	AGU, ARZ	1781	23x150; ch.1U-Y-390001→	SK-1710	BTK
1.8 T 4x4	05/01-05/06	AGU	1781	23x150; ch.→1U-Y-390000; mit Spanndämpfer, Spannrolle	SK-1337	BTK
1.8 T 4x4, RS 1.8 T	05/01-05/06	ARX, AUQ	1781	23x150	SK-1660	BTK
1.8 T 4x4, RS 1.8 T	05/01-05/06	ARX, AUQ	1781	23x150	SK-1660AQ1	BTKW
1.8 T 4x4, RS 1.8 T	05/01-05/06	ARX, AUQ	1781	23x150	SK-1710	BTK
1.9 SDI	07/98-12/03	AGP, AQM	1896	25x141; :→AGP400000, AQM030000; mit Zubehör	SK-1110	BTK
1.9 SDI	07/98-12/03	AQM	1896	25x141; :AQM030001→; :→AQM045000; mit Zubehör	SK-1111	BTK
1.9 SDI	07/98-12/03	AGP, AQM	1896	25x141; 08/2000 →; :AQM030001→; :→AQM045000; mit Zubehör	SK-1111AQ1	BTKW
1.9 SDI	07/98-12/03	AGP, AQM	1896	25x141; :AGP400001, AQM045001→; mit Zubehör	SK-1258	BTK
1.9 SDI	07/98-12/03	AQM	1896	25x141; 08/2000 →; :AQM045001→; mit Zubehör	SK-1258AQ1	BTKW
1.9 SDI	07/98-12/03	AGP	1896	25x141; :AGP400001→; mit Zubehör	SK-1258AQ1	BTKW
1.9 SDI	07/98-12/03	AGP	1896	25x141; :→AGP400000	SK-1259	BTK
1.9 SDI	07/98-12/03	AQM	1896	25x141; :→AQM030000	SK-1259	BTK
1.9 TDI	07/98-01/06	AHF	1896	25x141; 01/1999 →; :→AHF006065; mit Zubehör	SK-1110	BTK
1.9 TDI	07/98-03/10	AGR	1896	25x141; :→AGR044441; mit Zubehör	SK-1110	BTK
1.9 TDI	07/98-01/06	ASV	1896	25x141; :→ASV150000; mit Zubehör	SK-1111	BTK
1.9 TDI	07/98-01/06	AHF	1896	25x141; :AHF006066→; :→AHF006065; mit Zubehör	SK-1111	BTK
1.9 TDI	07/98-03/10	ALH	1896	25x141; :→ALH500000; mit Zubehör	SK-1111	BTK
1.9 TDI	07/98-03/10	AGR	1896	25x141; :AGR044442→; :→AGR565000; mit Zubehör	SK-1111	BTK
1.9 TDI	07/98-01/06	ASV	1896	25x141; 08/2000 →; :→ASV150000; mit Zubehör	SK-1111AQ1	BTKW
1.9 TDI	07/98-01/06	AHF	1896	25x141; :AHF006066→; :→AHF595000; mit Zubehör	SK-1111AQ1	BTKW
1.9 TDI	07/98-03/10	ALH	1896	25x141; :→ALH500000; mit Zubehör	SK-1111AQ1	BTKW
1.9 TDI	07/98-03/10	AGR	1896	25x141; :AGR044442→; :→AGR565000; mit Zubehör	SK-1111AQ1	BTKW
1.9 TDI	07/98-01/06	AHF	1896	25x141; :AHF595001→; mit Zubehör	SK-1258	BTK
1.9 TDI	07/98-01/06	ASV	1896	25x141; :ASV150001→; mit Zubehör	SK-1258	BTK
1.9 TDI	07/98-03/10	AGR, ALH	1896	25x141; :AGR565001, ALH500001→; mit Zubehör	SK-1258	BTK
1.9 TDI	07/98-01/06	ASV	1896	25x141; 08/2000 →; :ASV150001→; mit Zubehör	SK-1258AQ1	BTKW
1.9 TDI	07/98-01/06	AHF	1896	25x141; :AHF595001→; mit Zubehör	SK-1258AQ1	BTKW
1.9 TDI	07/98-03/10	AGR	1896	25x141; :AGR565001→; mit Zubehör	SK-1258AQ1	BTKW
1.9 TDI	07/98-03/10	ALH	1896	25x141; :ALH500001→; mit Zubehör	SK-1258AQ1	BTKW
1.9 TDI	07/98-01/06	AHF	1896	25x141; :→AHF006065	SK-1259	BTK
1.9 TDI	07/98-03/10	AGR	1896	25x141; :→AGR044441	SK-1259	BTK
1.9 TDI	08/00-12/10	ATD, AXR	1896	30x120; ch.1U-2A006981, 1U-32704907, 1U-38677466→; mit Zubehör	SK-1372	BTK
1.9 TDI	08/00-12/10	ASZ, AXR, AXR	1896	30x120	SK-1372AQ2	BTKW
1.9 TDI	08/00-12/10	ATD	1896	30x120; ch.→1U-2A006980, 1U-32704906, 1U-38677465; mit Zubehör	SK-1582	BTK



CM³



Art. Nr.



ohne Halter

OCTAVIA Combi (1U5)

1.9 TDI	08/00-12/10	ATD	1896	30x120; ch.→1U-2A006980, 1U-32704906, 1U-38677465; mit Spanndämpfer, Spannrolle; mit Zubehör	SK-1583	BTK
1.9 TDI	09/02-09/04	ASZ	1896	30x120; mit Zubehör	SK-1372	BTK
1.9 TDI 4x4	11/99-02/06	AGR	1896	25x141; →AGR044441; mit Zubehör	SK-1110	BTK
1.9 TDI 4x4	11/99-02/06	AGR	1896	25x141; →AGR044442→; →AGR565000; mit Zubehör	SK-1111	BTK
1.9 TDI 4x4	11/99-02/06	AGR	1896	25x141; →ALH500000; mit Zubehör	SK-1111AQ1	BTKW
1.9 TDI 4x4	11/99-02/06	AGR	1896	25x141; →AGR044442→; →AGR565000; mit Zubehör	SK-1111AQ1	BTKW
1.9 TDI 4x4	11/99-02/06	AGR	1896	25x141; →AGR565001→; mit Zubehör	SK-1258	BTK
1.9 TDI 4x4	11/99-02/06	AGR	1896	25x141; →AGR565001→; mit Zubehör	SK-1258AQ1	BTKW
1.9 TDI 4x4	11/99-02/06	AGR	1896	25x141; →ALH500001→; mit Zubehör	SK-1258AQ1	BTKW
1.9 TDI 4x4	11/99-02/06	AGR	1896	25x141; →AGR044441	SK-1259	BTK
1.9 TDI 4x4	09/00-01/06	ATD	1896	30x120; ch.1U-2A006981, 1U-32704907, 1U-38677466→; mit Zubehör	SK-1372	BTK
1.9 TDI 4x4	09/00-01/06	ATD	1896	30x120; →ATD211246→	SK-1372AQ2	BTKW
1.9 TDI 4x4	09/00-01/06	ATD	1896	30x120; →ATD211245; mit Zubehör; Baumuster: 1U5	SK-1582	BTK
1.9 TDI 4x4	09/00-01/06	ATD	1896	30x120; →ATD211245; ohne Spanndämpfer, Spannrolle; mit Zubehör	SK-1582AQ1	BTKW
1.9 TDI 4x4	09/00-01/06	ATD	1896	30x120; →ATD211245; mit Spanndämpfer, Spannrolle; mit Zubehör; Baumuster: 1U5	SK-1583	BTK
1.9 TDI 4x4	09/00-01/06	ATD	1896	30x120; →ATD211245; mit Spanndämpfer, Spannrolle; mit Zubehör	SK-1583AQ1	BTKW
2.0	04/99-05/07	AEG, APK, AQY, AZJ	1984	23x138; Baumuster: 1U5	SK-1109	BTK
2.0 4x4	01/00-12/10	ATF	1984	23x138	SK-1109	BTK
2.0 4x4	01/00-12/10	ATF	1984	23x138	SK-1109AQ2	BTKW
2.0 4x4	08/00-09/04	AZH, AZJ	1984	23x138; Baumuster: 1U5	SK-1109	BTK
2.0, 2.0 4x4	04/99-05/07	AEG, APK, AQY, AZH, AZJ, AZH, AZJ	1984	23x138; für OE: 06A121011T	SK-1109AQ2	BTKW
1.4 16V	08/00-12/10	AXP, BCA	1390		0-N1262	TB [DG]
1.4 16V	08/00-12/10	AXP, BCA	1390		0-N1263	TB [TE]
1.4 16V	08/00-12/10	AXP, BCA	1390		0-N158	TB [TE]
1.4 16V	08/00-12/10	AXP, BCA	1390		0-N164	TB [DG]
1.6	07/98-09/04	AEE	1598		0-N106	TB [TE]
1.6	07/98-12/10	AEH, AKL, AVU, BFQ	1595		0-N157	TB [TE]
1.8 20V, 1.8 T	07/98-12/10	AGN, AGU, ARX, ARZ, AUM	1781	ch.1U-Y-390001→	0-N1042	TB [TE]
1.8 20V, 1.8 T	07/98-12/10	AGN, AGU, ARX, ARZ, AUM	1781	ch.→1U-Y-390000	0-N1654	TB [TE]
1.8 20V, 1.8 T, 1.8 T 4x4, RS 1.8 T	07/98-12/10	AGN, AGU, ARX, ARZ, AUM, ARX, AUQ	1781		0-N1237	TB [BT]
1.8 20V, 1.8 T, 1.8 T 4x4, RS 1.8 T	07/98-12/10	AGN, AGU, ARX, ARZ, AUM, ARX, AUQ	1781		0-N1316	TB [DG]
1.8 T 4x4, RS 1.8 T	05/01-05/06	ARX, AUQ	1781		0-N1042	TB [TE]
1.9 SDI	07/98-12/03	AGP	1896	→ 12/2000; →399999	0-N107	TB [TE]
1.9 SDI	07/98-12/03	AGP	1896	→ 12/2000; →400000→	0-N107	TB [TE]
1.9 SDI	07/98-12/03	AQM	1896	08/2000 → 08/2009	0-N107	TB [TE]
1.9 SDI	07/98-12/03	AQM	1896		0-N167	TB [DG]
1.9 SDI	07/98-12/03	AGP	1896	→400001→	0-N167	TB [DG]
1.9 SDI, 1.9 TDI, 1.9 TDI 4x4	07/98-03/10	AGP, AQM, AGR, AGR, ALH, AHF, ASV	1896		0-N131	TB [DG]
1.9 SDI, 1.9 TDI, 1.9 TDI 4x4	07/98-03/10	AGP, AQM, AGR, AGR, ALH, AHF, ASV	1896		0-N166	TB [DG]
1.9 TDI	07/98-01/06	ASV	1896	→ 08/2009	0-N107	TB [TE]
1.9 TDI	07/98-01/06	AHF	1896	→ 08/2009; →006065	0-N107	TB [TE]
1.9 TDI	07/98-01/06	AHF	1896	→ 08/2009; →006066→	0-N107	TB [TE]
1.9 TDI	07/98-03/10	AGR	1896	→ 08/2009; →044441	0-N107	TB [TE]
1.9 TDI	07/98-03/10	AGR	1896	→ 08/2009; →044442→	0-N107	TB [TE]
1.9 TDI	07/98-03/10	ALH	1896	08/2000 → 08/2009	0-N107	TB [TE]
1.9 TDI	07/98-01/06	ASV	1896		0-N167	TB [DG]
1.9 TDI	07/98-01/06	AHF	1896	→006066→	0-N167	TB [DG]
1.9 TDI	07/98-03/10	ALH	1896		0-N167	TB [DG]
1.9 TDI	07/98-03/10	AGR	1896	→044442→	0-N167	TB [DG]
1.9 TDI	08/00-12/10	AXR, AXR	1896	09/2002 →	0-N1046	TB [DG]
1.9 TDI	08/00-12/10	ATD	1896	→ 09/2002	0-N1048	TB [TE]
1.9 TDI	08/00-12/10	ATD	1896	→ 09/2002	0-N1268	TB [DG]
1.9 TDI	08/00-12/10	ATD	1896	→ 09/2002	0-N1274	TB [BT]
1.9 TDI	09/02-09/04	ASZ	1896		0-N1045	TB [TE]
1.9 TDI	09/02-09/04	ASZ	1896		0-N1046	TB [DG]
1.9 TDI 4x4	11/99-02/06	AGR	1896	→044441	0-N107	TB [TE]
1.9 TDI 4x4	11/99-02/06	AGR	1896	→044442→	0-N107	TB [TE]
1.9 TDI 4x4	11/99-02/06	AGR	1896	→044442→	0-N167	TB [DG]

CM³

Art. Nr.



OCTAVIA Combi (1U5)

1.9 TDI 4x4	09/00-01/06	ATD	1896	:211246→	0-N1045	TB [TE]	
1.9 TDI 4x4	09/00-01/06	ATD	1896	:211246→	0-N1046	TB [DG]	
1.9 TDI 4x4	09/00-01/06	ATD	1896	:→211245	0-N1048	TB [TE]	
1.9 TDI 4x4	09/00-01/06	ATD	1896	:→211245	0-N1268	TB [DG]	
1.9 TDI 4x4	09/00-01/06	ATD	1896	:→211245	0-N1274	TB [BT]	
2.0, 2.0 4x4	04/99-12/10	AEG, APK, AQY, AZH, AZJ, ATF, AZH, AZJ	1984		0-N157	TB [TE]	
1.4 16V	08/00-12/10	AXP, BCA	1390	für Fahrzeuge mit Servolenkung	0-N1445	VB [BT]	S
1.4 16V	08/00-12/10	AXP, BCA	1390		0-N1539	VB [BT]	S
1.6	07/98-12/10	AEH, AKL, AVU, BFQ	1595		0-N1041	VB [BT]	S
1.6	07/98-09/04	AEE	1598	für Fahrzeuge mit Servolenkung	0-N1445	VB [BT]	S
1.6	07/98-09/04	AEE	1598		0-N1539	VB [BT]	S
1.8 20V, RS 1.8 T	07/98-01/06	AGN, AUQ	1781		0-N1041	VB [BT]	S
1.8 T	07/98-12/10	ARZ, AUM	1781		0-N1041	VB [BT]	S
1.8 T 4x4	05/01-05/06	ARX	1781		0-N1041	VB [BT]	S
1.9 SDI	07/98-12/03	AGP, AQM	1896		0-N1606	VB [BT]	S
1.9 SDI, 1.9 TDI, 1.9 TDI 4x4	07/98-03/10	AGP, AQM, AGR, AGR, ALH, AHF, ASV	1896		0-N174	VB [DG]	
1.9 TDI	07/98-01/06	AHF, ASV	1896		0-N1538	VB [BT]	S
1.9 TDI	07/98-03/10	ALH	1896		0-N1538	VB [BT]	S
1.9 TDI	07/98-03/10	AGR	1896	ch.1U-W-033908→	0-N1538	VB [BT]	S
1.9 TDI	07/98-03/10	AGR	1896	ch.→1U-W-033907	0-N1606	VB [BT]	S
1.9 TDI 4x4	11/99-02/06	AGR	1896	ch.1U-W-033908→	0-N1538	VB [BT]	S
1.9 TDI 4x4	11/99-02/06	AGR	1896	ch.→1U-W-033907	0-N1606	VB [BT]	S
1.9 TDI, 1.9 TDI 4x4	09/00-01/06	ASZ, ATD	1896		0-N1494	VB [BT]	S
2.0	04/99-05/07	AEG, APK, AQY, AZJ	1984		0-N1041	VB [BT]	S
2.0 4x4	08/00-09/04	AZH	1984		0-N1041	VB [BT]	S

OCTAVIA (1Z3)

1.4	05/04-04/13	BCA, BUD, CGGA	1390	20x130; 17x58; beinhaltetete Rollen: 4	SK-1511	BTK	
1.4	05/04-05/06	BCA	1390	20x130; 17x58; beinhaltetete Rollen: 4	SK-1511AQ1	BTKW	
1.4	06/04-04/13	BUD, CGGA	1390	20x130; 17x58; ch.1Z-9-000001→; beinhaltetete Rollen: 4	SK-1511AQ1	BTKW	
1.6	06/04-06/13	BGU, BSE, BSF, CMXA	1595	23x138; Baumuster: 1Z3	SK-1109	BTK	
1.6 LPG	08/09-11/12	CHGA	1595	23x138; Baumuster: 1Z3	SK-1109	BTK	
1.6 MultiFuel	01/08-06/13	CCSA	1595	23x138; Baumuster: 1Z3	SK-1109	BTK	
1.6 TDI	06/09-04/13	CAYC	1598	25x160; → 11/2010	SK-1695	BTK	
1.6 TDI	06/09-04/13	CAYC	1598	25x160; → 11/2010	SK-1695AQ1	BTKW	
1.6 TDI	06/09-04/13	CAYC	1598	25x160; 12/2010 →	SK-1727	BTK	
1.6 TDI	06/09-04/13	CAYC	1598	25x160; → 11/2010	SK-1727AQ2	BTKW	
1.6, 1.6 LPG, 1.6 MultiFuel	06/04-06/13	BGU, BSE, BSF, CCSA, CMXA, CCSA, CMXA, CHGA	1595	23x138	SK-1109AQ1	BTKW	
1.9 TDI	06/04-12/10	BJB, BKC, BLS, BXE	1896	30x120; mit Zubehör	SK-1372	BTK	
1.9 TDI	06/04-12/10	BJB, BKC, BLS, BXE	1896	30x120	SK-1372AQ1	BTKW	
2.0 FSI	11/04-10/08	BLR, BLY, BVY, BVZ	1984	23x148	SK-1724	BTK	
2.0 FSI	11/04-10/08	BLR, BLY, BVY, BVZ	1984	23x148	SK-1724AQ2	BTKW	
2.0 RS	10/05-02/13	BWA	1984	23x148	SK-1724	BTK	
2.0 RS	10/05-02/13	BWA	1984	23x148	SK-1724AQ1	BTKW	
2.0 TDI	02/04-05/10	AZV	1968	30x141; ch.→1K-6-250000; mit Zubehör	SK-1595	BTK	
2.0 TDI	02/04-05/10	AZV	1968	30x141; → 05/2006; mit Zubehör	SK-1595AQ1	BTKW	
2.0 TDI	02/04-05/10	AZV	1968	30x141; ch.1K-7-000001→; mit Zubehör	SK-1668	BTK	
2.0 TDI	02/04-05/10	AZV	1968	30x141; 06/2006 →	SK-1668AQ1	BTKW	
2.0 TDI	11/05-05/10	BMM	1968	30x120; mit Zubehör	SK-1372	BTK	
2.0 TDI	11/05-05/10	BMM	1968	30x120	SK-1372AQ2	BTKW	
2.0 TDI	03/10-06/13	CFHF, CLCA	1968	30x160	SK-1694	BTK	
2.0 TDI	03/10-06/13	CFHF, CLCA	1968	25x160; → 11/2010	SK-1695AQ1	BTKW	
2.0 TDI	03/10-06/13	CFHF, CLCA	1968	25x160; 12/2010 →	SK-1727	BTK	
2.0 TDI	03/10-06/13	CFHF, CLCA	1968	25x160; → 11/2010	SK-1727AQ2	BTKW	
2.0 TDI 16V	02/04-04/13	BKD	1968	30x141; ch.→1K-6-250000; mit Zubehör	SK-1595	BTK	
2.0 TDI 16V	02/04-04/13	BKD	1968	30x141; ch.→1Z-6-250000; mit Zubehör	SK-1595AQ1	BTKW	
2.0 TDI 16V	02/04-04/13	BKD	1968	30x141; ch.1K-7-000001→; mit Zubehör	SK-1668	BTK	
2.0 TDI 16V	02/04-04/13	BKD	1968	30x141; ch.1Z-7-000001→	SK-1668AQ1	BTKW	
2.0 TDI 16V	02/04-04/13	CFHC, CLCB	1968	30x160	SK-1694	BTK	
2.0 TDI 16V	02/04-04/13	CFHC, CLCB	1968	25x160; → 11/2010	SK-1695AQ1	BTKW	
2.0 TDI 16V	02/04-04/13	CFHC, CLCB	1968	25x160; 11/2010 →	SK-1727	BTK	
2.0 TDI 16V	02/04-04/13	CFHC, CLCB	1968	25x160; → 11/2010	SK-1727AQ2	BTKW	
2.0 TDI RS	04/06-02/13	BMN	1968	30x141; mit Zubehör	SK-1668	BTK	
2.0 TDI RS	04/06-02/13	BMN	1968	30x141	SK-1668AQ1	BTKW	

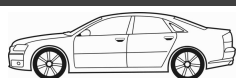

CM³



Art. Nr.



OCTAVIA (1Z3)

2.0 TDI RS	04/06-02/13	CEGA	1968	30x160; → 11/2010	SK-1694	BTK	
2.0 TDI RS	04/06-02/13	CEGA	1968	30x160	SK-1694AQ2	BTKW	
2.0 TDI, 2.0 TDI 16V	02/04-06/13	BKD, CFHC, CLCB, CFHF, CLCA	1968	25x160; → 11/2010	SK-1695	BTK	
1.4	05/04-04/13	BCA, BUD, CGGA	1390		0-N1262	TB [DG]	
1.4	05/04-04/13	BCA, BUD, CGGA	1390		0-N1263	TB [TE]	
1.4	05/04-04/13	BCA, BUD, CGGA	1390		0-N158	TB [TE]	
1.4	05/04-05/06	BCA	1390		0-N164	TB [DG]	
1.6 TDI	06/09-04/13	CAYC	1598		0-N131	TB [DG]	
1.6 TDI	06/09-04/13	CAYC	1598		0-N2025	TB [DG]	
1.6 TDI	06/09-04/13	CAYC	1598		0-N2061	TB [TE]	
1.6 TDI	06/09-04/13	CAYC	1598		0-N2200	TB [DG]	
1.6, 1.6 LPG, 1.6 MultiFuel	06/04-06/13	BGU, BSE, BSF, CCSA, CMXA, CCSA, CMXA, CHGA	1595		0-N157	TB [TE]	
1.9 TDI	06/04-12/10	BJB, BKC, BLS, BXE	1896		0-N1045	TB [TE]	
1.9 TDI	06/04-12/10	BJB, BKC, BLS, BXE	1896		0-N1046	TB [DG]	
2.0 FSI	11/04-10/08	BLR, BLY, BVY, BVZ	1984		0-N1316	TB [DG]	
2.0 FSI	11/04-10/08	BLR, BLY, BVY, BVZ	1984		0-N1346	TB [DG]	
2.0 FSI, 2.0 RS	11/04-02/13	BLR, BLY, BVY, BVZ, BWA, CCZA	1984		0-N2208	TB [TE]	
2.0 RS	10/05-02/13	BWA	1984		0-N1316	TB [DG]	
2.0 RS	10/05-02/13	BWA	1984		0-N1346	TB [DG]	
2.0 TDI	02/04-05/10	AZV, BMM	1968		0-N1046	TB [DG]	
2.0 TDI	02/04-05/10	AZV	1968		0-N1335	TB [TE]	
2.0 TDI	02/04-05/10	AZV	1968	→ 05/2006	0-N1336	TB [DG]	
2.0 TDI	02/04-05/10	AZV	1968	05/2006 →	0-N1575	TB [DG]	
2.0 TDI	11/05-05/10	BMM	1968		0-N1045	TB [TE]	
2.0 TDI	03/10-06/13	CFHF, CLCA	1968		0-N131	TB [DG]	
2.0 TDI	03/10-06/13	CFHF, CLCA	1968		0-N2025	TB [DG]	
2.0 TDI	03/10-06/13	CFHF, CLCA	1968		0-N2061	TB [TE]	
2.0 TDI	03/10-06/13	CFHF, CLCA	1968		0-N2200	TB [DG]	
2.0 TDI 16V	02/04-04/13	BKD	1968		0-N1046	TB [DG]	
2.0 TDI 16V	02/04-04/13	CFHC, CLCB	1968	→ 11/2010	0-N1046	TB [DG]	
2.0 TDI 16V	02/04-04/13	CFHC, CLCB	1968		0-N131	TB [DG]	
2.0 TDI 16V	02/04-04/13	BKD	1968		0-N1335	TB [TE]	
2.0 TDI 16V	02/04-04/13	BKD	1968	→ 05/2006	0-N1336	TB [DG]	
2.0 TDI 16V	02/04-04/13	BKD	1968	05/2006 →	0-N1575	TB [DG]	
2.0 TDI 16V	02/04-04/13	CFHC, CLCB	1968		0-N2025	TB [DG]	
2.0 TDI 16V	02/04-04/13	CFHC, CLCB	1968		0-N2061	TB [TE]	
2.0 TDI 16V	02/04-04/13	CFHC, CLCB	1968		0-N2200	TB [DG]	
2.0 TDI RS	04/06-02/13	BMN, CEGA	1968		0-N1046	TB [DG]	
2.0 TDI RS	04/06-02/13	CEGA	1968		0-N1268	TB [DG]	
2.0 TDI RS	04/06-02/13	BMN	1968		0-N1335	TB [TE]	
2.0 TDI RS	04/06-02/13	CEGA	1968		0-N1336	TB [DG]	
2.0 TDI RS	04/06-02/13	BMN	1968		0-N1575	TB [DG]	
2.0 TDI RS	04/06-02/13	CEGA	1968		0-N1905	TB [BT]	
1.2 TSI	02/10-06/13	CBZB	1197		0-N1733	VB [BT]	S
1.2 TSI	02/10-06/13	CBZB	1197	☼	0-N2121	VB [DG]	
1.4	05/04-05/06	BCA	1390	☼, für Fahrzeuge mit Servolenkung	0-N1445	VB [BT]	S
1.4	06/04-04/13	BUD, CGGA	1390	☼	0-N1445	VB [BT]	S
1.4 TSI	11/08-06/13	CAXA	1390	☼; ☼	0-N1454	VB [DG]	
1.4 TSI	11/08-06/13	CAXA	1390	☼	0-N1525	VB [BT]	S
1.4 TSI	11/08-06/13	CAXA	1390	☼	0-N1733	VB [BT]	S
1.6 FSI	02/04-10/08	BLF	1598	☼; ☼	0-N1454	VB [DG]	
1.6 FSI	02/04-10/08	BLF	1598	☼	0-N1525	VB [BT]	S
1.6 FSI	02/04-10/08	BLF	1598	☼	0-N1733	VB [BT]	S
1.6 TDI	06/09-04/13	CAYC	1598		0-N1534	VB [BT]	S
1.8 TSI	06/07-06/13	BZB, CDAA, CDAB	1798		0-N1832	VB [BT]	S
1.9 TDI	06/04-12/10	BJB, BKC	1896	ch.→1Z-5-121646, 1Z-58052421	0-N1530	VB [BT]	S
1.9 TDI	06/04-12/10	BLS, BXE	1896		0-N1531	VB [BT]	S
1.9 TDI	06/04-12/10	BJB, BKC	1896	ch.1Z-5-121647, 1Z-58052422→	0-N1531	VB [BT]	S
2.0 RS	10/05-02/13	BWA	1984	ch.1Z-4-000001→	0-N1656	VB [BT]	S
2.0 TDI	02/04-05/10	AZV	1968		0-N1530	VB [BT]	S
2.0 TDI	11/05-05/10	BMM	1968		0-N1531	VB [BT]	S
2.0 TDI	03/10-06/13	CFHF, CLCA	1968		0-N1534	VB [BT]	S
2.0 TDI 16V	02/04-04/13	BKD	1968		0-N1530	VB [BT]	S
2.0 TDI 16V, 2.0 TDI RS	02/04-04/13	BMS	1968		0-N1534	VB [BT]	S

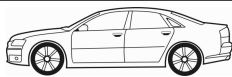
CM³

Art. Nr.



ohne Halter

OCTAVIA (1Z3)

2.0 TDI RS	04/06-02/13	BMN	1968			0-N1530	VB [BT]	S
------------	-------------	-----	------	--	--	----------------	---------	---

OCTAVIA Combi (1Z5)

1.4	05/04-06/13	BCA, BUD, CGGA	1390	20x130; 17x58; beinhalten Rollen: 4	SK-1511	BTK	
1.4	05/04-05/06	BCA	1390	20x130; 17x58; beinhalten Rollen: 4	SK-1511AQ1	BTKW	
1.4	05/06-06/13	BUD, CGGA	1390	20x130; 17x58; ch.1Z-9-000001→; beinhalten Rollen: 4	SK-1511AQ1	BTKW	
1.6	09/04-06/13	BGU, BSE, BSF, CCSA	1595	23x138; Baumuster: 1Z5	SK-1109	BTK	
1.6 LPG	08/09-11/12	CHGA	1595	23x138; Baumuster: 1Z5	SK-1109	BTK	
1.6 MultiFuel	01/08-06/13	CCSA	1595	23x138; Baumuster: 1Z5	SK-1109	BTK	
1.6 TDI, 1.6 TDI 4x4	06/09-04/13	CAYC	1598	25x160; → 11/2010	SK-1695	BTK	
1.6 TDI, 1.6 TDI 4x4	06/09-04/13	CAYC	1598	25x160; → 11/2010	SK-1695AQ1	BTKW	
1.6 TDI, 1.6 TDI 4x4	06/09-04/13	CAYC	1598	25x160; 12/2010 →	SK-1727	BTK	
1.6 TDI, 1.6 TDI 4x4	06/09-04/13	CAYC	1598	25x160; → 11/2010	SK-1727AQ2	BTKW	
1.6, 1.6 LPG, 1.6 MultiFuel	09/04-06/13	BGU, BSE, BSF, CCSA, CMXA, CCSA, CMXA, CHGA	1595	23x138	SK-1109AQ1	BTKW	
1.9 TDI, 1.9 TDI 4x4	09/04-12/10	BJB, BKC, BLS, BXE, BKC, BLS, BXE	1896	30x120; mit Zubehör	SK-1372	BTK	
1.9 TDI, 1.9 TDI 4x4	09/04-12/10	BJB, BKC, BLS, BXE, BKC, BLS, BXE	1896	30x120	SK-1372AQ1	BTKW	
2.0 FSI	11/04-10/08	BLR, BLY, BVY, BVZ	1984	23x148	SK-1724	BTK	
2.0 FSI	11/04-10/08	BLR, BLY, BVY, BVZ	1984	23x148	SK-1724AQ2	BTKW	
2.0 FSI 4x4	11/04-10/08	BLX, BVX	1984	23x148; Baumuster: Octavia Scout	SK-1724	BTK	
2.0 FSI 4x4	11/04-10/08	BLX, BVX	1984	23x148; Baumuster: Octavia Scout	SK-1724AQ2	BTKW	
2.0 RS	10/05-02/13	BWA	1984	23x148	SK-1724	BTK	
2.0 RS	10/05-02/13	BWA	1984	23x148	SK-1724AQ1	BTKW	
2.0 TDI	11/05-05/10	BMM	1968	30x120	SK-1372AQ2	BTKW	
2.0 TDI	03/10-06/13	CFHF, CLCA	1968	25x160; → 11/2010	SK-1727AQ2	BTKW	
2.0 TDI 16V	02/04-05/10	AZV	1968	30x141; ch.→1K-6-250000; mit Zubehör	SK-1595	BTK	
2.0 TDI 16V	02/04-05/13	BKD	1968	30x141; ch.→1K-6-250000; mit Zubehör	SK-1595	BTK	
2.0 TDI 16V	02/04-05/10	AZV	1968	30x141; → 05/2006; mit Zubehör	SK-1595AQ1	BTKW	
2.0 TDI 16V	02/04-05/13	BKD	1968	30x141; ch.→1Z-6-250000; mit Zubehör	SK-1595AQ1	BTKW	
2.0 TDI 16V	02/04-05/10	AZV	1968	30x141; ch.1K-7-000001→; mit Zubehör	SK-1668	BTK	
2.0 TDI 16V	02/04-05/13	BKD	1968	30x141; ch.1K-7-000001→; mit Zubehör	SK-1668	BTK	
2.0 TDI 16V	02/04-05/10	AZV	1968	30x141; 06/2006 →	SK-1668AQ1	BTKW	
2.0 TDI 16V	02/04-05/13	BKD	1968	30x141; ch.1Z-7-000001→	SK-1668AQ1	BTKW	
2.0 TDI 16V	02/04-05/13	CFHC, CLCB	1968	30x160	SK-1694	BTK	
2.0 TDI 16V	02/04-05/13	CFHC, CLCB	1968	25x160; → 11/2010	SK-1695	BTK	
2.0 TDI 16V	02/04-05/13	CFHC, CLCB	1968	25x160; → 11/2010	SK-1695AQ1	BTKW	
2.0 TDI 16V	02/04-05/13	CFHC, CLCB	1968	25x160; 12/2010 →	SK-1727	BTK	
2.0 TDI 16V	02/04-05/13	CFHC, CLCB	1968	25x160; → 11/2010	SK-1727AQ2	BTKW	
2.0 TDI 16V 4x4	05/10-02/13	CFHC	1968	30x141; mit Zubehör	SK-1595	BTK	
2.0 TDI 16V 4x4	05/10-02/13	BKD	1968	30x141; ch.→1Z-6-250000; mit Zubehör; Baumuster: Octavia Scout	SK-1595AQ1	BTKW	
2.0 TDI 16V 4x4	05/10-02/13	CFHC	1968	30x141; mit Zubehör	SK-1668	BTK	
2.0 TDI 16V 4x4	05/10-02/13	BKD	1968	30x141; ch.1Z-7-000001→; Baumuster: Octavia Scout	SK-1668AQ1	BTKW	
2.0 TDI 16V 4x4	05/10-02/13	CFHC	1968	25x160; → 11/2010	SK-1695	BTK	
2.0 TDI 16V 4x4	05/10-02/13	CFHC, CLCB	1968	25x160; → 11/2010; Baumuster: Octavia Scout	SK-1695AQ1	BTKW	
2.0 TDI 16V 4x4	05/10-02/13	CFHC	1968	25x160; → 11/2010	SK-1727AQ2	BTKW	
2.0 TDI 4x4	07/06-05/10	BMM	1968	30x120; Baumuster: Octavia Scout	SK-1372AQ2	BTKW	
2.0 TDI 4x4	07/06-05/10	BMM	1968	30x160; 05/2010 →	SK-1694	BTK	
2.0 TDI 4x4	05/11-02/13	CFHF	1968	25x160	SK-1727	BTK	
2.0 TDI 4x4	05/11-02/13	CFHF, CLCA	1968	25x160	SK-1727AQ2	BTKW	
2.0 TDI RS	04/06-02/13	BMN	1968	30x141; mit Zubehör	SK-1668	BTK	
2.0 TDI RS	04/06-02/13	BMN	1968	30x141	SK-1668AQ1	BTKW	
2.0 TDI RS	04/06-02/13	CEGA	1968	30x160; → 11/2010	SK-1694	BTK	
2.0 TDI RS	04/06-02/13	CEGA	1968	30x160	SK-1694AQ2	BTKW	
2.0 TDI, 2.0 TDI 16V 4x4	03/10-06/13	CFHC, CFHF, CLCA	1968	25x160; → 11/2010	SK-1695AQ1	BTKW	
2.0 TDI, 2.0 TDI 16V 4x4	03/10-06/13	CFHC, CFHF, CLCA	1968	25x160; 12/2010 →	SK-1727	BTK	
2.0 TDI, 2.0 TDI 16V 4x4, 2.0 TDI 4x4	03/10-06/13	CFHC, CFHF, CFHF, CLCA	1968	30x160	SK-1694	BTK	
2.0 TDI, 2.0 TDI 4x4	11/05-05/10	BMM	1968	30x120; mit Zubehör	SK-1372	BTK	
1.4	05/04-06/13	BCA, BUD, CGGA	1390		0-N1262	TB [DG]	
1.4	05/04-06/13	BCA, BUD, CGGA	1390		0-N1263	TB [TE]	
1.4	05/04-06/13	BCA, BUD, CGGA	1390		0-N158	TB [TE]	
1.4	05/04-05/06	BCA	1390		0-N164	TB [DG]	
1.6 TDI, 1.6 TDI 4x4	06/09-04/13	CAYC	1598		0-N131	TB [DG]	
1.6 TDI, 1.6 TDI 4x4	06/09-04/13	CAYC	1598		0-N2025	TB [DG]	

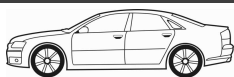

CM³



Art. Nr.



ohne Halter

OCTAVIA Combi (1Z5)

1.6 TDI, 1.6 TDI 4x4	06/09-04/13	CAYC	1598		0-N2061	TB [TE]	
1.6 TDI, 1.6 TDI 4x4	06/09-04/13	CAYC	1598		0-N2200	TB [DG]	
1.6, 1.6 LPG, 1.6 MultiFuel	09/04-06/13	BGU, BSE, BSF, CCSA, CMXA, CCSA, CMXA, CHGA	1595		0-N157	TB [TE]	
1.9 TDI, 1.9 TDI 4x4	09/04-12/10	BJB, BKC, BLS, BXE, BKC, BLS, BXE	1896		0-N1045	TB [TE]	
1.9 TDI, 1.9 TDI 4x4	09/04-12/10	BJB, BKC, BLS, BXE, BKC, BLS, BXE	1896		0-N1046	TB [DG]	
2.0 FSI, 2.0 FSI 4x4	11/04-10/08	BLR, BLY, BVY, BVZ, BLX, BVX	1984		0-N1316	TB [DG]	
2.0 FSI, 2.0 FSI 4x4	11/04-10/08	BLR, BLY, BVY, BVZ, BLX, BVX	1984		0-N1346	TB [DG]	
2.0 FSI, 2.0 FSI 4x4, 2.0 RS	11/04-02/13	BLR, BLY, BVY, BVZ, BLX, BVX, BWA, CCZA	1984		0-N2208	TB [TE]	
2.0 RS	10/05-02/13	BWA	1984		0-N1316	TB [DG]	
2.0 RS	10/05-02/13	BWA	1984		0-N1346	TB [DG]	
2.0 TDI	03/10-06/13	CFHF, CLCA	1968		0-N2025	TB [DG]	
2.0 TDI 16V	02/04-05/13	BKD	1968		0-N1046	TB [DG]	
2.0 TDI 16V	02/04-05/13	CFHC, CLCB	1968	→ 11/2010	0-N1046	TB [DG]	
2.0 TDI 16V	02/04-05/13	CFHC, CLCB	1968		0-N131	TB [DG]	
2.0 TDI 16V	02/04-05/10	AZV	1968		0-N1335	TB [TE]	
2.0 TDI 16V	02/04-05/13	BKD	1968		0-N1335	TB [TE]	
2.0 TDI 16V	02/04-05/10	AZV	1968	→ 05/2006	0-N1336	TB [DG]	
2.0 TDI 16V	02/04-05/13	BKD	1968	→ 05/2006	0-N1336	TB [DG]	
2.0 TDI 16V	02/04-05/10	AZV	1968	05/2006 →	0-N1575	TB [DG]	
2.0 TDI 16V	02/04-05/13	BKD	1968	05/2006 →	0-N1575	TB [DG]	
2.0 TDI 16V	02/04-05/13	CFHC, CLCB	1968		0-N2025	TB [DG]	
2.0 TDI 16V	02/04-05/13	CFHC, CLCB	1968		0-N2061	TB [TE]	
2.0 TDI 16V	02/04-05/13	CFHC, CLCB	1968		0-N2200	TB [DG]	
2.0 TDI 16V 4x4	05/10-02/13	CFHC	1968		0-N2025	TB [DG]	
2.0 TDI RS	04/06-02/13	BMN, CEGA	1968		0-N1046	TB [DG]	
2.0 TDI RS	04/06-02/13	CEGA	1968		0-N1268	TB [DG]	
2.0 TDI RS	04/06-02/13	BMN	1968		0-N1335	TB [TE]	
2.0 TDI RS	04/06-02/13	CEGA	1968		0-N1336	TB [DG]	
2.0 TDI RS	04/06-02/13	BMN	1968		0-N1575	TB [DG]	
2.0 TDI RS	04/06-02/13	CEGA	1968		0-N1905	TB [BT]	
2.0 TDI, 2.0 TDI 16V 4x4, 2.0 TDI 4x4	03/10-06/13	CFHC, CFHF, CFHF, CLCA	1968		0-N131	TB [DG]	
2.0 TDI, 2.0 TDI 16V 4x4, 2.0 TDI 4x4	03/10-06/13	CFHC, CFHF, CFHF, CLCA	1968		0-N2061	TB [TE]	
2.0 TDI, 2.0 TDI 16V 4x4, 2.0 TDI 4x4	03/10-06/13	CFHC, CFHF, CFHF, CLCA	1968		0-N2200	TB [DG]	
2.0 TDI, 2.0 TDI 16V, 2.0 TDI 4x4	02/04-05/10	AZV, BMM	1968		0-N1046	TB [DG]	
2.0 TDI, 2.0 TDI 4x4	11/05-05/10	BMM	1968		0-N1045	TB [TE]	
1.2 TSI	02/10-04/13	CBZB	1197		0-N1733	VB [BT]	S
1.2 TSI	02/10-04/13	CBZB	1197	☼	0-N2121	VB [DG]	
1.4	05/04-05/06	BCA	1390	☼, für Fahrzeuge mit Servolenkung	0-N1445	VB [BT]	S
1.4	05/06-06/13	BUD, CGGA	1390	☼	0-N1445	VB [BT]	S
1.4 TSI	11/08-06/13	CAXA	1390	☼; ☼	0-N1454	VB [DG]	
1.4 TSI	11/08-06/13	CAXA	1390	☼	0-N1525	VB [BT]	S
1.4 TSI	11/08-06/13	CAXA	1390	☼	0-N1733	VB [BT]	S
1.6 FSI	02/04-10/08	BLF	1598	☼; ☼	0-N1454	VB [DG]	
1.6 FSI	02/04-10/08	BLF	1598	☼	0-N1525	VB [BT]	S
1.6 FSI	02/04-10/08	BLF	1598	☼	0-N1733	VB [BT]	S
1.6 TDI, 1.6 TDI 4x4	06/09-04/13	CAYC	1598		0-N1534	VB [BT]	S
1.8 TSI, 1.8 TSI 4x4	06/07-06/13	BZB, CDA, CDA, CDAB	1798		0-N1832	VB [BT]	S
1.9 TDI	09/04-12/10	BJB, BKC	1896	ch.→1Z-5-121646, 1Z-58052421	0-N1530	VB [BT]	S
1.9 TDI	09/04-12/10	BJB, BKC	1896	ch.1Z-5-121647, 1Z-58052422→	0-N1531	VB [BT]	S
1.9 TDI 4x4	11/04-12/10	BKC	1896	ch.→1Z-5-121646, 1Z-58052421	0-N1530	VB [BT]	S
1.9 TDI 4x4	11/04-12/10	BKC	1896	ch.1Z-5-121647, 1Z-58052422→	0-N1531	VB [BT]	S
1.9 TDI, 1.9 TDI 4x4	09/04-12/10	BLS, BXE	1896		0-N1531	VB [BT]	S
2.0 RS	10/05-02/13	BWA	1984	ch.1Z-4-000001→	0-N1656	VB [BT]	S
2.0 TDI 16V	02/04-05/10	AZV	1968		0-N1530	VB [BT]	S
2.0 TDI 16V	02/04-05/13	BKD	1968		0-N1530	VB [BT]	S
2.0 TDI 16V, 2.0 TDI RS	02/04-05/13	BMS	1968		0-N1534	VB [BT]	S
2.0 TDI RS	04/06-02/13	BMN	1968		0-N1530	VB [BT]	S
2.0 TDI, 2.0 TDI 16V 4x4, 2.0 TDI 4x4	03/10-06/13	CFHC, CFHF, CFHF, CLCA	1968		0-N1534	VB [BT]	S
2.0 TDI, 2.0 TDI 4x4	11/05-05/10	BMM	1968		0-N1531	VB [BT]	S

OCTAVIA (5E3)

1.2 TSI	11/12-	CJZA, CJZB	1197		0-N2313	TB [TE]	
1.2 TSI	11/12-	CJZA, CJZB	1197		0-N2381	TB [DG]	
1.4 TSI, 1.4 TSI G-TEC	11/12-	CHPA, CPWA	1395		0-N2313	TB [TE]	

CM³

Art. Nr.



ohne Halter

OCTAVIA (5E3)

1.4 TSI, 1.4 TSI G-TEC	11/12-	CHPA, CPWA	1395		0-N2381	TB [DG]	
1.6	01/14-	CWVA	1598		0-N2313	TB [TE]	
1.6	01/14-	CWVA	1598		0-N2381	TB [DG]	
1.6 TDI	11/12-	CLHA, CLHB, CRKB, CXXB, DBKA	1598		0-N131	TB [DG]	
1.6 TDI	11/12-	CLHA, CLHB, CRKB, CXXB, DBKA	1598		0-N2314	TB [TE]	
2.0 TDI, 2.0 TDI 4x4	11/12-	CKFB, CRVC, CKFC, CRMB, CUNA, CUPA	1968		0-N131	TB [DG]	
2.0 TDI, 2.0 TDI 4x4	11/12-	CKFB, CRVC, CKFC, CRMB, CUNA, CUPA	1968		0-N2314	TB [TE]	
1.6 TDI	11/12-	CLHA, CLHB, CRKB, CXXB, DBKA	1598	*	0-N2288	VB [BT]	S
2.0 TDI	11/12-	CKFB, CRVC	1968	ch.5E-D-000001→; *	0-N2288	VB [BT]	S
2.0 TDI	05/13-	CUNA, CUPA	1968	*	0-N2288	VB [BT]	S

OCTAVIA Combi (5E5)

1.2 TSI	11/12-	CJZA, CJZB	1197		0-N2313	TB [TE]	
1.2 TSI	11/12-	CJZA, CJZB	1197		0-N2381	TB [DG]	
1.4 TSI, 1.4 TSI G-TEC	11/12-	CHPA, CPWA	1395		0-N2313	TB [TE]	
1.4 TSI, 1.4 TSI G-TEC	11/12-	CHPA, CPWA	1395		0-N2381	TB [DG]	
1.6	01/14-	CWVA	1598		0-N2313	TB [TE]	
1.6	01/14-	CWVA	1598		0-N2381	TB [DG]	
1.6 TDI, 1.6 TDI 4x4	11/12-	CLHA, CLHB, CRKB, CXXB, DBKA	1598		0-N131	TB [DG]	
1.6 TDI, 1.6 TDI 4x4	11/12-	CLHA, CLHB, CRKB, CXXB, DBKA	1598		0-N2314	TB [TE]	
2.0 TDI, 2.0 TDI 4x4	11/12-	CKFB, CRVC, CKFC, CKFC, CRMB, CUNA, CUPA	1968		0-N131	TB [DG]	
2.0 TDI, 2.0 TDI 4x4	11/12-	CKFB, CRVC, CKFC, CKFC, CRMB, CUNA, CUPA	1968		0-N2314	TB [TE]	
1.6 TDI	05/13-	CRKB, CXXB, DBKA	1598		0-N2288	VB [BT]	S
1.6 TDI, 1.6 TDI 4x4	11/12-	CLHA, CLHB	1598	*	0-N2288	VB [BT]	S
2.0 TDI, 2.0 TDI 4x4	11/12-	CKFB, CRVC, CKFC	1968	ch.5E-D-000001→; *	0-N2288	VB [BT]	S
2.0 TDI, 2.0 TDI 4x4	05/13-	CUNA, CUPA	1968	*	0-N2288	VB [BT]	S

RAPID (NH3)

1.6 TDI	07/12-	CAYC, CLNA	1598	25x160; → 12/2012	SK-1727	BTK	
1.6 TDI	07/12-	CAYC, CLNA	1598	25x160	SK-1727AQ2	BTKW	
1.6 TDI	08/13-	CAYC	1598	25x160	SK-1727AQ2	BTKW	
1.6 TDI	07/12-	CAYB, CAYC, CLNA	1598		0-N131	TB [DG]	
1.2	07/12-	CGPC	1198	*	0-N1908	VB [BT]	S
1.2 TSI	07/12-	CBZB	1197		0-N1733	VB [BT]	S
1.2 TSI	07/12-	CBZA	1197	*	0-N1733	VB [BT]	S
1.4 TSI	07/12-	CAXA	1390	*	0-N1733	VB [BT]	S
1.6	07/12-	CFNA	1598	*	0-N1733	VB [BT]	S
1.6 TDI	07/12-	CAYB, CAYC, CLNA	1598		0-N1534	VB [BT]	S

RAPID Spaceback (NH1)

1.6 TDI	07/12-	CAYC, CLNA	1598	25x160; → 12/2012	SK-1727	BTK	
1.6 TDI	07/12-	CAYC, CLNA	1598	25x160	SK-1727AQ2	BTKW	
1.6 TDI	08/13-	CAYC	1598	25x160	SK-1727AQ2	BTKW	
1.2	07/12-	CGPC	1198	*	0-N1908	VB [BT]	S
1.2 TSI	07/12-	CBZA, CBZB	1197	*	0-N1733	VB [BT]	S
1.4 TSI	07/12-	CAXA	1390	*	0-N1733	VB [BT]	S
1.6	07/12-	CFNA	1598	*	0-N1733	VB [BT]	S
1.6 TDI	08/13-	CAYB	1598	*	0-N1534	VB [BT]	S
1.6, 1.6 TDI	07/12-	CAYC, CLNA, CFNA	1598		0-N1534	VB [BT]	S

ROOMSTER (5J)

1.2 TDI	03/10-05/15	CFWA	1199	25x160	SK-1695	BTK	
1.2 TDI	03/10-05/15	CFWA	1199	25x160; → 11/2010	SK-1695AQ1	BTKW	
1.2 TDI	03/10-05/15	CFWA	1199	25x160; → 11/2010; Baumuster: Scout	SK-1695AQ1	BTKW	
1.2 TDI	03/10-05/15	CFWA	1199	25x160; → 11/2010	SK-1727AQ2	BTKW	
1.4	09/06-05/15	BXW, CGGB	1390	20x130; 17x58; beinhaltetete Rollen: 4	SK-1511	BTK	
1.4	09/06-05/15	BXW, CGGB	1390	20x130; 17x58; beinhaltetete Rollen: 4; Baumuster: Scout	SK-1511AQ1	BTKW	
1.4 TDI	07/06-03/10	BMS, BNV, BNM	1422	30x120; mit Zubehör	SK-1372	BTK	
1.4 TDI	07/06-03/10	BNM	1422	30x120	SK-1372AQ1	BTKW	
1.4 TDI	09/06-03/10	BMS, BNV	1422	30x120; Baumuster: Scout	SK-1372AQ1	BTKW	
1.6 TDI	03/10-05/15	CAYB, CAYC	1598	25x160	SK-1695	BTK	
1.6 TDI	03/10-05/15	CAYB, CAYC	1598	25x160; → 11/2010	SK-1695AQ1	BTKW	
1.6 TDI	03/10-05/15	CAYB, CAYC	1598	25x160; → 11/2010; Baumuster: Scout	SK-1695AQ1	BTKW	
1.6 TDI	03/10-05/15	CAYC	1598	25x160; → 11/2010	SK-1727AQ2	BTKW	
1.9 TDI	03/06-03/10	AXR, BLS, BSW	1896	30x120; mit Zubehör	SK-1372	BTK	



CM³



Art. Nr.



ROOMSTER (5J)							
1.9 TDI	03/06-05/06	AXR	1896	30x120	SK-1372AQ1	BTKW	
1.9 TDI	09/06-03/10	BLS, BSW	1896	30x120; Baumuster: Scout	SK-1372AQ1	BTKW	
1.2 TDI	03/10-05/15	CFWA	1199		0-N131	TB [DG]	
1.2 TDI	03/10-05/15	CFWA	1199		0-N2025	TB [DG]	
1.2 TDI	03/10-05/15	CFWA	1199		0-N2061	TB [TE]	
1.2 TDI	03/10-05/15	CFWA	1199		0-N2200	TB [DG]	
1.4	09/06-05/15	BXW, CGGB	1390		0-N1262	TB [DG]	
1.4	09/06-05/15	BXW, CGGB	1390		0-N1263	TB [TE]	
1.4	09/06-05/15	BXW, CGGB	1390		0-N158	TB [TE]	
1.4	09/06-05/15	BXW, CGGB	1390		0-N164	TB [DG]	
1.4 TDI	07/06-03/10	BMS, BNV, BNM	1422		0-N1045	TB [TE]	
1.4 TDI	07/06-03/10	BMS, BNV, BNM	1422		0-N1046	TB [DG]	
1.6 TDI	03/10-05/15	CAYB, CAYC	1598		0-N131	TB [DG]	
1.6 TDI	03/10-05/15	CAYB, CAYC	1598		0-N2025	TB [DG]	
1.6 TDI	03/10-05/15	CAYB, CAYC	1598		0-N2061	TB [TE]	
1.6 TDI	03/10-05/15	CAYB, CAYC	1598		0-N2200	TB [DG]	
1.9 TDI	03/06-03/10	AXR, BLS, BSW	1896		0-N1046	TB [DG]	
1.9 TDI	09/06-03/10	BLS, BSW	1896		0-N1045	TB [TE]	
1.2	05/06-05/15	BME, BZG, CGPA	1198		0-N1908	VB [BT]	S
1.2	05/06-05/15	BME, BZG, CGPA	1198	☼	0-N1909	VB [DG]	
1.2 TDI	03/10-05/15	CFWA	1199		0-N1534	VB [BT]	S
1.2 TSI	03/10-05/15	CBZA, CBZB	1197		0-N1733	VB [BT]	S
1.2 TSI	03/10-05/15	CBZA, CBZB	1197	☼	0-N2121	VB [DG]	
1.4	09/06-05/15	BXW, CGGB	1390	☼	0-N1445	VB [BT]	S
1.4 TDI	07/06-03/10	BNM	1422		0-N1704	VB [BT]	S
1.4 TDI	09/06-03/10	BMS	1422		0-N1534	VB [BT]	S
1.4 TDI	09/06-03/10	BNV	1422		0-N1704	VB [BT]	S
1.6	09/06-05/15	BTS, CFNA	1598	☼; ☼	0-N1454	VB [DG]	
1.6	09/06-05/15	BTS, CFNA	1598	☼	0-N1525	VB [BT]	S
1.6	09/06-05/15	BTS, CFNA	1598	☼	0-N1733	VB [BT]	S
1.6 TDI	03/10-05/15	CAYB, CAYC	1598		0-N1534	VB [BT]	S
1.9 TDI	03/06-05/06	AXR	1896	☼	0-N1534	VB [BT]	S
1.9 TDI	09/06-03/10	BMS	1896		0-N1534	VB [BT]	S
1.9 TDI	09/06-03/10	BLS, BSW	1896		0-N1536	VB [BT]	S

ROOMSTER Praktik (5J)							
1.2 TDI	03/10-05/15	CFWA	1199	25x160	SK-1695	BTK	
1.2 TDI	03/10-05/15	CFWA	1199	25x160; → 11/2010	SK-1695AQ1	BTKW	
1.2 TDI	03/10-05/15	CFWA	1199	25x160; → 11/2010	SK-1727AQ2	BTKW	
1.4	03/07-05/15	BXW, CGGB	1390	20x130; 17x58; beinhaltetete Rollen: 4	SK-1511	BTK	
1.4	03/07-05/15	BXW, CGGB	1390	20x130; 17x58; beinhaltetete Rollen: 4	SK-1511AQ1	BTKW	
1.4 TDI	03/07-03/10	BMS, BNV, BNM	1422	30x120; mit Zubehör	SK-1372	BTK	
1.4 TDI	03/07-03/10	BMS, BNV, BNM	1422	30x120	SK-1372AQ1	BTKW	
1.6 TDI	03/10-05/15	CAYB	1598	25x160	SK-1695	BTK	
1.6 TDI	03/10-05/15	CAYB	1598	25x160; → 11/2010	SK-1695AQ1	BTKW	
1.6 TDI	03/10-05/15	CAYC	1598	25x160; → 11/2010	SK-1727AQ2	BTKW	
1.2 TDI	03/10-05/15	CFWA	1199		0-N131	TB [DG]	
1.2 TDI	03/10-05/15	CFWA	1199		0-N2025	TB [DG]	
1.2 TDI	03/10-05/15	CFWA	1199		0-N2061	TB [TE]	
1.2 TDI	03/10-05/15	CFWA	1199		0-N2200	TB [DG]	
1.4	03/07-05/15	BXW, CGGB	1390		0-N1262	TB [DG]	
1.4	03/07-05/15	BXW, CGGB	1390		0-N1263	TB [TE]	
1.4	03/07-05/15	BXW, CGGB	1390		0-N158	TB [TE]	
1.4 TDI	03/07-03/10	BMS, BNV, BNM	1422		0-N1045	TB [TE]	
1.4 TDI	03/07-03/10	BMS, BNV, BNM	1422		0-N1046	TB [DG]	
1.6 TDI	03/10-05/15	CAYB	1598	→ 11/2010	0-N1046	TB [DG]	
1.6 TDI	03/10-05/15	CAYB	1598		0-N131	TB [DG]	
1.2	03/07-05/15	BZG, CGPA	1198		0-N1908	VB [BT]	S
1.2	03/07-05/15	BZG, CGPA	1198	☼	0-N1909	VB [DG]	
1.2 TDI	03/10-05/15	CFWA	1199		0-N1534	VB [BT]	S
1.2 TSI	03/10-05/15	CBZA	1197	☼	0-N1733	VB [BT]	S
1.2 TSI	03/10-05/15	CBZA	1197	☼	0-N2121	VB [DG]	
1.4	03/07-05/15	BXW, CGGB	1390		0-N1445	VB [BT]	S
1.4 TDI	03/07-03/10	BMS	1422		0-N1534	VB [BT]	S
1.4 TDI	03/07-03/10	BNM	1422		0-N1704	VB [BT]	S
1.4 TDI	03/07-03/10	BNV	1422		0-N1704	VB [BT]	S



OPTIMAL®

SKODA

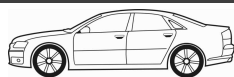

CM³



Art. Nr.



ROOMSTER Praktik (5J)							
1.6 TDI	03/10-05/15	CAYB	1598			0-N1534	VB [BT] S
SUPERB (3U4)							
1.8 T	12/01-03/08	AWT	1781	23x150; ohne Spanndämpfer, Spannrolle; mit Zubehör		SK-1640	BTK
1.8 T	12/01-03/08	AWT	1781	23x150; ohne Spanndämpfer, Spannrolle; mit Zubehör		SK-1640AQ1	BTKW
1.8 T	12/01-03/08	AWT	1781	23x150; mit Zubehör		SK-1726	BTK
1.8 T	12/01-03/08	AWT	1781	23x150; mit Zubehör		SK-1726AQ1	BTKW
1.9 TDI	12/01-03/08	AVB, AVF, AWX, BPZ, BSV	1896	30x120; ch.→3U-29015229→; mit Zubehör		SK-1372	BTK
1.9 TDI	12/01-03/08	AVF	1896	30x120		SK-1372AQ2	BTKW
1.9 TDI	12/01-03/08	AWX	1896	30x120; ch.→3U-3-009507→		SK-1372AQ2	BTKW
1.9 TDI	12/01-03/08	AVF, AWX	1896	30x120; ch.→3U-3-009506; mit Zubehör; Baumuster: 3U4		SK-1582	BTK
1.9 TDI	12/01-03/08	AWX	1896	30x120; ch.→3U-3-009506; ohne Spanndämpfer, Spannrolle; mit Zubehör		SK-1582AQ1	BTKW
1.9 TDI	12/01-03/08	AVF, AWX	1896	30x120; ch.→3U-3-009506; mit Spanndämpfer, Spannrolle; mit Zubehör; Baumuster: 3U4		SK-1583	BTK
1.9 TDI	12/01-03/08	AWX	1896	30x120; ch.→3U-3-009506; mit Spanndämpfer, Spannrolle; mit Zubehör		SK-1583AQ1	BTKW
1.9 TDI	08/02-10/05	AVB	1896	30x120; ch.3U-3-009507→		SK-1372AQ2	BTKW
1.9 TDI	08/02-10/05	AVB	1896	30x120; ch.→3U-3-009506; mit Zubehör; Baumuster: 3U4		SK-1582	BTK
1.9 TDI	08/02-10/05	AVB	1896	30x120; ch.→3U-3-009506; ohne Spanndämpfer, Spannrolle; mit Zubehör		SK-1582AQ1	BTKW
1.9 TDI	08/02-10/05	AVB	1896	30x120; ch.→3U-3-009506; mit Spanndämpfer, Spannrolle; mit Zubehör; Baumuster: 3U4		SK-1583	BTK
1.9 TDI	08/02-10/05	AVB	1896	30x120; ch.→3U-3-009506; mit Spanndämpfer, Spannrolle; mit Zubehör		SK-1583AQ1	BTKW
1.9 TDI	10/05-03/08	BPZ, BSV	1896	30x120		SK-1372AQ2	BTKW
2.0	12/01-03/08	AZM	1984	23x138; Baumuster: 3U4		SK-1109	BTK
2.0	12/01-03/08	AZM	1984	23x138; ch.→3U-3-033360; für OE: 06A121011T		SK-1109AQ2	BTKW
2.0 TDI	10/05-03/08	BSS	1968	30x120; ch.3U-29015229→; mit Zubehör		SK-1372	BTK
2.0 TDI	10/05-03/08	BSS	1968	30x120		SK-1372AQ2	BTKW
2.0 TDI	10/05-03/08	BSS	1968	30x120; ch.→3U-29015228; mit Zubehör		SK-1582	BTK
2.0 TDI	10/05-03/08	BSS	1968	30x120; ch.→3U-29015228; mit Spanndämpfer, Spannrolle; mit Zubehör		SK-1583	BTK
2.5 TDI	12/01-03/08	AYM, BDG	2496	30x207; 24x87; ohne Spanndämpfer, Spannrolle; mit Zubehör; Baumuster: 3U4		SK-1619	BTK
2.5 TDI	12/01-03/08	AYM, BDG	2496	30x207; 24x87; nur in Verbindung mit: 078 121 113 F; mit Zubehör		SK-1619AQ2	BTKW
2.5 TDI	12/01-03/08	AYM, BDG	2496	30x207; 24x87; mit Spanndämpfer, Spannrolle; mit Zubehör; Baumuster: 3U4		SK-1621	BTK
2.5 TDI	12/01-03/08	AYM, BDG	2496	30x207; 24x87; mit Spanndämpfer, Spannrolle; mit Zubehör		SK-1621AQ1	BTKW
2.5 TDI	12/01-03/08	AYM, BDG	2496	32x207; 24x87; mit Spanndämpfer, Spannrolle; mit Zubehör		SK-1633AQ1	BTKW
2.8 V6	12/01-03/08	AMX	2771	30x253; mit Spanndämpfer, Spannrolle; mit Zubehör; Baumuster: 3U4		SK-1377	BTK
2.8 V6	12/01-03/08	AMX, BBG	2771	30x253; mit Spanndämpfer, Spannrolle; mit Zubehör		SK-1377AQ1	BTKW
2.8 V6	12/01-03/08	AMX, BBG	2771	30x253; ohne Spanndämpfer, Spannrolle; mit Zubehör		SK-1383	BTK
2.8 V6	06/02-03/08	BBG	2771	30x253; mit Spanndämpfer, Spannrolle; mit Zubehör		SK-1377	BTK
1.8 T	12/01-03/08	AWT	1781			0-N1050	TB [TE]
1.8 T	12/01-03/08	AWT	1781			0-N1051	TB [BT] S
1.8 T	12/01-03/08	AWT	1781			0-N1316	TB [DG]
1.8 T	12/01-03/08	AWT	1781			0-N1822	TB [BT] S
1.9 TDI	12/01-03/08	AVB, AVF, AWX	1896	ch.3U-29015229→		0-N1045	TB [TE]
1.9 TDI	12/01-03/08	AVB, AVF, AWX	1896	ch.3U-29015229→		0-N1046	TB [DG]
1.9 TDI	12/01-03/08	AVB, AVF, AWX	1896	ch.→3U-29015228		0-N1048	TB [TE]
1.9 TDI	12/01-03/08	AVB, AVF, AWX	1896	ch.→3U-29015228		0-N1268	TB [DG]
1.9 TDI	12/01-03/08	AVB, AVF, AWX	1896	ch.→3U-29015228		0-N1274	TB [BT]
1.9 TDI	10/05-03/08	BPZ, BSV	1896			0-N1045	TB [TE]
1.9 TDI	10/05-03/08	BPZ, BSV	1896			0-N1046	TB [DG]
2.0	12/01-03/08	AZM	1984			0-N157	TB [TE]
2.0	12/01-03/08	AZM	1984			0-N1822	TB [BT] S
2.0 TDI	10/05-03/08	BSS	1968			0-N1045	TB [TE]



CM³



Art. Nr.



SUPERB (3U4)							
2.0 TDI	10/05-03/08	BSS	1968			0-N1046	TB [DG]
2.5 TDI	12/01-03/08	AYM, BDG	2496			0-N1266	TB [TE]
2.5 TDI	12/01-03/08	AYM, BDG	2496			0-N1363	TB [TE]
2.5 TDI	12/01-03/08	AYM, BDG	2496			0-N1364	TB [BT]
2.5 TDI	12/01-03/08	AYM, BDG	2496			0-N168	TB [DG]
2.5 TDI	12/01-03/08	AYM, BDG	2496			0-N201	TB [BT]
2.8 V6	12/01-03/08	AMX	2771			0-N1238	TB [TE]
2.8 V6	12/01-03/08	AMX	2771			0-N1275	TB [BT]
2.8 V6	12/01-03/08	AMX	2771			0-N1371	TB [TE]
2.8 V6	12/01-03/08	AMX	2771			0-N2001	TB [DG]
1.8 T	12/01-03/08	AWT	1781	Rippenanzahl: 4		0-N1317	VB [TE] S
1.9 TDI	12/01-03/08	AVB, AVF, AWX, BPZ, BSV	1896	Rippenanzahl: 4		0-N1317	VB [TE] S
1.9 TDI	12/01-03/08	AVB, AVF, AWX, BPZ, BSV	1896	Rippenanzahl: 5		0-N1441	VB [BT] S
1.9 TDI	12/01-03/08	AVB, AVF, AWX	1896			0-N2047	VB [DG]
1.9 TDI	12/01-03/08	AVB, AVF, AWX, BPZ, BSV	1896			0-N2139	VB [VD]
2.0	12/01-03/08	AZM	1984	Rippenanzahl: 4		0-N1317	VB [TE] S
2.0 TDI	10/05-03/08	BSS	1968	Rippenanzahl: 4		0-N1317	VB [TE] S
2.0 TDI	10/05-03/08	BSS	1968	Rippenanzahl: 5		0-N1441	VB [BT] S
2.0 TDI	10/05-03/08	BSS	1968			0-N2139	VB [VD]
2.5 TDI	12/01-03/08	AYM, BDG	2496			0-N1005	VB [TE]
2.5 TDI	12/01-03/08	AYM, BDG	2496			0-N1308	VB [TE]
2.5 TDI	12/01-03/08	AYM, BDG	2496			0-N1315	VB [DG]
2.5 TDI	12/01-03/08	AYM, BDG	2496	Rippenanzahl: 6		0-N1431	VB [DG]
2.5 TDI	12/01-03/08	AYM, BDG	2496			0-N1947	VB [VD]
2.5 TDI	12/01-03/08	AYM, BDG	2496			0-N2196	VB [BT]
2.5 TDI	12/01-03/08	AYM, BDG	2496			0-N2258	VB [BT]
2.5 TDI	12/01-03/08	AYM, BDG	2496			0-N2417	VB [BT]
2.8 V6	12/01-03/08	AMX	2771			0-N1083	VB [BT] S
SUPERB (3T4)							
1.6 TDI	09/10-05/15	CAYC	1598	25x160; → 11/2010		SK-1695	BTK
1.6 TDI	09/10-05/15	CAYC	1598	25x160; → 11/2010		SK-1695AQ1	BTKW
1.6 TDI	09/10-05/15	CAYC	1598	25x160; 12/2010 →		SK-1727	BTK
1.6 TDI	09/10-05/15	CAYC	1598	25x160; → 11/2010		SK-1727AQ2	BTKW
1.9 TDI	03/08-11/10	BLS, BXE	1896	30x120; mit Zubehör		SK-1372	BTK
1.9 TDI	03/08-11/10	BLS, BXE	1896	30x120		SK-1372AQ1	BTKW
2.0 TDI	03/08-05/10	BMP	1968	30x120; mit Zubehör		SK-1372	BTK
2.0 TDI	03/08-05/10	BMP	1968	30x120		SK-1372AQ2	BTKW
2.0 TDI 16V	01/09-05/15	BKD	1968	30x141; → 11/2010; mit Zubehör		SK-1668	BTK
2.0 TDI 16V	01/09-05/15	BKD	1968	30x141		SK-1668AQ1	BTKW
2.0 TDI 16V	01/09-05/15	CFFB, CLJA	1968	25x160; → 11/2010		SK-1695	BTK
2.0 TDI 16V	01/09-05/15	CFFB, CLJA	1968	25x160; → 11/2010		SK-1695AQ1	BTKW
2.0 TDI 16V	01/09-05/15	CFFB, CLJA	1968	25x160; 12/2010 →		SK-1727	BTK
2.0 TDI 16V 4x4	11/10-05/15	CFFB	1968	25x160		SK-1695	BTK
2.0 TDI 16V 4x4	11/10-05/15	CFFB	1968	25x160; → 11/2010		SK-1695AQ1	BTKW
2.0 TDI 16V, 2.0 TDI 16V 4x4	01/09-05/15	CFFB	1968	25x160; → 11/2010		SK-1727AQ2	BTKW
2.0 TDI, 2.0 TDI 4x4	07/08-05/15	CBBB	1968	30x160		SK-1694	BTK
2.0 TDI, 2.0 TDI 4x4	07/08-05/15	CBBB	1968	30x160		SK-1694AQ2	BTKW
2.0 TDI, 2.0 TDI 4x4	07/08-05/15	CFGB	1968	25x160		SK-1695	BTK
2.0 TDI, 2.0 TDI 4x4	07/08-05/15	CFGB	1968	25x160; → 11/2010		SK-1695AQ1	BTKW
2.0 TDI, 2.0 TDI 4x4	07/08-05/15	CFFB, CFGB	1968	25x160; → 11/2010		SK-1727AQ2	BTKW
1.6 TDI	09/10-05/15	CAYC	1598			0-N131	TB [DG]
1.6 TDI	09/10-05/15	CAYC	1598			0-N2025	TB [DG]
1.6 TDI	09/10-05/15	CAYC	1598			0-N2061	TB [TE]
1.6 TDI	09/10-05/15	CAYC	1598			0-N2200	TB [DG]
1.9 TDI	03/08-11/10	BLS, BXE	1896			0-N1045	TB [TE]
1.9 TDI	03/08-11/10	BLS, BXE	1896			0-N1046	TB [DG]
2.0 TDI	03/08-05/10	BMP	1968			0-N1045	TB [TE]
2.0 TDI	03/08-05/10	BMP	1968			0-N1046	TB [DG]
2.0 TDI	07/08-05/15	CFGB	1968	→ 10/2010		0-N1046	TB [DG]
2.0 TDI 16V	01/09-05/15	BKD	1968			0-N1046	TB [DG]
2.0 TDI 16V	01/09-05/15	CFFB, CLJA	1968	→ 10/2010		0-N1046	TB [DG]
2.0 TDI 16V	01/09-05/15	CFFB, CLJA	1968			0-N131	TB [DG]
2.0 TDI 16V	01/09-05/15	BKD	1968			0-N1335	TB [TE]
2.0 TDI 16V	01/09-05/15	BKD	1968			0-N1575	TB [DG]
2.0 TDI 16V	01/09-05/15	CFFB, CLJA	1968			0-N2025	TB [DG]



OPTIMAL®

SKODA



CM³



Art. Nr.



ohne Halter

SUPERB (3T4)

2.0 TDI 16V	01/09-05/15	CFFB, CLJA	1968		0-N2061	TB [TE]	
2.0 TDI 16V	01/09-05/15	CFFB, CLJA	1968	12/2010 →	0-N2200	TB [DG]	
2.0 TDI 16V 4x4	11/10-05/15	CFFB	1968		0-N131	TB [DG]	
2.0 TDI 16V 4x4	11/10-05/15	CFFB	1968		0-N2061	TB [TE]	
2.0 TDI 16V 4x4	11/10-05/15	CFFB	1968		0-N2200	TB [DG]	
2.0 TDI 4x4	09/08-05/15	CFGB	1968	→ 11/2010	0-N1046	TB [DG]	
2.0 TDI, 2.0 TDI 4x4	07/08-05/15	CBBB	1968		0-N1046	TB [DG]	
2.0 TDI, 2.0 TDI 4x4	07/08-05/15	CBBB	1968		0-N1268	TB [DG]	
2.0 TDI, 2.0 TDI 4x4	07/08-05/15	CFGB	1968		0-N131	TB [DG]	
2.0 TDI, 2.0 TDI 4x4	07/08-05/15	CBBB	1968		0-N1336	TB [DG]	
2.0 TDI, 2.0 TDI 4x4	07/08-05/15	CBBB	1968		0-N1905	TB [BT]	
2.0 TDI, 2.0 TDI 4x4	07/08-05/15	CFGB	1968		0-N2025	TB [DG]	
2.0 TDI, 2.0 TDI 4x4	07/08-05/15	CFGB	1968		0-N2061	TB [TE]	
2.0 TDI, 2.0 TDI 4x4	07/08-05/15	CFGB	1968	12/2010 →	0-N2200	TB [DG]	
1.4 TSI	07/08-05/15	CAXC	1390	†; *	0-N1454	VB [DG]	
1.4 TSI	07/08-05/15	CAXC	1390	*	0-N1525	VB [BT]	S
1.4 TSI	07/08-05/15	CAXC	1390	*	0-N1733	VB [BT]	S
1.6 TDI	09/10-05/15	CAYC	1598		0-N1534	VB [BT]	S
1.8 TSI, 1.8 TSI 4x4	03/08-05/15	BZB, CDA, CDA, CDAB	1798		0-N1832	VB [BT]	S
1.9 TDI	03/08-11/10	BLS, BXE	1896		0-N1531	VB [BT]	S
2.0 TDI	03/08-05/10	BMP	1968		0-N1531	VB [BT]	S
2.0 TDI 16V	01/09-05/15	BKD	1968		0-N1530	VB [BT]	S
2.0 TDI 16V 4x4	11/10-05/15	CFFB	1968		0-N1534	VB [BT]	S
2.0 TDI, 2.0 TDI 16V, 2.0 TDI 4x4	07/08-05/15	BMS	1968		0-N1534	VB [BT]	S
2.0 TSI	05/10-05/15	CCZA	1984		0-N1832	VB [BT]	S
3.6 V6 4x4	11/08-05/15	CDVA	3580		0-N1715	VB [DG]	
3.6 V6 4x4	11/08-05/15	CDVA	3580		0-N2209	VB [BT]	S

SUPERB Kombi (3T5)

1.6 TDI	09/10-05/15	CAYC	1598	25x160; → 11/2010	SK-1695	BTK	
1.6 TDI	09/10-05/15	CAYC	1598	25x160; → 11/2010	SK-1695AQ1	BTKW	
1.6 TDI	09/10-05/15	CAYC	1598	25x160; 12/2010 →	SK-1727	BTK	
1.6 TDI	09/10-05/15	CAYC	1598	25x160; → 11/2010	SK-1727AQ2	BTKW	
1.9 TDI	10/09-11/10	BLS, BXE	1896	30x120; mit Zubehör	SK-1372	BTK	
1.9 TDI	10/09-11/10	BLS, BXE	1896	30x120	SK-1372AQ1	BTKW	
2.0 TDI	10/09-03/10	BMP	1968	30x120; mit Zubehör	SK-1372	BTK	
2.0 TDI	10/09-03/10	BMP	1968	30x120	SK-1372AQ2	BTKW	
2.0 TDI 16V	10/09-05/15	BKD	1968	30x141; → 11/2010; mit Zubehör	SK-1668	BTK	
2.0 TDI 16V	10/09-05/15	BKD	1968	30x141	SK-1668AQ1	BTKW	
2.0 TDI 16V	10/09-05/15	CFFB, CLJA	1968	25x160; → 11/2010	SK-1695	BTK	
2.0 TDI 16V	10/09-05/15	CFFB, CLJA	1968	25x160; → 11/2010	SK-1695AQ1	BTKW	
2.0 TDI 16V	10/09-05/15	CFFB, CLJA	1968	25x160; 12/2010 →	SK-1727	BTK	
2.0 TDI 16V 4x4	11/10-05/15	CFFB	1968	25x160	SK-1695	BTK	
2.0 TDI 16V 4x4	11/10-05/15	CFFB	1968	25x160; → 11/2010	SK-1695AQ1	BTKW	
2.0 TDI 16V, 2.0 TDI 16V 4x4	10/09-05/15	CFFB	1968	25x160; → 11/2010	SK-1727AQ2	BTKW	
2.0 TDI, 2.0 TDI 4x4	10/09-05/15	CBBB	1968	30x160	SK-1694	BTK	
2.0 TDI, 2.0 TDI 4x4	10/09-05/15	CBBB	1968	30x160	SK-1694AQ2	BTKW	
2.0 TDI, 2.0 TDI 4x4	10/09-05/15	CFGB	1968	25x160	SK-1695	BTK	
2.0 TDI, 2.0 TDI 4x4	10/09-05/15	CFGB	1968	25x160; → 11/2010	SK-1695AQ1	BTKW	
2.0 TDI, 2.0 TDI 4x4	10/09-05/15	CFFB, CFGB	1968	25x160; → 11/2010	SK-1727AQ2	BTKW	
1.6 TDI	09/10-05/15	CAYC	1598		0-N131	TB [DG]	
1.6 TDI	09/10-05/15	CAYC	1598		0-N2025	TB [DG]	
1.6 TDI	09/10-05/15	CAYC	1598		0-N2061	TB [TE]	
1.6 TDI	09/10-05/15	CAYC	1598		0-N2200	TB [DG]	
1.9 TDI	10/09-11/10	BLS, BXE	1896		0-N1046	TB [DG]	
2.0 TDI	10/09-03/10	BMP	1968		0-N1045	TB [TE]	
2.0 TDI	10/09-03/10	BMP	1968		0-N1046	TB [DG]	
2.0 TDI	10/09-03/10	BMP	1968		0-N2025	TB [DG]	
2.0 TDI 16V	10/09-05/15	BKD	1968		0-N1046	TB [DG]	
2.0 TDI 16V	10/09-05/15	CFFB, CLJA	1968	→ 11/2010	0-N1046	TB [DG]	
2.0 TDI 16V	10/09-05/15	CFFB, CLJA	1968		0-N131	TB [DG]	
2.0 TDI 16V	10/09-05/15	BKD	1968		0-N1335	TB [TE]	
2.0 TDI 16V	10/09-05/15	BKD	1968		0-N1575	TB [DG]	
2.0 TDI 16V	10/09-05/15	CFFB, CLJA	1968		0-N2025	TB [DG]	
2.0 TDI 16V	10/09-05/15	CFFB, CLJA	1968		0-N2061	TB [TE]	
2.0 TDI 16V	10/09-05/15	CFFB, CLJA	1968	12/2010 →	0-N2200	TB [DG]	



CM³



Art. Nr.



ohne Halter

SUPERB Kombi (3T5)							
2.0 TDI 16V 4x4	11/10-05/15	CFFB	1968		0-N131	TB [DG]	
2.0 TDI 16V 4x4	11/10-05/15	CFFB	1968		0-N2061	TB [TE]	
2.0 TDI 16V 4x4	11/10-05/15	CFFB	1968		0-N2200	TB [DG]	
2.0 TDI, 2.0 TDI 4x4	10/09-05/15	CBBB	1968		0-N1046	TB [DG]	
2.0 TDI, 2.0 TDI 4x4	10/09-05/15	CFGB	1968	→ 11/2010	0-N1046	TB [DG]	
2.0 TDI, 2.0 TDI 4x4	10/09-05/15	CBBB	1968		0-N1268	TB [DG]	
2.0 TDI, 2.0 TDI 4x4	10/09-05/15	CFGB	1968		0-N131	TB [DG]	
2.0 TDI, 2.0 TDI 4x4	10/09-05/15	CBBB	1968		0-N1336	TB [DG]	
2.0 TDI, 2.0 TDI 4x4	10/09-05/15	CBBB	1968		0-N1905	TB [BT]	
2.0 TDI, 2.0 TDI 4x4	10/09-05/15	CFGB	1968		0-N2025	TB [DG]	
2.0 TDI, 2.0 TDI 4x4	10/09-05/15	CFGB	1968		0-N2061	TB [TE]	
2.0 TDI, 2.0 TDI 4x4	10/09-05/15	CFGB	1968	12/2010 →	0-N2200	TB [DG]	
1.4 TSI	10/09-05/15	CAXC	1390	⚙; ⚙	0-N1454	VB [DG]	
1.4 TSI	10/09-05/15	CAXC	1390	⚙	0-N1525	VB [BT]	S
1.4 TSI	10/09-05/15	CAXC	1390	⚙	0-N1733	VB [BT]	S
1.6 TDI	09/10-05/15	CAYC	1598		0-N1534	VB [BT]	S
1.8 TSI, 1.8 TSI 4x4	10/09-05/15	CDA, CDAB	1798		0-N1832	VB [BT]	S
1.9 TDI	10/09-11/10	BLS, BXE	1896		0-N1531	VB [BT]	S
2.0 TDI	10/09-03/10	BMP	1968		0-N1531	VB [BT]	S
2.0 TDI 16V	10/09-05/15	BKD	1968		0-N1530	VB [BT]	S
2.0 TDI 16V 4x4	11/10-05/15	CFFB	1968		0-N1534	VB [BT]	S
2.0 TDI, 2.0 TDI 16V, 2.0 TDI 4x4	10/09-05/15	BMS	1968		0-N1534	VB [BT]	S
2.0 TSI	05/10-05/15	CCZA	1984		0-N1832	VB [BT]	S
3.6 V6 4x4	10/09-05/15	CDVA	3580		0-N1715	VB [DG]	
3.6 V6 4x4	10/09-05/15	CDVA	3580		0-N2209	VB [BT]	S
YETI (5L)							
1.6 TDI	11/10-	CAYC	1598	25x160	SK-1727	BTK	
1.6 TDI	11/10-	CAYC	1598	25x160	SK-1727AQ2	BTKW	
2.0 TDI	11/09-	CFHA	1968	25x160; → 11/2010	SK-1695	BTK	
2.0 TDI	11/09-	CFHA	1968	25x160; → 11/2010	SK-1695AQ1	BTKW	
2.0 TDI	11/09-	CFHA	1968	25x160; 12/2010 →	SK-1727	BTK	
2.0 TDI	11/09-	CFHA, CFHC, CFHF, CLCA	1968	25x160; → 11/2010	SK-1727AQ2	BTKW	
2.0 TDI	11/11-	CFHC, CLCB	1968	25x160	SK-1727AQ2	BTKW	
2.0 TDI 4x4	05/09-	CBDB	1968	30x160	SK-1694	BTK	
2.0 TDI 4x4	05/09-	CBDB	1968	30x160	SK-1694AQ2	BTKW	
2.0 TDI 4x4	05/09-	CFHC, CLCB	1968	25x160	SK-1695	BTK	
2.0 TDI 4x4	05/09-	CFHC, CLCB	1968	25x160; → 11/2010	SK-1695AQ1	BTKW	
2.0 TDI 4x4	05/09-	CFHC, CLCB	1968	25x160; → 11/2010	SK-1727AQ2	BTKW	
2.0 TDI 4x4	11/09-	CEGA	1968	30x160	SK-1694	BTK	
2.0 TDI 4x4	11/09-	CEGA	1968	30x160	SK-1694AQ2	BTKW	
2.0 TDI 4x4	11/09-	CFJA	1968	25x160	SK-1695	BTK	
2.0 TDI 4x4	11/09-	CFHF	1968	25x160	SK-1695AQ1	BTKW	
2.0 TDI 4x4	11/09-	CFJA	1968	25x160; → 11/2010	SK-1695AQ1	BTKW	
2.0 TDI 4x4	11/09-	CFHA, CFHC, CFHF	1968	25x160; → 11/2010	SK-1727AQ2	BTKW	
2.0 TDI 4x4	11/09-	CFJA	1968	25x160; → 11/2010	SK-1727AQ2	BTKW	
2.0 TDI, 2.0 TDI 4x4	11/09-	CFHC, CFHF	1968	25x160	SK-1695	BTK	
1.6	04/14-	CWVA	1598		0-N2313	TB [TE]	
1.6	04/14-	CWVA	1598		0-N2381	TB [DG]	
1.6 TDI	11/10-	CAYC	1598		0-N131	TB [DG]	
1.6 TDI	11/10-	CAYC	1598		0-N2025	TB [DG]	
1.6 TDI	11/10-	CAYC	1598		0-N2061	TB [TE]	
1.6 TDI	11/10-	CAYC	1598		0-N2200	TB [DG]	
2.0 TDI	11/09-	CFHA, CLCA	1968		0-N2025	TB [DG]	
2.0 TDI 4x4	05/09-	CBDB	1968		0-N1046	TB [DG]	
2.0 TDI 4x4	05/09-	CFHC, CLCB	1968	→ 11/2010	0-N1046	TB [DG]	
2.0 TDI 4x4	05/09-	CBDB	1968		0-N1268	TB [DG]	
2.0 TDI 4x4	05/09-	CFHC, CLCB	1968		0-N131	TB [DG]	
2.0 TDI 4x4	05/09-	CBDB	1968		0-N1336	TB [DG]	
2.0 TDI 4x4	05/09-	CBDB	1968		0-N1905	TB [BT]	
2.0 TDI 4x4	05/09-	CFHC, CLCB	1968		0-N2025	TB [DG]	
2.0 TDI 4x4	05/09-	CFHC, CLCB	1968		0-N2061	TB [TE]	
2.0 TDI 4x4	05/09-	CFHC, CLCB	1968	12/2010 →	0-N2200	TB [DG]	
2.0 TDI 4x4	11/09-	CEGA	1968		0-N1046	TB [DG]	
2.0 TDI 4x4	11/09-	CFJA	1968	→ 11/2010	0-N1046	TB [DG]	
2.0 TDI 4x4	11/09-	CEGA	1968		0-N1268	TB [DG]	



CM³



Art. Nr.



ohne Halter

YETI (5L)

2.0 TDI 4x4	11/09-	CFJA	1968		0-N131	TB [DG]	
2.0 TDI 4x4	11/09-	CEGA	1968		0-N1336	TB [DG]	
2.0 TDI 4x4	11/09-	CEGA	1968		0-N1905	TB [BT]	
2.0 TDI 4x4	11/09-	CFHF	1968		0-N2025	TB [DG]	
2.0 TDI 4x4	11/09-	CFJA	1968		0-N2025	TB [DG]	
2.0 TDI 4x4	11/09-	CFJA	1968		0-N2061	TB [TE]	
2.0 TDI 4x4	11/09-	CFJA	1968	12/2010 →	0-N2200	TB [DG]	
2.0 TDI, 2.0 TDI 4x4	11/09-	CFHA, CLCA, CFHC, CFHF	1968		0-N131	TB [DG]	
2.0 TDI, 2.0 TDI 4x4	11/09-	CFHA, CLCA, CFHC, CFHF	1968		0-N2061	TB [TE]	
2.0 TDI, 2.0 TDI 4x4	11/09-	CFHA, CLCA, CFHC, CFHF	1968		0-N2200	TB [DG]	
1.2 TSI	09/09-	CBZB	1197		0-N1733	VB [BT]	S
1.2 TSI	09/09-	CBZB	1197	⚙	0-N2121	VB [DG]	
1.4 TSI	06/10-	CAXA	1390	⚙; ⚙	0-N1454	VB [DG]	
1.4 TSI	06/10-	CAXA	1390	⚙	0-N1525	VB [BT]	S
1.4 TSI	06/10-	CAXA	1390	⚙	0-N1733	VB [BT]	S
1.6 TDI	11/10-	CAYC	1598		0-N1534	VB [BT]	S
1.8 TSI 4x4	05/09-	CDAА, CDAB	1798		0-N1832	VB [BT]	S
2.0 TDI 4x4	05/09-	BMS	1968		0-N1534	VB [BT]	S
2.0 TDI, 2.0 TDI 4x4	11/09-	CFHA, CLCA, CFHC, CFHF	1968		0-N1534	VB [BT]	S

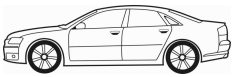

CM³



Art. Nr.



ohne Halter

OCTAVIA (1Z3)

1.4 TSi	04/10-	CFB	1390	⊗	0-N1733	VB [BT]	S
1.6	06/07-04/10	CDF	1595	⊗	0-N1733	VB [BT]	S

SUPERB

1.4 TSi	04/10-	CFB	1390	⊗	0-N1733	VB [BT]	S
---------	--------	-----	------	---	---------	---------	---



CM³



Art. Nr.



ohne Halter

CABRIO (450)							
0.6	03/00-01/04	M 160 E6AL B03, M 160.920	599			0-N2020	VB [BT]
0.8 CDI	03/01-01/04	OM 660 DE 8LA, OM 660.940	799			0-N2020	VB [BT]
CITY-COUPE (450)							
0.6	07/98-01/04	M 160 E6AL B03, M 160.920, M 160 E6AL B04, M 160.920	599			0-N2020	VB [BT]
0.8 CDI	11/99-01/04	OM 660 DE 8LA, OM 660.940	799			0-N2020	VB [BT]
FORFOUR (454)							
1.5 CDI	09/04-06/06	OM 639.939	1493			0-N2402	VB [BT] S
1.5 CDI	09/04-06/06	OM 639.939	1493			0-N2419	VB [DG]
FORTWO Cabrio (450)							
0.8 CDI	01/04-01/07	OM 660 DE 8LA, OM 660.940	799			0-N2020	VB [BT]
FORTWO Cabrio (451)							
1.0	01/07-	M 132.910	999	Baumuster: 451480; für Fahrzeuge mit Start-Stopp-Funktion		0-N2297	VB [VD]
1.0, 1.0 Brabus, 1.0 Turbo, 1.0 Turbo Brabus	01/07-	M 132.910, M 132.930	999			0-N2404	VB [BT] S
FORTWO Coupe (450)							
0.8 CDI	01/04-01/07	OM 660.940, OM 660.940	799			0-N2020	VB [BT]
FORTWO Coupe (451)							
1.0	01/07-	M 132.910	999	Baumuster: 451334		0-N2297	VB [VD]
1.0	01/07-	M 132.910	999	Baumuster: 451380		0-N2297	VB [VD]
1.0, 1.0 Brabus, 1.0 Turbo, 1.0 Turbo Brabus	01/07-	M 132.910, M 132.930	999			0-N2404	VB [BT] S



CM³



Art. Nr.



ACTYON I								
2.0 Xdi, 200 Xdi 4WD	11/05-	D20DT	1998			0-N2226	VB [BT]	S
2.3, 2.3 4x4	11/06-	G23D	2295			0-N1833	VB [TE]	
2.3, 2.3 4x4	11/06-	G23D	2295			0-N1951	VB [VD]	
2.3, 2.3 4x4	11/06-	G23D	2295			0-N2418	VB [BT]	
ACTYON SPORTS I (QJ)								
2.0 Xdi, 2.0 Xdi 2WD, 2.0 Xdi 4WD	04/07-	D20DT, D20DTR	1998			0-N2226	VB [BT]	S
ACTYON II								
2.0 XDi, 2.0 XDi 4x4	08/12-	D20DTF	1998			0-N2388	VB [BT]	S
ACTYON SPORTS II								
2.0 Xdi 2WD, 2.0 Xdi 4WD	10/12-	D20DTR	1998			0-N2388	VB [BT]	S
CHAIRMAN (HT_)								
2.3	07/97-	M 111.970, M 111.974	2295			0-N2418	VB [BT]	
2.8	07/97-	M 104.942	2797	:→005789		0-N1011	VB [BT]	S
2.8	07/97-	M 104.942	2797	:→048696		0-N1011	VB [BT]	S
ISTANA Bus								
2.9 D, 2.9 TD	10/92-05/95	OM 602.940, OM 602.980	2874	Rippenanzahl: 6		0-N1288	VB [DG]	
2.9 D, 2.9 TD	10/92-05/95	OM 602.940, OM 602.980	2874			0-N1289	VB [BT]	
ISTANA Kasten								
2.9 D	10/92-05/95	OM 602.940, OM 602.980	2874	Rippenanzahl: 6		0-N1288	VB [DG]	
2.9 D	10/92-05/95	OM 602.940, OM 602.980	2874			0-N1289	VB [BT]	
ISTANA Bus								
2.3	06/95-		2295			0-N1289	VB [BT]	
2.9 D, 2.9 TD	06/95-	OM 602.940, OM 602.980	2874	Rippenanzahl: 6		0-N1288	VB [DG]	
2.9 D, 2.9 TD	06/95-	OM 602.940, OM 602.980	2874			0-N1289	VB [BT]	
ISTANA Kasten								
2.9 D	06/95-	OM 602.940, OM 602.980	2874	Rippenanzahl: 6		0-N1288	VB [DG]	
2.9 D	06/95-	OM 602.940, OM 602.980	2874			0-N1289	VB [BT]	
KORANDO								
2.0 e-XDi, 2.0 e-XDi 4WD	11/10-	D20DTF	1998			0-N2388	VB [BT]	S
2.0 e-XDi, 2.0 e-XDi 4WD	02/12-	D20DTR	1998			0-N2388	VB [BT]	S
KORANDO (KJ)								
2.0	05/97-	E20	1998	→ 10/2002		0-N1951	VB [VD]	
2.0	05/97-	E20	1998			0-N2418	VB [BT]	
2.3	05/97-	M 111.970, M 161.970	2295			0-N1833	VB [TE]	
2.3	05/97-	M 111.970	2295	→ 02/2000		0-N1951	VB [VD]	
2.3	05/97-	M 111.970, M 161.970	2295			0-N2418	VB [BT]	
2.3	01/99-		2295	12/2002 → 09/2005		0-N1951	VB [VD]	
2.3	01/02-	M 161.970	2295	→ 09/2005		0-N1951	VB [VD]	
2.3 D	12/96-	OM 601.940	2299	Rippenanzahl: 6		0-N1288	VB [DG]	
2.3 TDiC	07/98-	MB - OM 661	2299	Rippenanzahl: 6		0-N1288	VB [DG]	
2.9 D	12/96-10/00	MB-OM 662	2874	Rippenanzahl: 6		0-N1288	VB [DG]	
2.9 TD	04/98-	MB - OM 662	2874	Rippenanzahl: 6		0-N1288	VB [DG]	
KORANDO Cabrio (KJ)								
2.3	11/97-	M 161.970	2295			0-N1833	VB [TE]	
2.3	11/97-		2295	→ 02/2000		0-N1951	VB [VD]	
2.3	11/97-	M 161.970	2295			0-N2418	VB [BT]	
2.3	02/99-		2295	12/2002 → 09/2005		0-N1951	VB [VD]	
2.3	01/02-	M 161.970	2295	→ 09/2005		0-N1951	VB [VD]	
2.9 D	11/97-	MB-OM 662	2874	Rippenanzahl: 6		0-N1288	VB [DG]	
2.9 TD	04/98-	MB - OM 662	2874	Rippenanzahl: 6		0-N1288	VB [DG]	
3.2	01/99-	M 104.995	3199	→ 11/2002		0-N1951	VB [VD]	
KYRON								
2.0 Xdi, 2.0 Xdi 4x4	05/05-	D20DT	1998			0-N2226	VB [BT]	S
2.3	01/10-	M 161.970	2295			0-N1833	VB [TE]	
2.3	01/10-	M 161.970	2295			0-N2418	VB [BT]	
2.7 Xdi	05/05-	D27DT	2696			0-N2226	VB [BT]	S
MUSSO (FJ)								
2.0	10/96-	E20	1998	→ 04/2005		0-N1951	VB [VD]	
2.0	10/96-	E20	1998			0-N2418	VB [BT]	
2.3	10/96-	M 111.970	2295			0-N1833	VB [TE]	



OPTIMAL®

SSANGYONG

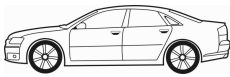

CM³



Art. Nr.



ohne Halter

MUSSO (FJ)

2.3	10/96-	M 111.970	2295	→ 11/2002	0-N1951	VB [VD]	
2.3	10/96-	M 111.970	2295		0-N2418	VB [BT]	
2.3	04/03-		2295	→ 04/2005	0-N1951	VB [VD]	
2.3 D, 2.3 TDiC Allrad	03/93-10/03	MB-OM 661, OM 601.940, OM 661.940	2299	Rippenanzahl: 6	0-N1288	VB [DG]	
2.9 D	03/96-	MB-OM 662	2874	Rippenanzahl: 6	0-N1288	VB [DG]	
2.9 TD	04/98-	MB - OM 662	2874	Rippenanzahl: 6	0-N1288	VB [DG]	

REXTON (GAB_)

2.3 RX230 4x4	05/02-	G23D	2295		0-N1833	VB [TE]	
2.3 RX230 4x4	05/02-	G23D	2295	→ 02/2006	0-N1951	VB [VD]	
2.3 RX230 4x4	05/02-	G23D	2295		0-N2418	VB [BT]	
2.7 D 4x4, 2.7 Xdi	08/04-08/06	D27DT, D27DTP	2696		0-N2226	VB [BT]	S

REXTON W

2.0 XDi, 2.0 XDi 4x4	07/12-	D20DTR	1998		0-N2388	VB [BT]	S
----------------------	--------	--------	------	--	----------------	---------	----------

RODIUS

2.7 Xdi, 2.7 Xdi 4WD	05/05-	D27DT	2696		0-N2226	VB [BT]	S
----------------------	--------	-------	------	--	----------------	---------	----------

RODIUS II

2.0 Xdi, 2.0 Xdi 4WD	07/13-	D20DTR	1998		0-N2388	VB [BT]	S
----------------------	--------	--------	------	--	----------------	---------	----------

STAVIC

2.7 270 sXDi, 2.7 270 sXDi 4x4	02/05-	D27DT	2696		0-N2226	VB [BT]	S
--------------------------------	--------	-------	------	--	----------------	---------	----------



CM³



Art. Nr.



FORESTER (SF)							
2.0	08/97-09/02	EJ20	1994	30x281; 06/2002 →	SK-1719	BTK	
2.0	06/98-09/02	EJ20	1994	27x223	SK-1712	BTK	
2.0	06/98-09/02	EJ20	1994	27x223	SK-1712AQ3	BTKW	
2.0 S Turbo	06/98-04/01	EJ20	1994	30x281; 09/1998 →	SK-1719	BTK	
2.0 S Turbo	06/98-09/02	EJ20, EJ205	1994	30x281	SK-1719AQ1	BTKW	
2.0 S Turbo	04/01-09/02	EJ205	1994	30x281; → 05/2002	SK-1719	BTK	
2.0	08/97-09/02	EJ20	1994	→ 03/1998	0-N1225	TB [DG]	
2.0	08/97-09/02	EJ20	1994	03/1998 →	0-N1225	TB [DG]	
2.0	08/97-09/02	EJ20	1994	03/1998 →	0-N1775	TB [DG]	
2.0	06/98-09/02	EJ20	1994		0-N1775	TB [DG]	
2.0 S Turbo	06/98-09/02	EJ20, EJ205	1994		0-N1777	TB [DG]	
2.0, 2.0 S Turbo	08/97-09/02	EJ20, EJ205	1994		0-N1226	TB [DG]	
2.0, 2.0 S Turbo	08/97-09/02	EJ20, EJ205	1994		0-N1767	TB [BT]	
2.0, 2.0 S Turbo	06/98-09/02	EJ20, EJ205	1994		0-N1225	TB [DG]	
2.5 AWD	07/97-05/02	EJ25D	2457		0-N1225	TB [DG]	
2.5 AWD	07/97-05/02	EJ25D	2457	Baumuster: B11	0-N1226	TB [DG]	
2.5 AWD	07/97-05/02	EJ25D	2457		0-N1767	TB [BT]	
2.0, 2.0 S Turbo	08/97-09/02	EJ20, EJ205	1994		0-N1724	VB [DG]	
2.0, 2.0 S Turbo	08/97-09/02	EJ20, EJ205	1994	Baumuster: S10	0-N2102	VB [DG]	
2.5 AWD	07/97-05/02	EJ25D	2457		0-N1724	VB [DG]	
2.5 AWD	07/97-05/02	EJ25D	2457		0-N2102	VB [DG]	
FORESTER (SG)							
2.0	09/02-	EJ20	1994	27x223	SK-1712AQ3	BTKW	
2.0 S Turbo	09/02-	EJ20	1994	30x281	SK-1719	BTK	
2.0 S Turbo	09/02-	EJ20	1994	30x281	SK-1719AQ1	BTKW	
2.0 X	09/05-	EJ204	1994	27x223	SK-1712AQ2	BTKW	
2.0 X	09/05-	EJ204	1994	30x281	SK-1721	BTK	
2.0 X	09/05-	EJ204	1994	30x281; RHT;	SK-1721AQ1	BTKW	
2.0 X	09/05-	EJ204	1994	30x281;	SK-1721AQ2	BTKW	
2.0, 2.0 X	09/02-	EJ20, EJ204	1994	27x223	SK-1712	BTK	
2.5 RX Nato AWD	11/02-08/05	EJ25	2457	27x223	SK-1712	BTK	
2.5 RX Nato AWD	11/02-08/05	EJ25	2457	27x223	SK-1712AQ3	BTKW	
2.5, 2.5 XT	12/03-	EJ25, EJ255	2457	30x281	SK-1721	BTK	
2.5, 2.5 XT	12/03-	EJ25, EJ255	2457	30x281	SK-1721AQ3	BTKW	
2.0 S Turbo, 2.0 X	09/02-	EJ20, EJ204	1994		0-N1776	TB [DG]	
2.0, 2.0 S Turbo, 2.0 X	09/02-	EJ20, EJ204	1994		0-N1225	TB [DG]	
2.0, 2.0 S Turbo, 2.0 X	09/02-	EJ20, EJ204	1994		0-N1226	TB [DG]	
2.0, 2.0 S Turbo, 2.0 X	09/02-	EJ20, EJ204	1994		0-N1767	TB [BT]	
2.0, 2.0 X	09/02-	EJ20, EJ204	1994		0-N1775	TB [DG]	
2.5 Allrad, 2.5 RX Nato AWD	11/02-08/05	EJ25, EJ25D	2457		0-N1775	TB [DG]	
2.5, 2.5 Allrad, 2.5 RX Nato AWD, 2.5 XT	11/02-08/05	EJ25, EJ255, EJ25D	2457		0-N1225	TB [DG]	
2.5, 2.5 Allrad, 2.5 RX Nato AWD, 2.5 XT	11/02-08/05	EJ25, EJ255, EJ25D	2457		0-N1226	TB [DG]	
2.5, 2.5 Allrad, 2.5 RX Nato AWD, 2.5 XT	11/02-08/05	EJ25, EJ255, EJ25D	2457		0-N1767	TB [BT]	
2.5, 2.5 XT	12/03-	EJ25, EJ255	2457		0-N1776	TB [DG]	
2.0, 2.0 S Turbo, 2.0 X	09/02-	EJ20, EJ204	1994	Baumuster: S11	0-N2102	VB [DG]	
2.0, 2.0 X	09/02-	EJ20, EJ204	1994		0-N1724	VB [DG]	
2.5 Allrad	07/05-	EJ25D	2457	→ 06/2007; Baumuster: S11	0-N2102	VB [DG]	
2.5, 2.5 Allrad, 2.5 RX Nato AWD, 2.5 XT	11/02-08/05	EJ25, EJ255, EJ25D	2457		0-N1724	VB [DG]	
2.5, 2.5 RX Nato AWD	11/02-08/05	EJ25	2457		0-N2102	VB [DG]	
2.5, 2.5 XT	01/05-	EJ255	2457	→ 11/2007; Baumuster: S11	0-N2102	VB [DG]	
FORESTER (SH)							
2.0	01/08-	EJ20	1994	30x281	SK-1721	BTK	
2.0	01/08-	EJ20	1994	30x281;	SK-1721AQ1	BTKW	
2.0	01/08-	EJ20	1994	30x281;	SK-1721AQ2	BTKW	
2.5	06/08-	EJ255	2457	30x281	SK-1721	BTK	
2.5	01/09-	EJ25	2457	27x223	SK-1712	BTK	
2.5	01/09-	EJ25	2457	27x223	SK-1712AQ1	BTKW	
2.0	01/08-	EJ20	1994		0-N1225	TB [DG]	
2.0	01/08-	EJ20	1994		0-N1226	TB [DG]	
2.0	01/08-	EJ20	1994		0-N1767	TB [BT]	
2.0	01/08-	EJ20	1994		0-N1776	TB [DG]	
2.5	06/08-	EJ25, EJ255	2457		0-N1225	TB [DG]	
2.5	06/08-	EJ25, EJ255	2457		0-N1226	TB [DG]	
2.5	06/08-	EJ25, EJ255	2457		0-N1767	TB [BT]	



CM³



Art. Nr.



FORESTER (SH)

2.5	06/08-	EJ25, EJ255	2457		0-N1776	TB [DG]	
2.0 D	09/08-	EE20Z	1998		0-N2230	VB [BT]	S
2.0 D	09/08-	EE20Z	1998		0-N2374	VB [DG]	

FORESTER (SJ)

2.0 D	03/13-	EE20Z	1998		0-N2374	VB [DG]	
-------	--------	-------	------	--	----------------	---------	--

IMPREZA Coupe (GFC)

1.6	12/96-12/00	EJ16E	1597	30x211	SK-1335	BTK	
1.6 4WD	12/96-12/00	EJ161	1597	30x211; → 01/1997	SK-1335	BTK	
1.6 4WD	12/96-12/00	EJ161	1597	27x223	SK-1712	BTK	
1.6 4WD	12/96-12/00	EJ161	1597	27x223	SK-1712AQ3	BTKW	
2.0 AWD	09/98-09/00	EJ205P	1994	30x281	SK-1719	BTK	
2.0 AWD	09/98-09/00	EJ205P	1994	30x281	SK-1719AQ1	BTKW	
2.0, 2.0 4WD	11/95-12/00	EJ20, EJ20E	1994	30x211	SK-1335	BTK	
1.6	09/98-09/00	EJ161	1597		0-N1225	TB [DG]	
1.6	09/98-09/00	EJ161	1597		0-N1767	TB [BT]	
1.6	09/98-09/00	EJ161	1597		0-N1775	TB [DG]	
1.6, 1.6 4WD	12/96-12/00	EJ161, EJ16E	1597	→ 01/1997; mit Anbaumaterial	0-N1223	TB [TE]	
1.6, 1.6 4WD	12/96-12/00	EJ161, EJ16E	1597	→ 12/1997	0-N1225	TB [DG]	
1.6, 1.6 4WD	12/96-12/00	EJ161, EJ16E	1597	12/1997 →	0-N1225	TB [DG]	
1.6, 1.6 4WD	12/96-12/00	EJ161, EJ16E	1597		0-N1226	TB [DG]	
1.6, 1.6 4WD	12/96-12/00	EJ161, EJ16E	1597	01/1997 →	0-N1767	TB [BT]	
1.6, 1.6 4WD	12/96-12/00	EJ161, EJ16E	1597	12/1997 →	0-N1775	TB [DG]	
2.0	09/98-09/00	EJ201	1994		0-N1775	TB [DG]	
2.0 4WD	12/95-12/00	EJ20	1994	→ 01/1997; mit Anbaumaterial	0-N1223	TB [TE]	
2.0 AWD, 2.0 Turbo 4WD	12/96-12/00	EJ205P, EJ20G	1994		0-N1777	TB [DG]	
2.0 Turbo 4WD	12/96-12/00	EJ20G	1994	10/1998 →	0-N1767	TB [BT]	
2.0 Turbo 4WD	12/96-12/00	EJ20G	1994	→ 10/1998	0-N1828	TB [BT]	
2.0, 2.0 4WD	11/95-12/00	EJ20, EJ20E	1994	→ 12/1997	0-N1225	TB [DG]	
2.0, 2.0 4WD	11/95-12/00	EJ20, EJ20E	1994	12/1997 →	0-N1225	TB [DG]	
2.0, 2.0 4WD	11/95-12/00	EJ20, EJ20E	1994	01/1997 →	0-N1767	TB [BT]	
2.0, 2.0 4WD	11/95-12/00	EJ20, EJ20E	1994	12/1997 →	0-N1775	TB [DG]	
2.0, 2.0 4WD, 2.0 AWD, 2.0 Turbo 4WD	11/95-12/00	EJ20, EJ201, EJ205P, EJ20E, EJ20G	1994		0-N1226	TB [DG]	
2.0, 2.0 AWD	09/98-09/00	EJ201, EJ205P	1994		0-N1767	TB [BT]	
2.0, 2.0 AWD, 2.0 Turbo 4WD	12/96-12/00	EJ201, EJ205P, EJ20G	1994		0-N1225	TB [DG]	
2.2 AWD	11/95-08/98	EJ22E	2212	01/1997 →	0-N1767	TB [BT]	
2.2, 2.2 AWD	11/95-09/00	EJ22E	2212		0-N1225	TB [DG]	
2.2, 2.2 AWD	11/95-09/00	EJ22E	2212		0-N1226	TB [DG]	
2.2, 2.2 AWD	09/98-09/00	EJ22E	2212		0-N1767	TB [BT]	
1.6, 1.6 4WD	12/96-12/00	EJ161, EJ16E	1597		0-N1724	VB [DG]	
1.6, 1.6 4WD	12/96-12/00	EJ161, EJ16E	1597	Baumuster: G10	0-N2102	VB [DG]	
2.0, 2.0 4WD, 2.0 AWD, 2.0 Turbo 4WD	11/95-12/00	EJ20, EJ201, EJ205P, EJ20E, EJ20G	1994		0-N1724	VB [DG]	
2.0, 2.0 4WD, 2.0 AWD, 2.0 Turbo 4WD	11/95-12/00	EJ20, EJ201, EJ205P, EJ20E, EJ20G	1994	Baumuster: G10	0-N2102	VB [DG]	
2.2, 2.2 AWD	11/95-09/00	EJ22E	2212		0-N1724	VB [DG]	
2.2, 2.2 AWD	11/95-09/00	EJ22E	2212		0-N2102	VB [DG]	

IMPREZA Stufenheck (GC)

1.6 i, 1.6 i 4WD	08/92-12/00	EJ16	1597	30x211; 01/1993 →	SK-1335	BTK	
1.6 i, 1.6 i 4WD	06/98-12/00	EJ161	1597	27x223	SK-1712	BTK	
1.6 i, 1.6 i 4WD	06/98-12/00	EJ161	1597	27x223	SK-1712AQ3	BTKW	
1.8	11/95-06/96	EJ18E	1820	30x211	SK-1335	BTK	
1.8 i 4WD	08/92-12/00	EJ18, EJ18E	1820	30x211; 01/1993 →	SK-1335	BTK	
2.0 AWD, 2.0 Turbo GT 4WD	06/98-12/00	EJ205, EJ205P	1994	30x281	SK-1719	BTK	
2.0 AWD, 2.0 Turbo GT 4WD	06/98-12/00	EJ205, EJ205P	1994	30x281	SK-1719AQ1	BTKW	
2.0, 2.0 i 4WD	10/95-12/00	EJ20, EJ20E	1994	30x211	SK-1335	BTK	
2.0, 2.0 i 4WD	06/98-12/00	EJ20, EJ201	1994	27x223	SK-1712	BTK	
2.0, 2.0 i 4WD	06/98-12/00	EJ20, EJ201	1994	27x223	SK-1712AQ3	BTKW	
1.6 i, 1.6 i 4WD	08/92-12/00	EJ16	1597	→ 01/1997; mit Anbaumaterial	0-N1223	TB [TE]	
1.6 i, 1.6 i 4WD	08/92-12/00	EJ16	1597	→ 12/1997	0-N1225	TB [DG]	
1.6 i, 1.6 i 4WD	08/92-12/00	EJ16	1597	12/1997 →	0-N1225	TB [DG]	
1.6 i, 1.6 i 4WD	08/92-12/00	EJ16, EJ161	1597		0-N1226	TB [DG]	
1.6 i, 1.6 i 4WD	08/92-12/00	EJ16	1597	01/1997 →	0-N1767	TB [BT]	
1.6 i, 1.6 i 4WD	08/92-12/00	EJ16	1597	12/1997 →	0-N1775	TB [DG]	
1.6 i, 1.6 i 4WD	06/98-12/00	EJ161	1597		0-N1225	TB [DG]	
1.6 i, 1.6 i 4WD	06/98-12/00	EJ161	1597		0-N1767	TB [BT]	
1.6 i, 1.6 i 4WD	06/98-12/00	EJ161	1597		0-N1775	TB [DG]	



CM³



Art. Nr.



ohne Halter

IMPREZA Stufenheck (GC)

1.8	11/95-06/96	EJ18E	1820			0-N1225	TB [DG]
1.8 i 4WD	08/92-12/00	EJ18, EJ18E	1820	→ 01/1997; mit Anbaumaterial		0-N1223	TB [TE]
1.8 i 4WD	08/92-12/00	EJ18, EJ18E	1820	→ 12/1997		0-N1225	TB [DG]
1.8 i 4WD	08/92-12/00	EJ18, EJ18E	1820	12/1997 →		0-N1225	TB [DG]
1.8 i 4WD	08/92-12/00	EJ18, EJ18E	1820	01/1997 →		0-N1767	TB [BT]
1.8 i 4WD	08/92-12/00	EJ18, EJ18E	1820	12/1997 →		0-N1775	TB [DG]
1.8, 1.8 i 4WD	08/92-12/00	EJ18, EJ18E, EJ18E	1820			0-N1226	TB [DG]
2.0 AWD, 2.0 Turbo GT 4WD	03/94-12/00	EJ20 (Turbo), EJ205, EJ205P	1994			0-N1777	TB [DG]
2.0 i 4WD	10/95-12/00	EJ20	1994	→ 01/1997; mit Anbaumaterial		0-N1223	TB [TE]
2.0 Turbo GT 4WD	03/94-12/00	EJ20 (Turbo), EJ205	1994	10/1998 →		0-N1767	TB [BT]
2.0 Turbo GT 4WD	03/94-12/00	EJ20 (Turbo), EJ205	1994	→ 10/1998		0-N1828	TB [BT]
2.0, 2.0 AWD, 2.0 i 4WD	06/98-12/00	EJ20, EJ201, EJ205P	1994			0-N1767	TB [BT]
2.0, 2.0 AWD, 2.0 i 4WD, 2.0 Turbo GT 4WD	03/94-12/00	EJ20, EJ20 (Turbo), EJ201, EJ205, EJ205P	1994			0-N1225	TB [DG]
2.0, 2.0 AWD, 2.0 i 4WD, 2.0 Turbo GT 4WD	03/94-12/00	EJ20, EJ20 (Turbo), EJ201, EJ205, EJ205P, EJ20E	1994			0-N1226	TB [DG]
2.0, 2.0 i 4WD	10/95-12/00	EJ20, EJ20E	1994	→ 12/1997		0-N1225	TB [DG]
2.0, 2.0 i 4WD	10/95-12/00	EJ20, EJ20E	1994	12/1997 →		0-N1225	TB [DG]
2.0, 2.0 i 4WD	10/95-12/00	EJ20, EJ20E	1994	01/1997 →		0-N1767	TB [BT]
2.0, 2.0 i 4WD	10/95-12/00	EJ20, EJ20E	1994	12/1997 →		0-N1775	TB [DG]
2.0, 2.0 i 4WD	06/98-12/00	EJ20, EJ201	1994			0-N1775	TB [DG]
2.2 GX AWD	11/95-09/00	EJ22, EJ22E	2212			0-N1225	TB [DG]
2.2 GX AWD	11/95-09/00	EJ22, EJ22E	2212			0-N1226	TB [DG]
2.2 GX AWD	11/95-08/98	EJ22	2212	01/1997 →		0-N1767	TB [BT]
2.2 GX AWD	09/98-09/00	EJ22E	2212			0-N1767	TB [BT]
1.6 i, 1.6 i 4WD	08/92-12/00	EJ16	1597	04/1995 →		0-N1724	VB [DG]
1.6 i, 1.6 i 4WD	08/92-12/00	EJ16	1597	04/1995 →; Baumuster: G10		0-N2102	VB [DG]
1.6 i, 1.6 i 4WD	06/98-12/00	EJ161	1597			0-N1724	VB [DG]
1.6 i, 1.6 i 4WD	06/98-12/00	EJ161	1597	Baumuster: G10		0-N2102	VB [DG]
1.8	11/95-06/96	EJ18E	1820			0-N1724	VB [DG]
1.8	11/95-06/96	EJ18E	1820			0-N2102	VB [DG]
1.8 i 4WD	08/92-12/00	EJ18, EJ18E	1820	04/1995 →		0-N1724	VB [DG]
1.8 i 4WD	08/92-12/00	EJ18, EJ18E	1820	04/1995 →		0-N2102	VB [DG]
2.0 Turbo GT 4WD	03/94-12/00	EJ20 (Turbo)	1994	04/1995 →		0-N1724	VB [DG]
2.0 Turbo GT 4WD	03/94-12/00	EJ20 (Turbo)	1994	04/1995 →; Baumuster: G10		0-N2102	VB [DG]
2.0, 2.0 AWD, 2.0 i 4WD, 2.0 Turbo GT 4WD	10/95-12/00	EJ20, EJ201, EJ205, EJ205P, EJ20E	1994			0-N1724	VB [DG]
2.0, 2.0 AWD, 2.0 i 4WD, 2.0 Turbo GT 4WD	10/95-12/00	EJ20, EJ201, EJ205, EJ205P, EJ20E	1994	Baumuster: G10		0-N2102	VB [DG]
2.2 GX AWD	11/95-09/00	EJ22, EJ22E	2212			0-N1724	VB [DG]
2.2 GX AWD	11/95-08/98	EJ22	2212			0-N2102	VB [DG]
2.2 GX AWD	09/98-09/00	EJ22E	2212			0-N2102	VB [DG]

IMPREZA Station Wagon (GF)

1.6	01/93-08/98	EJ16E	1597	30x211		SK-1335	BTK
1.6 i 4WD	08/92-12/00	EJ16	1597	30x211; 01/1993 →		SK-1335	BTK
1.6 i, 1.6 i 4WD	06/98-12/00	EJ161	1597	27x223		SK-1712	BTK
1.6 i, 1.6 i 4WD	06/98-12/00	EJ161	1597	27x223		SK-1712AQ3	BTKW
1.8	11/95-06/96	EJ18E	1820	30x211		SK-1335	BTK
1.8 i 4WD	08/92-12/00	EJ18	1820	30x211; 01/1993 →		SK-1335	BTK
2.0 16V AWD	06/98-12/00	EJ20, EJ20E	1994	27x223		SK-1712	BTK
2.0 16V AWD	06/98-12/00	EJ20, EJ20E	1994	27x223		SK-1712AQ3	BTKW
2.0 Turbo GT 4WD	06/98-12/00	EJ205	1994	30x281; 09/1998 →		SK-1719	BTK
2.0 Turbo GT 4WD	06/98-12/00	EJ205	1994	30x281		SK-1719AQ1	BTKW
2.0, 2.0 4WD	12/95-12/00	EJ20, EJ20E	1994	30x211		SK-1335	BTK
1.6 i 4WD	08/92-12/00	EJ16	1597	→ 01/1997; mit Anbaumaterial		0-N1223	TB [TE]
1.6 i, 1.6 i 4WD	06/98-12/00	EJ161	1597			0-N1225	TB [DG]
1.6 i, 1.6 i 4WD	06/98-12/00	EJ161	1597			0-N1767	TB [BT]
1.6 i, 1.6 i 4WD	06/98-12/00	EJ161	1597			0-N1775	TB [DG]
1.6, 1.6 i 4WD	08/92-12/00	EJ16, EJ16E	1597	→ 12/1997		0-N1225	TB [DG]
1.6, 1.6 i 4WD	08/92-12/00	EJ16, EJ16E	1597	12/1997 →		0-N1225	TB [DG]
1.6, 1.6 i 4WD	08/92-12/00	EJ16, EJ16E	1597	01/1997 →		0-N1767	TB [BT]
1.6, 1.6 i 4WD	08/92-12/00	EJ16, EJ16E	1597	12/1997 →		0-N1775	TB [DG]
1.6, 1.6 i, 1.6 i 4WD	08/92-12/00	EJ16, EJ161, EJ16E	1597			0-N1226	TB [DG]
1.8	11/95-06/96	EJ18E	1820			0-N1225	TB [DG]
1.8 i 4WD	08/92-12/00	EJ18	1820	→ 01/1997; mit Anbaumaterial		0-N1223	TB [TE]
1.8 i 4WD	08/92-12/00	EJ18	1820	→ 12/1997		0-N1225	TB [DG]



CM³



Art. Nr.



IMPREZA Station Wagon (GF)

1.8 i 4WD	08/92-12/00	EJ18	1820	12/1997 →	0-N1225	TB [DG]
1.8 i 4WD	08/92-12/00	EJ18	1820	01/1997 →	0-N1767	TB [BT]
1.8 i 4WD	08/92-12/00	EJ18	1820	12/1997 →	0-N1775	TB [DG]
1.8, 1.8 i 4WD	08/92-12/00	EJ18, EJ18E	1820		0-N1226	TB [DG]
2.0 4WD	12/95-12/00	EJ20		→ 01/1997; mit Anbaumaterial	0-N1223	TB [TE]
2.0 i Turbo 4WD, 2.0 Turbo GT 4WD	03/94-12/00	EJ20 (Turbo), EJ205	1994	10/1998 →	0-N1767	TB [BT]
2.0 i Turbo 4WD, 2.0 Turbo GT 4WD	03/94-12/00	EJ20 (Turbo), EJ205	1994		0-N1777	TB [DG]
2.0 i Turbo 4WD, 2.0 Turbo GT 4WD	03/94-12/00	EJ20 (Turbo), EJ205	1994	→ 10/1998	0-N1828	TB [BT]
2.0, 2.0 16V AWD	06/98-12/00	EJ20, EJ20E, EJ201	1994		0-N1767	TB [BT]
2.0, 2.0 16V AWD	06/98-12/00	EJ20, EJ20E, EJ201	1994		0-N1775	TB [DG]
2.0, 2.0 16V AWD, 2.0 4WD, 2.0 i Turbo 4WD, 2.0 Turbo GT 4WD	03/94-12/00	EJ20, EJ20 (Turbo), EJ20, EJ20E, EJ201, EJ205, EJ20E	1994		0-N1226	TB [DG]
2.0, 2.0 16V AWD, 2.0 i Turbo 4WD, 2.0 Turbo GT 4WD	03/94-12/00	EJ20 (Turbo), EJ20, EJ20E, EJ201, EJ205	1994		0-N1225	TB [DG]
2.0, 2.0 4WD	12/95-12/00	EJ20, EJ20E	1994	→ 12/1997	0-N1225	TB [DG]
2.0, 2.0 4WD	12/95-12/00	EJ20, EJ20E	1994	12/1997 →	0-N1225	TB [DG]
2.0, 2.0 4WD	12/95-12/00	EJ20, EJ20E	1994	01/1997 →	0-N1767	TB [BT]
2.0, 2.0 4WD	12/95-12/00	EJ20, EJ20E	1994	12/1997 →	0-N1775	TB [DG]
2.2 GX AWD	11/95-09/00	EJ22, EJ22E	2212		0-N1225	TB [DG]
2.2 GX AWD	11/95-09/00	EJ22, EJ22E	2212		0-N1226	TB [DG]
2.2 GX AWD	11/95-08/98	EJ22	2212	01/1997 →	0-N1767	TB [BT]
2.2 GX AWD	09/98-09/00	EJ22E	2212		0-N1767	TB [BT]
1.6 i, 1.6 i 4WD	06/98-12/00	EJ161	1597		0-N1724	VB [DG]
1.6 i, 1.6 i 4WD	06/98-12/00	EJ161	1597	Baumuster: G10	0-N2102	VB [DG]
1.6, 1.6 i 4WD	08/92-12/00	EJ16, EJ16E	1597	04/1995 →	0-N1724	VB [DG]
1.6, 1.6 i 4WD	08/92-12/00	EJ16, EJ16E	1597	04/1995 →; Baumuster: G10	0-N2102	VB [DG]
1.8	11/95-06/96	EJ18E	1820		0-N1724	VB [DG]
1.8	11/95-06/96	EJ18E	1820		0-N2102	VB [DG]
1.8 i 4WD	08/92-12/00	EJ18	1820	04/1995 →	0-N1724	VB [DG]
1.8 i 4WD	08/92-12/00	EJ18	1820	04/1995 →	0-N2102	VB [DG]
2.0 i Turbo 4WD	03/94-12/00	EJ20 (Turbo)	1994	04/1995 →	0-N1724	VB [DG]
2.0 i Turbo 4WD	03/94-12/00	EJ20 (Turbo)	1994	04/1995 →; Baumuster: G10	0-N2102	VB [DG]
2.0, 2.0 16V AWD, 2.0 4WD, 2.0 Turbo GT 4WD	12/95-12/00	EJ20, EJ20, EJ20E, EJ201, EJ205, EJ20E	1994		0-N1724	VB [DG]
2.0, 2.0 16V AWD, 2.0 4WD, 2.0 Turbo GT 4WD	12/95-12/00	EJ20, EJ20, EJ20E, EJ201, EJ205, EJ20E	1994	Baumuster: G10	0-N2102	VB [DG]
2.2 GX AWD	11/95-09/00	EJ22, EJ22E	2212		0-N1724	VB [DG]
2.2 GX AWD	11/95-08/98	EJ22	2212		0-N2102	VB [DG]
2.2 GX AWD	09/98-09/00	EJ22E	2212		0-N2102	VB [DG]

IMPREZA Schrägheck

2.0 Allrad	12/02-12/07	EJ201	1994	27x223	SK-1712	BTK
2.0 Allrad	12/02-12/07	EJ201	1994	27x223	SK-1712AQ3	BTKW
2.0 Allrad	10/05-12/07	EJ204	1994	30x281	SK-1721	BTK
2.0 Allrad	10/05-12/07	EJ204	1994	30x281; Länderausführung Südafrika;	SK-1721AQ1	BTKW
2.0 Allrad	10/05-12/07	EJ204	1994	30x281;	SK-1721AQ2	BTKW
2.5 WRX	09/05-12/07	EJ255	2457	30x281	SK-1721	BTK
2.5 WRX	09/05-12/07	EJ255	2457	30x281	SK-1721AQ3	BTKW
2.0 Allrad	12/02-12/07	EJ201, EJ204, EJ205, EJ207	1994		0-N1225	TB [DG]
2.0 Allrad	12/02-12/07	EJ201, EJ204, EJ205, EJ207	1994		0-N1226	TB [DG]
2.0 Allrad	12/02-12/07	EJ201, EJ204, EJ205, EJ207	1994		0-N1767	TB [BT]
2.0 Allrad	12/02-12/07	EJ201, EJ204, EJ205, EJ207	1994		0-N1776	TB [DG]
2.5 Allrad	12/02-09/05	EJ25	2457		0-N1225	TB [DG]
2.5 Allrad	12/02-09/05	EJ25	2457		0-N1767	TB [BT]
2.5 Allrad	12/02-09/05	EJ25	2457		0-N1775	TB [DG]
2.5 Allrad, 2.5 WRX	12/02-12/07	EJ25, EJ255	2457		0-N1226	TB [DG]
2.0 Allrad	12/02-12/07	EJ201, EJ204, EJ205, EJ207	1994		0-N1724	VB [DG]
2.0 Allrad	12/02-12/07	EJ201, EJ204, EJ205, EJ207	1994	Baumuster: G11	0-N2102	VB [DG]
2.5 Allrad	12/02-09/05	EJ25	2457		0-N1724	VB [DG]
2.5 Allrad	12/02-09/05	EJ25	2457		0-N2102	VB [DG]
2.5 WRX	09/05-12/07	EJ255	2457	→ 06/2007; Baumuster: G11	0-N2102	VB [DG]

IMPREZA Station Wagon (GG)

1.5	06/01-08/05	EL15	1498	30x281	SK-1721	BTK
1.5	06/01-08/05	EL15	1498	30x281	SK-1721AQ1	BTKW
1.6	12/00-	EJ16	1597	27x223	SK-1712	BTK
1.6	12/00-	EJ16	1597	27x223	SK-1712AQ3	BTKW



CM³



Art. Nr.



ohne Halter

IMPREZA Station Wagon (GG)							
2.0	12/00-	EJ20	1994	27x223	SK-1712	BTK	
2.0	12/00-	EJ20	1994	27x223	SK-1712AQ3	BTKW	
2.0 AWD, 2.0 R, 2.0 WRX Turbo	12/02-06/07	EJ20, EJ204, EJ205	1994	30x281	SK-1721	BTK	
2.0 AWD, 2.0 WRX Turbo	12/02-	EJ205	1994	30x281	SK-1721AQ3	BTKW	
2.0 R	09/05-06/07	EJ20, EJ204	1994	30x281;	SK-1721AQ1	BTKW	
2.0 R	09/05-06/07	EJ20, EJ204	1994	30x281;	SK-1721AQ2	BTKW	
2.0 Turbo	12/00-	EJ205	1994	30x281; → 08/2002	SK-1719	BTK	
2.0 Turbo	12/00-	EJ205	1994	30x281; → 08/2002	SK-1719AQ1	BTKW	
2.0 Turbo	12/00-	EJ205	1994	30x281; 09/2002 →	SK-1721	BTK	
2.0 Turbo	12/00-	EJ205	1994	30x281; 09/2002 →	SK-1721AQ3	BTKW	
2.5 AWD, 2.5 WRX	09/05-	EJ255, EJ257	2457	30x281	SK-1721	BTK	
2.5 AWD, 2.5 WRX	09/05-	EJ255, EJ257	2457	30x281	SK-1721AQ3	BTKW	
1.5, 1.5 AWD	06/01-08/05	EL15	1498		0-N1225	TB [DG]	
1.5, 1.5 AWD	06/01-08/05	EL15	1498		0-N1226	TB [DG]	
1.5, 1.5 AWD	06/01-08/05	EL15	1498		0-N1767	TB [BT]	
1.5, 1.5 AWD	06/01-08/05	EL15	1498		0-N1776	TB [DG]	
1.6	12/00-	EJ16	1597		0-N1225	TB [DG]	
1.6	12/00-	EJ16	1597		0-N1226	TB [DG]	
1.6	12/00-	EJ16	1597		0-N1767	TB [BT]	
1.6	12/00-	EJ16	1597		0-N1775	TB [DG]	
2.0, 2.0 AWD, 2.0 R, 2.0 Turbo, 2.0 WRX STi AWD, 2.0 WRX Turbo	12/00-06/07	EJ20, EJ20, EJ204, EJ205, EJ208	1994		0-N1225	TB [DG]	
2.0, 2.0 AWD, 2.0 R, 2.0 Turbo, 2.0 WRX STi AWD, 2.0 WRX Turbo	12/00-06/07	EJ20, EJ20, EJ204, EJ205, EJ208	1994		0-N1226	TB [DG]	
2.0, 2.0 AWD, 2.0 R, 2.0 Turbo, 2.0 WRX STi AWD, 2.0 WRX Turbo	12/00-06/07	EJ20, EJ20, EJ204, EJ205, EJ208	1994		0-N1767	TB [BT]	
2.0, 2.0 AWD, 2.0 R, 2.0 Turbo, 2.0 WRX STi AWD, 2.0 WRX Turbo	12/00-06/07	EJ20, EJ20, EJ204, EJ205, EJ208	1994		0-N1776	TB [DG]	
2.2	06/01-08/05	EJ22E	2212		0-N1225	TB [DG]	
2.2	06/01-08/05	EJ22E	2212		0-N1226	TB [DG]	
2.2	06/01-08/05	EJ22E	2212		0-N1767	TB [BT]	
2.5 AWD, 2.5 WRX	09/05-	EJ255, EJ257	2457		0-N1225	TB [DG]	
2.5 AWD, 2.5 WRX	09/05-	EJ255, EJ257	2457		0-N1226	TB [DG]	
2.5 AWD, 2.5 WRX	09/05-	EJ255, EJ257	2457		0-N1767	TB [BT]	
2.5 AWD, 2.5 WRX	09/05-	EJ255, EJ257	2457		0-N1776	TB [DG]	
1.5	06/01-08/05	EL15	1498	Baumuster: G11	0-N2102	VB [DG]	
1.5, 1.5 AWD	06/01-08/05	EL15	1498		0-N1724	VB [DG]	
1.5, 1.5 AWD	10/05-	EL15	1498	→ 06/2007; Baumuster: G11	0-N2102	VB [DG]	
1.6	12/00-	EJ16	1597		0-N1724	VB [DG]	
1.6	12/00-	EJ16	1597	Baumuster: G11	0-N2102	VB [DG]	
2.0, 2.0 AWD, 2.0 R, 2.0 Turbo, 2.0 WRX STi AWD, 2.0 WRX Turbo	12/00-06/07	EJ20, EJ20, EJ204, EJ205, EJ208	1994		0-N1724	VB [DG]	
2.0, 2.0 AWD, 2.0 R, 2.0 Turbo, 2.0 WRX STi AWD, 2.0 WRX Turbo	12/00-06/07	EJ20, EJ20, EJ204, EJ205, EJ208	1994	Baumuster: G11	0-N2102	VB [DG]	
2.2	06/01-08/05	EJ22E	2212		0-N1724	VB [DG]	
2.2	06/01-08/05	EJ22E	2212		0-N2102	VB [DG]	
2.5 AWD, 2.5 WRX	09/05-	EJ255, EJ257	2457		0-N1724	VB [DG]	
2.5 AWD, 2.5 WRX	09/05-	EJ255, EJ257	2457	→ 06/2007; Baumuster: G11	0-N2102	VB [DG]	
IMPREZA Stufenheck (GD)							
1.5, 1.5 AWD	06/01-09/05	EL15, EL15, EL154	1498	30x281	SK-1721	BTK	
1.5, 1.5 AWD	06/01-09/05	EL15, EL15, EL154	1498	30x281	SK-1721AQ1	BTKW	
1.6 AWD	12/00-	EJ16	1597	27x223	SK-1712	BTK	
1.6 AWD	12/00-	EJ16	1597	27x223	SK-1712AQ3	BTKW	
2.0	12/00-	EJ20	1994	27x223	SK-1712	BTK	
2.0	12/00-	EJ20	1994	27x223	SK-1712AQ3	BTKW	
2.0 AWD, 2.0 R, 2.0 WRX STi, 2.0 WRX Turbo	12/02-	EJ20 (Turbo), EJ204, EJ205, EJ207	1994	30x281	SK-1721	BTK	
2.0 AWD, 2.0 WRX STi, 2.0 WRX Turbo	12/02-	EJ20 (Turbo), EJ205, EJ207	1994	30x281	SK-1721AQ3	BTKW	
2.0 R	09/05-	EJ204	1994	30x281; Länderausführung Südafrika;	SK-1721AQ1	BTKW	
2.0 R	09/05-	EJ204	1994	30x281;	SK-1721AQ2	BTKW	
2.0 WRX STi, 2.0 WRX Turbo	12/00-	EJ205, EJ207	1994	30x281; → 08/2002	SK-1719	BTK	
2.0 WRX STi, 2.0 WRX Turbo	12/00-	EJ205, EJ207	1994	30x281; → 08/2002	SK-1719AQ1	BTKW	
2.0 WRX STi, 2.0 WRX Turbo	12/00-	EJ205, EJ207	1994	30x281; 09/2002 →	SK-1721	BTK	
2.0 WRX STi, 2.0 WRX Turbo	12/00-	EJ205, EJ207	1994	30x281; 09/2002 →	SK-1721AQ3	BTKW	
2.5 Allrad, 2.5 AWD	03/01-09/05	EJ251	2457	27x223	SK-1712	BTK	
2.5 Allrad, 2.5 AWD	03/01-09/05	EJ251	2457	27x223	SK-1712AQ3	BTKW	
2.5 AWD, 2.5 WRX, 2.5 WRX STi	09/05-	EJ255, EJ257	2457	30x281	SK-1721	BTK	

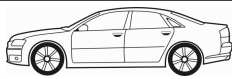
CM³

Art. Nr.



ohne Halter

IMPREZA Stufenheck (GD)

2.5 AWD, 2.5 WRX, 2.5 WRX STi	09/05-	EJ255, EJ257	2457	30x281	SK-1721AQ3	BTKW
1.5, 1.5 AWD	06/01-09/05	EL15, EL15, EL154	1498		0-N1225	TB [DG]
1.5, 1.5 AWD	06/01-09/05	EL15, EL15, EL154	1498		0-N1226	TB [DG]
1.5, 1.5 AWD	06/01-09/05	EL15, EL15, EL154	1498		0-N1767	TB [BT]
1.5, 1.5 AWD	06/01-09/05	EL15, EL15, EL154	1498		0-N1776	TB [DG]
1.6 AWD	12/00-	EJ16	1597		0-N1225	TB [DG]
1.6 AWD	12/00-	EJ16	1597		0-N1226	TB [DG]
1.6 AWD	12/00-	EJ16	1597		0-N1767	TB [BT]
1.6 AWD	12/00-	EJ16	1597		0-N1775	TB [DG]
2.0, 2.0 Allrad, 2.0 AWD, 2.0 R, 2.0 WRX STi, 2.0 WRX Turbo	12/00-09/05	EJ20, EJ20 (Turbo), EJ204, EJ205, EJ205P, EJ207	1994		0-N1225	TB [DG]
2.0, 2.0 Allrad, 2.0 AWD, 2.0 R, 2.0 WRX STi, 2.0 WRX Turbo	12/00-09/05	EJ20, EJ20 (Turbo), EJ204, EJ205, EJ205P, EJ207	1994		0-N1226	TB [DG]
2.0, 2.0 Allrad, 2.0 AWD, 2.0 R, 2.0 WRX STi, 2.0 WRX Turbo	12/00-09/05	EJ20, EJ20 (Turbo), EJ204, EJ205, EJ205P, EJ207	1994		0-N1767	TB [BT]
2.0, 2.0 Allrad, 2.0 AWD, 2.0 R, 2.0 WRX STi, 2.0 WRX Turbo	12/00-09/05	EJ20, EJ20 (Turbo), EJ204, EJ205, EJ205P, EJ207	1994		0-N1776	TB [DG]
2.2	06/01-08/05	EJ22E	2212		0-N1225	TB [DG]
2.2	06/01-08/05	EJ22E	2212		0-N1226	TB [DG]
2.2	06/01-08/05	EJ22E	2212		0-N1767	TB [BT]
2.5 Allrad, 2.5 AWD	03/01-09/05	EJ251	2457		0-N1775	TB [DG]
2.5 Allrad, 2.5 AWD, 2.5 WRX, 2.5 WRX STi	03/01-09/05	EJ251, EJ255, EJ257	2457		0-N1225	TB [DG]
2.5 Allrad, 2.5 AWD, 2.5 WRX, 2.5 WRX STi	03/01-09/05	EJ251, EJ255, EJ257	2457		0-N1226	TB [DG]
2.5 Allrad, 2.5 AWD, 2.5 WRX, 2.5 WRX STi	03/01-09/05	EJ251, EJ255, EJ257	2457		0-N1767	TB [BT]
2.5 AWD, 2.5 WRX, 2.5 WRX STi	09/05-	EJ255, EJ257	2457		0-N1776	TB [DG]
1.5, 1.5 AWD	10/05-	EL15	1498		0-N1724	VB [DG]
1.5, 1.5 AWD	10/05-	EL15	1498	→ 06/2007; Baumuster: G11	0-N2102	VB [DG]
1.6 AWD	12/00-	EJ16	1597		0-N1724	VB [DG]
1.6 AWD	12/00-	EJ16	1597	Baumuster: G11	0-N2102	VB [DG]
2.0, 2.0 Allrad, 2.0 AWD, 2.0 R, 2.0 WRX STi, 2.0 WRX Turbo	12/00-09/05	EJ20, EJ20 (Turbo), EJ204, EJ205, EJ205P, EJ207	1994		0-N1724	VB [DG]
2.0, 2.0 Allrad, 2.0 AWD, 2.0 R, 2.0 WRX STi, 2.0 WRX Turbo	12/00-09/05	EJ20, EJ20 (Turbo), EJ204, EJ205, EJ205P, EJ207	1994	Baumuster: G11	0-N2102	VB [DG]
2.2	06/01-08/05	EJ22E	2212		0-N1724	VB [DG]
2.2	06/01-08/05	EJ22E	2212		0-N2102	VB [DG]
2.5 Allrad	12/02-09/05	EJ251	2457	Baumuster: G11	0-N2102	VB [DG]
2.5 Allrad, 2.5 AWD, 2.5 WRX, 2.5 WRX STi	03/01-09/05	EJ251, EJ255, EJ257	2457		0-N1724	VB [DG]
2.5 AWD	03/01-09/05	EJ251	2457		0-N2102	VB [DG]
2.5 AWD, 2.5 WRX, 2.5 WRX STi	09/05-	EJ255, EJ257	2457	→ 06/2007; Baumuster: G11	0-N2102	VB [DG]

IMPREZA Schrägheck (GR, GH, G3)

1.5, 1.5 Allrad	02/08-	EL15	1498	30x281	SK-1721	BTK
1.5, 1.5 Allrad	02/08-	EL15	1498	30x281	SK-1721AQ1	BTKW
2.0 Allrad	01/08-	EJ204	1994	30x281	SK-1721	BTK
2.5 Allrad, 2.5 STi CS400, 2.5 WRX S AWD	01/08-12/10	EJ255, EJ257	2457	30x281	SK-1721	BTK
2.5 Allrad, 2.5 STi CS400, 2.5 WRX S AWD	01/08-12/10	EJ255, EJ257	2457	30x281	SK-1721AQ3	BTKW
1.5, 1.5 Allrad	02/08-	EL15	1498		0-N1225	TB [DG]
1.5, 1.5 Allrad	02/08-	EL15	1498		0-N1226	TB [DG]
1.5, 1.5 Allrad	02/08-	EL15	1498		0-N1767	TB [BT]
1.5, 1.5 Allrad	02/08-	EL15	1498		0-N1776	TB [DG]
2.0, 2.0 Allrad	01/08-	EJ204	1994		0-N1225	TB [DG]
2.0, 2.0 Allrad	01/08-	EJ204	1994		0-N1226	TB [DG]
2.0, 2.0 Allrad	01/08-	EJ204	1994		0-N1767	TB [BT]
2.0, 2.0 Allrad	01/08-	EJ204	1994		0-N1776	TB [DG]
2.5, 2.5 Allrad	01/08-	EJ255, EJ257	2457		0-N1225	TB [DG]
2.5, 2.5 Allrad	01/08-	EJ255, EJ257	2457		0-N1767	TB [BT]
2.5, 2.5 Allrad	01/08-	EJ255, EJ257	2457		0-N1776	TB [DG]
2.5, 2.5 Allrad, 2.5 STi CS400	01/08-	EJ255, EJ257	2457		0-N1226	TB [DG]
2.0 D Allrad	01/09-	EE20Z	1998		0-N2230	VB [BT]
2.0 D Allrad	01/09-	EE20Z	1998		0-N2374	VB [DG]

IMPREZA Stufenheck (GR)

1.5, 1.5 Allrad	02/08-	EL15	1498	30x281	SK-1721	BTK
1.5, 1.5 Allrad	02/08-	EL15	1498	30x281	SK-1721AQ1	BTKW

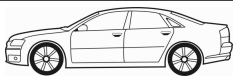

CM³



Art. Nr.



IMPREZA Stufenheck (GR)

2.0 AWD	01/11-	EJ204	1994	30x281	SK-1721	BTK
2.5 WRX STI AWD	01/11-	EJ257	2457	30x281	SK-1721	BTK
2.5 WRX STI AWD	01/11-	EJ257	2457	30x281	SK-1721AQ3	BTKW
1.5, 1.5 Allrad	02/08-	EL15	1498		0-N1225	TB [DG]
1.5, 1.5 Allrad	02/08-	EL15	1498		0-N1226	TB [DG]
1.5, 1.5 Allrad	02/08-	EL15	1498		0-N1767	TB [BT]
1.5, 1.5 Allrad	02/08-	EL15	1498		0-N1776	TB [DG]
2.0 AWD	01/11-	EJ204	1994	Baumuster: G12	0-N1226	TB [DG]
2.5 WRX STI AWD	01/11-	EJ257	2457		0-N1226	TB [DG]

JUSTY I (KAD)

1000, 1000 4WD	11/84-10/95	EF10	998		0-N1071	TB [TE]
1200, 1200 4WD	10/86-10/95	EF12	1190		0-N1244	TB [TE]

JUSTY II (JMA, MS)

1.3 4x4	04/01-11/03	G13BB	1298	25.4x89	SK-1519	BTK
1.3 4x4	04/01-11/03	G13BB	1298	25.4x97	SK-1564	BTK
1.3 GX 4x4	10/95-11/03	EF13	1298	25.4x89; 01/1997 →	SK-1519	BTK
1.3 GX 4x4	10/95-11/03	EF13	1298	19x89; → 09/2000	SK-1563	BTK
1.3 4x4, 1.3 GX 4x4	10/95-11/03	EF13, G13BB	1298		0-N916	TB [TE]

LEGACY I (BC)

1.6	05/89-12/93	EJ16	1597	30x211	SK-1335	BTK
1800, 1800 4WD	01/89-12/93	EJ18 SPI	1820	30x211; 05/1989 →	SK-1335	BTK
2.0, 2.0 GL	08/91-12/93	EJ20E	1994	30x211	SK-1335	BTK
2000 4WD	08/91-07/94	EJ20 EMPI	1994	30x211; → 12/1993	SK-1335	BTK
2200 4WD	01/89-07/94	EJ22 EMPI	2212	30x211; 05/1989 →	SK-1335	BTK
1.6	05/89-12/93	EJ16	1597		0-N1225	TB [DG]
1.6	05/89-12/93	EJ16	1597		0-N1226	TB [DG]
1800 4WD	01/89-09/91	EJ18 SPI	1820	mit Anbaumaterial	0-N1223	TB [TE]
1800, 1800 4WD	01/89-12/93	EJ18 SPI	1820		0-N1225	TB [DG]
1800, 1800 4WD	01/89-12/93	EJ18 SPI	1820		0-N1226	TB [DG]
2.0, 2.0 GL, 2000 4WD, 2000 Turbo 4WD	08/91-07/94	EJ20 EMPI, EJ20E, EJ20-GN	1994		0-N1225	TB [DG]
2.0, 2.0 GL, 2000 4WD, 2000 Turbo 4WD	08/91-07/94	EJ20 EMPI, EJ20E, EJ20-GN	1994		0-N1226	TB [DG]
2000 4WD	08/91-07/94	EJ20 EMPI	1994	mit Anbaumaterial	0-N1223	TB [TE]
2000 Turbo 4WD	05/92-07/94	EJ20-GN	1994		0-N1777	TB [DG]
2000 Turbo 4WD	05/92-07/94	EJ20-GN	1994		0-N1828	TB [BT]
2200 4WD	01/89-07/94	EJ22 EMPI	2212	mit Anbaumaterial	0-N1223	TB [TE]
2200 4WD	01/89-07/94	EJ22 EMPI	2212		0-N1225	TB [DG]
2200 4WD	01/89-07/94	EJ22 EMPI	2212		0-N1226	TB [DG]

LEGACY I Station Wagon (BC, BJF)

1.6 GL	05/89-12/93	EJ16	1597	30x211	SK-1335	BTK
1800, 1800 4WD	01/89-07/94	EJ18 SPI	1820	30x211; 05/1989 →	SK-1335	BTK
2.2	05/89-10/91	EJ22	2212	30x211	SK-1335	BTK
2000, 2000 4WD	09/91-07/94	EJ20 EMPI	1994	30x211	SK-1335	BTK
2200 Super 4WD	01/89-07/94	EJ22 EMPI	2212	30x211; 05/1989 →	SK-1335	BTK
1.6 GL	05/89-12/93	EJ16	1597		0-N1225	TB [DG]
1.6 GL	05/89-12/93	EJ16	1597		0-N1226	TB [DG]
1800 4WD	01/89-07/94	EJ18 SPI	1820	mit Anbaumaterial	0-N1223	TB [TE]
1800, 1800 4WD	01/89-07/94	EJ18 SPI	1820		0-N1225	TB [DG]
1800, 1800 4WD	01/89-07/94	EJ18 SPI	1820		0-N1226	TB [DG]
2.2, 2200 Super 4WD	01/89-07/94	EJ22, EJ22 EMPI	2212		0-N1225	TB [DG]
2.2, 2200 Super 4WD	01/89-07/94	EJ22, EJ22 EMPI	2212		0-N1226	TB [DG]
2000 Turbo Super 4WD	05/92-07/94	EJ20-GN	1994		0-N1777	TB [DG]
2000 Turbo Super 4WD	05/92-07/94	EJ20-GN	1994		0-N1828	TB [BT]
2000, 2000 4WD	09/91-07/94	EJ20 EMPI	1994	mit Anbaumaterial	0-N1223	TB [TE]
2000, 2000 4WD, 2000 Turbo Super 4WD	09/91-07/94	EJ20 EMPI, EJ20-GN	1994		0-N1225	TB [DG]
2000, 2000 4WD, 2000 Turbo Super 4WD	09/91-07/94	EJ20 EMPI, EJ20-GN	1994		0-N1226	TB [DG]
2200 Super 4WD	01/89-07/94	EJ22 EMPI	2212	mit Anbaumaterial	0-N1223	TB [TE]

LEGACY II (BD, BG)

1.8 AWD	05/96-09/98	EJ18E	1820	30x211	SK-1335	BTK
2.0 i, 2.0 i 4WD	09/94-03/99	EJ20, EJ20E	1994	30x211	SK-1335	BTK
2.2 i 4WD	09/94-03/99	EJ22 EMPI	2212	30x211	SK-1335	BTK
1.8 AWD	05/96-09/98	EJ18E	1820	→ 04/1998	0-N1225	TB [DG]
1.8 AWD	05/96-09/98	EJ18E	1820	04/1998 →	0-N1225	TB [DG]
1.8 AWD	05/96-09/98	EJ18E	1820		0-N1226	TB [DG]



CM³



Art. Nr.



LEGACY II (BD, BG)

1.8 AWD	05/96-09/98	EJ18E	1820	01/1997 →	0-N1767	TB [BT]
1.8 AWD	05/96-09/98	EJ18E	1820	04/1998 →	0-N1775	TB [DG]
2.0 i, 2.0 i 4WD	09/94-03/99	EJ20, EJ20E	1994	→ 01/1997; mit Anbaumaterial	0-N1223	TB [TE]
2.0 i, 2.0 i 4WD	09/94-03/99	EJ20, EJ20E	1994	→ 04/1998	0-N1225	TB [DG]
2.0 i, 2.0 i 4WD	09/94-03/99	EJ20, EJ20E	1994	04/1998 →	0-N1225	TB [DG]
2.0 i, 2.0 i 4WD	09/94-03/99	EJ20, EJ20E	1994		0-N1226	TB [DG]
2.0 i, 2.0 i 4WD	09/94-03/99	EJ20, EJ20E	1994	01/1997 →	0-N1767	TB [BT]
2.0 i, 2.0 i 4WD	09/94-03/99	EJ20, EJ20E	1994	04/1998 →	0-N1775	TB [DG]
2.2 i 4WD	09/94-03/99	EJ22 EMPI	2212	→ 01/1997; mit Anbaumaterial	0-N1223	TB [TE]
2.2 i 4WD	09/94-03/99	EJ22 EMPI	2212	04/1998 →	0-N1775	TB [DG]
2.2, 2.2 i 4WD	07/94-03/99	EJ22, EJ22 EMPI	2212		0-N1225	TB [DG]
2.2, 2.2 i 4WD	07/94-03/99	EJ22, EJ22 EMPI	2212		0-N1226	TB [DG]
2.2, 2.2 i 4WD	07/94-03/99	EJ22, EJ22 EMPI	2212	01/1997 →	0-N1767	TB [BT]
2.5 i 4WD	06/96-03/99	EJ25D	2457	Baumuster: B11	0-N1225	TB [DG]
2.5 i 4WD	06/96-03/99	EJ25D	2457	Baumuster: B11	0-N1226	TB [DG]
2.5 i 4WD	06/96-03/99	EJ25D	2457	Baumuster: B11	0-N1767	TB [BT]
1.8 AWD	05/96-09/98	EJ18E	1820		0-N1724	VB [DG]
1.8 AWD	05/96-09/98	EJ18E	1820		0-N2102	VB [DG]
2.0 i, 2.0 i 4WD	09/94-03/99	EJ20, EJ20E	1994	Baumuster: B11	0-N1724	VB [DG]
2.0 i, 2.0 i 4WD	09/94-03/99	EJ20, EJ20E	1994	Baumuster: B11	0-N2102	VB [DG]
2.2 i 4WD	06/96-03/99	EJ22 EMPI	2212		0-N1724	VB [DG]
2.2 i 4WD	06/96-03/99	EJ22E	2212		0-N2102	VB [DG]
2.2, 2.2 i 4WD	07/94-03/99	EJ22, EJ22 EMPI	2212	04/1995 →	0-N1724	VB [DG]
2.2, 2.2 i 4WD	07/94-03/99	EJ22E	2212	04/1995 →	0-N2102	VB [DG]
2.5 i 4WD	06/96-03/99	EJ25D	2457	Baumuster: B11	0-N1724	VB [DG]
2.5 i 4WD	06/96-03/99	EJ25D	2457		0-N2102	VB [DG]

LEGACY II Station Wagon (BD, BG)

2.0 i, 2.0 i 4WD	09/94-11/98	EJ20, EJ20 EMPI	1994	30x211	SK-1335	BTK
2.2 i 4WD	02/94-12/98	EJ22 EMPI	2212	30x211	SK-1335	BTK
2.0 i, 2.0 i 4WD	09/94-11/98	EJ20, EJ20 EMPI	1994	→ 01/1997; mit Anbaumaterial	0-N1223	TB [TE]
2.0 i, 2.0 i 4WD	09/94-11/98	EJ20, EJ20 EMPI	1994	→ 04/1998	0-N1225	TB [DG]
2.0 i, 2.0 i 4WD	09/94-11/98	EJ20, EJ20 EMPI	1994	04/1998 →	0-N1225	TB [DG]
2.0 i, 2.0 i 4WD	09/94-11/98	EJ20, EJ20 EMPI	1994		0-N1226	TB [DG]
2.0 i, 2.0 i 4WD	09/94-11/98	EJ20, EJ20 EMPI	1994	01/1997 →	0-N1767	TB [BT]
2.0 i, 2.0 i 4WD	09/94-11/98	EJ20, EJ20 EMPI	1994	04/1998 →	0-N1775	TB [DG]
2.2 i 4WD	02/94-12/98	EJ22 EMPI	2212	→ 01/1997; mit Anbaumaterial	0-N1223	TB [TE]
2.2 i 4WD	02/94-12/98	EJ22 EMPI	2212		0-N1225	TB [DG]
2.2 i 4WD	02/94-12/98	EJ22 EMPI	2212		0-N1226	TB [DG]
2.2 i 4WD	02/94-12/98	EJ22 EMPI	2212	01/1997 →	0-N1767	TB [BT]
2.5 i 4WD	06/96-11/98	EJ25D	2457		0-N1225	TB [DG]
2.5 i 4WD	06/96-11/98	EJ25D	2457		0-N1226	TB [DG]
2.5 i 4WD	06/96-11/98	EJ25D	2457		0-N1767	TB [BT]
2.0 i, 2.0 i 4WD	09/94-11/98	EJ20, EJ20 EMPI	1994	Baumuster: B11	0-N1724	VB [DG]
2.0 i, 2.0 i 4WD	09/94-11/98	EJ20, EJ20 EMPI	1994	Baumuster: B11	0-N2102	VB [DG]
2.2 i 4WD	02/94-12/98	EJ22 EMPI	2212	04/1995 →	0-N1724	VB [DG]
2.2 i 4WD	02/94-12/98	EJ22E	2212	04/1995 →	0-N2102	VB [DG]
2.2 i 4WD	06/96-11/98	EJ22 EMPI	2212		0-N1724	VB [DG]
2.2 i 4WD	06/96-11/98	EJ22E	2212		0-N2102	VB [DG]
2.5 i 4WD	06/96-11/98	EJ25D	2457	Baumuster: B11	0-N1724	VB [DG]
2.5 i 4WD	06/96-11/98	EJ25D	2457		0-N2102	VB [DG]

LEGACY III (BE, BH)

2.0	04/99-08/03	EJ20	1994	27x223; Baumuster: Legacy	SK-1712	BTK
2.0	04/99-08/03	EJ20	1994	27x223; Baumuster: Outback	SK-1712	BTK
2.0	04/99-08/03	EJ20	1994	27x223; Baumuster: Outback	SK-1712AQ1	BTKW
2.0	04/99-08/03	EJ20	1994	27x223; Baumuster: Outback	SK-1712AQ2	BTKW
2.0	04/99-08/03	EJ20	1994	27x223; Baumuster: Legacy	SK-1712AQ3	BTKW
2.5	10/98-08/03	EJ25	2457	27x223	SK-1712	BTK
2.5	10/98-08/03	EJ25	2457	27x223	SK-1712AQ3	BTKW
2.0	04/99-08/03	EJ20	1994		0-N1225	TB [DG]
2.0	04/99-08/03	EJ20	1994		0-N1226	TB [DG]
2.0	04/99-08/03	EJ20	1994		0-N1767	TB [BT]
2.0	04/99-08/03	EJ20	1994		0-N1775	TB [DG]
2.0 AWD, 2.0 RSK AWD	08/00-08/03	EJ205P, EJ206	1994	Baumuster: B12	0-N1225	TB [DG]
2.0 AWD, 2.0 RSK AWD	08/00-08/03	EJ205P, EJ206	1994	Baumuster: B12	0-N1226	TB [DG]



CM³



Art. Nr.



LEGACY III (BE, BH)							
2.0 AWD, 2.0 RSK AWD	08/00-08/03	EJ205P, EJ206	1994	Baumuster: B12	0-N1767	TB [BT]	
2.0 AWD, 2.0 RSK AWD	08/00-08/03	EJ205P, EJ206	1994	Baumuster: B12	0-N1776	TB [DG]	
2.5	10/98-08/03	EJ25	2457		0-N1225	TB [DG]	
2.5	10/98-08/03	EJ25	2457		0-N1226	TB [DG]	
2.5	10/98-08/03	EJ25	2457		0-N1767	TB [BT]	
2.5	10/98-08/03	EJ25	2457		0-N1775	TB [DG]	
2.0, 2.0 AWD, 2.0 RSK AWD	04/99-08/03	EJ20, EJ205P, EJ206	1994	Baumuster: B12	0-N1724	VB [DG]	
2.0, 2.0 AWD, 2.0 RSK AWD	04/99-08/03	EJ20, EJ205P, EJ206	1994	Baumuster: B12	0-N2102	VB [DG]	
2.5	10/98-08/03	EJ25	2457	Baumuster: B12	0-N1724	VB [DG]	
2.5	10/98-08/03	EJ25	2457	Baumuster: B12	0-N2102	VB [DG]	
3.0 H6 AWD	08/00-08/03	EZ30	3000		0-N2182	VB [BT]	S

LEGACY III Station Wagon (BE, BH)							
2.0	12/98-08/03	EJ20	1994	27x223	SK-1712	BTK	
2.0	12/98-08/03	EJ20	1994	27x223	SK-1712AQ3	BTKW	
2.0 RSK AWD	08/00-08/03	EJ206	1994	30x281; → 08/2002	SK-1719	BTK	
2.5	12/98-08/03	EJ25	2457	27x223	SK-1712	BTK	
2.5	12/98-08/03	EJ25	2457	27x223	SK-1712AQ3	BTKW	
2.0	12/98-08/03	EJ20	1994		0-N1225	TB [DG]	
2.0	12/98-08/03	EJ20	1994		0-N1226	TB [DG]	
2.0	12/98-08/03	EJ20	1994		0-N1767	TB [BT]	
2.0	12/98-08/03	EJ20	1994		0-N1775	TB [DG]	
2.0 AWD, 2.0 RSK AWD	08/00-08/03	EJ205P, EJ206	1994	Baumuster: B12	0-N1225	TB [DG]	
2.0 AWD, 2.0 RSK AWD	08/00-08/03	EJ205P, EJ206	1994	Baumuster: B12	0-N1226	TB [DG]	
2.0 AWD, 2.0 RSK AWD	08/00-08/03	EJ205P, EJ206	1994	Baumuster: B12	0-N1767	TB [BT]	
2.0 AWD, 2.0 RSK AWD	08/00-08/03	EJ205P, EJ206	1994	Baumuster: B12	0-N1776	TB [DG]	
2.5	12/98-08/03	EJ25	2457		0-N1225	TB [DG]	
2.5	12/98-08/03	EJ25	2457		0-N1226	TB [DG]	
2.5	12/98-08/03	EJ25	2457		0-N1767	TB [BT]	
2.5	12/98-08/03	EJ25	2457		0-N1775	TB [DG]	
2.0, 2.0 AWD, 2.0 RSK AWD	12/98-08/03	EJ20, EJ205P, EJ206	1994	Baumuster: B12	0-N1724	VB [DG]	
2.0, 2.0 AWD, 2.0 RSK AWD	12/98-08/03	EJ20, EJ205P, EJ206	1994	Baumuster: B12	0-N2102	VB [DG]	
2.5	12/98-08/03	EJ25	2457	Baumuster: B12	0-N1724	VB [DG]	
2.5	12/98-08/03	EJ25	2457	Baumuster: B12	0-N2102	VB [DG]	
3.0 H6 AWD	08/00-08/03	EZ30	3000		0-N2182	VB [BT]	S

LEGACY IV (BL, BP)							
2.0	09/03-	EJ20	1994	27x223	SK-1712	BTK	
2.0	09/03-	EJ20	1994	27x223; Länderausführung Iran, Israel, Saudi Arabien, Vereinigte Arabische Emirate	SK-1712AQ1	BTKW	
2.0	09/03-	EJ20	1994	27x223; nicht für Länderausführung Iran, Israel, Saudi Arabien, Vereinigte Arabische Emirate	SK-1712AQ2	BTKW	
2.0 R	09/07-	EJ204	1994	30x281; Länderausführung Iran, Israel, Saudi Arabien, Vereinigte Arabische Emirate; ; Baumuster: I-2008	SK-1721AQ1	BTKW	
2.0 R	09/07-	EJ204	1994	30x281; Länderausführung Südafrika; ; Baumuster: I-2008	SK-1721AQ1	BTKW	
2.0 R	09/07-	EJ204	1994	30x281; LHT	SK-1721AQ1	BTKW	
2.0 R	09/07-	EJ204	1994	30x281; →2005	SK-1721AQ2	BTKW	
2.0 R	09/07-	EJ204	1994	30x281; →2008;	SK-1721AQ2	BTKW	
2.0 R	09/07-	EJ204	1994	30x281; RHT	SK-1721AQ2	BTKW	
2.0, 2.0 R	06/05-	EJ20, EJ204	1994	30x281	SK-1721	BTK	
2.5, 2.5 i	09/03-	EJ25	2457	27x223	SK-1712	BTK	
2.5, 2.5 i	09/03-	EJ25	2457	27x223; Länderausführung Iran, Israel, Saudi Arabien, Vereinigte Arabische Emirate	SK-1712AQ1	BTKW	
2.5, 2.5 i	09/03-	EJ25	2457	27x223; Länderausführung Südafrika	SK-1712AQ1	BTKW	
2.5, 2.5 i	09/03-	EJ25	2457	27x223; Länderausführung Südafrika	SK-1712AQ2	BTKW	
2.5, 2.5 i	09/03-	EJ25	2457	27x223; nicht für Länderausführung Iran, Israel, Saudi Arabien, Vereinigte Arabische Emirate	SK-1712AQ2	BTKW	
2.0	09/03-	EJ20	1994		0-N1225	TB [DG]	
2.0	09/03-	EJ20	1994		0-N1226	TB [DG]	
2.0	09/03-	EJ20	1994		0-N1767	TB [BT]	
2.0	09/03-	EJ20	1994		0-N1775	TB [DG]	
2.0, 2.0 R	06/05-	EJ20, EJ204, EJ20Y	1994	Baumuster: B13	0-N1225	TB [DG]	
2.0, 2.0 R	06/05-	EJ20, EJ204, EJ20Y	1994	Baumuster: B13	0-N1226	TB [DG]	
2.0, 2.0 R	06/05-	EJ20, EJ204, EJ20Y	1994	Baumuster: B13	0-N1767	TB [BT]	
2.0, 2.0 R	06/05-	EJ20, EJ204, EJ20Y	1994	Baumuster: B13	0-N1776	TB [DG]	

CM³

Art. Nr.

**LEGACY IV (BL, BP)**

2.5, 2.5 i	09/03-	EJ25	2457	Baumuster: B13	0-N1225	TB [DG]	
2.5, 2.5 i	09/03-	EJ25	2457	Baumuster: B13	0-N1226	TB [DG]	
2.5, 2.5 i	09/03-	EJ25	2457	Baumuster: B13	0-N1767	TB [BT]	
2.5, 2.5 i	09/03-	EJ25	2457	Baumuster: B13	0-N1775	TB [DG]	
2.0 D	02/08-	EE20Z	1998		0-N2230	VB [BT]	S
2.0 D	02/08-	EE20Z	1998		0-N2374	VB [DG]	
2.0, 2.0 R	09/03-	EJ20, EJ204, EJ20Y	1994	Baumuster: B13	0-N1724	VB [DG]	
2.0, 2.0 R	09/03-	EJ20, EJ204, EJ20Y	1994	Baumuster: B13	0-N2102	VB [DG]	
2.5, 2.5 i	09/03-	EJ25	2457	Baumuster: B13	0-N1724	VB [DG]	
2.5, 2.5 i	09/03-	EJ25	2457	Baumuster: B13	0-N2102	VB [DG]	
3.0 R	09/03-	EZ30	3000		0-N2182	VB [BT]	S

LEGACY IV Station Wagon (BL, BP, B13_)

2.0	09/03-	EJ20	1994	27x223	SK-1712	BTK	
2.0	09/03-	EJ20	1994	27x223; Länderausführung Iran, Israel, Saudi Arabien, Vereinigte Arabische Emirate	SK-1712AQ1	BTKW	
2.0	09/03-	EJ20	1994	27x223; nicht für Länderausführung Iran, Israel, Saudi Arabien, Vereinigte Arabische Emirate	SK-1712AQ2	BTKW	
2.0 R	09/07-	EJ204	1994	30x281; Länderausführung Iran, Israel, Saudi Arabien, Vereinigte Arabische Emirate;	SK-1721AQ1	BTKW	
2.0 R	09/07-	EJ204	1994	30x281; Länderausführung Südafrika;	SK-1721AQ1	BTKW	
2.0 R	09/07-	EJ204	1994	30x281;	SK-1721AQ2	BTKW	
2.0, 2.0 R	06/05-	EJ20, EJ204	1994	30x281	SK-1721	BTK	
2.5	09/03-	EJ25	2457	27x223	SK-1712AQ1	BTKW	
2.5	09/03-	EJ25	2457	27x223	SK-1712AQ2	BTKW	
2.5 i	01/08-	EJ25	2457	27x223	SK-1712	BTK	
2.5 i	01/08-	EJ25	2457	27x223; Länderausführung Iran, Israel, Saudi Arabien, Vereinigte Arabische Emirate	SK-1712AQ1	BTKW	
2.5 i	01/08-	EJ25	2457	27x223; Länderausführung Südafrika	SK-1712AQ1	BTKW	
2.5 i	01/08-	EJ25	2457	27x223; nicht für Länderausführung Iran, Israel, Saudi Arabien, Vereinigte Arabische Emirate	SK-1712AQ2	BTKW	
2.5 i	01/08-	EJ25	2457	27x223; nicht für Länderausführung Südafrika	SK-1712AQ2	BTKW	
2.0	09/03-	EJ20	1994		0-N1225	TB [DG]	
2.0	09/03-	EJ20	1994		0-N1226	TB [DG]	
2.0	09/03-	EJ20	1994		0-N1767	TB [BT]	
2.0	09/03-	EJ20	1994		0-N1775	TB [DG]	
2.0, 2.0 R	06/05-	EJ20, EJ204, EJ20Y	1994	Baumuster: B13	0-N1225	TB [DG]	
2.0, 2.0 R	06/05-	EJ20, EJ204, EJ20Y	1994	Baumuster: B13	0-N1226	TB [DG]	
2.0, 2.0 R	06/05-	EJ20, EJ204, EJ20Y	1994	Baumuster: B13	0-N1767	TB [BT]	
2.0, 2.0 R	06/05-	EJ20, EJ204, EJ20Y	1994	Baumuster: B13	0-N1776	TB [DG]	
2.5	09/03-	EJ25	2457	Baumuster: B13	0-N1225	TB [DG]	
2.5	09/03-	EJ25	2457	Baumuster: B13	0-N1226	TB [DG]	
2.5	09/03-	EJ25	2457	Baumuster: B13	0-N1767	TB [BT]	
2.5	09/03-	EJ25	2457	Baumuster: B13	0-N1775	TB [DG]	
2.5 i	01/08-	EJ25	2457	05/2009 →; Baumuster: B14	0-N1225	TB [DG]	
2.5 i	01/08-	EJ25	2457	05/2009 →; Baumuster: B14	0-N1226	TB [DG]	
2.5 i	01/08-	EJ25	2457	05/2009 →; Baumuster: B14	0-N1767	TB [BT]	
2.5 i	01/08-	EJ25	2457	05/2009 →; Baumuster: B14	0-N1775	TB [DG]	
2.0 D	02/08-	EE20Z	1998		0-N2230	VB [BT]	S
2.0 D	02/08-	EE20Z	1998		0-N2374	VB [DG]	
2.0, 2.0 R	09/03-	EJ20, EJ204, EJ20Y	1994	Baumuster: B13	0-N1724	VB [DG]	
2.0, 2.0 R	09/03-	EJ20, EJ204, EJ20Y	1994	Baumuster: B13	0-N2102	VB [DG]	
2.5	09/03-	EJ25	2457	Baumuster: B13	0-N1724	VB [DG]	
2.5	09/03-	EJ25	2457	Baumuster: B13	0-N2102	VB [DG]	
2.5 i	01/08-	EJ25	2457	→ 05/2009; Baumuster: B13	0-N2102	VB [DG]	
3.0 R	09/03-	EZ30	3000		0-N2182	VB [BT]	S

LEGACY V (BM, BR)

2.0 i	09/09-	EJ204	1994	30x281	SK-1721	BTK	
2.5 GT	07/10-	EJ255	2457	30x281	SK-1721	BTK	
2.5 i	09/09-	EJ253	2457	27x223	SK-1712	BTK	
2.5 i	09/09-	EJ253	2457	27x223	SK-1712AQ1	BTKW	
2.0 i	09/09-	EJ204	1994	Baumuster: B14	0-N1225	TB [DG]	
2.0 i	09/09-	EJ204	1994	Baumuster: B14	0-N1226	TB [DG]	
2.0 i	09/09-	EJ204	1994	Baumuster: B14	0-N1767	TB [BT]	



CM³



Art. Nr.



ohne Halter

LEGACY V (BM, BR)							
2.0 i	09/09-	EJ204	1994	Baumuster: B14	0-N1776	TB [DG]	
2.5 GT	07/10-	EJ255	2457	Baumuster: B14	0-N1776	TB [DG]	
2.5 GT, 2.5 i	09/09-	EJ253, EJ255	2457	Baumuster: B14	0-N1225	TB [DG]	
2.5 GT, 2.5 i	09/09-	EJ253, EJ255	2457	Baumuster: B14	0-N1226	TB [DG]	
2.5 GT, 2.5 i	09/09-	EJ253, EJ255	2457	Baumuster: B14	0-N1767	TB [BT]	
2.5 i	09/09-	EJ253	2457	Baumuster: B14	0-N1775	TB [DG]	
2.0 D	09/09-	EE20Z	1998		0-N2230	VB [BT]	S
2.0 D	09/09-	EE20Z	1998		0-N2374	VB [DG]	

LEGACY V Station Wagon (BM, BR)							
2.0 i	09/09-	EJ204, FB20	1994	30x281	SK-1721	BTK	
2.5 GT	07/10-	EJ255	2457	30x281	SK-1721	BTK	
2.5 i	09/09-	EJ253	2457	27x223	SK-1712	BTK	
2.5 i	09/09-	EJ253	2457	27x223	SK-1712AQ1	BTKW	
2.0 i	09/09-	EJ204, FB20	1994	Baumuster: B14	0-N1225	TB [DG]	
2.0 i	09/09-	EJ204, FB20	1994	Baumuster: B14	0-N1226	TB [DG]	
2.0 i	09/09-	EJ204, FB20	1994	Baumuster: B14	0-N1767	TB [BT]	
2.0 i	09/09-	EJ204, FB20	1994	Baumuster: B14	0-N1776	TB [DG]	
2.5 GT	07/10-	EJ255	2457	Baumuster: B14	0-N1776	TB [DG]	
2.5 GT, 2.5 i	09/09-	EJ253, EJ255	2457	Baumuster: B14	0-N1225	TB [DG]	
2.5 GT, 2.5 i	09/09-	EJ253, EJ255	2457	Baumuster: B14	0-N1226	TB [DG]	
2.5 GT, 2.5 i	09/09-	EJ253, EJ255	2457	Baumuster: B14	0-N1767	TB [BT]	
2.5 i	09/09-	EJ253	2457	Baumuster: B14	0-N1775	TB [DG]	
2.0 D	09/09-	EE20Z	1998		0-N2230	VB [BT]	S
2.0 D	09/09-	EE20Z	1998		0-N2374	VB [DG]	

LEGACY OUTBACK (BG)							
2.5	01/96-12/99	EJ25D	2457	→ 11/1998; Baumuster: B11	0-N1225	TB [DG]	
2.5	01/96-12/99	EJ25D	2457	→ 11/1998; Baumuster: B11	0-N1226	TB [DG]	
2.5	01/96-12/99	EJ25D	2457	→ 11/1998; Baumuster: B11	0-N1767	TB [BT]	
2.5	01/96-12/99	EJ25D	2457	Baumuster: B11	0-N1724	VB [DG]	
2.5	01/96-12/99	EJ25D	2457		0-N2102	VB [DG]	

LIBERO Bus (E10, E12)							
1.0 4WD	01/83-12/87	EF10	998		0-N1071	TB [TE]	
1.2 4WD	08/86-02/00	EF12	1190		0-N1829	TB [BT]	
1.2 i 4WD	08/91-02/00	EF12	1189		0-N1829	TB [BT]	

OUTBACK (BE, BH)							
2.5	10/00-08/03	EJ25	2457	27x223	SK-1712	BTK	
2.5	10/00-08/03	EJ25	2457	27x223	SK-1712AQ3	BTKW	
2.5	10/00-08/03	EJ25	2457		0-N1225	TB [DG]	
2.5	10/00-08/03	EJ25	2457		0-N1226	TB [DG]	
2.5	10/00-08/03	EJ25	2457		0-N1767	TB [BT]	
2.5	10/00-08/03	EJ25	2457		0-N1775	TB [DG]	
2.5	10/00-08/03	EJ25	2457		0-N1724	VB [DG]	
2.5	10/00-08/03	EJ25	2457		0-N2102	VB [DG]	
3.0 H6	10/00-08/03	EZ30	3000		0-N2182	VB [BT]	S

OUTBACK (BL, BP)							
2.0	09/03-10/05	EJ20	1994	27x223	SK-1712	BTK	
2.0	09/03-10/05	EJ20	1994	27x223	SK-1712AQ1	BTKW	
2.0	09/03-10/05	EJ20	1994	27x223	SK-1712AQ2	BTKW	
2.5	11/03-09/09	EJ251, EJ25D	2457	27x223	SK-1712	BTK	
2.5	11/03-09/09	EJ251, EJ25D	2457	27x223; für Länderausführung Africa	SK-1712AQ1	BTKW	
2.5	11/03-09/09	EJ251, EJ25D	2457	27x223; Länderausführung Iran, Israel, Saudi Arabien, Vereinigte Arabische Emirate	SK-1712AQ1	BTKW	
2.5	11/03-09/09	EJ251, EJ25D	2457	27x223; für Länderausführung Iran, Israel, Saudi Arabien, Vereinigte Arabische Emirate	SK-1712AQ2	BTKW	
2.5	11/03-09/09	EJ251, EJ25D	2457	27x223; nicht für Länderausführung Africa	SK-1712AQ2	BTKW	
2.0	09/03-10/05	EJ20	1994		0-N1225	TB [DG]	
2.0	09/03-10/05	EJ20	1994		0-N1226	TB [DG]	
2.0	09/03-10/05	EJ20	1994		0-N1767	TB [BT]	
2.0	09/03-10/05	EJ20	1994		0-N1775	TB [DG]	
2.5	11/03-09/09	EJ251, EJ25D	2457		0-N1225	TB [DG]	
2.5	11/03-09/09	EJ251, EJ25D	2457		0-N1226	TB [DG]	
2.5	11/03-09/09	EJ251, EJ25D	2457		0-N1767	TB [BT]	
2.5	11/03-09/09	EJ251, EJ25D	2457		0-N1775	TB [DG]	
2.0 D	09/08-09/09	EE20Z	1998		0-N2230	VB [BT]	S



OPTIMAL®

SUBARU



CM³



Art. Nr.



ohne Halter

OUTBACK (BL, BP)

2.0 D	09/08-09/09	EE20Z	1998		0-N2374	VB [DG]	
2.5	11/03-09/09	EJ25D	2457	→ 05/2009	0-N1724	VB [DG]	
2.5	11/03-09/09	EJ25D	2457		0-N2102	VB [DG]	
3.0	11/03-09/09	EZ30	3000		0-N2182	VB [BT]	S

OUTBACK (BM, BR)

2.5 i	09/09-	EJ253	2457	27x223	SK-1712	BTK	
2.5 i	09/09-	EJ253	2457	27x223	SK-1712AQ1	BTKW	
2.5 i	09/09-	EJ253	2457		0-N1225	TB [DG]	
2.5 i	09/09-	EJ253	2457		0-N1226	TB [DG]	
2.5 i	09/09-	EJ253	2457		0-N1767	TB [BT]	
2.5 i	09/09-	EJ253	2457		0-N1775	TB [DG]	
2.0 D	09/09-	EE20Z	1998		0-N2230	VB [BT]	S
2.0 D	09/09-	EE20Z	1998		0-N2374	VB [DG]	

SVX (CX)

3.3 AWD	02/94-12/97	EG33	3319		0-N2325	TB [TE]	
3.3 i 24V 4WD	09/92-12/97	EG33 DOHC	3319		0-N1782	TB [DG]	
3.3 i 24V 4WD	09/92-12/97	EG33 DOHC	3319		0-N1783	TB [DG]	
3.3 i 24V 4WD	09/92-12/97	EG33 DOHC	3319		0-N2325	TB [TE]	

TREZIA

1.3	03/11-	1NR-FE, 1NR-FKE	1329		0-N2393	VB [BT]	S
1.4 D	03/11-	1ND-TV	1364		0-N2107	VB [BT]	S

TRIBECA (B9)

3.0	01/05-	EZ30	2999		0-N2182	VB [BT]	S
3.0	10/06-	EZ30	3000		0-N2182	VB [BT]	S

XV

2.0 D	03/12-	EE20Z	1998		0-N2374	VB [DG]	
-------	--------	-------	------	--	----------------	---------	--



CM³



Art. Nr.



ohne Halter

ALTO (SS80)							
0.8	06/82-08/84	F8B	796	19x88	SK-1327	BTK	
0.8	10/83-08/84	F8A	797	19x88	SK-1327	BTK	
0.8	06/82-08/84	F8B	796		0-N017	TB [TE]	
0.8	10/83-08/84	F8A	797		0-N017	TB [TE]	
ALTO							
0.8	01/86-12/88	F8B	796	19x88	SK-1327	BTK	
0.8	01/86-12/88	F8B	796		0-N017	TB [TE]	
ALTO (HA11)							
1.0	09/94-09/98	G10BB	993	25.4x89	SK-1519	BTK	
1.0	09/94-09/98	G10BB	993		0-N916	TB [TE]	
ALTO (HA12, HA23)							
1.0	01/00-06/02	G10BB	993	25.4x89	SK-1519	BTK	
1.0	01/00-06/02	G10BB	993	25.4x97; 10/2000 → 03/2002	SK-1564	BTK	
1.0	01/00-06/02	G10BB	993		0-N916	TB [TE]	
1.3	10/98-09/00	G13BB	1298		0-N916	TB [TE]	
1.6	10/98-09/00	G16B	1590		0-N916	TB [TE]	
ALTO (HA24)							
1.1	09/04-12/08	F10D, F10DN	1061	24.5x106; Benzineinspritzung	SK-1738	BTK	
1.1	09/04-12/08	F10D, F10DN	1061		0-N2322	TB [TE]	
BALENO (EG)							
1.3, 1.3 i 16V	07/95-05/02	G13BA, G13BB	1298	25.4x97	SK-1564	BTK	
1.6 i 16V, 1.6 i 16V 4x4	07/95-05/02	G16B	1590	25x103	SK-1245	BTK	
1.9 TD	04/98-05/02	DHV (XUD9BSD), DHW (XUD9SD)	1905	25.4x136	SK-1022	BTK	
1.3, 1.3 i 16V	07/95-05/02	G13BA, G13BB	1298		0-N916	TB [TE]	
1.6 i 16V, 1.6 i 16V 4x4	07/95-05/02	G16B	1590		0-N916	TB [TE]	
1.9 TD	04/98-05/02	DHV (XUD9BSD), DHW (XUD9SD)	1905		0-N900	TB [DG]	
1.9 TD	04/98-05/02	DHV (XUD9BSD), DHW (XUD9SD)	1905		0-N901	TB [TE]	
1.8 GTX, 1.8 i 4x4	03/96-05/02	J18A	1839		0-N1876	VB [BT]	S
1.8 GTX, 1.8 i 4x4	03/96-05/02	J18A	1839		0-N1938	VB [DG]	
1.9 TD	04/98-05/02	XUD9A	1905		0-N1320	VB [TE]	
BALENO Kombi (EG)							
1.3 16V	03/97-05/02	G13BB	1298	25.4x97; 06/1997 →	SK-1564	BTK	
1.6 i 16V, 1.6 i 16V 4x4	08/96-05/02	G16B	1590	25x103	SK-1245	BTK	
1.9 TD	04/98-05/02	DHV (XUD9BSD), DHW (XUD9SD)	1905	25.4x136; 02/1999 →	SK-1022	BTK	
1.3 16V	03/97-05/02	G13BB	1298		0-N916	TB [TE]	
1.6 i 16V, 1.6 i 16V 4x4	08/96-05/02	G16B	1590		0-N916	TB [TE]	
1.9 TD	04/98-05/02	DHV (XUD9BSD), DHW (XUD9SD)	1905		0-N900	TB [DG]	
1.9 TD	04/98-05/02	DHV (XUD9BSD), DHW (XUD9SD)	1905		0-N901	TB [TE]	
1.8 i 16V, 1.8 i 16V 4x4	08/96-05/02	J18A	1839		0-N1876	VB [BT]	S
1.8 i 16V, 1.8 i 16V 4x4	08/96-05/02	J18A	1839		0-N1938	VB [DG]	
1.9 TD	04/98-05/02	XUD9A	1905		0-N1320	VB [TE]	
BALENO Schrägheck (EG)							
1.3, 1.3 i 16V	07/95-05/02	G13BA, G13BB	1298	25.4x97	SK-1564	BTK	
1.6 i 16V, 1.6 i 16V 4x4	07/95-05/02	G16B	1590	25x103	SK-1245	BTK	
1.9 TD	04/98-05/02	DHV (XUD9SD)	1905	25.4x136	SK-1022	BTK	
1.3, 1.3 i 16V	07/95-05/02	G13BA, G13BB	1298		0-N916	TB [TE]	
1.6 i 16V, 1.6 i 16V 4x4	07/95-05/02	G16B	1590		0-N916	TB [TE]	
1.9 TD	04/98-05/02	DHV (XUD9SD)	1905		0-N900	TB [DG]	
1.9 TD	04/98-05/02	DHV (XUD9SD)	1905		0-N901	TB [TE]	
1.8 GTX, 1.8 i 4x4	03/96-05/02	J18A	1839		0-N1876	VB [BT]	S
1.8 GTX, 1.8 i 4x4	03/96-05/02	J18A	1839		0-N1938	VB [DG]	
1.9 TD	04/98-05/02	XUD9A	1905		0-N1320	VB [TE]	
CARRY Kasten (ST90V)							
0.8	11/80-10/85	F8A	797		0-N017	TB [TE]	
CARRY Pick-up							
1.0	07/85-12/90	F10A	970		0-N017	TB [TE]	
CARRY Kasten (FD)							
1.3, 1.3 16 V, 1.3 4x4	02/99-09/04	G13BB	1298	25.4x97	SK-1564	BTK	
1.3, 1.3 16 V, 1.3 4x4	02/99-09/04	G13BB	1298		0-N916	TB [TE]	
GRAND VITARA I (FT)							
1.6, 1.6 Allrad	03/98-07/03	G16B	1590	25x103	SK-1245	BTK	



OPTIMAL®

SUZUKI

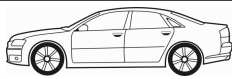

CM³



Art. Nr.



ohne Halter

GRAND VITARA I (FT)

2.0 HDI 110	07/01-09/05	RHZ	1997	25x141; mit Zubehör	SK-1085	BTK	
2.0 HDI 110	07/01-09/05	RHZ	1997	25.4x141; :→4001431; mit Zubehör	SK-1085AQ1	BTKW	
2.0 HDI 110 16V	07/01-09/05	RHW	1997	25.4x144; 02/2003 →	SK-1534	BTK	
2.0 HDI 110 16V	07/01-09/05	RHW	1997	25.4x144; :4021472→	SK-1534	BTK	
2.0 HDI 110 16V	07/01-09/05	RHW	1997	25.4x144; 02/2003 → 10/2005	SK-1534AQ1	BTKW	
1.6, 1.6 Allrad	03/98-07/03	G16B	1590		0-N916	TB [TE]	
2.0 HDI 110, 2.0 HDI 110 16V	07/01-09/05	RHW, RHZ	1997		0-N118P	TB [TE]	
2.0 HDI 110, 2.0 HDI 110 16V	07/01-09/05	RHW, RHZ	1997		0-N119P	TB [DG]	
2.0 TD Intercooler	03/98-07/03	RF	1998		0-N1216	TB [TE]	
2.0	03/98-07/03	J20A	1995		0-N1938	VB [DG]	
2.0 HDI 110	07/01-09/05	RHZ	1997	→ 10/2003	0-N2118	VB [TE]	
2.0 HDI 110 16V	07/01-09/05	RHW	1997	06/2003 →	0-N2118	VB [TE]	
2.0, 2.0 Allrad	03/98-08/05	J20A	1995		0-N1876	VB [BT]	S
2.5 V6 24V	04/98-07/03	H 25 A	2493		0-N2239	VB [TE]	
2.7, 2.7 XL-7	06/01-08/06	H 27 A	2736		0-N2239	VB [TE]	

GRAND VITARA II (JT)

1.9 DDiS	10/05-02/15	F9QB	1870	26x133	SK-1580	BTK	
1.9 DDiS	10/05-02/15	F9QB	1870	26x133	SK-1698	BTK	
1.9 DDiS	10/05-02/15	F9QB	1870	26x133; ch.JSAJTD44V00610001→; Baumuster: JB419XD	SK-1698AQ1	BTKW	
1.9 DDiS	10/05-02/15	F9QB	1870	26x133; ch.JSAJTD44V00610001→; Nicht für Länderausführung Afrika, Türkei ; Baumuster: JB419WD	SK-1698AQ1	BTKW	
1.3	05/05-07/06	G13BB	1298		0-N916	TB [TE]	
1.9 DDiS	10/05-02/15	F9QB	1870	JS3TD44VA4600000;	0-N1066	TB [DG]	
1.9 DDiS	10/05-02/15	F9QB	1870	mit Anbaumaterial	0-N1323	TB [TE]	
1.9 DDiS	10/05-02/15	F9QB	1870	ch.JS3TD44VA4600001→;	0-N2228	TB [DG]	
1.6 Allrad	04/05-02/15	M16A	1586		0-N2106	VB [TE]	
1.9 DDiS	10/05-02/15	F9QB	1870	mit Spanndämpfer, Spannrolle	0-N1804	VB [DG]	S
1.9 DDiS	10/05-02/15	F9QB	1870		0-N1965	VB [DG]	
1.9 DDiS	10/05-02/15	F9QB	1870	Rippenanzahl: 7	0-N2052	VB [DG]	
2.0 Allrad	10/05-02/15	J20A	1995		0-N1876	VB [BT]	S
2.0 Allrad	10/05-02/15	J20A	1995		0-N1938	VB [DG]	
2.7 Allrad	01/07-	H 27 A	2736		0-N2239	VB [TE]	

IGNIS (FH)

1.3, 1.3 4WD	10/00-09/03	M13A	1328		0-N2023	VB [TE]	
--------------	-------------	------	------	--	---------	---------	--

IGNIS II

1.3	09/03-	M13A	1328	→ 04/2011; Baumuster: RM413; Fahrzeugproduktionsland Ungarn	0-N2023	VB [TE]	
1.3	09/03-	M13A	1328	→ 04/2011; nicht für Länderausführung Ungarn; Baumuster: RG413	0-N2023	VB [TE]	
1.3 4x4	09/03-	M13A	1328	→ 04/2011	0-N2023	VB [TE]	
1.3 DDiS	09/03-	Z13DT	1248		0-N1526	VB [BT]	S
1.5, 1.5 4x4, 1.5 Sport	09/03-	M15A	1490	→ 04/2009	0-N2023	VB [TE]	

JIMNY (FJ)

1.3 16V, 1.3 16V 4WD	02/01-	M13A	1328	25.4x97	SK-1564	BTK	
1.3 16V, 1.3 16V 4WD, 1.3 4x4	09/98-08/00	G13BB	1298	25.4x97	SK-1564	BTK	
1.5 DDiS 4WD, 1.5 DDiS 4x4	12/03-	K9K 266, K9K 700	1461	27x123; mit Zubehör	SK-1487	BTK	
1.5 DDiS 4WD, 1.5 DDiS 4x4	12/03-	K9K 266, K9K 700	1461	27x123; mit Zubehör	SK-1487AQ1	BTKW	
1.5 DDiS 4x4	08/05-	K9K 266	1461	27x123; mit Zubehör	SK-1487AQ2	BTKW	
1.0	09/98-10/03	F10AC	970		0-N017	TB [TE]	
1.3 16V, 1.3 16V 4WD	02/01-	M13A	1328		0-N916	TB [TE]	
1.3 16V, 1.3 16V 4WD, 1.3 4x4	09/98-08/00	G13BB	1298		0-N916	TB [TE]	
1.5 DDiS 4WD, 1.5 DDiS 4x4	12/03-	K9K 266, K9K 700	1461		0-N1111	TB [TE]	
1.3 16V 4x4, 1.3 4x4	09/00-08/02	M13A	1328		0-N2106	VB [TE]	
1.3 16V, 1.3 16V 4WD	09/98-	G13BB	1298	→ 04/2011; für Fahrzeuge mit Servolenkung	0-N2023	VB [TE]	
1.3 16V, 1.3 16V 4WD	09/98-	G13BB	1298	→ 04/2011; für Fahrzeuge ohne Servolenkung	0-N2023	VB [TE]	
1.3 16V, 1.3 16V 4WD	09/98-	G13BB	1298	→ 04/2011;	0-N2023	VB [TE]	
1.3 16V, 1.3 16V 4WD	02/01-	M13A	1328	05/2001 → 07/2004;	0-N2106	VB [TE]	
1.3 16V, 1.3 16V 4WD, 1.3 16V 4x4	02/01-	M13A	1328	→ 04/2011; für Fahrzeuge ohne Servolenkung	0-N2023	VB [TE]	
1.3 4x4	09/98-08/00	G13BB	1298		0-N2023	VB [TE]	
1.3 4x4	09/98-08/00	G13BB	1298	für Fahrzeuge mit Servolenkung	0-N2023	VB [TE]	
1.3 4x4	09/98-08/00	G13BB	1298	für Fahrzeuge ohne Servolenkung	0-N2023	VB [TE]	
1.3 4x4	09/00-08/02	M13A	1328	für Fahrzeuge ohne Servolenkung	0-N2023	VB [TE]	



CM³



Art. Nr.



ohne Halter

JIMNY (FJ)								
1.5 DDiS 4WD, 1.5 DDiS 4x4	12/03-	K9K 266, K9K 700	1461			0-N1474	VB [BT]	
1.5 DDiS 4WD, 1.5 DDiS 4x4	12/03-	K9K 266, K9K 700	1461			0-N2405	VB [BT]	S
LIANA (ER)								
1.4 DDiS	04/04-	8HY	1398	25.4x135		SK-1577	BTK	
1.4 DDiS	04/04-	8HY	1398	25.4x135; → 04/2009; :5025152→		SK-1577AQ1	BTKW	
1.4 DDiS	04/04-	8HY	1398			0-N1062	TB [TE]	
1.4 DDiS	04/04-	8HY	1398			0-N1066	TB [DG]	
1.4 DDiS	04/04-	8HY	1398			0-N1418	VB [DG]	
1.4 DDiS	04/04-	8HY	1398			0-N1636	VB [BT]	S
LIANA Kombi (ER)								
1.4 DDiS	04/04-12/07	8HY	1398	25.4x135		SK-1577	BTK	
1.4 DDiS	04/04-12/07	8HY	1398	25.4x135; → 04/2009; :5025152→		SK-1577AQ1	BTKW	
1.4 DDiS	04/04-12/07	8HY	1398			0-N1062	TB [TE]	
1.4 DDiS	04/04-12/07	8HY	1398			0-N1066	TB [DG]	
1.4 DDiS	04/04-12/07	8HY	1398			0-N1418	VB [DG]	
1.4 DDiS	04/04-12/07	8HY	1398			0-N1636	VB [BT]	S
LJ 80								
0.8	01/80-01/84	F8A	797			0-N017	TB [TE]	
SAMURAI (SJ)								
1.0 Allrad	11/88-12/04	F10A	970	19x88; → 10/1994; für OE: 1276178400		SK-1327	BTK	
1.3	11/88-12/04	G13A	1324	19.05x89		SK-1248	BTK	
1.3 Allrad	11/88-12/04	G13BA	1298	19.05x89; → 07/1993		SK-1248	BTK	
1.3 Allrad	11/88-12/04	G13BA	1298	25.4x89		SK-1519	BTK	
1.3 Allrad	11/88-12/04	G13BA	1298	19x89; 07/1993 → 08/2000		SK-1563	BTK	
1.3 Allrad	01/00-12/04	G13BA	1298	25.4x89; → 03/2002		SK-1519	BTK	
1.9 TD	11/98-12/04		1870	25.4x136		SK-1022	BTK	
1.9 TD	11/98-12/04	XUD9	1905	25.4x136		SK-1022	BTK	
1.0 Allrad	11/88-12/04	F10A	970			0-N017	TB [TE]	
1.3	11/88-12/04	G13A	1324			0-N018	TB [TE]	
1.3 Allrad	11/88-12/04	G13BA	1298			0-N018	TB [TE]	
1.9 TD	11/98-12/04	XUD9	1905			0-N900	TB [DG]	
1.9 TD	11/98-12/04	XUD9	1905			0-N901	TB [TE]	
SJ 410								
1.0	09/81-12/88	F10A	970	19x88; 01/1986 → 03/1988		SK-1327	BTK	
1.0	09/81-12/88	F10A	970			0-N017	TB [TE]	
SJ 410 Cabrio								
1.0	09/81-12/88	F10A	970	19x88; 01/1986 → 03/1988		SK-1327	BTK	
1.0	09/81-12/88	F10A	970			0-N017	TB [TE]	
SJ 413								
1.3	09/84-08/90	G13A	1324	19.05x89		SK-1248	BTK	
1.3	09/84-08/90	G13A	1324			0-N018	TB [TE]	
SPLASH								
1.3 CDTI	01/08-	D13A, Z 13 DTJ	1248			0-N1526	VB [BT]	S
SUPER CARRY Bus (ED)								
1.0	10/85-03/99	F10A	970	19x88		SK-1327	BTK	
1.0	10/85-03/99	F10A	970			0-N017	TB [TE]	
SWIFT I (AA)								
1.0, 1.0 Turbo	10/83-12/89	G10, G10A, G10T	993	19.05x89		SK-1248	BTK	
1.3	10/84-03/89	G13A	1324	19.05x89		SK-1248	BTK	
1.0, 1.0 Turbo	10/83-12/89	G10, G10A, G10T	993			0-N018	TB [TE]	
1.3	10/84-03/89	G13A	1324			0-N018	TB [TE]	
1.3 GTi/GXi	08/85-03/89	G13B	1298			0-N019	TB [TE]	
1.3 GTi/GXi	08/85-03/89	G13B	1298			0-N020	TB [TE]	
SWIFT Cabriolet (SF413)								
1.3 i	09/91-10/96	G13BA	1298	19.05x89; → 12/1993; :→G13BA339760		SK-1248	BTK	
1.3 i	09/91-10/96	G13BA	1298	25.4x89; 06/1996 →		SK-1519	BTK	
1.3 i	09/91-10/96	G13BA	1298	19x89; 01/1994 →; :G13BA339761→		SK-1563	BTK	
1.3 i	09/91-10/96	G13BA	1298	→ 05/1996		0-N018	TB [TE]	
1.3 i	09/91-10/96	G13BA	1298	06/1996 →		0-N916	TB [TE]	
SWIFT II Schrägheck (EA, MA)								
1.0, 1.0 i	03/89-12/05	G10A	993	19x97; :→147246, 176378		SK-1249	BTK	



OPTIMAL®

SUZUKI



CM³



Art. Nr.



ohne Halter

SWIFT II Schrägheck (EA, MA)

1.0, 1.0 i	03/89-12/05	G10A	993	19x97; :147247, 176379→	SK-1566	BTK	
1.0 i	03/89-12/05	G10A	993	25.4x97; Baumuster: SF310MA	SK-1757	BTK	
1.0 i	01/95-12/05	G10A	993	25.4x97; Baumuster: Cultus, SF310MA	SK-1757	BTK	
1.3	03/89-05/01	G13A	1298	19.05x89; → 12/1993; :→G13B253432	SK-1248	BTK	
1.3	03/89-05/01	G13A	1298	19.05x89; → 12/1993; :→G13BA339760	SK-1248	BTK	
1.3	03/89-12/91	G13A	1324	19.05x89	SK-1248	BTK	
1.3	03/89-05/01	G13A	1298	25.4x89; 06/1996 →	SK-1519	BTK	
1.3	03/89-05/01	G13A	1298	19x89; 01/1993 →; :G13B253433→	SK-1563	BTK	
1.3	03/89-05/01	G13A	1298	19x89; 01/1993 →; :G13BA339761→	SK-1563	BTK	
1.3	03/89-10/96	G13BA	1298	19x89; :G13B253433→	SK-1563	BTK	
1.3	03/89-10/96	G13BA	1298	19x89; :G13BA339761→	SK-1563	BTK	
1.3	06/01-12/03	G13BB	1298	25.4x97	SK-1564	BTK	
1.3 4WD	03/89-05/01	G13A	1324	19.05x89; → 12/1993; :→G13B253432	SK-1248	BTK	
1.3 4WD	03/89-05/01	G13A	1324	19.05x89; → 12/1993; :→G13BA339760	SK-1248	BTK	
1.3 4WD	03/89-05/01	G13A	1324	25.4x89; 06/1996 →	SK-1519	BTK	
1.3 4WD	03/89-05/01	G13A	1324	19x89; 01/1993 →; :G13B253433→	SK-1563	BTK	
1.3 4WD	03/89-05/01	G13A	1324	19x89; 01/1993 →; :G13BA339761→	SK-1563	BTK	
1.3 4WD	10/89-12/91	G13A	1324	19.05x89; :→G13B253432	SK-1248	BTK	
1.3 4WD	10/89-12/91	G13A	1324	19.05x89; :→G13BA339760	SK-1248	BTK	
1.3 GTi	03/89-05/01	G13B	1298	25.4x119	SK-1246	BTK	
1.6 4x4	03/89-10/96	G16B	1590	25x103	SK-1245	BTK	
1.0, 1.0 i	03/89-12/05	G10A	993	→ 05/1996	0-N019	TB [TE]	
1.0, 1.0 i	03/89-12/05	G10A	993	06/1996 →	0-N020	TB [TE]	
1.0 i	03/89-12/91	G10A	993		0-N019	TB [TE]	
1.3	03/89-05/01	G13A, G13BA	1298	→ 05/1996	0-N018	TB [TE]	
1.3	03/89-05/01	G13A, G13BA	1298	06/1996 →	0-N916	TB [TE]	
1.3	06/01-12/03	G13BB	1298		0-N916	TB [TE]	
1.3, 1.3 4WD	03/89-12/91	G13A	1324		0-N018	TB [TE]	
1.3 4WD	03/89-05/01	G13A	1324	→ 05/1996	0-N018	TB [TE]	
1.3 4WD	03/89-05/01	G13A	1324	06/1996 →	0-N916	TB [TE]	
1.6 4x4	03/89-10/96	G16B	1590		0-N916	TB [TE]	

SWIFT II Stufenheck (AH, AJ)

1.3	03/89-05/01	G13A	1324	19.05x89; → 12/1993; :→G13B253432	SK-1248	BTK	
1.3	03/89-05/01	G13A	1324	19.05x89; → 12/1993; :→G13BA339760	SK-1248	BTK	
1.3	03/89-12/91	G13A	1324	19.05x89; :→G13B253432	SK-1248	BTK	
1.3	03/89-12/91	G13A	1324	19.05x89; :→G13BA339760	SK-1248	BTK	
1.3	03/89-05/01	G13A	1324	25.4x89	SK-1519	BTK	
1.3	03/89-05/01	G13A	1324	19x89; 11/1996 → 06/2000; :G13B253433→	SK-1563	BTK	
1.3	03/89-05/01	G13A	1324	19x89; 11/1996 → 06/2000; :G13BA339761→	SK-1563	BTK	
1.3	03/89-12/91	G13A	1324	19x89; :G13B253433→	SK-1563	BTK	
1.3	03/89-12/91	G13A	1324	19x89; :G13BA339761→	SK-1563	BTK	
1.6, 1.6 4WD, 1.6 i, 1.6 i 4WD	11/89-05/01	G16B	1590	25x103	SK-1245	BTK	
1.3	03/89-05/01	G13A	1324	→ 05/1996	0-N018	TB [TE]	
1.3	03/89-12/91	G13A	1324		0-N018	TB [TE]	
1.3	03/89-05/01	G13A	1324	06/1996 →	0-N916	TB [TE]	
1.6, 1.6 4WD, 1.6 i, 1.6 i 4WD	11/89-05/01	G16B	1590		0-N916	TB [TE]	

SWIFT III (MZ, EZ)

1.3 DDiS	08/05-	D13A, Z 13 DTJ, Z13DT	1248		0-N1526	VB [BT]	S
1.3, 1.3 4x4	02/05-	M13A	1328	→ 04/2011	0-N2023	VB [TE]	
1.5	02/05-	M15A	1490	→ 04/2011; Fahrzeugproduktionsland Ungarn	0-N2023	VB [TE]	
1.5	02/05-	M15A	1490	→ 04/2011; nicht für Länderausführung Ungarn	0-N2023	VB [TE]	
1.5 4x4	02/05-	M15A	1490	→ 04/2011	0-N2023	VB [TE]	
1.6	05/06-	M16A	1586	→ 04/2011; Fahrzeugproduktionsland Ungarn	0-N2023	VB [TE]	
1.6	05/06-	M16A	1586	→ 04/2011; nicht für Länderausführung Ungarn	0-N2023	VB [TE]	

SWIFT IV (FZ, NZ)

1.3 DDiS	10/10-	D13A	1248		0-N1526	VB [BT]	S
----------	--------	------	------	--	---------	---------	---

SX4 (EY, GY)

1.9 DDiS, 1.9 DDiS 4x4	06/06-	D19AA	1910	24x190; mit Zubehör	SK-1629	BTK	
1.9 DDiS, 1.9 DDiS 4x4	06/06-	D19AA	1910	24x190	SK-1696	BTK	



CM³



Art. Nr.



SX4 (EY, GY)							
1.9 DDiS, 1.9 DDiS 4x4	06/06-	D19AA	1910	24x190		SK-1696AQ1	BTKW
2.0 DDiS, 2.0 DDiS 4x4	07/09-	D20AA	1956	24x199		SK-1586AQ1	BTKW
1.6 DDiS	04/07-	9HX	1560			0-N1066	TB [DG]
1.9 DDiS, 1.9 DDiS 4x4	06/06-	D19AA	1910			0-N115	TB [TE]
1.9 DDiS, 1.9 DDiS 4x4	06/06-	D19AA	1910			0-N2149	TB [DG]
2.0 DDiS, 2.0 DDiS 4x4	07/09-	D20AA	1956			0-N2149	TB [DG]
1.5, 1.5 VVT	06/06-	M15A	1490	→ 04/2011; nicht für Länderausführung Ungarn; ☼		0-N2023	VB [TE]
1.5, 1.5 VVT	06/06-	M15A	1490	→ 04/2011; ☼; Fahrzeugproduktionsland Ungarn		0-N2023	VB [TE]
1.6, 1.6 VVT, 1.6 VVT 4x4	06/06-	M16A	1586	→ 04/2011; nicht für Länderausführung Ungarn; ☼		0-N2023	VB [TE]
1.6, 1.6 VVT, 1.6 VVT 4x4	06/06-	M16A	1586	→ 04/2011; ☼; Fahrzeugproduktionsland Ungarn		0-N2023	VB [TE]
1.9 DDiS, 1.9 DDiS 4x4	06/06-	D19AA	1910			0-N1522	VB [DG]
1.9 DDiS, 1.9 DDiS 4x4	06/06-	D19AA	1910	Rippenanzahl: 6		0-N1667	VB [DG]
2.0 DDiS, 2.0 DDiS 4x4	07/09-	D20AA	1956			0-N1522	VB [DG]
2.0 DDiS, 2.0 DDiS 4x4	07/09-	D20AA	1956	Rippenanzahl: 6		0-N1667	VB [DG]
2.0, 2.0 4x4	06/06-	J20A	1995			0-N1876	VB [BT] S
SX4 S-Cross							
1.6 DDiS, 1.6 DDiS 4x4	08/13-	D16AA	1598			0-N2149	TB [DG]
SX4 Stufenheck (GY)							
1.6	10/07-	M16A	1586	→ 04/2011; nicht für Länderausführung Ungarn; ☼		0-N2023	VB [TE]
1.6	10/07-	M16A	1586	→ 04/2011; ☼; Fahrzeugproduktionsland Ungarn		0-N2023	VB [TE]
VITARA (ET, TA)							
1.6, 1.6 i 16V	07/88-03/98	G16A (8V), G16B	1589	19x95		SK-1250	BTK
1.6 i 16V	07/90-03/98	G16B	1589	25x103		SK-1245	BTK
1.9 D	01/95-03/98	XUD9A	1905	25.4x136; 11/1995 →		SK-1022	BTK
1.9 D	08/96-03/98	XUD9SD	1905	25.4x136		SK-1022	BTK
1.6	07/88-03/98	G16A (8V)	1589			0-N018	TB [TE]
1.6 i 16V	07/90-03/98	G16B	1589			0-N916	TB [TE]
1.9 D	01/95-03/98	XUD9A, XUD9SD	1905			0-N900	TB [DG]
1.9 D	01/95-03/98	XUD9A, XUD9SD	1905			0-N901	TB [TE]
2.0 TD, 2.0 TD Intercooler	12/94-03/98	RF	1998			0-N1216	TB [TE]
2.0 16V	12/96-03/98	J20A	1995			0-N1876	VB [BT] S
2.0 16V	12/96-03/98	J20A	1995			0-N1938	VB [DG]
2.0 V6 24V	12/94-03/98	H 20 A	1998			0-N2239	VB [TE]
2.5 V6 24V	12/95-03/98	H 25 A	2493			0-N2239	VB [TE]
VITARA [USA] Sport Utility							
2.0, 2.0 16V, 2.0 16V AWD	01/99-12/03		2000			0-N1694	VB [DG]
VITARA (ET)							
HDI	12/03-12/05	RHP (DW10TD)	1997	25.4x141; mit Zubehör		SK-1085AQ1	BTKW
HDI	12/03-12/05	RHP (DW10TD)	1997			0-N1381	TB [DG]
VITARA Cabrio (ET)							
2.0 HDI	12/03-12/05	RHP (DW10TD)	1997	25.4x141; mit Zubehör		SK-1085AQ1	BTKW
2.0 HDI	12/03-12/05	RHP (DW10TD)	1997			0-N1381	TB [DG]
VITARA Cabrio (ET, TA)							
1.6 i 16V	07/90-03/99	G16B	1589	25x103		SK-1245	BTK
1.6, 1.6 i 16V	07/88-03/99	G16A (8V), G16B	1589	19x95		SK-1250	BTK
1.9 D	01/95-03/98	XUD9A	1905	25.4x136; 11/1995 →		SK-1022	BTK
1.9 D	08/96-03/99	XUD9SD	1905	25.4x136		SK-1022	BTK
1.6	07/88-01/95	G16A (8V)	1589			0-N018	TB [TE]
1.6 i 16V	07/90-03/99	G16B	1589			0-N916	TB [TE]
1.9 D	01/95-03/99	XUD9A, XUD9SD	1905			0-N900	TB [DG]
1.9 D	01/95-03/99	XUD9A, XUD9SD	1905			0-N901	TB [TE]
2.0 16V	12/96-03/99	J20A	1995			0-N1876	VB [BT] S
2.0 16V	12/96-03/99	J20A	1995			0-N1938	VB [DG]
WAGON R							
1.0	07/03-08/05	G10A	993	25.4x97		SK-1757	BTK
1.0	07/03-08/05	G10A	993			0-N020	TB [TE]
1.0	06/04-08/05	Z 10 XEP	998			0-N2170	VB [BT] S
1.2	06/04-08/05	Z 12 XEP	1229			0-N2170	VB [BT] S



OPTIMAL®

SUZUKI



CM³



Art. Nr.



ohne Halter

WAGON R+ (EM)

1.0	02/98-05/00	K10A	996		0-N2023	VB [TE]	
-----	-------------	------	-----	--	----------------	---------	--

WAGON R+ (MM)

1.3, 1.3 4WD	05/00-12/04	G13BB	1298	25.4x97	SK-1564	BTK	
1.3, 1.3 4WD	05/00-12/04	G13BB	1298		0-N916	TB [TE]	
1.3	05/00-12/04	G13BB	1298	→ 04/2011	0-N2023	VB [TE]	
1.3	08/01-	M13A	1328	→ 01/2005	0-N2023	VB [TE]	
1.3 4WD	10/01-	G13BB	1298	→ 04/2009	0-N2023	VB [TE]	
1.3 DDiS	09/03-	Z13DT	1248		0-N1526	VB [BT]	S
1.3, 1.3 4WD	09/03-	M13A	1328	→ 04/2009	0-N2023	VB [TE]	

X-90 (EL)

1.6 i 16V, 1.6 i 16V 4x4	09/95-12/97	G16B	1590	25x103	SK-1245	BTK	
1.6 i 16V, 1.6 i 16V 4x4	09/95-12/97	G16B	1590		0-N916	TB [TE]	

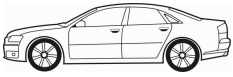

CM³



Art. Nr.



ohne Halter

ALTO						
0.8	01/92-08/08	F8B, JL360Q	796		0-N017	TB [TE]
SWIFT (EZ, MZ)						
1.3	05/05-	G 13 B, JL474Q5, JL474Q8	1301		0-N916	TB [TE]
1.5	12/07-	M15A	1490		0-N916	TB [TE]

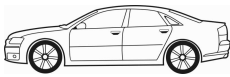

CM³



Art. Nr.



ohne Halter

EXPRESS 1000 -1500 Bus

1.9 D	07/87-10/90	XUD9A	1905	25.39x136	SK-1007	BTK	
1.9 D	07/87-10/90	XUD9A	1905	25.4x136	SK-1007AQ1	BTKW	
2.5 D, 2.5 TD	07/82-10/94	CRD93, CRD93LS	2498	32x118	SK-1018S	BTK	

EXPRESS 1000 -1500 Pritsche/Fahrgestell

2.5 D, 2.5 D Allrad, 2.5 TD, 2.5 TD Allrad	07/82-10/94	CRD93, CRD93LS	2498	32x118	SK-1018S	BTK	
--	-------------	----------------	------	--------	----------	-----	--

EXPRESS 1000 -1800 Kasten

1.9 D	07/87-10/90	XUD9A	1905	25.39x136	SK-1007	BTK	
1.9 D	07/87-10/90	XUD9A	1905	25.4x136	SK-1007AQ1	BTKW	
2.5 D, 2.5 D Allrad, 2.5 TD, 2.5 TD Allrad	07/82-10/94	CRD93, CRD93LS	2498	32x118	SK-1018S	BTK	

HORIZON

1.9 Diesel	07/82-06/86	XUD9	1905	25.39x136; 08/1983 →	SK-1007	BTK	
1.9 Diesel	07/84-06/86	XUD9	1905	25.39x136	SK-1007	BTK	
1.9 Diesel	07/84-06/86	XUD9	1905	25.4x136	SK-1007AQ1	BTKW	
1.9 Diesel	07/82-06/86	XUD9	1905		0-N813	TB [TE]	
1.9 Diesel	07/82-06/86	XUD9	1905		0-N814	TB [DG]	

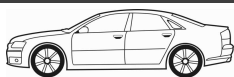
CM³

Art. Nr.

ohne
Halter

ARIA							
2.2 Di 4WD	10/10-	DW12DD	2179		0-N2331	TB [TE]	
2.2 Di 4WD	10/10-	DW12DD	2179		0-N2385	TB [DG]	
2.2 Di 4WD	10/10-	DW12DD	2179		0-N2386	TB [DG]	
INDICA (40_V2)							
1.4 D	10/98-	475 DL	1405		0-N1066	TB [DG]	
1.4 D	10/98-	475 DL	1405		0-N2331	TB [TE]	
1.4 L	06/98-09/02		1405		0-N2330	TB [TE]	
1.4 D	10/98-	475 DL	1405		0-N2378	VB [DG]	
1.4 D, 1.4 i	10/98-	475 DL, 475 Si	1405		0-N2379	VB [DG]	
INDIGO (4_V2)							
1.4, 1.4 D	01/03-	475 DL, 475 Si	1405		0-N2378	VB [DG]	
1.4, 1.4 D	01/03-	475 DL, 475 Si	1405		0-N2379	VB [DG]	
INDIGO MARINA (4_V2)							
1.4, 1.4 D	01/03-12/10	475 DL, 475 Si	1405		0-N2378	VB [DG]	
1.4, 1.4 D	01/03-12/10	475 DL, 475 Si	1405		0-N2379	VB [DG]	
SAFARI (42_FD)							
2.2 TDiC, 2.2 TDiC 4x4	07/06-	DW12DD	2179		0-N2331	TB [TE]	
2.2 TDiC, 2.2 TDiC 4x4	07/06-	DW12DD	2179		0-N2385	TB [DG]	
2.2 TDiC, 2.2 TDiC 4x4	07/06-	DW12DD	2179		0-N2386	TB [DG]	
XENON Pick-up							
2.2 DiCOR, 2.2 DiCOR 4x4	01/09-	DW12DD	2179		0-N2331	TB [TE]	
2.2 DiCOR, 2.2 DiCOR 4x4	01/09-	DW12DD	2179		0-N2385	TB [DG]	
2.2 DiCOR, 2.2 DiCOR 4x4	01/09-	DW12DD	2179		0-N2386	TB [DG]	

CM³

Art. Nr.

**4 RUNNER (RN10_, VZN13_, VZN10_, RN13_)**

2.4 TD 4x4	08/89-11/95	2L-T	2446	31x129	SK-1522	BTK	
3.0 Turbo-D	10/93-03/96	1KZ-T	2982		SK-1682	BTK	
3.4 i 4x4	11/95-03/96	5VZ-FE	3378	36x191	SK-1702	BTK	
3.0 Turbo-D	10/93-03/96	1KZ-T	2982		0-N1618	TB [TE]	
3.0 Turbo-D	10/93-03/96	1KZ-T	2982		0-N1819	TB [BT]	
3.0 V6	07/90-11/95	3VZ-E	2959		0-N1250	TB [DG]	
3.0 V6	07/90-11/95	3VZ-E	2959	12/1992 →	0-N1774	TB [BT]	
3.4 i 4x4	11/95-03/96	5VZ-FE	3378		0-N1773	TB [DG]	
3.4 i 4x4	11/95-03/96	5VZ-FE	3378		0-N1879	TB [TE]	

4 RUNNER (UZN21_, KZN21_, GRN21_)

4.0 4WD	11/02-07/09	1GR-FE	3956	✳	0-N1878	VB [DG]	
---------	-------------	--------	------	---	---------	---------	--

4 RUNNER (KZN18_, VZN18_, RZN18_)

3.0 Turbo-D	11/95-11/02	1KZ-T	2982	25x102; 06/2000 →	SK-1521	BTK	
3.0 Turbo-D	11/95-11/02	1KZ-T	2982	→ 06/2000	SK-1682	BTK	
3.0 Turbo-D	11/95-11/02	1KZ-T	2982	→ 06/2000	0-N1618	TB [TE]	
3.0 Turbo-D	11/95-11/02	1KZ-T	2982	06/2000 →	0-N176	TB [TE]	
3.0 Turbo-D	11/95-11/02	1KZ-T	2982		0-N1819	TB [BT]	
4.0 VVTi	08/02-11/02	1GR-FE	3956	✳	0-N1728	VB [DG]	
4.0 VVTi	08/02-11/02	1GR-FE	3956	✳	0-N1878	VB [DG]	
4.0 VVTi	08/02-11/02	1GR-FE	3956		0-N2188	VB [BT]	S

ALLION I (ZZT24_, NZT24_, AZT24_)

1.8, 1.8 4x4	06/01-06/07	1ZZ-FE	1794		0-N1462	VB [BT]	S
2.0, 2.0 4x4	06/01-06/07	1AZ-FSE	1998		0-N2185	VB [VD]	

ALPHARD (ATH1_, MNH1_, ANH1_)

2.4, 2.4 4x4	09/03-04/08	2AZ-FE	2362		0-N2184	VB [BT]	S
--------------	-------------	--------	------	--	---------	---------	---

ALPHARD / VELLFIRE (GGH2_, ANH2_, ATH2_)

2.4, 2.4 4WD	04/08-12/14	2AZ-FE	2362		0-N2184	VB [BT]	S
2.4, 2.4 4WD	04/08-12/14	2AZ-FE	2362		0-N2185	VB [VD]	
3.5, 3.5 4WD	04/08-12/14	2GR-FE	3456		0-N1728	VB [DG]	
3.5, 3.5 4WD	04/08-12/14	2GR-FE	3456		0-N2032	VB [BT]	S

ALTEZZA (SXE1_, JCE1_, GXE1_)

3.0	07/01-07/05	2JZ-GE	2997		0-N1877	VB [BT]	S
-----	-------------	--------	------	--	---------	---------	---

ALTEZZA GITA (SXE1_, GXE1_)

3.0	07/01-06/05	2JZ-GE	2997		0-N1877	VB [BT]	S
-----	-------------	--------	------	--	---------	---------	---

ARISTO (JZS16_)

4.3	04/99-09/04	3UZ-FE	4293		0-N1883	TB [BT]	S
4.3	04/99-09/04	3UZ-FE	4293		0-N2058	TB [DG]	
3.0	08/97-09/04	2JZ-GE, 2JZ-GTE	2997		0-N1877	VB [BT]	S
4.3	04/99-09/04	3UZ-FE	4293	Rippenanzahl: 6	0-N2186	VB [DG]	
4.3	04/99-09/04	3UZ-FE	4293		0-N2187	VB [BT]	
4.3	04/99-09/04	3UZ-FE	4293		0-N2189S	VB [DG]	

ARISTO (UZS14_, JZS14_)

4.0 Allrad	10/92-07/97	1UZ-FE	3969		0-N2058	TB [DG]	
4.0 Allrad	10/92-07/97	1UZ-FE	3969	mit Grundträger	0-N2319	TB [TE]	
3.0	10/90-07/97	2JZ-GE, 2JZ-GTE	2997		0-N1877	VB [BT]	S
4.0 Allrad	10/92-07/97	1UZ-FE	3969	Rippenanzahl: 6	0-N2186	VB [DG]	
4.0 Allrad	10/92-07/97	1UZ-FE	3969		0-N2187	VB [BT]	
4.0 Allrad	10/92-07/97	1UZ-FE	3969		0-N2189S	VB [DG]	

ASCENT Liftback

1.8	06/01-10/03	7A-FE	1762		0-N999	TB [TE]	
-----	-------------	-------	------	--	--------	---------	--

ASCENT Stufenheck

1.8	06/01-10/03	7A-FE	1762		0-N999	TB [TE]	
-----	-------------	-------	------	--	--------	---------	--

AURION (GSV4_, ACV4_)

2.0	03/06-07/09	1AZ-FSE	1998		0-N2185	VB [VD]	
2.4	03/06-07/09	2AZ-FE	2362		0-N2185	VB [VD]	
3.5	03/06-09/11	2GR-FE, 2GR-FSE	3456	✳	0-N1728	VB [DG]	
3.5	03/06-09/11	2GR-FE	3456		0-N2032	VB [BT]	S

AURION (ACV5_, GSV5_)

3.5	09/11-	2GR-FE	3456		0-N1728	VB [DG]	
3.5	09/11-	2GR-FE	3456		0-N2032	VB [BT]	S



CM³



Art. Nr.



ohne Halter

AURIS (ZWE18_, NZE18_, ZRE18_)								
1.3	10/12-	1NR-FE	1329			0-N2393	VB [BT]	S
2.0 D-4D	10/12-	1AD-FTV	1998			0-N1482S	VB [TE]	
2.0 D-4D	10/12-	1AD-FTV	1998			0-N2040	VB [DG]	
2.0 D-4D	10/12-	1AD-FTV	1998			0-N2051	VB [DG]	
AURIS (NRE15_, ZZE15_, ADE15_, ZRE15_, NDE15_)								
1.33 Dual-VVTi	05/09-09/12	1NR-FE	1329			0-N2198	VB [BT]	S
1.4 D-4D	03/07-09/12	1ND-TV	1364	11/2008 →		0-N2107	VB [BT]	S
1.4 VVTi	03/07-09/12	4ZZ-FE	1398			0-N1462	VB [BT]	S
2.0 D-4D	03/07-09/12	1AD-FTV	1998			0-N1482S	VB [TE]	
2.0 D-4D	03/07-09/12	1AD-FTV	1998	→ 03/2011; *		0-N2040	VB [DG]	
2.0 D-4D	03/07-09/12	1AD-FTV	1998	→ 03/2011; *		0-N2040	VB [DG]	
2.0 D-4D	03/07-09/12	1AD-FTV	1998			0-N2051	VB [DG]	
2.2 D	03/07-09/12	2AD-FHV	2231			0-N1482S	VB [TE]	
2.2 D	03/07-09/12	2AD-FHV	2231	→ 03/2011; *		0-N2040	VB [DG]	
2.2 D	03/07-09/12	2AD-FHV	2231	→ 03/2011; *		0-N2040	VB [DG]	
2.2 D	03/07-09/12	2AD-FHV	2231			0-N2051	VB [DG]	
2.4 VVTi, 2.4 VVTi 4x4	04/07-	2AZ-FE	2362			0-N2185	VB [VD]	
3.5 VVTi 4x4	04/07-	2GR-FE	3456	*		0-N1728	VB [DG]	
1.4 VVTi	03/07-09/12	4ZZ-FE	1398	→ 11/2008; Baumuster: ZZE150		0-N1982	FB [DG]	
AURIS TOURING SPORTS (ADE18_, ZWE18_, ZRE18_)								
1.3	07/13-	1NR-FE	1329			0-N2393	VB [BT]	S
2.0 D-4D	07/13-	1AD-FTV	1998			0-N2040	VB [DG]	
2.0 D-4D	07/13-	1AD-FTV	1998			0-N2051	VB [DG]	
AURIS VAN Kasten (NDE15_)								
1.4 D-4D	03/07-04/13	1ND-TV	1364			0-N2107	VB [BT]	S
AVALON Stufenheck (MCX2_)								
3.0	04/00-06/05	1MZ-FE	2995	32x211		SK-1289	BTK	
2.4	08/01-04/05	2AZ-FE	2362			0-N2184	VB [BT]	S
AVALON Stufenheck (GSX3_)								
3.5 VVTi	01/05-	2GR-FE	3456	*		0-N1728	VB [DG]	
3.5 VVTi	01/05-	2GR-FE	3456			0-N2032	VB [BT]	S
AVANZA (F602_, F601_)								
1.3	12/03-	K3-VE	1298			0-N2229	VB [TE]	
1.5	08/06-	3SZ-VE	1495			0-N2273	VB [TE]	
AVANZA (F6_)								
1.5	11/11-	3SZ-VE	1495			0-N2273	VB [TE]	
AVANZA II (F65_)								
1.5	11/11-	3SZ-VE	1495			0-N2273	VB [TE]	
AVENSIS (_T22_)								
1.6	09/97-10/00	4A-FE	1587	21x117		SK-1192	BTK	
1.8	09/97-10/00	7A-FE	1762	21x121		SK-1075	BTK	
1.9 D, 2.0 D-4D	10/99-02/03	1CD-FTV	1995	25x178		SK-1589	BTK	
2.0	09/97-10/00	3S-FE	1998	27x163		SK-1186	BTK	
2.0 D-4D	10/99-02/03	1CD-FTV	1995	25x178		SK-1589AQ1	BTKW	
2.0 D-4D	10/99-02/03	1CD-FTV	1995	25x178; mit Spanndämpfer, Spannrolle		SK-1717	BTK	
2.0 D-4D	10/99-02/03	1CD-FTV	1995	25x178; mit Spanndämpfer, Spannrolle		SK-1717AQ1	BTKW	
2.0 TD	09/97-02/03	2C-TE	1975	25.4x177		SK-1062	BTK	
1.6	09/97-10/00	4A-FE	1587			0-N999	TB [TE]	
1.8	09/97-10/00	7A-FE	1762			0-N999	TB [TE]	
1.9 D, 2.0 D-4D	10/99-02/03	1CD-FTV	1995			0-N1328	TB [TE]	
1.9 D, 2.0 D-4D	10/99-02/03	1CD-FTV	1995			0-N1329	TB [DG]	
1.9 D, 2.0 D-4D	10/99-02/03	1CD-FTV	1995	hydraulisch		0-N1820	TB [BT]	
2.0	09/97-10/00	3S-FE	1998			0-N991	TB [DG]	
2.0	09/97-10/00	3S-FE	1998			0-N992	TB [TE]	
2.0 TD	09/97-02/03	2C-TE	1975			0-N995	TB [TE]	
2.0 TD	09/97-02/03	2C-TE	1975			0-N996	TB [DG]	
1.6	09/97-10/00	4A-FE	1587	10/1997 → 07/2000; Baumuster: AT220		0-N1725	VB [DG]	
1.6 VVT-i	10/00-02/03	3ZZ-FE	1598			0-N1462	VB [BT]	S
1.8	09/97-10/00	7A-FE	1762	Baumuster: AT221		0-N1725	VB [DG]	
1.8 VVT-i	10/00-02/03	1ZZ-FE	1794			0-N1462	VB [BT]	S
2.0 D-4D	10/99-02/03	1CD-FTV	1995			0-N1541	VB [DG]	
2.0 VVT-i	10/00-02/03	1AZ-FSE	1998			0-N1810	VB [BT]	S

CM³

Art. Nr.



AVENSIS (_T22_)								
2.0 VVT-i	10/00-02/03	1AZ-FSE	1998			0-N2185	VB [VD]	
AVENSIS Liftback (_T22_)								
1.6	09/97-10/00	4A-FE	1587	21x117		SK-1192	BTK	
1.8	09/97-10/00	7A-FE	1762	21x121		SK-1075	BTK	
2.0	09/97-10/00	3S-FE	1998	27x163		SK-1186	BTK	
2.0 D, 2.0 D-4D	10/99-02/03	1CD-FTV	1995	25x178		SK-1589	BTK	
2.0 D, 2.0 D-4D	10/99-02/03	1CD-FTV	1995	25x178		SK-1589AQ1	BTKW	
2.0 D, 2.0 D-4D	10/99-02/03	1CD-FTV	1995	25x178; mit Spanndämpfer, Spannrolle		SK-1717	BTK	
2.0 D, 2.0 D-4D	10/99-02/03	1CD-FTV	1995	25x178; mit Spanndämpfer, Spannrolle		SK-1717AQ1	BTKW	
2.0 TD	09/97-02/03	2C-TE	1975	25.4x177		SK-1062	BTK	
1.6	09/97-10/00	4A-FE	1587			0-N999	TB [TE]	
1.8	09/97-10/00	7A-FE	1762			0-N999	TB [TE]	
2.0	09/97-10/00	3S-FE	1998			0-N991	TB [DG]	
2.0	09/97-10/00	3S-FE	1998			0-N992	TB [TE]	
2.0 D, 2.0 D-4D	10/99-02/03	1CD-FTV	1995			0-N1328	TB [TE]	
2.0 D, 2.0 D-4D	10/99-02/03	1CD-FTV	1995			0-N1329	TB [DG]	
2.0 D, 2.0 D-4D	10/99-02/03	1CD-FTV	1995	hydraulisch		0-N1820	TB [BT]	
2.0 TD	09/97-02/03	2C-TE	1975			0-N995	TB [TE]	
2.0 TD	09/97-02/03	2C-TE	1975			0-N996	TB [DG]	
1.6	09/97-10/00	4A-FE	1587	10/1997 → 07/2000; Baumuster: AT220		0-N1725	VB [DG]	
1.6 VVT-i	10/00-02/03	3ZZ-FE	1598			0-N1462	VB [BT]	S
1.8	09/97-10/00	7A-FE	1762	Baumuster: AT221		0-N1725	VB [DG]	
1.8 VVT-i	10/00-02/03	1ZZ-FE	1794			0-N1462	VB [BT]	S
2.0 D-4D	10/99-02/03	1CD-FTV	1995			0-N1541	VB [DG]	
2.0 VVT-i	10/00-02/03	1AZ-FSE	1998			0-N1810	VB [BT]	S
2.0 VVT-i	10/00-02/03	1AZ-FSE	1998			0-N2185	VB [VD]	
AVENSIS Station Wagon (_T22_)								
1.6	09/97-10/00	4A-FE	1587	21x117		SK-1192	BTK	
1.8	09/97-10/00	7A-FE	1762	21x121		SK-1075	BTK	
1.9 D	10/97-05/98	2C-T	1974	25.4x177		SK-1062	BTK	
1.9 D, 2.0 D-4D	10/99-02/03	1CD-FTV	1995	25x178		SK-1589	BTK	
1.9 D, 2.0 D-4D	10/99-02/03	1CD-FTV	1995	25x178		SK-1589AQ1	BTKW	
1.9 D, 2.0 D-4D	10/99-02/03	1CD-FTV	1995	25x178; mit Spanndämpfer, Spannrolle		SK-1717	BTK	
1.9 D, 2.0 D-4D	10/99-02/03	1CD-FTV	1995	25x178; mit Spanndämpfer, Spannrolle		SK-1717AQ1	BTKW	
2.0	09/97-10/00	3S-FE	1998	27x163		SK-1186	BTK	
2.0 TD	09/97-02/03	2C-TE	1975	25.4x177		SK-1062	BTK	
1.6	09/97-10/00	4A-FE	1587			0-N999	TB [TE]	
1.8	09/97-10/00	7A-FE	1762			0-N999	TB [TE]	
1.9 D, 2.0 D-4D	10/99-02/03	1CD-FTV	1995			0-N1328	TB [TE]	
1.9 D, 2.0 D-4D	10/99-02/03	1CD-FTV	1995			0-N1329	TB [DG]	
1.9 D, 2.0 D-4D	10/99-02/03	1CD-FTV	1995	hydraulisch		0-N1820	TB [BT]	
2.0	09/97-10/00	3S-FE	1998			0-N991	TB [DG]	
2.0	09/97-10/00	3S-FE	1998			0-N992	TB [TE]	
2.0 TD	09/97-02/03	2C-TE	1975			0-N995	TB [TE]	
2.0 TD	09/97-02/03	2C-TE	1975			0-N996	TB [DG]	
1.6	09/97-10/00	4A-FE	1587	10/1997 → 07/2000; Baumuster: AT220		0-N1725	VB [DG]	
1.6 VVT-i	10/00-02/03	3ZZ-FE	1598			0-N1462	VB [BT]	S
1.8	09/97-10/00	7A-FE	1762	Baumuster: AT221		0-N1725	VB [DG]	
1.8 VVT-i	10/00-02/03	1ZZ-FE	1794			0-N1462	VB [BT]	S
2.0 D-4D	10/99-02/03	1CD-FTV	1995			0-N1541	VB [DG]	
2.0 VVT-i	10/00-02/03	1AZ-FSE	1998			0-N1810	VB [BT]	S
2.0 VVT-i	10/00-02/03	1AZ-FSE	1998			0-N2185	VB [VD]	
AVENSIS (T25_)								
2.0 D-4D	04/03-11/08	1CD-FTV	1995	25x178		SK-1589	BTK	
2.0 D-4D	04/03-11/08	1CD-FTV	1995	25x178; ohne Spanndämpfer, Spannrolle		SK-1589AQ2	BTKW	
2.0 D-4D	04/03-11/08	1CD-FTV	1995	25x178; mit Spanndämpfer, Spannrolle		SK-1717	BTK	
2.0 D-4D	04/03-11/08	1CD-FTV	1995	25x178; mit Spanndämpfer, Spannrolle		SK-1717AQ2	BTKW	
2.0 D-4D	04/03-11/08	1CD-FTV	1995			0-N1328	TB [TE]	
2.0 D-4D	04/03-11/08	1CD-FTV	1995			0-N1329	TB [DG]	
2.0 D-4D	04/03-11/08	1CD-FTV	1995	hydraulisch		0-N1820	TB [BT]	
1.6 VVT-i	04/03-11/08	3ZZ-FE	1598			0-N1462	VB [BT]	S
1.8	04/03-11/08	1ZZ-FE	1794			0-N1462	VB [BT]	S
2.0	04/03-11/08	1AZ-FSE	1998			0-N1810	VB [BT]	S
2.0	04/03-11/08	1AZ-FSE	1998			0-N2185	VB [VD]	

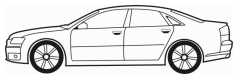

CM³



Art. Nr.



AVENSIS (T25_)

2.0 D-4D	04/03-11/08	1CD-FTV	1995		0-N2098	VB [BT]	S
2.0 D-4D	03/06-11/08	1AD-FTV	1998		0-N1482S	VB [TE]	
2.0 D-4D	03/06-11/08	1AD-FTV	1998	04/2006 → 01/2011; Baumuster: ADT250; ⚡, für Fahrzeuge mit Servolenkung	0-N2040	VB [DG]	
2.0 D-4D	03/06-11/08	1AD-FTV	1998		0-N2051	VB [DG]	
2.2 D-4D, 2.2 D-CAT	07/05-11/08	2AD-FHV, 2AD-FTV	2231		0-N1482S	VB [TE]	
2.2 D-4D, 2.2 D-CAT	07/05-11/08	2AD-FHV, 2AD-FTV	2231	→ 01/2011; Baumuster: ADT251; ⚡, für Fahrzeuge mit Servolenkung	0-N2040	VB [DG]	
2.2 D-4D, 2.2 D-CAT	07/05-11/08	2AD-FHV, 2AD-FTV	2231		0-N2051	VB [DG]	
2.4	09/03-11/08	2AZ-FSE	2362		0-N1810	VB [BT]	S
2.4	09/03-11/08	2AZ-FSE	2362		0-N2185	VB [VD]	
1.6 VVT-i	04/03-11/08	3ZZ-FE	1598	Baumuster: ZTZ250	0-N1982	FB [DG]	
1.8	04/03-11/08	1ZZ-FE	1794	Baumuster: ZTZ251; für Fahrzeuge mit elektrischer Servolenkung	0-N1982	FB [DG]	

AVENSIS Combi (T25)

2.0 D-4D	04/03-11/08	1CD-FTV	1995	25x178	SK-1589	BTK	
2.0 D-4D	04/03-11/08	1CD-FTV	1995	25x178; ohne Spanndämpfer, Spannrolle	SK-1589AQ2	BTKW	
2.0 D-4D	04/03-11/08	1CD-FTV	1995	25x178; mit Spanndämpfer, Spannrolle	SK-1717	BTK	
2.0 D-4D	04/03-11/08	1CD-FTV	1995	25x178; mit Spanndämpfer, Spannrolle	SK-1717AQ2	BTKW	
2.0 D-4D	04/03-11/08	1CD-FTV	1995		0-N1328	TB [TE]	
2.0 D-4D	04/03-11/08	1CD-FTV	1995		0-N1329	TB [DG]	
2.0 D-4D	04/03-11/08	1CD-FTV	1995	hydraulisch	0-N1820	TB [BT]	
1.6 VVT-i	04/03-11/08	3ZZ-FE	1598		0-N1462	VB [BT]	S
1.8	04/03-11/08	1ZZ-FE	1794		0-N1462	VB [BT]	S
2.0	04/03-11/08	1AZ-FSE	1998		0-N1810	VB [BT]	S
2.0 D-4D	04/03-11/08	1CD-FTV	1995		0-N2098	VB [BT]	S
2.0 D-4D	03/06-11/08	1AD-FTV	1998		0-N1482S	VB [TE]	
2.0 D-4D	03/06-11/08	1AD-FTV	1998	04/2006 → 01/2011; Baumuster: ADT250; ⚡, für Fahrzeuge mit Servolenkung	0-N2040	VB [DG]	
2.0 D-4D	03/06-11/08	1AD-FTV	1998		0-N2051	VB [DG]	
2.0, 2.0 VVTi	04/03-11/08	1AZ-FE, 1AZ-FSE	1998		0-N2185	VB [VD]	
2.2 D-4D, 2.2 D-CAT	07/05-11/08	2AD-FHV, 2AD-FTV	2231		0-N1482S	VB [TE]	
2.2 D-4D, 2.2 D-CAT	07/05-11/08	2AD-FHV, 2AD-FTV	2231	→ 01/2011; Baumuster: ADT251; ⚡, für Fahrzeuge mit Servolenkung	0-N2040	VB [DG]	
2.2 D-4D, 2.2 D-CAT	07/05-11/08	2AD-FHV, 2AD-FTV	2231		0-N2051	VB [DG]	
2.4	09/03-11/08	2AZ-FSE	2362		0-N1810	VB [BT]	S
2.4	09/03-11/08	2AZ-FSE	2362		0-N2185	VB [VD]	
1.6 VVT-i	04/03-11/08	3ZZ-FE	1598	Baumuster: ZTZ250	0-N1982	FB [DG]	
1.8	04/03-11/08	1ZZ-FE	1794	Baumuster: ZTZ251; für Fahrzeuge mit elektrischer Servolenkung	0-N1982	FB [DG]	

AVENSIS Stufenheck (T25)

2.0 D-4D	04/03-11/08	1CD-FTV	1995	25x178	SK-1589	BTK	
2.0 D-4D	04/03-11/08	1CD-FTV	1995	25x178; ohne Spanndämpfer, Spannrolle	SK-1589AQ2	BTKW	
2.0 D-4D	04/03-11/08	1CD-FTV	1995	25x178; mit Spanndämpfer, Spannrolle	SK-1717	BTK	
2.0 D-4D	04/03-11/08	1CD-FTV	1995	25x178; mit Spanndämpfer, Spannrolle	SK-1717AQ2	BTKW	
2.0 D-4D	04/03-11/08	1CD-FTV	1995		0-N1328	TB [TE]	
2.0 D-4D	04/03-11/08	1CD-FTV	1995		0-N1329	TB [DG]	
2.0 D-4D	04/03-11/08	1CD-FTV	1995	hydraulisch	0-N1820	TB [BT]	
1.6 VVT-i	04/03-11/08	3ZZ-FE	1598		0-N1462	VB [BT]	S
1.8	04/03-11/08	1ZZ-FE	1794		0-N1462	VB [BT]	S
2.0	04/03-11/08	1AZ-FSE	1998		0-N1810	VB [BT]	S
2.0 D-4D	04/03-11/08	1CD-FTV	1995		0-N2098	VB [BT]	S
2.0 D-4D	03/06-11/08	1AD-FTV	1998		0-N1482S	VB [TE]	
2.0 D-4D	03/06-11/08	1AD-FTV	1998	04/2006 → 01/2011; Baumuster: ADT250; ⚡, für Fahrzeuge mit Servolenkung	0-N2040	VB [DG]	
2.0 D-4D	03/06-11/08	1AD-FTV	1998		0-N2051	VB [DG]	
2.0, 2.0 VVTi	04/03-11/08	1AZ-FE, 1AZ-FSE	1998		0-N2185	VB [VD]	
2.2 D-4D, 2.2 D-CAT	07/05-11/08	2AD-FHV, 2AD-FTV	2231		0-N1482S	VB [TE]	
2.2 D-4D, 2.2 D-CAT	07/05-11/08	2AD-FHV, 2AD-FTV	2231	→ 01/2011; Baumuster: ADT251; ⚡, für Fahrzeuge mit Servolenkung	0-N2040	VB [DG]	
2.2 D-4D, 2.2 D-CAT	07/05-11/08	2AD-FHV, 2AD-FTV	2231		0-N2051	VB [DG]	
2.4	09/03-11/08	2AZ-FSE	2362		0-N1810	VB [BT]	S
2.4	09/03-11/08	2AZ-FSE	2362		0-N2185	VB [VD]	
1.6 VVT-i	04/03-11/08	3ZZ-FE	1598	Baumuster: ZTZ250	0-N1982	FB [DG]	
1.8	04/03-11/08	1ZZ-FE	1794	Baumuster: ZTZ251; für Fahrzeuge mit elektrischer Servolenkung	0-N1982	FB [DG]	

CM³

Art. Nr.

**AVENSIS Station Wagon (ZRT27, ADT27)**

2.0 D-4D	02/09-	1AD-FTV	1998		0-N1482S	VB [TE]	
2.0 D-4D	02/09-	1AD-FTV	1998	→ 03/2011; Baumuster: ADT270; für Fahrzeuge mit Servolenkung, ☼	0-N2040	VB [DG]	
2.0 D-4D	02/09-	1AD-FTV	1998	→ 03/2011; Baumuster: ADT270; ☼, für Fahrzeuge mit Servolenkung	0-N2040	VB [DG]	
2.0 D-4D	02/09-	1AD-FTV	1998	Baumuster: ADT270; für Fahrzeuge mit Servolenkung	0-N2051	VB [DG]	
2.0 D-4D	11/11-	1AD-FTV	1998		0-N2040	VB [DG]	
2.0 D-4D	11/11-	1AD-FTV	1998		0-N2051	VB [DG]	
2.2 D-4D	02/09-	2AD-FHV, 2AD-FHV, 2AD-FTV	2231		0-N1482S	VB [TE]	
2.2 D-4D	02/09-	2AD-FHV, 2AD-FHV, 2AD-FTV	2231	→ 03/2011; Baumuster: ADT271; für Fahrzeuge mit Servolenkung, ☼	0-N2040	VB [DG]	
2.2 D-4D	02/09-	2AD-FHV, 2AD-FHV, 2AD-FTV	2231	→ 03/2011; Baumuster: ADT271; ☼, für Fahrzeuge mit Servolenkung	0-N2040	VB [DG]	
2.2 D-4D	02/09-	2AD-FHV, 2AD-FHV, 2AD-FTV	2231	Baumuster: ADT271; für Fahrzeuge mit Servolenkung	0-N2051	VB [DG]	

AVENSIS Stufenheck (ZRT27, ADT27)

2.0 D-4D	11/08-	1AD-FTV	1998		0-N1482S	VB [TE]	
2.0 D-4D	11/08-	1AD-FTV	1998	→ 03/2011; Baumuster: ADT270; für Fahrzeuge mit Servolenkung, ☼	0-N2040	VB [DG]	
2.0 D-4D	11/08-	1AD-FTV	1998	→ 03/2011; Baumuster: ADT270; ☼, für Fahrzeuge mit Servolenkung	0-N2040	VB [DG]	
2.0 D-4D	11/08-	1AD-FTV	1998	Baumuster: ADT270; für Fahrzeuge mit Servolenkung	0-N2051	VB [DG]	
2.0 D-4D	11/11-	1AD-FTV	1998		0-N2040	VB [DG]	
2.0 D-4D	11/11-	1AD-FTV	1998		0-N2051	VB [DG]	
2.2 D-4D	11/08-	2AD-FHV, 2AD-FHV, 2AD-FTV	2231		0-N1482S	VB [TE]	
2.2 D-4D	11/08-	2AD-FHV, 2AD-FHV, 2AD-FTV	2231	→ 03/2011; Baumuster: ADT271; für Fahrzeuge mit Servolenkung, ☼	0-N2040	VB [DG]	
2.2 D-4D	11/08-	2AD-FHV, 2AD-FHV, 2AD-FTV	2231	→ 03/2011; Baumuster: ADT271; ☼, für Fahrzeuge mit Servolenkung	0-N2040	VB [DG]	
2.2 D-4D	11/08-	2AD-FHV, 2AD-FHV, 2AD-FTV	2231	Baumuster: ADT271; für Fahrzeuge mit Servolenkung	0-N2051	VB [DG]	

AVENSIS VERSO (_CLM2_, _ACM2_)

2.0 D-4D	08/01-08/05	1CD-FTV	1995	25x178	SK-1589	BTK	
2.0 D-4D	08/01-08/05	1CD-FTV	1995	25x178; Baumuster: Sportsvan	SK-1589AQ1	BTKW	
2.0 D-4D	08/01-08/05	1CD-FTV	1995	25x178; mit Spanndämpfer, Spannrolle; Baumuster: Sportsvan	SK-1717	BTK	
2.0 D-4D	08/01-08/05	1CD-FTV	1995	25x178; mit Spanndämpfer, Spannrolle; Baumuster: Sportsvan	SK-1717AQ1	BTKW	
2.0 D-4D	08/01-08/05	1CD-FTV	1995		0-N1328	TB [TE]	
2.0 D-4D	08/01-08/05	1CD-FTV	1995		0-N1329	TB [DG]	
2.0 D-4D	08/01-08/05	1CD-FTV	1995	hydraulisch	0-N1820	TB [BT]	
2.0 D-4D	08/01-08/05	1CD-FTV	1995		0-N2098	VB [BT]	S
2.0 VVT-i	08/01-11/09	1AZ-FE	1998		0-N1810	VB [BT]	S
2.0 VVT-i	08/01-11/09	1AZ-FE	1998		0-N2185	VB [VD]	
2.4 VVTi 4x4, 2.4 VVTi GLS	10/03-11/09	2AZ-FE	2362		0-N2185	VB [VD]	

AYGO (WNB1_, KGB1_)

1.4 HDi	07/05-08/10	2WZ-TV	1398	25.4x144	SK-1391	BTK	
1.4 HDi	07/05-08/10	2WZ-TV	1398	25.4x144	SK-1391AQ1	BTKW	
1.4 HDi	07/05-08/10	2WZ-TV	1398		0-N1062	TB [TE]	
1.4 HDi	07/05-08/10	2WZ-TV	1398		0-N1066	TB [DG]	
1.4 HDi	07/05-08/10	2WZ-TV	1398		0-N1339	VB [BT]	S
1.4 HDi	07/05-08/10	2WZ-TV	1398		0-N1418	VB [DG]	

bB II (QNC2_)

1.3, 1.3 4WD	12/05-	K3-VE	1298		0-N2229	VB [TE]	
1.5	12/05-	3SZ-VE	1495		0-N2273	VB [TE]	

BREVIS (JCG1_)

2.5	10/99-09/02	1JZ-FSE	2491		0-N2183	VB [BT]	S
3.0	10/99-06/07	2JZ-FSE	2997		0-N1877	VB [BT]	S

CALDINA (ST19_, ET19_, CT19_, AT19_)

1.6	02/92-09/97	4A-FE	1587		0-N999	TB [TE]	
1.8	02/92-09/97	7A-FE	1762		0-N999	TB [TE]	

CALDINA (ST21_, CT21_, AT21_)

1.8	10/97-09/01	7A-FE	1762		0-N999	TB [TE]	
-----	-------------	-------	------	--	---------------	---------	--

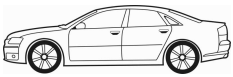

CM³



Art. Nr.



CALDINA (ZZT24_, ST24_, AZT24_)

2.0	09/02-06/07	1AZ-FSE	1998		0-N2185	VB [VD]
-----	-------------	---------	------	--	---------	---------

CAMI Geländewagen geschlossen (J12_E, J10_E)

1.3, 1.3 4x4	06/99-12/05	K3-VE, K3-VET	1298		0-N2229	VB [TE]
--------------	-------------	---------------	------	--	---------	---------

CAMRY Liftback (_V1_)

1.8 Turbo-D	10/84-01/88	1C-TL	1840	25.4x177	SK-1062	BTK
1.8	02/83-10/86	1S-L	1832		0-N990	TB [TE]
1.8	02/83-10/86	1S-L	1832		0-N991	TB [DG]
1.8 Turbo-D	10/84-01/88	1C-TL	1840		0-N995	TB [TE]
1.8 Turbo-D	10/84-01/88	1C-TL	1840		0-N996	TB [DG]
2.0	04/86-01/88	2S-ELC	1995		0-N990	TB [TE]
2.0	04/86-01/88	2S-ELC	1995		0-N991	TB [DG]

CAMRY Stufenheck (_V1_)

1.8 Turbo-D	11/83-01/88	1C-TL	1840	25.4x177	SK-1062	BTK
1.8	02/83-10/86	1S-L	1832		0-N990	TB [TE]
1.8	02/83-10/86	1S-L	1832		0-N991	TB [DG]
1.8 Turbo-D	11/83-01/88	1C-TL	1840		0-N995	TB [TE]
1.8 Turbo-D	11/83-01/88	1C-TL	1840		0-N996	TB [DG]
2.0, 2.0 GLI	03/83-01/88	2S-E, 2S-ELC, 2S-EL	1995		0-N990	TB [TE]
2.0, 2.0 GLI	03/83-01/88	2S-E, 2S-ELC, 2S-EL	1995		0-N991	TB [DG]

CAMRY (_V2_)

2.0, 2.0 4x4, 2.0 Gli 16V	11/86-06/91	3S-FC, 3S-FE	1998	27x163	SK-1186	BTK
2.0 Turbo-D	11/86-05/91	2C-T	1975	25.4x177	SK-1062	BTK
2.5 V6 GXI	02/88-05/91	2VZ-FE	2508	32x179	SK-1278	BTK
1.8 i	10/86-08/88	1S-L	1832		0-N990	TB [TE]
1.8 i	10/86-08/88	1S-L	1832		0-N991	TB [DG]
2.0, 2.0 Gli 16V	11/86-05/91	3S-FE	1998		0-N991	TB [DG]
2.0, 2.0 Gli 16V	11/86-05/91	3S-FE	1998		0-N992	TB [TE]
2.0 Turbo-D	11/86-05/91	2C-T	1975		0-N995	TB [TE]
2.0 Turbo-D	11/86-05/91	2C-T	1975		0-N996	TB [DG]
2.5 V6 GXI	02/88-05/91	2VZ-FE	2508		0-N993	TB [TE]
2.5 V6 GXI	02/88-05/91	2VZ-FE	2508		0-N994	TB [DG]

CAMRY Station Wagon (_V2_)

2.0, 2.0 GLi 16V, 2.0 GLi 4x4	11/86-05/91	3S-FE	1998	27x163	SK-1186	BTK
2.0 Turbo-D	11/86-05/91	2C-T	1975	25.4x177	SK-1062	BTK
2.5	01/90-05/91	2VZ-FE	2508	32x179	SK-1278	BTK
1.8	11/86-08/88	1S	1832		0-N990	TB [TE]
1.8	11/86-08/88	1S	1832		0-N991	TB [DG]
2.0, 2.0 GLi 16V	11/86-05/91	3S-FE	1998		0-N991	TB [DG]
2.0, 2.0 GLi 16V	11/86-05/91	3S-FE	1998		0-N992	TB [TE]
2.0 Turbo-D	11/86-05/91	2C-T	1975		0-N995	TB [TE]
2.0 Turbo-D	11/86-05/91	2C-T	1975		0-N996	TB [DG]
2.5	01/90-05/91	2VZ-FE	2508		0-N993	TB [TE]
2.5	01/90-05/91	2VZ-FE	2508		0-N994	TB [DG]

CAMRY (_CV1_, _XV1_, _V1_)

2.0 ZX	08/93-09/97	3S-FSE	1998	27x163	SK-1186	BTK
2.2	06/91-08/96	5S-FE	2164	27x163	SK-1186	BTK
2.5	06/91-07/96	4VZ-FE	2497	32x179; 08/1993 →	SK-1278	BTK
2000ZX Allrad	06/91-09/97	3S-FE	1998	27x163; 08/1993 →	SK-1186	BTK
3.0	06/91-08/96	3VZ-FE	2959	32x191	SK-1274	BTK
3.0	09/93-07/96	1MZ-FE	2995	32x211	SK-1289	BTK
2.2	06/91-08/96	5S-FE	2164		0-N991	TB [DG]
2.2	06/91-08/96	5S-FE	2164		0-N992	TB [TE]
3.0	06/91-08/96	3VZ-FE	2959		0-N993	TB [TE]
3.0	06/91-08/96	3VZ-FE	2959		0-N994	TB [DG]

CAMRY Station Wagon (_XV1_, _CV1_, _V10)

2.2	03/92-07/96	5S-FE	2164	27x163	SK-1186	BTK
3.0	03/92-07/96	3VZ-FE	2959	32x191	SK-1274	BTK
2.2	03/92-07/96	5S-FE	2164		0-N991	TB [DG]
2.2	03/92-07/96	5S-FE	2164		0-N992	TB [TE]
3.0	03/92-07/96	3VZ-FE	2959		0-N993	TB [TE]
3.0	03/92-07/96	3VZ-FE	2959		0-N994	TB [DG]

CM³

Art. Nr.

**CAMRY (_CV2_, _XV2_)**

2.2	08/96-11/01	5S-FE	2164	27x163	SK-1186	BTK
3.0 24V, 3.0 V6	08/96-11/01	1MZ-FE	2995	32x211	SK-1289	BTK
2.2	08/96-11/01	5S-FE	2164		0-N991	TB [DG]
2.2	08/96-11/01	5S-FE	2164		0-N992	TB [TE]
3.0 24V, 3.0 V6	08/96-11/01	1MZ-FE	2995		0-N993	TB [TE]
3.0 24V, 3.0 V6	08/96-11/01	1MZ-FE	2995		0-N994	TB [DG]

CAMRY (MCV3_, ACV3_, XV3_)

3.0 V6	11/01-11/06	1MZ-FE	2995		0-N1761	TB [BT]
3.0 V6	11/01-11/06	1MZ-FE	2995		0-N994	TB [DG]
2.0 VVTi	08/01-11/06	1AZ-FE	1998		0-N2185	VB [VD]
2.4 VVT-i	11/01-11/06	2AZ-FE	2362		0-N1810	VB [BT] S
2.4 VVT-i, 2.4 VVTi LE	11/01-11/06	2AZ-FE	2362		0-N2185	VB [VD]
3.5 VVTi XLE	01/06-11/06	2GR-FE	3456	*	0-N1728	VB [DG]
3.5 VVTi XLE	01/06-11/06	2GR-FE	3456		0-N2032	VB [BT] S

CAMRY Stufenheck (_XV4_)

2.0 VVT-i	01/06-09/11	1AZ-FE	1998		0-N2185	VB [VD]
2.4 VVTi	01/06-09/11	2AZ-FE	2362		0-N2184	VB [BT] S
3.5	01/08-09/11	2GR-FE	3456	*	0-N1728	VB [DG]
3.5	01/08-09/11	2GR-FE	3456		0-N2032	VB [BT] S

CAMRY Stufenheck (AVV5_, XV5_)

2.0	09/11-	1AZ-FE	1998		0-N2185	VB [VD]
3.5	09/11-	2GR-FE	3456	*	0-N1728	VB [DG]
3.5	09/11-	2GR-FE	3456		0-N2032	VB [BT] S

CAMRY SOLARA Cabriolet (MCV3_, ACV3_)

2.4	02/04-11/08	2AZ-FE	2362		0-N2184	VB [BT] S
-----	-------------	--------	------	--	---------	-----------

CAMRY SOLARA Coupe (MCV3_, ACV3_)

2.4	07/03-07/08	2AZ-FE	2362		0-N2184	VB [BT] S
-----	-------------	--------	------	--	---------	-----------

CARIBE Station Wagon

1.3	09/94-08/96	4E-FE	1332		0-N007	TB [TE]
1.3	09/94-08/96	4E-FE	1332		0-N008	TB [DG]
1.6	09/94-08/03	4A-FE	1587		0-N999	TB [TE]

CARINA (TA4L, TA6_L)

1.8 D	04/82-09/83	1C	1840	25.4x177	SK-1062	BTK
-------	-------------	----	------	----------	---------	-----

CARINA Station Wagon (TA4K, TA6K)

1.8 D	04/82-09/83	1C	1840	25.4x177	SK-1062	BTK
-------	-------------	----	------	----------	---------	-----

CARINA II (_T15_)

1.6	10/83-11/87	4A-L	1588	19x88	SK-1650	BTK
1.6	10/83-11/87	4A-LC	1587	19x88	SK-1650	BTK
2.0 D	02/84-05/88	2C-L	1974	25.4x177	SK-1062	BTK
1.6	10/83-11/87	4A-L	1588		0-N997	TB [TE]
1.6	10/83-11/87	4A-LC	1587		0-N997	TB [TE]
1.8 GLI	10/83-11/87	1S-L	1832		0-N990	TB [TE]
1.8 GLI	10/83-11/87	1S-L	1832		0-N991	TB [DG]
2.0 D	02/84-05/88	2C-L	1974		0-N995	TB [TE]
2.0 D	02/84-05/88	2C-L	1974		0-N996	TB [DG]

CARINA II Stufenheck (_T15_)

1.6	10/83-11/87	4A-L	1588	19x88	SK-1650	BTK
1.6	10/83-11/87	4A-LC	1587	19x88	SK-1650	BTK
2.0 D	02/84-05/88	2C-L	1974	25.4x177	SK-1062	BTK
1.6	10/83-11/87	4A-L	1588		0-N997	TB [TE]
1.6	10/83-11/87	4A-LC	1587		0-N997	TB [TE]
1.8 GLI	10/83-11/87	1S-EL	1832		0-N990	TB [TE]
1.8 GLI	10/83-11/87	1S-EL	1832		0-N991	TB [DG]
2.0 D	02/84-05/88	2C-L	1974		0-N995	TB [TE]
2.0 D	02/84-05/88	2C-L	1974		0-N996	TB [DG]

CARINA II (_T17_)

1.6	12/87-03/92	4A-F, 4A-FE	1587	19x94	SK-1275	BTK
2.0 D	03/88-06/92	2C-L	1974	25.4x177	SK-1062	BTK
2.0 GLI	12/87-03/92	3S-FE	1998	27x163	SK-1186	BTK
1.6	12/87-03/92	4A-F, 4A-FE	1587		0-N997	TB [TE]
2.0 D	03/88-06/92	2C-L	1974		0-N995	TB [TE]



CM³



Art. Nr.



CARINA II (_T17_)							
2.0 D	03/88-06/92	2C-L	1974			0-N996	TB [DG]
2.0 GLI	12/87-03/92	3S-FE	1998			0-N991	TB [DG]
2.0 GLI	12/87-03/92	3S-FE	1998			0-N992	TB [TE]
1.6 , 1.6 4x4	12/87-03/92	4A-F, 4A-FE	1587	Baumuster: AT171		0-N1725	VB [DG]
CARINA II Station Wagon (_T17_)							
1.6	12/87-03/92	4A-F, 4A-FE	1587	19x94		SK-1275	BTK
2.0 D	12/87-01/92	2C-L	1975	25.4x177		SK-1062	BTK
2.0, 2.0 GLi	12/87-04/92	3S-FE	1998	27x163		SK-1186	BTK
1.6	12/87-03/92	4A-F, 4A-FE	1587			0-N997	TB [TE]
2.0	12/87-04/92	3S-FE	1998			0-N991	TB [DG]
2.0	12/87-04/92	3S-FE	1998			0-N992	TB [TE]
2.0 D	12/87-01/92	2C-L	1975			0-N995	TB [TE]
2.0 D	12/87-01/92	2C-L	1975			0-N996	TB [DG]
1.6	12/87-03/92	4A-F, 4A-FE	1587	Baumuster: AT171		0-N1725	VB [DG]
CARINA II Stufenheck (_T17_)							
1.6	12/87-03/92	4A-F, 4A-FE	1587	19x94		SK-1275	BTK
2.0 D	03/88-06/92	2C	1974	25.4x177		SK-1062	BTK
2.0 GLI	12/87-03/92	3S-FE	1998	27x163		SK-1186	BTK
1.6	12/87-03/92	4A-F, 4A-FE	1587			0-N997	TB [TE]
2.0 D	03/88-06/92	2C	1974			0-N995	TB [TE]
2.0 D	03/88-06/92	2C	1974			0-N996	TB [DG]
2.0 GLI	12/87-03/92	3S-FE	1998			0-N991	TB [DG]
2.0 GLI	12/87-03/92	3S-FE	1998			0-N992	TB [TE]
1.6 , 1.6 4x4	12/87-03/92	4A-F, 4A-FE	1587	Baumuster: AT171		0-N1725	VB [DG]
2.0 D	03/88-06/92	2C	1974	→ 11/1992; ⚠, für Fahrzeuge mit Servolenkung		0-N1725	VB [DG]
CARINA E (_T19_)							
1.6 , 1.6 16V, 1.6 GLI	04/92-09/97	4A-FE	1587	21x117		SK-1192	BTK
1.8 , 1.8 GL	10/94-09/97	7A-FE	1762	21x121		SK-1075	BTK
2.0 D , 2.0 TD	04/92-09/97	2C, 2C-T	1975	25.4x177		SK-1062	BTK
2.0 GLI	04/92-09/97	3S-FE	1998	27x163		SK-1186	BTK
2.0 GTi	04/92-02/94	3S-GE	1998	25x178		SK-1187	BTK
2.0 i	12/93-09/97	3S-FE	1998	27x163; 11/1994 →		SK-1186	BTK
1.6 , 1.6 16V, 1.6 GLI	04/92-09/97	4A-FE	1587			0-N999	TB [TE]
1.8 , 1.8 GL	10/94-09/97	7A-FE	1762			0-N999	TB [TE]
2.0 D , 2.0 TD	04/92-09/97	2C, 2C-T	1975			0-N995	TB [TE]
2.0 D , 2.0 TD	04/92-09/97	2C, 2C-T	1975			0-N996	TB [DG]
2.0 GLI , 2.0 GTi , 2.0 GTi 16V , 2.0 i	04/92-09/97	3S-FE, 3S-GE	1998			0-N991	TB [DG]
2.0 GLI , 2.0 i	04/92-09/97	3S-FE	1998			0-N992	TB [TE]
2.0 GTi	04/92-02/94	3S-GE	1998			0-N000	TB [TE]
2.0 GTi 16V	03/94-09/97	3S-GE	1998			0-N2298	TB [BT]
1.6 , 1.6 16V, 1.6 GLI	04/92-09/97	4A-FE	1587	→ 01/1996; Baumuster: AT190		0-N1725	VB [DG]
1.8	01/95-09/97	7A-FE	1762	Baumuster: AT191		0-N1725	VB [DG]
2.0 D	04/92-01/96	2C	1975	12/1994 →		0-N1541	VB [DG]
2.0 D	04/92-01/96	2C	1975	⚠, für Fahrzeuge mit Servolenkung		0-N1725	VB [DG]
2.0 TD	01/96-09/97	2C-T	1975			0-N1541	VB [DG]
CARINA E Sportswagon (_T19_)							
1.6, 1.6 GLI , 1.6 i	04/92-09/97	4A-FE	1587	21x117		SK-1192	BTK
1.8 GL, 1.8 i	10/94-09/97	7A-FE	1762	21x121		SK-1075	BTK
2.0 D , 2.0 TD	01/93-09/97	2C, 2C-T	1975	25.4x177		SK-1062	BTK
2.0 GLI , 2.0 i	01/93-09/97	3S-FE	1998	27x163		SK-1186	BTK
1.6, 1.6 GLI , 1.6 i	04/92-09/97	4A-FE	1587			0-N999	TB [TE]
1.8 GL	10/94-09/97	7A-FE	1762			0-N2298	TB [BT]
1.8 GL, 1.8 i	10/94-09/97	7A-FE	1762			0-N999	TB [TE]
2.0 D , 2.0 TD	01/93-09/97	2C, 2C-T	1975			0-N995	TB [TE]
2.0 D , 2.0 TD	01/93-09/97	2C, 2C-T	1975			0-N996	TB [DG]
2.0 GLI	01/93-09/97	3S-FE	1998	06/1995 →		0-N2298	TB [BT]
2.0 GLI , 2.0 i	01/93-09/97	3S-FE	1998			0-N991	TB [DG]
2.0 GLI , 2.0 i	01/93-09/97	3S-FE	1998			0-N992	TB [TE]
1.6, 1.6 GLI , 1.6 i	04/92-09/97	4A-FE	1587	→ 01/1996; Baumuster: AT190		0-N1725	VB [DG]
1.8 i	02/95-09/97	7A-FE	1762	Baumuster: AT191		0-N1725	VB [DG]
2.0 D	01/93-01/96	2C	1975	05/1995 →		0-N1541	VB [DG]
2.0 D	01/93-01/96	2C	1975	⚠, für Fahrzeuge mit Servolenkung		0-N1725	VB [DG]



CM³



Art. Nr.



ohne Halter

CARINA E Stufenheck (_T19_)								
1.6, 1.6 16V	01/93-09/97	4A-FE	1587	21x117		SK-1192	BTK	
1.8 GL, 1.8 i 16V	10/94-09/97	7A-FE	1762	21x121		SK-1075	BTK	
2.0, 2.0 i	12/92-09/97	3S-FE	1998	27x163		SK-1186	BTK	
2.0 D, 2.0 TD	08/92-09/97	2C, 2C-T	1975	25.4x177		SK-1062	BTK	
2.0 GTi	04/92-02/94	3S-GE	1998	25x178		SK-1187	BTK	
1.6, 1.6 16V	01/93-09/97	4A-FE	1587			0-N999	TB [TE]	
1.8, 1.8 GL, 1.8 i 16V	04/92-09/97	7A-FE	1762			0-N999	TB [TE]	
2.0, 2.0 GTi, 2.0 GTi 16V, 2.0 i	04/92-09/97	3S-FE, 3S-GE	1998			0-N991	TB [DG]	
2.0, 2.0 i	12/92-09/97	3S-FE	1998			0-N992	TB [TE]	
2.0 D	08/92-01/96	2C	1975	12/1994 →		0-N2298	TB [BT]	
2.0 D, 2.0 TD	08/92-09/97	2C, 2C-T	1975			0-N995	TB [TE]	
2.0 D, 2.0 TD	08/92-09/97	2C, 2C-T	1975			0-N996	TB [DG]	
2.0 GTi	04/92-02/94	3S-GE	1998			0-N000	TB [TE]	
2.0 GTi 16V	03/94-09/97	3S-GE	1998			0-N2298	TB [BT]	
1.6, 1.6 16V	01/93-09/97	4A-FE	1587	→ 01/1996; Baumuster: AT190		0-N1725	VB [DG]	
1.8, 1.8 i 16V	04/92-09/97	7A-FE	1762	Baumuster: AT191		0-N1725	VB [DG]	
2.0 D	08/92-01/96	2C	1975	12/1994 →		0-N1541	VB [DG]	
2.0 D	08/92-01/96	2C	1975	☛, für Fahrzeuge mit Servolenkung		0-N1725	VB [DG]	
2.0 TD	01/96-09/97	2C-T	1975			0-N1541	VB [DG]	
CELICA (TA60, RA40, RA6_)								
1.6	08/83-07/85	4A-GE	1587	19x113		SK-1197	BTK	
CELICA Coupe (_A6_)								
1.6	12/83-12/85	4A-GE	1587	19x113		SK-1197	BTK	
1.6	12/83-12/85	4A-GE	1587			0-N998	TB [TE]	
CELICA (AT16_, ST16_)								
1.6	04/86-08/89	4A-L	1588	19x88		SK-1650	BTK	
1.6 GT 16V	04/86-08/89	4A-GEL	1587	19x113		SK-1197	BTK	
1.6	04/86-08/89	4A-L	1588			0-N997	TB [TE]	
1.6 GT 16V	04/86-08/89	4A-GEL	1587			0-N998	TB [TE]	
2.0	01/87-08/89	3S-GEL	1998			0-N001	TB [TE]	
2.0	01/87-08/89	3S-GEL	1998			0-N991	TB [DG]	
CELICA Cabriolet (ST16_, AT16_)								
2.0 GT	08/85-08/89	3S-GEL, 3S-GELC	1998			0-N001	TB [TE]	
2.0 GT	08/85-08/89	3S-GEL, 3S-GELC	1998			0-N991	TB [DG]	
CELICA Coupe (ST16_, AT16_)								
2.0 Turbo 4x4	03/88-08/89	3S-GTE	1998			0-N000	TB [TE]	
2.0 Turbo 4x4	03/88-08/89	3S-GTE	1998			0-N991	TB [DG]	
CELICA Liftback (ST16_, AT16_)								
1.6	04/86-08/89	4A-L	1588	19x88		SK-1650	BTK	
1.6 GT, 1.6 GT 16V	09/85-08/89	4A-GEL, 4A-GELC	1587	19x113		SK-1197	BTK	
1.6	04/86-08/89	4A-L	1588			0-N997	TB [TE]	
1.6 GT, 1.6 GT 16V	09/85-08/89	4A-GEL, 4A-GELC	1587			0-N998	TB [TE]	
2.0 GT	08/85-08/89	3S-GEL, 3S-GELC	1998			0-N001	TB [TE]	
2.0 GT	08/85-08/89	3S-GEL, 3S-GELC	1998			0-N991	TB [DG]	
CELICA Cabriolet (AT18_, ST18_)								
2.0 GTi	10/89-11/93	3S-GE	1998	25x178; 05/1991 →		SK-1187	BTK	
2.0 GTi	10/89-11/93	3S-GE	1998			0-N000	TB [TE]	
2.0 GTi	10/89-11/93	3S-GE	1998			0-N991	TB [DG]	
CELICA Coupe (AT18_, ST18_)								
1.6 STi	10/89-11/93	4A-FE	1587	19x94		SK-1275	BTK	
2.0 GTi, 2.0 Turbo 4WD	10/89-11/93	3S-GE, 3S-GTE	1998	25x178		SK-1187	BTK	
1.6 STi	10/89-11/93	4A-FE	1587			0-N997	TB [TE]	
2.0 GTi, 2.0 Turbo 4WD	10/89-11/93	3S-GE, 3S-GTE	1998			0-N000	TB [TE]	
2.0 GTi, 2.0 Turbo 4WD	10/89-11/93	3S-GE, 3S-GTE	1998			0-N991	TB [DG]	
CELICA (ST20_, AT20_)								
1.8 i 16V	11/93-11/99	7A-FE	1762	21x121		SK-1075	BTK	
1.8 i 16V	11/93-11/99	7A-FE	1762			0-N999	TB [TE]	
2.0 i 16V	11/93-11/99	3S-GE	1998	03/1994 →		0-N2298	TB [BT]	
2.0 i 16V	04/96-11/99	3S-GE	1998			0-N2298	TB [BT]	
2.0 i 16V, 2.0 i Turbo 4WD	11/93-11/99	3S-GE, 3S-GTE	1998			0-N991	TB [DG]	
2.0 i Turbo 4WD	02/94-11/99	3S-GTE	1998	05/1994 →		0-N2298	TB [BT]	
1.8 i 16V	11/93-11/99	7A-FE	1762	Baumuster: AT200		0-N1725	VB [DG]	



CM³



Art. Nr.



CELICA Cabriolet (AT20_, ST20_)							
2.0 GTi	08/94-08/99	3S-GE	1998			0-N2298	TB [BT]
2.0 i 16V	11/93-08/99	3S-GE	1998	04/1996 →		0-N2298	TB [BT]
2.0 i 16V	11/93-08/99	3S-GE	1998			0-N991	TB [DG]
CELICA (ZZT23_)							
1.8 16V TS	08/99-09/05	2ZZ-GE	1796			0-N1462	VB [BT] S
1.8 16V VT-i	08/99-07/05	1ZZ-FE	1794			0-N1462	VB [BT] S
CELSIOR (UCF1_)							
4.0	12/88-08/00	1UZ-FE	3969			0-N1823	TB [BT]
4.0	12/88-08/00	1UZ-FE	3969			0-N2058	TB [DG]
4.0	12/88-09/96	1UZ-FE	3969	mit Grundträger		0-N2319	TB [TE]
4.0	10/96-08/00	1UZ-FE	3969	07/1997 →		0-N1883	TB [BT] S
4.0	12/88-08/00	1UZ-FE	3969	Rippenanzahl: 6		0-N2186	VB [DG]
4.0	12/88-08/00	1UZ-FE	3969			0-N2187	VB [BT]
4.0	12/88-08/00	1UZ-FE	3969			0-N2189S	VB [DG]
CELSIOR (UCF2_)							
4.0	05/93-08/00	1UZ-FE	3969			0-N1823	TB [BT]
4.0	05/93-08/00	1UZ-FE	3969			0-N2058	TB [DG]
4.0	05/93-09/96	1UZ-FE	3969	mit Grundträger		0-N2319	TB [TE]
4.0	10/96-08/00	1UZ-FE	3969	07/1997 →		0-N1883	TB [BT] S
4.0	10/96-08/00	1UZ-FE	3969	→ 07/1997; mit Grundträger		0-N2319	TB [TE]
4.0	05/93-08/00	1UZ-FE	3969	Rippenanzahl: 6		0-N2186	VB [DG]
4.0	05/93-08/00	1UZ-FE	3969			0-N2187	VB [BT]
4.0	05/93-08/00	1UZ-FE	3969			0-N2189S	VB [DG]
CELSIOR (UCF3_)							
4.3 VVTi	09/00-08/06	3UZ-FE	4293			0-N1823	TB [BT]
4.3 VVTi	09/00-08/06	3UZ-FE	4293			0-N1883	TB [BT] S
4.3 VVTi	09/00-08/06	3UZ-FE	4293			0-N2058	TB [DG]
4.3 VVTi	09/00-08/06	3UZ-FE	4293	Rippenanzahl: 6		0-N2186	VB [DG]
4.3 VVTi	09/00-08/06	3UZ-FE	4293			0-N2187	VB [BT]
4.3 VVTi	09/00-08/06	3UZ-FE	4293			0-N2189S	VB [DG]
CHASER (_X10_)							
2.5 VVTi	10/96-05/01	1JZ-GE, 1JZ-GTE	2491			0-N2183	VB [BT] S
3.0 VVTi	10/96-05/01	2JZ-FSE	2997			0-N1877	VB [BT] S
CHASER (_X9_)							
1.8	10/93-08/96	7A-FE	1762			0-N999	TB [TE]
COASTER Bus (TRB5_, XZB5_, RZB4_, HZB5_, BZB5_, BB4_)							
4.2 TD	02/93-10/03	1H-Z	4164	05/1998 →		0-N2320	TB [TE]
4.2 TD	08/04-	1H-Z	4164			0-N2320	TB [TE]
2.7	08/04-	2TR-FE	2694	08/2007 →; Baumuster: TRB40, TRB50; ✱		0-N1878	VB [DG]
CONQUEST (E90)							
1.6	01/96-12/99	3ZZ-FE	1598			0-N1462	VB [BT] S
COROLLA (_E7_)							
1.8 D	01/83-09/83	1C	1839	25.4x177		SK-1062	BTK
1.8 D	01/83-09/83	1C	1839			0-N995	TB [TE]
1.8 D	01/83-09/83	1C	1839			0-N996	TB [DG]
COROLLA Liftback (_E7_)							
1.8 D	01/83-09/83	1C	1839			0-N995	TB [TE]
1.8 D	01/83-09/83	1C	1839			0-N996	TB [DG]
COROLLA Station Wagon (_E7_)							
1.8 D	05/83-08/87	1C	1839	25.4x177; 08/1983 →		SK-1062	BTK
1.8 D	05/83-08/87	1C	1839			0-N995	TB [TE]
1.8 D	05/83-08/87	1C	1839			0-N996	TB [DG]
COROLLA (_E8_)							
1.3	06/83-10/84	2A-L	1296	19x88		SK-1650	BTK
1.3	08/83-08/87	2E, 2E-L, 2E-LC	1295	24x123; 04/1986 →		SK-1188	BTK
1.6	06/83-08/87	4A-L	1588	19x88		SK-1650	BTK
1.6	08/85-05/88	4A-LC	1587	19x88		SK-1650	BTK
1.8 D	06/83-05/88	1C	1840	25.4x177		SK-1062	BTK
1.8 D	06/83-06/89	1C-L	1839	25.4x177		SK-1062	BTK
1.3	06/83-10/84	2A-L	1296			0-N997	TB [TE]
1.3	10/84-08/87	2E-L, 2E-LC	1295	04/1986 →		0-N005	TB [TE]

CM³

Art. Nr.



ohne Halter

COROLLA (_E8_)

1.3	10/84-08/87	2E-L, 2E-LC	1295	04/1986 →	0-N006	TB [DG]
1.6	06/83-08/87	4A-L	1588		0-N997	TB [TE]
1.6	08/85-05/88	4A-LC	1587		0-N997	TB [TE]
1.8 D	06/83-05/88	1C	1840		0-N995	TB [TE]
1.8 D	06/83-06/89	1C-L	1839		0-N995	TB [TE]
1.8 D	06/83-05/88	1C	1840		0-N996	TB [DG]
1.8 D	06/83-06/89	1C-L	1839		0-N996	TB [DG]

COROLLA Coupe (AE86)

1.6 16V, 1.6 GT 16V	08/83-07/87	4A-GE, 4A-GEC	1587	19x113	SK-1197	BTK
1.6 SR 16V	05/83-04/87	4A-C	1587	19x88	SK-1650	BTK
1.6 16V, 1.6 GT 16V	08/83-07/87	4A-GE, 4A-GEC	1587		0-N998	TB [TE]

COROLLA FX Compact (E8B)

1.3	08/85-08/87	2E-L	1295	24x123; 04/1986 →	SK-1188	BTK
1.6	08/84-09/87	4A-C, 4A-LC	1587	19x88	SK-1650	BTK
1.6 GT 16V	08/85-08/87	4A-GEL	1587	19x113	SK-1197	BTK
1.8 D	01/85-05/88	1C, 1C-L	1839	25.4x177	SK-1062	BTK
1.3	08/85-08/87	2E-L	1295	05/1986 →	0-N005	TB [TE]
1.3	08/85-08/87	2E-L	1295	05/1986 →	0-N006	TB [DG]
1.6 GT 16V	08/85-08/87	4A-GEL	1587		0-N998	TB [TE]
1.8 D	01/85-05/88	1C, 1C-L	1839		0-N995	TB [TE]
1.8 D	01/85-05/88	1C, 1C-L	1839		0-N996	TB [DG]

COROLLA Liftback (_E8_)

1.3	06/83-09/84	2A-L	1296	19x88	SK-1650	BTK
1.3	01/85-08/87	2E-L, 2E-LC	1296	24x123; 04/1986 →	SK-1188	BTK
1.6	06/83-08/87	4A-L	1588	19x88	SK-1650	BTK
1.6	07/85-05/88	4A-L, 4A-LC	1587	19x88	SK-1650	BTK
1.8 D	06/83-05/88	1C, 1C-L	1839	25.4x177	SK-1062	BTK
1.3	06/83-09/84	2A-L	1296		0-N997	TB [TE]
1.3	01/85-08/87	2E-L, 2E-LC	1296	04/1986 →	0-N005	TB [TE]
1.3	01/85-08/87	2E-L, 2E-LC	1296	04/1986 →	0-N006	TB [DG]
1.6	06/83-08/87	4A-L	1588		0-N997	TB [TE]
1.6	07/85-05/88	4A-L, 4A-LC	1587		0-N997	TB [TE]
1.8 D	06/83-05/88	1C, 1C-L	1839		0-N995	TB [TE]
1.8 D	06/83-05/88	1C, 1C-L	1839		0-N996	TB [DG]

COROLLA (_E9_)

1.3	05/87-04/92	2E	1295	24x123	SK-1188	BTK
1.3 i	08/87-12/92	2E, 2E-E	1296	24x123	SK-1188	BTK
1.6, 1.6 GL 4x4, 1.6 i, 1.6 i 4WD	08/87-06/93	4A-F, 4A-FE	1587	19x94	SK-1275	BTK
1.8 D	07/87-06/93	1C	1840	25.4x177	SK-1062	BTK
1.3 i	08/87-12/92	2E, 2E-E	1296		0-N005	TB [TE]
1.3 i	08/87-12/92	2E, 2E-E	1296		0-N006	TB [DG]
1.6, 1.6 i	08/87-06/93	4A-F, 4A-FE	1587		0-N997	TB [TE]
1.8 D	07/87-06/93	1C	1840		0-N995	TB [TE]
1.8 D	07/87-06/93	1C	1840		0-N996	TB [DG]
1.6, 1.6 GL 4x4, 1.6 i 4WD	08/87-08/90	4A-F, 4A-FE	1587	→ 08/1989	0-N1725	VB [DG]
1.6 Allrad, 1.6 XL	08/87-04/92	4A-F	1587		0-N1725	VB [DG]
1.6 GL 4x4, 1.6 i 4WD	10/87-08/90	4A-F, 4A-FE	1587	09/1989 →	0-N1725	VB [DG]
1.6 i	11/89-06/93	4A-FE	1587	→ 06/1992	0-N1725	VB [DG]

COROLLA Compact (_E9_)

1.3	08/87-12/89	2E	1296	24x123	SK-1188	BTK
1.6, 1.6 GL 4x4, 1.6 i	08/87-04/92	4A-F, 4A-FE	1587	19x94	SK-1275	BTK
1.6 GTi	08/87-04/92	4A-GE	1587	19x113	SK-1197	BTK
1.8 D	08/87-04/92	1C	1840	25.4x177	SK-1062	BTK
1.3	08/87-12/89	2E	1296		0-N005	TB [TE]
1.3	08/87-12/89	2E	1296		0-N006	TB [DG]
1.6, 1.6 i	08/87-04/92	4A-F, 4A-FE	1587		0-N997	TB [TE]
1.6 GTi	08/87-04/92	4A-GE	1587		0-N998	TB [TE]
1.8 D	08/87-04/92	1C	1840		0-N995	TB [TE]
1.8 D	08/87-04/92	1C	1840		0-N996	TB [DG]
1.6, 1.6 GL 4x4, 1.6 i	08/87-04/92	4A-F, 4A-FE	1587	→ 08/1989	0-N1725	VB [DG]
1.6, 1.6 GL 4x4, 1.6 i	08/87-04/92	4A-F, 4A-FE	1587	09/1989 →	0-N1725	VB [DG]
1.6 XL	09/89-04/92	4A-F	1587		0-N1725	VB [DG]

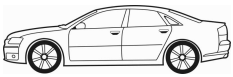

CM³



Art. Nr.



COROLLA Liftback (_E9_)

1.3	07/87-04/92	2E	1295	24x123	SK-1188	BTK
1.3 i	08/87-04/92	2E, 2E-E	1296	24x123	SK-1188	BTK
1.6	08/87-04/92	4A-F, 4A-FE	1587	19x94	SK-1275	BTK
1.6 GTI	07/87-06/93	4A-GE	1587	19x113	SK-1197	BTK
1.8 D	08/87-04/92	1C	1839	25.4x177	SK-1062	BTK
1.8 D	08/89-04/92	1C	1840	25.4x177	SK-1062	BTK
1.3 i	08/87-04/92	2E, 2E-E	1296		0-N005	TB [TE]
1.3 i	08/87-04/92	2E, 2E-E	1296		0-N006	TB [DG]
1.6	08/87-04/92	4A-F, 4A-FE	1587		0-N997	TB [TE]
1.6 GTI	07/87-06/93	4A-GE	1587		0-N998	TB [TE]
1.8 D	08/87-04/92	1C	1839		0-N995	TB [TE]
1.8 D	08/87-04/92	1C	1839		0-N996	TB [DG]
1.8 D	08/89-04/92	1C	1840		0-N995	TB [TE]
1.8 D	08/89-04/92	1C	1840		0-N996	TB [DG]
1.6	08/87-04/92	4A-F, 4A-FE	1587	→ 08/1989	0-N1725	VB [DG]
1.6	08/87-04/92	4A-F, 4A-FE	1587	09/1989 →	0-N1725	VB [DG]
1.6 4WD, 1.6 Allrad	08/87-05/92	4A-F, 4A-FE	1587		0-N1725	VB [DG]

COROLLA Station Wagon (_E9_)

1.3	05/87-04/92	2E	1295	24x123	SK-1188	BTK
1.3, 1.3 i	12/87-06/92	2E, 2E-E	1296	24x123	SK-1188	BTK
1.6, 1.6 Allrad, 1.6 XLI, 1.6 XLI 4x4	12/87-08/92	4A-F, 4A-FE	1587	19x94	SK-1275	BTK
1.8 D	12/87-06/92	1C	1839	25.4x177	SK-1062	BTK
1.8 D	08/89-06/92	1C	1840	25.4x177	SK-1062	BTK
1.3, 1.3 i	12/87-06/92	2E, 2E-E	1296		0-N005	TB [TE]
1.3, 1.3 i	12/87-06/92	2E, 2E-E	1296		0-N006	TB [DG]
1.6, 1.6 XLI, 1.6 XLI 4x4	12/87-06/92	4A-F, 4A-FE	1587		0-N997	TB [TE]
1.8 D	12/87-06/92	1C	1839		0-N995	TB [TE]
1.8 D	12/87-06/92	1C	1839		0-N996	TB [DG]
1.8 D	08/89-06/92	1C	1840		0-N995	TB [TE]
1.8 D	08/89-06/92	1C	1840		0-N996	TB [DG]
1.6, 1.6 Allrad, 1.6 XLI 4x4	12/87-08/92	4A-F, 4A-FE	1587	→ 08/1989	0-N1725	VB [DG]
1.6, 1.6 Allrad, 1.6 XLI 4x4	12/87-08/92	4A-F, 4A-FE	1587	09/1989 →	0-N1725	VB [DG]
1.6 XLI	11/89-06/92	4A-FE	1587		0-N1725	VB [DG]

COROLLA (_E10_)

1.3 12V	07/92-04/97	2E	1296	24x123	SK-1188	BTK
1.3 XLI, 1.3 XLI 16V	07/92-04/97	4E-FE	1332	26x124	SK-1196	BTK
1.6, 1.6 Si	05/92-04/97	4A-FE	1587	21x117	SK-1192	BTK
2.0 D	07/92-04/97	2C	1975	25.4x177	SK-1062	BTK
1.3 12V	07/92-04/97	2E	1296		0-N005	TB [TE]
1.3 12V	07/92-04/97	2E	1296		0-N006	TB [DG]
1.3 XLI, 1.3 XLI 16V	07/92-04/97	4E-FE	1332		0-N007	TB [TE]
1.3 XLI, 1.3 XLI 16V	07/92-04/97	4E-FE	1332		0-N008	TB [DG]
1.6, 1.6 Si	05/92-04/97	4A-FE	1587		0-N999	TB [TE]
1.8 i	11/92-09/94	7A-FE	1762		0-N999	TB [TE]
2.0 D	07/92-04/97	2C	1975		0-N995	TB [TE]
2.0 D	07/92-04/97	2C	1975		0-N996	TB [DG]
1.6, 1.6 Si	05/92-04/97	4A-FE	1587	Baumuster: AE101	0-N1725	VB [DG]
1.8 i	11/92-09/94	7A-FE	1762	Baumuster: AE10_	0-N1725	VB [DG]
2.0 D	07/92-04/97	2C	1975	06/1993 →	0-N1541	VB [DG]

COROLLA Compact (_E10_)

1.3 12V	07/92-05/95	2E	1296	24x123	SK-1188	BTK
1.3 XLI, 1.3 XLI 16V	07/92-04/97	4E-FE	1332	26x124	SK-1196	BTK
1.6 Si	07/92-04/97	4A-FE	1587	21x117	SK-1192	BTK
1.8 GT, 1.8 GTi 4x4	11/92-05/95	7A-FE	1762	21x121	SK-1075	BTK
2.0 D	07/92-04/97	2C	1975	25.4x177	SK-1062	BTK
1.3 12V	07/92-05/95	2E	1296		0-N005	TB [TE]
1.3 12V	07/92-05/95	2E	1296		0-N006	TB [DG]
1.3 XLI, 1.3 XLI 16V	07/92-04/97	4E-FE	1332		0-N007	TB [TE]
1.3 XLI, 1.3 XLI 16V	07/92-04/97	4E-FE	1332		0-N008	TB [DG]
1.6 Si	07/92-04/97	4A-FE	1587		0-N999	TB [TE]
1.8 GT, 1.8 GTi 4x4	11/92-05/95	7A-FE	1762		0-N999	TB [TE]
2.0 D	07/92-04/97	2C	1975		0-N995	TB [TE]
2.0 D	07/92-04/97	2C	1975		0-N996	TB [DG]
1.6 Si	07/92-04/97	4A-FE	1587	Baumuster: AE101	0-N1725	VB [DG]

CM³

Art. Nr.



ohne Halter

COROLLA Compact (_E10_)

1.8 GT	11/92-05/95	7A-FE	1762	Baumuster: AE10_	0-N1725	VB [DG]
2.0 D	07/92-04/97	2C	1975	06/1993 →	0-N1541	VB [DG]

COROLLA Liftback (_E10_)

1.3 12V	07/92-05/95	2E	1296	24x123	SK-1188	BTK
1.3 XLI	07/92-04/97	4E-FE	1332	26x124	SK-1196	BTK
1.6 GLI	07/92-04/97	4A-FE	1587	21x117	SK-1192	BTK
1.8 GT, 1.8 GTI 4x4	05/92-07/95	7A-FE	1762	21x121	SK-1075	BTK
2.0 D	07/92-04/97	2C	1975	25.4x177	SK-1062	BTK
1.3 12V	07/92-05/95	2E	1296		0-N005	TB [TE]
1.3 12V	07/92-05/95	2E	1296		0-N006	TB [DG]
1.3 XLI	07/92-04/97	4E-FE	1332		0-N007	TB [TE]
1.3 XLI	07/92-04/97	4E-FE	1332		0-N008	TB [DG]
1.6 GLI	07/92-04/97	4A-FE	1587		0-N999	TB [TE]
1.8 GT, 1.8 GTI 4x4	05/92-07/95	7A-FE	1762		0-N999	TB [TE]
2.0 D	07/92-04/97	2C	1975		0-N995	TB [TE]
2.0 D	07/92-04/97	2C	1975		0-N996	TB [DG]
1.6 GLI	07/92-04/97	4A-FE	1587	Baumuster: AE101	0-N1725	VB [DG]
1.8 GT	11/92-05/95	7A-FE	1762	Baumuster: AE10_	0-N1725	VB [DG]
2.0 D	07/92-04/97	2C	1975	06/1993 →	0-N1541	VB [DG]

COROLLA Wagon (_E10_)

1.3 12V	07/92-05/95	2E	1296	24x123	SK-1188	BTK
1.3 XLI, 1.3 XLI 16V	07/92-04/97	4E-FE	1332	26x124	SK-1196	BTK
1.6 Si	07/92-04/97	4A-FE	1587	21x117	SK-1192	BTK
1.8, 1.8 16V 4WD, 1.8 XL, 1.8 XL 4x4	09/92-04/97	7A-FE	1762	21x121	SK-1075	BTK
2.0 D	07/92-04/97	2C	1975	25.4x177	SK-1062	BTK
1.3 12V	07/92-05/95	2E	1296		0-N005	TB [TE]
1.3 12V	07/92-05/95	2E	1296		0-N006	TB [DG]
1.3 XLI, 1.3 XLI 16V	07/92-04/97	4E-FE	1332		0-N007	TB [TE]
1.3 XLI, 1.3 XLI 16V	07/92-04/97	4E-FE	1332		0-N008	TB [DG]
1.6, 1.6 Si	07/92-04/97	4A-FE	1587		0-N999	TB [TE]
1.8, 1.8 16V 4WD, 1.8 XL, 1.8 XL 4x4	09/92-04/97	7A-FE	1762		0-N999	TB [TE]
2.0 D	07/92-04/97	2C	1975		0-N995	TB [TE]
2.0 D	07/92-04/97	2C	1975		0-N996	TB [DG]
1.6, 1.6 Si	07/92-04/97	4A-FE	1587	Baumuster: AE101	0-N1725	VB [DG]
1.8, 1.8 16V 4WD, 1.8 XL, 1.8 XL 4x4	09/92-04/97	7A-FE	1762	Baumuster: AE10_	0-N1725	VB [DG]
2.0 D	07/92-04/97	2C	1975		0-N1541	VB [DG]

COROLLA (_E11_)

1.3	05/97-10/01	2E	1295	24x123	SK-1188	BTK
1.4	04/97-02/00	4E-FE	1332	26x124	SK-1196	BTK
1.6, 1.6 Aut.	04/97-02/00	4A-FE	1587	21x117	SK-1192	BTK
1.8 Linea Terra	10/97-10/01	7A-FE	1762	21x121	SK-1075	BTK
1.9 D	02/00-11/01	1WZ	1867	25.4x140	SK-1086	BTK
1.9 D	02/00-11/01	1WZ	1867	25.4x140	SK-1086AQ1	BTKW
2.0 D	04/97-02/00	2C-E	1975	25.4x177	SK-1062	BTK
2.0 D-4D	08/00-11/01	1CD-FTV	1995	25x178	SK-1589	BTK
2.0 D-4D	09/00-11/01	1CD-FTV	1995	25x178	SK-1589AQ1	BTKW
2.0 D-4D	09/00-11/01	1CD-FTV	1995	25x178; mit Spanndämpfer, Spannrolle	SK-1717	BTK
2.0 D-4D	09/00-11/01	1CD-FTV	1995	25x178; mit Spanndämpfer, Spannrolle	SK-1717AQ1	BTKW
1.4	04/97-02/00	4E-FE	1332		0-N007	TB [TE]
1.4	04/97-02/00	4E-FE	1332		0-N008	TB [DG]
1.6, 1.6 Aut.	04/97-02/00	4A-FE	1587		0-N999	TB [TE]
1.8, 1.8 Linea Terra	10/97-06/02	7A-FE	1762		0-N999	TB [TE]
1.9 D	02/00-11/01	1WZ	1867		0-N118P	TB [TE]
1.9 D	02/00-11/01	1WZ	1867		0-N1381	TB [DG]
2.0 D	04/97-02/00	2C-E	1975		0-N995	TB [TE]
2.0 D	04/97-02/00	2C-E	1975		0-N996	TB [DG]
2.0 D-4D	08/00-11/01	1CD-FTV	1995		0-N1328	TB [TE]
2.0 D-4D	08/00-11/01	1CD-FTV	1995		0-N1329	TB [DG]
2.0 D-4D	08/00-11/01	1CD-FTV	1995	hydraulisch	0-N1820	TB [BT]
1.4 16V	02/00-11/01	4ZZ-FE	1398		0-N1462	VB [BT] S
1.6, 1.6 Aut.	04/97-02/00	4A-FE	1587	→ 11/1999; Baumuster: AE111	0-N1725	VB [DG]
1.6 16V	02/00-11/01	3ZZ-FE	1598		0-N1462	VB [BT] S
2.0 D	04/97-02/00	2C-E	1975		0-N1541	VB [DG]



CM³



Art. Nr.



COROLLA Compact (_E11_)

1.4	04/97-02/00	4E-FE	1332	26x124	SK-1196	BTK	
1.6 , 1.6 Aut.	04/97-02/00	4A-FE	1587	21x117	SK-1192	BTK	
1.9 D	02/00-01/02	1WZ	1867	25.4x140	SK-1086	BTK	
1.9 D	02/00-01/02	1WZ	1867	25.4x140	SK-1086AQ1	BTKW	
2.0 D	04/97-02/00	2C-E	1975	25.4x177	SK-1062	BTK	
2.0 D-4D	08/00-01/02	1CD-FTV	1995	25x178	SK-1589	BTK	
2.0 D-4D	09/00-01/02	1CD-FTV	1995	25x178	SK-1589AQ1	BTKW	
2.0 D-4D	09/00-01/02	1CD-FTV	1995	25x178; mit Spanndämpfer, Spannrolle	SK-1717	BTK	
2.0 D-4D	09/00-01/02	1CD-FTV	1995	25x178; mit Spanndämpfer, Spannrolle	SK-1717AQ1	BTKW	
1.4	04/97-02/00	4E-FE	1332		0-N007	TB [TE]	
1.4	04/97-02/00	4E-FE	1332		0-N008	TB [DG]	
1.6 , 1.6 Aut.	04/97-02/00	4A-FE	1587		0-N999	TB [TE]	
1.9 D	02/00-01/02	1WZ	1867		0-N118P	TB [TE]	
1.9 D	02/00-01/02	1WZ	1867		0-N1381	TB [DG]	
2.0 D	04/97-02/00	2C-E	1975		0-N995	TB [TE]	
2.0 D	04/97-02/00	2C-E	1975		0-N996	TB [DG]	
2.0 D-4D	08/00-01/02	1CD-FTV	1995		0-N1328	TB [TE]	
2.0 D-4D	08/00-01/02	1CD-FTV	1995		0-N1329	TB [DG]	
2.0 D-4D	08/00-01/02	1CD-FTV	1995	hydraulisch	0-N1820	TB [BT]	
1.4	02/00-01/02	4ZZ-FE	1398		0-N1462	VB [BT]	S
1.6	02/00-01/02	3ZZ-FE	1598		0-N1462	VB [BT]	S
1.6 , 1.6 Aut.	04/97-02/00	4A-FE	1587	→ 11/1999; Baumuster: AE111	0-N1725	VB [DG]	
2.0 D	04/97-02/00	2C-E	1975		0-N1541	VB [DG]	

COROLLA Liftback (_E11_)

1.4	04/97-02/00	4E-FE	1332	26x124	SK-1196	BTK	
1.6 , 1.6 Aut.	04/97-02/00	4A-FE	1587	21x117	SK-1192	BTK	
1.8	09/98-11/01	7A-FE	1762	21x121	SK-1075	BTK	
1.8	09/98-11/01	7A-FE	1762	26x124	SK-1196	BTK	
1.9 D	02/00-01/02	1WZ	1867	25.4x140	SK-1086	BTK	
1.9 D	02/00-01/02	1WZ	1867	25.4x140	SK-1086AQ1	BTKW	
2.0 D	04/97-02/00	2C-E	1975	25.4x177	SK-1062	BTK	
2.0 D-4D	09/00-01/02	1CD-FTV	1995	25x178	SK-1589	BTK	
2.0 D-4D	09/00-01/02	1CD-FTV	1995	25x178	SK-1589AQ1	BTKW	
2.0 D-4D	09/00-01/02	1CD-FTV	1995	25x178; mit Spanndämpfer, Spannrolle	SK-1717	BTK	
2.0 D-4D	09/00-01/02	1CD-FTV	1995	25x178; mit Spanndämpfer, Spannrolle	SK-1717AQ1	BTKW	
1.4	04/97-02/00	4E-FE	1332		0-N007	TB [TE]	
1.4	04/97-02/00	4E-FE	1332		0-N008	TB [DG]	
1.6 , 1.6 Aut.	04/97-02/00	4A-FE	1587		0-N999	TB [TE]	
1.8	09/98-11/01	7A-FE	1762		0-N999	TB [TE]	
1.9 D	02/00-01/02	1WZ	1867		0-N118P	TB [TE]	
1.9 D	02/00-01/02	1WZ	1867		0-N1381	TB [DG]	
2.0 D	04/97-02/00	2C-E	1975		0-N995	TB [TE]	
2.0 D	04/97-02/00	2C-E	1975		0-N996	TB [DG]	
2.0 D-4D	09/00-01/02	1CD-FTV	1995		0-N1328	TB [TE]	
2.0 D-4D	09/00-01/02	1CD-FTV	1995		0-N1329	TB [DG]	
2.0 D-4D	09/00-01/02	1CD-FTV	1995	hydraulisch	0-N1820	TB [BT]	
1.4	02/00-01/02	4ZZ-FE	1398		0-N1462	VB [BT]	S
1.6	02/00-01/02	3ZZ-FE	1598		0-N1462	VB [BT]	S
1.6 , 1.6 Aut.	04/97-02/00	4A-FE	1587	→ 11/1999; Baumuster: AE111	0-N1725	VB [DG]	
2.0 D	04/97-02/00	2C-E	1975		0-N1541	VB [DG]	

COROLLA Wagon (_E11_)

1.4	04/97-02/00	4E-FE	1332	26x124	SK-1196	BTK	
1.6 , 1.6 Aut.	04/97-02/00	4A-FE	1587	21x117	SK-1192	BTK	
1.8	10/97-10/01	7A-FE	1762	21x121	SK-1075	BTK	
1.8 AWD	04/97-10/01	7A-FE	1762	21x121; 10/1997 →	SK-1075	BTK	
1.9 D	02/00-10/01	1WZ	1867	25.4x140	SK-1086	BTK	
1.9 D	02/00-10/01	1WZ	1867	25.4x140	SK-1086AQ1	BTKW	
2.0 D	04/97-02/00	2C-E	1975	25.4x177	SK-1062	BTK	
2.0 D-4D	09/00-10/01	1CD-FTV	1995	25x178	SK-1589	BTK	
2.0 D-4D	09/00-10/01	1CD-FTV	1995	25x178	SK-1589AQ1	BTKW	
2.0 D-4D	09/00-10/01	1CD-FTV	1995	25x178; mit Spanndämpfer, Spannrolle	SK-1717	BTK	
1.4	04/97-02/00	4E-FE	1332		0-N007	TB [TE]	
1.4	04/97-02/00	4E-FE	1332		0-N008	TB [DG]	
1.6 , 1.6 Aut.	04/97-02/00	4A-FE	1587		0-N999	TB [TE]	

CM³

Art. Nr.



ohne Halter

COROLLA Wagon (_E11_)

1.8, 1.8 AWD	04/97-10/01	7A-FE	1762		0-N999	TB [TE]	
1.9 D	02/00-10/01	1WZ	1867		0-N118P	TB [TE]	
1.9 D	02/00-10/01	1WZ	1867		0-N1381	TB [DG]	
2.0 D	04/97-02/00	2C-E	1975		0-N995	TB [TE]	
2.0 D	04/97-02/00	2C-E	1975		0-N996	TB [DG]	
2.0 D4d, 2.0 D-4D, 2.0 D4d GS	04/97-10/01	1CD-FTV	1995		0-N1328	TB [TE]	
2.0 D4d, 2.0 D-4D, 2.0 D4d GS	04/97-10/01	1CD-FTV	1995		0-N1329	TB [DG]	
2.0 D4d, 2.0 D-4D, 2.0 D4d GS	04/97-10/01	1CD-FTV	1995	hydraulisch	0-N1820	TB [BT]	
1.4 16V	02/00-10/01	4ZZ-FE	1398		0-N1462	VB [BT]	S
1.6, 1.6 Aut.	04/97-02/00	4A-FE	1587	→ 11/1999; Baumuster: AE111	0-N1725	VB [DG]	
1.6 16V	02/00-10/01	3ZZ-FE	1598		0-N1462	VB [BT]	S
2.0 D	04/97-02/00	2C-E	1975		0-N1541	VB [DG]	
2.0 D4d	04/97-10/01	1CD-FTV	1995		0-N2098	VB [BT]	S
2.0 D-4D	09/00-10/01	1CD-FTV	1995		0-N1541	VB [DG]	

COROLLA (CDE12_, ZZE12_, NDE12_, ZDE12_)

2.0 D-4D	01/02-02/07	1CD-FTV	1995	25x178	SK-1589	BTK	
2.0 D-4D	01/02-02/07	1CD-FTV	1995	25x178	SK-1589AQ1	BTKW	
2.0 D-4D	01/02-02/07	1CD-FTV	1995	25x178; für Fahrzeuge ohne Rußpartikelfilter; Fahrzeugproduktionsland Europa	SK-1589AQ1	BTKW	
2.0 D-4D	01/02-02/07	1CD-FTV	1995	25x178; für Fahrzeuge mit Rußpartikelfilter; ohne Spanndämpfer, Spannrolle; Fahrzeugproduktionsland Europa	SK-1589AQ2	BTKW	
2.0 D-4D	01/02-02/07	1CD-FTV	1995	25x178; mit Spanndämpfer, Spannrolle	SK-1717	BTK	
2.0 D-4D	01/02-02/07	1CD-FTV	1995	25x178; für Fahrzeuge ohne Rußpartikelfilter; mit Spanndämpfer, Spannrolle; Fahrzeugproduktionsland Europa	SK-1717AQ1	BTKW	
2.0 D-4D	01/02-02/07	1CD-FTV	1995	25x178; mit Spanndämpfer, Spannrolle; Fahrzeugproduktionsland Japan	SK-1717AQ1	BTKW	
2.0 D-4D	01/02-02/07	1CD-FTV	1995	25x178; für Fahrzeuge mit Rußpartikelfilter; mit Spanndämpfer, Spannrolle; Fahrzeugproduktionsland Europa	SK-1717AQ2	BTKW	
2.0 D-4D	01/02-02/07	1CD-FTV	1995		0-N1328	TB [TE]	
2.0 D-4D	01/02-02/07	1CD-FTV	1995		0-N1329	TB [DG]	
2.0 D-4D	01/02-02/07	1CD-FTV	1995	hydraulisch	0-N1820	TB [BT]	
1.4 D	07/04-02/07	1ND-TV	1364		0-N2107	VB [BT]	S
1.4 VVT-i	01/02-12/06	4ZZ-FE	1398		0-N1462	VB [BT]	S
1.6 VVT-i	01/02-12/06	3ZZ-FE	1598		0-N1462	VB [BT]	S
1.8 Allrad, 1.8 VVTi	12/01-02/07	1ZZ-FE	1794		0-N1462	VB [BT]	S
1.8 VVTi TS	01/02-02/07	2ZZ-GE	1796		0-N1462	VB [BT]	S
2.0 D-4D	01/02-02/07	1CD-FTV	1995		0-N2098	VB [BT]	S

COROLLA [USA] Liftback

1.8 Flex	01/84-12/87	F18D4	1587		0-N1347	TB [TE]	
1.8 Flex	01/84-12/87	F18D4	1587	Rippenanzahl: 6;	0-N1646	VB [DG]	

COROLLA Combi (_E12J_, _E12T_)

2.0 D-4D	01/02-02/07	1CD-FTV	1995	25x178	SK-1589	BTK	
2.0 D-4D	01/02-02/07	1CD-FTV	1995	25x178	SK-1589AQ1	BTKW	
2.0 D-4D	01/02-02/07	1CD-FTV	1995	25x178; für Fahrzeuge ohne Rußpartikelfilter; Fahrzeugproduktionsland Europa	SK-1589AQ1	BTKW	
2.0 D-4D	01/02-02/07	1CD-FTV	1995	25x178; für Fahrzeuge mit Rußpartikelfilter; ohne Spanndämpfer, Spannrolle; Fahrzeugproduktionsland Europa	SK-1589AQ2	BTKW	
2.0 D-4D	01/02-02/07	1CD-FTV	1995	25x178; mit Spanndämpfer, Spannrolle	SK-1717	BTK	
2.0 D-4D	01/02-02/07	1CD-FTV	1995	25x178; für Fahrzeuge ohne Rußpartikelfilter; mit Spanndämpfer, Spannrolle; Fahrzeugproduktionsland Europa	SK-1717AQ1	BTKW	
2.0 D-4D	01/02-02/07	1CD-FTV	1995	25x178; mit Spanndämpfer, Spannrolle; Fahrzeugproduktionsland Japan	SK-1717AQ1	BTKW	
2.0 D-4D	01/02-02/07	1CD-FTV	1995	25x178; für Fahrzeuge mit Rußpartikelfilter; mit Spanndämpfer, Spannrolle; Fahrzeugproduktionsland Europa	SK-1717AQ2	BTKW	
2.0 D-4D	01/02-02/07	1CD-FTV	1995		0-N1328	TB [TE]	
2.0 D-4D	01/02-02/07	1CD-FTV	1995		0-N1329	TB [DG]	
2.0 D-4D	01/02-02/07	1CD-FTV	1995	hydraulisch	0-N1820	TB [BT]	
1.4 D	07/04-02/07	1ND-TV	1364		0-N2107	VB [BT]	S
1.4 VVT-i	01/02-02/07	4ZZ-FE	1398		0-N1462	VB [BT]	S



CM³



Art. Nr.



COROLLA Combi (_E12J_, _E12T_)

1.6 VVT-i	01/02-02/07	3ZZ-FE	1598		0-N1462	VB [BT]	S
1.8, 1.8 Allrad	12/01-02/07	1ZZ-FE	1794		0-N1462	VB [BT]	S
2.0 D-4D	01/02-02/07	1CD-FTV	1995		0-N2098	VB [BT]	S

COROLLA Stufenheck (_E12J_, _E12T_)

2.0 D4d, 2.0 D-4D	08/02-07/07	1CD-FTV	1995	25x178	SK-1589	BTK	
2.0 D4d, 2.0 D-4D	08/02-07/07	1CD-FTV	1995	25x178	SK-1589AQ1	BTKW	
2.0 D4d, 2.0 D-4D	08/02-07/07	1CD-FTV	1995	25x178; für Fahrzeuge ohne Rußpartikelfilter; Fahrzeugproduktionsland Europa	SK-1589AQ1	BTKW	
2.0 D4d, 2.0 D-4D	08/02-07/07	1CD-FTV	1995	25x178; für Fahrzeuge mit Rußpartikelfilter; ohne Spanndämpfer, Spannrolle; Fahrzeugproduktionsland Europa	SK-1589AQ2	BTKW	
2.0 D4d, 2.0 D-4D	08/02-07/07	1CD-FTV	1995	25x178; mit Spanndämpfer, Spannrolle	SK-1717	BTK	
2.0 D4d, 2.0 D-4D	08/02-07/07	1CD-FTV	1995	25x178; für Fahrzeuge ohne Rußpartikelfilter; mit Spanndämpfer, Spannrolle; Fahrzeugproduktionsland Europa	SK-1717AQ1	BTKW	
2.0 D4d, 2.0 D-4D	08/02-07/07	1CD-FTV	1995	25x178; mit Spanndämpfer, Spannrolle; Fahrzeugproduktionsland Japan	SK-1717AQ1	BTKW	
2.0 D4d, 2.0 D-4D	08/02-07/07	1CD-FTV	1995	25x178; für Fahrzeuge mit Rußpartikelfilter; mit Spanndämpfer, Spannrolle; Fahrzeugproduktionsland Europa	SK-1717AQ2	BTKW	
2.0 D4d, 2.0 D-4D	08/02-07/07	1CD-FTV	1995		0-N1328	TB [TE]	
2.0 D4d, 2.0 D-4D	08/02-07/07	1CD-FTV	1995		0-N1329	TB [DG]	
2.0 D4d, 2.0 D-4D	08/02-07/07	1CD-FTV	1995	hydraulisch	0-N1820	TB [BT]	
1.4 D	07/04-07/07	1ND-TV	1364		0-N2107	VB [BT]	S
1.4 VVT-i	08/02-07/07	4ZZ-FE	1398		0-N1462	VB [BT]	S
1.6 VVT-i	08/02-07/07	3ZZ-FE	1598		0-N1462	VB [BT]	S
1.8	03/01-07/07	1ZZ-FE	1794		0-N1462	VB [BT]	S
2.0 D4d, 2.0 D-4D	08/02-07/07	1CD-FTV	1995		0-N2098	VB [BT]	S

COROLLA Verso (ZDE12_, CDE12_)

2.0 D-4D	01/02-05/04	1CD-FTV	1995	25x178	SK-1589	BTK	
2.0 D-4D	01/02-05/04	1CD-FTV	1995	25x178	SK-1589AQ1	BTKW	
2.0 D-4D	01/02-05/04	1CD-FTV	1995	25x178; mit Spanndämpfer, Spannrolle	SK-1717	BTK	
2.0 D-4D	01/02-05/04	1CD-FTV	1995	25x178; mit Spanndämpfer, Spannrolle	SK-1717AQ1	BTKW	
2.0 D4d, 2.0 D-4D	09/01-05/04	1CD-FTV	1995		0-N1328	TB [TE]	
2.0 D4d, 2.0 D-4D	09/01-05/04	1CD-FTV	1995		0-N1329	TB [DG]	
2.0 D4d, 2.0 D-4D	09/01-05/04	1CD-FTV	1995	hydraulisch	0-N1820	TB [BT]	
1.4 D4d	09/01-05/04	1ND-TV	1364		0-N2107	VB [BT]	S
1.4 VVT-i	01/02-05/04	4ZZ-FE	1398		0-N1462	VB [BT]	S
1.6 VVT-i	01/02-05/04	3ZZ-FE	1598		0-N1462	VB [BT]	S
1.8 VVT-i, 1.8 VVTi Allrad	10/01-05/04	1ZZ-FE	1794		0-N1462	VB [BT]	S
2.0 D4d, 2.0 D-4D	09/01-05/04	1CD-FTV	1995		0-N2098	VB [BT]	S

COROLLA Verso (ZER_, ZZE12_, R1_)

2.0 D-4D	04/04-03/09	1CD-FTV	1995	25x178	SK-1589	BTK	
2.0 D-4D	04/04-03/09	1CD-FTV	1995	25x178; ohne Spanndämpfer, Spannrolle	SK-1589AQ2	BTKW	
2.0 D-4D	04/04-03/09	1CD-FTV	1995	25x178; mit Spanndämpfer, Spannrolle	SK-1717	BTK	
2.0 D-4D	04/04-03/09	1CD-FTV	1995	25x178; mit Spanndämpfer, Spannrolle	SK-1717AQ2	BTKW	
2.0 D-4D	04/04-03/09	1CD-FTV	1995		0-N1328	TB [TE]	
2.0 D-4D	04/04-03/09	1CD-FTV	1995		0-N1329	TB [DG]	
2.0 D-4D	04/04-03/09	1CD-FTV	1995	hydraulisch	0-N1820	TB [BT]	
1.4 D-4D	03/04-03/09	1ND-TV	1364		0-N2107	VB [BT]	S
1.6	04/04-03/09	3ZZ-FE	1598		0-N1462	VB [BT]	S
1.8	04/04-03/09	1ZZ-FE	1794		0-N1462	VB [BT]	S
2.0 D-4D	04/04-03/09	1CD-FTV	1995		0-N2098	VB [BT]	S
2.2 D-4D	10/05-03/09	2AD-FHV, 2AD-FTV	2231		0-N1482S	VB [TE]	
2.2 D-4D	10/05-03/09	2AD-FHV, 2AD-FTV	2231	→ 02/2009; Baumuster: AUR10	0-N2040	VB [DG]	
2.2 D-4D	10/05-03/09	2AD-FHV, 2AD-FTV	2231		0-N2051	VB [DG]	

COROLLA Stufenheck (E15_)

1.33	01/07-	1NR-FE	1329		0-N2198	VB [BT]	S
1.4 D-4D	01/07-	1ND-TV	1364		0-N2107	VB [BT]	S
1.4 VVT-i	01/07-	4ZZ-FE	1398		0-N1462	VB [BT]	S
1.6 CNG, 1.6 VVTi, 1.6 VVT-i	08/07-	3ZZ-FE	1598		0-N1462	VB [BT]	S
2.0 D-4D	01/07-	1AD-FTV	1998		0-N2040	VB [DG]	
2.0 D-4D	01/07-	1AD-FTV	1998		0-N2051	VB [DG]	
2.2 D-4D	11/06-	2AD-FHV	2231		0-N2040	VB [DG]	



CM³



Art. Nr.



COROLLA Stufenheck (E15_)										
2.2 D-4D	11/06-	2AD-FHV	2231					0-N2051	VB [DG]	
COROLLA Stufenheck (NRE18_, ZRE17_, ZRE18_, NDE18_)										
1.33	06/13-	1NR-FE	1329					0-N2393	VB [BT]	S
COROLLA Stufenheck (_NZE16_)										
1.3	05/12-	1NR-FE	1329					0-N2393	VB [BT]	S
CORONA Liftback										
1.6	02/92-09/97	4A-FE	1587					0-N999	TB [TE]	
1.8	02/92-09/97	7A-FE	1762					0-N999	TB [TE]	
CORONA Station Wagon										
1.6	02/92-09/97	4A-FE	1587					0-N999	TB [TE]	
1.8	02/92-09/97	7A-FE	1762					0-N999	TB [TE]	
CORONA Stufenheck										
1.6	02/92-09/97	4A-FE	1587	21x117				SK-1192	BTK	
2.0	02/92-09/97	3S-FE	1998	27x163				SK-1186	BTK	
1.6	02/92-09/97	4A-FE	1587					0-N999	TB [TE]	
1.8	02/92-09/97	7A-FE	1762					0-N999	TB [TE]	
CORSA Stufenheck										
1.3	10/90-10/94	4E-FE	1332					0-N007	TB [TE]	
1.3	10/90-10/94	4E-FE	1332					0-N008	TB [DG]	
CORSA Liftback										
1.3	11/94-09/99	4E-FE	1332					0-N007	TB [TE]	
1.3	11/94-09/99	4E-FE	1332					0-N008	TB [DG]	
CORSA Stufenheck										
1.3	11/94-09/99	4E-FE	1332					0-N007	TB [TE]	
1.3	11/94-09/99	4E-FE	1332					0-N008	TB [DG]	
CRESSIDA Station Wagon (X6K, MX62)										
2.2 D	06/81-03/85	L	2173	25.4x130; 05/1982 →				SK-1189	BTK	
2.2 D	06/81-03/85	L	2173					0-N988	TB [TE]	
2.2 D	06/81-03/85	L	2173					0-N989	TB [DG]	
CRESSIDA Stufenheck (_X6_)										
2.2 D	09/80-07/84	L	2173	25.4x130; 05/1982 →				SK-1189	BTK	
2.0 GLI	11/82-12/84	1G-E	1988					0-N991	TB [DG]	
2.2 D	09/80-07/84	L	2173					0-N988	TB [TE]	
2.2 D	09/80-07/84	L	2173					0-N989	TB [DG]	
CRESSIDA Stufenheck (GX7_, MX73)										
2.4 TD	01/85-10/88	2L-T	2446	25.4x130; 05/1985 →				SK-1189	BTK	
2.4 TD	05/85-09/88	2L-T	2446	25.4x130				SK-1189	BTK	
CRESSIDA Stufenheck (LX8_, GX8_, MX8_, RX8_)										
2.5 Turbo	10/91-09/92	1JZ-GTE	2491					0-N2183	VB [BT]	S
CRESTA Station Wagon										
2.5 VVTi	10/96-09/01	1JZ-GE	2491					0-N2183	VB [BT]	S
3.0 VVTi	10/96-09/01	2JZ-GE	2997					0-N1877	VB [BT]	S
CRESTA Stufenheck										
2.5 VVTi	10/96-09/01	1JZ-GE	2491					0-N2183	VB [BT]	S
3.0 VVTi	10/96-09/01	2JZ-GE	2997					0-N1877	VB [BT]	S
CROWN Station Wagon (_S1_)										
2.8	09/80-09/83	5M, 5M-E	2759					0-N993	TB [TE]	
CROWN Stufenheck (_S1_)										
2.2 D	04/80-07/83	L	2188	25.4x130; 05/1982 →				SK-1189	BTK	
2.8 SI	04/80-07/83	5M, 5M-E	2759					0-N993	TB [TE]	
CROWN Stufenheck (JZS13_, YS13_, LS13_, GS13_)										
4.0, 4.0 4x4	08/91-08/99	1UZ-FE	3969					0-N1823	TB [BT]	
4.0, 4.0 4x4	08/91-08/99	1UZ-FE	3969	07/1997 →				0-N1883	TB [BT]	S
4.0, 4.0 4x4	08/91-08/99	1UZ-FE	3969					0-N2058	TB [DG]	
4.0, 4.0 4x4	08/91-08/99	1UZ-FE	3969	→ 07/1997; mit Grundträger				0-N2319	TB [TE]	
3.0, 3.0 4x4	08/91-08/99	2JZ-GE	2997					0-N1877	VB [BT]	S
4.0, 4.0 4x4	08/91-08/99	1UZ-FE	3969	Rippenanzahl: 6				0-N2186	VB [DG]	
4.0, 4.0 4x4	08/91-08/99	1UZ-FE	3969					0-N2187	VB [BT]	
4.0, 4.0 4x4	08/91-08/99	1UZ-FE	3969					0-N2189S	VB [DG]	



CM³



Art. Nr.



CROWN Station Wagon								
2.5, 2.5 Allrad	09/99-08/03	1JZ-GE	2491			0-N2183	VB [BT]	S
3.0	09/99-08/03	2JZ-FSE	2997			0-N1877	VB [BT]	S
CROWN Stufenheck (JZS17_)								
2.5	09/99-08/03	1JZ-GTE	2491			0-N2183	VB [BT]	S
3.0	09/99-08/03	2JZ-FSE	2997			0-N1877	VB [BT]	S
CROWN Stufenheck (CRS_, JZS_, GRS18_, UZS_)								
4.3 Royal Saloon, 4.3 Royal Saloon 4x4	09/03-02/08	3UZ-FE	4293			0-N1823	TB [BT]	
4.3 Royal Saloon, 4.3 Royal Saloon 4x4	09/03-02/08	3UZ-FE	4293			0-N1883	TB [BT]	S
4.3 Royal Saloon, 4.3 Royal Saloon 4x4	09/03-02/08	3UZ-FE	4293			0-N2058	TB [DG]	
2.5 Athlete	09/03-02/08	4GR-FSE	2499	✳		0-N1728	VB [DG]	
3.0, 3.0 Allrad	09/03-02/08	3GR-FE, 3GR-FSE	2994	✳		0-N1728	VB [DG]	
4.3 Royal Saloon, 4.3 Royal Saloon 4x4	09/03-02/08	3UZ-FE	4293	Rippenanzahl: 6		0-N2186	VB [DG]	
4.3 Royal Saloon, 4.3 Royal Saloon 4x4	09/03-02/08	3UZ-FE	4293			0-N2187	VB [BT]	
4.3 Royal Saloon, 4.3 Royal Saloon 4x4	09/03-02/08	3UZ-FE	4293			0-N2189S	VB [DG]	
CROWN Stufenheck (GRS20_)								
2.5 V6, 2.5 V6 4WD	02/08-11/12	4GR-FSE	2499			0-N1728	VB [DG]	
3.0	02/08-11/12	3GR-FE	2995			0-N1728	VB [DG]	
3.0, 3.0 4WD	02/08-11/12	3GR-FSE	2994			0-N1728	VB [DG]	
3.5 V6	02/08-11/12	2GR-FSE	3456			0-N1728	VB [DG]	
4.3 V8 4WD	04/09-11/12	3UZ-FE	4292			0-N2187	VB [BT]	
4.3 V8 4WD	04/09-11/12	3UZ-FE	4292			0-N2189S	VB [DG]	
CURREN Coupe (ST20_)								
1.8	11/93-10/98	7A-FE	1762			0-N999	TB [TE]	
DUET (M11_, M10_)								
1.3	09/98-04/04	K3-VE2	1298			0-N2229	VB [TE]	
DYNA 150 Pritsche/Fahrgestell								
2.4 D	08/85-08/87	2L	2446	25.4x130		SK-1189	BTK	
DYNA 150 Pritsche/Fahrgestell (LY_)								
2.8 D	05/95-08/98	3L	2779	31x129		SK-1522	BTK	
3.0 D	09/98-07/01	5L	2986	31x129		SK-1522	BTK	
DYNA Bus (_U3_, _U2_)								
2.4 D	08/77-02/79	2J	2449			0-N988	TB [TE]	
2.4 D	08/77-02/79	2J	2449			0-N989	TB [DG]	
DYNA Pritsche/Fahrgestell								
2.4 D	09/84-08/87	2J	2449			0-N988	TB [TE]	
2.4 D	09/84-08/87	2J	2449			0-N989	TB [DG]	
DYNA Pritsche/Fahrgestell (KD_, LY_, TRY2_, KDY2_, XZU4_, XZ)								
2.5 D4d	08/01-	2KD-FTV	2494	25x97		SK-1713	BTK	
2.5 D4d	08/01-	2KD-FTV	2494	25x97		SK-1722	BTK	
2.5 D4d	08/01-	2KD-FTV	2494	25x97; → 08/2006		SK-1722	BTK	
3.0 D4d	09/06-	1KD-FTV	2982	25x97		SK-1713	BTK	
3.0 D4d	09/06-	1KD-FTV	2982	25x97; ohne Spanndämpfer, Spannrolle		SK-1713	BTK	
3.0 D4d	09/06-	1KD-FTV	2982	25x97		SK-1722	BTK	
2.5 D4d	08/01-	2KD-FTV	2494			0-N176	TB [TE]	
2.5 D4d	08/01-	2KD-FTV	2494			0-N1819	TB [BT]	
3.0 D4d, 3.0 D4d 4WD	09/06-	1KD-FTV	2982			0-N176	TB [TE]	
3.0 D4d, 3.0 D4d 4WD	09/06-	1KD-FTV	2982			0-N1819	TB [BT]	
2.5 D4d	08/01-	2KD-FTV	2494			0-N1880	VB [BT]	S
3.0 D4d, 3.0 D4d 4WD	09/06-	1KD-FTV	2982			0-N1880	VB [BT]	S
ECHO Liftback (NCP13_, NCP12_)								
1.4 D4d	01/00-03/03	1ND-TV	1364			0-N2107	VB [BT]	S
EXSIOR								
2.5	06/92-09/97	1JZ-GE	2491			0-N2183	VB [BT]	S
FJ CRUISER (GSJ1_)								
4.0 i V6, 4.0 VVTi, 4.0 VVTi 4WD	01/06-12/11	1GR-FE	3956	✳		0-N1728	VB [DG]	
4.0 i V6, 4.0 VVTi, 4.0 VVTi 4WD	01/06-12/11	1GR-FE	3956	✳		0-N1878	VB [DG]	
FORTUNER (TGN6_, KUN6_, GGN6_, TGN5_, LAN5_, KUN5_, GGN5_)								
2.5 D-4D 4WD, 2.5 D-4D 4x4	01/09-05/15	2KD-FTV	2494			0-N176	TB [TE]	
2.5 D-4D 4WD, 2.5 D-4D 4x4	01/09-05/15	2KD-FTV	2494			0-N1819	TB [BT]	
3.0 D, 3.0 D 4x4	06/04-05/15	1KD-FTV	2982			0-N176	TB [TE]	



OPTIMAL®

TOYOTA



CM³



Art. Nr.



ohne Halter

FORTUNER (TGN6_, KUN6_, GGN6_, TGN5_, LAN5_, KUN5_, GGN5_)

3.0 D, 3.0 D 4x4	06/04-05/15	1KD-FTV	2982		0-N1819	TB [BT]	
2.5 D-4D 4WD, 2.5 D-4D 4x4	01/09-05/15	2KD-FTV	2494		0-N1880	VB [BT]	S
2.7 VVTi, 2.7 VVTi 4x4	06/04-05/15	2TR-FE	2694	01/2005 →; Baumuster: TGN51, TGN61; *	0-N1878	VB [DG]	
3.0 D, 3.0 D 4x4	06/04-05/15	1KD-FTV	2982		0-N1880	VB [BT]	S
4.0 VVTi 4x4	01/10-05/15	1GR-FE	3956		0-N2188	VB [BT]	S
4.0 VVTi, 4.0 VVTi 4x4	01/10-05/15	1GR-FE	3956	*	0-N1728	VB [DG]	
4.0 VVTi, 4.0 VVTi 4x4	01/10-05/15	1GR-FE	3956	*	0-N1878	VB [DG]	

GAIA (CXM1_, SXM1_, ACM1_)

2.0 VVTi, 2.0 VVTi 4x4	05/98-10/03	1AZ-FSE	1998		0-N2185	VB [VD]	
------------------------	-------------	---------	------	--	---------	---------	--

GRANVIA (_H2_, _H1_)

3.0 TDi	08/95-	1KZ-TE	2982		0-N1618	TB [TE]	
3.0 TDi	08/95-	1KZ-TE	2982		0-N1819	TB [BT]	
3.4	08/95-	5VZ-FE	3378		0-N1773	TB [DG]	
3.4	08/95-	5VZ-FE	3378		0-N1879	TB [TE]	

HARRIER (MCU3_, MHU3_, ACU3_, GSU3_)

3.5 VVTi 4x4	04/05-12/08	2GR-FE	3456	*	0-N1728	VB [DG]	
3.5 VVTi 4x4	04/05-12/08	2GR-FE	3456		0-N2032	VB [BT]	S

HIACE I Kasten (RH1_, LH3_, RH3_, RH2_, LH2_, LH1_)

2.2 D	01/79-03/83	L	2173		0-N988	TB [TE]	
2.2 D	01/79-03/83	L	2173		0-N989	TB [DG]	

HIACE II Kasten (LH5_, YH7_, LH7_, LH6_, YH6_, YH5_)

2.2 D	03/83-11/89	L	2173	25.4x130	SK-1189	BTK	
2.4 D	05/84-11/89	2L	2446	25.4x130	SK-1189	BTK	
2.2 D	03/83-11/89	L	2173		0-N988	TB [TE]	
2.2 D	03/83-11/89	L	2173		0-N989	TB [DG]	
2.4 D	05/84-11/89	2L	2446		0-N988	TB [TE]	
2.4 D	05/84-11/89	2L	2446		0-N989	TB [DG]	

HIACE II Wagon (LH7_, LH5_, LH6_, YH7_, YH6_, YH5_)

2.2 D	03/83-11/89	L	2173	25.4x130	SK-1189	BTK	
2.4 D, 2.4 D 4WD	08/84-08/89	2L	2446	25.4x130	SK-1189	BTK	
2.2 D	03/83-11/89	L	2173		0-N988	TB [TE]	
2.2 D	03/83-11/89	L	2173		0-N989	TB [DG]	
2.4 D, 2.4 D 4WD	08/84-08/89	2L	2446		0-N988	TB [TE]	
2.4 D, 2.4 D 4WD	08/84-08/89	2L	2446		0-N989	TB [DG]	

HIACE III Kasten (YH7_, LH6_, LH7_, LH5_, YH5_, YH6_)

2.4 D, 2.4 D 4WD, 2.4 D 4x4, 2.4 Diesel	08/89-08/95	2L	2446	31x129	SK-1522	BTK	
2.5 D-4D 4x4	08/01-08/04	2KD-FTV	2494	25x97	SK-1713	BTK	
2.5 D-4D 4x4	08/01-08/04	2KD-FTV	2494	25x97	SK-1722	BTK	
2.8 D	08/89-08/00	3L	2779	31x129	SK-1522	BTK	
3.0 D	08/98-08/04	5L	2986	31x129; → 08/2004	SK-1522	BTK	
2.4 D 4WD, 2.4 Diesel	08/89-08/95	2L	2446		0-N013	TB [TE]	
2.4 D 4WD, 2.4 Diesel	08/89-08/95	2L	2446		0-N014	TB [DG]	
2.5 D-4D 4x4	08/01-08/04	2KD-FTV	2494		0-N176	TB [TE]	
2.5 D-4D 4x4	08/01-08/04	2KD-FTV	2494		0-N1819	TB [BT]	
2.5 D-4D 4x4	08/01-08/04	2KD-FTV	2494		0-N1880	VB [BT]	S

HIACE III Wagon (LH1_, RZH1_)

2.4 D	08/89-08/95	2L	2446	31x129	SK-1522	BTK	
2.4 D, 2.4 D 4WD	08/89-08/95	2L	2446	31x129; 01/1992 →	SK-1522	BTK	
2.5 D-4D 4x4	08/01-08/04	2KD-FTV	2494	25x97	SK-1713	BTK	
2.5 D-4D 4x4	08/01-08/04	2KD-FTV	2494	25x97	SK-1722	BTK	
2.8 D	08/89-08/00	3L	2779	31x129	SK-1522	BTK	
3.0 D	08/98-08/04	5L	2986	31x129; → 08/2004	SK-1522	BTK	
2.4 D, 2.4 D 4WD	08/89-08/95	2L	2446		0-N013	TB [TE]	
2.4 D, 2.4 D 4WD	08/89-08/95	2L	2446		0-N014	TB [DG]	
2.5 D-4D 4x4	08/01-08/04	2KD-FTV	2494		0-N176	TB [TE]	
2.5 D-4D 4x4	08/01-08/04	2KD-FTV	2494		0-N1819	TB [BT]	
3.4, 3.4 4x4	08/95-08/01	5VZ-FE	3378		0-N1773	TB [DG]	
3.4, 3.4 4x4	08/95-08/01	5VZ-FE	3378		0-N1879	TB [TE]	
2.5 D-4D 4x4	08/01-08/04	2KD-FTV	2494		0-N1880	VB [BT]	S

HIACE IV Bus (LH1_)

2.4 D, 2.4 TD	08/95-08/06	2L, 2L-T	2446	31x129	SK-1522	BTK	
2.4 TD 4WD	08/95-08/06	2L-T	2446	31x129; 10/1996 →	SK-1522	BTK	



CM³



Art. Nr.



HIACE IV Bus (LH1_)							
2.5 D-4D	11/01-08/06	2KD-FTV	2494	25x97	SK-1713	BTK	
2.5 D-4D	11/01-08/06	2KD-FTV	2494	25x97	SK-1722	BTK	
2.5 D-4D 4WD	11/01-08/06	2KD-FTV	2494	25x97; ohne Spanndämpfer, Spannrolle	SK-1713	BTK	
2.5 D-4D 4x4	10/06-	2KD-FTV	2494	25x97; → 12/2012	SK-1722	BTK	
2.5 D-4D, 2.5 D-4D 4x4	08/06-	2KD-FTV	2494	25x97; 09/2006 →	SK-1713	BTK	
2.4 D, 2.4 TD, 2.4 TD 4WD	08/95-08/06	2L, 2L-T	2446		0-N013	TB [TE]	
2.4 D, 2.4 TD, 2.4 TD 4WD	08/95-08/06	2L, 2L-T	2446		0-N014	TB [DG]	
2.5 D-4D, 2.5 D-4D 4x4	11/01-08/06	2KD-FTV	2494		0-N176	TB [TE]	
2.5 D-4D, 2.5 D-4D 4x4	11/01-08/06	2KD-FTV	2494		0-N1819	TB [BT]	
2.5 D-4D, 2.5 D-4D 4x4	11/01-08/06	2KD-FTV	2494		0-N1880	VB [BT]	S
HIACE IV Kasten (H100)							
2.8 D	08/95-08/00	3L	2779	31x129	SK-1522	BTK	
HIACE IV Kasten (LXH1_, RZH1_, LH1_)							
2.4 D, 2.4 TD	08/95-08/06	2L, 2L-T	2446	31x129	SK-1522	BTK	
2.4 TD 4WD	08/95-08/06	2L-T	2446	31x129; 10/1996 →	SK-1522	BTK	
2.5 D-4D, 2.5 D-4D 4WD, 2.5 D-4D 4x4	11/01-08/06	2KD-FTV	2494	25x97	SK-1713	BTK	
2.5 D-4D, 2.5 D-4D 4WD, 2.5 D-4D 4x4	11/01-08/06	2KD-FTV	2494	25x97	SK-1722	BTK	
2.4 D, 2.4 TD, 2.4 TD 4WD	08/95-08/06	2L, 2L-T	2446		0-N013	TB [TE]	
2.4 D, 2.4 TD, 2.4 TD 4WD	08/95-08/06	2L, 2L-T	2446		0-N014	TB [DG]	
2.5 D-4D, 2.5 D-4D 4WD, 2.5 D-4D 4x4	11/01-08/06	2KD-FTV	2494		0-N176	TB [TE]	
2.5 D-4D, 2.5 D-4D 4WD, 2.5 D-4D 4x4	11/01-08/06	2KD-FTV	2494		0-N1819	TB [BT]	
2.5 D-4D, 2.5 D-4D 4WD, 2.5 D-4D 4x4	11/01-08/06	2KD-FTV	2494		0-N1880	VB [BT]	S
HIACE IV Pritsche/Fahrgestell (LXH1_, RCH1_, KLH1_)							
2.4 D	08/95-08/06	2L	2446		0-N013	TB [TE]	
2.4 D	08/95-08/06	2L	2446		0-N014	TB [DG]	
HIACE IV Wagon (H100)							
2.8 D	08/95-08/00	3L	2779	31x129	SK-1522	BTK	
HIACE V Kasten (TRH2_, KDH2_)							
2.5 D-4D	09/06-	2KD-FTV	2494	25x97	SK-1713	BTK	
2.5 D-4D	09/06-	2KD-FTV	2494	25x97; ohne Spanndämpfer, Spannrolle	SK-1713	BTK	
2.5 D-4D	09/06-	2KD-FTV	2494	25x97	SK-1722	BTK	
3.0 D	01/05-	1KD-FTV	2982	25x97; 05/2010 →; ohne Spanndämpfer, Spannrolle	SK-1713	BTK	
3.0 D	01/05-	1KD-FTV	2982	25x97; 05/2010 →	SK-1722	BTK	
2.5 D-4D	09/06-	2KD-FTV	2494		0-N176	TB [TE]	
2.5 D-4D	09/06-	2KD-FTV	2494		0-N1819	TB [BT]	
3.0 D	01/05-	1KD-FTV	2982		0-N176	TB [TE]	
3.0 D	01/05-	1KD-FTV	2982		0-N1819	TB [BT]	
2.5 D-4D	09/06-	2KD-FTV	2494		0-N1880	VB [BT]	S
2.7 VVTi	01/05-	2TR-FE	2694	→ 03/2007; ✱	0-N1878	VB [DG]	
3.0 D	01/05-	1KD-FTV	2982		0-N1880	VB [BT]	S
HIACE / COMMUTER V (TRH2_, KDH2_)							
2.5 D-4D	09/06-	2KD-FTV	2494	25x97	SK-1713	BTK	
2.5 D-4D	09/06-	2KD-FTV	2494	25x97	SK-1722	BTK	
2.5 D-4D, 2.5 D-4D 4WD	01/05-	2KD-FTV	2494		0-N176	TB [TE]	
2.5 D-4D, 2.5 D-4D 4WD	01/05-	2KD-FTV	2494		0-N1819	TB [BT]	
3.0 D	01/05-	1KD-FTV	2982		0-N176	TB [TE]	
3.0 D	01/05-	1KD-FTV	2982		0-N1819	TB [BT]	
2.5 D-4D, 2.5 D-4D 4WD	01/05-	2KD-FTV	2494		0-N1880	VB [BT]	S
2.7 VVTi	01/05-	2TR-FE	2694	→ 03/2007; ✱	0-N1878	VB [DG]	
3.0 D	01/05-	1KD-FTV	2982		0-N1880	VB [BT]	S
HILUX II Pick-up (LN8_, RN5_, LN6_, YN6_, YN5_, LN5_, RN6_)							
2.2 D	08/83-08/84	L	2188	25.4x130	SK-1189	BTK	
2.4 D	08/88-07/05	2L	2446	31x129; → 09/1991; Baumuster: LN85, LN90	SK-1522	BTK	
2.4 D	01/92-07/05	2L	2446	31x129; → 07/1997; Baumuster: LN85, LN90	SK-1522	BTK	
2.4 D 4WD	08/88-07/05	2L	2446	31x129; → 09/1991	SK-1522	BTK	
2.4 D, 2.4 D 4WD, 2.4 TD 4WD	01/94-07/05	2L, 2L-T	2446	31x129	SK-1522	BTK	
2.4 D, 2.4 D AWD	01/84-08/91	2L	2446	25.4x130	SK-1189	BTK	
2.5 D-4D, 2.5 D-4D 4WD	11/01-07/05	2KD-FTV	2494	25x97	SK-1713	BTK	
2.5 D-4D, 2.5 D-4D 4WD	11/01-07/05	2KD-FTV	2494	25x97	SK-1722	BTK	
2.8 D 4WD	08/94-07/01	3L	2779	31x129; → 12/1997	SK-1522	BTK	



OPTIMAL®

TOYOTA



CM³



Art. Nr.



ohne Halter

HILUX II Pick-up (LN8_, RN5_, LN6_, YN6_, YN5_, LN5_, RN6_)

2.8 D 4WD	08/94-07/01	3L	2779	25x97; → 12/1997	SK-1722	BTK	
2.8 D, 2.8 D Allrad	10/88-12/97	3L	2779	31x129	SK-1522	BTK	
3.0 D Allrad	11/01-04/05	1KZ-T	2982	25x102	SK-1521	BTK	
2.4 D AWD	01/84-08/88	2L	2446		0-N988	TB [TE]	
2.4 D AWD	01/84-08/88	2L	2446		0-N989	TB [DG]	
2.4 D, 2.4 D 4WD, 2.4 TD 4WD	08/88-07/05	2L, 2L-T	2446		0-N013	TB [TE]	
2.4 D, 2.4 D 4WD, 2.4 TD 4WD	08/88-07/05	2L, 2L-T	2446		0-N014	TB [DG]	
2.5 D-4D, 2.5 D-4D 4WD	11/01-07/05	2KD-FTV	2494		0-N176	TB [TE]	
2.5 D-4D, 2.5 D-4D 4WD	11/01-07/05	2KD-FTV	2494		0-N1819	TB [BT]	
3.0 D Allrad	11/01-04/05	1KZ-T	2982		0-N176	TB [TE]	
3.0 D Allrad	11/01-04/05	1KZ-T	2982		0-N1819	TB [BT]	
3.4	08/01-07/05	5VZ-FE	3378	08/2002 → 02/2005	0-N1773	TB [DG]	
3.4 4WD	08/01-07/05	5VZ-FE	3378		0-N1773	TB [DG]	
3.4, 3.4 4WD	08/01-07/05	5VZ-FE	3378		0-N1879	TB [TE]	
2.5 D-4D, 2.5 D-4D 4WD	11/01-07/05	2KD-FTV	2494		0-N1880	VB [BT]	S

HILUX Geländewagen geschlossen (ZN13_, LN9_, RN1_, YN8_, LN8)

3.0 TDiC 4x4	08/93-07/97	1KZ-T	2982		0-N1618	TB [TE]	
3.0 TDiC 4x4	08/93-07/97	1KZ-T	2982		0-N1819	TB [BT]	

HILUX II Pritsche/Fahrgestell (LN6_, LN5_, YN6_, YN5_, VZN1_)

3.0 D Allrad	08/97-08/05	5L-E	2986	31x129	SK-1522	BTK	
--------------	-------------	------	------	--------	---------	-----	--

HILUX Geländewagen geschlossen (RZN1_, LN1_)

3.4 4x4	11/95-07/04	5VZ-FE	3378		0-N1773	TB [DG]	
3.4 4x4	11/95-07/04	5VZ-FE	3378		0-N1879	TB [TE]	

HILUX III Pick-up (KUN_, TGN_, LAN_, GGN_)

2.5 D 4x4, 2.5 D-4D, 2.5 D-4D 4x4	07/05-	2KD-FTV	2494	25x97	SK-1713	BTK	
2.5 D 4x4, 2.5 D-4D, 2.5 D-4D 4x4	07/05-	2KD-FTV	2494	25x97	SK-1722	BTK	
2.5 D-4D 4x4	12/07-	2KD-FTV	2494	25x97; 01/2010 →	SK-1713	BTK	
2.5 D-4D 4x4	12/07-	2KD-FTV	2494	25x97; 01/2010 →	SK-1722	BTK	
3.0, 3.0 Allrad, 3.0 D-4D 4x4	08/05-09/06	1KD-FTV	2982	25x97	SK-1722	BTK	
3.0, 3.0 D-4D 4x4	08/05-09/06	1KD-FTV	2982	25x97	SK-1713	BTK	
2.5 D 4x4, 2.5 D-4D, 2.5 D-4D 4x4	07/05-	2KD-FTV	2494		0-N176	TB [TE]	
2.5 D 4x4, 2.5 D-4D, 2.5 D-4D 4x4	07/05-	2KD-FTV	2494		0-N1819	TB [BT]	
3.0, 3.0 Allrad, 3.0 D, 3.0 D-4D 4x4	08/05-09/06	1KD-FTV	2982		0-N176	TB [TE]	
3.0, 3.0 Allrad, 3.0 D, 3.0 D-4D 4x4	08/05-09/06	1KD-FTV	2982		0-N1819	TB [BT]	
2.0	02/05-	1TR-FE	1998	Baumuster: TGN10, TGN15; ☼	0-N1878	VB [DG]	
2.0	08/05-	1AZ-FSE	1998		0-N2185	VB [VD]	
2.5 D 4x4, 2.5 D-4D, 2.5 D-4D 4x4	07/05-	2KD-FTV	2494		0-N1880	VB [BT]	S
2.7	08/05-	2TR-FE	2694	Baumuster: TGN11, TGN16, TGN26, TGN36; ☼	0-N1878	VB [DG]	
2.7 Allrad	08/05-	2TR-FE	2694	☼	0-N1878	VB [DG]	
3.0, 3.0 Allrad, 3.0 D, 3.0 D-4D 4x4	08/05-09/06	1KD-FTV	2982		0-N1880	VB [BT]	S
4.0, 4.0 Allrad	08/05-	1GR-FE	3956	☼	0-N1728	VB [DG]	
4.0, 4.0 Allrad	08/05-	1GR-FE	3956	☼	0-N1878	VB [DG]	
4.0, 4.0 Allrad	08/05-	1GR-FE	3956		0-N2188	VB [BT]	S

HILUX III Pritsche/Fahrgestell (KUN1_, TGN3_, TGN2_, TGN1_)

2.7	02/05-	2TR-FE	2694	Baumuster: TGN11, TGN16, TGN26, TGN36; ☼	0-N1878	VB [DG]	
4.0	02/05-	1GR-FE	3956	Baumuster: GGN15, GGN25, GGN35; ☼	0-N1878	VB [DG]	
4.0 Allrad	02/05-	1GR-FE	3956	☼	0-N1878	VB [DG]	

IQ (KPJ1_, NGJ1_, KGJ1_, NUJ1_)

1.33	01/09-	1NR-FE	1329	05/2009 →	0-N2088	VB [BT]	S
1.4 D-4D	01/09-	1ND-TV	1364		0-N2107	VB [BT]	S

ISIS (ZNM1_, ANM1_, ZGM1_)

1.8 VVTi	07/04-	1ZZ-FE	1794		0-N1462	VB [BT]	S
2.0 VVTi, 2.0 VVTi 4x4	07/04-	1AZ-FSE	1998		0-N2185	VB [VD]	

KIJANG INNOVA (_TGN4_, _KUN4_)

2.5 D4d	08/04-	2KD-FTV	2494		0-N176	TB [TE]	
2.5 D4d	08/04-	2KD-FTV	2494		0-N1819	TB [BT]	
2.0	07/03-	1TR-FE	1998	08/2004 →; Baumuster: TGN40; ☼	0-N1878	VB [DG]	
2.5 D4d	08/04-	2KD-FTV	2494		0-N1880	VB [BT]	S
2.7 VVTi	08/04-	2TR-FE	2694	12/2004 →; Baumuster: TGN41; ☼	0-N1878	VB [DG]	



CM³



Art. Nr.



KLUGER (_MCU2_, _ACU2_)								
2.4, 2.4 4x4	06/00-05/07	2AZ-FE	2362			0-N2185	VB [VD]	
KLUGER (_MHU4_, _GSU4_, _ASU4_)								
3.5, 3.5 4x4	05/07-	2GR-FE	3456	*		0-N1728	VB [DG]	
3.5, 3.5 4x4	05/07-	2GR-FE	3456			0-N2032	VB [BT]	S
LAND CRUISER (PZJ7_, KZJ7_, HZJ7_, BJ7_, LJ7_, RJ7_)								
2.4 D	11/84-10/85	2L	2446	25.4x130		SK-1189	BTK	
2.4 TD	10/85-05/90	2L-T	2446	25.4x130; → 01/1990		SK-1189	BTK	
2.4 TD	10/85-05/90	2L-T	2446	31x129; 01/1990 →		SK-1522	BTK	
2.4 TD	01/90-05/93	2L-T	2446	31x129		SK-1522	BTK	
3.0 TD	05/93-05/96	1KZ-T	2982	25x102		SK-1521	BTK	
3.0 TD	05/93-05/96	1KZ-T	2982			SK-1682	BTK	
4.2 TDi 4x4	09/01-06/06	1HD-FTE	4164	25x105		SK-1752	BTK	
2.4 D , 2.4 TD	11/84-05/90	2L, 2L-T	2446			0-N988	TB [TE]	
2.4 D , 2.4 TD	11/84-05/90	2L, 2L-T	2446			0-N989	TB [DG]	
2.4 TD	01/90-05/93	2L-T	2446			0-N013	TB [TE]	
2.4 TD	01/90-05/93	2L-T	2446			0-N014	TB [DG]	
3.0 TD	05/93-05/96	1KZ-T	2982			0-N1618	TB [TE]	
3.0 TD	05/93-05/96	1KZ-T	2982			0-N1819	TB [BT]	
4.2 TD	01/90-	1H-Z	4164	05/1998 →		0-N2320	TB [TE]	
4.2 TDi 4x4	09/01-06/06	1HD-FTE	4164			0-N2320	TB [TE]	
4.5 TD 24V 4x4	03/07-	1VD-FTV	4461			0-N2301	VB [BT]	S
4.5 TD 24V 4x4	03/07-	1VD-FTV	4461			0-N2360	VB [DG]	
LAND CRUISER Hardtop (_J7_)								
2.4 TD	07/90-05/96	2L-T	2446	31x129		SK-1522	BTK	
3.0 TD	05/93-05/96	1KZ-T	2982			SK-1682	BTK	
2.4 TD	07/90-05/96	2L-T	2446			0-N013	TB [TE]	
2.4 TD	07/90-05/96	2L-T	2446			0-N014	TB [DG]	
3.0 TD	05/93-05/96	1KZ-T	2982			0-N1618	TB [TE]	
3.0 TD	05/93-05/96	1KZ-T	2982			0-N1819	TB [BT]	
LAND CRUISER Pick-up (_J7_)								
4.2 TD 4x4	01/90-	1H-Z	4164	05/1998 →		0-N2320	TB [TE]	
4.2 TD 4x4	03/07-	1H-Z	4164			0-N2320	TB [TE]	
4.0 4x4	03/07-	1GR-FE	3956	*		0-N1728	VB [DG]	
4.0 4x4	03/07-	1GR-FE	3956	*		0-N1878	VB [DG]	
LAND CRUISER 80 (_J8_)								
4.2 TD 24V	03/95-12/97	1HD-FT	4164	25x105		SK-1752	BTK	
3.0 TD	01/90-09/91	1KZ-T	2982			0-N1618	TB [TE]	
3.0 TD	01/90-09/91	1KZ-T	2982			0-N1819	TB [BT]	
4.2 TD 24V	03/95-12/97	1HD-FT	4164			0-N1821	TB [BT]	
4.2 TD 24V	03/95-12/97	1HD-FT	4164			0-N2320	TB [TE]	
LAND CRUISER 90 (_J9_)								
3.0 D-4D	10/00-	1KD-FTV	2982	25x97		SK-1713	BTK	
3.0 D-4D	10/00-	1KD-FTV	2982	25x97; → 08/2002		SK-1722	BTK	
3.0 TD	04/95-07/00	1KZ-TE	2982	25x102; 06/2000 →		SK-1521	BTK	
3.0 TD	04/95-07/00	1KZ-TE	2982			SK-1682	BTK	
3.0 TD	04/96-	1KZ-TE	2982	25x102		SK-1521	BTK	
3.0 TD	04/96-	1KZ-TE	2982	→ 06/2000		SK-1682	BTK	
3.4 i 24V	04/96-	5VZ-FE	3378	36x191		SK-1702	BTK	
3.0 D-4D	10/00-	1KD-FTV	2982			0-N176	TB [TE]	
3.0 D-4D , 3.0 TD	04/95-07/00	1KD-FTV, 1KZ-TE	2982			0-N1819	TB [BT]	
3.0 TD	04/95-07/00	1KZ-TE	2982			0-N1618	TB [TE]	
3.0 TD	04/96-	1KZ-TE	2982	→ 06/2000		0-N1618	TB [TE]	
3.0 TD	04/96-	1KZ-TE	2982	06/2000 →		0-N176	TB [TE]	
3.4 i 24V	04/96-	5VZ-FE	3378			0-N1773	TB [DG]	
3.4 i 24V	04/96-	5VZ-FE	3378			0-N1879	TB [TE]	
4.2 TD	08/99-08/01	1H-Z	4164			0-N2320	TB [TE]	
4.7	08/02-	2UZ-FE	4664			0-N1823	TB [BT]	
4.7	08/02-	2UZ-FE	4664			0-N1883	TB [BT]	S
4.7	08/02-	2UZ-FE	4664			0-N2058	TB [DG]	
3.0 D-4D	10/00-	1KD-FTV	2982			0-N2192	VB [BT]	S
4.7	08/02-	2UZ-FE	4664	Rippenanzahl: 6		0-N2186	VB [DG]	
4.7	08/02-	2UZ-FE	4664			0-N2187	VB [BT]	

CM³

Art. Nr.

**LAND CRUISER 100 (FZJ1_, UZJ1_)**

4.2 TD	01/98-08/07	1HD-FTE	4164	25x105; Baumuster: Land Cruiser 100	SK-1752	BTK	
4.2 TD	01/98-08/07	1HD-FTE	4164	25x105; Baumuster: Land Cruiser Amazon	SK-1752	BTK	
4.7	01/98-08/07	2UZ-FE	4664	34x211	SK-1703	BTK	
4.2 D 4x4 , 4.2 TD	01/98-08/07	1HD-FTE, 1H-Z	4164		0-N2320	TB [TE]	
4.2 TD	01/98-08/07	1HD-FTE	4164		0-N1821	TB [BT]	
4.7	01/98-08/07	2UZ-FE	4664		0-N1823	TB [BT]	
4.7	01/98-08/07	2UZ-FE	4664		0-N1883	TB [BT]	S
4.7	01/98-08/07	2UZ-FE	4664		0-N2058	TB [DG]	
4.7	01/98-08/07	2UZ-FE	4664	Rippenanzahl: 6	0-N2186	VB [DG]	
4.7	01/98-08/07	2UZ-FE	4664		0-N2187	VB [BT]	
4.7	01/98-08/07	2UZ-FE	4664		0-N2189S	VB [DG]	

LAND CRUISER (LJ12_, KZJ12_, TRJ12_, KDJ12_, GRJ12_)

3.0 D	09/02-07/09	5L-E	2986	31x129; 04/2006 →	SK-1522	BTK	
3.0 D-4D	09/02-07/09	1KD-FTV	2982	25x97	SK-1713	BTK	
3.0 D-4D	09/02-07/09	1KD-FTV	2982	25x97	SK-1722	BTK	
3.0 D-4D	01/03-07/09	1KD-FTV	2982	25x97; → 09/2004	SK-1722	BTK	
3.0 D-4D	08/04-07/09	1KD-FTV	2982	25x97; 10/2004 →	SK-1713	BTK	
3.0 D-4D	08/04-07/09	1KD-FTV	2982	25x97; → 10/2006	SK-1722	BTK	
3.0 D-4D	09/02-07/09	1KD-FTV, 1KZ-TE	2982		0-N176	TB [TE]	
3.0 D-4D	09/02-07/09	1KD-FTV, 1KZ-TE	2982		0-N1819	TB [BT]	
3.4	09/02-08/04	5VZ-FE	3378		0-N1773	TB [DG]	
3.4	09/02-08/04	5VZ-FE	3378		0-N1879	TB [TE]	
2.7	09/02-08/04	3RZ-FE	2694	☼	0-N1878	VB [DG]	
2.7	11/03-07/09	2TR-FE	2694	→ 07/2007; ☼	0-N1878	VB [DG]	
3.0 D-4D	09/02-07/09	1KD-FTV	2982		0-N2192	VB [BT]	S
4.0	09/02-07/09	1GR-FE	3956	☼	0-N1728	VB [DG]	
4.0	09/02-08/04	1GR-FE	3956	☼	0-N1878	VB [DG]	
4.0	09/02-07/09	1GR-FE	3956		0-N2188	VB [BT]	S
4.0	01/03-07/09	1GR-FE	3956	→ 11/2005; ☼	0-N1878	VB [DG]	

LAND CRUISER 150 (KDJ15_, GRJ15_)

3.0 D-4D	01/10-	1KD-FTV	2982	25x97	SK-1713	BTK	
3.0 D-4D	01/10-	1KD-FTV	2982		0-N176	TB [TE]	
3.0 D-4D	01/10-	1KD-FTV	2982		0-N1819	TB [BT]	
2.7 4WD	01/10-	2TR-FE	2694	☼	0-N1878	VB [DG]	
3.0 D-4D	01/10-	1KD-FTV	2982		0-N2192	VB [BT]	S
4.0 V6 Dual VVTi, 4.0 V6 VVTi, 4.0 V6 VVT-i	01/10-	1GR-FE	3956	☼	0-N1728	VB [DG]	
4.0 V6 Dual VVTi, 4.0 V6 VVTi, 4.0 V6 VVT-i	01/10-	1GR-FE	3956	☼	0-N1878	VB [DG]	
4.0 V6 Dual VVTi, 4.0 V6 VVTi, 4.0 V6 VVT-i	01/10-	1GR-FE	3956		0-N2188	VB [BT]	S
4.0 V6 VVT-i	01/10-	1GR-FE	3956		0-N2032	VB [BT]	S

LAND CRUISER 200 (VDJ2_, UZJ2_)

4.7 V8	01/08-	2UZ-FE	4664	34x211	SK-1703	BTK	
4.7 V8	08/07-	2UZ-FE	4664		0-N1823	TB [BT]	
4.7 V8	08/07-	2UZ-FE	4664		0-N1883	TB [BT]	S
4.7 V8	08/07-	2UZ-FE	4664		0-N2058	TB [DG]	
4.0 VVTi	01/10-	1GR-FE	3956	☼	0-N1728	VB [DG]	
4.0 VVTi	01/10-	1GR-FE	3956	☼	0-N1878	VB [DG]	
4.5 D V8 , 4.5 D-40 V8 , 4.5 D4-D	08/07-	1VD-FTV	4461		0-N2301	VB [BT]	S
4.5 D V8 , 4.5 D-40 V8 , 4.5 D4-D	08/07-	1VD-FTV	4461		0-N2360	VB [DG]	
4.7 V8	08/07-	2UZ-FE	4664	Rippenanzahl: 6	0-N2186	VB [DG]	
4.7 V8	08/07-	2UZ-FE	4664		0-N2187	VB [BT]	

LITEACE Kasten (KM2_)

1.8 D	10/82-09/85	1C	1839	25.4x177	SK-1062	BTK	
-------	-------------	----	------	----------	---------	-----	--

LITEACE Wagon (YM2_, CM2_, KM2_)

1.8 D	10/82-09/85	1C	1839	25.4x177	SK-1062	BTK	
1.8 D	10/82-09/85	1C	1839		0-N995	TB [TE]	
1.8 D	10/82-09/85	1C	1839		0-N996	TB [DG]	

LITEACE Bus (CM30_G, KM30_G)

2.0 D	08/88-01/92	2C	1975	25.4x177	SK-1062	BTK	
2.0 D	08/88-01/92	2C	1975		0-N995	TB [TE]	
2.0 D	08/88-01/92	2C	1975		0-N996	TB [DG]	



CM³



Art. Nr.



ohne Halter

LITEACE Kasten (CM3_V, KM3_V)							
1.8 D	10/85-08/88	1C	1839	25.4x177		SK-1062	BTK
2.0 D	08/88-01/92	2C	1975	25.4x177		SK-1062	BTK
1.8 D	10/85-08/88	1C	1839			0-N995	TB [TE]
1.8 D	10/85-08/88	1C	1839			0-N996	TB [DG]
2.0 D	08/88-01/92	2C	1975			0-N995	TB [TE]
2.0 D	08/88-01/92	2C	1975			0-N996	TB [DG]
LITEACE Bus (_R2_LG)							
2.0 D	01/92-05/94	2C	1974	25.4x177		SK-1062	BTK
LITEACE Kasten (_R2_V)							
2.0 D	01/92-05/94	2C	1974	25.4x177		SK-1062	BTK
LITEACE Bus							
1.8	10/97-08/01	1ZZ-FE	1794			0-N1462	VB [BT] S
MAJESTA							
4.0	09/99-08/03	1UZ-FE	3969			0-N1823	TB [BT]
4.0	09/99-08/03	1UZ-FE	3969			0-N1883	TB [BT] S
4.0	09/99-08/03	1UZ-FE	3969			0-N2058	TB [DG]
4.0	09/99-08/03	1UZ-FE	3969	Rippenanzahl: 6		0-N2186	VB [DG]
4.0	09/99-08/03	1UZ-FE	3969			0-N2187	VB [BT]
4.0	09/99-08/03	1UZ-FE	3969			0-N2189S	VB [DG]
MARK II Station Wagon (SXV2_, MCV2_, LX1_, JZX1_, GX1_)							
3.0	08/96-07/01	2JZ-GE	2997			0-N1877	VB [BT] S
MARK II Stufenheck							
2.5, 2.5 4x4, 2.5 VVTi	10/92-09/96	1JZ-GE, 1JZ-GTE	2491			0-N2183	VB [BT] S
3.0, 3.0 VVTi	10/92-09/96	2JZ-GE	2997			0-N1877	VB [BT] S
MARK II Stufenheck							
2.5, 2.5 4x4, 2.5 VVTi	10/96-09/01	1JZ-GE, 1JZ-GTE	2491			0-N2183	VB [BT] S
3.0, 3.0 VVTi	10/96-09/01	2JZ-GE	2997			0-N1877	VB [BT] S
MARK X I (GRX12_)							
2.5 VVTi, 2.5 VVTi 4x4	03/04-09/09	4GR-FSE	2499	☼		0-N1728	VB [DG]
3.0 VVTi	03/04-09/09	2JZ-FSE	2997			0-N1877	VB [BT] S
3.0 VVTi	05/04-09/09	3GR-FSE	2995	☼		0-N1728	VB [DG]
MARK X II (GRX13_)							
2.5, 2.5 4WD	10/09-	4GR-FSE	2499			0-N1728	VB [DG]
3.5	10/09-	2GR-FSE	3456			0-N1728	VB [DG]
MARK X ZiO (GGA1_, ANA1_)							
3.5	09/07-	2GR-FE	3456			0-N1728	VB [DG]
3.5	09/07-	2GR-FE	3456			0-N2032	VB [BT] S
MATRIX (ZZE13_)							
1.8 VVTi, 1.8 VVTi Allrad	09/01-02/04	1ZZ-FE	1794			0-N1462	VB [BT] S
MODELL F Bus (_R2_, 31)							
2.0 D	04/85-08/88	2C	1974	25.4x177		SK-1062	BTK
MR 2 I (AW1_)							
1.6 16V	11/84-06/90	4A-GEL, 4A-GELC	1587	19x113		SK-1197	BTK
1.6 16V	11/84-06/90	4A-GEL, 4A-GELC	1587			0-N998	TB [TE]
MR 2 II (SW2_)							
2.0	12/89-08/92	3S-FE	1998	27x163		SK-1186	BTK
2.0 16V	12/89-05/00	3S-GE	1998	25x178		SK-1187	BTK
2.0 16V	12/89-05/00	3S-GE	1998	→ 11/1993		0-N000	TB [TE]
2.0 16V	12/89-05/00	3S-GE	1998	02/1994 →		0-N2298	TB [BT]
2.0 16V	12/89-05/00	3S-GE	1998	05/1996 →		0-N2298	TB [BT]
2.0 16V	12/89-05/00	3S-GE	1998	ch.0087386 →; 06/1990 →		0-N2298	TB [BT]
2.0 16V	12/89-05/00	3S-GE	1998			0-N991	TB [DG]
MR 2 III (ZZW3_)							
1.8 16V VT-i	10/99-06/07	1ZZ-FE	1794			0-N1462	VB [BT] S
NOAH/VOXY (_AZR6_)							
2.0, 2.0 4x4	12/01-06/07	1AZ-FSE	1998			0-N2185	VB [VD]
OPA (ZCT1_, ACT1_)							
1.8, 1.8 4x4	04/00-08/03	1ZZ-FE	1794			0-N1462	VB [BT] S
2.0	08/00-04/05	1AZ-FSE	1998			0-N2185	VB [VD]

CM³

Art. Nr.



PASEO Coupe (EL44_)								
1.5	04/91-08/95	5E-FE	1497	26x128		SK-1190	BTK	
1.5	06/88-08/95	5E-FE	1497			0-N007	TB [TE]	
1.5	06/88-08/95	5E-FE	1497			0-N008	TB [DG]	
PASEO Cabriolet (EL54)								
1.5 16V	10/96-01/98	5E-FE	1497	26x128		SK-1190	BTK	
1.5, 1.5 16V	10/96-01/98	5E-FE	1497			0-N007	TB [TE]	
1.5, 1.5 16V	10/96-01/98	5E-FE	1497			0-N008	TB [DG]	
PASEO Coupe (EL54)								
1.5 16V	08/95-07/99	5E-FE	1497	26x128		SK-1190	BTK	
1.3	08/95-06/99	4E-FE	1332			0-N007	TB [TE]	
1.3	08/95-06/99	4E-FE	1332			0-N008	TB [DG]	
1.5, 1.5 16V	08/95-07/99	5E-FE	1497			0-N007	TB [TE]	
1.5, 1.5 16V	08/95-07/99	5E-FE	1497			0-N008	TB [DG]	
PASSO (_NC1_, _XC1_)								
1.3	06/05-12/07	K3-VE	1298			0-N2229	VB [TE]	
1.3	01/08-01/10	1NR-FE	1329			0-N2393	VB [BT]	S
PASSO (_NGC3_, _KGC3_)								
1.3	02/10-	1NR-FE	1329			0-N2393	VB [BT]	S
PASSO SETTE (M5_E)								
1.5, 1.5 4WD	12/08-	3SZ-VE	1495			0-N2273	VB [TE]	
PICNIC (_XM10)								
2.0	01/01-12/01	3S-FE	1998	27x163		SK-1186	BTK	
2.0 16V	05/96-12/01	3S-FE	1998	27x163; 08/1996 →		SK-1186	BTK	
2.2 D	08/97-12/01	3C-TE	2184	25.4x177		SK-1062	BTK	
2.0, 2.0 16V	05/96-12/01	3S-FE	1998			0-N991	TB [DG]	
2.0, 2.0 16V	05/96-12/01	3S-FE	1998			0-N992	TB [TE]	
2.2 D	08/97-12/01	3C-TE	2184			0-N995	TB [TE]	
2.2 D	08/97-12/01	3C-TE	2184			0-N996	TB [DG]	
PREMIO (ZZT24_, NZT24_, AZT24_)								
1.8	12/01-05/07	7A-FE	1762			0-N999	TB [TE]	
PREVIA (MCR3_, ACR3_, CLR3_)								
2.0 D-4D	03/01-01/06	1CD-FTV	1995	25x178		SK-1589	BTK	
2.0 D-4D	03/01-01/06	1CD-FTV	1995	25x178		SK-1589AQ1	BTKW	
2.0 D-4D	03/01-01/06	1CD-FTV	1995	25x178; mit Spanndämpfer, Spannrolle		SK-1717	BTK	
2.0 D-4D	03/01-01/06	1CD-FTV	1995	25x178; mit Spanndämpfer, Spannrolle		SK-1717AQ1	BTKW	
2.0 D-4D	03/01-01/06	1CD-FTV	1995			0-N1328	TB [TE]	
2.0 D-4D	03/01-01/06	1CD-FTV	1995			0-N1329	TB [DG]	
2.0 D-4D	03/01-01/06	1CD-FTV	1995	hydraulisch		0-N1820	TB [BT]	
2.0 D-4D	03/01-01/06	1CD-FTV	1995			0-N2098	VB [BT]	S
2.4 16V	08/00-01/06	2AZ-FE	2362			0-N1810	VB [BT]	S
2.4 16V	08/00-01/06	2AZ-FE	2362			0-N2185	VB [VD]	
3.5, 3.5 4x4	02/00-01/06	2GR-FE	3456	⊛		0-N1728	VB [DG]	
3.5, 3.5 4x4	02/00-01/06	2GR-FE	3456			0-N2032	VB [BT]	S
PREVIA III (AHR5_, GSR5_, ACR5_)								
2.4	10/05-	2AZ-FE	2362	04/2008 →		0-N2184	VB [BT]	S
2.4	10/05-	2AZ-FE	2362	→ 04/2008		0-N2185	VB [VD]	
3.5	01/06-	2GR-FE	3456	⊛		0-N1728	VB [DG]	
3.5, 3.5 4WD	01/06-	2GR-FE	3456			0-N1728	VB [DG]	
3.5, 3.5 4WD	01/06-	2GR-FE	3456			0-N2032	VB [BT]	S
PRIUS Stufenheck (NHW11_)								
1.5	05/00-01/04	1NZ-FXE	1497			0-N2201	VB [TE]	
PRIUS Liftback (NHW20_)								
1.5	08/03-03/09	1NZ-FXE	1497			0-N2201	VB [TE]	
PRIUS (ZVW3_)								
1.8 Hybrid	04/09-	2ZR-FXE	1798			0-N1462	VB [BT]	S
PROBOX/SUCCEED (_NLP5_, _NCP5_)								
1.4 D4d	07/02-	1ND-TV	1364			0-N2107	VB [BT]	S
1.5 VVTi Hybrid	07/02-	1NZ-FXE	1497			0-N2201	VB [TE]	
PROGRES (JCG1_)								
3.0	05/98-05/07	2JZ-FSE	2997			0-N1877	VB [BT]	S

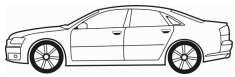

CM³



Art. Nr.



RACTIS (SCP10_, NCP10_)							
1.3	09/05-08/10	2SZ-FE	1298			0-N2273	VB [TE]
RAV 4 I (SXA1_)							
2.0 16V 4WD	06/94-06/00	3S-FE	1998	27x163		SK-1186	BTK
2.0 16V 4WD	06/94-06/00	3S-FE	1998			0-N991	TB [DG]
2.0 16V 4WD	06/94-06/00	3S-FE	1998			0-N992	TB [TE]
RAV 4 I Cabrio (SXA1_)							
2.0 16V 4WD	12/97-06/00	3S-FE	1998	27x163		SK-1186	BTK
2.0 16V 4WD	12/97-06/00	3S-FE	1998			0-N991	TB [DG]
2.0 16V 4WD	12/97-06/00	3S-FE	1998			0-N992	TB [TE]
RAV 4 II (CLA2_, XA2_, ZCA2_, ACA2_)							
2.0 D-4D 4WD	09/01-11/05	1CD-FTV	1995	25x178		SK-1589	BTK
2.0 D-4D 4WD	09/01-11/05	1CD-FTV	1995	25x178		SK-1589AQ1	BTKW
2.0 D-4D 4WD	09/01-11/05	1CD-FTV	1995	25x178; mit Spanndämpfer, Spannrolle		SK-1717	BTK
2.0 D-4D 4WD	09/01-11/05	1CD-FTV	1995	25x178; mit Spanndämpfer, Spannrolle		SK-1717AQ1	BTKW
2.0 D-4D 4WD	09/01-11/05	1CD-FTV	1995			0-N1328	TB [TE]
2.0 D-4D 4WD	09/01-11/05	1CD-FTV	1995			0-N1329	TB [DG]
2.0 D-4D 4WD	09/01-11/05	1CD-FTV	1995	hydraulisch		0-N1820	TB [BT]
1.8 VVTi	08/00-11/05	1ZZ-FE	1794			0-N1462	VB [BT] S
2.0 D-4D 4WD	09/01-11/05	1CD-FTV	1995			0-N2098	VB [BT] S
2.0 VVTi 4WD	06/00-11/05	1AZ-FE	1998			0-N1810	VB [BT] S
2.0 VVTi 4WD	06/00-11/05	1AZ-FE	1998			0-N2185	VB [VD]
2.4 VVTi 4WD	08/03-11/05	2AZ-FE	2362			0-N2184	VB [BT] S
2.4 VVTi 4WD	08/03-11/05	2AZ-FE	2362			0-N2185	VB [VD]
RAV 4 III (ACA3_, ACE_, ALA3_, GSA3_, ZSA3_)							
2.0 VVT-i 4WD	03/06-	1AZ-FE	1998			0-N1810	VB [BT] S
2.0 VVT-i 4WD	03/06-	1AZ-FE	1998			0-N2185	VB [VD]
2.2 D-4D, 2.2 D-4D 4WD, 2.2 D-CAT 4WD	03/06-	2AD-FHV, 2AD-FHV, 2AD-FTV, 2AD-FTV	2231			0-N1482S	VB [TE]
2.2 D-4D, 2.2 D-4D 4WD, 2.2 D-CAT 4WD	03/06-	2AD-FHV, 2AD-FHV, 2AD-FTV, 2AD-FTV	2231	→ 03/2011; ☼		0-N2040	VB [DG]
2.2 D-4D, 2.2 D-4D 4WD, 2.2 D-CAT 4WD	03/06-	2AD-FHV, 2AD-FHV, 2AD-FTV, 2AD-FTV	2231	→ 03/2011; ☼		0-N2040	VB [DG]
2.2 D-4D, 2.2 D-4D 4WD, 2.2 D-CAT 4WD	03/06-	2AD-FHV, 2AD-FHV, 2AD-FTV, 2AD-FTV	2231			0-N2051	VB [DG]
2.4 VVTi	11/05-	2AZ-FE	2362	07/2007 →; Baumuster: ACA30		0-N1810	VB [BT] S
2.4 VVTi	11/05-	2AZ-FE	2362			0-N2184	VB [BT] S
2.4 VVTi, 2.4 VVTi 4WD	11/05-	2AZ-FE	2362	07/2007 →; Baumuster: ACA30		0-N2185	VB [VD]
3.5 4WD	08/07-	2GR-FE	3456			0-N1728	VB [DG]
3.5 4WD, 3.5 VVTi 4WD	11/05-	2GR-FE	3456			0-N2032	VB [BT] S
3.5 VVTi 4WD	11/05-	2GR-FE	3456	☼		0-N1728	VB [DG]
RAV 4 IV (WWA4_, AVA4_, ZSA4_, ALA4_)							
2.0 D4-D, 2.0 D4-D 4WD	12/12-	1AD-FTV	1998			0-N2040	VB [DG]
2.0 D4-D, 2.0 D4-D 4WD	12/12-	1AD-FTV	1998			0-N2051	VB [DG]
2.2 D4-D 4WD	12/12-	2AD-FHV, 2AD-FTV	2231			0-N2040	VB [DG]
2.2 D4-D 4WD	12/12-	2AD-FHV, 2AD-FTV	2231			0-N2051	VB [DG]
REGIUSACE Bus (TRH2_, KDH2_)							
2.5 D4d	08/04-	2KD-FTV	2494			0-N176	TB [TE]
2.5 D4d	08/04-	2KD-FTV	2494			0-N1819	TB [BT]
2.5 D4d	08/04-	2KD-FTV	2494			0-N1880	VB [BT] S
REGIUSACE Kasten (TRH2_, KDH2_)							
2.5 D4d	08/04-	2KD-FTV	2494			0-N176	TB [TE]
2.5 D4d	08/04-	2KD-FTV	2494			0-N1819	TB [BT]
2.5 D4d	08/04-	2KD-FTV	2494			0-N1880	VB [BT] S
RUSH Geländewagen geschlossen (F700_)							
1.3	03/06-	K3-VE	1298			0-N2229	VB [TE]
1.5, 1.5 4x4	03/06-	3SZ-VE	1495			0-N2273	VB [TE]
SEQUOIA (UCK45_, UCK35_)							
4.7, 4.7 4x4	05/00-11/07	2UZ-FE	4664			0-N1823	TB [BT]
4.7, 4.7 4x4	05/00-11/07	2UZ-FE	4664			0-N1883	TB [BT] S
4.7, 4.7 4x4	05/00-11/07	2UZ-FE	4664			0-N2058	TB [DG]
4.7, 4.7 4x4	05/00-11/07	2UZ-FE	4664	Rippenanzahl: 6		0-N2186	VB [DG]
4.7, 4.7 4x4	05/00-11/07	2UZ-FE	4664			0-N2187	VB [BT]
4.7, 4.7 4x4	05/00-11/07	2UZ-FE	4664			0-N2189S	VB [DG]
SEQUOIA (UCK6_, UPK6_, USK6_)							
4.7 AWD	11/07-	2UZ-FE	4664			0-N2187	VB [BT]

CM³

Art. Nr.

**SEQUOIA (UCK6_, UPK6_, USK6_)**

4.7 AWD	11/07-	2UZ-FE	4664		0-N2189S	VB [DG]	
---------	--------	--------	------	--	----------	---------	--

SIENNA (MCL10_)

3.0	05/97-04/03	1MZ-FE	2995	32x211	SK-1289	BTK	
-----	-------------	--------	------	--------	---------	-----	--

SIENNA (ASL3_, GSL3_)

3.5 VVTi, 3.5 VVTi 4WD	02/10-	2GR-FE	3456	*	0-N1728	VB [DG]	
3.5 VVTi, 3.5 VVTi 4WD	02/10-	2GR-FE	3456		0-N2032	VB [BT]	S

SOARER Coupe (_Z3_)

4.0	05/92-09/00	1UZ-FE	3969		0-N1823	TB [BT]	
4.0	05/92-09/00	1UZ-FE	3969	07/1997 →	0-N1883	TB [BT]	S
4.0	05/92-09/00	1UZ-FE	3969		0-N2058	TB [DG]	
4.0	05/92-09/00	1UZ-FE	3969	→ 07/1997; mit Grundträger	0-N2319	TB [TE]	
2.5 Turbo	09/90-09/00	1JZ-GTE	2491		0-N2183	VB [BT]	S
3.0	09/90-09/00	2JZ-GE	2997		0-N1877	VB [BT]	S
4.0	05/92-09/00	1UZ-FE	3969	Rippenanzahl: 6	0-N2186	VB [DG]	
4.0	05/92-09/00	1UZ-FE	3969		0-N2187	VB [BT]	
4.0	05/92-09/00	1UZ-FE	3969		0-N2189S	VB [DG]	

SOLUNA VIOS

1.5	07/02-	5A-FE	1498		0-N999	TB [TE]	
-----	--------	-------	------	--	--------	---------	--

SPRINTER CARIB (AE11_)

1.3	06/92-04/97	4E-FE	1332		0-N007	TB [TE]	
1.3	06/92-04/97	4E-FE	1332		0-N008	TB [DG]	
1.8, 1.8 4x4	11/92-04/97	7A-FE	1762		0-N999	TB [TE]	

SPRINTER CARIB (AE11_)

1.6	08/95-10/01	4A-FE	1587		0-N999	TB [TE]	
1.8, 1.8 4x4	08/95-10/01	7A-FE	1762		0-N999	TB [TE]	

SPRINTER Liftback

1.3	06/92-11/00	4E-FE	1332		0-N007	TB [TE]	
1.3	06/92-11/00	4E-FE	1332		0-N008	TB [DG]	
1.6	06/92-04/97	4A-FE	1587		0-N999	TB [TE]	
1.8	11/92-04/97	7A-FE	1762		0-N999	TB [TE]	

SPRINTER Stufenheck (_E11_)

1.3	06/92-11/00	4E-FE	1332		0-N007	TB [TE]	
1.3	06/92-11/00	4E-FE	1332		0-N008	TB [DG]	
1.6	06/92-04/97	4A-FE	1587		0-N999	TB [TE]	
1.8	11/92-04/97	7A-FE	1762		0-N999	TB [TE]	

STARLET (_P7_)

1.0	10/84-12/89	1E-L	999	24x121	SK-1195	BTK	
1.3	10/84-12/89	2E-LC	1295	24x123; 03/1986 →	SK-1188	BTK	
1.0	10/84-12/89	1E-L	999	03/1986 →	0-N005	TB [TE]	
1.0	10/84-12/89	1E-L	999	03/1986 →	0-N006	TB [DG]	
1.3	10/84-12/89	2E-LC	1295	05/1986 →	0-N005	TB [TE]	
1.3	10/84-12/89	2E-LC	1295	05/1986 →	0-N006	TB [DG]	
1.0	10/84-12/89	1E-L	999		0-N1725	VB [DG]	
1.3	10/84-12/89	2E-LC	1295		0-N1725	VB [DG]	
1.5 D	12/86-12/89	1N	1453		0-N1725	VB [DG]	
1.5 D	12/86-12/89	1N	1453		0-N1754	VB [BT]	

STARLET (_P8_)

1.0	12/89-12/92	1E	999	24x121	SK-1195	BTK	
1.3 12V	12/89-03/96	2E, 2E-E, 2E-E	1296	24x123	SK-1188	BTK	
1.0	12/89-12/92	1E	999		0-N005	TB [TE]	
1.0	12/89-12/92	1E	999		0-N006	TB [DG]	
1.3 12V	12/89-03/96	2E, 2E-E, 2E-E	1296		0-N005	TB [TE]	
1.3 12V	12/89-03/96	2E, 2E-E, 2E-E	1296		0-N006	TB [DG]	
1.0	12/89-12/92	1E	999	04/1991 → 01/1992	0-N1725	VB [DG]	
1.3 12V	12/89-03/96	2E-E	1296	→ 12/1993	0-N1725	VB [DG]	
1.3 12V	12/89-12/92	2E, 2E-E	1296		0-N1725	VB [DG]	
1.3 XL	12/89-12/91	2E	1295		0-N1725	VB [DG]	

STARLET (EP91)

1.3	04/96-03/99	4E-FE	1332	26x124	SK-1196	BTK	
1.3	04/96-03/99	4E-FE	1332		0-N007	TB [TE]	
1.3	04/96-03/99	4E-FE	1332		0-N008	TB [DG]	



CM³



Art. Nr.



SUPRA (JZA80)							
3.0 i Bi-Turbo	05/93-08/02	2JZ-GTE	2997			0-N1549	TB [TE]
3.0 i, 3.0 i Bi-Turbo	05/93-08/02	2JZ-GE, 2JZ-GTE	2997			0-N1877	VB [BT] S
TERCEL (_L1_, _L2_)							
1.3	03/79-01/88	2A	1296	19x88; 05/1982 →		SK-1650	BTK
1.45	08/83-05/85	3A-C	1452	19x88		SK-1650	BTK
1.3	03/79-01/88	2A	1296			0-N997	TB [TE]
TERCEL (AL2_)							
1.5 4WD	10/82-01/88	3A, 3A-C	1452	19x88		SK-1650	BTK
1.5 4WD	10/82-01/88	3A, 3A-C	1452			0-N997	TB [TE]
TERCEL Station Wagon (AL2_)							
1.5	08/82-10/86	3A	1452	19x88		SK-1650	BTK
TERCEL Stufenheck							
1.5, 1.5 4x4	05/82-10/85	3A-U	1452	19x88		SK-1650	BTK
TERCEL Liftback							
1.3	05/92-10/94	4E-FE	1332	26x124		SK-1196	BTK
1.3	05/92-10/94	4E-FE	1332			0-N007	TB [TE]
1.3	05/92-10/94	4E-FE	1332			0-N008	TB [DG]
TERCEL Stufenheck							
1.3	05/92-10/94	4E-FE	1332			0-N007	TB [TE]
1.3	05/92-10/94	4E-FE	1332			0-N008	TB [DG]
TERCEL Liftback							
1.3	11/94-09/99	4E-FE	1332	26x124		SK-1196	BTK
1.5	11/94-09/99	5E-FE	1496	26x128		SK-1190	BTK
1.3	11/94-09/99	4E-FE	1332			0-N007	TB [TE]
1.3	11/94-09/99	4E-FE	1332			0-N008	TB [DG]
TERCEL Stufenheck							
1.3	11/94-09/99	4E-FE	1332			0-N007	TB [TE]
1.3	11/94-09/99	4E-FE	1332			0-N008	TB [DG]
1.5, 1.5 4x4	11/94-09/99	5E-FE	1497			0-N007	TB [TE]
1.5, 1.5 4x4	11/94-09/99	5E-FE	1497			0-N008	TB [DG]
TOWN ACE Bus (SR5_, SR4_, KR4_, CR5_, CR4_)							
2.4	10/03-07/07	2AZ-FE	2362			0-N2185	VB [VD]
TOWN ACE Bus (S4_)							
1.5, 1.5 4WD	01/08-	3SZ-VE	1495			0-N2273	VB [TE]
TOWN ACE Pritsche/Fahrgestell (S4_)							
1.5, 1.5 4WD	01/08-	3SZ-VE	1495			0-N2273	VB [TE]
TUNDRA Pick-up (_K4_, _K3_)							
3.4, 3.4 4x4	04/99-07/03	5VZ-FE	3378			0-N1773	TB [DG]
3.4, 3.4 4x4	04/99-07/03	5VZ-FE	3378			0-N1879	TB [TE]
4.0, 4.0 4x4	05/03-11/06	1GR-FE	3956	☼		0-N1728	VB [DG]
4.0, 4.0 4x4	05/03-11/06	1GR-FE	3956	☼		0-N1878	VB [DG]
4.0, 4.0 4x4	05/03-11/06	1GR-FE	3956			0-N2188	VB [BT] S
TUNDRA Pick-up (_K5_)							
4.0, 4.0 4WD	01/07-12/11	1GR-FE	3956	☼		0-N1878	VB [DG]
URBAN CRUISER (NSP1_, NLP1_, ZSP1_, NCP11_)							
1.33	04/09-	1NR-FE	1329			0-N2198	VB [BT] S
1.4 D-4D, 1.4 D-4D 4WD	04/09-	1ND-TV	1364			0-N2107	VB [BT] S
VERSO (_AUR2_, _ZGR2_)							
1.6 D4-D	11/13-	1WW	1598			0-N2369	VB [DG]
1.6 D4-D	11/13-	1WW	1598			0-N2387	VB [BT] S
2.0 D-4D	04/09-	1AD-FTV	1998			0-N1482S	VB [TE]
2.0 D-4D	04/09-	1AD-FTV	1998			0-N2040	VB [DG]
2.0 D-4D	04/09-	1AD-FTV	1998			0-N2051	VB [DG]
2.2 D-4D, 2.2 D-CAT	04/09-	2AD-FHV	2231			0-N1482S	VB [TE]
2.2 D-4D, 2.2 D-CAT	04/09-	2AD-FHV	2231			0-N2040	VB [DG]
2.2 D-4D, 2.2 D-CAT	04/09-	2AD-FHV	2231			0-N2051	VB [DG]
VERSO S (NLP12_, NCP12_, NSP12_)							
1.33	11/10-	1NR-FE	1329			0-N2393	VB [BT] S
1.4 D4-D	11/10-	1ND-TV	1364			0-N2107	VB [BT] S

CM³

Art. Nr.



VIOS (SCP4_, NCP4_, AXP4_)							
1.3 VVTi	07/02-01/08	8A-FE	1342			0-N999	TB [TE]
VISTA Stufenheck (SV5_, ZV5_)							
1.8 N180	06/98-08/03	1ZZ-FE	1794			0-N1462	VB [BT] S
2.0 D4 N200, 2.0 D4 N200 4WD	06/98-08/03	1AZ-FE, 1AZ-FSE	1998			0-N2185	VB [VD]
2.4	06/01-08/03	2AZ-FE	2362			0-N2185	VB [VD]
WILL VS (ZZE12_, NZE12_)							
1.8 VVTi, 1.8 VVTi 4WD, 1.8 VVTi GT	03/01-04/04	1ZZ-FE, 1ZZ-GE	1794			0-N1462	VB [BT] S
WISH Großraumlimousine (ZNE1_, ANE1_)							
1.8 Hi, 1.8 Hi 4WD	04/03-03/09	1ZZ-FE	1794			0-N1462	VB [BT] S
2.0 Zi	04/03-03/09	1AZ-FSE	1998			0-N2185	VB [VD]
YARIS (SCP1_, NLP1_, NCP1_)							
1.0 16V	04/99-09/05	1SZ-FE	998	Baumuster: SCP10; ⚡, für Fahrzeuge mit Servolenkung; Fahrzeugproduktionsland Japan		0-N1983	VB [DG]
1.0 16V	04/99-09/05	1SZ-FE	998	ch.VNK; 02/2003 →; ⚡		0-N2304	VB [DG]
1.0 16V	03/03-09/05	1SZ-FE	998	ch.VNK; ⚡		0-N2304	VB [DG]
1.3	04/02-09/05	2SZ-FE	1298	Baumuster: SCP12; für Fahrzeuge mit elektrischer Servolenkung; ⚡; Fahrzeugproduktionsland Frankreich		0-N2304	VB [DG]
1.4 D-4D	12/01-09/05	1ND-TV	1364			0-N2107	VB [BT] S
1.0 16V	04/99-09/05	1SZ-FE	998	⚡; Fahrzeugproduktionsland Japan		0-N1981	FB [DG]
1.3 16V	11/99-09/05	2NZ-FE	1299	⚡; Fahrzeugproduktionsland Japan		0-N1981	FB [DG]
1.4 D-4D	12/01-09/05	1ND-TV	1364	⚡; Fahrzeugproduktionsland Japan		0-N1981	FB [DG]
1.5 TS, 1.5 VVT-i TS	04/01-09/05	1NZ-FE	1497	⚡; Fahrzeugproduktionsland Japan		0-N1981	FB [DG]
YARIS (SCP9_, NSP9_, KSP9_, NCP9_, ZSP9_)							
1.3 VVT-i	08/05-	2NZ-FE, 2SZ-FE	1298	→ 11/2008; Baumuster: SCP90		0-N2304	VB [DG]
1.33 VVT-i	03/09-	1NR-FE	1329			0-N2198	VB [BT] S
1.4 D-4D	08/05-	1ND-TV	1364			0-N2107	VB [BT] S
1.8 VVTi	11/05-	1ZZ-FE	1794			0-N1462	VB [BT] S
YARIS (NHP13_, NSP13_, NCP13_, KSP13_, NLP13_)							
1.3, 1.3 4WD	12/10-	1NR-FE, 1NR-FE, 1NR-FKE	1329			0-N2393	VB [BT] S
1.4 D-4D	09/11-	1ND-TV	1364			0-N2107	VB [BT] S
YARIS VERSO (_NLP2_, _NCP2_)							
1.4 D-4D	12/01-09/05	1ND-TV	1364			0-N2107	VB [BT] S
VENZA (GGV1_, AGV1_)							
3.5, 3.5 4WD	11/08-	2GR-FE	3456	Antriebsart: Heckantrieb; für Fahrzeuge mit Automatikgetriebe		0-N2032	VB [BT] S



CM³



Art. Nr.



ohne Halter

COROLLA							
1.8	02/04-01/07	1ZZ-FE	1794		0-N1462	VB [BT]	S
CROWN ROYAL							
2.5	02/05-	5GR-FE	2497		0-N2032	VB [BT]	S
3.0	02/05-	3GR-FE	2995		0-N2032	VB [BT]	S
LAND CRUISER 100							
4.7 AWD	10/03-07/07	2UZ-FE	4664		0-N1823	TB [BT]	
4.7 AWD	10/03-07/07	2UZ-FE	4664		0-N1883	TB [BT]	S
4.7 AWD	10/03-07/07	2UZ-FE	4664		0-N2058	TB [DG]	
4.7 AWD	10/03-07/07	2UZ-FE	4664	Rippenanzahl: 6	0-N2186	VB [DG]	
4.7 AWD	10/03-07/07	2UZ-FE	4664		0-N2187	VB [BT]	
4.7 AWD	10/03-07/07	2UZ-FE	4664		0-N2189S	VB [DG]	
PRADO							
4.0 Allrad	10/03-06/10	1GR-FE	3956	✳	0-N1878	VB [DG]	
REIZ							
2.5	10/05-09/10	5GR-FE	2497		0-N2032	VB [BT]	S
3.0	10/05-09/10	3GR-FE	2995		0-N2032	VB [BT]	S
VIOS							
1.3	11/02-10/05	8A-FE	1342		0-N999	TB [TE]	
1.5	11/02-10/05	5A-FE	1498		0-N999	TB [TE]	

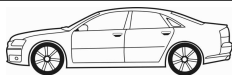

CM³



Art. Nr.



ohne Halter

CAMRY

200	06/06-	1AZ-FE	1998		0-N2185	VB [VD]	
240	06/06-	2AZ-FE	2362		0-N2185	VB [VD]	



CM³



Art. Nr.



ohne Halter

31512

2.1 D	01/98-	XUD11 A	2138	25.4x144; mit Zubehör	SK-1016	BTK
-------	--------	---------	------	-----------------------	---------	-----



OPTIMAL®

VAUXHALL



CM³



Art. Nr.



ohne Halter

ADAM								
1.2	10/12-	A 12 XEL, B 12 XEL	1229			0-N2170	VB [BT]	S
1.4	10/12-	A 14 XEL, A 14 XER	1398			0-N2170	VB [BT]	S
AGILA Mk I (A)								
1.0 12V	02/00-11/06	Z 10 XEP	998			0-N2170	VB [BT]	S
1.0 12V	09/00-08/05	Z 10 XE	973			0-N2170	VB [BT]	S
1.2 16V	09/00-03/08	Z 12 XE	1199			0-N2170	VB [BT]	S
1.2 16V Twinport	07/04-11/06	Z 12 XEP	1229			0-N2170	VB [BT]	S
AGILA Mk II (B)								
1.3 CDTi	01/08-11/14	D13A, Z 13 DTJ	1248			0-N1526	VB [BT]	S
ANTARA (J26, H26)								
2.0 CDTi	08/06-04/15	Z 20 DM	1991	22x151; 06/2007 →		SK-1723	BTK	
2.0 CDTi	08/06-04/15	Z 20 DMH	1991	22x151; 11/2006 →		SK-1723	BTK	
2.0 CDTi FWD	08/06-	Z 20 DM, Z 20 DMH	1991	22x151		SK-1723	BTK	
2.0 CDTi, 2.0 CDTi FWD	08/06-04/15	Z 20 DM, Z 20 DMH	1991	22x151		SK-1723AQ1	BTKW	
2.4	08/06-04/15	Z 24 XED	2405	24x171		SK-1644AQ1	BTKW	
2.4, 2.4 FWD	08/06-04/15	Z 24 XED	2405	24x171		SK-1644	BTK	
2.0 CDTi, 2.0 CDTi FWD	08/06-04/15	Z 20 DM, Z 20 DMH	1991			0-N1952	TB [TE]	
2.0 CDTi, 2.0 CDTi FWD	08/06-04/15	Z 20 DM, Z 20 DMH	1991			0-N1960	TB [TE]	
2.4, 2.4 FWD	08/06-04/15	Z 24 XED	2405			0-N1383	TB [TE]	
2.4, 2.4 FWD	08/06-04/15	Z 24 XED	2405			0-N906	TB [DG]	
2.0 CDTi, 2.0 CDTi FWD	08/06-04/15	Z 20 DM, Z 20 DMH	1991			0-N2171	VB [DG]	
2.0 CDTi, 2.0 CDTi FWD	08/06-04/15	Z 20 DM, Z 20 DMH	1991			0-N2197	VB [BT]	S
2.2 CDTi, 2.2 CDTi FWD	12/10-	A 22 DM, A 22 DMH	2231			0-N2420	VB [DG]	
2.2 CDTi, 2.2 CDTi FWD	12/10-	A 22 DM, A 22 DMH	2231			0-N2421	VB [DG]	
2.4	11/10-04/15	A 24 XE	2384			0-N2283	VB [DG]	
2.4	11/10-04/15	A 24 XE	2384			0-N2299	VB [BT]	S
3.0	11/10-04/15	A 30 XH	2997			0-N2194	VB [BT]	S
3.0	11/10-04/15	A 30 XH	2997			0-N2340	VB [DG]	
3.2 V6	11/06-04/15	10 HM, Z 32 SED	3195			0-N2194	VB [BT]	S
3.2 V6	11/06-04/15	10 HM, Z 32 SED	3195			0-N2340	VB [DG]	
ARENA Combi								
1.9 D	03/98-08/01	F8Q 600, F8Q 606	1870	25.4x153; 09/1998 →		SK-1107	BTK	
2.5 D	03/98-08/01	S8U 758, S8U 780, S8U 782	2499	30x152		SK-1035	BTK	
2.5 D	03/98-08/01	S8U 758, S8U 780, S8U 782	2499	30x152; mit Spanndämpfer, Spannrolle		SK-1680	BTK	
1.9 D	03/98-08/01	F8Q 600, F8Q 606	1870			0-N147	TB [DG]	
1.9 D	03/98-08/01	F8Q 600, F8Q 606	1870			0-N173	TB [TE]	
1.9 D	03/98-08/01	F8Q 600, F8Q 606	1870			0-N854	TB [DG]	
2.5 D	03/98-08/01	S8U 758, S8U 780, S8U 782	2499			0-N1617	TB [BT]	
2.5 D	03/98-08/01	S8U 758, S8U 780, S8U 782	2499			0-N816	TB [DG]	
2.5 D	03/98-08/01	S8U 758, S8U 780, S8U 782	2499			0-N821	TB [DG]	
ARENA Van								
1.9 D	03/98-08/01	F8Q 600, F8Q 606	1870	25.4x153		SK-1107	BTK	
2.5 D	03/98-08/01	S8U 758, S8U 780, S8U 782	2499	30x152		SK-1035	BTK	
2.5 D	03/98-08/01	S8U 758, S8U 780, S8U 782	2499	30x152; mit Spanndämpfer, Spannrolle		SK-1680	BTK	
1.9 D	03/98-08/01	F8Q 600, F8Q 606	1870			0-N147	TB [DG]	
1.9 D	03/98-08/01	F8Q 600, F8Q 606	1870			0-N173	TB [TE]	
1.9 D	03/98-08/01	F8Q 600, F8Q 606	1870			0-N854	TB [DG]	
2.5 D	03/98-08/01	S8U 758, S8U 780, S8U 782	2499			0-N1617	TB [BT]	
2.5 D	03/98-08/01	S8U 758, S8U 780, S8U 782	2499			0-N816	TB [DG]	
2.5 D	03/98-08/01	S8U 758, S8U 780, S8U 782	2499			0-N821	TB [DG]	
ASTRA CC								
1.6 D	03/82-08/86	16 D	1598	24x146; 07/1983 →; :14498631 →;		SK-1037	BTK	
1.6 D	03/82-08/86	16 D	1598	24x146; 07/1983 →; :14503757 →;		SK-1037	BTK	
1.6 D	03/82-08/86	16 D	1598	24x146; 07/1983 →; :14498631 →;		SK-1037AQ1	BTKW	
1.6 D	03/82-08/86	16 D	1598	24x146; 07/1983 →; :14503757 →;		SK-1037AQ1	BTKW	
1.6 D	03/82-08/86	16 D	1598	24x147; 07/1983 →; :14498630;		SK-1056	BTK	
1.6 D	03/82-08/86	16 D	1598	24x147; 07/1983 →; :14503756;		SK-1056	BTK	
1.6 S	09/81-08/86	16 S	1598	20x111; ch.12387790, 14391115 →		R-1072AQ1	BTKW	
1.8 GTE	03/83-08/86	18 E	1796	20x111; 06/1983 →; :14056061 →; :14270600		R-1072AQ1	BTKW	
1.6 D	03/82-08/86	16 D	1598	:14478631, 14503757 →		0-N875	TB [DG]	
1.8 GTE	03/83-08/86	18 E	1796	:14270601 →		0-N101	TB [TE]	

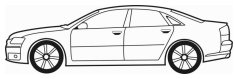

CM³



Art. Nr.



ASTRA Estate							
1.6 D	02/82-08/86	16 D	1598	24x146; 07/1983 →; :14498631 →;	SK-1037	BTK	
1.6 D	02/82-08/86	16 D	1598	24x146; 07/1983 →; :14503757 →;	SK-1037	BTK	
1.6 D	02/82-08/86	16 D	1598	24x146; 07/1983 →; :14498631 →;	SK-1037AQ1	BTKW	
1.6 D	02/82-08/86	16 D	1598	24x146; 07/1983 →; :14503757 →;	SK-1037AQ1	BTKW	
1.6 D	02/82-08/86	16 D	1598	24x147; 07/1983 →; :→14498630;	SK-1056	BTK	
1.6 D	02/82-08/86	16 D	1598	24x147; 07/1983 →; :→14503756;	SK-1056	BTK	
1.6 S	09/81-08/86	16 SH	1598	20x111; ch.12387790, 14391115 →	R-1072AQ1	BTKW	
1.6 D	02/82-08/86	16 D	1598	:14478631, 14503757 →	0-N875	TB [DG]	
ASTRA Mk II Belmont							
1.4 i	01/90-12/91	C 14 NZ	1389	17x111; :19311739 →; mit Zubehör	SK-1162	BTK	
1.4 i	01/90-12/91	C 14 NZ	1389	17x111; ch.02J22350, 19311738 →; :19311739 →; mit Zubehör	SK-1162AQ1	BTKW	
1.5 DT	01/87-08/90	15 DT, 15 DT (T4EC1)	1499	25x136; mit Zubehör	SK-1054	BTK	
1.6	09/85-08/91	16 SH	1598	20x111; ch.12387790, 14391115 →	R-1072AQ1	BTKW	
1.6 D	09/85-08/91	16 DA	1598	24x146	SK-1037	BTK	
1.6 D	09/85-08/91	16 DA	1598	24x146; :14498631 →;	SK-1037AQ1	BTKW	
1.6 D	09/85-08/91	16 DA	1598	24x146; :14503757 →;	SK-1037AQ1	BTKW	
1.6 D	09/85-08/91	16 DA	1598	24x147; 01/1986 →; :→14498630;	SK-1056	BTK	
1.6 D	09/85-08/91	16 DA	1598	24x147; 01/1986 →; :→14503756;	SK-1056	BTK	
1.6 S	01/89-12/91	16 SV	1598	17x111; 09/1989 →; :02J22350 →; mit Zubehör	SK-1162	BTK	
1.6 S	01/89-12/91	16 SV	1598	17x111; 09/1989 →; :02J22350 →; mit Zubehör	SK-1162AQ1	BTKW	
1.7 D	01/89-12/91	17 D	1699	24x146	SK-1037	BTK	
1.7 D	01/89-12/91	17 D	1699	24x146; :→14363650	SK-1037AQ1	BTKW	
1.7 D	01/89-12/91	17 D	1699	24x176; :14363651 →	SK-1038	BTK	
1.7 D	01/89-12/91	17 D	1699	24x176; :14363652 →	SK-1038AQ1	BTKW	
1.8, 1.8 i	09/85-08/91	18 E, 18 SE, 18 SE	1796	20x111; :14056061 →; :→14270600	R-1072AQ1	BTKW	
1.5 DT	01/87-08/90	15 DT, 15 DT (T4EC1)	1499		0-N878	TB [DG]	
1.5 DT	01/87-08/90	15 DT, 15 DT (T4EC1)	1499		0-N879	TB [TE]	
1.6 D	09/85-08/91	16 DA	1598	:14478631, 14503757 →	0-N875	TB [DG]	
1.7 D	01/89-12/91	17 D	1699		0-N875	TB [DG]	
1.8 i	09/85-08/91	18 E, 18 SE	1796		0-N101	TB [TE]	
1.4 i	01/90-12/91	C 14 NZ	1389	:19311739 →	0-N948	TB [TE]	
1.6 S	01/89-12/91	16 SV	1598	:02122350 →	0-N948	TB [TE]	
ASTRA Mk II CC							
1.4 i	01/90-08/91	C 14 NZ	1389	17x111; :19311738 →; mit Zubehör	SK-1162	BTK	
1.4 i	01/90-08/91	C 14 NZ	1389	17x111; ch.02J22350, 19311738 →; :19311739 →; mit Zubehör	SK-1162AQ1	BTKW	
1.4 S	01/90-08/91	14 NV	1389	17x111; :02J22650, 19307806 →; mit Zubehör	SK-1162	BTK	
1.4 S	01/90-08/91	14 NV	1389	17x111; :02J22650, 19307806 →; mit Zubehör	SK-1162AQ1	BTKW	
1.6	09/84-08/91	16 SV	1598	17x111; 09/1986 →; :02J22350 →; mit Zubehör	SK-1162	BTK	
1.6	09/84-08/91	16 SV	1598	17x111; 09/1986 →; :02J22350 →; mit Zubehör	SK-1162AQ1	BTKW	
1.6 D	09/84-12/89	16 DA	1598	24x146	SK-1037	BTK	
1.6 D	09/84-12/89	16 DA	1598	24x146; :14498631 →;	SK-1037AQ1	BTKW	
1.6 D	09/84-12/89	16 DA	1598	24x146; :14503757 →;	SK-1037AQ1	BTKW	
1.6 D	09/84-12/89	16 DA	1598	24x147; :→14498630;	SK-1056	BTK	
1.6 D	09/84-12/89	16 DA	1598	24x147; :→14503756;	SK-1056	BTK	
1.7 D	01/89-08/91	17 DR	1699	24x146	SK-1037	BTK	
1.7 D	01/89-08/91	17 DR	1699	24x146; :→14363650	SK-1037AQ1	BTKW	
1.7 D	01/89-08/91	17 DR	1699	24x176; :14363651 →	SK-1038	BTK	
1.7 D	01/89-08/91	17 DR	1699	24x176; :14363652 →	SK-1038AQ1	BTKW	
1.8 GTE	09/84-08/91	18 E, 18 SE	1796	20x111; :14056061 →; :→14270600	R-1072AQ1	BTKW	
1.9	03/88-08/91	C 20 XE	1998	24x141; :→14142838	SK-1163	BTK	
1.9, 2.0 GTE 16V	03/88-08/91	20 XE, C 20 XE	1998	24x176; :14142839 →	SK-1165	BTK	
2.0 GTE 16V	05/88-08/91	20 XE	1998	24x141	SK-1163	BTK	
2.0, 2.0 GTE	09/86-08/91	20 NE, 20 SEH	1998	20x111; :→14608700	R-1072AQ1	BTKW	
1.6 D	09/84-12/89	16 DA	1598	:14478631, 14503757 →	0-N875	TB [DG]	
1.7 D	01/89-08/91	17 DR	1699		0-N100	TB [TE]	
1.7 D	01/89-08/91	17 DR	1699		0-N909	TB [DG]	
1.9	03/88-08/91	C 20 XE	1998	:14142839 →	0-N100	TB [TE]	
1.9	03/88-08/91	C 20 XE	1998	:14142839 →	0-N906	TB [DG]	
1.9	03/88-08/91	C 20 XE	1998	:14142839 →	0-N907	TB [DG]	

CM³

Art. Nr.



ohne Halter

ASTRA Mk II CC

1.9, 2.0 GTE 16V	03/88-08/91	20 XE, C 20 XE	1998		0-N877	TB [TE]
2.0, 2.0 GTE	09/86-08/91	20 NE, 20 SEH	1998	14608701 →	0-N101	TB [TE]
1.4 i	01/90-08/91	C 14 NZ	1389	19311739 →	0-N948	TB [TE]
1.4 S	01/90-08/91	14 NV	1389	19307806 →	0-N948	TB [TE]
1.6	09/84-08/91	16 SV	1598	02122350 →	0-N948	TB [TE]

ASTRA Mk II Convertible

1.6 i	01/87-12/91	16 SV	1598	17x111; 09/1987 →; 02J22350 →; mit Zubehör	SK-1162	BTK
1.6 i	01/87-12/91	16 SV	1598	17x111; 09/1987 →; 02J22350 →; mit Zubehör	SK-1162AQ1	BTKW
1.6 i, 1.6 i KAT	10/87-08/93	C 16 LZ, C 16 NZ, E 16 NZ	1598	17x111; 02J22350 →; mit Zubehör	SK-1162	BTK
1.6 i, 1.6 i KAT	10/87-08/93	C 16 LZ, C 16 NZ, E 16 NZ	1598	17x111; 02J22350 →; mit Zubehör	SK-1162AQ1	BTKW
2.0 i, 2.0 i KAT	01/87-08/93	20 NE, C 20 NE	1998	20x111; →14608700	R-1072AQ1	BTKW
2.0 i, 2.0 i KAT	01/87-08/93	C 20 NE	1998	20x146; 14608701 →	SK-1169	BTK
2.0 i, 2.0 i KAT	01/87-08/93	20 NE, C 20 NE	1998	20x146; 14608701 →	SK-1169AQ1	BTKW
2.0 i, 2.0 i KAT	01/87-08/93	20 NE, C 20 NE	1998	14608701 →	0-N101	TB [TE]
1.6 i, 1.6 i KAT	01/87-08/93	16 SV, C 16 LZ, C 16 NZ, E 16 NZ	1598	02122350 →	0-N948	TB [TE]

ASTRA Mk II Estate

1.4 S	01/89-08/91	14 NV	1389	17x111; 09/1989 →; 02J22650, 19307806 →; mit Zubehör	SK-1162	BTK
1.4 S	01/89-08/91	14 NV	1389	17x111; 09/1989 →; 02J22650, 19307806 →; mit Zubehör	SK-1162AQ1	BTKW
1.5 DT	01/88-08/91	15 DT (T4EC1)	1499	25x136; mit Zubehör	SK-1054	BTK
1.6	09/84-08/91	16 SV	1598	17x111; 09/1986 →; 02J22350 →; mit Zubehör	SK-1162	BTK
1.6	09/84-08/91	16 SV	1598	17x111; 09/1986 →; 02J22350 →; mit Zubehör	SK-1162AQ1	BTKW
1.6 D	09/84-12/89	16 DA	1598	24x146	SK-1037	BTK
1.6 D	09/84-12/89	16 DA	1598	24x146; 14498631 →; hbf	SK-1037AQ1	BTKW
1.6 D	09/84-12/89	16 DA	1598	24x146; 14503757 →; hbf	SK-1037AQ1	BTKW
1.6 D	09/84-12/89	16 DA	1598	24x147; →14498630; hbf	SK-1056	BTK
1.6 D	09/84-12/89	16 DA	1598	24x147; →14503756; hbf	SK-1056	BTK
1.7 D	02/89-08/91	17 D	1699	24x146	SK-1037	BTK
1.7 D	02/89-08/91	17 D	1699	24x146; →14363650	SK-1037AQ1	BTKW
1.7 D	02/89-08/91	17 D	1699	24x176; 14363651 →	SK-1038	BTK
1.7 D	02/89-08/91	17 D	1699	24x176; 14363652 →	SK-1038AQ1	BTKW
1.8 i	01/90-08/91	18 E	1796	20x111; 14056061 →; →14270600	R-1072AQ1	BTKW
1.5 DT	01/88-08/91	15 DT (T4EC1)	1499		0-N878	TB [DG]
1.5 DT	01/88-08/91	15 DT (T4EC1)	1499		0-N879	TB [TE]
1.6 D	09/84-12/89	16 DA	1598	14478631, 14503757 →	0-N875	TB [DG]
1.7 D	02/89-08/91	17 D	1699		0-N875	TB [DG]
1.4 S	01/89-08/91	14 NV	1389	19307806 →	0-N948	TB [TE]
1.6	09/84-08/91	16 SV	1598	02122350 →	0-N948	TB [TE]

ASTRA Mk III (F)

1.4 i	04/92-09/98	C 14 NZ	1389	17x111; 09/1995 →; mit Zubehör	SK-1162	BTK
1.4 i	04/92-09/98	C 14 SE	1389	17x111; mit Zubehör; Baumuster: 57	SK-1162	BTK
1.4 i	04/92-09/98	C 14 NZ, C 14 SE	1389	17x111; mit Zubehör	SK-1162AQ1	BTKW
1.4 i 16V	02/96-09/98	X 14 XE	1389	20x169; mit Zubehör	SK-1073	BTK
1.4 i 16V	02/96-09/98	X 14 XE	1389	20x169; mit Zubehör	SK-1073AQ1	BTKW
1.6 i	03/92-09/98	X 16 SZR	1598	17x111; 09/1996 →; mit Zubehör; Baumuster: 56	SK-1162	BTK
1.6 i	03/92-09/98	C 16 NZ, X 16 SZR, C 16 SE, X 16 SZ	1598	17x111; mit Zubehör	SK-1162AQ1	BTKW
1.6 i	05/92-12/94	C 16 SE	1598	17x111; mit Zubehör; Baumuster: 57	SK-1162	BTK
1.6 i	08/94-07/96	X 16 SZ	1598	17x111; mit Zubehör	SK-1162	BTK
1.6 i 16V	08/94-09/98	X 16 XEL	1598	20x169; mit Zubehör	SK-1073	BTK
1.6 i 16V	08/94-09/98	X 16 XEL	1598	20x169; mit Zubehör	SK-1073AQ1	BTKW
1.7 D	03/92-09/92	17 D	1700	24x146	SK-1037	BTK
1.7 D	03/92-09/92	17 D	1700	24x146; →14363650	SK-1037AQ1	BTKW
1.7 D	03/92-09/98	17 D, 17 DR	1700	24x176; 14363651 →	SK-1038	BTK
1.7 D	07/92-09/98	17 DR	1700	24x146; →14363650	SK-1037	BTK
1.7 D	07/92-09/98	17 DR	1700	24x146; →14363651	SK-1037AQ1	BTKW
1.7 D, 1.7 TD	03/92-09/98	17 D, 17 DR, X 17 DTL	1700	24x176; 14363652 →	SK-1038AQ1	BTKW
1.7 TD	12/91-09/98	17 DT (TC4EE1)	1686	25.4x136; P4999999, R2599999, R5999999, R6599999, R8999999; mit Zubehör	SK-1164	BTK
1.7 TD	12/91-09/98	17 DT (TC4EE1)	1686	25x136; ch.S2500001, S5000001, SP000001 →; mit Zubehör	SK-1168	BTK

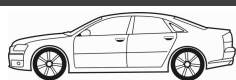

CM³



Art. Nr.



ohne Halter

ASTRA Mk III (F)							
1.7 TD	08/94-09/98	X 17 DTL	1700	24x176		SK-1038	BTK
1.8 i	03/92-09/98	C 18 NZ	1796	20x111; :14254438		R-1072AQ1	BTKW
1.8 i	03/92-09/98	C 18 NZ	1796	20x146; 01/1993 →; :14254439 →		SK-1169	BTK
1.8 i	03/92-09/98	C 18 NZ	1796	20x146; 01/1993 →; :14254439 →		SK-1169AQ1	BTKW
1.8 i 16V	06/93-10/94	C 18 XE	1799	24x169		SK-1100	BTK
1.8 i 16V	06/93-10/94	C 18 XE	1799	24x169		SK-1100AQ1	BTKW
1.8 i 16V	01/94-12/96	C 18 XEL	1796	24x169		SK-1100	BTK
1.8 i 16V	01/94-12/96	C 18 XEL	1796	24x169		SK-1100AQ1	BTKW
2.0 i	03/92-09/98	C 20 NE	1998	20x111; :14608700		R-1072AQ1	BTKW
2.0 i	03/92-09/98	C 20 NE	1998	20x146; 01/1993 →; :14608701 →		SK-1169	BTK
2.0 i	03/92-09/98	C 20 NE	1998	20x146; :14608701 →		SK-1169AQ1	BTKW
2.0 i 16V	02/95-09/98	X 20 XEV	1998	24x169		SK-1100	BTK
2.0 i 16V	02/95-09/98	X 20 XEV	1998	24x169		SK-1100AQ1	BTKW
1.4 i 16V	02/96-09/98	X 14 XE	1389			0-N102	TB [TE]
1.4 i 16V	02/96-09/98	X 14 XE	1389			0-N952	TB [DG]
1.4 i 16V	02/96-09/98	X 14 XE	1389			0-N953	TB [DG]
1.6 i 16V	08/94-09/98	X 16 XEL	1598			0-N102	TB [TE]
1.6 i 16V	08/94-09/98	X 16 XEL	1598			0-N952	TB [DG]
1.6 i 16V	08/94-09/98	X 16 XEL	1598			0-N953	TB [DG]
1.7 D	03/92-09/92	17 D	1700			0-N875	TB [DG]
1.7 D, 1.7 TD	07/92-09/98	17 DR, X 17 DTL	1700			0-N100	TB [TE]
1.7 D, 1.7 TD	07/92-09/98	17 DR, X 17 DTL	1700			0-N909	TB [DG]
1.7 TD	12/91-09/98	17 DT (TC4EE1)	1686	:855806 →		0-N126	TB [TE]
1.7 TD	12/91-09/98	17 DT (TC4EE1)	1686			0-N878	TB [DG]
1.7 TD	12/91-09/98	17 DT (TC4EE1)	1686	:→855805		0-N910	TB [TE]
1.8 i	03/92-09/98	C 18 NZ	1796	:14142839 →		0-N101	TB [TE]
1.8 i 16V	06/93-10/94	C 18 XE	1799			0-N100	TB [TE]
1.8 i 16V	06/93-10/94	C 18 XE	1799			0-N906	TB [DG]
1.8 i 16V	01/94-12/96	C 18 XEL	1796			0-N100	TB [TE]
1.8 i 16V	01/94-12/96	C 18 XEL	1796			0-N906	TB [DG]
2.0 i	03/92-09/98	C 20 NE	1998	:14608701 →		0-N101	TB [TE]
2.0 i 16V	02/95-09/98	X 20 XEV	1998			0-N100	TB [TE]
2.0 i 16V	02/95-09/98	X 20 XEV	1998			0-N906	TB [DG]
1.4 i	04/92-09/98	C 14 SE	1389			0-N948	TB [TE]
1.4 i	04/92-09/98	C 14 NZ	1389	:19311739 →		0-N948	TB [TE]
1.4 i, 1.4 i 16V	04/92-09/98	C 14 NZ, C 14 SE, X 14 XE	1389	Rippenanzahl: 6		0-N1439	VB [DG]
1.4 i, 1.4 i 16V	04/92-09/98	C 14 NZ, C 14 SE, X 14 XE	1389	für Fahrzeuge ohne Servolenkung		0-N1464	VB [BT] S
1.6 i	03/92-09/98	C 16 NZ, X 16 SZR	1598	:02122350 →		0-N948	TB [TE]
1.6 i	05/92-07/96	C 16 SE, X 16 SZ	1598			0-N948	TB [TE]
1.6 i, 1.6 i 16V	03/92-09/98	C 16 NZ, X 16 SZR, C 16 SE, X 16 SZ, X 16 XEL	1598	Rippenanzahl: 6		0-N1439	VB [DG]
1.6 i, 1.6 i 16V	03/92-09/98	C 16 NZ, X 16 SZR, C 16 SE, X 16 SZ, X 16 XEL	1598	für Fahrzeuge ohne Servolenkung		0-N1464	VB [BT] S
1.7 TD	12/91-09/98	17 DT (TC4EE1)	1686	Rippenanzahl: 6;		0-N1439	VB [DG]
ASTRA Mk III (F) CC							
1.4 i	09/91-02/98	C 14 NZ	1389	17x111; mit Zubehör		SK-1162	BTK
1.4 i	09/91-02/98	C 14 NZ	1389	17x111; mit Zubehör		SK-1162AQ1	BTKW
1.4 i	03/92-02/98	C 14 SE	1389	17x111; 09/1992 →; mit Zubehör		SK-1162	BTK
1.4 i	03/92-02/98	C 14 SE	1389	17x111; 09/1992 →; mit Zubehör		SK-1162AQ1	BTKW
1.4 i 16V	02/96-02/98	X 14 XE	1389	20x169; 09/1996 →; mit Zubehör		SK-1073	BTK
1.4 i 16V	02/96-02/98	X 14 XE	1389	20x169; mit Zubehör		SK-1073AQ1	BTKW
1.4 S	09/91-02/98	14 NV	1389	17x111; :02J22350, 19307806 →; mit Zubehör		SK-1162	BTK
1.4 S	09/91-02/98	14 NV	1389	17x111; :02J22350, 19307806 →; mit Zubehör		SK-1162AQ1	BTKW
1.6 i	09/91-02/98	C 16 NZ, E 16 NZ	1598	17x111; 09/1995 →; mit Zubehör; Baumuster: 53, 54, 58, 59		SK-1162	BTK
1.6 i	09/91-02/98	C 16 NZ, E 16 NZ, C 16 SE, X 16 SZ	1598	17x111; mit Zubehör		SK-1162AQ1	BTKW
1.6 i	03/92-02/98	C 16 SE, X 16 SZ	1598	17x111; mit Zubehör		SK-1162	BTK
1.6 i 16V	01/94-02/98	X 16 XEL	1598	20x169; mit Zubehör		SK-1073AQ1	BTKW
1.6 i, 1.6 i 16V	03/92-02/98	C 16 SE, X 16 XEL	1598	20x169; 09/1994 →; mit Zubehör		SK-1073	BTK
1.7 D	09/91-12/94	17 DR	1699	24x146; :14363650		SK-1037	BTK
1.7 D	09/91-02/98	17 D, 17 DR	1699	24x146; :→14363651		SK-1037AQ1	BTKW
1.7 D	09/91-02/98	17 D, 17 DR	1699	24x176; :14363651 →		SK-1038	BTK
1.7 D	09/91-02/98	17 D, 17 DR	1699	24x176; :14363652 →		SK-1038AQ1	BTKW
1.7 D	12/91-02/98	17 D	1699	24x146		SK-1037	BTK



OPTIMAL®

VAUXHALL



CM³



Art. Nr.



ohne Halter

ASTRA Mk III (F) CC

1.7 TD	12/91-02/98	17 DT (TC4EE1)	1686	25 4x136; P4999999, R2599999, R5999999, R6599999, R8999999; mit Zubehör	SK-1164	BTK	
1.7 TD	12/91-02/98	17 DT (TC4EE1)	1686	25x136; ch.S2500001, S5000001, SP000001→; mit Zubehör	SK-1168	BTK	
1.7 TD	08/94-02/98	X 17 DTL	1700	24x176	SK-1038	BTK	
1.7 TD	08/94-02/98	X 17 DTL	1700	24x176; :14363652→	SK-1038AQ1	BTKW	
1.8 i	09/91-02/98	C 18 NZ	1796	20x111; 05/1992 →; :→14254438	R-1072AQ1	BTKW	
1.8 i	09/91-02/98	C 18 NZ	1796	20x146; 01/1993 →; :14254439→	SK-1169	BTK	
1.8 i	09/91-02/98	C 18 NZ	1796	20x146; 01/1993 →; :14254439→	SK-1169AQ1	BTKW	
1.8 i 16V	09/94-02/98	C 18 XE, C 18 XEL	1796	24x169	SK-1100	BTK	
1.8 i 16V	09/94-02/98	C 18 XE, C 18 XEL	1796	24x169	SK-1100AQ1	BTKW	
2.0 i	09/91-02/98	C 20 NE	1998	20x111; :→14608700	R-1072AQ1	BTKW	
2.0 i	09/91-02/98	C 20 NE	1998	20x146; 01/1993 →; :14608701→	SK-1169	BTK	
2.0 i	09/91-02/98	C 20 NE	1998	20x146; :14608701→	SK-1169AQ1	BTKW	
2.0 i 16V	09/91-02/98	C 20 XE	1998	24x141	SK-1163	BTK	
2.0 i 16V	09/91-02/98	C 20 XE	1998	24x176; :14142839→	SK-1165	BTK	
2.0 i 16V	01/94-02/98	X 20 XEV	1998	24x169; 09/1996 →	SK-1100	BTK	
2.0 i 16V	01/94-02/98	X 20 XEV	1998	24x169; 09/1996 →	SK-1100AQ1	BTKW	
1.4 i 16V	02/96-02/98	X 14 XE	1389		0-N102	TB [TE]	
1.4 i 16V	02/96-02/98	X 14 XE	1389		0-N952	TB [DG]	
1.4 i 16V	02/96-02/98	X 14 XE	1389		0-N953	TB [DG]	
1.6 i 16V	01/94-02/98	X 16 XEL	1598		0-N102	TB [TE]	
1.6 i 16V	01/94-02/98	X 16 XEL	1598		0-N952	TB [DG]	
1.6 i 16V	01/94-02/98	X 16 XEL	1598		0-N953	TB [DG]	
1.7 D	09/91-12/94	17 DR	1699		0-N100	TB [TE]	
1.7 D	09/91-12/94	17 DR	1699		0-N909	TB [DG]	
1.7 D	12/91-02/98	17 D	1699		0-N875	TB [DG]	
1.7 TD	12/91-02/98	17 DT (TC4EE1)	1686	:855806→	0-N126	TB [TE]	
1.7 TD	12/91-02/98	17 DT (TC4EE1)	1686		0-N878	TB [DG]	
1.7 TD	12/91-02/98	17 DT (TC4EE1)	1686	:→855805	0-N910	TB [TE]	
1.7 TD	08/94-02/98	X 17 DTL	1700		0-N100	TB [TE]	
1.7 TD	08/94-02/98	X 17 DTL	1700		0-N909	TB [DG]	
1.8 i	09/91-02/98	C 18 NZ	1796	:14142839→	0-N101	TB [TE]	
1.8 i 16V	09/94-02/98	C 18 XE, C 18 XEL	1796		0-N100	TB [TE]	
1.8 i 16V	09/94-02/98	C 18 XE, C 18 XEL	1796		0-N906	TB [DG]	
2.0 i	09/91-02/98	C 20 NE	1998	:14608701→	0-N101	TB [TE]	
2.0 i 16V	09/91-02/98	C 20 XE	1998	:14142839→	0-N100	TB [TE]	
2.0 i 16V	09/91-02/98	C 20 XE	1998		0-N877	TB [TE]	
2.0 i 16V	09/91-02/98	C 20 XE	1998	:14142839→	0-N906	TB [DG]	
2.0 i 16V	09/91-02/98	C 20 XE	1998	:14142839→	0-N907	TB [DG]	
2.0 i 16V	01/94-02/98	X 20 XEV	1998		0-N100	TB [TE]	
2.0 i 16V	01/94-02/98	X 20 XEV	1998		0-N906	TB [DG]	
1.4 i	09/91-02/98	C 14 NZ	1389	:19311739→	0-N948	TB [TE]	
1.4 i	03/92-02/98	C 14 SE	1389		0-N948	TB [TE]	
1.4 i, 1.4 i 16V, 1.4 S	09/91-02/98	14 NV, C 14 NZ, C 14 SE, X 14 XE	1389	Rippenanzahl: 6	0-N1439	VB [DG]	
1.4 i, 1.4 i 16V, 1.4 S	09/91-02/98	14 NV, C 14 NZ, C 14 SE, X 14 XE	1389	für Fahrzeuge ohne Servolenkung	0-N1464	VB [BT]	S
1.4 S	09/91-02/98	14 NV	1389	:19307806→	0-N948	TB [TE]	
1.6 i	09/91-02/98	C 16 NZ, E 16 NZ	1598	:02122350→	0-N948	TB [TE]	
1.6 i	03/92-02/98	C 16 SE, X 16 SZ	1598		0-N948	TB [TE]	
1.6 i, 1.6 i 16V	09/91-02/98	C 16 NZ, E 16 NZ, C 16 SE, X 16 SZ, X 16 XEL	1598	Rippenanzahl: 6	0-N1439	VB [DG]	
1.6 i, 1.6 i 16V	09/91-02/98	C 16 NZ, E 16 NZ, C 16 SE, X 16 SZ, X 16 XEL	1598	für Fahrzeuge ohne Servolenkung	0-N1464	VB [BT]	S
1.7 TD	12/91-02/98	17 DT (TC4EE1)	1686	Rippenanzahl: 6;	0-N1439	VB [DG]	

ASTRA Mk III (F) Convertible

1.4	09/91-09/93	14 NV	1389	17x111; :02J22650, 19307806→; mit Zubehör	SK-1162	BTK	
1.4	09/91-09/93	14 NV	1389	17x111; :02J22650, 19307806→; mit Zubehör	SK-1162AQ1	BTKW	
1.4 i	05/93-02/98	C 14 NZ	1389	17x111; :19311738→; mit Zubehör	SK-1162	BTK	
1.4 i	05/93-03/01	C 14 SE	1389	17x111; mit Zubehör	SK-1162	BTK	
1.4 i	05/93-03/01	C 14 SE	1389	17x111; :→14254439; mit Zubehör	SK-1162AQ1	BTKW	
1.4 i 16V	01/96-03/01	X 14 XE	1389	20x169; mit Zubehör	SK-1073	BTK	
1.6 i	03/93-08/96	X 16 SZ	1598	17x111; 09/1994 →; mit Zubehör; Baumuster: 53	SK-1162	BTK	
1.6 i	03/93-08/96	X 16 SZ	1598	17x111; 09/1994 →; mit Zubehör	SK-1162AQ1	BTKW	

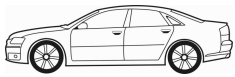

CM³



Art. Nr.



ASTRA Mk III (F) Convertible

1.6, 1.6 i	03/94-03/01	C 16 SE, X 16 SZR	1598	17x111; mit Zubehör; Baumuster: 53	SK-1162	BTK	
1.6, 1.6 i	03/94-03/01	C 16 SE, X 16 SZR	1598	17x111; mit Zubehör	SK-1162AQ1	BTKW	
1.8 i	05/93-02/98	C 18 NZ	1796	20x111; :→14254438	R-1072AQ1	BTKW	
1.8 i	05/93-02/98	C 18 NZ	1796	20x146; :14254439→	SK-1169	BTK	
1.8 i	05/93-02/98	C 18 NZ	1796	20x146; :14254439→	SK-1169AQ1	BTKW	
1.8, 1.8 16V	09/94-03/01	C 18 XE, C 18 XEL, X 18 XE	1799	24x169	SK-1100	BTK	
1.8, 1.8 16V	09/94-03/01	C 18 XE, C 18 XEL, X 18 XE	1799	24x169	SK-1100AQ1	BTKW	
2.0 i	03/93-10/94	C 20 NE	1998	20x111; 10/1993 →; :→14608700	R-1072AQ1	BTKW	
2.0 i	03/93-10/94	C 20 NE	1998	20x146; :14608701→	SK-1169	BTK	
2.0 i	03/93-10/94	C 20 NE	1998	20x146; :14608701→	SK-1169AQ1	BTKW	
2.0 i 16V	01/94-02/98	X 20 XEV	1998	24x169	SK-1100	BTK	
2.0 i 16V	01/94-02/98	X 20 XEV	1998	24x169	SK-1100AQ1	BTKW	
1.4 i 16V	01/96-03/01	X 14 XE	1389		0-N102	TB [TE]	
1.4 i 16V	01/96-03/01	X 14 XE	1389		0-N952	TB [DG]	
1.4 i 16V	01/96-03/01	X 14 XE	1389		0-N953	TB [DG]	
1.8 16V	11/94-03/01	C 18 XEL, X 18 XE	1799		0-N100	TB [TE]	
1.8 16V	11/94-03/01	C 18 XEL, X 18 XE	1799		0-N906	TB [DG]	
1.8 i	05/93-02/98	C 18 NZ	1796	:14142839→	0-N101	TB [TE]	
2.0 i	03/93-10/94	C 20 NE	1998	:14608701→	0-N101	TB [TE]	
1.4 i	05/93-03/01	C 14 SE	1389		0-N948	TB [TE]	
1.4 i, 1.4 i 16V	05/93-03/01	C 14 SE, X 14 XE	1389	für Fahrzeuge ohne Servolenkung	0-N1464	VB [BT]	S
1.4, 1.4 i, 1.4 i 16V	09/91-03/01	14 NV, C 14 NZ, C 14 SE, X 14 XE	1389	Rippenanzahl: 6	0-N1439	VB [DG]	
1.6 i	03/93-03/01	X 16 SZ, X 16 SZR	1598	für Fahrzeuge ohne Servolenkung	0-N1464	VB [BT]	S
1.6 i	03/93-03/01	X 16 SZ, X 16 SZR	1598		0-N948	TB [TE]	
1.6, 1.6 i	03/93-03/01	C 16 SE, X 16 SZ, X 16 SZR	1598	Rippenanzahl: 6	0-N1439	VB [DG]	

ASTRA Mk III (F) Estate

1.4 i	03/91-02/98	C 14 SE	1389	17x111; 09/1991 →; mit Zubehör; Baumuster: 52	SK-1162	BTK	
1.4 i	03/91-02/98	C 14 SE	1389	17x111; 09/1991 →; mit Zubehör	SK-1162AQ1	BTKW	
1.4 i	09/91-02/98	C 14 NZ	1389	17x111; mit Zubehör; Baumuster: 51	SK-1162	BTK	
1.4 i	09/91-02/98	C 14 NZ	1389	17x111; mit Zubehör	SK-1162AQ1	BTKW	
1.4 i 16V	02/96-01/98	X 14 XE	1389	20x169; 09/1996 →; mit Zubehör	SK-1073	BTK	
1.4 i 16V	02/96-01/98	X 14 XE	1389	20x169; mit Zubehör	SK-1073AQ1	BTKW	
1.4 S	09/91-02/98	14 NV	1389	17x111; :02J22350, 19307806→; mit Zubehör	SK-1162	BTK	
1.4 S	09/91-02/98	14 NV	1389	17x111; :02J22350, 19307806→; mit Zubehör	SK-1162AQ1	BTKW	
1.6 i	09/91-02/98	C 16 NZ, E 16 NZ	1598	17x111; 09/1996 →; mit Zubehör	SK-1162	BTK	
1.6 i	09/91-02/98	C 16 NZ, E 16 NZ	1598	17x111; mit Zubehör	SK-1162AQ1	BTKW	
1.6 i	07/94-02/98	X 16 SZ	1598	17x111; 09/1995 →; mit Zubehör	SK-1162	BTK	
1.6 i	07/94-02/98	X 16 SZ	1598	17x111; 09/1995 →; mit Zubehör	SK-1162AQ1	BTKW	
1.6 i 16V	01/94-02/98	X 16 XEL	1598	20x169; 09/1994 →; mit Zubehör	SK-1073	BTK	
1.6 i 16V	01/94-02/98	X 16 XEL	1598	20x169; mit Zubehör	SK-1073AQ1	BTKW	
1.6 Si	03/91-12/94	C 16 SE	1598	17x111; 09/1991 →; mit Zubehör; Baumuster: 52	SK-1162	BTK	
1.6 Si	03/91-12/94	C 16 SE	1598	17x111; 09/1991 →; mit Zubehör	SK-1162AQ1	BTKW	
1.7 D	03/91-12/94	17 DR	1699	24x146; 09/1991 →; :→14363650	SK-1037	BTK	
1.7 D	03/91-12/94	17 DR	1699	24x146; 09/1991 →; :→14363651	SK-1037AQ1	BTKW	
1.7 D	03/91-12/94	17 DR	1699	24x176; 09/1991 →; :14363651→	SK-1038	BTK	
1.7 D	03/91-02/98	17 D, 17 DR	1699	24x176; :14363652→	SK-1038AQ1	BTKW	
1.7 D	12/91-02/98	17 D	1699	24x146	SK-1037	BTK	
1.7 D	12/91-02/98	17 D	1699	24x146; :→14363651	SK-1037AQ1	BTKW	
1.7 D	12/91-02/98	17 D	1699	24x176; :14363651→	SK-1038	BTK	
1.7 TD	12/91-02/98	17 DT (TC4EE1)	1686	25.4x136; P4999999, R2599999, R5999999, R6599999, R8999999; mit Zubehör	SK-1164	BTK	
1.7 TD	12/91-02/98	17 DT (TC4EE1)	1686	25x136; ch.S2500001, S5000001, SP000001→; mit Zubehör	SK-1168	BTK	
1.7 TD	01/94-02/98	X 17 DTL	1700	24x176; 09/1994 →	SK-1038	BTK	
1.7 TD	01/94-02/98	X 17 DTL	1700	24x176; :14363652→	SK-1038AQ1	BTKW	
1.8 i	09/91-02/98	C 18 NZ	1796	20x111; 05/1992 →; :→14254438	R-1072AQ1	BTKW	
1.8 i	09/91-02/98	C 18 NZ	1796	20x146; 01/1993 →; :14254439→	SK-1169	BTK	
1.8 i	09/91-02/98	C 18 NZ	1796	20x146; 01/1993 →; :14254439→	SK-1169AQ1	BTKW	
1.8 i 16V	09/94-02/98	C 18 XE, C 18 XEL, X 18 XE	1796	24x169	SK-1100	BTK	
1.8 i 16V	09/94-02/98	C 18 XE, C 18 XEL, X 18 XE	1796	24x169	SK-1100AQ1	BTKW	
2.0 i	09/91-02/98	C 20 NE	1998	20x111; :→14608700	R-1072AQ1	BTKW	
2.0 i	09/91-02/98	C 20 NE	1998	20x146; 01/1993 →; :14608701→	SK-1169	BTK	



CM³



Art. Nr.



ASTRA Mk III (F) Estate

2.0 i	09/91-02/98	C 20 NE	1998	20x146; :14608701→	SK-1169AQ1	BTKW	
2.0 i 16V	01/94-02/98	X 20 XEV	1998	24x169; 09/1995 →	SK-1100	BTK	
2.0 i 16V	01/94-02/98	X 20 XEV	1998	24x169; 09/1995 →	SK-1100AQ1	BTKW	
1.4 i 16V	02/96-01/98	X 14 XE	1389		0-N102	TB [TE]	
1.4 i 16V	02/96-01/98	X 14 XE	1389		0-N952	TB [DG]	
1.4 i 16V	02/96-01/98	X 14 XE	1389		0-N953	TB [DG]	
1.6 i 16V	01/94-02/98	X 16 XEL	1598		0-N102	TB [TE]	
1.6 i 16V	01/94-02/98	X 16 XEL	1598		0-N952	TB [DG]	
1.6 i 16V	01/94-02/98	X 16 XEL	1598		0-N953	TB [DG]	
1.7 D	03/91-12/94	17 DR	1699		0-N100	TB [TE]	
1.7 D	03/91-12/94	17 DR	1699		0-N909	TB [DG]	
1.7 D	12/91-02/98	17 D	1699		0-N875	TB [DG]	
1.7 TD	12/91-02/98	17 DT (TC4EE1)	1686	:855806→	0-N126	TB [TE]	
1.7 TD	12/91-02/98	17 DT (TC4EE1)	1686		0-N878	TB [DG]	
1.7 TD	12/91-02/98	17 DT (TC4EE1)	1686	:→855805	0-N910	TB [TE]	
1.7 TD	01/94-02/98	X 17 DTL	1700		0-N100	TB [TE]	
1.7 TD	01/94-02/98	X 17 DTL	1700		0-N909	TB [DG]	
1.8 i	09/91-02/98	C 18 NZ	1796	:14142839→	0-N101	TB [TE]	
1.8 i 16V	09/94-02/98	C 18 XE, C 18 XEL, X 18 XE	1796		0-N100	TB [TE]	
1.8 i 16V	09/94-02/98	C 18 XE, C 18 XEL, X 18 XE	1796		0-N906	TB [DG]	
2.0 i	09/91-02/98	C 20 NE	1998	:14608701→	0-N101	TB [TE]	
2.0 i 16V	01/94-02/98	X 20 XEV	1998		0-N100	TB [TE]	
2.0 i 16V	01/94-02/98	X 20 XEV	1998		0-N906	TB [DG]	
1.4 i	03/91-02/98	C 14 SE	1389		0-N948	TB [TE]	
1.4 i	09/91-02/98	C 14 NZ	1389	:19311739→	0-N948	TB [TE]	
1.4 i, 1.4 i 16V, 1.4 S	03/91-02/98	14 NV, C 14 NZ, C 14 SE, X 14 XE	1389	Rippenanzahl: 6	0-N1439	VB [DG]	
1.4 i, 1.4 i 16V, 1.4 S	03/91-02/98	14 NV, C 14 NZ, C 14 SE, X 14 XE	1389	für Fahrzeuge ohne Servolenkung	0-N1464	VB [BT]	S
1.4 S	09/91-02/98	14 NV	1389	:19307806→	0-N948	TB [TE]	
1.6 i	09/91-02/98	C 16 NZ, E 16 NZ	1598	:02122350→	0-N948	TB [TE]	
1.6 i, 1.6 i 16V, 1.6 Si	03/91-02/98	C 16 NZ, E 16 NZ, C 16 SE, X 16 SZ, X 16 XEL	1598	Rippenanzahl: 6	0-N1439	VB [DG]	
1.6 i, 1.6 i 16V, 1.6 Si	03/91-02/98	C 16 NZ, E 16 NZ, C 16 SE, X 16 SZ, X 16 XEL	1598	für Fahrzeuge ohne Servolenkung	0-N1464	VB [BT]	S
1.6 i, 1.6 Si	03/91-02/98	C 16 SE, X 16 SZ	1598		0-N948	TB [TE]	
1.7 TD	12/91-02/98	17 DT (TC4EE1)	1686	Rippenanzahl: 6;	0-N1439	VB [DG]	

ASTRA Mk IV (G) CC

1.4 16V	02/98-05/05	X 14 XE, Z 14 XE	1389	20x162; :→02HL5117, 20041690; mit Zubehör	SK-1113	BTK	
1.4 16V	02/98-05/05	X 14 XE, Z 14 XE	1389	20x162; :→02HL5117, 20041690; mit Zubehör	SK-1113AQ1	BTKW	
1.4 16V	02/98-05/05	X 14 XE, Z 14 XE	1389	20x162; :02HL5118, 20041691→; mit Zubehör	SK-1355	BTK	
1.4 16V	02/98-05/05	X 14 XE, Z 14 XE	1389	20x162; :02MV7225, 20U75999→; mit Zubehör	SK-1355AQ2	BTKW	
1.4 16V	02/98-05/05	X 14 XE, Z 14 XE	1389	20x162; :02HL5118, 20041691→; :→02MV7224	SK-1355AQ3	BTKW	
1.6	09/00-05/05	Z 16 SE	1598	17x111; :02MZ5254, 20U75999→	SK-1162AQ2	BTKW	
1.6 16V, 1.6 Dualfuel	02/98-05/05	X 16 XEL, Z 16 XE, Z 16 XE	1598	20x162; :→02HL5117, 20041690; mit Zubehör	SK-1113	BTK	
1.6 16V, 1.6 Dualfuel	02/98-05/05	X 16 XEL, Z 16 XE, Z 16 XE	1598	20x162; :→02HL5117, 20041690; mit Zubehör	SK-1113AQ1	BTKW	
1.6 16V, 1.6 Dualfuel	02/98-05/05	X 16 XEL, Z 16 XE, Z 16 XE	1598	20x162; :02HL5118, 20041691→; mit Zubehör	SK-1355	BTK	
1.6 16V, 1.6 Dualfuel	02/98-05/05	X 16 XEL, Z 16 XE, Z 16 XE	1598	20x162; :02MV7225, 20U75999→; mit Zubehör	SK-1355AQ2	BTKW	
1.6 16V, 1.6 Dualfuel	02/98-05/05	X 16 XEL, Z 16 XE, Z 16 XE	1598	20x162; :02HL5118, 20041691→; :→02MV7224	SK-1355AQ3	BTKW	
1.6, 1.6 Dualfuel	02/98-05/05	X 16 SZR, Z 16 SE	1598	17x111; mit Zubehör	SK-1162	BTK	
1.6, 1.6 Dualfuel	02/98-05/05	X 16 SZR, Z 16 SE	1598	17x111; mit Zubehör	SK-1162AQ1	BTKW	
1.7 CDTI 16V	04/03-05/05	Z 17 DTL	1686	25x129; mit Zubehör	SK-1612	BTK	
1.7 DTI 16V	02/00-05/05	Y 17 DT	1686	25x131; 09/2000 →; mit Zubehör	SK-1479	BTK	
1.7 DTI 16V	02/00-05/05	Y 17 DT	1686	25x131; 09/2000 →; :328704→; mit Zubehör	SK-1481	BTK	
1.7 DTI 16V	02/00-05/05	Y 17 DT	1686	25x131; 09/2000 →; :→328703	SK-1689	BTK	
1.7 TD	02/98-08/00	X 17 DTL	1700	24x176	SK-1038	BTK	
1.7 TD	02/98-08/00	X 17 DTL	1700	24x176	SK-1038AQ1	BTKW	
1.8 16V, 1.8 16V Dualfuel	02/98-05/05	X 18 XE1, Z 18 XE	1796	20x162; :→02HL5117, 20041690; mit Zubehör	SK-1113	BTK	

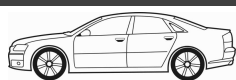

CM³



Art. Nr.



ASTRA Mk IV (G) CC							
1.8 16V, 1.8 16V Dualfuel	02/98-05/05	X 18 XE1, Z 18 XE	1796	20x162; :→02HL5117, 20041690; mit Zubehör	SK-1113AQ2	BTKW	
1.8 16V, 1.8 16V Dualfuel	02/98-05/05	X 18 XE1, Z 18 XE	1796	20x162; :02HL5118, 20041691→; mit Zubehör	SK-1355	BTK	
1.8 16V, 1.8 16V Dualfuel	02/98-05/05	X 18 XE1, Z 18 XE	1796	20x162; :02HL5118, 20041691→; mit Zubehör	SK-1355AQ1	BTKW	
2.0	10/99-08/00	X 20 XER	1998	24x168	SK-1632	BTK	
2.0	10/99-08/00	X 20 XER	1998	24x168	SK-1632AQ1	BTKW	
2.0 16V	02/98-05/05	X 20 XEV	1998	24x168	SK-1478	BTK	
2.0 16V	02/98-05/05	X 20 XEV	1998	24x168	SK-1478AQ1	BTKW	
2.0 SRI Turbo	11/01-05/05	Z 20 LET	1998	24x168; ch.→32999999, 35999999	SK-1632	BTK	
2.0 SRI Turbo	11/01-05/05	Z 20 LET	1998	24x168; ch.→36999999, 38999999	SK-1632	BTK	
2.0 SRI Turbo	11/01-05/05	Z 20 LET	1998	24x168; ch.→3B999999, 3H999999	SK-1632	BTK	
2.0 SRI Turbo	11/01-05/05	Z 20 LET	1998	24x168; ch.→32999999, 35999999, 36999999, 38999999, 3B999999, 3G999999, 3H999999	SK-1632AQ1	BTKW	
2.0 SRI Turbo	11/01-05/05	Z 20 LET	1998	24x168; ch.42000001, 45000001, 48000001, 4B000001, 4G000001, 4H000001→	SK-1667	BTK	
2.0 SRI Turbo	11/01-05/05	Z 20 LET	1998	24x168; ch.42000001, 45000001, 48000001, 4B000001, 4G000001, 4H000001→	SK-1667AQ1	BTKW	
1.4 16V	02/98-05/05	X 14 XE, Z 14 XE	1389		0-N102	TB [TE]	
1.4 16V	02/98-05/05	X 14 XE, Z 14 XE	1389	:02HL5118, 20041691→; ; mit Anbaumaterial	0-N300	TB [DG]	
1.4 16V	02/98-05/05	X 14 XE, Z 14 XE	1389	:→02HL5117, 20041690	0-N952	TB [DG]	
1.4 16V	02/98-05/05	X 14 XE, Z 14 XE	1389		0-N953	TB [DG]	
1.6	12/02-05/05	Z 16 XEP	1598		0-N1347	TB [TE]	
1.6 16V, 1.6 Dualfuel	02/98-05/05	X 16 XEL, Z 16 XE, Z 16 XE	1598		0-N102	TB [TE]	
1.6 16V, 1.6 Dualfuel	02/98-05/05	X 16 XEL, Z 16 XE, Z 16 XE	1598	:02HL5118, 20041691→; ; mit Anbaumaterial	0-N300	TB [DG]	
1.6 16V, 1.6 Dualfuel	02/98-05/05	X 16 XEL, Z 16 XE, Z 16 XE	1598	:→02HL5117, 20041690	0-N952	TB [DG]	
1.6 16V, 1.6 Dualfuel	02/98-05/05	X 16 XEL, Z 16 XE, Z 16 XE	1598		0-N953	TB [DG]	
1.7 CDTI 16V	04/03-05/05	Z 17 DTL	1686		0-N1085	TB [TE]	
1.7 CDTI 16V, 1.7 DTI 16V	02/00-05/05	Y 17 DT, Z 17 DTL	1686		0-N878	TB [DG]	
1.7 DTI 16V	02/00-05/05	Y 17 DT	1686	:0328705→	0-N1085	TB [TE]	
1.7 TD	02/98-08/00	X 17 DTL	1700		0-N100	TB [TE]	
1.7 TD	02/98-08/00	X 17 DTL	1700		0-N909	TB [DG]	
1.8 16V, 1.8 16V Dualfuel	02/98-05/05	X 18 XE1, Z 18 XE	1796		0-N102	TB [TE]	
1.8 16V, 1.8 16V Dualfuel	02/98-05/05	X 18 XE1, Z 18 XE	1796	:02HL5118, 20041691→; ; mit Anbaumaterial	0-N300	TB [DG]	
1.8 16V, 1.8 16V Dualfuel	02/98-05/05	X 18 XE1, Z 18 XE	1796	:→02HL5117, 20041690	0-N952	TB [DG]	
1.8 16V, 1.8 16V Dualfuel	02/98-05/05	X 18 XE1, Z 18 XE	1796		0-N953	TB [DG]	
2.0 16V	02/98-05/05	X 20 XEV	1998		0-N100	TB [TE]	
2.0 SRI Turbo	11/01-05/05	Z 20 LET	1998	→ 12/2003	0-N127	TB [DG]	
2.0 SRI Turbo	11/01-05/05	Z 20 LET	1998	01/2004 →	0-N127	TB [DG]	
2.0 SRI Turbo	11/01-05/05	Z 20 LET	1998	01/2004 →	0-N1574	TB [DG]	
2.0, 2.0 16V	02/98-05/05	X 20 XER, X 20 XEV	1998		0-N127	TB [DG]	
2.0, 2.0 SRI Turbo	10/99-05/05	X 20 XER, Z 20 LET	1998		0-N1369	TB [TE]	
1.2 16V	02/98-05/05	X 12 XE, Z 12 XE	1199		0-N2170	VB [BT]	S
1.4 16V	02/98-05/05	X 14 XE, Z 14 XE	1389		0-N1466	VB [BT]	S
1.6	02/98-09/00	X 16 SZR	1598	Rippenanzahl: 6	0-N1439	VB [DG]	
1.6	02/98-05/05	X 16 SZR, Z 16 SE	1598		0-N948	TB [TE]	
1.6, 1.6 16V, 1.6 Dualfuel	02/98-05/05	X 16 SZR, X 16 XEL, Z 16 XE, Z 16 SE, Z 16 XE	1598		0-N1466	VB [BT]	S
1.8 16V, 1.8 16V Dualfuel	02/98-05/05	X 18 XE1, Z 18 XE	1796		0-N1466	VB [BT]	S
2.0 DI, 2.0 DTI 16V	02/98-05/05	X 20 DTH, Y 20 DTH, X 20 DTL, Y 20 DTL	1995	Rippenanzahl: 6	0-N1437	VB [DG]	
2.0 DI, 2.0 DTI 16V	02/98-05/05	X 20 DTH, Y 20 DTH, X 20 DTL, Y 20 DTL	1995		0-N1485	VB [BT]	S
2.0 DI, 2.0 DTI 16V	02/98-05/05	X 20 DTH, Y 20 DTH, X 20 DTL, Y 20 DTL	1995		0-N2169	VB [VD]	
2.2 16V	03/01-05/05	Z 22 SE	2198		0-N1588	VB [BT]	S

ASTRA Mk IV (G) Convertible							
1.6 16V	03/01-10/05	Z 16 XE	1598	20x162; :→02HL5117, 20041690; mit Zubehör	SK-1113	BTK	
1.6 16V	03/01-10/05	Z 16 XE	1598	20x162; :→02HL5117, 20041690; mit Zubehör	SK-1113AQ1	BTKW	
1.6 16V	03/01-10/05	Z 16 XE	1598	20x162; :02HL5118, 20041691→; mit Zubehör	SK-1355	BTK	
1.6 16V	03/01-10/05	Z 16 XE	1598	20x162; :02MV7225, 20U75999→; mit Zubehör	SK-1355AQ2	BTKW	

CM³

Art. Nr.



ASTRA Mk IV (G) Convertible

1.6 16V	03/01-10/05	Z 16 XE	1598	20x162; :02HL5118, 20041691→; :→02MV7224	SK-1355AQ3	BTKW	
1.6 16V	03/03-10/05	Z 16 XEP	1598	24x146; 04/2004 →	SK-1607	BTK	
1.8 16V	03/01-10/05	Z 18 XE	1796	20x162; :→02HL5117, 20041690; mit Zubehör	SK-1113	BTK	
1.8 16V	03/01-10/05	Z 18 XE	1796	20x162; :→02HL5117, 20041690; mit Zubehör	SK-1113AQ2	BTKW	
1.8 16V	03/01-10/05	Z 18 XE	1796	20x162; :02HL5118, 20041691→; mit Zubehör	SK-1355	BTK	
1.8 16V	03/01-10/05	Z 18 XE	1796	20x162; :02HL5118, 20041691→; mit Zubehör	SK-1355AQ1	BTKW	
2.0, 2.0 Turbo	03/02-10/05	Z 20 LET	1998	24x168; ch.→32999999, 35999999	SK-1632	BTK	
2.0, 2.0 Turbo	03/02-10/05	Z 20 LET	1998	24x168; ch.→36999999, 38999999	SK-1632	BTK	
2.0, 2.0 Turbo	03/02-10/05	Z 20 LET	1998	24x168; ch.→3B999999, 3H999999	SK-1632	BTK	
2.0, 2.0 Turbo	03/02-10/05	Z 20 LET	1998	24x168; ch.→32999999, 35999999, 36999999, 38999999, 3B999999, 3G999999, 3H999999	SK-1632AQ1	BTKW	
2.0, 2.0 Turbo	03/02-10/05	Z 20 LET	1998	24x168; ch.42000001, 45000001, 48000001, 4B000001, 4G000001, 4H000001→	SK-1667	BTK	
2.0, 2.0 Turbo	03/02-10/05	Z 20 LET	1998	24x168; ch.42000001, 45000001, 48000001, 4B000001, 4G000001, 4H000001→	SK-1667AQ1	BTKW	
1.6 16V	03/01-10/05	Z 16 XE	1598		0-N102	TB [TE]	
1.6 16V	03/01-10/05	Z 16 XE	1598	:02HL5118, 20041691→; ; mit Anbaumaterial	0-N300	TB [DG]	
1.6 16V	03/01-10/05	Z 16 XE	1598	:→02HL5117, 20041690	0-N952	TB [DG]	
1.6 16V	03/01-10/05	Z 16 XE	1598		0-N953	TB [DG]	
1.6 16V	03/03-10/05	Z 16 XEP	1598		0-N1347	TB [TE]	
1.8 16V	03/01-10/05	Z 18 XE	1796		0-N102	TB [TE]	
1.8 16V	03/01-10/05	Z 18 XE	1796	:02HL5118, 20041691→; ; mit Anbaumaterial	0-N300	TB [DG]	
1.8 16V	03/01-10/05	Z 18 XE	1796	:→02HL5117, 20041690	0-N952	TB [DG]	
1.8 16V	03/01-10/05	Z 18 XE	1796		0-N953	TB [DG]	
2.0 Turbo	03/02-10/05	Z 20 LET	1998	→ 12/2003	0-N127	TB [DG]	
2.0 Turbo	03/02-10/05	Z 20 LET	1998	01/2004 →	0-N127	TB [DG]	
2.0 Turbo	03/02-10/05	Z 20 LET	1998		0-N1369	TB [TE]	
2.0 Turbo	03/02-10/05	Z 20 LET	1998	01/2004 →	0-N1574	TB [DG]	
1.6 16V	03/01-10/05	Z 16 XE	1598		0-N1466	VB [BT]	S
1.8 16V	03/01-10/05	Z 18 XE	1796		0-N1466	VB [BT]	S
2.2 16V	03/01-10/05	Z 22 SE	2198		0-N1588	VB [BT]	S

ASTRA Mk IV (G) Coupe (F67)

1.6 16V	03/00-08/05	Z 16 XEP	1598	20x162; :→02HL5117, 20041690; mit Zubehör	SK-1113	BTK	
1.6 16V	03/00-08/05	Z 16 XEP	1598	20x162; :02HL5118, 20041691→; mit Zubehör	SK-1355	BTK	
1.6 16V	03/00-08/05	Z 16 XEP	1598	20x162; :02MV7225, 20U75999→; mit Zubehör	SK-1355AQ2	BTKW	
1.6 16V	03/00-08/05	Z 16 XEP	1598	20x162; :02HL5118, 20041691→; :→02MV7224, 20U75998	SK-1355AQ3	BTKW	
1.8 16V	03/00-08/05	X 18 XE1, Z 18 XEL, Z 18 XE	1796	20x162; :02HL5118, 20041691→; mit Zubehör	SK-1355AQ1	BTKW	
1.8 16V Dualfuel	09/02-08/05	Z 18 XE	1796	20x162; → 05/2005; :02HL5118, 20041691→; mit Zubehör	SK-1355AQ1	BTKW	
1.8 16V, 1.8 16V Dualfuel	03/00-08/05	X 18 XE1, Z 18 XEL, Z 18 XE	1796	20x162; :→02HL5117, 20041690; mit Zubehör	SK-1113	BTK	
1.8 16V, 1.8 16V Dualfuel	03/00-08/05	X 18 XE1, Z 18 XEL, Z 18 XE	1796	20x162; :→02HL5117, 20041690; mit Zubehör	SK-1113AQ2	BTKW	
1.8 16V, 1.8 16V Dualfuel	03/00-08/05	X 18 XE1, Z 18 XEL, Z 18 XE	1796	20x162; :02HL5118, 20041691→; mit Zubehör	SK-1355	BTK	
2.0, 2.0 16V Turbo	09/00-08/05	Z 20 LET	1998	24x168; ch.→32999999, 35999999	SK-1632	BTK	
2.0, 2.0 16V Turbo	09/00-08/05	Z 20 LET	1998	24x168; ch.→36999999, 38999999	SK-1632	BTK	
2.0, 2.0 16V Turbo	09/00-08/05	Z 20 LET	1998	24x168; ch.→3B999999, 3H999999	SK-1632	BTK	
2.0, 2.0 16V Turbo	09/00-08/05	Z 20 LET	1998	24x168; ch.→32999999, 35999999, 36999999, 38999999, 3B999999, 3G999999, 3H999999	SK-1632AQ1	BTKW	
2.0, 2.0 16V Turbo	09/00-08/05	Z 20 LET	1998	24x168; ch.42000001, 45000001, 48000001, 4B000001, 4G000001, 4H000001→	SK-1667	BTK	
2.0, 2.0 16V Turbo	09/00-08/05	Z 20 LET	1998	24x168; ch.42000001, 45000001, 48000001, 4B000001, 4G000001, 4H000001→	SK-1667AQ1	BTKW	

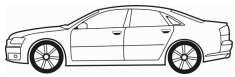

CM³



Art. Nr.



ASTRA Mk IV (G) Coupe (F67)

1.6 16V	03/00-08/05	Z 16 XEP	1598		0-N1347	TB [TE]	
1.8 16V, 1.8 16V Dualfuel	03/00-08/05	X 18 XE1, Z 18 XEL, Z 18 XE	1796		0-N102	TB [TE]	
1.8 16V, 1.8 16V Dualfuel	03/00-08/05	X 18 XE1, Z 18 XEL, Z 18 XE	1796	:02HL5118, 20041691→; ; mit Anbaumaterial	0-N300	TB [DG]	
1.8 16V, 1.8 16V Dualfuel	03/00-08/05	X 18 XE1, Z 18 XEL, Z 18 XE	1796	:→02HL5117, 20041690	0-N952	TB [DG]	
1.8 16V, 1.8 16V Dualfuel	03/00-08/05	X 18 XE1, Z 18 XEL, Z 18 XE	1796		0-N953	TB [DG]	
2.0 16V Turbo	09/00-08/05	Z 20 LET	1998	→ 12/2003	0-N127	TB [DG]	
2.0 16V Turbo	09/00-08/05	Z 20 LET	1998	01/2004 →	0-N127	TB [DG]	
2.0 16V Turbo	09/00-08/05	Z 20 LET	1998		0-N1369	TB [TE]	
2.0 16V Turbo	09/00-08/05	Z 20 LET	1998	01/2004 →	0-N1574	TB [DG]	
1.8 16V, 1.8 16V Dualfuel	03/00-08/05	X 18 XE1, Z 18 XEL, Z 18 XE	1796		0-N1466	VB [BT]	S
2.2 16V	03/00-08/05	Z 22 SE	2198		0-N1588	VB [BT]	S

ASTRA Mk IV (G) Estate

1.4 16V	02/98-05/05	X 14 XE, Z 14 XE	1389	20x162; :→02HL5117, 20041690; mit Zubehör	SK-1113	BTK	
1.4 16V	02/98-05/05	X 14 XE, Z 14 XE	1389	20x162; :→02HL5117, 20041690; mit Zubehör	SK-1113AQ1	BTKW	
1.4 16V	02/98-05/05	X 14 XE, Z 14 XE	1389	20x162; :02HL5118, 20041691→; mit Zubehör	SK-1355	BTK	
1.4 16V	02/98-05/05	X 14 XE, Z 14 XE	1389	20x162; :02MV7225, 20U75999→; mit Zubehör	SK-1355AQ2	BTKW	
1.4 16V	02/98-05/05	X 14 XE, Z 14 XE	1389	20x162; :02HL5118, 20041691→; :→02MV7224	SK-1355AQ3	BTKW	
1.6	03/98-04/04	Z 16 SE	1598	17x111; 09/2000 →; mit Zubehör	SK-1162	BTK	
1.6	03/98-04/04	Z 16 SE	1598	17x111; 09/2000 →; mit Zubehör	SK-1162AQ1	BTKW	
1.6	03/98-04/04	Z 16 SE	1598	17x111; :02MZ5254, 20U75999→	SK-1162AQ2	BTKW	
1.6	12/02-05/05	Z 16 XEP	1598	24x146	SK-1607	BTK	
1.6 16V	03/98-04/04	X 16 XEL, Z 16 XE	1598	20x162; :→02HL5117, 20041690; mit Zubehör	SK-1113	BTK	
1.6 16V, 1.6 Dualfuel	03/98-04/04	X 16 XEL, Z 16 XE, Z 16 XE	1598	20x162; :→02HL5117, 20041690; mit Zubehör	SK-1113AQ1	BTKW	
1.6 16V, 1.6 Dualfuel	03/98-04/04	X 16 XEL, Z 16 XE, Z 16 XE	1598	20x162; :02HL5118, 20041691→; mit Zubehör	SK-1355	BTK	
1.6 16V, 1.6 Dualfuel	03/98-04/04	X 16 XEL, Z 16 XE, Z 16 XE	1598	20x162; :02MV7225, 20U75999→; mit Zubehör	SK-1355AQ2	BTKW	
1.6 16V, 1.6 Dualfuel	03/98-04/04	X 16 XEL, Z 16 XE, Z 16 XE	1598	20x162; :02HL5118, 20041691→; :→02MV7224	SK-1355AQ3	BTKW	
1.6 Dualfuel	03/98-04/04	Z 16 XE	1598	20x162; 08/2002 →; :→02HL5117, 20041690; mit Zubehör	SK-1113	BTK	
1.6, 1.6 Dualfuel	03/98-05/05	X 16 SZR, Z 16 SE	1598	17x111; mit Zubehör	SK-1162	BTK	
1.6, 1.6 Dualfuel	03/98-05/05	X 16 SZR, Z 16 SE	1598	17x111; mit Zubehör	SK-1162AQ1	BTKW	
1.7 CDTI 16V	04/03-05/05	Z 17 DTL	1686	25x129; mit Zubehör	SK-1612	BTK	
1.7 DTI 16V	02/00-05/05	Y 17 DT	1686	25x131; 09/2000 →; mit Zubehör	SK-1479	BTK	
1.7 DTI 16V	02/00-05/05	Y 17 DT	1686	25x131; 09/2000 →; :328704→; mit Zubehör	SK-1481	BTK	
1.7 DTI 16V	02/00-05/05	Y 17 DT	1686	25x131; 09/2000 →; :→328703	SK-1689	BTK	
1.7 TD	02/98-08/00	X 17 DTL	1700	24x176	SK-1038	BTK	
1.7 TD	02/98-08/00	X 17 DTL	1700	24x176	SK-1038AQ1	BTKW	
1.8 16V, 1.8 16V Dualfuel	02/98-05/05	X 18 XE1, Z 18 XE	1796	20x162; :→02HL5117, 20041690; mit Zubehör	SK-1113	BTK	
1.8 16V, 1.8 16V Dualfuel	02/98-05/05	X 18 XE1, Z 18 XE	1796	20x162; :→02HL5117, 20041690; mit Zubehör	SK-1113AQ2	BTKW	
1.8 16V, 1.8 16V Dualfuel	02/98-05/05	X 18 XE1, Z 18 XE	1796	20x162; :02HL5118, 20041691→; mit Zubehör	SK-1355	BTK	
1.8 16V, 1.8 16V Dualfuel	02/98-05/05	X 18 XE1, Z 18 XE	1796	20x162; :02HL5118, 20041691→; mit Zubehör	SK-1355AQ1	BTKW	
2.0 16V	10/99-05/05	X 20 XER	1998	24x168	SK-1632	BTK	
2.0 16V	10/99-05/05	X 20 XER	1998	24x168	SK-1632AQ1	BTKW	
1.4 16V	02/98-05/05	X 14 XE, Z 14 XE	1389		0-N102	TB [TE]	
1.4 16V	02/98-05/05	X 14 XE, Z 14 XE	1389	:02HL5118, 20041691→; ; mit Anbaumaterial	0-N300	TB [DG]	
1.4 16V	02/98-05/05	X 14 XE, Z 14 XE	1389	:→02HL5117, 20041690	0-N952	TB [DG]	
1.4 16V	02/98-05/05	X 14 XE, Z 14 XE	1389		0-N953	TB [DG]	
1.6	12/02-05/05	Z 16 XEP	1598		0-N1347	TB [TE]	
1.6 16V, 1.6 Dualfuel	03/98-04/04	X 16 XEL, Z 16 XE, Z 16 XE	1598		0-N102	TB [TE]	
1.6 16V, 1.6 Dualfuel	03/98-04/04	X 16 XEL, Z 16 XE, Z 16 XE	1598	:02HL5118, 20041691→; ; mit Anbaumaterial	0-N300	TB [DG]	
1.6 16V, 1.6 Dualfuel	03/98-04/04	X 16 XEL, Z 16 XE, Z 16 XE	1598	:→02HL5117, 20041690	0-N952	TB [DG]	
1.6 16V, 1.6 Dualfuel	03/98-04/04	X 16 XEL, Z 16 XE, Z 16 XE	1598		0-N953	TB [DG]	
1.7 CDTI 16V	04/03-05/05	Z 17 DTL	1686		0-N1085	TB [TE]	



CM³



Art. Nr.



ASTRA Mk IV (G) Estate

1.7 CDTI 16V, 1.7 DTI 16V	02/00-05/05	Y 17 DT, Z 17 DTL	1686		0-N878	TB [DG]	
1.7 DTI 16V	02/00-05/05	Y 17 DT	1686	02HL5117, 20041690 →	0-N1085	TB [TE]	
1.7 TD	02/98-08/00	X 17 DTL	1700		0-N100	TB [TE]	
1.7 TD	02/98-08/00	X 17 DTL	1700		0-N909	TB [DG]	
1.8 16V, 1.8 16V Dualfuel	02/98-05/05	X 18 XE1, Z 18 XE	1796		0-N102	TB [TE]	
1.8 16V, 1.8 16V Dualfuel	02/98-05/05	X 18 XE1, Z 18 XE	1796	02HL5118, 20041691 →; mit Anbaumaterial	0-N300	TB [DG]	
1.8 16V, 1.8 16V Dualfuel	02/98-05/05	X 18 XE1, Z 18 XE	1796	02HL5117, 20041690	0-N952	TB [DG]	
1.8 16V, 1.8 16V Dualfuel	02/98-05/05	X 18 XE1, Z 18 XE	1796		0-N953	TB [DG]	
2.0 16V	02/98-05/05	X 20 XEV	1998		0-N100	TB [TE]	
2.0 16V	02/98-05/05	X 20 XER, X 20 XEV	1998		0-N127	TB [DG]	
2.0 16V	10/99-05/05	X 20 XER	1998		0-N1369	TB [TE]	
1.2 16V	02/98-05/05	X 12 XE, Z 12 XE	1199		0-N2170	VB [BT]	S
1.4 16V	02/98-05/05	X 14 XE, Z 14 XE	1389		0-N1466	VB [BT]	S
1.6	03/98-04/04	X 16 SZR	1598	Rippenanzahl: 6	0-N1439	VB [DG]	
1.6	03/98-04/04	X 16 SZR, Z 16 SE	1598		0-N948	TB [TE]	
1.6, 1.6 16V, 1.6 Dualfuel	03/98-05/05	X 16 SZR, X 16 XEL, Z 16 XE, Z 16 SE, Z 16 XE	1598		0-N1466	VB [BT]	S
1.8 16V, 1.8 16V Dualfuel	02/98-05/05	X 18 XE1, Z 18 XE	1796		0-N1466	VB [BT]	S
2.0 DI, 2.0 DTI 16V	03/98-04/04	X 20 DTH, Y 20 DTH, X 20 DTL, Y 20 DTL	1995	Rippenanzahl: 6	0-N1437	VB [DG]	
2.0 DI, 2.0 DTI 16V	03/98-04/04	X 20 DTH, Y 20 DTH, X 20 DTL, Y 20 DTL	1995		0-N1485	VB [BT]	S
2.0 DI, 2.0 DTI 16V	03/98-04/04	X 20 DTH, Y 20 DTH, X 20 DTL, Y 20 DTL	1995		0-N2169	VB [VD]	
2.2 16V	03/01-05/05	Z 22 SE	2198		0-N1588	VB [BT]	S

ASTRA Mk IV (G) Sedan

1.4 16V	09/98-05/05	X 14 XE, Z 14 XE	1389	20x162; 09/2000 →; 02HL5117, 20041690; mit Zubehör	SK-1113	BTK	
1.4 16V	09/98-05/05	X 14 XE, Z 14 XE	1389	20x162; 02HL5117, 20041690; mit Zubehör	SK-1113AQ1	BTKW	
1.4 16V	09/98-05/05	X 14 XE, Z 14 XE	1389	20x162; 02HL5118, 20041691 →; mit Zubehör	SK-1355	BTK	
1.4 16V	09/98-05/05	X 14 XE, Z 14 XE	1389	20x162; 02MV7225, 20U75999 →; mit Zubehör	SK-1355AQ2	BTKW	
1.4 16V	09/98-05/05	X 14 XE, Z 14 XE	1389	20x162; 02HL5118, 20041691 →; 02MV7224	SK-1355AQ3	BTKW	
1.6	09/00-05/05	Z 16 SE	1598	17x111; 02MZ5254, 20U75999 →	SK-1162AQ2	BTKW	
1.6 16V	09/98-05/05	C 16 SEL, X 16 XEL, Z 16 XE, Z 16 XEP	1598	20x162; 09/2000 →; 02HL5117, 20041690; mit Zubehör	SK-1113	BTK	
1.6 16V, 1.6 Dualfuel	09/98-05/05	C 16 SEL, X 16 XEL, Z 16 XE, Z 16 XEP, Z 16 XE	1598	20x162; 02HL5117, 20041690; mit Zubehör	SK-1113AQ1	BTKW	
1.6 16V, 1.6 Dualfuel	09/98-05/05	C 16 SEL, X 16 XEL, Z 16 XE, Z 16 XEP, Z 16 XE	1598	20x162; 02HL5118, 20041691 →; mit Zubehör	SK-1355	BTK	
1.6 16V, 1.6 Dualfuel	09/98-05/05	C 16 SEL, X 16 XEL, Z 16 XE, Z 16 XEP, Z 16 XE	1598	20x162; 02MV7225, 20U75999 →; mit Zubehör	SK-1355AQ2	BTKW	
1.6 16V, 1.6 Dualfuel	09/98-05/05	C 16 SEL, X 16 XEL, Z 16 XE, Z 16 XEP, Z 16 XE	1598	20x162; 02HL5118, 20041691 →; 02MV7224	SK-1355AQ3	BTKW	
1.6 Dualfuel	09/02-05/05	Z 16 XE	1598	20x162; 02HL5117, 20041690; mit Zubehör	SK-1113	BTK	
1.6, 1.6 Dualfuel	09/98-05/05	X 16 SZR, Z 16 SE	1598	17x111; mit Zubehör	SK-1162	BTK	
1.6, 1.6 Dualfuel	09/98-05/05	X 16 SZR, Z 16 SE	1598	17x111; mit Zubehör	SK-1162AQ1	BTKW	
1.7 CDTI 16V	04/03-05/05	Z 17 DTL	1686	25x129; mit Zubehör	SK-1612	BTK	
1.7 DTI 16V	02/00-05/05	Y 17 DT	1686	25x131; 09/2000 →; mit Zubehör	SK-1479	BTK	
1.7 DTI 16V	02/00-05/05	Y 17 DT	1686	25x131; 09/2000 →; 0328704 →; mit Zubehör	SK-1481	BTK	
1.7 DTI 16V	02/00-05/05	Y 17 DT	1686	25x131; 09/2000 →; 328703	SK-1689	BTK	
1.7 TD	09/98-08/00	X 17 DTL	1700	24x176	SK-1038	BTK	
1.7 TD	09/98-08/00	X 17 DTL	1700	24x176	SK-1038AQ1	BTKW	
1.8 16V	02/98-07/04	Z 18 XE	1796	20x162; 09/2000 →; 02HL5117, 20041690; mit Zubehör	SK-1113	BTK	
1.8 16V	02/98-07/04	X 18 XE1	1796	20x162; 11/1998 →; 02HL5117, 20041690; mit Zubehör	SK-1113	BTK	
1.8 16V Dualfuel	02/98-07/04	Z 18 XE	1796	20x162; 08/2001 →; 02HL5117, 20041690; mit Zubehör	SK-1113	BTK	
1.8 16V, 1.8 16V Dualfuel	02/98-07/04	X 18 XE1, Z 18 XE	1796	20x162; 02HL5117, 20041690; mit Zubehör	SK-1113AQ2	BTKW	
1.8 16V, 1.8 16V Dualfuel	02/98-07/04	X 18 XE1, Z 18 XE	1796	20x162; 02HL5118, 20041691 →; mit Zubehör	SK-1355	BTK	
1.8 16V, 1.8 16V Dualfuel	02/98-07/04	X 18 XE1, Z 18 XE	1796	20x162; 02HL5118, 20041691 →; mit Zubehör	SK-1355AQ1	BTKW	
2.0 16V	09/98-05/05	X 20 XEV	1998	24x168	SK-1478	BTK	
2.0 16V	09/98-05/05	X 20 XEV	1998	24x168	SK-1478AQ1	BTKW	



CM³



Art. Nr.



ASTRA Mk IV (G) Sedan

2.0 16V	10/99-05/05	X 20 XER	1998	24x168	SK-1632	BTK	
2.0 16V	10/99-05/05	X 20 XER	1998	24x168	SK-1632AQ1	BTKW	
1.4 16V	09/98-05/05	X 14 XE, Z 14 XE	1389		0-N102	TB [TE]	
1.4 16V	09/98-05/05	X 14 XE, Z 14 XE	1389	:02HL5118, 20041691→; †; mit Anbaumaterial	0-N300	TB [DG]	
1.4 16V	09/98-05/05	X 14 XE, Z 14 XE	1389	:→02HL5117, 20041690	0-N952	TB [DG]	
1.4 16V	09/98-05/05	X 14 XE, Z 14 XE	1389		0-N953	TB [DG]	
1.6 16V	09/98-05/05	C 16 SEL, X 16 XEL, Z 16 LER	1598		0-N102	TB [TE]	
1.6 16V	09/98-05/05	Z 16 XEP	1598		0-N1347	TB [TE]	
1.6 16V	09/98-05/05	C 16 SEL, X 16 XEL, Z 16 LER	1598	†; mit Anbaumaterial	0-N300	TB [DG]	
1.6 16V	09/98-05/05	C 16 SEL, X 16 XEL, Z 16 LER	1598		0-N953	TB [DG]	
1.6 16V, 1.6 Dualfuel	09/98-05/05	C 16 SEL, X 16 XEL, Z 16 XE, Z 16 XEP, Z 16 XE	1598	:02HL5118, 20041691→; †; mit Anbaumaterial	0-N300	TB [DG]	
1.6 16V, 1.6 Dualfuel	09/98-05/05	C 16 SEL, X 16 XEL, Z 16 XE, Z 16 XEP, Z 16 XE	1598	:→02HL5117, 20041690	0-N952	TB [DG]	
1.6 Dualfuel	09/02-05/05	Z 16 XE	1598		0-N102	TB [TE]	
1.6 Dualfuel	09/02-05/05	Z 16 XE	1598		0-N953	TB [DG]	
1.7 CDTI 16V	04/03-05/05	Z 17 DTL	1686		0-N1085	TB [TE]	
1.7 CDTI 16V, 1.7 DTI 16V	02/00-05/05	Y 17 DT, Z 17 DTL	1686		0-N878	TB [DG]	
1.7 DTI 16V	02/00-05/05	Y 17 DT	1686	:0328705→	0-N1085	TB [TE]	
1.7 TD	09/98-08/00	X 17 DTL	1700		0-N100	TB [TE]	
1.7 TD	09/98-08/00	X 17 DTL	1700		0-N909	TB [DG]	
1.8 16V, 1.8 16V Dualfuel	02/98-07/04	X 18 XE1, Z 18 XE	1796		0-N102	TB [TE]	
1.8 16V, 1.8 16V Dualfuel	02/98-07/04	X 18 XE1, Z 18 XE	1796	:02HL5118, 20041691→; †; mit Anbaumaterial	0-N300	TB [DG]	
1.8 16V, 1.8 16V Dualfuel	02/98-07/04	X 18 XE1, Z 18 XE	1796	:→02HL5117, 20041690	0-N952	TB [DG]	
1.8 16V, 1.8 16V Dualfuel	02/98-07/04	X 18 XE1, Z 18 XE	1796		0-N953	TB [DG]	
2.0 16V	09/98-05/05	X 20 XEV	1998		0-N100	TB [TE]	
2.0 16V	09/98-05/05	X 20 XER, X 20 XEV	1998		0-N127	TB [DG]	
2.0 16V	10/99-05/05	X 20 XER	1998		0-N1369	TB [TE]	
1.2 16V	09/98-05/05	X 12 XE, Z 12 XE	1199		0-N2170	VB [BT]	S
1.4	05/98-05/05	C 14 NZ	1389	für Fahrzeuge ohne Servolenkung	0-N1464	VB [BT]	S
1.4	05/98-05/05	C 14 NZ	1389		0-N948	TB [TE]	
1.4 16V	09/98-05/05	X 14 XE, Z 14 XE	1389		0-N1466	VB [BT]	S
1.6	09/98-09/00	X 16 SZR	1598	Rippenanzahl: 6	0-N1439	VB [DG]	
1.6	09/98-05/05	X 16 SZR, Z 16 SE	1598		0-N948	TB [TE]	
1.6 16V	09/98-05/05	Z 16 XEP	1598		0-N1799	VB [BT]	S
1.6, 1.6 16V, 1.6 Dualfuel	09/98-05/05	C 16 SEL, X 16 XEL, Z 16 XE, Z 16 XEP, X 16 SZR, Z 16 SE, Z 16 XE	1598		0-N1466	VB [BT]	S
1.8 16V, 1.8 16V Dualfuel	02/98-07/04	X 18 XE1, Z 18 XE	1796		0-N1466	VB [BT]	S
2.0 Di, 2.0 DTI 16V	02/98-07/04	X 20 DTH, Y 20 DTH, X 20 DTL, Y 20 DTL	1995	Rippenanzahl: 6	0-N1437	VB [DG]	
2.0 Di, 2.0 DTI 16V	02/98-07/04	X 20 DTH, Y 20 DTH, X 20 DTL, Y 20 DTL	1995		0-N1485	VB [BT]	S
2.0 Di, 2.0 DTI 16V	02/98-07/04	X 20 DTH, Y 20 DTH, X 20 DTL, Y 20 DTL	1995		0-N2169	VB [VD]	
2.2 16V	03/01-05/05	Z 22 SE	2198		0-N1588	VB [BT]	S
2.2 DTI	09/02-05/05	Y 22 DTR	2172		0-N1485	VB [BT]	S
2.2 DTI	09/02-05/05	Y 22 DTR	2172		0-N2169	VB [VD]	

ASTRA Mk V (H) CC

1.6, 1.6 Turbo	01/04-05/09	Z 16 LET, Z 16 XEP, Z 16 XER	1598	24x146	SK-1607	BTK	
1.7 CDTi	01/04-09/09	A 17 DTJ, Z 17 DTJ, A 17 DTR, Z 17 DTR	1686	25x131; mit Zubehör	SK-1481	BTK	
1.7 CDTI	01/04-05/09	Z 17 DTL	1686	25x129; 05/2004 →; mit Zubehör	SK-1612	BTK	
1.7 CDTI	01/04-05/09	Z 17 DTH	1686	25x129; mit Zubehör	SK-1612	BTK	
1.8	01/04-05/09	Z 18 XE	1796	20x162; mit Zubehör	SK-1355	BTK	
1.8	01/04-05/09	Z 18 XE	1796	20x162; mit Zubehör	SK-1355AQ1	BTKW	
1.8	01/04-05/09	A 18 XER, Z 18 XER	1796	24x146; 04/2006 →	SK-1607	BTK	
1.9 CDTI	01/04-05/09	Z 19 DT	1910	24x190	SK-1696	BTK	
1.9 CDTI	01/04-05/09	Z 19 DT	1910	24x190	SK-1696AQ1	BTKW	
1.9 CDTI, 1.9 CDTI 16V	01/04-05/09	Z 19 DTH, Z 19 DTJ	1910	24x199	SK-1586	BTK	
1.9 CDTI, 1.9 CDTI 16V	01/04-05/09	Z 19 DTH, Z 19 DTJ	1910	24x199	SK-1586AQ1	BTKW	
2.0 Turbo	01/04-05/09	Z 20 LEH, Z 20 LEL, Z 20 LER	1998	24x168	SK-1667	BTK	
2.0 Turbo	01/04-05/09	Z 20 LEH, Z 20 LEL, Z 20 LER	1998	24x168	SK-1667AQ1	BTKW	
1.6	01/04-05/09	Z 16 XEP	1598		0-N1348	TB [DG]	
1.6, 1.6 Turbo	01/04-05/09	Z 16 LET, Z 16 XEP, Z 16 XER	1598		0-N1347	TB [TE]	
1.7 CDTI	01/04-09/09	A 17 DTJ, Z 17 DTJ, A 17 DTR, Z 17 DTR, Z 17 DTH, Z 17 DTL	1686		0-N1085	TB [TE]	
1.7 CDTi	01/04-09/09	A 17 DTR	1686		0-N878	TB [DG]	
1.7 CDTI, 1.7 TD	01/04-05/09	Z 17 DTH, Z 17 DTL	1686		0-N878	TB [DG]	



CM³



Art. Nr.



ASTRA Mk V (H) CC

1.7 TD	01/04-05/09	A 17 DTJ	1686			0-N1085	TB [TE]	
1.8	01/04-05/09	Z 18 XE	1796			0-N102	TB [TE]	
1.8	01/04-05/09	A 18 XER, Z 18 XER	1796			0-N1347	TB [TE]	
1.8	01/04-05/09	Z 18 XE	1796	†; mit Anbaumaterial		0-N300	TB [DG]	
1.8	01/04-05/09	Z 18 XE	1796			0-N953	TB [DG]	
1.9 CDTi, 1.9 CDTi 16V	01/04-05/09	Z 19 DT, Z 19 DTH, Z 19 DTJ	1910			0-N115	TB [TE]	
1.9 CDTi, 1.9 CDTi 16V	01/04-05/09	Z 19 DT, Z 19 DTH, Z 19 DTJ	1910			0-N2149	TB [DG]	
2.0 Turbo	01/04-05/09	Z 20 LEH, Z 20 LEL, Z 20 LER	1998			0-N127	TB [DG]	
2.0 Turbo	01/04-05/09	Z 20 LEH, Z 20 LEL, Z 20 LER	1998			0-N1369	TB [TE]	
2.0 Turbo	01/04-05/09	Z 20 LEH, Z 20 LEL, Z 20 LER	1998			0-N1574	TB [DG]	
1.3 CDTi	01/04-05/09	Z 13 DTH	1248			0-N1526	VB [BT]	S
1.4	01/04-05/09	Z 14 XEP	1364			0-N2170	VB [BT]	S
1.6	01/04-05/09	Z 16 XEP, Z 16 XER	1598			0-N1799	VB [BT]	S
1.7 CDTi, 1.7 TD	01/04-09/09	A 17 DTJ, Z 17 DTJ, A 17 DTR, Z 17 DTR, Z 17 DTH	1686			0-N1798	VB [BT]	S
1.8	01/04-05/09	Z 18 XE	1796			0-N1466	VB [BT]	S
1.8	01/04-05/09	A 18 XER, Z 18 XER	1796			0-N1799	VB [BT]	S
1.9 CDTi	01/04-05/09	Z 19 DT, Z 19 DTH	1910	ENGINES: →71111927		0-N1503	VB [BT]	S
1.9 CDTi 16V	01/04-05/09	Z 19 DTJ	1910			0-N1503	VB [BT]	S
1.9 CDTi, 1.9 CDTi 16V	01/04-05/09	Z 19 DT, Z 19 DTH, Z 19 DTJ	1910	ENGINES: →71111927; †		0-N1522	VB [DG]	
1.9 CDTi, 1.9 CDTi 16V	01/04-05/09	Z 19 DT, Z 19 DTH, Z 19 DTJ	1910	Rippenanzahl: 6		0-N1667	VB [DG]	
1.9 CDTi, 1.9 CDTi 16V	01/04-05/09	Z 19 DT, Z 19 DTH, Z 19 DTJ	1910	ENGINES: 71111928 →		0-N2030	VB [BT]	S

ASTRA Mk V (H) Estate

1.6	08/04-03/09	Z 16 XEP	1598	24x146		SK-1607	BTK	
1.6	08/04-03/09	A 16 XER, Z 16 XER, Z 16 LET	1598	24x146; 10/2006 →		SK-1607	BTK	
1.7 CDTi	08/04-10/10	A 17 DTJ, Z 17 DTJ, A 17 DTR, Z 17 DTR	1686	25x131; mit Zubehör		SK-1481	BTK	
1.7 CDTi	08/04-03/09	Z 17 DTH	1686	25x129; mit Zubehör		SK-1612	BTK	
1.7 CDTi	08/04-05/09	Z 17 DTL	1686	25x129; 09/2004 →; mit Zubehör		SK-1612	BTK	
1.8	10/04-03/09	Z 18 XE	1796	20x162; mit Zubehör		SK-1355	BTK	
1.8	10/04-03/09	Z 18 XE	1796	20x162; mit Zubehör		SK-1355AQ1	BTKW	
1.8	12/05-10/10	A 18 XER, Z 18 XER	1796	24x146; 04/2006 →		SK-1607	BTK	
1.9 CDTi	08/04-03/09	Z 19 DT	1910	24x199		SK-1586	BTK	
1.9 CDTi	08/04-03/09	Z 19 DTH	1910	24x199; 11/2005 →		SK-1586	BTK	
1.9 CDTi	08/04-03/09	Z 19 DTH	1910	24x199		SK-1586AQ1	BTKW	
1.9 CDTi	08/04-03/09	Z 19 DT, Z 19 DTJ, Z 19 DTL	1910	24x190		SK-1696	BTK	
1.9 CDTi	08/04-03/09	Z 19 DT, Z 19 DTL	1910	24x190		SK-1696AQ1	BTKW	
2.0 Turbo	08/04-10/10	Z 20 LEL, Z 20 LER	1998	24x168		SK-1667	BTK	
2.0 Turbo	08/04-10/10	Z 20 LEL, Z 20 LER	1998	24x168		SK-1667AQ1	BTKW	
1.6	08/04-03/09	A 16 XER, Z 16 XER, Z 16 LET, Z 16 XEP	1598			0-N1347	TB [TE]	
1.6	08/04-03/09	Z 16 XEP	1598			0-N1348	TB [DG]	
1.7 CDTi	08/04-10/10	A 17 DTJ, Z 17 DTJ, A 17 DTR, Z 17 DTR, Z 17 DTH	1686			0-N1085	TB [TE]	
1.7 CDTi	08/04-10/10	A 17 DTR	1686			0-N878	TB [DG]	
1.7 CDTi, 1.7 TD	08/04-05/09	Z 17 DTH, Z 17 DTL	1686			0-N878	TB [DG]	
1.7 TD	08/04-03/09	A 17 DTJ	1686			0-N1085	TB [TE]	
1.8	10/04-03/09	Z 18 XE	1796			0-N102	TB [TE]	
1.8	10/04-03/09	Z 18 XE	1796	†; mit Anbaumaterial		0-N300	TB [DG]	
1.8	10/04-03/09	Z 18 XE	1796			0-N953	TB [DG]	
1.8	12/05-10/10	A 18 XER, Z 18 XER	1796			0-N1347	TB [TE]	
1.9 CDTi	08/04-03/09	Z 19 DT, Z 19 DTH, Z 19 DTJ, Z 19 DTL	1910			0-N115	TB [TE]	
1.9 CDTi	08/04-03/09	Z 19 DT, Z 19 DTH, Z 19 DTJ, Z 19 DTL	1910			0-N2149	TB [DG]	
2.0 Turbo	08/04-10/10	Z 20 LEL, Z 20 LER	1998			0-N127	TB [DG]	
2.0 Turbo	08/04-10/10	Z 20 LEL, Z 20 LER	1998			0-N1369	TB [TE]	
2.0 Turbo	08/04-10/10	Z 20 LEL, Z 20 LER	1998			0-N1574	TB [DG]	
1.3 CDTi	08/04-03/09	Z 13 DTH	1248			0-N1526	VB [BT]	S
1.4	08/04-03/09	Z 14 XEP	1364			0-N2170	VB [BT]	S
1.6	08/04-03/09	A 16 XER, Z 16 XER, Z 16 LET, Z 16 XEP	1598			0-N1799	VB [BT]	S
1.7 CDTi, 1.7 TD	08/04-10/10	A 17 DTJ, Z 17 DTJ, A 17 DTR, Z 17 DTR, Z 17 DTH	1686			0-N1798	VB [BT]	S
1.8	10/04-03/09	Z 18 XE	1796			0-N1466	VB [BT]	S
1.8	12/05-10/10	A 18 XER, Z 18 XER	1796			0-N1799	VB [BT]	S
1.9 CDTi	08/04-03/09	Z 19 DT, Z 19 DTH, Z 19 DTJ, Z 19 DTL	1910	ENGINES: →71111927		0-N1503	VB [BT]	S
1.9 CDTi	08/04-03/09	Z 19 DT, Z 19 DTH, Z 19 DTJ, Z 19 DTL	1910	ENGINES: →71111927; †		0-N1522	VB [DG]	
1.9 CDTi	08/04-03/09	Z 19 DT, Z 19 DTH, Z 19 DTJ, Z 19 DTL	1910	Rippenanzahl: 6		0-N1667	VB [DG]	
1.9 CDTi	08/04-03/09	Z 19 DT, Z 19 DTH, Z 19 DTJ	1910	ENGINES: 71111928 →		0-N2030	VB [BT]	S

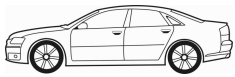

CM³



Art. Nr.



ASTRA Mk V (H) Sport Hatch

1.6, 1.6 i 16V	02/05-11/10	Z 16 LET, Z 16 XEP, Z 16 XER	1598	24x146	SK-1607	BTK	
1.7 CDTi	02/05-11/10	Z 17 DTH	1686	25x129; mit Zubehör	SK-1612	BTK	
1.7 CDTi	02/07-11/10	A 17 DTJ	1686	25x131; mit Zubehör	SK-1481	BTK	
1.8	02/05-11/10	Z 18 XE	1796	20x162; mit Zubehör	SK-1355	BTK	
1.8	02/05-11/10	Z 18 XE	1796	20x162; mit Zubehör	SK-1355AQ1	BTKW	
1.8 i 16V	03/07-11/10	A 18 XER, Z 18 XER	1796	24x146	SK-1607	BTK	
1.9 CDTi	02/05-11/10	Z 19 DT, Z 19 DTH	1910	24x199	SK-1586	BTK	
1.9 CDTi	02/05-11/10	Z 19 DTH	1910	24x199	SK-1586AQ1	BTKW	
1.9 CDTi	02/05-11/10	Z 19 DT, Z 19 DTL	1910	24x190	SK-1696	BTK	
1.9 CDTi	02/05-11/10	Z 19 DT, Z 19 DTL	1910	24x190	SK-1696AQ1	BTKW	
2.0 Turbo, 2.0 VXR	02/05-11/10	Z 20 LEH, Z 20 LEL	1998	24x168	SK-1667	BTK	
2.0 Turbo, 2.0 VXR	02/05-11/10	Z 20 LEH, Z 20 LEL	1998	24x168	SK-1667AQ1	BTKW	
1.6	02/05-11/10	Z 16 XEP	1598		0-N1348	TB [DG]	
1.6, 1.6 i 16V	02/05-11/10	Z 16 LET, Z 16 XEP, Z 16 XER	1598		0-N1347	TB [TE]	
1.7 CDTi	02/05-11/10	Z 17 DTH	1686		0-N1085	TB [TE]	
1.7 CDTi	02/05-11/10	Z 17 DTH	1686		0-N878	TB [DG]	
1.7 CDTi	02/07-11/10	A 17 DTJ	1686		0-N1085	TB [TE]	
1.7 CDTi	02/07-11/10	A 17 DTR	1686		0-N878	TB [DG]	
1.8	02/05-11/10	Z 18 XE	1796		0-N102	TB [TE]	
1.8	02/05-11/10	Z 18 XE	1796	†; mit Anbaumaterial	0-N300	TB [DG]	
1.8	02/05-11/10	Z 18 XE	1796		0-N953	TB [DG]	
1.8 i 16V	03/07-11/10	A 18 XER, Z 18 XER	1796		0-N1347	TB [TE]	
1.9 CDTi	02/05-11/10	Z 19 DT, Z 19 DTH, Z 19 DTL	1910		0-N115	TB [TE]	
1.9 CDTi	02/05-11/10	Z 19 DT, Z 19 DTH, Z 19 DTL	1910		0-N2149	TB [DG]	
2.0 Turbo, 2.0 VXR	02/05-11/10	Z 20 LEH, Z 20 LEL	1998		0-N127	TB [DG]	
2.0 Turbo, 2.0 VXR	02/05-11/10	Z 20 LEH, Z 20 LEL	1998		0-N1369	TB [TE]	
2.0 Turbo, 2.0 VXR	02/05-11/10	Z 20 LEH, Z 20 LEL	1998		0-N1574	TB [DG]	
1.3 CDTi	04/05-11/10	Z 13 DTH	1248		0-N1526	VB [BT]	S
1.4 i 16V	03/05-11/10	Z 14 XEP	1364		0-N2170	VB [BT]	S
1.6, 1.6 i 16V	02/05-11/10	Z 16 LET, Z 16 XEP, Z 16 XER	1598		0-N1799	VB [BT]	S
1.7 CDTi	02/05-11/10	A 17 DTJ, Z 17 DTH, Z 17 DTR	1686		0-N1798	VB [BT]	S
1.8	02/05-11/10	Z 18 XE	1796		0-N1466	VB [BT]	S
1.8 i 16V	03/07-11/10	A 18 XER, Z 18 XER	1796		0-N1799	VB [BT]	S
1.9 CDTi	02/05-11/10	Z 19 DT	1910		0-N1503	VB [BT]	S
1.9 CDTi	02/05-11/10	Z 19 DTH, Z 19 DTL	1910	EMARK: →71111927	0-N1503	VB [BT]	S
1.9 CDTi	02/05-11/10	Z 19 DT, Z 19 DTH, Z 19 DTL	1910	EMARK: →71111927; ⚙	0-N1522	VB [DG]	
1.9 CDTi	02/05-11/10	Z 19 DT, Z 19 DTH, Z 19 DTL	1910	Rippenanzahl: 6	0-N1667	VB [DG]	
1.9 CDTi	02/05-11/10	Z 19 DTH, Z 19 DTL	1910	EMARK: 71111928 →	0-N2030	VB [BT]	S

ASTRA TwinTop Mk V (H)

1.6	09/05-11/10	Z 16 XEP	1598	24x146; 02/2006 →	SK-1607	BTK	
1.6, 1.6 i 16V	10/06-11/10	Z 16 LET, Z 16 XER	1598	24x146	SK-1607	BTK	
1.8	09/05-11/10	Z 18 XE	1796	20x162; mit Zubehör	SK-1355	BTK	
1.8	05/08-11/10	Z 18 XER	1796	24x146	SK-1607	BTK	
1.9 CDTi	01/06-11/10	Z 19 DTH	1910	24x199	SK-1586	BTK	
1.9 CDTi	01/06-11/10	Z 19 DTH	1910	24x199	SK-1586AQ1	BTKW	
2.0, 2.0 Turbo	01/06-11/10	Z 20 LEL, Z 20 LER	1998	24x168	SK-1667	BTK	
2.0, 2.0 Turbo	01/06-11/10	Z 20 LEL, Z 20 LER	1998	24x168	SK-1667AQ1	BTKW	
1.6	09/05-11/10	Z 16 XEP	1598		0-N1348	TB [DG]	
1.6, 1.6 i 16V	09/05-11/10	Z 16 LET, Z 16 XEP, Z 16 XER	1598		0-N1347	TB [TE]	
1.8	05/08-11/10	Z 18 XER	1796		0-N1347	TB [TE]	
1.9 CDTi	01/06-11/10	Z 19 DTH	1910		0-N115	TB [TE]	
1.9 CDTi	01/06-11/10	Z 19 DTH	1910		0-N2149	TB [DG]	
2.0, 2.0 Turbo	01/06-11/10	Z 20 LEL, Z 20 LER	1998		0-N127	TB [DG]	
2.0, 2.0 Turbo	01/06-11/10	Z 20 LEL, Z 20 LER	1998		0-N1369	TB [TE]	
2.0, 2.0 Turbo	01/06-11/10	Z 20 LEL, Z 20 LER	1998		0-N1574	TB [DG]	
1.6, 1.6 i 16V	09/05-11/10	Z 16 LET, Z 16 XEP, Z 16 XER	1598		0-N1799	VB [BT]	S
1.8	05/08-11/10	Z 18 XER	1796		0-N1799	VB [BT]	S
1.9 CDTi	01/06-11/10	Z 19 DTH	1910	EMARK: →71111927	0-N1503	VB [BT]	S
1.9 CDTi	01/06-11/10	Z 19 DTH	1910	EMARK: →71111927; ⚙	0-N1522	VB [DG]	
1.9 CDTi	01/06-11/10	Z 19 DTH	1910	Rippenanzahl: 6	0-N1667	VB [DG]	
1.9 CDTi	01/06-11/10	Z 19 DTH	1910	EMARK: 71111928 →	0-N2030	VB [BT]	S

ASTRA Mk VI (J)

1.6, 1.6 Turbo	12/09-	A 16 LET, A 16 XER, B 16 XER	1598	24x146	SK-1607	BTK	
1.7 CDTi	12/09-	A 17 DTC, A 17 DTE, A 17 DTJ, A 17 DTF, A 17 DTS, A 17 DTL, Z 17 DTH, A 17 DTR	1686	25x131; mit Zubehör	SK-1481	BTK	



CM³



Art. Nr.



ohne Halter

ASTRA Mk VI (J)

2.0 CDTi	12/09-	A 20 DTH	1956	24x199; → 06/2011	SK-1586	BTK	
2.0 CDTi	12/09-	A 20 DTH	1956	24x199	SK-1586AQ1	BTKW	
2.0 CDTi	08/11-	A 20 DTH	1956	24x199	SK-1586	BTK	
1.6, 1.6 Turbo	12/09-	A 16 LET, A 16 XER, B 16 XER	1598		0-N1347	TB [TE]	
1.7 CDTi	12/09-	A 17 DTC, A 17 DTE, A 17 DTJ, A 17 DTF, A 17 DTS, A 17 DTL, Z 17 DTH, A 17 DTR	1686		0-N1085	TB [TE]	
1.7 CDTi	12/09-	A 17 DTF, A 17 DTS, A 17 DTL, Z 17 DTH, A 17 DTR	1686		0-N878	TB [DG]	
1.7 CDTi	12/09-	A17DTJ	1686		0-N878	TB [DG]	
2.0 BiTurbo CDTi, 2.0 CDTi	12/09-	A 20 DTH, A 20 DTR	1956		0-N2149	TB [DG]	
2.0 CDTi	12/09-	A 20 DTH	1956		0-N115	TB [TE]	
1.3 CDTi	12/09-	A 13 DTE	1248		0-N1526	VB [BT]	S
1.4	12/09-	A 14 XEL, A 14 XER	1398		0-N2170	VB [BT]	S
1.4 Turbo	12/09-	A 14 NEL, A 14 NET	1364		0-N2170	VB [BT]	S
1.6 CDTi	11/13-	B 16 DTH, B 16 DTL	1598	☒	0-N1649	VB [DG]	
1.6, 1.6 Turbo	12/09-	A 16 LET, A 16 XER, B 16 XER	1598		0-N1799	VB [BT]	S
1.7 CDTi	12/09-	A 17 DTC, A 17 DTE, A 17 DTJ, A 17 DTF, A 17 DTS, A 17 DTR	1686	☒	0-N2341	VB [DG]	
1.7 CDTi	12/09-	A 17 DTC, A 17 DTE, A 17 DTJ, A 17 DTF, A 17 DTS, A 17 DTR	1686		0-N2389	VB [BT]	S
2.0 BiTurbo CDTi, 2.0 CDTi	12/09-	A 20 DTH, A 20 DTR	1956	☒	0-N1649	VB [DG]	
2.0 BiTurbo CDTi, 2.0 CDTi	12/09-	A 20 DTH, A 20 DTR	1956	für Fahrzeuge mit elektrischer Servolenkung	0-N2254	VB [DG]	
2.0 CDTi	12/09-	A 20 DTH	1956		0-N2087	VB [BT]	S
2.0 CDTi	12/09-	A 20 DTH	1956		0-N2221	VB [DG]	

ASTRA Mk VI (J) Sedan

1.6 Turbo	06/12-	A 16 LET, A 16 XER	1598	24x146	SK-1607	BTK	
1.7 CDTi	06/12-	A 17 DTC, A 17 DTE, A 17 DTJ, A 17 DTF, A 17 DTS	1686	25x131; mit Zubehör	SK-1481	BTK	
1.6 Turbo	06/12-	A 16 LET, A 16 XER	1598		0-N1347	TB [TE]	
1.7 CDTi	06/12-	A 17 DTC, A 17 DTE, A 17 DTJ, A 17 DTF, A 17 DTS	1686		0-N1085	TB [TE]	
1.7 CDTi	06/12-	A 17 DTC, A 17 DTE, A 17 DTJ, A 17 DTF, A 17 DTS	1686		0-N878	TB [DG]	
2.0 BiTurbo CDTi	12/12-	A 20 DTR	1956		0-N2149	TB [DG]	
1.7 CDTi	06/12-	A 17 DTC, A 17 DTE, A 17 DTJ, A 17 DTF, A 17 DTS	1686	☒	0-N2341	VB [DG]	
1.7 CDTi	06/12-	A 17 DTC, A 17 DTE, A 17 DTJ, A 17 DTF, A 17 DTS	1686		0-N2389	VB [BT]	S
2.0 BiTurbo CDTi	12/12-	A 20 DTR	1956	☒	0-N1649	VB [DG]	
2.0 BiTurbo CDTi	12/12-	A 20 DTR	1956	für Fahrzeuge mit elektrischer Servolenkung	0-N2254	VB [DG]	

ASTRA Mk VI (J) Estate

1.6, 1.6 Turbo	10/10-	A 16 LET, A 16 XER, B 16 XER	1598	24x146	SK-1607	BTK	
1.7 CDTi	10/10-	A 17 DTC, A 17 DTE, A 17 DTJ, A 17 DTF, A 17 DTS, A 17 DTL, A 17 DTR	1686	25x131; mit Zubehör	SK-1481	BTK	
2.0 CDTi	10/10-	A 20 DTH	1956	24x199; → 06/2011	SK-1586	BTK	
2.0 CDTi	10/10-	A 20 DTH	1956	24x199	SK-1586AQ1	BTKW	
2.0 CDTi	08/11-	A 20 DTH	1956	24x199	SK-1586	BTK	
1.6, 1.6 Turbo	10/10-	A 16 LET, A 16 XER, B 16 XER	1598		0-N1347	TB [TE]	
1.7 CDTi	10/10-	A 17 DTC, A 17 DTE, A 17 DTJ, A 17 DTF, A 17 DTS, A 17 DTL, A 17 DTR	1686		0-N1085	TB [TE]	
1.7 CDTi	10/10-	A 17 DTF, A 17 DTS, A 17 DTL, A 17 DTR	1686		0-N878	TB [DG]	
1.7 CDTi	10/10-	A17DTJ	1686		0-N878	TB [DG]	
2.0 BiTurbo CDTi, 2.0 CDTi	10/10-	A 20 DTH, A 20 DTR	1956		0-N2149	TB [DG]	
2.0 CDTi	10/10-	A 20 DTH	1956		0-N115	TB [TE]	
1.3 CDTi	10/10-	A 13 DTE	1248		0-N1526	VB [BT]	S
1.4	12/09-	A 14 XEL, A 14 XER	1398		0-N2170	VB [BT]	S
1.4 Turbo	10/10-	A 14 NEL, A 14 NET	1364		0-N2170	VB [BT]	S
1.6 CDTi	01/14-	B 16 DTH, B 16 DTL	1598	☒	0-N1649	VB [DG]	
1.6, 1.6 Turbo	10/10-	A 16 LET, A 16 XER, B 16 XER	1598		0-N1799	VB [BT]	S
1.7 CDTi	10/10-	A 17 DTC, A 17 DTE, A 17 DTJ, A 17 DTF, A 17 DTS, A 17 DTR	1686	☒	0-N2341	VB [DG]	
1.7 CDTi	10/10-	A 17 DTC, A 17 DTE, A 17 DTJ, A 17 DTF, A 17 DTS, A 17 DTR	1686		0-N2389	VB [BT]	S
2.0 BiTurbo CDTi, 2.0 CDTi	10/10-	A 20 DTH, A 20 DTR	1956	☒	0-N1649	VB [DG]	
2.0 BiTurbo CDTi, 2.0 CDTi	10/10-	A 20 DTH, A 20 DTR	1956	für Fahrzeuge mit elektrischer Servolenkung	0-N2254	VB [DG]	
2.0 CDTi	10/10-	A 20 DTH	1956		0-N2087	VB [BT]	S
2.0 CDTi	10/10-	A 20 DTH	1956		0-N2221	VB [DG]	



CM³



Art. Nr.



ASTRA GTC Mk VI (J)

1.6	10/11-	A 16 LET	1598	24x146	SK-1607	BTK	
1.7 CDTi	10/11-	A 17 DTC, A 17 DTE, A 17 DTJ, A 17 DTF, A 17 DTS	1686	25x131; mit Zubehör	SK-1481	BTK	
2.0 CDTi	10/11-	A 20 DTH	1956	24x199	SK-1586	BTK	
2.0 CDTi	10/11-	A 20 DTH	1956	24x199	SK-1586AQ1	BTKW	
1.6	10/11-	A 16 LET	1598		0-N1347	TB [TE]	
1.7 CDTi	10/11-	A 17 DTC, A 17 DTE, A 17 DTJ	1686		0-N1085	TB [TE]	
1.7 CDTi	10/11-	A 17 DTF, A 17 DTS	1686		0-N1085	TB [TE]	
1.7 CDTi	10/11-	A 17 DTC, A 17 DTE, A 17 DTJ	1686		0-N878	TB [DG]	
1.7 CDTi	10/11-	A 17 DTF, A 17 DTS	1686		0-N878	TB [DG]	
2.0 BiTurbo CDTi	12/12-	A 20 DTR	1956		0-N2236	TB [DG]	
2.0 BiTurbo CDTi, 2.0 CDTi	10/11-	A 20 DTH, A 20 DTR	1956		0-N2149	TB [DG]	
1.4	10/11-	A 14 NEL, B 14 NEL, A 14 NET, B 14 NET	1364		0-N2170	VB [BT]	S
1.4	10/11-	A 14 XER	1398		0-N2170	VB [BT]	S
1.6	10/11-	A 16 LET	1598		0-N1799	VB [BT]	S
1.6 CDTi	07/14-	B 16 DTH, B 16 DTL	1598	☼	0-N1649	VB [DG]	
1.7 CDTi	10/11-	A 17 DTC, A 17 DTE, A 17 DTJ, A 17 DTF, A 17 DTS	1686	☼	0-N2341	VB [DG]	
1.7 CDTi	10/11-	A 17 DTC, A 17 DTE, A 17 DTJ, A 17 DTF, A 17 DTS	1686		0-N2389	VB [BT]	S
2.0 BiTurbo CDTi, 2.0 CDTi	10/11-	A 20 DTH, A 20 DTR	1956	☼	0-N1649	VB [DG]	
2.0 BiTurbo CDTi, 2.0 CDTi	10/11-	A 20 DTH, A 20 DTR	1956		0-N2221	VB [DG]	
2.0 BiTurbo CDTi, 2.0 CDTi	10/11-	A 20 DTH, A 20 DTR	1956	für Fahrzeuge mit elektrischer Servolenkung	0-N2254	VB [DG]	
2.0 CDTi	10/11-	A 20 DTH	1956		0-N2087	VB [BT]	S
2.0 VXR	04/12-	A 20 NFT, B 20 NFT	1998		0-N2283	VB [DG]	
2.0 VXR	04/12-	A 20 NFT, B 20 NFT	1998		0-N2299	VB [BT]	S

ASTRAMAX

1.4 i	08/91-07/94	C 14 NZ	1389	17x111; :19311738→; mit Zubehör	SK-1162	BTK	
1.4 i	08/91-07/94	C 14 NZ	1389	17x111; :19311738→; mit Zubehör	SK-1162AQ1	BTKW	
1.4 S	07/89-08/91	14 NV	1389	17x111; :02J22650, 19307806→; mit Zubehör	SK-1162	BTK	
1.4 S	07/89-08/91	14 NV	1389	17x111; :02J22650, 19307806→; mit Zubehör	SK-1162AQ1	BTKW	
1.6 D	05/86-06/90	16 DA	1598	24x146; :14498631→;	SK-1037	BTK	
1.6 D	05/86-06/90	16 DA	1598	24x146; :14503757→;	SK-1037	BTK	
1.6 D	05/86-06/90	16 DA	1598	24x146; :14498631→;	SK-1037AQ1	BTKW	
1.6 D	05/86-06/90	16 DA	1598	24x146; :14503757→;	SK-1037AQ1	BTKW	
1.6 D	05/86-06/90	16 DA	1598	24x147; :14498630;	SK-1056	BTK	
1.6 D	05/86-06/90	16 DA	1598	24x147; :14503756;	SK-1056	BTK	
1.6, 1.6 i	09/85-10/94	16 SV, C 16 NZ	1598	17x111; :02J22350→; mit Zubehör	SK-1162	BTK	
1.6, 1.6 i	09/85-10/94	16 SV, C 16 NZ	1598	17x111; :02J22350→; mit Zubehör	SK-1162AQ1	BTKW	
1.7 D	01/89-07/94	17 D	1700	24x146; :14363650	SK-1037	BTK	
1.7 D	01/89-07/94	17 D	1700	24x146; :14363650	SK-1037AQ1	BTKW	
1.7 D	01/89-07/94	17 D	1700	24x176; :14363651→	SK-1038	BTK	
1.7 D	01/89-07/94	17 D	1700	24x176; :14363651→	SK-1038AQ1	BTKW	
1.6 D	05/86-06/90	16 DA	1598	:14478631, 14503757→	0-N875	TB [DG]	
1.7 D	01/89-07/94	17 D	1700	:14363650	0-N875	TB [DG]	
1.4 i, 1.4 S	07/89-07/94	14 NV, C 14 NZ	1389	Rippenanzahl: 6	0-N1439	VB [DG]	
1.6	09/85-12/91	16 SV	1598	:02122350→	0-N948	TB [TE]	
1.6 i	08/91-10/94	C 16 NZ	1598	Rippenanzahl: 6	0-N1439	VB [DG]	

ASTRAVAN Mk III (F)

1.4 i	01/91-10/94	C 14 NZ	1389	17x111; 09/1991 →; mit Zubehör	SK-1162	BTK	
1.4 i	01/91-10/94	C 14 NZ	1389	17x111; 09/1991 →; mit Zubehör	SK-1162AQ1	BTKW	
1.6 i	01/91-08/98	C 16 NZ, X 16 SZ	1598	17x111; 09/1994 →; mit Zubehör	SK-1162	BTK	
1.6 i	01/91-08/98	C 16 NZ, X 16 SZ	1598	17x111; 09/1994 →; mit Zubehör	SK-1162AQ1	BTKW	
1.7 D	01/91-08/94	17 DR	1699	24x176; 09/1993 →	SK-1038	BTK	
1.7 D	01/91-08/94	17 DR	1699	24x176	SK-1038AQ1	BTKW	
1.7 TD	01/94-08/98	X 17 DTL	1700	24x176; 09/1994 →	SK-1038	BTK	
1.7 TD	01/94-08/98	X 17 DTL	1700	24x176	SK-1038AQ1	BTKW	
1.7 D	01/91-08/94	17 DR	1699		0-N100	TB [TE]	
1.7 D	01/91-08/94	17 DR	1699		0-N909	TB [DG]	
1.7 TD	01/94-08/98	X 17 DTL	1700		0-N100	TB [TE]	
1.7 TD	01/94-08/98	X 17 DTL	1700		0-N909	TB [DG]	
1.4 i	01/91-10/94	C 14 NZ	1389	:19311739→	0-N948	TB [TE]	
1.6 i	01/91-08/98	C 16 NZ, X 16 SZ	1598	Rippenanzahl: 6	0-N1439	VB [DG]	
1.6 i	01/91-08/98	C 16 NZ, X 16 SZ	1598		0-N948	TB [TE]	



OPTIMAL®

VAUXHALL



CM³



Art. Nr.



ohne Halter

ASTRAVAN Mk IV (G)

1.6 i	08/98-09/00	X 16 SZR	1598	17x111; mit Zubehör	SK-1162	BTK	
1.6 i	08/98-09/00	X 16 SZR	1598	17x111; mit Zubehör	SK-1162AQ1	BTKW	
1.6 i	09/00-08/06	Z 16 SE	1598	17x111; 04/2001 →; mit Zubehör	SK-1162	BTK	
1.6 i	09/00-08/06	Z 16 SE	1598	17x111; →02MZ5253, 20U75998; mit Zubehör	SK-1162AQ1	BTKW	
1.6 i	09/00-08/06	Z 16 SE	1598	17x111; →02MZ5254, 20U75999→	SK-1162AQ2	BTKW	
1.7 CDTi	04/04-08/06	Z 17 DTL	1686	25x129; 03/2005 →; mit Zubehör	SK-1612	BTK	
1.7 DTi 16V	04/01-08/06	Y 17 DT	1686	25x131; mit Zubehör	SK-1479	BTK	
1.7 DTi 16V	04/01-08/06	Y 17 DT	1686	25x131; →328704→; mit Zubehör	SK-1481	BTK	
1.7 DTi 16V	04/01-08/06	Y 17 DT	1686	25x131; →328703	SK-1689	BTK	
1.7 TD	08/98-08/06	X 17 DTL	1700	24x176	SK-1038	BTK	
1.7 TD	08/98-08/06	X 17 DTL	1700	24x176	SK-1038AQ1	BTKW	
1.7 CDTi	04/04-08/06	Z 17 DTL	1686		0-N1085	TB [TE]	
1.7 CDTi, 1.7 DTi 16V	04/01-08/06	Y 17 DT, Z 17 DTL	1686		0-N878	TB [DG]	
1.7 DTi 16V	04/01-08/06	Y 17 DT	1686	→0328705→	0-N1085	TB [TE]	
1.7 TD	08/98-08/06	X 17 DTL	1700		0-N100	TB [TE]	
1.7 TD	08/98-08/06	X 17 DTL	1700		0-N909	TB [DG]	
1.6 i	08/98-09/00	X 16 SZR	1598	Rippenanzahl: 6	0-N1439	VB [DG]	
1.6 i	08/98-08/06	X 16 SZR, Z 16 SE	1598		0-N1466	VB [BT]	S
1.6 i	08/98-08/06	X 16 SZR, Z 16 SE	1598		0-N948	TB [TE]	
2.0 Di, 2.0 DTi	08/98-08/06	X 20 DTL, Y 20 DTH	1995	Rippenanzahl: 6	0-N1437	VB [DG]	
2.0 Di, 2.0 DTi	08/98-08/06	X 20 DTL, Y 20 DTH	1995		0-N1485	VB [BT]	S
2.0 Di, 2.0 DTi	08/98-08/06	X 20 DTL, Y 20 DTH	1995		0-N2169	VB [VD]	

ASTRAVAN Mk V (H)

1.6	03/05-	Z 16 XE1, Z 16 XEP	1598	24x146	SK-1607	BTK	
1.7 CDTi	03/05-11/11	Z 17 DTH, Z 17 DTL	1686	25x129; mit Zubehör	SK-1612	BTK	
1.7 CDTi	06/11-12/13	A 17 DTJ, Z 17 DTJ, A 17 DTR, Z 17 DTR	1686	25x131; mit Zubehör	SK-1481	BTK	
1.9 CDTi	03/05-11/11	Z 19 DTH	1910	24x199	SK-1586	BTK	
1.9 CDTi	03/05-11/11	Z 19 DTH	1910	24x199	SK-1586AQ1	BTKW	
1.9 CDTi	03/05-11/11	Z 19 DT	1910	24x190	SK-1696	BTK	
1.9 CDTi	03/05-11/11	Z 19 DT	1910	24x190	SK-1696AQ1	BTKW	
1.6	03/05-	Z 16 XE1, Z 16 XEP	1598		0-N1347	TB [TE]	
1.7 CDTi	03/05-12/13	A 17 DTJ, Z 17 DTJ, A 17 DTR, Z 17 DTR, Z 17 DTH, Z 17 DTL	1686		0-N1085	TB [TE]	
1.7 CDTi	03/05-12/13	A 17 DTJ, Z 17 DTJ, A 17 DTR, Z 17 DTR, Z 17 DTH, Z 17 DTL	1686		0-N878	TB [DG]	
1.9 CDTi	03/05-11/11	Z 19 DT, Z 19 DTH	1910		0-N115	TB [TE]	
1.9 CDTi	03/05-11/11	Z 19 DT, Z 19 DTH	1910		0-N2149	TB [DG]	
1.3 CDTi	08/05-	Z 13 DTH	1248		0-N1526	VB [BT]	S
1.4 i	03/05-	Z 14 XEP	1364		0-N2170	VB [BT]	S
1.6	03/05-	Z 16 XE1, Z 16 XEP	1598		0-N1799	VB [BT]	S
1.7 CDTi	03/05-11/11	Z 17 DTH	1686		0-N1798	VB [BT]	S
1.7 CDTi	06/11-12/13	A 17 DTJ, Z 17 DTJ, A 17 DTR, Z 17 DTR	1686		0-N2389	VB [BT]	S
1.9 CDTi	03/05-11/11	Z 19 DT, Z 19 DTH	1910	→71111927	0-N1503	VB [BT]	S
1.9 CDTi	03/05-11/11	Z 19 DT, Z 19 DTH	1910	→71111927; ⚡	0-N1522	VB [DG]	
1.9 CDTi	03/05-11/11	Z 19 DT, Z 19 DTH	1910	Rippenanzahl: 6	0-N1667	VB [DG]	
1.9 CDTi	03/05-11/11	Z 19 DT, Z 19 DTH	1910	→71111928→	0-N2030	VB [BT]	S

BRAVA Pick-up

2.5 D, 2.5 D 4x4, 2.5 TD, 2.5 TD 4x4	06/90-12/02	4 JA1, 4 JA1T	2499	32x119	SK-1260	BTK	
3.1 D	07/91-07/01	4 JG2 T	3059	32x119	SK-1260	BTK	
2.2 D, 2.2 D 4x4	12/88-09/96	C223	2238		0-N048	TB [TE]	
2.3, 2.3 4x4	06/90-08/94	4 ZD1	2255		0-N042	TB [TE]	
2.3, 2.3 4x4	08/94-09/96	23 P	2254		0-N042	TB [TE]	

CALIBRA

2.0 i 16V	06/90-07/97	X 20 XEV	1998	24x169; 09/1994 →	SK-1100	BTK	
2.0 i 16V	06/90-07/97	X 20 XEV	1998	24x169; 09/1994 →	SK-1100AQ1	BTKW	
2.0 i 16V 4x4	02/94-07/97	X 20 XEV	1998	24x169	SK-1100	BTK	
2.0 i 16V 4x4	02/94-07/97	X 20 XEV	1998	24x169	SK-1100AQ1	BTKW	
2.0 i 16V, 2.0 i 16V 4x4	06/90-02/94	C 20 XE	1998	24x176; →14142839→	SK-1165	BTK	
2.0 i 16V, 2.0 i 16V 4x4, 2.0 i Turbo 4x4	06/90-07/97	C 20 LET, C 20 XE	1998	24x141	SK-1163	BTK	
2.0 i Turbo 4x4	03/92-07/97	C 20 LET	1998	24x176; →14002935→	SK-1165	BTK	
2.0 i, 2.0 i 4x4	06/90-07/97	C 20 NE	1998	20x111; →14608701	R-1072AQ1	BTKW	
2.0 i, 2.0 i 4x4	06/90-07/97	C 20 NE	1998	20x146; →14608701→	SK-1169	BTK	
2.0 i, 2.0 i 4x4	06/90-07/97	C 20 NE	1998	20x146; →14608702→	SK-1169AQ1	BTKW	
2.5 i V6	04/93-07/97	C 25 XE, X 25 XE	2498	30x225; 09/1993 →; mit Zubehör	SK-1508	BTK	

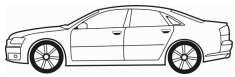

CM³



Art. Nr.



CALIBRA

2.0 i 16V, 2.0 i 16V 4x4	06/90-02/94	C 20 XE	1998	:14142839→	0-N100	TB [TE]	
2.0 i 16V, 2.0 i 16V 4x4	06/90-07/97	X 20 XEV	1998		0-N100	TB [TE]	
2.0 i 16V, 2.0 i 16V 4x4	06/90-02/94	C 20 XE	1998	:14142839→	0-N906	TB [DG]	
2.0 i 16V, 2.0 i 16V 4x4	06/90-07/97	X 20 XEV	1998		0-N906	TB [DG]	
2.0 i 16V, 2.0 i 16V 4x4	06/90-02/94	C 20 XE	1998	:14142839→	0-N907	TB [DG]	
2.0 i 16V, 2.0 i 16V 4x4, 2.0 i Turbo 4x4	06/90-07/97	C 20 LET, C 20 XE	1998		0-N877	TB [TE]	
2.0 i Turbo 4x4	03/92-07/97	C 20 LET	1998	ch.14002935→	0-N100	TB [TE]	
2.0 i Turbo 4x4	03/92-07/97	C 20 LET	1998	ch.14002935→	0-N906	TB [DG]	
2.0 i Turbo 4x4	03/92-07/97	C 20 LET	1998	ch.14002935→	0-N907	TB [DG]	
2.0 i, 2.0 i 4x4	06/90-07/97	C 20 NE	1998	:14608701→	0-N101	TB [TE]	
2.5 i V6	04/93-07/97	C 25 XE, X 25 XE	2498		0-N957	TB [DG]	
2.5 i V6	04/93-07/97	C 25 XE, X 25 XE	2498	Rippenanzahl: 6;	0-N1438	VB [BT]	S
2.5 i V6	04/93-07/97	C 25 XE, X 25 XE	2498		0-N1603	VB [DG]	

CARLTON Mk II

2.0 S	10/78-08/86	C 20 NEJ	1998	20x111; :→14608700	R-1072AQ1	BTKW	
-------	-------------	----------	------	--------------------	------------------	------	--

CARLTON Mk II Estate

2.0 S	01/82-08/86	C 20 NEJ	1998	20x111; :→14608700	R-1072AQ1	BTKW	
-------	-------------	----------	------	--------------------	------------------	------	--

CARLTON Mk III

1.8	09/87-03/94	E 18 NVR	1796	20x111	R-1072AQ1	BTKW	
1.8 i, 1.8 S	09/86-03/94	18 SEH, 18 SV	1796	20x111; → 09/1991; :→14270600	R-1072AQ1	BTKW	
1.8 N	09/86-08/87	18 NV	1796	20x111; :→14270600	R-1072AQ1	BTKW	
2.0, 2.0 i	09/86-03/94	20 SE, C 20 NE, C 20 NEF, C 20 NEJ	1998	20x111; :→14608700	R-1072AQ1	BTKW	
2.0, 2.0 i	09/86-03/94	20 SE, C 20 NE, C 20 NEF, C 20 NEJ	1998	20x146; :14608701→	SK-1169	BTK	
2.0, 2.0 i	09/86-03/94	20 SE, C 20 NE, C 20 NEF, C 20 NEJ	1998	20x146; :14608701→	SK-1169AQ1	BTKW	
1.8 S	09/86-03/94	18 SV	1796	:14142839→	0-N101	TB [TE]	
2.0, 2.0 i	09/86-03/94	20 SE, C 20 NE	1998	:14608701→	0-N101	TB [TE]	
2.6 i	09/90-03/94	C 26 NE	2594	ch.01032427→; Rippenanzahl: 6	0-N1439	VB [DG]	
2.6 i	09/90-03/94	C 26 NE	2594		0-N1603	VB [DG]	
3.0 3000, 3.0 3000 24V, 3000 KAT	03/87-03/94	30 NE, C 30 NE, C 30 SE	2969	ch.01024730, 01039675→; Rippenanzahl: 6	0-N1439	VB [DG]	
3.0 3000, 3.0 3000 24V, 3000 KAT	03/87-03/94	30 NE, C 30 NE, C 30 SE	2969		0-N1603	VB [DG]	

CARLTON Mk III Estate

1.8	09/87-03/94	E 18 NVR	1796	20x111	R-1072AQ1	BTKW	
1.8 i, 1.8 S	09/86-03/94	18 SEH, 18 SV	1796	20x111; → 08/1987; :→14270600	R-1072AQ1	BTKW	
1.8, 1.8 N	09/86-08/88	18 NV, S 18 NV	1796	20x111; :→14270600	R-1072AQ1	BTKW	
2.0, 2.0 i	09/86-03/94	20 SE, C 20 NE, C 20 NEF, C 20 NEJ	1998	20x111; :→14608700	R-1072AQ1	BTKW	
2.0, 2.0 i	09/86-03/94	20 SE, C 20 NE, C 20 NEF, C 20 NEJ	1998	20x146; :14608701→	SK-1169	BTK	
2.0, 2.0 i	09/86-03/94	20 SE, C 20 NE, C 20 NEF, C 20 NEJ	1998	20x146; :14608701→	SK-1169AQ1	BTKW	
2.0, 2.0 i	09/86-03/94	20 SE, C 20 NE	1998	:14608701→	0-N101	TB [TE]	
2.6 i	09/90-03/94	C 26 NE	2594	ch.01032427→; Rippenanzahl: 6	0-N1439	VB [DG]	
3.0	03/87-03/94	C 30 NE	2969	ch.01024730, 01039675→; Rippenanzahl: 6	0-N1439	VB [DG]	
3.0	03/87-03/94	C 30 NE	2969		0-N1603	VB [DG]	

CASCADA Convertible

2.0 CDTI	02/13-	A 20 DTH	1956	24x199	SK-1586	BTK	
2.0 CDTI	02/13-	A 20 DTH	1956	24x199	SK-1586AQ1	BTKW	
2.0 CDTI	02/13-	A 20 DTH, A 20 DTR	1956		0-N2149	TB [DG]	
2.0 CDTI	02/13-	A 20 DTR	1956		0-N2236	TB [DG]	
1.4	02/13-	A 14 NEL	1364		0-N2170	VB [BT]	S
2.0 CDTI	02/13-	A 20 DTR	1956	für Fahrzeuge mit elektrischer Servolenkung	0-N2254	VB [DG]	

CAVALIER Mk II

1.6	08/81-07/86	16 N	1598	20x111; :14054371→;	R-1072AQ1	BTKW	
1.6	08/81-07/86	16 N	1598	20x111; :14058656→;	R-1072AQ1	BTKW	
1.6 D	03/82-08/88	16 D	1598	24x146	SK-1037	BTK	
1.6 D	03/82-08/88	16DA	1598	24x146	SK-1037AQ1	BTKW	
1.6 D	03/82-08/88	16 D	1598	24x147; :→14498630;	SK-1056	BTK	
1.6 D	03/82-08/88	16 D	1598	24x147; :→14503756;	SK-1056	BTK	
1.6 i, 1.6 i KAT, 1.6 N	09/81-08/88	16 N, C 16 LZ, C 16 NZ, E 16 NZ	1598	17x111; :02J22350→; mit Zubehör	SK-1162	BTK	
1.6 i, 1.6 i KAT, 1.6 N	09/81-08/88	16 N, C 16 LZ, C 16 NZ, E 16 NZ	1598	17x111; :02J22350→; mit Zubehör	SK-1162AQ1	BTKW	
1.6 S	09/81-08/88	16 SH	1598	20x111; :14387790→;	R-1072AQ1	BTKW	
1.6 S	09/81-08/88	16 SH	1598	20x111; :14391115→;	R-1072AQ1	BTKW	
1.8 i	09/81-08/88	18 E, 18 SE	1796	20x111; LHT; :14056061→	R-1072AQ1	BTKW	
1.8 i	09/81-08/88	18 E, 18 SE	1796	20x111; RHT; :14237770→	R-1072AQ1	BTKW	
2.0 4x4, 2.0 i, 2.0 i KAT, 2.0 SRi 130	09/86-08/88	20 NE, 20 SEH, C 20 NE	1998	20x111	R-1072AQ1	BTKW	
1.6 D	03/82-08/88	16 D	1598	:14478631, 14503757→	0-N875	TB [DG]	



OPTIMAL®

VAUXHALL



CM³



Art. Nr.



ohne Halter

CAVALIER Mk II							
1.8	08/86-08/88	C 18 NZ, S 18 NV	1796	:14142839→		0-N101	TB [TE]
CAVALIER Mk II CC							
1.6 S	09/81-08/88	16 SH	1598	20x111; :14387790→;		R-1072AQ1	BTKW
1.6 S	09/81-08/88	16 SH	1598	20x111; :14391115→;		R-1072AQ1	BTKW
1.8 i, 1.8 S	09/81-08/88	18 E, 18 S, 18 SE	1796	20x111; LHT; :14056061→		R-1072AQ1	BTKW
1.8 i, 1.8 S	09/81-08/88	18 E, 18 S, 18 SE	1796	20x111; RHT; :14237770→		R-1072AQ1	BTKW
1600D	03/82-08/88	16 D, 16 DA	1598	24x146		SK-1037	BTK
1600D	03/82-08/88	16 DA	1598	24x146		SK-1037AQ1	BTKW
1600D	03/82-08/88	16 D, 16 DA	1598	24x147; :→14498630;		SK-1056	BTK
1600D	03/82-08/88	16 D, 16 DA	1598	24x147; :→14503756;		SK-1056	BTK
2.0 4x4, 2.0 i KAT, 2.0 SRi 130	09/86-08/88	20 SEH, C 20 NE	1998	20x111		R-1072AQ1	BTKW
1600D	03/82-08/88	16 D, 16 DA	1598	:14478631, 14503757→		0-N875	TB [DG]
CAVALIER Mk II Convertible							
1800i	03/85-10/88	18 SE	1796	20x111; LHT; :14056061→		R-1072AQ1	BTKW
1800i	03/85-10/88	18 SE	1796	20x111; RHT; :14237770→		R-1072AQ1	BTKW
CAVALIER Mk II Estate							
1.6	10/83-08/88	16 SH	1598	20x111; :14387790→;		R-1072AQ1	BTKW
1.6	10/83-08/88	16 SH	1598	20x111; :14391115→;		R-1072AQ1	BTKW
1.6 D	03/82-08/88	16 DA	1598	24x146		SK-1037	BTK
1.6 D	03/82-08/88	16 DA	1598	24x146		SK-1037AQ1	BTKW
1.8 i	09/81-08/88	18 E, 18 SE	1796	20x111; LHT; :14056061→		R-1072AQ1	BTKW
1.8 i	09/81-08/88	18 E, 18 SE	1796	20x111; RHT; :14237770→		R-1072AQ1	BTKW
1.6 D	03/82-08/88	16 DA	1598	:14478631, 14503757→		0-N875	TB [DG]
CAVALIER Mk III (87)							
1.4 S	09/88-11/95	14 NV	1389	17x111; :1402J22350, 19307806→; mit Zubehör		SK-1162	BTK
1.4 S	09/88-11/95	14 NV	1389	17x111; :1402J22350→; mit Zubehör		SK-1162AQ1	BTKW
1.4 S	09/88-11/95	14 NV	1389	17x111; :19307806→; mit Zubehör		SK-1162AQ1	BTKW
1.6	09/88-05/93	16 SV	1598	17x111; :02J22350→; mit Zubehör		SK-1162	BTK
1.6	09/88-05/93	16 SV	1598	17x111; :02J22350→; mit Zubehör		SK-1162AQ1	BTKW
1.6 i	09/88-11/95	E 16 NZ	1598	17x111; 09/1989 →; :02J22350→; mit Zubehör		SK-1162	BTK
1.6 i	09/88-11/95	E 16 NZ	1598	17x111; 09/1989 →; :02J22350→; mit Zubehör		SK-1162AQ1	BTKW
1.6 i	09/93-11/95	X 16 SZ	1598	17x111; mit Zubehör		SK-1162	BTK
1.6 i	09/93-11/95	X 16 SZ	1598	17x111; :02J22350, 19307806→; mit Zubehör		SK-1162AQ1	BTKW
1.7 D	09/88-09/92	17 D	1699	24x146		SK-1037	BTK
1.7 D	09/88-09/92	17 D	1699	24x146; :→14333430		SK-1037AQ1	BTKW
1.7 D	09/88-09/92	17 D	1699	24x176; :14333431→		SK-1038	BTK
1.7 D	09/88-09/92	17 D	1699	24x176; :14333431→		SK-1038AQ1	BTKW
1.7 D	07/92-11/95	17 DR	1700	24x146; :→14333430		SK-1037	BTK
1.7 D	07/92-11/95	17 DR	1700	24x146; :→14333430		SK-1037AQ1	BTKW
1.7 D	07/92-11/95	17 DR	1700	24x176; 01/1993 →; :14333431→		SK-1038	BTK
1.7 D	07/92-11/95	17 DR	1700	24x176; :14333431→		SK-1038AQ1	BTKW
1.7 TD	09/88-11/95	17 DT (TC4EE1)	1686	25.4x136; 09/1992 →; :→551390; mit Zubehör		SK-1164	BTK
1.7 TD	09/88-11/95	17 DT (TC4EE1)	1686	25x136; 09/1992 →; :551391→; mit Zubehör		SK-1168	BTK
1.8, 1.8 i KAT	09/88-11/95	18 SV, C 18 NZ, C 18 NZ	1796	20x111; :→14142838		R-1072AQ1	BTKW
1.8, 1.8 i KAT	09/88-11/95	18 SV, C 18 NZ, C 18 NZ	1796	20x146; :14142839→		SK-1169	BTK
1.8, 1.8 i KAT	09/88-11/95	C 18 NZ	1796	20x146; :14254439→		SK-1169AQ1	BTKW
1.8, 1.8 i KAT	09/88-11/95	18 SV, C 18 NZ, C 18 NZ	1796	20x146; :14270601→		SK-1169AQ1	BTKW
2.0 GSi, 2.0 GSi 4x4	09/89-08/92	20 XE	1998	24x141; :→14142838		SK-1163	BTK
2.0 GSi, 2.0 GSi 4x4	09/89-08/92	20 XE	1998	24x176; :14142839→		SK-1165	BTK
2.0 i 16V, 2.0 i 16V 4x4	09/88-11/95	C 20 XE	1998	24x176; 01/1993 →; :14142839→		SK-1165	BTK
2.0 i 16V, 2.0 i 16V 4x4, 2.0 i Turbo 4x4	09/88-11/95	C 20 LET, C 20 XE	1998	24x141		SK-1163	BTK
2.0 i 4x4	09/88-09/92	20 SEH	1998	20x111; ch.→M1999999, MV999999; 09/1989 →; :→14608700		R-1072AQ1	BTKW
2.0 i 4x4	09/88-09/92	20 SEH	1998	20x111; ch.→M5999999; 09/1989 →; :→14608700		R-1072AQ1	BTKW
2.0 i 4x4	01/91-10/92	20 NE	1998	20x111; :→14142838		R-1072AQ1	BTKW
2.0 i 4x4	01/91-10/92	20 NE	1998	20x146; :14142839→		SK-1169	BTK
2.0 i 4x4	01/91-10/92	20 NE	1998	20x146; :14142839→		SK-1169AQ1	BTKW
2.0 i Turbo 4x4	06/92-11/94	C 20 LET	1998	24x176; :14002935→		SK-1165	BTK
2.0 i, 2.0 i 4x4, 2.0 i KAT, 2.0 SRi	09/88-11/95	20 NE, 20 SEH, C 20 NE	1998	20x146; ch.N1000001, NV000001→		SK-1169	BTK



CM³



Art. Nr.



CAVALIER Mk III (87)

2.0 i, 2.0 i 4x4, 2.0 i KAT, 2.0 SRi	09/88-11/95	20 NE, 20 SEH, C 20 NE	1998	20x146; ch.N5000001→	SK-1169	BTK	
2.0 i, 2.0 i 4x4, 2.0 i KAT, 2.0 SRi	09/88-11/95	20 NE, 20 SEH, C 20 NE	1998	20x146; :14608701→	SK-1169AQ1	BTKW	
2.0 i, 2.0 i KAT, 2.0 SRi	09/88-11/95	20 NE, 20 SEH, C 20 NE	1998	20x111; ch.→M1999999, MV999999; :→14608700	R-1072AQ1	BTKW	
2.0 i, 2.0 i KAT, 2.0 SRi	09/88-11/95	20 NE, 20 SEH, C 20 NE	1998	20x111; ch.→M5999999; :→14608700	R-1072AQ1	BTKW	
2.0 SRi 16V	09/93-11/95	X 20 XEV	1998	24x169	SK-1100	BTK	
2.0 SRi 16V	09/93-11/95	X 20 XEV	1998	24x169	SK-1100AQ1	BTKW	
2.5 V6	08/88-06/94	C 25 XE	2498	30x225; mit Zubehör	SK-1508	BTK	
1.7 D	09/88-09/92	17 D	1699		0-N875	TB [DG]	
1.7 D	07/92-11/95	17 DR	1700		0-N100	TB [TE]	
1.7 D	07/92-11/95	17 DR	1700		0-N909	TB [DG]	
1.7 TD	09/88-11/95	17 DT (TC4EE1)	1686	:855806→	0-N126	TB [TE]	
1.7 TD	09/88-11/95	17 DT (TC4EE1)	1686		0-N878	TB [DG]	
1.7 TD	09/88-11/95	17 DT (TC4EE1)	1686	:→855805	0-N910	TB [TE]	
1.8, 1.8 i KAT	09/88-11/95	C 18 NZ	1796	:14142839→	0-N101	TB [TE]	
2.0 GSi, 2.0 GSi 4x4, 2.0 i 16V, 2.0 i 16V 4x4	09/88-11/95	20 XE, C 20 XE	1998		0-N877	TB [TE]	
2.0 i 16V, 2.0 i 16V 4x4	09/88-11/95	C 20 XE	1998	:14142839→	0-N100	TB [TE]	
2.0 i 16V, 2.0 i 16V 4x4	09/88-11/95	C 20 XE	1998	:14142839→	0-N906	TB [DG]	
2.0 i 16V, 2.0 i 16V 4x4	09/88-11/95	C 20 XE	1998	:14142839→	0-N907	TB [DG]	
2.0 i KAT	09/90-11/95	C 20 NE	1998	:14608701→	0-N101	TB [TE]	
2.0 i Turbo 4x4	06/92-11/94	C 20 LET	1998		0-N907	TB [DG]	
2.0 i Turbo 4x4, 2.0 SRi 16V	06/92-11/95	C 20 LET, X 20 XEV	1998		0-N100	TB [TE]	
2.0 i Turbo 4x4, 2.0 SRi 16V	06/92-11/95	C 20 LET, X 20 XEV	1998		0-N906	TB [DG]	
2.5 V6	08/88-06/94	C 25 XE	2498		0-N957	TB [DG]	
1.4 S	09/88-11/95	14 NV	1389	:19307806→	0-N948	TB [TE]	
1.6 i	09/93-11/95	X 16 SZ	1598	Rippenanzahl: 6	0-N1439	VB [DG]	
1.6 i	09/93-11/95	X 16 SZ	1598		0-N948	TB [TE]	
1.6, 1.6 i	09/88-11/95	16 SV, E 16 NZ	1598	:02122350→	0-N948	TB [TE]	
1.7 TD	09/88-11/95	17 DT (TC4EE1)	1686	Rippenanzahl: 6;	0-N1439	VB [DG]	
2.5 V6	08/88-06/94	C 25 XE	2498	Rippenanzahl: 6;	0-N1438	VB [BT]	S
2.5 V6	08/88-06/94	C 25 XE	2498		0-N1603	VB [DG]	

CAVALIER Mk III CC

1.4 S	09/88-11/95	14 NV	1389	17x111; :1402J22350, 19307806→; mit Zubehör	SK-1162	BTK	
1.4 S	09/88-11/95	14 NV	1389	17x111; :1402J22350→; mit Zubehör	SK-1162AQ1	BTKW	
1.4 S	09/88-11/95	14 NV	1389	17x111; :19307806→; mit Zubehör	SK-1162AQ1	BTKW	
1.6	09/88-05/93	16 SV	1598	17x111; :02J22350→; mit Zubehör	SK-1162	BTK	
1.6	09/88-05/93	16 SV	1598	17x111; :02J22350→; mit Zubehör	SK-1162AQ1	BTKW	
1.6 i	09/88-11/95	E 16 NZ	1598	17x111; 09/1989 →; :02J22350→; mit Zubehör	SK-1162	BTK	
1.6 i	09/88-11/95	E 16 NZ	1598	17x111; 09/1989 →; :02J22350→; mit Zubehör	SK-1162AQ1	BTKW	
1.6 i	09/93-11/95	X 16 SZ	1598	17x111; mit Zubehör	SK-1162	BTK	
1.6 i	09/93-11/95	X 16 SZ	1598	17x111; :02J22350, 19307806→; mit Zubehör	SK-1162AQ1	BTKW	
1.7 D	09/88-09/92	17 D	1699	24x146	SK-1037	BTK	
1.7 D	09/88-09/92	17 D	1699	24x146; :→14333430	SK-1037AQ1	BTKW	
1.7 D	09/88-09/92	17 D	1699	24x176; :14333431→	SK-1038	BTK	
1.7 D	09/88-09/92	17 D	1699	24x176; :14333431→	SK-1038AQ1	BTKW	
1.7 D	07/92-11/95	17 DR	1700	24x146; :→14333430	SK-1037	BTK	
1.7 D	07/92-11/95	17 DR	1700	24x146; :→14333430	SK-1037AQ1	BTKW	
1.7 D	07/92-11/95	17 DR	1700	24x176; 01/1993 →; :14333431→	SK-1038	BTK	
1.7 D	07/92-11/95	17 DR	1700	24x176; :14333431→	SK-1038AQ1	BTKW	
1.7 TD	09/88-11/95	17 DT (TC4EE1)	1686	25.4x136; 09/1992 →; :→551390; mit Zubehör	SK-1164	BTK	
1.7 TD	09/88-11/95	17 DT (TC4EE1)	1686	25x136; 09/1992 →; :551391→; mit Zubehör	SK-1168	BTK	
1.8 i KAT	03/90-11/95	C 18 NZ	1796	20x146; 01/1993 →; :14142839→	SK-1169	BTK	
1.8, 1.8 i KAT	09/88-11/95	18 SV, C 18 NZ, C 18 NZ	1796	20x111; :→14142838	R-1072AQ1	BTKW	
1.8, 1.8 i KAT	09/88-11/95	18 SV, C 18 NZ, C 18 NZ	1796	20x146; :14254439→	SK-1169AQ1	BTKW	
2.0 i 16V	09/93-11/95	X 20 XEV	1998	24x169	SK-1100	BTK	
2.0 i 16V	09/93-11/95	X 20 XEV	1998	24x169	SK-1100AQ1	BTKW	
2.0 i 16V, 2.0 i 16V 4x4	09/88-11/95	C 20 XE	1998	24x141	SK-1163	BTK	
2.0 i 16V, 2.0 i 16V 4x4	09/88-11/95	C 20 XE	1998	24x176; 01/1993 →; :14142839→	SK-1165	BTK	
2.0 i 4x4	09/88-09/92	20 SEH	1998	20x146; ch.N1000001, N5000001→	SK-1169	BTK	
2.0 i 4x4	09/88-09/92	20 SEH	1998	20x146; ch.NV000001→	SK-1169	BTK	



CM³



Art. Nr.



ohne Halter

CAVALIER Mk III CC

2.0 i 4x4	01/91-10/92	20 NE	1998	20x111; 09/1991 →; :→14142838	R-1072AQ1	BTKW	
2.0 i 4x4	01/91-10/92	20 NE	1998	20x146; :14142839→	SK-1169	BTK	
2.0 i 4x4	01/91-10/92	20 NE	1998	20x146; :14142839→	SK-1169AQ1	BTKW	
2.0 i, 2.0 i 4x4, 2.0 i KAT, 2.0 SRi	09/88-11/95	20 NE, 20 SEH, C 20 NE	1998	20x111; ch.→M1999999, MV999999; :→14608700	R-1072AQ1	BTKW	
2.0 i, 2.0 i 4x4, 2.0 i KAT, 2.0 SRi	09/88-11/95	20 NE, 20 SEH, C 20 NE	1998	20x111; ch.→M5999999; :→14608700	R-1072AQ1	BTKW	
2.0 i, 2.0 i 4x4, 2.0 i KAT, 2.0 SRi	09/88-11/95	20 NE, 20 SEH, C 20 NE	1998	20x146; :14608701→	SK-1169AQ1	BTKW	
2.0 i, 2.0 i KAT, 2.0 SRi	09/88-11/95	20 NE, 20 SEH, C 20 NE	1998	20x146; ch.N1000001, NV000001→	SK-1169	BTK	
2.0 i, 2.0 i KAT, 2.0 SRi	09/88-11/95	20 NE, 20 SEH, C 20 NE	1998	20x146; ch.N5000001→	SK-1169	BTK	
2.5 V6	09/88-06/94	C 25 XE	2498	30x225; mit Zubehör	SK-1508	BTK	
1.7 D	09/88-09/92	17 D	1699		0-N875	TB [DG]	
1.7 D	07/92-11/95	17 DR	1700		0-N100	TB [TE]	
1.7 D	07/92-11/95	17 DR	1700		0-N909	TB [DG]	
1.7 TD	09/88-11/95	17 DT (TC4EE1)	1686	:855806→	0-N126	TB [TE]	
1.7 TD	09/88-11/95	17 DT (TC4EE1)	1686		0-N878	TB [DG]	
1.7 TD	09/88-11/95	17 DT (TC4EE1)	1686	:→855805	0-N910	TB [TE]	
1.8, 1.8 i KAT	09/88-11/95	C 18 NZ	1796	:14142839→	0-N101	TB [TE]	
2.0 i 16V	09/93-11/95	X 20 XEV	1998		0-N100	TB [TE]	
2.0 i 16V	09/93-11/95	X 20 XEV	1998		0-N906	TB [DG]	
2.0 i 16V, 2.0 i 16V 4x4	09/88-11/95	C 20 XE	1998	:14142839→	0-N100	TB [TE]	
2.0 i 16V, 2.0 i 16V 4x4	09/88-11/95	C 20 XE	1998		0-N877	TB [TE]	
2.0 i 16V, 2.0 i 16V 4x4	09/88-11/95	C 20 XE	1998	:14142839→	0-N906	TB [DG]	
2.0 i 16V, 2.0 i 16V 4x4	09/88-11/95	C 20 XE	1998	:14142839→	0-N907	TB [DG]	
2.0 i KAT	09/90-11/95	C 20 NE	1998	:14608701→	0-N101	TB [TE]	
2.5 V6	09/88-06/94	C 25 XE	2498		0-N957	TB [DG]	
1.4 S	09/88-11/95	14 NV	1389	:19307806→	0-N948	TB [TE]	
1.6 i	09/93-11/95	X 16 SZ	1598	Rippenanzahl: 6	0-N1439	VB [DG]	
1.6 i	09/93-11/95	X 16 SZ	1598		0-N948	TB [TE]	
1.6, 1.6 i	09/88-11/95	16 SV, E 16 NZ	1598	:02122350→	0-N948	TB [TE]	
1.7 TD	09/88-11/95	17 DT (TC4EE1)	1686	Rippenanzahl: 6;	0-N1439	VB [DG]	
2.5 V6	09/88-06/94	C 25 XE	2498	Rippenanzahl: 6;	0-N1438	VB [BT]	S
2.5 V6	09/88-06/94	C 25 XE	2498		0-N1603	VB [DG]	

COMBO Mk I (B)

1.2	07/94-10/01	C 12 NZ, X 12 SZ	1195	17x111; mit Zubehör	SK-1162	BTK	
1.2	07/94-10/01	C 12 NZ, X 12 SZ	1195	17x111; mit Zubehör	SK-1162AQ1	BTKW	
1.4	07/94-10/01	C 14 NZ, C 14 SE	1389	17x111; mit Zubehör; Baumuster: 71_	SK-1162	BTK	
1.4	07/94-10/01	C 14 NZ, C 14 SE	1389	17x111; mit Zubehör	SK-1162AQ1	BTKW	
1.4 16V	08/99-10/01	X 14 XE	1389	20x169; mit Zubehör	SK-1073	BTK	
1.7 D	07/94-10/01	17 D (4EE1), X 17 D (4EE1)	1686	25.4x136; R3999999, R4999999, R6999999; mit Zubehör	SK-1164	BTK	
1.7 D	07/94-10/01	17 D (4EE1), X 17 D (4EE1)	1686	25x136; ch.S3000001, S4000001, S6000001→; :→029082; mit Zubehör	SK-1168	BTK	
1.7 D	07/94-10/01	17 D (4EE1), X 17 D (4EE1)	1686	:855806→	0-N126	TB [TE]	
1.7 D	07/94-10/01	17 D (4EE1), X 17 D (4EE1)	1686		0-N878	TB [DG]	
1.7 D	07/94-10/01	17 D (4EE1), X 17 D (4EE1)	1686	:→855805	0-N910	TB [TE]	
1.2	07/94-10/01	C 12 NZ, X 12 SZ	1195		0-N948	TB [TE]	
1.4	07/94-10/01	C 14 NZ, C 14 SE	1389	Rippenanzahl: 6	0-N1439	VB [DG]	
1.4	07/94-10/01	C 14 NZ, C 14 SE	1389	für Fahrzeuge ohne Servolenkung	0-N1464	VB [BT]	S
1.4	07/94-10/01	C 14 NZ, C 14 SE	1389		0-N948	TB [TE]	
1.7 D	07/94-10/01	17 D (4EE1), X 17 D (4EE1)	1686	Rippenanzahl: 6;	0-N1439	VB [DG]	

COMBO Mk II (C) Kasten/Kombi (F25)

1.4 16V	10/01-05/07	Z 14 XE	1389	20x162; mit Zubehör	SK-1355	BTK	
1.4 16V	10/01-05/07	Z 14 XE	1389	20x162; :02MZ5254, 20U75999→; mit Zubehör	SK-1355AQ2	BTKW	
1.4 16V	10/01-05/07	Z 14 XE	1389	20x162; :→02MZ5253, 20U75998	SK-1355AQ3	BTKW	
1.6	09/01-11/11	Z 16 SE	1598	17x111; mit Zubehör	SK-1162	BTK	
1.6 CNG 16V	04/05-02/12	Z 16 YNG	1598	20x162; mit Zubehör	SK-1355	BTK	
1.6 CNG 16V	04/05-02/12	Z 16 YNG	1598	20x162; mit Zubehör	SK-1355AQ2	BTKW	
1.7 CDTI 16V, 1.7 DI 16V, 1.7 DTI 16V	09/01-11/11	Y 17 DT, Y 17 DTL, Z 17 DTH	1686	25x131; mit Zubehör	SK-1479	BTK	
1.7 DI 16V, 1.7 DTI 16V	09/01-11/11	Y 17 DT, Y 17 DTL	1686	25x131; :328704→; mit Zubehör	SK-1481	BTK	
1.7 DI 16V, 1.7 DTI 16V	09/01-11/11	Y 17 DT, Y 17 DTL	1686	25x131; :→328703	SK-1689	BTK	
1.7 CDTI 16V	12/04-11/11	Z 17 DTH	1686		0-N1085	TB [TE]	
1.7 CDTI 16V, 1.7 DI 16V, 1.7 DTI 16V	09/01-11/11	Y 17 DT, Y 17 DTL, Z 17 DTH	1686		0-N878	TB [DG]	
1.7 DI 16V, 1.7 DTI 16V	09/01-11/11	Y 17 DT, Y 17 DTL	1686	:0328705→	0-N1085	TB [TE]	
1.3 CDTI 16V	09/04-02/12	Z 13 DT, Z 13 DTJ	1248		0-N1526	VB [BT]	S

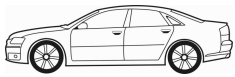

CM³



Art. Nr.



COMBO Mk II (C) Kasten/Kombi (F25)

1.4 16V	10/01-05/07	Z 14 XE	1389		0-N1466	VB [BT]	S
1.4 i 16V	01/04-11/11	Z 14 XEP	1364		0-N2170	VB [BT]	S
1.6	10/01-11/11	Z 16 SE	1598		0-N948	TB [TE]	
1.6, 1.6 CNG 16V	09/01-02/12	Z 16 SE, Z 16 YNG	1598		0-N1466	VB [BT]	S
1.7 CDTi 16V	12/04-11/11	Z 17 DTH	1686		0-N1798	VB [BT]	S

COMBO TOUR Mk II (C) (F25)

1.6	10/01-06/04	Z 16 SE	1598	17x111; mit Zubehör	SK-1162	BTK	
1.6 CNG, 1.6 CNG 16V	04/05-02/12	Z 16 YNG	1598	20x162; mit Zubehör	SK-1355	BTK	
1.6 CNG, 1.6 CNG 16V	04/05-02/12	Z 16 YNG	1598	20x162; mit Zubehör	SK-1355AQ2	BTKW	
1.7 CDTi 16V, 1.7 DI 16V, 1.7 DTi 16V	09/01-02/12	Y 17 DT, Y 17 DTL, Z 17 DTH	1686	25x131; mit Zubehör	SK-1479	BTK	
1.7 DI 16V, 1.7 DTi 16V	09/01-02/12	Y 17 DT, Y 17 DTL	1686	25x131; :328704→; mit Zubehör	SK-1481	BTK	
1.7 DI 16V, 1.7 DTi 16V	09/01-02/12	Y 17 DT, Y 17 DTL	1686	25x131; :→328703	SK-1689	BTK	
1.6 CNG	06/06-09/10	Z 16 YNG	1598		0-N102	TB [TE]	
1.6 CNG	06/06-09/10	Z 16 YNG	1598	†; mit Anbaumaterial	0-N300	TB [DG]	
1.6 CNG	06/06-09/10	Z 16 YNG	1598		0-N953	TB [DG]	
1.7 CDTi 16V	12/04-09/10	Z 17 DTH	1686		0-N1085	TB [TE]	
1.7 DI 16V, 1.7 DTi 16V	09/01-02/12	Y 17 DT, Y 17 DTL	1686	:0328705→	0-N1085	TB [TE]	
1.7 DI 16V, 1.7 DTi 16V	09/01-02/12	Y 17 DT, Y 17 DTL	1686		0-N878	TB [DG]	
1.6, 1.6 CNG, 1.6 CNG 16V	10/01-02/12	Z 16 SE, Z 16 YNG	1598		0-N1466	VB [BT]	S
1.7 CDTi 16V	12/04-09/10	Z 17 DTH	1686		0-N1798	VB [BT]	S

COMBO Mk III (D) Kasten/Kombi

1.6 CDTi	11/11-	A 16 FDH, A 16 FDL	1598	24x194	SK-1693	BTK	
1.6 CDTi	11/11-	A 16 FDH, A 16 FDL	1598	24x194	SK-1693AQ1	BTKW	
2.0 CDTi	11/11-	A 20 FD	1956	24x199	SK-1586	BTK	
2.0 CDTi	11/11-	A 20 FD	1956	24x199	SK-1586AQ1	BTKW	
1.4, 1.4 CNG	11/11-	198 A4.000, A 14 FC, 843 A1.000, A 14 FP	1368		0-N195	TB [TE]	
1.6 CDTi	11/11-	A 16 FDH, A 16 FDL	1598		0-N2149	TB [DG]	
2.0 CDTi	11/11-	A 20 FD	1956		0-N2149	TB [DG]	

CORSA Mk I (B)

1.2 i	03/93-09/00	C 12 NZ, X 12 SZ	1195	17x111; mit Zubehör; Baumuster: 73, 78	SK-1162	BTK	
1.2 i	03/93-09/00	C 12 NZ, X 12 SZ	1195	17x111; mit Zubehör	SK-1162AQ1	BTKW	
1.4 i 16V	09/94-09/00	C 14 SEL, X 14 XE	1389	20x169; mit Zubehör	SK-1073	BTK	
1.4 i 16V	09/94-09/00	C 14 SEL, X 14 XE	1389	20x169; mit Zubehör	SK-1073AQ1	BTKW	
1.4 i, 1.4 i S	03/93-09/00	C 14 NZ, X 14 SZ, C 14 SE	1389	17x111; mit Zubehör; Baumuster: 73, 78	SK-1162	BTK	
1.4 i, 1.4 i S	03/93-09/00	C 14 NZ, X 14 SZ, C 14 SE	1389	17x111; mit Zubehör	SK-1162AQ1	BTKW	
1.5 D, 1.5 TD	12/92-12/96	15 D, 15 DT (T4EC1), X 15 DT (T4EC1)	1488	25x136; mit Zubehör	SK-1054	BTK	
1.6 GSI 16V	03/93-09/00	C 16 XE	1598	20x169; 06/1997 →; mit Zubehör	SK-1073	BTK	
1.6 GSI 16V, 1.6 i 16V	03/93-09/00	C 16 SEL, C 16 XE, C 16 XE, X 16 XE	1598	20x169; mit Zubehör	SK-1073AQ1	BTKW	
1.6 i 16V	09/94-09/00	C 16 SEL, C 16 XE, X 16 XE	1598	20x169; mit Zubehör	SK-1073	BTK	
1.7 D	02/96-09/00	17 D (4EE1), X 17 D (4EE1)	1686	25.4x136; R3999999, R4999999, R6999999; mit Zubehör	SK-1164	BTK	
1.7 D	02/96-09/00	17 D (4EE1), X 17 D (4EE1)	1686	25x136; ch.S3000001, S4000001, S6000001→; :→029082; mit Zubehör	SK-1168	BTK	
1.4 i 16V	09/94-09/00	C 14 SEL, X 14 XE	1389		0-N102	TB [TE]	
1.4 i 16V	09/94-09/00	C 14 SEL, X 14 XE	1389		0-N952	TB [DG]	
1.4 i 16V	09/94-09/00	C 14 SEL, X 14 XE	1389		0-N953	TB [DG]	
1.5 D, 1.5 TD	12/92-12/96	15 D, 15 DT (T4EC1), X 15 DT (T4EC1)	1488		0-N878	TB [DG]	
1.5 D, 1.5 TD	12/92-12/96	15 D, 15 DT (T4EC1), X 15 DT (T4EC1)	1488		0-N879	TB [TE]	
1.6 GSI 16V, 1.6 i 16V	03/93-09/00	C 16 XE, C 16 XE, X 16 XE	1598		0-N102	TB [TE]	
1.6 GSI 16V, 1.6 i 16V	03/93-09/00	C 16 XE, C 16 XE, X 16 XE	1598		0-N952	TB [DG]	
1.6 GSI 16V, 1.6 i 16V	03/93-09/00	C 16 XE, C 16 XE, X 16 XE	1598		0-N953	TB [DG]	
1.7 D	02/96-09/00	17 D (4EE1), X 17 D (4EE1)	1686	:855806→	0-N126	TB [TE]	
1.7 D	02/96-09/00	17 D (4EE1), X 17 D (4EE1)	1686		0-N878	TB [DG]	
1.7 D	02/96-09/00	17 D (4EE1), X 17 D (4EE1)	1686	:→855805	0-N910	TB [TE]	
1.0 i 12V	11/96-09/00	X 10 XE	973		0-N2170	VB [BT]	S
1.2 i	03/93-09/00	C 12 NZ, X 12 SZ	1195		0-N948	TB [TE]	
1.2 i 16V	03/98-09/00	X 12 XE	1199		0-N2170	VB [BT]	S
1.4 i 16V	08/97-09/00	C 14 SEL	1389	☼, für Fahrzeuge ohne Servolenkung	0-N1464	VB [BT]	S
1.4 i, 1.4 i 16V, 1.4 i S	03/93-09/00	C 14 NZ, X 14 SZ, C 14 SE, C 14 SEL, X 14 XE	1389	Rippenanzahl: 6	0-N1439	VB [DG]	
1.4 i, 1.4 i 16V, 1.4 i S	03/93-09/00	C 14 NZ, X 14 SZ, C 14 SE, X 14 XE	1389	für Fahrzeuge ohne Servolenkung	0-N1464	VB [BT]	S
1.4 i, 1.4 i S	03/93-09/00	C 14 NZ, X 14 SZ, C 14 SE	1389		0-N948	TB [TE]	
1.5 D, 1.5 TD	12/92-12/96	15 D, 15 DT (T4EC1), X 15 DT (T4EC1)	1488	Rippenanzahl: 6; ☼	0-N1439	VB [DG]	
1.6 GSI 16V, 1.6 i 16V	03/93-09/00	C 16 SEL, C 16 XE, C 16 XE, X 16 XE	1598	Rippenanzahl: 6	0-N1439	VB [DG]	
1.6 GSI 16V, 1.6 i 16V	03/93-09/00	C 16 XE, C 16 XE, X 16 XE	1598	für Fahrzeuge ohne Servolenkung	0-N1464	VB [BT]	S



OPTIMAL®

VAUXHALL



CM³



Art. Nr.



CORSA Mk I (B)							
1.7 D	02/96-09/00	17 D (4EE1), X 17 D (4EE1)	1686	Rippenanzahl: 6; ⚙	0-N1439	VB [DG]	
CORSA Mk II (C) (W5L, F08)							
1.4 16V	09/00-10/06	Z 14 XE	1389	20x162; ⚙:→02NF0884, 20V82069; mit Zubehör	SK-1113	BTK	
1.4 16V	09/00-10/06	Z 14 XE	1389	20x162; mit Zubehör	SK-1355	BTK	
1.4 16V	09/00-10/06	Z 14 XE	1389	20x162; ⚙:02MZ5254, 20U75999→; mit Zubehör	SK-1355AQ2	BTKW	
1.4 16V	09/00-10/06	Z 14 XE	1389	20x162; ⚙:→02MZ5253, 20U75998	SK-1355AQ3	BTKW	
1.6	08/01-10/04	Z 16 SE	1598	17x111; mit Zubehör	SK-1162	BTK	
1.6	08/01-10/04	Z 16 SE	1598	17x111; ⚙:→02MZ5253, 20U75998; mit Zubehör	SK-1162AQ1	BTKW	
1.6 CNG	05/03-10/06	Y 16 YNG, Z 16 YNG	1598	20x162; mit Zubehör	SK-1355	BTK	
1.6 CNG	05/03-10/06	Y 16 YNG, Z 16 YNG	1598	20x162; mit Zubehör	SK-1355AQ2	BTKW	
1.7 CDTI 16V	08/00-09/06	Z 17 DTH	1686	25x131; 11/2003 →; mit Zubehör	SK-1479	BTK	
1.7 DI 16V, 1.7 DTI 16V	08/00-09/06	Y 17 DT, Y 17 DTL	1686	25x131; mit Zubehör	SK-1479	BTK	
1.7 DI 16V, 1.7 DTI 16V	08/00-09/06	Y 17 DT, Y 17 DTL	1686	25x131; ⚙:328704→; mit Zubehör	SK-1481	BTK	
1.7 DI 16V, 1.7 DTI 16V	08/00-09/06	Y 17 DT, Y 17 DTL	1686	25x131; ⚙:→328703	SK-1689	BTK	
1.8 16V	08/00-09/06	Z 18 XE	1796	20x162; ⚙:→02NF0884, 20V82069; mit Zubehör	SK-1113	BTK	
1.8 16V	08/00-09/06	Z 18 XE	1796	20x162; mit Zubehör	SK-1355	BTK	
1.8 16V	08/00-09/06	Z 18 XE	1796	20x162; mit Zubehör	SK-1355AQ1	BTKW	
1.4 16V	09/00-10/06	Z 14 XE	1389		0-N102	TB [TE]	
1.4 16V	09/00-10/06	Z 14 XE	1389	†; mit Anbaumaterial	0-N300	TB [DG]	
1.4 16V	09/00-10/06	Z 14 XE	1389		0-N953	TB [DG]	
1.7 CDTI 16V	08/00-09/06	Z 17 DTH	1686		0-N1085	TB [TE]	
1.7 CDTI 16V, 1.7 DI 16V, 1.7 DTI 16V	08/00-09/06	Y 17 DT, Y 17 DTL, Z 17 DTH	1686		0-N878	TB [DG]	
1.7 DI 16V, 1.7 DTI 16V	08/00-09/06	Y 17 DT, Y 17 DTL	1686	⚙:0328705→	0-N1085	TB [TE]	
1.8 16V	08/00-09/06	Z 18 XE	1796		0-N102	TB [TE]	
1.8 16V	08/00-09/06	Z 18 XE	1796	†; mit Anbaumaterial	0-N300	TB [DG]	
1.8 16V	08/00-09/06	Z 18 XE	1796		0-N953	TB [DG]	
1.0 12V	09/00-10/03	Z 10 XE	973		0-N2170	VB [BT]	S
1.0 12V	11/03-10/06	Z 10 XEP	998		0-N2170	VB [BT]	S
1.2 16V, 1.2 16V Dualfuel	09/00-10/06	Z 12 XE	1199		0-N2170	VB [BT]	S
1.2 Twinport	07/04-10/06	Z 12 XEP	1229		0-N2170	VB [BT]	S
1.3 CDTI 16V	08/00-09/06	Z 13 DT, Z 13 DTJ	1248		0-N1526	VB [BT]	S
1.4 16V	09/00-10/06	Z 14 XE	1389		0-N1466	VB [BT]	S
1.4 Twinport	06/03-10/06	Z 14 XEP	1364		0-N2170	VB [BT]	S
1.6, 1.6 CNG	08/01-10/06	Y 16 YNG, Z 16 YNG, Z 16 SE	1598		0-N1466	VB [BT]	S
1.7 CDTI 16V	08/00-09/06	Z 17 DTH	1686		0-N1798	VB [BT]	S
1.8 16V	08/00-09/06	Z 18 XE	1796		0-N1466	VB [BT]	S
CORSA Mk III (D) (L_8)							
1.6 SRi, 1.6 VXR	02/07-08/14	A 16 LEL, A 16 LEL, A 16 LER, Z 16 LER	1598	24x146	SK-1607	BTK	
1.6 VXR	06/11-08/14	A 16 LES, Z 16 LER	1598	24x146; → 12/2011	SK-1607	BTK	
1.7 CDTI	11/06-08/14	A 17 DTS	1686	25x131; 03/2007 →; mit Zubehör	SK-1481	BTK	
1.7 CDTI	11/06-08/14	Z 17 DTR, Z 17 DTR	1686	25x131; mit Zubehör	SK-1481	BTK	
1.6 SRi, 1.6 VXR	02/07-08/14	A 16 LEL, A 16 LEL, A 16 LER, Z 16 LER	1598		0-N1347	TB [TE]	
1.7 CDTI	11/06-08/14	A 17 DTS, Z 17 DTR, Z 17 DTR	1686		0-N1085	TB [TE]	
1.7 CDTI	11/06-08/14	A 17 DTS, Z 17 DTR, Z 17 DTR	1686		0-N878	TB [DG]	
1.0, 1.0 i 12V	11/06-08/14	A 10 XEP, A 10 XEP, Z 10 XEP	998		0-N2170	VB [BT]	S
1.2, 1.2 i 16V, 1.2 LPG	11/06-08/14	A 12 XER, Z 12 XEP	1229		0-N2170	VB [BT]	S
1.3 CDTI	07/06-08/14	A 13 DTC, Z 13 DTJ, A 13 DTE, A 13 DTR, A 13 DTR, Z 13 DTE, Z 13 DTH	1248		0-N1526	VB [BT]	S
1.4	07/06-08/14	A 14 NEL, Z 14 XEP	1364		0-N2170	VB [BT]	S
1.4, 1.4 LPG	09/09-08/14	A 14 XEL, A 14 XER	1398		0-N2170	VB [BT]	S
1.6 SRi, 1.6 VXR	02/07-08/14	A 16 LEL, A 16 LEL, A 16 LER, Z 16 LER	1598		0-N1799	VB [BT]	S
1.7 CDTI	11/06-08/14	Z 17 DTR, Z 17 DTR	1686		0-N1798	VB [BT]	S
1.7 CDTI	11/06-08/14	A 17 DTS	1686	⚙	0-N2341	VB [DG]	
1.7 CDTI	11/06-08/14	A 17 DTS	1686		0-N2389	VB [BT]	S
CORSAVAN Mk I (B)							
1.4 i	01/94-09/00	C 14 NZ	1389	17x111; mit Zubehör	SK-1162	BTK	
1.4 i	01/94-09/00	C 14 NZ	1389	17x111; mit Zubehör	SK-1162AQ1	BTKW	
1.5 D	08/94-12/95	15 D	1488	25x136; mit Zubehör	SK-1054	BTK	
1.7 D	01/94-09/00	17 D (4EE1), X 17 D (4EE1)	1686	25.4x136; R3999999, R4999999, R6999999; 03/1996 →; mit Zubehör	SK-1164	BTK	



CM³



Art. Nr.



CORSAVAN Mk I (B)							
1.7 D	01/94-09/00	17 D (4EE1), X 17 D (4EE1)	1686	25x136; ch.S3000001, S4000001, S6000001→; 03/1996 →; :→029082; mit Zubehör	SK-1168	BTK	
1.7 D	01/94-09/00	17 D (4EE1), X 17 D (4EE1)	1686	:855806→	0-N126	TB [TE]	
1.7 D	01/94-09/00	17 D (4EE1), X 17 D (4EE1)	1686		0-N878	TB [DG]	
1.7 D	01/94-09/00	17 D (4EE1), X 17 D (4EE1)	1686	:→855805	0-N910	TB [TE]	
1.4 i	01/94-09/00	C 14 NZ	1389	Rippenanzahl: 6	0-N1439	VB [DG]	
1.4 i	01/94-09/00	C 14 NZ	1389	für Fahrzeuge ohne Servolenkung	0-N1464	VB [BT]	S
1.4 i	01/94-09/00	C 14 NZ	1389		0-N948	TB [TE]	
1.5 D	08/94-12/95	15 D	1488	Rippenanzahl: 6;	0-N1439	VB [DG]	
1.7 D	01/94-09/00	17 D (4EE1), X 17 D (4EE1)	1686	Rippenanzahl: 6;	0-N1439	VB [DG]	

CORSAVAN Mk II (C)							
1.7 DI 16V, 1.7 DTI 16V	09/00-06/06	Y 17 DT, Y 17 DTL	1686	25x131; mit Zubehör	SK-1479	BTK	
1.7 DI 16V, 1.7 DTI 16V	09/00-06/06	Y 17 DT, Y 17 DTL	1686	25x131; :328704→; mit Zubehör	SK-1481	BTK	
1.7 DI 16V, 1.7 DTI 16V	09/00-06/06	Y 17 DT, Y 17 DTL	1686	25x131; :→328703	SK-1689	BTK	
1.7 DI 16V, 1.7 DTI 16V	09/00-06/06	Y 17 DT, Y 17 DTL	1686	:0328705→	0-N1085	TB [TE]	
1.7 DI 16V, 1.7 DTI 16V	09/00-06/06	Y 17 DT, Y 17 DTL	1686		0-N878	TB [DG]	
1.2 16V, 1.2 16V Dualfuel	09/00-06/06	Z 12 XE	1199		0-N2170	VB [BT]	S
1.3 CDTI 16V	04/04-06/06	Z 13 DT	1248		0-N1526	VB [BT]	S
1.4	11/03-06/06	Z 14 XEP	1364		0-N2170	VB [BT]	S

CORSAVAN Mk III (D)							
1.2	01/10-	A 12 XEL	1229		0-N2170	VB [BT]	S
1.3 CDTI	07/06-	A 13 DTC, Z 13 DTJ, A 13 DTE, A 13 DTR, B 13 DTR, Z 13 DTE, Z 13 DTH	1248		0-N1526	VB [BT]	S

FRONTERA Mk I (A)							
2.0	04/95-08/98	C 20 NE	1998	20x111; :→14608700	R-1072AQ1	BTKW	
2.0	04/95-08/98	X 20 SE	1998	20x146	SK-1169	BTK	
2.0	04/95-08/98	C 20 NE	1998	20x146; :14608701→	SK-1169	BTK	
2.0	04/95-08/98	X 20 SE	1998	20x146	SK-1169AQ1	BTKW	
2.0	04/95-08/98	C 20 NE	1998	20x146; :14608701→	SK-1169AQ1	BTKW	
2.2 i	03/95-10/98	X 22 XE	2198	24x171; ch.→TV899999; → 08/1996	SK-1166	BTK	
2.2 i	03/95-10/98	X 22 XE	2198	24x171; ch.VV600001→; 08/1996 →; Baumuster: 54MWL4	SK-1644	BTK	
2.2 i	03/95-10/98	X 22 XE	2198	24x171; ch.VV600001→; 08/1996 →	SK-1644AQ1	BTKW	
2.8 TD	01/95-12/96	28 TDI (4JB1T)	2771	32x119	SK-1260	BTK	
2.0	04/95-08/98	X 20 SE	1998		0-N101	TB [TE]	
2.0	04/95-08/98	C 20 NE	1998	:14608701→	0-N101	TB [TE]	
2.2 i	03/95-10/98	X 22 XE	2198	für Fahrzeuge ohne Katalysator	0-N100	TB [TE]	
2.2 i	03/95-10/98	X 22 XE	2198	für Fahrzeuge mit Katalysator	0-N1383	TB [TE]	
2.2 i	03/95-10/98	X 22 XE	2198		0-N906	TB [DG]	

FRONTERA Mk I (A) Sport							
2.0 i	03/92-10/98	C 20 NE	1998	20x111; :→14608700	R-1072AQ1	BTKW	
2.0 i	03/92-10/98	X 20 SE	1998	20x146	SK-1169	BTK	
2.0 i	03/92-10/98	C 20 NE	1998	20x146; :14608701→	SK-1169	BTK	
2.0 i	03/92-10/98	X 20 SE	1998	20x146	SK-1169AQ1	BTKW	
2.0 i	03/92-10/98	C 20 NE	1998	20x146; :14608701→	SK-1169AQ1	BTKW	
2.8 TD	01/95-12/96	28 TDI (4JB1T)	2771	32x119	SK-1260	BTK	
2.0 i	03/92-10/98	C 20 NE, X 20 SE	1998		0-N101	TB [TE]	

FRONTERA Mk II (B)							
2.2 i	10/98-10/04	X 22 SE, Y 22 SE	2198	24x171; Baumuster: 6B_	SK-1644	BTK	
2.2 i	10/98-10/04	X 22 SE, Y 22 SE	2198	24x171	SK-1644AQ1	BTKW	
2.2 i	10/98-10/04	X 22 SE, Y 22 SE	2198		0-N1383	TB [TE]	
2.2 i	10/98-10/04	X 22 SE, Y 22 SE	2198		0-N906	TB [DG]	
2.2 DTI	10/98-09/04	X 22 DTH, Y 22 DTH	2171		0-N1485	VB [BT]	S
2.2 DTI	10/98-09/04	X 22 DTH, Y 22 DTH	2171		0-N2169	VB [VD]	

INSIGNIA							
1.3 VVTI, 1.6 CNG, 2.0 CDTI, 2.0 CDTI 4x4	07/08-	A 20 DTE, A 20 DTH, A 20 DTJ	1956	24x199	SK-1586	BTK	
1.3 VVTI, 1.6 CNG, 2.0 CDTI, 2.0 CDTI 4x4	07/08-	A 20 DTC, A 20 DTE, A 20 DTH, A 20 DTJ	1956	24x199	SK-1586AQ1	BTKW	
1.6, 1.6 Turbo	07/08-	A 16 LET, A 16 XER	1598	24x146	SK-1607	BTK	
1.8	07/08-	A 18 XER, B 18 XER	1796	24x146	SK-1607	BTK	
2.0 CDTI	07/08-	A 20 DTC	1956	24x199; → 06/2010	SK-1586	BTK	
1.6, 1.6 Turbo	07/08-	A 16 LET, A 16 XER	1598		0-N1347	TB [TE]	
1.8	07/08-	A 18 XER, B 18 XER	1796		0-N1347	TB [TE]	



OPTIMAL®

VAUXHALL



CM³



Art. Nr.



INSIGNIA

2.0 Biturbo CDTI, 2.0 Biturbo CDTI 4x4, 2.0 CDTI, 2.0 CDTI 4x4	10/08-	A 20 DTR	1956		0-N2236	TB [DG]	
2.0 Biturbo CDTI, 2.0 Biturbo CDTI 4x4, 2.0 CDTI, 2.0 CDTI 4x4, 2.4	07/08-	A 20 DTC, A 20 DTH, A 20 DTJ, A 20 DTR	1956		0-N2149	TB [DG]	
2.0 CDTI, 2.0 CDTI 4x4	07/08-	A 20 DTH, A 20 DTJ	1956		0-N115	TB [TE]	
1.4	04/11-	A 14 NET, B 14 NET	1364		0-N2170	VB [BT]	S
1.6, 1.6 Turbo	07/08-	A 16 LET, A 16 XER	1598		0-N1799	VB [BT]	S
1.8	07/08-	A 18 XER, B 18 XER	1796		0-N1799	VB [BT]	S
2.0 Biturbo CDTI, 2.0 Biturbo CDTI 4x4, 2.0 CDTI, 2.0 CDTI 4x4	07/08-	A 20 DTC, A 20 DTH, A 20 DTJ, A 20 DTR	1956		0-N2087	VB [BT]	S
2.0 Biturbo CDTI, 2.0 Biturbo CDTI 4x4, 2.0 CDTI, 2.0 CDTI 4x4	07/08-	A 20 DTC, A 20 DTH, A 20 DTJ, A 20 DTR	1956		0-N2221	VB [DG]	
2.0 Biturbo CDTI, 2.0 Biturbo CDTI 4x4, 2.0 CDTI, 2.0 CDTI 4x4	07/08-	A 20 DTC, A 20 DTH, A 20 DTJ, A 20 DTR	1956	für Fahrzeuge mit elektrischer Servolenkung	0-N2254	VB [DG]	
2.0 Biturbo CDTI, 2.0 Biturbo CDTI 4x4, 2.0 CDTI, 2.0 CDTI 4x4, 2.4	07/08-	A 20 DTC, A 20 DTH, A 20 DTJ, A 20 DTR	1956		0-N1649	VB [DG]	
2.0 CDTI	10/08-	A 20 DTR	1956	11/2008 →	0-N2087	VB [BT]	S
2.0 Turbo, 2.0 Turbo 4x4	07/08-	A 20 NFT, A 20 NHT	1998		0-N2283	VB [DG]	
2.0 Turbo, 2.0 Turbo 4x4	07/08-	A 20 NFT, A 20 NHT	1998		0-N2299	VB [BT]	S
2.8 V6 Turbo 4x4, 2.8 VXR	07/08-	A 28 NER, A 28 NET	2792		0-N2194	VB [BT]	S
2.8 V6 Turbo 4x4, 2.8 VXR	07/08-	A 28 NER, A 28 NET	2792		0-N2340	VB [DG]	

INSIGNIA Sedan

1.6, 1.6 Turbo	07/08-	A 16 LET, A 16 XER	1598	24x146	SK-1607	BTK	
1.8	07/08-09/13	A 18 XER, B 18 XER	1796	24x146	SK-1607	BTK	
2.0 CDTI, 2.0 CDTI 4x4	07/08-	A 20 DTC, A 20 DTH, A 20 DTJ	1956	24x199	SK-1586	BTK	
2.0 CDTI, 2.0 CDTI 4x4	07/08-	A 20 DTC, A 20 DTH, A 20 DTJ	1956	24x199	SK-1586AQ1	BTKW	
1.6, 1.6 Turbo	07/08-	A 16 LET, A 16 XER	1598		0-N1347	TB [TE]	
1.8	07/08-09/13	A 18 XER, B 18 XER	1796		0-N1347	TB [TE]	
2.0 Biturbo CDTI, 2.0 Biturbo CDTI 4x4, 2.0 CDTI, 2.0 CDTI 4x4	11/08-	A 20 DTR	1956		0-N2236	TB [DG]	
2.0 Biturbo CDTI, 2.0 Biturbo CDTI 4x4, 2.0 CDTI, 2.0 CDTI 4x4, 2.5 TDdi 4x4	07/08-	A 20 DTC, A 20 DTH, A 20 DTJ, A 20 DTR	1956		0-N2149	TB [DG]	
2.0 CDTI, 2.0 CDTI 4x4	07/08-	A 20 DTH, A 20 DTJ	1956		0-N115	TB [TE]	
2.5 TDdi 4x4	07/13-	A 20 DTH	1956	Nockenwelle: SOHC/OHC	0-N2225	TB [TE]	
1.3	07/13-	A 20 DTE	1956		0-N2229	VB [TE]	
1.4	04/11-	A 14 NET	1364		0-N2170	VB [BT]	S
1.6, 1.6 Turbo	07/08-	A 16 LET, A 16 XER	1598		0-N1799	VB [BT]	S
1.8	07/08-09/13	A 18 XER, B 18 XER	1796		0-N1799	VB [BT]	S
2.0 Biturbo CDTI, 2.0 Biturbo CDTI 4x4, 2.0 CDTI, 2.0 CDTI 4x4	07/08-	A 20 DTC, A 20 DTH, A 20 DTJ, A 20 DTR	1956		0-N2087	VB [BT]	S
2.0 Biturbo CDTI, 2.0 Biturbo CDTI 4x4, 2.0 CDTI, 2.0 CDTI 4x4	07/08-	A 20 DTC, A 20 DTH, A 20 DTJ, A 20 DTR	1956		0-N2221	VB [DG]	
2.0 Biturbo CDTI, 2.0 Biturbo CDTI 4x4, 2.0 CDTI, 2.0 CDTI 4x4	07/08-	A 20 DTC, A 20 DTH, A 20 DTJ, A 20 DTR	1956	für Fahrzeuge mit elektrischer Servolenkung	0-N2254	VB [DG]	
2.0 Biturbo CDTI, 2.0 Biturbo CDTI 4x4, 2.0 CDTI, 2.0 CDTI 4x4, 2.5 TDdi 4x4	07/08-	A 20 DTH, A 20 DTJ, A 20 DTR	1956		0-N1649	VB [DG]	
2.0 CDTI	07/08-	A 20 DTC	1956		0-N1649	VB [DG]	
2.0 Turbo, 2.0 Turbo 4x4	07/08-	A 20 NFT, A 20 NHT	1998		0-N2283	VB [DG]	
2.0 Turbo, 2.0 Turbo 4x4	07/08-	A 20 NFT, A 20 NHT	1998		0-N2299	VB [BT]	S
2.8 V6 Turbo 4x4, 2.8 VXR	07/08-	A 28 NER, A 28 NET	2792		0-N2194	VB [BT]	S
2.8 V6 Turbo 4x4, 2.8 VXR	07/08-	A 28 NER, A 28 NET	2792		0-N2340	VB [DG]	

INSIGNIA Estate

1.6, 1.6 Turbo	07/08-	A 16 LET, A 16 XER	1598	24x146	SK-1607	BTK	
1.8	07/08-	A 18 XER, B 18 XER	1796	24x146	SK-1607	BTK	
2.0 4WD, 2.0 CDTI, 2.0 CDTI 4x4, 3.0, 3.0 TDCi 4x4	07/08-	A 20 DTE, A 20 DTH, A 20 DTJ	1956	24x199	SK-1586	BTK	
2.0 4WD, 2.0 CDTI, 2.0 CDTI 4x4, 3.0, 3.0 TDCi 4x4	07/08-	A 20 DTC, A 20 DTE, A 20 DTH, A 20 DTJ	1956	24x199	SK-1586AQ1	BTKW	
2.0 CDTI	07/08-	A 20 DTC	1956	24x199; → 06/2010	SK-1586	BTK	
1.6, 1.6 Turbo	07/08-	A 16 LET, A 16 XER	1598		0-N1347	TB [TE]	
1.8	07/08-	A 18 XER, B 18 XER	1796		0-N1347	TB [TE]	
2.0 Biturbo CDTI, 2.0 Biturbo CDTI 4x4, 2.0 CDTI 4x4	05/09-	A 20 DTR	1956		0-N2236	TB [DG]	
2.0 Biturbo CDTI, 2.0 Biturbo CDTI 4x4, 2.0 CDTI, 2.0 CDTI 4x4, 3.0	07/08-	A 20 DTC, A 20 DTH, A 20 DTJ, A 20 DTR	1956		0-N2149	TB [DG]	
2.0 CDTI, 2.0 CDTI 4x4	07/08-	A 20 DTH, A 20 DTJ	1956		0-N115	TB [TE]	
1.4	04/11-	A 14 NET, B 14 NET	1364		0-N2170	VB [BT]	S
1.6, 1.6 Turbo	07/08-	A 16 LET, A 16 XER	1598		0-N1799	VB [BT]	S
1.8	07/08-	A 18 XER, B 18 XER	1796		0-N1799	VB [BT]	S



CM³



Art. Nr.



ohne Halter

INSIGNIA Estate								
2.0 Biturbo CDTi, 2.0 Biturbo CDTi 4x4, 2.0 CDTi, 2.0 CDTi 4x4	07/08-	A 20 DTC, A 20 DTH, A 20 DTJ, A 20 DTR	1956			0-N2087	VB [BT]	S
2.0 Biturbo CDTi, 2.0 Biturbo CDTi 4x4, 2.0 CDTi, 2.0 CDTi 4x4	07/08-	A 20 DTC, A 20 DTH, A 20 DTJ, A 20 DTR	1956			0-N2221	VB [DG]	
2.0 Biturbo CDTi, 2.0 Biturbo CDTi 4x4, 2.0 CDTi, 2.0 CDTi 4x4	07/08-	A 20 DTC, A 20 DTH, A 20 DTJ, A 20 DTR	1956	für Fahrzeuge mit elektrischer Servolenkung		0-N2254	VB [DG]	
2.0 Biturbo CDTi, 2.0 Biturbo CDTi 4x4, 2.0 CDTi, 2.0 CDTi 4x4, 3.0	07/08-	A 20 DTC, A 20 DTH, A 20 DTJ, A 20 DTR	1956			0-N1649	VB [DG]	
2.0 Turbo, 2.0 Turbo 4x4	07/08-	A 20 NFT, A 20 NHT	1998			0-N2283	VB [DG]	
2.0 Turbo, 2.0 Turbo 4x4	07/08-	A 20 NFT, A 20 NHT	1998			0-N2299	VB [BT]	S
2.8 V6 Turbo, 2.8 VXR	08/08-	A 28 NER, A 28 NET	2792			0-N2194	VB [BT]	S
2.8 V6 Turbo, 2.8 VXR	08/08-	A 28 NER, A 28 NET	2792			0-N2340	VB [DG]	
MERIVA Mk I (A)								
1.6 i	01/03-06/10	Z 16 SE	1598	17x111; 06/2003 →; mit Zubehör		SK-1162	BTK	
1.6 i	01/03-06/10	Z 16 SE	1598	17x111		SK-1162AQ2	BTKW	
1.6 i 16V	01/03-09/05	Z 16 XE	1598	20x162; mit Zubehör		SK-1355	BTK	
1.6 i 16V	01/03-09/05	Z 16 XE	1598	20x162; mit Zubehör		SK-1355AQ2	BTKW	
1.6 i 16V Twinport	05/03-06/10	Z 16 XEP	1598	24x146; 04/2006 →		SK-1607	BTK	
1.6 Turbo	05/06-06/10	Z 16 LET	1598	24x146		SK-1607	BTK	
1.7 CDTi	08/06-06/10	Z 17 DTR	1686	25x131; mit Zubehör		SK-1481	BTK	
1.7 CDTi 16V, 1.7 DTi 16V	06/03-06/10	Y 17 DT, Z 17 DTH	1686	25x131; mit Zubehör		SK-1479	BTK	
1.7 CDTi 16V, 1.7 DTi 16V	06/03-06/10	Y 17 DT, Z 17 DTH	1686	25x131; →:328704→; mit Zubehör		SK-1481	BTK	
1.7 DTi 16V	06/03-06/10	Y 17 DT	1686	25x131; →:328703		SK-1689	BTK	
1.8 i 16V	05/03-08/05	Z 18 XE	1796	20x162; mit Zubehör		SK-1355	BTK	
1.8 i 16V	05/03-08/05	Z 18 XE	1796	20x162; mit Zubehör		SK-1355AQ1	BTKW	
1.8 i 16V	05/03-08/05	Z 18 XE	1796	20x162; mit Zubehör		SK-1355AQ2	BTKW	
1.6 i 16V	01/03-09/05	Z 16 XE	1598			0-N102	TB [TE]	
1.6 i 16V	01/03-09/05	Z 16 XE	1598	‡; mit Anbaumaterial		0-N300	TB [DG]	
1.6 i 16V	01/03-09/05	Z 16 XE	1598			0-N953	TB [DG]	
1.6 i 16V Twinport, 1.6 Turbo	05/03-06/10	Z 16 LET, Z 16 XEP	1598			0-N1347	TB [TE]	
1.6 i 16V Twinport, 1.6 Turbo	05/03-06/10	Z 16 LET, Z 16 XEP	1598			0-N1348	TB [DG]	
1.7 CDTi, 1.7 CDTi 16V	09/03-06/10	Z 17 DTH, Z 17 DTR	1686			0-N878	TB [DG]	
1.7 CDTi, 1.7 CDTi 16V, 1.7 DTi 16V	06/03-06/10	Y 17 DT, Z 17 DTH, Z 17 DTR	1686			0-N1085	TB [TE]	
1.8 i 16V	05/03-08/05	Z 18 XE	1796			0-N102	TB [TE]	
1.8 i 16V	05/03-08/05	Z 18 XE	1796	‡; mit Anbaumaterial		0-N300	TB [DG]	
1.8 i 16V	05/03-08/05	Z 18 XE	1796			0-N953	TB [DG]	
1.3 CDTi	01/03-10/09	Z 13 DTJ	1248			0-N1526	VB [BT]	S
1.4 16V Twinport	01/03-10/09	Z 14 XEP	1364			0-N2170	VB [BT]	S
1.6 i	01/03-06/10	Z 16 SE	1598			0-N948	TB [TE]	
1.6 i 16V Twinport, 1.6 Turbo	05/03-06/10	Z 16 LET, Z 16 XEP	1598			0-N1799	VB [BT]	S
1.6 i, 1.6 i 16V	01/03-06/10	Z 16 SE, Z 16 XE	1598			0-N1466	VB [BT]	S
1.7 CDTi 16V	09/03-08/05	Z 17 DTH	1686			0-N1798	VB [BT]	S
1.8 i 16V	05/03-08/05	Z 18 XE	1796			0-N1466	VB [BT]	S
MERIVA Mk II (B)								
1.7 CDTi	06/10-	A 17 DTC, A 17 DTI, A 17 DTS	1686	25x131; mit Zubehör		SK-1481	BTK	
1.7 CDTi	06/10-	A 17 DT, A 17 DTC, A 17 DTI, A 17 DTS	1686			0-N1085	TB [TE]	
1.7 CDTi	06/10-	A 17 DT, A 17 DTC, A 17 DTI, A 17 DTS	1686			0-N878	TB [DG]	
1.3 CDTi	06/10-	A 13 DTC, A 13 DTE	1248			0-N1526	VB [BT]	S
1.4	06/10-	A 14 XER, B 14 XER	1398			0-N2170	VB [BT]	S
1.4, 1.4 LPG	06/10-	A 14 NEL, B 14 NEL, A 14 NET, B 14 NET	1364			0-N2170	VB [BT]	S
1.6 CDTi, 1.6 CDTi ecoFLEX	11/13-	B 16 DTC, B 16 DTE, B 16 DTL, B 16 DTN, B 16 DTH	1598	☼		0-N1649	VB [DG]	
1.7 CDTi	06/10-	A 17 DT, A 17 DTC, A 17 DTI, A 17 DTS	1686	☼		0-N2341	VB [DG]	
1.7 CDTi	06/10-	A 17 DT, A 17 DTC, A 17 DTI, A 17 DTS	1686			0-N2389	VB [BT]	S
MOKKA								
1.6	06/12-	A 16 XER, B 16 XER	1598	24x146		SK-1607	BTK	
1.6	06/12-	A 16 XER, B 16 XER	1598			0-N1347	TB [TE]	
1.7 CDTi, 1.7 CDTi 4x4	06/12-	A 17 DTS	1686			0-N1085	TB [TE]	
1.7 CDTi, 1.7 CDTi 4x4	06/12-	A 17 DTS	1686			0-N878	TB [DG]	
1.4 4x4	06/12-	A 14 NET, B 14 NET	1364			0-N2170	VB [BT]	S
1.6	06/12-	A 16 XER, B 16 XER	1598			0-N1799	VB [BT]	S
1.6 CDTi, 1.6 CDTi 4x4	01/15-	B 16 DTH	1598	☼		0-N1649	VB [DG]	
1.7 CDTi, 1.7 CDTi 4x4	06/12-	A 17 DTS	1686	☼		0-N2341	VB [DG]	
1.7 CDTi, 1.7 CDTi 4x4	06/12-	A 17 DTS	1686			0-N2389	VB [BT]	S



OPTIMAL®

VAUXHALL



CM³



Art. Nr.



MONTEREY								
3.1 TD	09/91-07/98	4 JG2TC	3059	32x119; 05/1994 →		SK-1260	BTK	
3.2	06/92-07/98	6 VD1	3165			0-N1768	TB [BT]	
3.2	06/92-07/98	6 VD1	3165			0-N2167	TB [DG]	
MONTEREY Mk II								
3.0 DTI	07/98-08/99	4 JX1	2999			0-N2168	TB [TE]	
MOVANO Mk I (A) Chassis/Cab (ED, UD, HD)								
2.2 DTI	09/00-05/10	G9T 720, G9T 722, G9T 750	2188	25x89; mit Zubehör		SK-1489	BTK	
2.5 CDTI	04/04-05/10	G9U 650	2463	25x89; 09/2006 →; mit Zubehör		SK-1489	BTK	
2.5 CDTI	08/06-05/10	G9U 632, G9U 650	2463	25x89; mit Zubehör		SK-1489	BTK	
2.5 CDTI	08/06-05/10	G9U 650	2463	25x89; mit Zubehör		SK-1489	BTK	
2.5 D	10/98-01/01	S8U 770	2499	30x152		SK-1035	BTK	
2.5 D	10/98-01/01	S8U 770	2499	30x152; mit Spanndämpfer, Spannrolle		SK-1680	BTK	
2.5 DTI	10/01-05/10	G9U 720	2463	25x89; mit Zubehör		SK-1489	BTK	
2.8 DTI	10/98-10/01	S9W 702	2799	30x154		SK-1153	BTK	
2.8 DTI	10/98-10/01	S9W 702	2799	mit Spanndämpfer, Spannrolle		SK-1681	BTK	
2.2 DTI	09/00-05/10	G9T 720, G9T 722, G9T 750	2188			0-N1269	TB [TE]	
2.2 DTI	09/00-05/10	G9T 720, G9T 722, G9T 750	2188			0-N1270	TB [DG]	
2.5 CDTI, 2.5 DTI	10/01-05/10	G9U 632, G9U 650, G9U 632, G9U 650, G9U 650, G9U 650, G9U 754, G9U 720, G9U 724, G9U 750, G9U 754	2463			0-N1269	TB [TE]	
2.5 CDTI, 2.5 DTI	10/01-05/10	G9U 632, G9U 650, G9U 632, G9U 650, G9U 650, G9U 650, G9U 754, G9U 720, G9U 724, G9U 750, G9U 754	2463			0-N1270	TB [DG]	
2.5 D	10/98-01/01	S8U 770	2499			0-N1617	TB [BT]	
2.5 D	10/98-01/01	S8U 770	2499			0-N816	TB [DG]	
2.5 D	10/98-01/01	S8U 770	2499			0-N821	TB [DG]	
2.8 DTI	10/98-10/01	S9W 702	2799			0-N1617	TB [BT]	
2.8 DTI	10/98-10/01	S9W 702	2799			0-N816	TB [DG]	
2.2 DTI	09/00-05/10	G9T 720, G9T 722, G9T 750	2188			0-N1409	VB [DG]	
2.2 DTI	09/00-05/10	G9T 720, G9T 722, G9T 750	2188	Rippenanzahl: 6; ☼		0-N1648	VB [DG]	
2.2 DTI	09/00-05/10	G9T 720, G9T 722, G9T 750	2188	☼		0-N1731	VB [BT]	S
2.5 CDTI, 2.5 DTI	10/01-05/10	G9U 632, G9U 650, G9U 632, G9U 650, G9U 650, G9U 650, G9U 754, G9U 720, G9U 724, G9U 750, G9U 754	2463			0-N1409	VB [DG]	
2.5 CDTI, 2.5 DTI	10/01-05/10	G9U 650, G9U 754, G9U 720, G9U 724, G9U 750, G9U 754	2463	Rippenanzahl: 6; ☼		0-N1648	VB [DG]	
2.5 CDTI, 2.5 DTI	10/01-05/10	G9U 632, G9U 650, G9U 632, G9U 650, G9U 650, G9U 650, G9U 754, G9U 720, G9U 724, G9U 750, G9U 754	2463	☼		0-N1731	VB [BT]	S
MOVANO Mk I (A) Combi (JD)								
1.9 DTI	09/00-10/01	F9Q 770	1870	26x153; beinhaltetete Rollen: 4; mit Zahnrad; mit Zubehör		SK-1490	BTK	
1.9 DTI	10/01-05/10	F9Q 774	1870	26x132; 10/2003 →		SK-1493	BTK	
1.9 DTI	10/01-05/10	F9Q 774	1870	26x132		SK-1493AQ1	BTKW	
1.9 DTI	10/01-05/10	F9Q 774	1870	26x132		SK-1493AQ2	BTKW	
2.2 DTI	09/00-05/10	G9T 720, G9T 750	2188	25x89; mit Zubehör		SK-1489	BTK	
2.5 CDTI	10/01-08/09	G9U 650, G9U 754	2463	25x89; 09/2006 →; mit Zubehör		SK-1489	BTK	
2.5 CDTI	02/03-08/09	G9U 632, G9U 650	2464	25x89; 10/2006 →; mit Zubehör		SK-1489	BTK	
2.5 CDTI	08/06-05/10	G9U 632	2464	25x89; mit Zubehör		SK-1489	BTK	
2.5 D	10/98-09/00	S8U 770	2499	30x152		SK-1035	BTK	
2.5 D	10/98-09/00	S8U 770	2499	30x152; 11/1998 →; mit Spanndämpfer, Spannrolle		SK-1680	BTK	
2.5 DTI	10/01-08/09	G9U 720, G9U 750, G9U 754	2463	25x89; 09/2002 →; mit Zubehör		SK-1489	BTK	
2.8 DTI	10/98-10/01	S9W 702	2799	30x154		SK-1153	BTK	
2.8 DTI	10/98-10/01	S9W 702	2799	mit Spanndämpfer, Spannrolle		SK-1681	BTK	
1.9 DTI	09/00-10/01	F9Q 770	1870			0-N147	TB [DG]	
1.9 DTI	10/01-05/10	F9Q 774	1870	mit Grundträger		0-N1173	TB [BT]	
2.2 DTI	09/00-05/10	G9T 720, G9T 750	2188			0-N1269	TB [TE]	
2.2 DTI	09/00-05/10	G9T 720, G9T 750	2188			0-N1270	TB [DG]	
2.5 CDTI	02/03-05/10	G9U 632, G9U 632, G9U 650	2464			0-N1269	TB [TE]	
2.5 CDTI	02/03-05/10	G9U 632, G9U 632, G9U 650	2464			0-N1270	TB [DG]	
2.5 CDTI, 2.5 DTI	10/01-08/09	G9U 650, G9U 754, G9U 720, G9U 750, G9U 754	2463			0-N1269	TB [TE]	
2.5 CDTI, 2.5 DTI	10/01-08/09	G9U 650, G9U 754, G9U 720, G9U 750, G9U 754	2463			0-N1270	TB [DG]	
2.5 D	10/98-09/00	S8U 770	2499			0-N1617	TB [BT]	
2.5 D	10/98-09/00	S8U 770	2499			0-N816	TB [DG]	



CM³



Art. Nr.



ohne Halter

MOVANO Mk I (A) Combi (JD)							
2.5 D	10/98-09/00	S8U 770	2499			0-N821	TB [DG]
2.8 DTI	10/98-10/01	S9W 702	2799			0-N1617	TB [BT]
2.8 DTI	10/98-10/01	S9W 702	2799			0-N816	TB [DG]
1.9 DTI	10/01-05/10	F9Q 774	1870	:C029794→;		0-N1409	VB [DG]
1.9 DTI	10/01-05/10	F9Q 774	1870			0-N1611	VB [BT] S
2.2 DTI	09/00-05/10	G9T 720, G9T 750	2188			0-N1409	VB [DG]
2.2 DTI	09/00-05/10	G9T 720, G9T 750	2188	Rippenanzahl: 6;		0-N1648	VB [DG]
2.2 DTI	09/00-05/10	G9T 720, G9T 750	2188			0-N1731	VB [BT] S
2.5 CDTI	02/03-05/10	G9U 632, G9U 632, G9U 650	2464			0-N1409	VB [DG]
2.5 CDTI	02/03-05/10	G9U 632, G9U 632, G9U 650	2464			0-N1731	VB [BT] S
2.5 CDTI, 2.5 DTI	10/01-08/09	G9U 650, G9U 754, G9U 720, G9U 750, G9U 754	2463			0-N1409	VB [DG]
2.5 CDTI, 2.5 DTI	10/01-08/09	G9U 650, G9U 754, G9U 720, G9U 750, G9U 754	2463	Rippenanzahl: 6;		0-N1648	VB [DG]
2.5 CDTI, 2.5 DTI	10/01-08/09	G9U 650, G9U 754, G9U 720, G9U 750, G9U 754	2463			0-N1731	VB [BT] S
MOVANO Mk I (A) Van (FD)							
1.9 DTI	09/00-10/01	F9Q 770	1870	26x153; beinhalten Rollen: 4; mit Zahnrad; mit Zubehör		SK-1490	BTK
1.9 DTI	10/01-05/10	F9Q 774	1870	26x132; 10/2003 →		SK-1493	BTK
1.9 DTI	10/01-05/10	F9Q 774	1870	26x132		SK-1493AQ1	BTKW
1.9 DTI	10/01-05/10	F9Q 774	1870	26x132		SK-1493AQ2	BTKW
2.2 DTI	09/00-05/10	G9T 720, G9T 722, G9T 750	2188	25x89; mit Zubehör		SK-1489	BTK
2.5 CDTI	04/04-05/10	G9U 650, G9U 754	2463	25x89; 09/2006 →; mit Zubehör		SK-1489	BTK
2.5 CDTI	08/06-05/10	G9U 632, G9U 632, G9U 650	2464	25x89; mit Zubehör		SK-1489	BTK
2.5 D	10/98-09/00	S8U 770	2499	30x152		SK-1035	BTK
2.5 D	10/98-09/00	S8U 770	2499	30x152; 12/1999 →; mit Spanndämpfer, Spannrolle		SK-1680	BTK
2.5 DTI	10/01-05/10	G9U 720, G9U 724, G9U 750, G9U 754	2463	25x89; mit Zubehör		SK-1489	BTK
2.8 TDI	10/98-10/01	S9W 702	2799	30x154		SK-1153	BTK
2.8 TDI	10/98-10/01	S9W 702	2799	mit Spanndämpfer, Spannrolle		SK-1681	BTK
1.9 DTI	09/00-10/01	F9Q 770	1870			0-N147	TB [DG]
1.9 DTI	10/01-05/10	F9Q 774	1870	mit Grundträger		0-N1173	TB [BT]
2.2 DTI	09/00-05/10	G9T 720, G9T 722, G9T 750	2188			0-N1269	TB [TE]
2.2 DTI	09/00-05/10	G9T 720, G9T 722, G9T 750	2188			0-N1270	TB [DG]
2.5 CDTI	08/06-05/10	G9U 632, G9U 632, G9U 650	2464			0-N1269	TB [TE]
2.5 CDTI	08/06-05/10	G9U 632, G9U 632, G9U 650	2464			0-N1270	TB [DG]
2.5 CDTI, 2.5 DTI	10/01-05/10	G9U 650, G9U 754, G9U 720, G9U 724, G9U 750, G9U 754	2463			0-N1269	TB [TE]
2.5 CDTI, 2.5 DTI	10/01-05/10	G9U 650, G9U 754, G9U 720, G9U 724, G9U 750, G9U 754	2463			0-N1270	TB [DG]
2.5 D	10/98-09/00	S8U 770	2499			0-N1617	TB [BT]
2.5 D	10/98-09/00	S8U 770	2499			0-N816	TB [DG]
2.5 D	10/98-09/00	S8U 770	2499			0-N821	TB [DG]
2.8 TDI	10/98-10/01	S9W 702	2799			0-N1617	TB [BT]
2.8 TDI	10/98-10/01	S9W 702	2799			0-N816	TB [DG]
1.9 DTI	10/01-05/10	F9Q 774	1870	:C029794→;		0-N1409	VB [DG]
1.9 DTI	10/01-05/10	F9Q 774	1870			0-N1611	VB [BT] S
2.2 DTI	09/00-05/10	G9T 720, G9T 722, G9T 750	2188			0-N1409	VB [DG]
2.2 DTI	09/00-05/10	G9T 720, G9T 722, G9T 750	2188	Rippenanzahl: 6;		0-N1648	VB [DG]
2.2 DTI	09/00-05/10	G9T 720, G9T 722, G9T 750	2188			0-N1731	VB [BT] S
2.5 CDTI	08/06-05/10	G9U 632, G9U 632, G9U 650	2464			0-N1409	VB [DG]
2.5 CDTI	08/06-05/10	G9U 632, G9U 632, G9U 650	2464			0-N1731	VB [BT] S
2.5 CDTI, 2.5 DTI	10/01-05/10	G9U 650, G9U 754, G9U 720, G9U 724, G9U 750, G9U 754	2463			0-N1409	VB [DG]
2.5 CDTI, 2.5 DTI	10/01-05/10	G9U 650, G9U 754, G9U 720, G9U 724, G9U 750, G9U 754	2463	Rippenanzahl: 6;		0-N1648	VB [DG]
2.5 CDTI, 2.5 DTI	10/01-05/10	G9U 650, G9U 754, G9U 720, G9U 724, G9U 750, G9U 754	2463			0-N1731	VB [BT] S
MOVANO Mk II (B) Chassis/Cab							
2.3 CDTI [RWD], 2.3 CDTI FWD	05/10-	M9T 670, M9T 672, M9T 676, M9T 680, M9T 696, M9T 876, M9T 670, M9T 672, M9T 676, M9T 870, M9T 870, M9T 670, M9T 690, M9T 692, M9T 870, M9T 678, M9T 680, M9T 686, M9T 690, M9T 692, M9T 696, M9T 698, M9T 876, M9T 694, M9T 696, M9T 698	2298			0-N1739	VB [DG]



OPTIMAL®

VAUXHALL



CM³



Art. Nr.



ohne Halter

MOVANO Mk II (B) Chassis/Cab								
2.3 CDTI [RWD], 2.3 CDTI FWD	05/10-	M9T 670, M9T 672, M9T 676, M9T 680, M9T 696, M9T 876, M9T 670, M9T 672, M9T 676, M9T 870, M9T 870, M9T 670, M9T 690, M9T 692, M9T 870, M9T 678, M9T 680, M9T 686, M9T 690, M9T 692, M9T 696, M9T 698, M9T 876, M9T 694, M9T 696, M9T 698	2298			0-N2039	VB [BT]	S
MOVANO Mk II (B) Combi								
2.3 CDTI	05/10-	M9T 670, M9T 672, M9T 676, M9T 670, M9T 672, M9T 676, M9T 680, M9T 876, M9T 678, M9T 680	2298			0-N1739	VB [DG]	
2.3 CDTI	05/10-	M9T 670, M9T 672, M9T 676, M9T 670, M9T 672, M9T 676, M9T 680, M9T 876, M9T 678, M9T 680	2298			0-N2039	VB [BT]	S
MOVANO Mk II (B) Doublecab								
2.3 CDTI [RWD], 2.3 CDTI FWD	05/10-	M9T 670, M9T 672, M9T 676, M9T 678, M9T 680, M9T 686, M9T 690, M9T 692, M9T 696, M9T 698, M9T 690, M9T 692, M9T 694, M9T 696	2298			0-N1739	VB [DG]	
2.3 CDTI [RWD], 2.3 CDTI FWD	05/10-	M9T 670, M9T 672, M9T 676, M9T 678, M9T 680, M9T 686, M9T 690, M9T 692, M9T 696, M9T 698, M9T 690, M9T 692, M9T 694, M9T 696	2298			0-N2039	VB [BT]	S
MOVANO Mk II (B) VAN								
2.3 CDTI [RWD], 2.3 CDTI FWD	05/10-	M9T 670, M9T 672, M9T 676, M9T 680, M9T 876, M9T 670, M9T 672, M9T 676, M9T 870, M9T 678, M9T 680, M9T 686, M9T 690, M9T 692, M9T 696, M9T 698, M9T 876, M9T 690, M9T 692, M9T 870, M9T 694, M9T 696, M9T 698	2298			0-N1739	VB [DG]	
2.3 CDTI [RWD], 2.3 CDTI FWD	05/10-	M9T 670, M9T 672, M9T 676, M9T 680, M9T 876, M9T 670, M9T 672, M9T 676, M9T 870, M9T 678, M9T 680, M9T 686, M9T 690, M9T 692, M9T 696, M9T 698, M9T 876, M9T 690, M9T 692, M9T 870, M9T 694, M9T 696, M9T 698	2298			0-N2039	VB [BT]	S
NOVA								
1.4	09/90-08/92	C 14 SE	1389	17x111; :02J22350→; mit Zubehör		SK-1162	BTK	
1.4	09/90-08/92	C 14 SE	1389	17x111; :02J22350→; nicht für Länderausführung Schweden, Schweiz; mit Zubehör		SK-1162AQ1	BTKW	
1.4	10/90-08/92	C 14 NZ	1389	17x111; :19311738→; mit Zubehör		SK-1162	BTK	
1.4	10/90-08/92	C 14 NZ	1389	17x111; :19311738→; nicht für Länderausführung Schweden, Schweiz; mit Zubehör		SK-1162AQ1	BTKW	
1.4 S	01/90-02/93	14 NV	1389	17x111; :19307806→; mit Zubehör		SK-1162	BTK	
1.4 S	01/90-02/93	14 NV	1389	17x111; :19307806→; nicht für Länderausführung Schweden, Schweiz; mit Zubehör		SK-1162AQ1	BTKW	
1.5 D, 1.5 TD	09/87-02/93	15 D, 15 DT (T4EC1)	1488	25x136; mit Zubehör		SK-1054	BTK	
1.5 D, 1.5 TD	09/87-02/93	15 D, 15 DT (T4EC1)	1488			0-N878	TB [DG]	
1.5 D, 1.5 TD	09/87-02/93	15 D, 15 DT (T4EC1)	1488			0-N879	TB [TE]	
1.4	09/90-08/92	C 14 NZ, C 14 SE	1389	Rippenanzahl: 6		0-N1439	VB [DG]	
1.4 S	01/90-02/93	14 NV	1389	:19307806→		0-N948	TB [TE]	
NOVA CC								
1.2 i KAT	09/89-03/93	C 12 NZ	1195	17x111; 09/1991 →; mit Zubehör		SK-1162	BTK	
1.2 i KAT	09/89-03/93	C 12 NZ	1195	17x111; 09/1991 →; ; mit Zubehör		SK-1162AQ1	BTKW	
1.4 i	01/90-03/93	C 14 NZ	1389	17x111; 10/1990 →; :19311738→; mit Zubehör		SK-1162	BTK	
1.4 i	01/90-03/93	C 14 NZ	1389	17x111; 10/1990 →; :19311738→; nicht für Länderausführung Schweden, Schweiz; mit Zubehör		SK-1162AQ1	BTKW	
1.4 i S	09/91-03/93	C 14 SE	1389	17x111; :02J22350→; mit Zubehör		SK-1162	BTK	
1.4 i S	09/91-03/93	C 14 SE	1389	17x111; :02J22350→; nicht für Länderausführung Schweden, Schweiz; mit Zubehör		SK-1162AQ1	BTKW	
1.4 S	01/90-03/93	14 NV	1389	17x111; :19307806→; mit Zubehör		SK-1162	BTK	
1.4 S	01/90-03/93	14 NV	1389	17x111; :19307806→; nicht für Länderausführung Schweden, Schweiz; mit Zubehör		SK-1162AQ1	BTKW	
1.5 D	09/87-03/93	15 D	1488	25x136; 10/1990 →; mit Zubehör		SK-1054	BTK	
1.5 TD	01/90-03/93	15 DT (T4EC1)	1488	25x136; mit Zubehör		SK-1054	BTK	
1.6, 1.6 GSI, 1.6 GSI KAT	05/88-03/93	C 16 SE, C 16 SEI, E 16 SE	1598	17x111; :02J22350→; mit Zubehör		SK-1162	BTK	

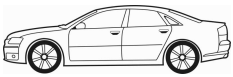

CM³



Art. Nr.



NOVA CC						
1.6, 1.6 GSI, 1.6 GSI KAT	05/88-03/93	C 16 SE, C 16 SEI, E 16 SE	1598	17x111; :02J22350→; nicht für Länderausführung Schweden, Schweiz; mit Zubehör	SK-1162AQ1	BTKW
1.5 D, 1.5 TD	09/87-03/93	15 D, 15 DT (T4EC1)	1488		0-N878	TB [DG]
1.5 D, 1.5 TD	09/87-03/93	15 D, 15 DT (T4EC1)	1488		0-N879	TB [TE]
1.2 i KAT	09/89-03/93	C 12 NZ	1195		0-N948	TB [TE]
1.4 i	01/90-03/93	C 14 NZ	1389	:19311739→	0-N948	TB [TE]
1.4 i S	09/91-03/93	C 14 SE	1389	:02122350→	0-N948	TB [TE]
1.4 S	01/90-03/93	14 NV	1389	:19307806→	0-N948	TB [TE]
1.6	09/88-08/90	E 16 SE	1598	:02J22350→	0-N948	TB [TE]
1.6 GSI	05/88-03/93	C 16 SEI, E 16 SE	1598	:02122350→	0-N948	TB [TE]
1.6 GSI KAT	02/92-03/93	C 16 SE	1598		0-N948	TB [TE]

NOVAVAN						
1.4	11/90-03/93	14 NV	1389	17x111; :19307806→; mit Zubehör	SK-1162	BTK
1.4	11/90-03/93	14 NV	1389	17x111; :19307806→; mit Zubehör	SK-1162AQ1	BTKW
1.5 D	01/91-10/94	15 D	1488	25x136; mit Zubehör	SK-1054	BTK
1.5 D	01/91-10/94	15 D	1488		0-N878	TB [DG]
1.5 D	01/91-10/94	15 D	1488		0-N879	TB [TE]
1.4	11/90-03/93	14 NV	1389	Rippenanzahl: 6	0-N1439	VB [DG]

OMEGA (B)						
2.0	03/94-09/99	20 SE, X 20 SE	1998	20x146	SK-1169	BTK
2.0	03/94-09/99	20 SE, X 20 SE	1998	20x146	SK-1169AQ1	BTKW
2.0 16V	03/94-09/99	X 20 XEV	1998	24x169; 06/1994 →	SK-1100	BTK
2.0 16V	03/94-09/99	X 20 XEV	1998	24x169; 06/1994 →	SK-1100AQ1	BTKW
2.2 16V	01/94-06/03	Z 22 XE	2198	24x171; 08/2000 →	SK-1644	BTK
2.2 16V	01/94-06/03	Y 22 XE, Z 22 XE	2198	24x171	SK-1644AQ1	BTKW
2.5 V6	03/94-09/00	X 25 XE	2498	30x225; 06/1994 →; :→08300418; mit Zubehör	SK-1508	BTK
2.6 V6	08/00-07/03	Y 26 SE	2597	30x225; :→08300418; mit Zubehör	SK-1508	BTK
3.0 V6	04/94-07/00	X 30 XE	2962	30x225; :→08300418; mit Zubehör	SK-1508	BTK
2.0	03/94-09/99	20 SE, X 20 SE	1998		0-N101	TB [TE]
2.0 16V	03/94-09/99	X 20 XEV	1998		0-N100	TB [TE]
2.0 16V	03/94-09/99	X 20 XEV	1998		0-N906	TB [DG]
2.2 16V	01/94-06/03	Y 22 XE, Z 22 XE	2198		0-N1383	TB [TE]
2.2 16V	01/94-06/03	Y 22 XE, Z 22 XE	2198		0-N906	TB [DG]
2.5 V6	03/94-09/00	X 25 XE	2498	:08292479→; :→08300418; für OE: 90530599	0-N956	TB [TE]
2.5 V6	03/94-09/00	X 25 XE	2498	:→08300418	0-N957	TB [DG]
3.0 V6	04/94-07/00	X 30 XE	2962	:08292479→; :→08300418; für OE: 90530599	0-N956	TB [TE]
3.0 V6	04/94-07/00	X 30 XE	2962	:→08300418	0-N957	TB [DG]
2.0 DTI 16V	01/98-09/00	X 20 DTH	1995	Rippenanzahl: 6	0-N1437	VB [DG]
2.0 DTI 16V	01/98-09/00	X 20 DTH	1995		0-N1485	VB [BT] S
2.0 DTI 16V	01/98-09/00	X 20 DTH	1995		0-N2169	VB [VD]
2.2 DTI 16V	08/00-07/03	Y 22 DTH	2171		0-N1485	VB [BT] S
2.2 DTI 16V	08/00-07/03	Y 22 DTH	2171		0-N2169	VB [VD]
2.5 DTI 24V	09/01-07/03	Y 25 DT	2497		0-N1396	VB [DG]
2.5 DTI 24V	09/01-07/03	Y 25 DT	2497		0-N1834	VB [BT] S
2.5 DTI 24V	09/01-07/03	Y 25 DT	2497		0-N1940	VB [BT] S
2.5 DTI 24V	09/01-07/03	Y 25 DT	2497		0-N2072	VB [BT]
2.5 TD	04/94-07/01	25 DT, X 25 DT	2497		0-N1303	VB [VD]
2.5 V6	03/94-09/00	X 25 XE	2498	Rippenanzahl: 6;	0-N1438	VB [BT] S
2.5 V6	03/94-09/00	X 25 XE	2498		0-N1603	VB [DG]
2.6 V6	08/00-07/03	Y 26 SE	2597	Rippenanzahl: 6	0-N1438	VB [BT] S
3.0 V6	04/94-07/00	X 30 XE	2962	Rippenanzahl: 6;	0-N1438	VB [BT] S
3.2 V6	02/01-07/03	Y 32 SE	3175	Rippenanzahl: 6	0-N1438	VB [BT] S

OMEGA (B) Estate						
2.0	03/94-09/99	X 20 SE	1998	20x146	SK-1169	BTK
2.0	03/94-09/99	X 20 SE	1998	20x146	SK-1169AQ1	BTKW
2.0 16V	03/94-02/01	X 20 XEV	1998	24x169	SK-1100	BTK
2.0 16V	03/94-02/01	X 20 XEV	1998	24x169	SK-1100AQ1	BTKW
2.2 16V	02/94-06/03	Z 22 XE	2198	24x171; 08/2000 →	SK-1644	BTK
2.2 16V	02/94-06/03	Y 22 XE, Z 22 XE	2198	24x171	SK-1644AQ1	BTKW
2.5 V6	03/94-09/00	X 25 XE	2498	30x225; 06/1994 →; :→08300418; mit Zubehör	SK-1508	BTK
2.6 V6	08/00-06/03	Y 26 SE	2597	30x225; :→08300418; mit Zubehör	SK-1508	BTK



CM³



Art. Nr.



OMEGA (B) Estate

3.0 V6	07/94-07/00	X 30 XE	2962	30x225; :→08300418; mit Zubehör	SK-1508	BTK	
2.0	03/94-09/99	X 20 SE	1998		0-N101	TB [TE]	
2.0 16V	03/94-02/01	X 20 XEV	1998		0-N100	TB [TE]	
2.0 16V	03/94-02/01	X 20 XEV	1998		0-N906	TB [DG]	
2.2 16V	02/94-06/03	Y 22 XE, Z 22 XE	2198		0-N1383	TB [TE]	
2.2 16V	02/94-06/03	Y 22 XE, Z 22 XE	2198		0-N906	TB [DG]	
2.5 V6	03/94-09/00	X 25 XE	2498	:08292479→; :→08300418; für OE: 90530599	0-N956	TB [TE]	
2.5 V6	03/94-09/00	X 25 XE	2498	:→08300418	0-N957	TB [DG]	
3.0 V6	07/94-07/00	X 30 XE	2962	:08292479→; :→08300418; für OE: 90530599	0-N956	TB [TE]	
3.0 V6	07/94-07/00	X 30 XE	2962	:→08300418	0-N957	TB [DG]	
2.0 DTI 16V	01/98-09/00	X 20 DTH	1995	Rippenanzahl: 6	0-N1437	VB [DG]	
2.0 DTI 16V	01/98-09/00	X 20 DTH	1995		0-N1485	VB [BT]	S
2.0 DTI 16V	01/98-09/00	X 20 DTH	1995		0-N2169	VB [VD]	
2.2 DTI 16V	08/00-06/03	Y 22 DTH	2171		0-N1485	VB [BT]	S
2.2 DTI 16V	08/00-06/03	Y 22 DTH	2171		0-N2169	VB [VD]	
2.5 DTI 24V	09/01-06/03	Y 25 DT	2497		0-N1396	VB [DG]	
2.5 DTI 24V	09/01-06/03	Y 25 DT	2497		0-N1834	VB [BT]	S
2.5 DTI 24V	09/01-06/03	Y 25 DT	2497		0-N1940	VB [BT]	S
2.5 DTI 24V	09/01-06/03	Y 25 DT	2497		0-N2072	VB [BT]	
2.5 TD	04/94-07/01	25 DT, X 25 DT	2497		0-N1303	VB [VD]	
2.5 V6	03/94-09/00	X 25 XE	2498	Rippenanzahl: 6;	0-N1438	VB [BT]	S
2.5 V6	03/94-09/00	X 25 XE	2498		0-N1603	VB [DG]	
2.6 V6	08/00-06/03	Y 26 SE	2597	Rippenanzahl: 6	0-N1438	VB [BT]	S
3.0 V6	07/94-07/00	X 30 XE	2962	Rippenanzahl: 6;	0-N1438	VB [BT]	S
3.2 V6	02/01-06/03	Y 32 SE	3175	Rippenanzahl: 6	0-N1438	VB [BT]	S

SENATOR Mk II (B)

2.6 i	09/90-09/93	C 26 NE	2594	ch.01032427→; Rippenanzahl: 6	0-N1439	VB [DG]	
2.6 i	09/90-09/93	C 26 NE	2594		0-N1603	VB [DG]	
3.0	09/87-08/88	30 NE	2969	:01039675→; Rippenanzahl: 6	0-N1439	VB [DG]	
3.0, 3.0 24V, 3.0 i KAT	01/88-09/93	30 NE, C 30 NE, C 30 SE	2969	ch.01024730, 01039675→; Rippenanzahl: 6	0-N1439	VB [DG]	
3.0, 3.0 24V, 3.0 i KAT	01/88-09/93	30 NE, C 30 NE, C 30 SE	2969		0-N1603	VB [DG]	

SIGNUM

1.8	06/03-07/05	Z 18 XE	1796	20x162; mit Zubehör	SK-1355	BTK	
1.8	06/03-07/05	Z 18 XE	1796	20x162; mit Zubehör	SK-1355AQ1	BTKW	
1.8	08/05-05/08	Z 18 XER	1796	24x146	SK-1607	BTK	
1.9 CDTI 16V	04/04-03/08	Z 19 DTH	1910	24x199	SK-1586	BTK	
1.9 CDTI 16V	04/04-03/08	Z 19 DTH	1910	24x199	SK-1586AQ1	BTKW	
1.9 CDTI, 1.9 Turbo	04/04-05/08	Z 19 DT, Z 19 DTL	1910	24x190	SK-1696	BTK	
1.9 CDTI, 1.9 Turbo	04/04-05/08	Z 19 DT, Z 19 DTL	1910	24x190	SK-1696AQ1	BTKW	
3.0 CDTi	05/03-05/08	Y 30 DT	2958	25x116	SK-1611	BTK	
3.0 V6 CDTI	07/05-06/08	Z 30 DT	2959	25x116; 08/2005 →	SK-1611	BTK	
1.8	06/03-07/05	Z 18 XE	1796		0-N102	TB [TE]	
1.8	06/03-07/05	Z 18 XE	1796	; mit Anbaumaterial	0-N300	TB [DG]	
1.8	06/03-07/05	Z 18 XE	1796		0-N953	TB [DG]	
1.8	08/05-05/08	Z 18 XER	1796		0-N1347	TB [TE]	
1.9 CDTI, 1.9 CDTI 16V	04/04-03/08	Z 19 DT, Z 19 DTH	1910		0-N115	TB [TE]	
1.9 CDTI, 1.9 CDTI 16V, 1.9 Turbo	04/04-05/08	Z 19 DT, Z 19 DTH, Z 19 DTL	1910		0-N2149	TB [DG]	
3.0 CDTi	05/03-05/08	Y 30 DT	2958		0-N1353	TB [TE]	
3.0 CDTi	05/03-05/08	Y 30 DT	2958		0-N1354	TB [DG]	
3.0 CDTi	05/03-05/08	Y 30 DT	2958		0-N1355	TB [DG]	
3.0 V6 CDTI	07/05-06/08	Z 30 DT	2959		0-N1353	TB [TE]	
3.0 V6 CDTI	07/05-06/08	Z 30 DT	2959		0-N1354	TB [DG]	
3.0 V6 CDTI	07/05-06/08	Z 30 DT	2959		0-N1355	TB [DG]	
1.8	06/03-07/05	Z 18 XE	1796		0-N1466	VB [BT]	S
1.8	08/05-05/08	Z 18 XER	1796		0-N1799	VB [BT]	S
1.9 CDTI, 1.9 CDTI 16V	04/04-03/08	Z 19 DT, Z 19 DTH	1910	:→71111927	0-N1503	VB [BT]	S
1.9 CDTI, 1.9 CDTI 16V	04/04-03/08	Z 19 DT, Z 19 DTH	1910	:→71111927;	0-N1522	VB [DG]	
1.9 CDTI, 1.9 CDTI 16V	04/04-03/08	Z 19 DT, Z 19 DTH	1910	Rippenanzahl: 6	0-N1667	VB [DG]	
1.9 CDTI, 1.9 CDTI 16V	04/04-03/08	Z 19 DT, Z 19 DTH	1910	:71111928→	0-N2030	VB [BT]	S
2.0 DTI	05/03-05/08	Y 20 DTH	1994	Rippenanzahl: 6	0-N1437	VB [DG]	
2.0 DTI	05/03-05/08	Y 20 DTH	1994		0-N1485	VB [BT]	S
2.0 DTI	05/03-05/08	Y 20 DTH	1994		0-N2169	VB [VD]	
2.0 i Turbo	03/03-10/08	Z 20 NET	1998		0-N1588	VB [BT]	S



CM³



Art. Nr.



SIGNUM							
2.2 DTI	05/03-05/08	Y 22 DTR	2172	Rippenanzahl: 6	0-N1437	VB [DG]	
2.2 DTI	05/03-05/08	Y 22 DTR	2172		0-N1485	VB [BT]	S
2.2 DTI	05/03-05/08	Y 22 DTR	2172		0-N2169	VB [VD]	
2.2 i	05/03-05/08	Z 22 YH	2198		0-N1588	VB [BT]	S
2.8 V6 Turbo	07/05-05/08	Z 28 NEL	2792		0-N1588	VB [BT]	S
2.8 V6 Turbo	07/05-05/08	Z 28 NEL	2792		0-N2194	VB [BT]	S
3.0 CDTi	05/03-05/08	Y 30 DT	2958		0-N1633	VB [DG]	
3.0 CDTi	05/03-05/08	Y 30 DT	2958	✱	0-N1649	VB [DG]	
3.0 CDTi	05/03-05/08	Y 30 DT	2958		0-N1717	VB [BT]	S
3.0 V6 CDTi	07/05-06/08	Z 30 DT	2959		0-N1633	VB [DG]	
3.0 V6 CDTi	07/05-06/08	Z 30 DT	2959	✱	0-N1649	VB [DG]	
3.0 V6 CDTi	07/05-06/08	Z 30 DT	2959		0-N1717	VB [BT]	S
3.2 V6	05/03-05/08	Z 32 SE	3175	Rippenanzahl: 6	0-N1438	VB [BT]	S

SINTRA							
2.2 i 16 V	11/96-04/99	X 22 XE	2198	24x171; 03/1997 →	SK-1644	BTK	
2.2 i 16 V	11/96-04/99	X 22 XE	2198	24x171	SK-1644AQ1	BTKW	
3.0 i 24V	11/96-04/99	X 30 XE	2962	30x225; 03/1997 →; : →08299999; mit Zubehör	SK-1508	BTK	
2.2 i 16 V	11/96-04/99	X 22 XE	2198		0-N1383	TB [TE]	
2.2 i 16 V	11/96-04/99	X 22 XE	2198		0-N906	TB [DG]	
3.0 i 24V	11/96-04/99	X 30 XE	2962	: →08300000	0-N957	TB [DG]	
2.2 DTI	07/97-04/99	X 22 DTH	2171		0-N1485	VB [BT]	S
2.2 DTI	07/97-04/99	X 22 DTH	2171		0-N2169	VB [VD]	
3.0 i 24V	11/96-04/99	X 30 XE	2962	Rippenanzahl: 6; ✱	0-N1438	VB [BT]	S

SPEEDSTER							
2.0	03/01-09/06	Z 20 LET	1998	24x168; ch. →3N999999	SK-1632	BTK	

TIGRA Mk I (F07)							
1.4 16V	07/94-12/00	X 14 XE	1389	20x169; mit Zubehör	SK-1073	BTK	
1.4 16V	07/94-12/00	X 14 XE	1389	20x169; mit Zubehör	SK-1073AQ1	BTKW	
1.6 16V	07/94-12/00	X 16 XE	1598	20x169; 11/1994 →; mit Zubehör	SK-1073	BTK	
1.6 16V	07/94-12/00	X 16 XE	1598	20x169; mit Zubehör	SK-1073AQ1	BTKW	
1.4 16V	07/94-12/00	X 14 XE	1389		0-N102	TB [TE]	
1.4 16V	07/94-12/00	X 14 XE	1389		0-N952	TB [DG]	
1.4 16V	07/94-12/00	X 14 XE	1389		0-N953	TB [DG]	
1.6 16V	07/94-12/00	X 16 XE	1598		0-N102	TB [TE]	
1.6 16V	07/94-12/00	X 16 XE	1598		0-N952	TB [DG]	
1.6 16V	07/94-12/00	X 16 XE	1598		0-N953	TB [DG]	
1.4 16V	07/94-12/00	X 14 XE	1389	Rippenanzahl: 6	0-N1439	VB [DG]	
1.4 16V	07/94-12/00	X 14 XE	1389	für Fahrzeuge ohne Servolenkung	0-N1464	VB [BT]	S
1.6 16V	07/94-12/00	X 16 XE	1598	Rippenanzahl: 6	0-N1439	VB [DG]	
1.6 16V	07/94-12/00	X 16 XE	1598	für Fahrzeuge ohne Servolenkung	0-N1464	VB [BT]	S

TIGRA TwinTop							
1.8	06/04-08/09	Z 18 XE	1796	20x162; mit Zubehör	SK-1355	BTK	
1.8	06/04-08/09	Z 18 XE	1796	20x162; mit Zubehör	SK-1355AQ1	BTKW	
1.8	06/04-08/09	Z 18 XE	1796		0-N102	TB [TE]	
1.8	06/04-08/09	Z 18 XE	1796	†; mit Anbaumaterial	0-N300	TB [DG]	
1.8	06/04-08/09	Z 18 XE	1796		0-N953	TB [DG]	
1.3 CDTi	06/04-08/09	Z 13 DT	1248		0-N1526	VB [BT]	S
1.4	06/04-08/09	Z 14 XEP	1364		0-N2170	VB [BT]	S
1.8	06/04-08/09	Z 18 XE	1796		0-N1466	VB [BT]	S

VECTRA (B)							
1.6 i	08/95-10/01	X 16 SZR	1598	17x111; mit Zubehör	SK-1162	BTK	
1.6 i	08/95-10/01	X 16 SZR	1598	17x111; :02LC6176 →; mit Zubehör	SK-1162AQ1	BTKW	
1.6 i 16V	08/95-10/01	X 16 XEL, Y 16 XE, Z 16 XE	1598	20x169; mit Zubehör	SK-1073	BTK	
1.6 i 16V	08/95-10/01	X 16 XEL, Y 16 XE, Z 16 XE	1598	20x169; : →02MZ5253, 20U75998; mit Zubehör	SK-1073AQ1	BTKW	
1.6 i 16V	08/95-10/01	X 16 XEL, Y 16 XE, Z 16 XE	1598	20x169; :02MZ5253, 20U75998 →	SK-1073AQ3	BTKW	
1.7 TD	10/95-11/96	X 17 DT (TC4EE1)	1686	25x136; mit Zubehör	SK-1168	BTK	
1.8 i 16V	10/95-09/00	X 18 XE1	1796	20x169; mit Zubehör	SK-1073	BTK	
1.8 i 16V	10/95-09/00	X 18 XE1	1796	20x169; mit Zubehör	SK-1073AQ2	BTKW	
1.8 i 16V	10/95-09/00	X 18 XE	1796	24x169	SK-1100	BTK	
1.8 i 16V	10/95-09/00	X 18 XE	1796	24x169	SK-1100AQ1	BTKW	
1.8 i 16V	09/00-03/02	Z 18 XE	1796	20x169; mit Zubehör	SK-1073	BTK	
1.8 i 16V	09/00-03/02	Z 18 XE	1796	20x169; mit Zubehör	SK-1073AQ2	BTKW	



CM³



Art. Nr.



VECTRA (B)

2.0 i 16V	10/95-01/01	X 20 XEV	1998	24x169	SK-1100	BTK	
2.0 i 16V	10/95-01/01	X 20 XEV	1998	24x169	SK-1100AQ1	BTKW	
2.5 i GSi, 2.5 i V6	09/95-08/00	X 25 XE	2498	30x225; ch.→W1285446, W5276825; mit Zubehör	SK-1508	BTK	
2.5 i GSi, 2.5 i V6	09/95-08/00	X 25 XE	2498	30x225; ch.→W7154258, WL999999; mit Zubehör	SK-1508	BTK	
1.6 i 16V	08/95-10/01	X 16 XEL, Y 16 XE, Z 16 XE	1598		0-N102	TB [TE]	
1.6 i 16V	08/95-10/01	X 16 XEL, Y 16 XE, Z 16 XE	1598		0-N952	TB [DG]	
1.6 i 16V	08/95-10/01	X 16 XEL, Y 16 XE, Z 16 XE	1598		0-N953	TB [DG]	
1.7 TD	10/95-11/96	X 17 DT (TC4EE1)	1686		0-N126	TB [TE]	
1.7 TD	10/95-11/96	X 17 DT (TC4EE1)	1686		0-N878	TB [DG]	
1.8 i 16V	10/95-09/00	X 18 XE	1796		0-N100	TB [TE]	
1.8 i 16V	10/95-09/00	X 18 XE1	1796		0-N102	TB [TE]	
1.8 i 16V	10/95-09/00	X 18 XE	1796		0-N906	TB [DG]	
1.8 i 16V	10/95-09/00	X 18 XE1	1796		0-N952	TB [DG]	
1.8 i 16V	10/95-09/00	X 18 XE1	1796		0-N953	TB [DG]	
1.8 i 16V	09/00-03/02	Z 18 XE	1796		0-N102	TB [TE]	
1.8 i 16V	09/00-03/02	Z 18 XE	1796		0-N952	TB [DG]	
1.8 i 16V	09/00-03/02	Z 18 XE	1796		0-N953	TB [DG]	
2.0 i 16V	10/95-01/01	X 20 XEV	1998		0-N100	TB [TE]	
2.0 i 16V	10/95-01/01	X 20 XEV	1998		0-N906	TB [DG]	
2.5 i GSi, 2.5 i V6	09/95-08/00	X 25 XE	2498	ANNE ENGINE:08292479-→; ANNE ENGINE:-→08300418; für OE: 90530599	0-N956	TB [TE]	
2.5 i GSi, 2.5 i V6	09/95-08/00	X 25 XE	2498	ANNE ENGINE:-→08300418	0-N957	TB [DG]	
1.6 i	08/95-10/01	X 16 SZR	1598		0-N948	TB [TE]	
2.0 DI 16V, 2.0 DTI 16V	08/95-10/01	X 20 DTH, Y 20 DTH, X 20 DTL	1995	Rippenanzahl: 6	0-N1437	VB [DG]	
2.0 DI 16V, 2.0 DTI 16V	08/95-10/01	X 20 DTH, Y 20 DTH, X 20 DTL	1995		0-N1485	VB [BT]	S
2.0 DI 16V, 2.0 DTI 16V	08/95-10/01	X 20 DTH, Y 20 DTH, X 20 DTL	1995		0-N2169	VB [VD]	
2.2 DTI 16V	08/95-10/01	Y 22 DTR	2172	Rippenanzahl: 6	0-N1437	VB [DG]	
2.2 DTI 16V	08/95-10/01	Y 22 DTR	2172		0-N1485	VB [BT]	S
2.2 DTI 16V	08/95-10/01	Y 22 DTR	2172		0-N2169	VB [VD]	
2.2 i 16V	08/95-10/01	Z 22 SE	2198		0-N1588	VB [BT]	S
2.5 i GSi, 2.5 i V6	09/95-08/00	X 25 XE	2498	Rippenanzahl: 6; ⚡	0-N1438	VB [BT]	S
2.5 i V6	09/95-08/00	X 25 XE	2498	⚡	0-N1603	VB [DG]	
2.6 i V6	09/00-03/02	Y 26 SE	2597	Rippenanzahl: 6	0-N1438	VB [BT]	S

VECTRA (B) CC

1.6 i	08/95-10/01	X 16 SZR	1598	17x111; mit Zubehör	SK-1162	BTK	
1.6 i	08/95-10/01	X 16 SZR	1598	17x111; ANNE ENGINE:02LC6176-→; mit Zubehör	SK-1162AQ1	BTKW	
1.6 i 16V	08/95-10/01	X 16 XEL, Y 16 XE, Z 16 XE	1598	20x169; mit Zubehör	SK-1073	BTK	
1.6 i 16V	08/95-10/01	X 16 XEL, Y 16 XE, Z 16 XE	1598	20x169; ANNE ENGINE:→02MZ5253, 20U75998; mit Zubehör	SK-1073AQ1	BTKW	
1.6 i 16V	08/95-10/01	X 16 XEL, Y 16 XE, Z 16 XE	1598	20x169; ANNE ENGINE:02MZ5253, 20U75998-→	SK-1073AQ3	BTKW	
1.7 TD	10/95-11/96	X 17 DT (TC4EE1)	1686	25x136; mit Zubehör	SK-1168	BTK	
1.8 i 16V	10/95-09/00	X 18 XE1	1796	20x169; 02/1999 -→; mit Zubehör	SK-1073	BTK	
1.8 i 16V	10/95-09/00	X 18 XE1	1796	20x169; mit Zubehör	SK-1073AQ2	BTKW	
1.8 i 16V	10/95-09/00	X 18 XE	1796	24x169	SK-1100	BTK	
1.8 i 16V	10/95-09/00	X 18 XE	1796	24x169	SK-1100AQ1	BTKW	
1.8 i 16V	09/00-07/03	Z 18 XE	1796	20x169; mit Zubehör	SK-1073	BTK	
1.8 i 16V	09/00-07/03	Z 18 XE	1796	20x169; mit Zubehör	SK-1073AQ2	BTKW	
2.0 i 16V	10/95-01/01	X 20 XEV	1998	24x169	SK-1100	BTK	
2.0 i 16V	10/95-01/01	X 20 XEV	1998	24x169	SK-1100AQ1	BTKW	
2.5 i GSi, 2.5 i V6	09/95-08/00	X 25 XE	2498	30x225; ch.→W1285446, W5276825; mit Zubehör	SK-1508	BTK	
2.5 i GSi, 2.5 i V6	09/95-08/00	X 25 XE	2498	30x225; ch.→W7154258, WL999999; mit Zubehör	SK-1508	BTK	
1.6 i 16V	08/95-10/01	X 16 XEL, Y 16 XE, Z 16 XE	1598		0-N102	TB [TE]	
1.6 i 16V	08/95-10/01	X 16 XEL, Y 16 XE, Z 16 XE	1598		0-N952	TB [DG]	
1.6 i 16V	08/95-10/01	X 16 XEL, Y 16 XE, Z 16 XE	1598		0-N953	TB [DG]	
1.7 TD	10/95-11/96	X 17 DT (TC4EE1)	1686		0-N126	TB [TE]	
1.7 TD	10/95-11/96	X 17 DT (TC4EE1)	1686		0-N878	TB [DG]	
1.8 i 16V	10/95-09/00	X 18 XE	1796		0-N100	TB [TE]	
1.8 i 16V	10/95-09/00	X 18 XE1	1796		0-N102	TB [TE]	
1.8 i 16V	10/95-09/00	X 18 XE	1796		0-N906	TB [DG]	
1.8 i 16V	10/95-09/00	X 18 XE1	1796		0-N952	TB [DG]	
1.8 i 16V	10/95-09/00	X 18 XE1	1796		0-N953	TB [DG]	
1.8 i 16V	09/00-07/03	Z 18 XE	1796		0-N102	TB [TE]	



CM³



Art. Nr.



ohne Halter

VECTRA (B) CC

1.8 i 16V	09/00-07/03	Z 18 XE	1796		0-N952	TB [DG]	
1.8 i 16V	09/00-07/03	Z 18 XE	1796		0-N953	TB [DG]	
2.0 i 16V	10/95-01/01	X 20 XEV	1998		0-N100	TB [TE]	
2.0 i 16V	10/95-01/01	X 20 XEV	1998		0-N906	TB [DG]	
2.5 i GSi, 2.5 i V6	09/95-08/00	X 25 XE	2498	08292479 →; 08300418; für OE: 90530599	0-N956	TB [TE]	
2.5 i GSi, 2.5 i V6	09/95-08/00	X 25 XE	2498	08300418	0-N957	TB [DG]	
1.6 i	08/95-10/01	X 16 SZR	1598		0-N948	TB [TE]	
2.0 Di 16V, 2.0 DTi 16V	08/95-10/01	X 20 DTH, Y 20 DTH, X 20 DTL	1995	Rippenanzahl: 6	0-N1437	VB [DG]	
2.0 Di 16V, 2.0 DTi 16V	08/95-10/01	X 20 DTH, Y 20 DTH, X 20 DTL	1995		0-N1485	VB [BT]	S
2.0 Di 16V, 2.0 DTi 16V	08/95-10/01	X 20 DTH, Y 20 DTH, X 20 DTL	1995		0-N2169	VB [VD]	
2.2 DTi 16V	08/95-10/01	Y 22 DTR	2172	Rippenanzahl: 6	0-N1437	VB [DG]	
2.2 DTi 16V	08/95-10/01	Y 22 DTR	2172		0-N1485	VB [BT]	S
2.2 DTi 16V	08/95-10/01	Y 22 DTR	2172		0-N2169	VB [VD]	
2.2 i 16V	09/00-07/03	Z 22 SE	2198		0-N1588	VB [BT]	S
2.5 i GSi, 2.5 i V6	09/95-08/00	X 25 XE	2498	Rippenanzahl: 6; *	0-N1438	VB [BT]	S
2.5 i V6	09/95-08/00	X 25 XE	2498	*	0-N1603	VB [DG]	
2.6 i V6	09/00-07/03	Y 26 SE	2597	Rippenanzahl: 6	0-N1438	VB [BT]	S

VECTRA (B) Estate

1.6 i	11/96-03/02	X 16 SZR	1598	17x111; mit Zubehör	SK-1162	BTK	
1.6 i	11/96-03/02	X 16 SZR	1598	17x111; 02LC6176 →; mit Zubehör	SK-1162AQ1	BTKW	
1.6 i 16V	11/96-03/02	X 16 XEL, Y 16 XE, Z 16 XE	1598	20x169; mit Zubehör	SK-1073	BTK	
1.7 TD	11/96-12/97	X 17 DT (TC4EE1)	1686	25x136; mit Zubehör	SK-1168	BTK	
1.8 i 16V	11/96-09/00	X 18 XE1	1796	20x169; mit Zubehör	SK-1073	BTK	
1.8 i 16V	11/96-09/00	X 18 XE1	1796	20x169; mit Zubehör	SK-1073AQ2	BTKW	
1.8 i 16V	11/96-09/00	X 18 XE	1796	24x169	SK-1100	BTK	
1.8 i 16V	11/96-09/00	X 18 XE	1796	24x169	SK-1100AQ1	BTKW	
1.8 i 16V	09/00-03/02	Z 18 XE	1796	20x169; mit Zubehör	SK-1073	BTK	
1.8 i 16V	09/00-03/02	Z 18 XE	1796	20x169; mit Zubehör	SK-1073AQ2	BTKW	
2.0 i 16V	10/95-01/01	X 20 XEV	1998	24x169; 11/1996 →	SK-1100	BTK	
2.0 i 16V	10/95-01/01	X 20 XEV	1998	24x169; 11/1996 →	SK-1100AQ1	BTKW	
2.5 i GSi, 2.5 i V6	11/96-08/00	X 25 XE	2498	30x225; ch. →W1285446, W5276825; mit Zubehör	SK-1508	BTK	
2.5 i GSi, 2.5 i V6	11/96-08/00	X 25 XE	2498	30x225; ch. →W7154258, WL999999; mit Zubehör	SK-1508	BTK	
1.6 i 16V	11/96-03/02	X 16 XEL, Y 16 XE, Z 16 XE	1598		0-N102	TB [TE]	
1.6 i 16V	11/96-03/02	X 16 XEL, Y 16 XE, Z 16 XE	1598		0-N952	TB [DG]	
1.6 i 16V	11/96-03/02	X 16 XEL, Y 16 XE, Z 16 XE	1598		0-N953	TB [DG]	
1.8 i 16V	11/96-09/00	X 18 XE	1796		0-N100	TB [TE]	
1.8 i 16V	11/96-09/00	X 18 XE1	1796		0-N102	TB [TE]	
1.8 i 16V	11/96-09/00	X 18 XE	1796		0-N906	TB [DG]	
1.8 i 16V	11/96-09/00	X 18 XE1	1796		0-N952	TB [DG]	
1.8 i 16V	11/96-09/00	X 18 XE1	1796		0-N953	TB [DG]	
1.8 i 16V	09/00-03/02	Z 18 XE	1796		0-N102	TB [TE]	
1.8 i 16V	09/00-03/02	Z 18 XE	1796		0-N952	TB [DG]	
1.8 i 16V	09/00-03/02	Z 18 XE	1796		0-N953	TB [DG]	
2.0 i 16V	10/95-01/01	X 20 XEV	1998		0-N100	TB [TE]	
2.0 i 16V	10/95-01/01	X 20 XEV	1998		0-N906	TB [DG]	
2.5 i GSi, 2.5 i V6	11/96-08/00	X 25 XE	2498	08292479 →; 08300418; für OE: 90530599	0-N956	TB [TE]	
2.5 i GSi, 2.5 i V6	11/96-08/00	X 25 XE	2498	08300418	0-N957	TB [DG]	
1.6 i	11/96-03/02	X 16 SZR	1598		0-N948	TB [TE]	
2.0 Di 16V, 2.0 DTi 16V	08/95-10/01	X 20 DTH, Y 20 DTH, X 20 DTL	1995	Rippenanzahl: 6	0-N1437	VB [DG]	
2.0 Di 16V, 2.0 DTi 16V	08/95-10/01	X 20 DTH, Y 20 DTH, X 20 DTL	1995		0-N1485	VB [BT]	S
2.0 Di 16V, 2.0 DTi 16V	08/95-10/01	X 20 DTH, Y 20 DTH, X 20 DTL	1995		0-N2169	VB [VD]	
2.2 DTi 16V	08/95-10/01	Y 22 DTR	2172	Rippenanzahl: 6	0-N1437	VB [DG]	
2.2 DTi 16V	08/95-10/01	Y 22 DTR	2172		0-N1485	VB [BT]	S
2.2 DTi 16V	08/95-10/01	Y 22 DTR	2172		0-N2169	VB [VD]	
2.2 i 16V	08/95-10/01	Z 22 SE	2198		0-N1588	VB [BT]	S
2.5 i GSi, 2.5 i V6	11/96-08/00	X 25 XE	2498	Rippenanzahl: 6; *	0-N1438	VB [BT]	S
2.5 i V6	11/96-08/00	X 25 XE	2498	*	0-N1603	VB [DG]	
2.6 i V6	09/00-03/02	Y 26 SE	2597	Rippenanzahl: 6	0-N1438	VB [BT]	S

VECTRA Mk II (C)

1.6	01/06-07/08	Z 16 XEP	1598	24x146	SK-1607	BTK	
1.6 16V	06/04-07/08	Z 16 XE	1598	20x162; mit Zubehör	SK-1355	BTK	



OPTIMAL®

VAUXHALL

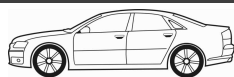

CM³



Art. Nr.



ohne Halter

VECTRA Mk II (C)

1.6 16V	06/04-07/08	Z 16 XE	1598	20x162; mit Zubehör	SK-1355AQ2	BTKW
1.8	01/06-07/08	Z 18 XER	1796	24x146	SK-1607	BTK
1.8, 1.8 16V, 1.8 16V Dualfuel	04/02-07/08	Z 18 XE, Z 18 XEL	1796	20x162; mit Zubehör	SK-1355	BTK
1.8, 1.8 16V, 1.8 16V Dualfuel	04/02-07/08	Z 18 XE, Z 18 XEL	1796	20x162; mit Zubehör	SK-1355AQ1	BTKW
1.9 CDTi	04/02-09/08	Z 19 DT	1910	24x190; 04/2004 →	SK-1696	BTK
1.9 CDTi	04/02-09/08	Z 19 DT	1910	24x190	SK-1696AQ1	BTKW
1.9 CDTi	10/05-07/08	Z 19 DTL	1910	24x190	SK-1696	BTK
1.9 CDTi 16V	04/04-08/08	Z 19 DTH	1910	24x199	SK-1586	BTK
1.9 CDTi 16V	04/04-08/08	Z 19 DTH	1910	24x199	SK-1586AQ1	BTKW
3.0 CDTi, 3.0 V6 CDTi	06/03-07/08	Y 30 DT, Z 30 DT	2958	25x116	SK-1611	BTK
1.6 16V	06/04-07/08	Z 16 XE	1598		0-N102	TB [TE]
1.6 16V	06/04-07/08	Z 16 XE	1598	†; mit Anbaumaterial	0-N300	TB [DG]
1.6 16V	06/04-07/08	Z 16 XE	1598		0-N953	TB [DG]
1.8	01/06-07/08	Z 18 XER	1796		0-N1347	TB [TE]
1.8 16V, 1.8 16V Dualfuel	04/02-07/08	Z 18 XE	1796		0-N102	TB [TE]
1.8 16V, 1.8 16V Dualfuel	04/02-07/08	Z 18 XE	1796	†; mit Anbaumaterial	0-N300	TB [DG]
1.8 16V, 1.8 16V Dualfuel	04/02-07/08	Z 18 XE	1796		0-N953	TB [DG]
1.9 CDTi, 1.9 CDTi 16V	04/02-09/08	Z 19 DT, Z 19 DTH, Z 19 DTL	1910		0-N115	TB [TE]
1.9 CDTi, 1.9 CDTi 16V	04/02-09/08	Z 19 DT, Z 19 DTH, Z 19 DTL	1910		0-N2149	TB [DG]
3.0 CDTi, 3.0 V6 CDTi	06/03-07/08	Y 30 DT, Z 30 DT	2958		0-N1353	TB [TE]
3.0 CDTi, 3.0 V6 CDTi	06/03-07/08	Y 30 DT, Z 30 DT	2958		0-N1354	TB [DG]
3.0 CDTi, 3.0 V6 CDTi	06/03-07/08	Y 30 DT, Z 30 DT	2958		0-N1355	TB [DG]
1.6	01/06-07/08	Z 16 XEP	1598		0-N1799	VB [BT] S
1.6 16V	06/04-07/08	Z 16 XE	1598		0-N1466	VB [BT] S
1.8	01/06-07/08	Z 18 XER	1796		0-N1799	VB [BT] S
1.8 16V, 1.8 16V Dualfuel	04/02-07/08	Z 18 XE	1796		0-N1466	VB [BT] S
1.9 CDTi, 1.9 CDTi 16V	04/02-09/08	Z 19 DT, Z 19 DTH, Z 19 DTL	1910	→71111927	0-N1503	VB [BT] S
1.9 CDTi, 1.9 CDTi 16V	04/02-09/08	Z 19 DT, Z 19 DTH, Z 19 DTL	1910	→71111927;	0-N1522	VB [DG]
1.9 CDTi, 1.9 CDTi 16V	04/02-09/08	Z 19 DT, Z 19 DTH, Z 19 DTL	1910	Rippenanzahl: 6	0-N1667	VB [DG]
1.9 CDTi, 1.9 CDTi 16V	04/02-09/08	Z 19 DT, Z 19 DTH, Z 19 DTL	1910	:71111928→	0-N2030	VB [BT] S
2.0 16V Turbo	01/00-10/08	Z 20 NET	1998		0-N1588	VB [BT] S
2.0 DTi 16V	04/02-10/08	Y 20 DTH	1995	Rippenanzahl: 6	0-N1437	VB [DG]
2.0 DTi 16V	04/02-10/08	Y 20 DTH	1995		0-N1485	VB [BT] S
2.0 DTi 16V	04/02-10/08	Y 20 DTH	1995		0-N2169	VB [VD]
2.2 16V, 2.2 direct	01/02-10/08	Z 22 SE, Z 22 YH	2198		0-N1588	VB [BT] S
2.2 DTi 16V	04/02-10/08	Y 22 DTR	2172	Rippenanzahl: 6	0-N1437	VB [DG]
2.2 DTi 16V	04/02-10/08	Y 22 DTR	2172		0-N1485	VB [BT] S
2.2 DTi 16V	04/02-10/08	Y 22 DTR	2172		0-N2169	VB [VD]
2.8 V6 Turbo	08/05-07/08	Z 28 NEL, Z 28 NET	2792		0-N2194	VB [BT] S
3.0 CDTi, 3.0 V6 CDTi	06/03-07/08	Y 30 DT, Z 30 DT	2958		0-N1633	VB [DG]
3.0 CDTi, 3.0 V6 CDTi	06/03-07/08	Y 30 DT, Z 30 DT	2958		0-N1649	VB [DG]
3.0 CDTi, 3.0 V6 CDTi	06/03-07/08	Y 30 DT, Z 30 DT	2958		0-N1717	VB [BT] S
3.2 V6	06/03-07/08	Z 32 SE	3175	Rippenanzahl: 6	0-N1437	VB [DG]
3.2 V6	06/03-07/08	Z 32 SE	3175	Rippenanzahl: 6	0-N1438	VB [BT] S

VECTRA Mk II (C) Estate

1.6 16V	06/04-07/08	Z 16 XE	1598	20x162; mit Zubehör	SK-1355	BTK
1.6 16V	06/04-07/08	Z 16 XE	1598	20x162; mit Zubehör	SK-1355AQ2	BTKW
1.8	01/06-07/08	Z 18 XER	1796	24x146	SK-1607	BTK
1.8, 1.8 16V	04/02-07/08	Z 18 XE, Z 18 XEL	1796	20x162; mit Zubehör	SK-1355	BTK
1.8, 1.8 16V	04/02-07/08	Z 18 XE, Z 18 XEL	1796	20x162; mit Zubehör	SK-1355AQ1	BTKW
1.9 CDTi	04/04-07/08	Z 19 DT, Z 19 DTL	1910	24x190	SK-1696	BTK
1.9 CDTi	04/04-07/08	Z 19 DT	1910	24x190	SK-1696AQ1	BTKW
1.9 CDTi 16V	04/04-07/08	Z 19 DTH	1910	24x199	SK-1586	BTK
1.9 CDTi 16V	04/04-07/08	Z 19 DTH	1910	24x199	SK-1586AQ1	BTKW
3.0 CDTi, 3.0 V6 CDTi	10/03-07/08	Y 30 DT, Z 30 DT	2958	25x116	SK-1611	BTK
1.6 16V	06/04-07/08	Z 16 XE	1598		0-N102	TB [TE]
1.6 16V	06/04-07/08	Z 16 XE	1598	†; mit Anbaumaterial	0-N300	TB [DG]
1.6 16V	06/04-07/08	Z 16 XE	1598		0-N953	TB [DG]
1.8	01/06-07/08	Z 18 XER	1796		0-N1347	TB [TE]
1.8 16V	10/03-08/05	Z 18 XE	1796		0-N102	TB [TE]
1.8 16V	10/03-08/05	Z 18 XE	1796	†; mit Anbaumaterial	0-N300	TB [DG]
1.8 16V	10/03-08/05	Z 18 XE	1796		0-N953	TB [DG]
1.9 CDTi, 1.9 CDTi 16V	04/04-07/08	Z 19 DT, Z 19 DTH, Z 19 DTL	1910		0-N115	TB [TE]
1.9 CDTi, 1.9 CDTi 16V	04/04-07/08	Z 19 DT, Z 19 DTH, Z 19 DTL	1910		0-N2149	TB [DG]
3.0 CDTi, 3.0 V6 CDTi	10/03-07/08	Y 30 DT, Z 30 DT	2958		0-N1353	TB [TE]



CM³



Art. Nr.



VECTRA Mk II (C) Estate

3.0 CDTi, 3.0 V6 CDTi	10/03-07/08	Y 30 DT, Z 30 DT	2958		0-N1354	TB [DG]	
3.0 CDTi, 3.0 V6 CDTi	10/03-07/08	Y 30 DT, Z 30 DT	2958		0-N1355	TB [DG]	
1.6 16V	06/04-07/08	Z 16 XE	1598		0-N1466	VB [BT]	S
1.8	01/06-07/08	Z 18 XER	1796		0-N1799	VB [BT]	S
1.8 16V	10/03-08/05	Z 18 XE	1796		0-N1466	VB [BT]	S
1.9 CDTi, 1.9 CDTi 16V	04/04-07/08	Z 19 DT, Z 19 DTH, Z 19 DTL	1910	→71111927	0-N1503	VB [BT]	S
1.9 CDTi, 1.9 CDTi 16V	04/04-07/08	Z 19 DT, Z 19 DTH, Z 19 DTL	1910	→71111927; *	0-N1522	VB [DG]	
1.9 CDTi, 1.9 CDTi 16V	04/04-07/08	Z 19 DT, Z 19 DTH, Z 19 DTL	1910	Rippenanzahl: 6	0-N1667	VB [DG]	
1.9 CDTi, 1.9 CDTi 16V	04/04-07/08	Z 19 DT, Z 19 DTH, Z 19 DTL	1910	:71111928→	0-N2030	VB [BT]	S
2.0 16V Turbo	10/03-07/08	Z 20 NET	1998		0-N1588	VB [BT]	S
2.0 DTi 16V	10/03-07/08	Y 20 DTH	1995	Rippenanzahl: 6	0-N1437	VB [DG]	
2.0 DTi 16V	10/03-07/08	Y 20 DTH	1995		0-N1485	VB [BT]	S
2.0 DTi 16V	10/03-07/08	Y 20 DTH	1995		0-N2169	VB [VD]	
2.2 direct	10/03-07/08	Z 22 YH	2198		0-N1588	VB [BT]	S
2.2 DTi 16V	10/03-07/08	Y 22 DTR	2172	Rippenanzahl: 6	0-N1437	VB [DG]	
2.2 DTi 16V	10/03-07/08	Y 22 DTR	2172		0-N1485	VB [BT]	S
2.2 DTi 16V	10/03-07/08	Y 22 DTR	2172		0-N2169	VB [VD]	
2.8 V6 Turbo	08/05-07/08	Z 28 NEL, Z 28 NET	2792		0-N2194	VB [BT]	S
3.0 CDTi, 3.0 V6 CDTi	10/03-07/08	Y 30 DT, Z 30 DT	2958		0-N1633	VB [DG]	
3.0 CDTi, 3.0 V6 CDTi	10/03-07/08	Y 30 DT, Z 30 DT	2958	*	0-N1649	VB [DG]	
3.0 CDTi, 3.0 V6 CDTi	10/03-07/08	Y 30 DT, Z 30 DT	2958		0-N1717	VB [BT]	S
3.2 V6	10/03-08/05	Z 32 SE	3175	Rippenanzahl: 6	0-N1437	VB [DG]	
3.2 V6	10/03-08/05	Z 32 SE	3175	Rippenanzahl: 6	0-N1438	VB [BT]	S

VECTRA Mk II (C) GTS

1.6	01/06-07/08	Z 16 XEP	1598	24x146	SK-1607	BTK	
1.6 16V	06/04-07/08	Z 16 XE	1598	20x162; mit Zubehör	SK-1355	BTK	
1.6 16V	06/04-07/08	Z 16 XE	1598	20x162; mit Zubehör	SK-1355AQ2	BTKW	
1.8	01/06-07/08	Z 18 XER	1796	24x146	SK-1607	BTK	
1.8 16V, 1.8 16V Dualfuel	08/02-07/08	Z 18 XE	1796	20x162; mit Zubehör	SK-1355	BTK	
1.8 16V, 1.8 16V Dualfuel	08/02-07/08	Z 18 XE	1796	20x162; mit Zubehör	SK-1355AQ1	BTKW	
1.9 CDTi	08/02-07/08	Z 19 DT	1910	24x190; 04/2004 →	SK-1696	BTK	
1.9 CDTi	08/02-07/08	Z 19 DT	1910	24x190	SK-1696AQ1	BTKW	
1.9 CDTi	10/05-07/08	Z 19 DTL	1910	24x190	SK-1696	BTK	
1.9 CDTi 16V	04/04-07/08	Z 19 DTH	1910	24x199	SK-1586	BTK	
1.9 CDTi 16V	04/04-07/08	Z 19 DTH	1910	24x199	SK-1586AQ1	BTKW	
3.0 CDTi, 3.0 V6 CDTi	06/03-07/08	Y 30 DT, Z 30 DT	2958	25x116	SK-1611	BTK	
1.6 16V	06/04-07/08	Z 16 XE	1598		0-N102	TB [TE]	
1.6 16V	06/04-07/08	Z 16 XE	1598	†; mit Anbaumaterial	0-N300	TB [DG]	
1.6 16V	06/04-07/08	Z 16 XE	1598		0-N953	TB [DG]	
1.8	01/06-07/08	Z 18 XER	1796		0-N1347	TB [TE]	
1.8 16V, 1.8 16V Dualfuel	08/02-07/08	Z 18 XE	1796		0-N102	TB [TE]	
1.8 16V, 1.8 16V Dualfuel	08/02-07/08	Z 18 XE	1796	†; mit Anbaumaterial	0-N300	TB [DG]	
1.8 16V, 1.8 16V Dualfuel	08/02-07/08	Z 18 XE	1796		0-N953	TB [DG]	
1.9 CDTi, 1.9 CDTi 16V	08/02-07/08	Z 19 DT, Z 19 DTH, Z 19 DTL	1910		0-N115	TB [TE]	
1.9 CDTi, 1.9 CDTi 16V	08/02-07/08	Z 19 DT, Z 19 DTH, Z 19 DTL	1910		0-N2149	TB [DG]	
3.0 CDTi, 3.0 V6 CDTi	06/03-07/08	Y 30 DT, Z 30 DT	2958		0-N1353	TB [TE]	
3.0 CDTi, 3.0 V6 CDTi	06/03-07/08	Y 30 DT, Z 30 DT	2958		0-N1354	TB [DG]	
3.0 CDTi, 3.0 V6 CDTi	06/03-07/08	Y 30 DT, Z 30 DT	2958		0-N1355	TB [DG]	
1.6	01/06-07/08	Z 16 XEP	1598		0-N1799	VB [BT]	S
1.6 16V	06/04-07/08	Z 16 XE	1598		0-N1466	VB [BT]	S
1.8	01/06-07/08	Z 18 XER	1796		0-N1799	VB [BT]	S
1.8 16V, 1.8 16V Dualfuel	08/02-07/08	Z 18 XE	1796		0-N1466	VB [BT]	S
1.9 CDTi, 1.9 CDTi 16V	08/02-07/08	Z 19 DT, Z 19 DTH, Z 19 DTL	1910	→71111927	0-N1503	VB [BT]	S
1.9 CDTi, 1.9 CDTi 16V	08/02-07/08	Z 19 DT, Z 19 DTH, Z 19 DTL	1910	→71111927; *	0-N1522	VB [DG]	
1.9 CDTi, 1.9 CDTi 16V	08/02-07/08	Z 19 DT, Z 19 DTH, Z 19 DTL	1910	Rippenanzahl: 6	0-N1667	VB [DG]	
1.9 CDTi, 1.9 CDTi 16V	08/02-07/08	Z 19 DT, Z 19 DTH, Z 19 DTL	1910	:71111928→	0-N2030	VB [BT]	S
2.0 16V Turbo	03/03-07/08	Z 20 NET	1998		0-N1588	VB [BT]	S
2.0 DTi 16V	08/02-07/08	Y 20 DTH	1995	Rippenanzahl: 6	0-N1437	VB [DG]	
2.0 DTi 16V	08/02-07/08	Y 20 DTH	1995		0-N1485	VB [BT]	S
2.0 DTi 16V	08/02-07/08	Y 20 DTH	1995		0-N2169	VB [VD]	
2.2 16V, 2.2 direct	08/02-07/08	Z 22 SE, Z 22 YH	2198		0-N1588	VB [BT]	S
2.2 DTi 16V	08/02-07/08	Y 22 DTR	2172	Rippenanzahl: 6	0-N1437	VB [DG]	
2.2 DTi 16V	08/02-07/08	Y 22 DTR	2172		0-N1485	VB [BT]	S
2.2 DTi 16V	08/02-07/08	Y 22 DTR	2172		0-N2169	VB [VD]	
2.8 V6 Turbo	08/05-07/08	Z 28 NEL, Z 28 NET	2792		0-N2194	VB [BT]	S



OPTIMAL®

VAUXHALL



CM³



Art. Nr.



ohne Halter

VECTRA Mk II (C) GTS

3.0 CDTi, 3.0 V6 CDTi	06/03-07/08	Y 30 DT, Z 30 DT	2958		0-N1633	VB [DG]	
3.0 CDTi, 3.0 V6 CDTi	06/03-07/08	Y 30 DT, Z 30 DT	2958	☼	0-N1649	VB [DG]	
3.0 CDTi, 3.0 V6 CDTi	06/03-07/08	Y 30 DT, Z 30 DT	2958		0-N1717	VB [BT]	S
3.2 V6	08/02-07/08	Z 32 SE	3175	Rippenanzahl: 6	0-N1437	VB [DG]	
3.2 V6	08/02-07/08	Z 32 SE	3175	Rippenanzahl: 6	0-N1438	VB [BT]	S

VIVARO Combi (J7)

1.9 DI, 1.9 DTI	08/01-12/06	F9Q 760, F9Q 762	1870	26x132	SK-1493	BTK	
1.9 DI, 1.9 DTI	08/01-12/06	F9Q 760, F9Q 762	1870	26x132	SK-1493AQ1	BTKW	
1.9 DI, 1.9 DTI	08/01-12/06	F9Q 760, F9Q 762	1870	26x132	SK-1493AQ2	BTKW	
2.0 16V	08/01-12/06	F4R 720	1998	27x126	SK-1624	BTK	
2.5 CDTi	01/06-07/14	G9U 630	2464	25x89; 08/2006 →; mit Zubehör	SK-1489	BTK	
2.5 DTI	07/03-07/14	G9U 630, G9U 730	2463	25x89; mit Zubehör	SK-1489	BTK	
1.9 DI, 1.9 DTI	08/01-12/06	F9Q 760, F9Q 762	1870	mit Grundträger	0-N1173	TB [BT]	
2.0 16V	08/01-12/06	F4R 720	1998		0-N1365	TB [DG]	
2.5 CDTi	01/06-07/14	G9U 630	2464		0-N1269	TB [TE]	
2.5 CDTi	01/06-07/14	G9U 630	2464		0-N1270	TB [DG]	
2.5 DTI	07/03-07/14	G9U 630, G9U 730	2463		0-N1269	TB [TE]	
2.5 DTI	07/03-07/14	G9U 630, G9U 730	2463		0-N1270	TB [DG]	
1.9 DI, 1.9 DTI	08/01-12/06	F9Q 760, F9Q 762	1870	02/2002 →	0-N1409	VB [DG]	
1.9 DI, 1.9 DTI	08/01-12/06	F9Q 760, F9Q 762	1870	☼	0-N1611	VB [BT]	S
1.9 DI, 1.9 DTI	08/01-12/06	F9Q 760, F9Q 762	1870	Rippenanzahl: 6; ☼	0-N1648	VB [DG]	
2.0 16V	08/01-12/06	F4R 720	1998	02/2002 →	0-N1409	VB [DG]	
2.0 16V	08/01-12/06	F4R 720	1998	☼	0-N1611	VB [BT]	S
2.0 CDTi	01/06-07/14	M9R 630, M9R 780, M9R 782, M9R 786, M9R 630, M9R 780, M9R 784, M9R 786, M9R 788	1995		0-N1739	VB [DG]	
2.0 CDTi	01/06-07/14	M9R 630, M9R 780, M9R 782, M9R 786, M9R 630, M9R 780, M9R 784, M9R 786, M9R 788	1995		0-N2039	VB [BT]	S
2.5 CDTi	01/06-07/14	G9U 630	2464		0-N1409	VB [DG]	
2.5 CDTi	01/06-07/14	G9U 630	2464	☼	0-N1731	VB [BT]	S
2.5 DTI	07/03-07/14	G9U 630, G9U 730	2463		0-N1409	VB [DG]	
2.5 DTI	07/03-07/14	G9U 630, G9U 730	2463	Rippenanzahl: 6; ☼	0-N1648	VB [DG]	
2.5 DTI	07/03-07/14	G9U 630, G9U 730	2463	☼	0-N1731	VB [BT]	S

VIVARO Kasten (F7)

1.9 DI, 1.9 DTI	08/01-12/06	F9Q 760, F9Q 762	1870	26x132	SK-1493	BTK	
1.9 DI, 1.9 DTI	08/01-12/06	F9Q 760, F9Q 762	1870	26x132	SK-1493AQ1	BTKW	
1.9 DI, 1.9 DTI	08/01-12/06	F9Q 760, F9Q 762	1870	26x132	SK-1493AQ2	BTKW	
2.0 16V	08/01-12/06	F4R 720	1998	27x126; 03/2002 →	SK-1624	BTK	
2.5 CDTi	08/06-07/14	G9U 630	2464	25x89; mit Zubehör	SK-1489	BTK	
2.5 DTI	07/03-07/14	G9U 630, G9U 730	2463	25x89; mit Zubehör	SK-1489	BTK	
1.9 DI, 1.9 DTI	08/01-12/06	F9Q 760, F9Q 762	1870	mit Grundträger	0-N1173	TB [BT]	
2.0 16V	08/01-12/06	F4R 720	1998		0-N1365	TB [DG]	
2.5 CDTi	08/06-07/14	G9U 630	2464		0-N1269	TB [TE]	
2.5 CDTi	08/06-07/14	G9U 630	2464		0-N1270	TB [DG]	
2.5 DTI	07/03-07/14	G9U 630, G9U 730	2463		0-N1269	TB [TE]	
2.5 DTI	07/03-07/14	G9U 630, G9U 730	2463		0-N1270	TB [DG]	
1.9 DI, 1.9 DTI	08/01-12/06	F9Q 760, F9Q 762	1870	02/2002 →	0-N1409	VB [DG]	
1.9 DI, 1.9 DTI	08/01-12/06	F9Q 760, F9Q 762	1870	☼	0-N1611	VB [BT]	S
1.9 DI, 1.9 DTI	08/01-12/06	F9Q 760, F9Q 762	1870	Rippenanzahl: 6; ☼	0-N1648	VB [DG]	
2.0 16V	08/01-12/06	F4R 720	1998	02/2002 →	0-N1409	VB [DG]	
2.0 16V	08/01-12/06	F4R 720	1998	☼	0-N1611	VB [BT]	S
2.0 CDTi	01/06-07/14	M9R 630, M9R 692, M9R 780, M9R 788, M9R 630, M9R 780, M9R 782, M9R 786	1995		0-N1739	VB [DG]	
2.0 CDTi	01/06-07/14	M9R 630, M9R 692, M9R 780, M9R 788, M9R 630, M9R 780, M9R 782, M9R 786	1995		0-N2039	VB [BT]	S
2.5 CDTi	08/06-07/14	G9U 630	2464		0-N1409	VB [DG]	
2.5 CDTi	08/06-07/14	G9U 630	2464	☼	0-N1731	VB [BT]	S
2.5 DTI	07/03-07/14	G9U 630, G9U 730	2463		0-N1409	VB [DG]	
2.5 DTI	07/03-07/14	G9U 630, G9U 730	2463	Rippenanzahl: 6; ☼	0-N1648	VB [DG]	
2.5 DTI	07/03-07/14	G9U 630, G9U 730	2463	☼	0-N1731	VB [BT]	S

VIVARO Pritsche/Fahrgestell (E7)

1.9 DI	04/03-07/14	F9Q 762	1870	26x132	SK-1493	BTK	
1.9 DI	04/03-07/14	F9Q 762	1870	26x132	SK-1493AQ1	BTKW	
2.5 CDTi	04/03-07/14	G9U 630, G9U 730, G9U 730	2463	25x89; mit Zubehör	SK-1489	BTK	
2.5 CDTi	08/06-07/14	G9U 630	2464	25x89; mit Zubehör	SK-1489	BTK	

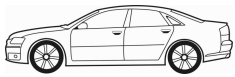

CM³



Art. Nr.



ohne Halter

VIVARO Pritsche/Fahrgestell (E7)

2.5 CDTI	04/03-07/14	G9U 630, G9U 730, G9U 730	2463		0-N1269	TB [TE]	
2.5 CDTI	04/03-07/14	G9U 630, G9U 730, G9U 730	2463		0-N1270	TB [DG]	
2.5 CDTI	08/06-07/14	G9U 630	2464		0-N1269	TB [TE]	
2.5 CDTI	08/06-07/14	G9U 630	2464		0-N1270	TB [DG]	
2.0 CDTI	01/06-07/14	M9R 630, M9R 780, M9R 782, M9R 786, M9R 630, M9R 780, M9R 788	1995		0-N1739	VB [DG]	
2.0 CDTI	01/06-07/14	M9R 630, M9R 780, M9R 782, M9R 786, M9R 630, M9R 780, M9R 788	1995		0-N2039	VB [BT]	S
2.5 CDTI	04/03-07/14	G9U 630, G9U 730, G9U 730	2463		0-N1409	VB [DG]	
2.5 CDTI	04/03-07/14	G9U 630, G9U 730, G9U 730	2463	✳	0-N1731	VB [BT]	S
2.5 CDTI	08/06-07/14	G9U 630	2464		0-N1409	VB [DG]	
2.5 CDTI	08/06-07/14	G9U 630	2464	✳	0-N1731	VB [BT]	S

VX220

2.0 i Turbo	03/01-07/05	Z 20 LET	1998	24x168; ch.→3N999999	SK-1632	BTK	
2.0 i Turbo	03/01-07/05	Z 20 LET	1998	24x168; ch.→3N999999	SK-1632AQ1	BTKW	
2.0 i Turbo	03/01-07/05	Z 20 LET	1998	24x168; ch.4N000001→	SK-1667	BTK	
2.0 i Turbo	03/01-07/05	Z 20 LET	1998	24x168; ch.4N000001→	SK-1667AQ1	BTKW	
2.0 i Turbo	03/01-07/05	Z 20 LET	1998	→ 12/2003	0-N127	TB [DG]	
2.0 i Turbo	03/01-07/05	Z 20 LET	1998	01/2004 →	0-N127	TB [DG]	
2.0 i Turbo	03/01-07/05	Z 20 LET	1998		0-N1369	TB [TE]	
2.0 i Turbo	03/01-07/05	Z 20 LET	1998	01/2004 →	0-N1574	TB [DG]	
2.2 i	09/00-07/05	Z 22 SE	2198		0-N1588	VB [BT]	S

ZAFIRA Mk I (A) (F75)

1.6 16V	04/99-08/05	X 16 XEL, Z 16 XE	1598	20x162; :→02HL5117, 20041690; mit Zubehör	SK-1113	BTK	
1.6 16V	04/99-08/05	X 16 XEL, Z 16 XE	1598	20x162; :02MV7225, 20U75999→; mit Zubehör	SK-1355AQ2	BTKW	
1.6 16V	04/99-08/05	X 16 XEL, Z 16 XE	1598	20x162; :02HL5118, 20041691→; :→02MV7224	SK-1355AQ3	BTKW	
1.6 16V, 1.6 Dualfuel	11/98-08/05	X 16 XEL, Z 16 XE	1598	20x162; :→02HL5117, 20041690; mit Zubehör	SK-1113AQ1	BTKW	
1.6 16V, 1.6 Dualfuel	11/98-08/05	X 16 XEL, Z 16 XE	1598	20x162; :02HL5118, 20041691→; mit Zubehör	SK-1355	BTK	
1.6 CNG	09/01-06/05	Z 16 YNG	1598	20x162; mit Zubehör	SK-1355	BTK	
1.6 CNG	09/01-06/05	Z 16 YNG	1598	20x162; mit Zubehör	SK-1355AQ2	BTKW	
1.8 16V, 1.8 Dualfuel	05/99-08/05	X 18 XE1, Z 18 XE	1796	20x162; :→02HL5117, 20041690; mit Zubehör	SK-1113	BTK	
1.8 16V, 1.8 Dualfuel	05/99-08/05	X 18 XE1, Z 18 XE	1796	20x162; :→02HL5117, 20041690; mit Zubehör	SK-1113AQ2	BTKW	
1.8 16V, 1.8 Dualfuel	05/99-08/05	X 18 XE1, Z 18 XE	1796	20x162; :02HL5118, 20041691→; mit Zubehör	SK-1355	BTK	
1.8 16V, 1.8 Dualfuel	05/99-08/05	X 18 XE1, Z 18 XE	1796	20x162; :02HL5118, 20041691→; mit Zubehör	SK-1355AQ1	BTKW	
2.0, 2.0 GSI Turbo	09/01-06/05	Z 20 LET	1998	24x168; ch.→32999999, 35999999	SK-1632	BTK	
2.0, 2.0 GSI Turbo	09/01-06/05	Z 20 LET	1998	24x168; ch.→36999999, 38999999	SK-1632	BTK	
2.0, 2.0 GSI Turbo	09/01-06/05	Z 20 LET	1998	24x168; ch.→3B999999, 3H999999	SK-1632	BTK	
2.0, 2.0 GSI Turbo	09/01-06/05	Z 20 LET	1998	24x168; ch.→32999999, 35999999	SK-1632AQ1	BTKW	
2.0, 2.0 GSI Turbo	09/01-06/05	Z 20 LET	1998	24x168; ch.→36999999, 38999999	SK-1632AQ1	BTKW	
2.0, 2.0 GSI Turbo	09/01-06/05	Z 20 LET	1998	24x168; ch.→3B999999, 3H999999	SK-1632AQ1	BTKW	
2.0, 2.0 GSI Turbo	09/01-06/05	Z 20 LET	1998	24x168; ch.→3G999999	SK-1632AQ1	BTKW	
2.0, 2.0 GSI Turbo	09/01-06/05	Z 20 LET	1998	24x168; ch.42000001, 45000001→	SK-1667	BTK	
2.0, 2.0 GSI Turbo	09/01-06/05	Z 20 LET	1998	24x168; ch.48000001, 4B000001→	SK-1667	BTK	
2.0, 2.0 GSI Turbo	09/01-06/05	Z 20 LET	1998	24x168; ch.4G000001, 4H000001→	SK-1667	BTK	
2.0, 2.0 GSI Turbo	09/01-06/05	Z 20 LET	1998	24x168; ch.42000001, 45000001→	SK-1667AQ1	BTKW	
2.0, 2.0 GSI Turbo	09/01-06/05	Z 20 LET	1998	24x168; ch.48000001, 4B000001→	SK-1667AQ1	BTKW	
2.0, 2.0 GSI Turbo	09/01-06/05	Z 20 LET	1998	24x168; ch.4G000001, 4H000001→	SK-1667AQ1	BTKW	
1.6 16V	04/99-08/05	X 16 XEL, Z 16 XE	1598	:02HL5118, 20041691→; ; mit Anbaumaterial	0-N300	TB [DG]	
1.6 16V	04/99-08/05	X 16 XEL, Z 16 XE	1598	:→02HL5117, 20041690	0-N952	TB [DG]	
1.6 16V, 1.6 CNG	04/99-08/05	X 16 XEL, Z 16 XE, Z 16 YNG	1598		0-N102	TB [TE]	
1.6 16V, 1.6 CNG	04/99-08/05	X 16 XEL, Z 16 XE, Z 16 YNG	1598		0-N953	TB [DG]	
1.6 CNG	09/01-06/05	Z 16 YNG	1598	; mit Anbaumaterial	0-N300	TB [DG]	
1.8 16V	05/99-08/05	X 18 XE1, Z 18 XE	1796		0-N102	TB [TE]	
1.8 16V	05/99-08/05	X 18 XE1, Z 18 XE	1796	:02HL5118, 20041691→; ; mit Anbaumaterial	0-N300	TB [DG]	
1.8 16V	05/99-08/05	X 18 XE1, Z 18 XE	1796	:→02HL5117, 20041690	0-N952	TB [DG]	
1.8 16V	05/99-08/05	X 18 XE1, Z 18 XE	1796		0-N953	TB [DG]	
2.0, 2.0 GSI Turbo	09/01-06/05	Z 20 LET	1998	→ 12/2003	0-N127	TB [DG]	

CM³

Art. Nr.

**ZAFIRA Mk I (A) (F75)**

2.0, 2.0 GSI Turbo	09/01-06/05	Z 20 LET	1998	01/2004 →	0-N127	TB [DG]	
2.0, 2.0 GSI Turbo	09/01-06/05	Z 20 LET	1998		0-N1369	TB [TE]	
2.0, 2.0 GSI Turbo	09/01-06/05	Z 20 LET	1998	01/2004 →	0-N1574	TB [DG]	
1.6 16V, 1.6 CNG, 1.6 Dualfuel	11/98-08/05	X 16 XEL, Z 16 XE, Z 16 YNG	1598		0-N1466	VB [BT]	S
1.8 16V, 1.8 Dualfuel	05/99-08/05	X 18 XE1, Z 18 XE	1796		0-N1466	VB [BT]	S
2.0 DI 16V, 2.0 DTI 16V	04/99-08/05	X 20 DTL, Y 20 DTH	1995	Rippenanzahl: 6	0-N1437	VB [DG]	
2.0 DI 16V, 2.0 DTI 16V	04/99-08/05	X 20 DTL, Y 20 DTH	1995		0-N1485	VB [BT]	S
2.0 DI 16V, 2.0 DTI 16V	04/99-08/05	X 20 DTL, Y 20 DTH	1995		0-N2169	VB [VD]	
2.2 16V	11/98-08/04	Z 22 SE	2198		0-N1588	VB [BT]	S
2.2 D	06/01-06/05	Y 22 DTR	2172	Rippenanzahl: 6	0-N1437	VB [DG]	
2.2 D	06/01-06/05	Y 22 DTR	2172		0-N1485	VB [BT]	S
2.2 D	06/01-06/05	Y 22 DTR	2172		0-N2169	VB [VD]	

ZAFIRA Mk II (B) (M75)

1.6 CNG	07/05-11/14	Z 16 YNG	1598	20x162; mit Zubehör	SK-1355	BTK	
1.6 CNG	07/05-11/14	Z 16 YNG	1598	20x162; mit Zubehör	SK-1355AQ2	BTKW	
1.6, 1.6 CNG Turbo	07/05-11/14	A 16 XER, Z 16 XER, A 16 XNT, Z 16 XNT, Z 16 XE1, Z 16 XEP	1598	24x146	SK-1607	BTK	
1.7 CDTi	01/08-11/14	A 17 DTJ, Z 17 DTJ, A 17 DTR	1686	25x131; mit Zubehör	SK-1481	BTK	
1.8	04/05-11/14	A 18 XER, Z 18 XER	1796	24x146; 02/2006 →	SK-1607	BTK	
1.9 CDTi	07/05-11/14	Z 19 DTH	1910	24x199	SK-1586	BTK	
1.9 CDTi	07/05-11/14	Z 19 DTH	1910	24x199	SK-1586AQ1	BTKW	
1.9 CDTi	07/05-11/14	Z 19 DT, Z 19 DTL	1910	24x190	SK-1696	BTK	
1.9 CDTi	07/05-11/14	Z 19 DT, Z 19 DTL	1910	24x190	SK-1696AQ1	BTKW	
2.0	07/05-11/14	Z 20 LEH, Z 20 LER	1998	24x168	SK-1667	BTK	
2.0	07/05-11/14	Z 20 LEH, Z 20 LER	1998	24x168	SK-1667AQ1	BTKW	
1.6	07/05-11/14	Z 16 XE1, Z 16 XEP	1598		0-N1348	TB [DG]	
1.6, 1.6 CNG Turbo	07/05-11/14	A 16 XER, Z 16 XER, A 16 XNT, Z 16 XNT, Z 16 XE1, Z 16 XEP	1598		0-N1347	TB [TE]	
1.7 CDTi	01/08-11/14	A 17 DTJ, Z 17 DTJ, A 17 DTR	1686		0-N1085	TB [TE]	
1.7 CDTi	01/08-11/14	A 17 DTJ, Z 17 DTJ, A 17 DTR	1686		0-N878	TB [DG]	
1.8	04/05-11/14	A 18 XEL, A 18 XER, Z 18 XER	1796		0-N1347	TB [TE]	
1.8	04/05-11/14	A 18 XER, Z 18 XER	1796		0-N1348	TB [DG]	
1.9 CDTi	07/05-11/14	Z 19 DT, Z 19 DTH, Z 19 DTL	1910		0-N115	TB [TE]	
1.9 CDTi	07/05-11/14	Z 19 DT, Z 19 DTH, Z 19 DTL	1910		0-N2149	TB [DG]	
2.0	07/05-11/14	Z 20 LEH, Z 20 LER	1998		0-N127	TB [DG]	
2.0	07/05-11/14	Z 20 LEH, Z 20 LER	1998		0-N1369	TB [TE]	
2.0	07/05-11/14	Z 20 LEH, Z 20 LER	1998		0-N1574	TB [DG]	
1.6 CNG	07/05-11/14	Z 16 YNG	1598		0-N1466	VB [BT]	S
1.6, 1.6 CNG, 1.6 CNG Turbo	07/05-11/14	A 16 XER, Z 16 XER, A 16 XNT, Z 16 XNT, Z 16 XE1, Z 16 XEP, Z 16 YNG	1598		0-N1799	VB [BT]	S
1.7 CDTi	01/08-11/14	A 17 DTJ, Z 17 DTJ, A 17 DTR	1686		0-N1798	VB [BT]	S
1.8	04/05-11/14	A 18 XER, Z 18 XER	1796		0-N1799	VB [BT]	S
1.9 CDTi	07/05-11/14	Z 19 DT, Z 19 DTH	1910	ENGINE: →71111927	0-N1503	VB [BT]	S
1.9 CDTi	07/05-11/14	Z 19 DT, Z 19 DTH	1910	ENGINE: →71111927; ⚡	0-N1522	VB [DG]	
1.9 CDTi	07/05-11/14	Z 19 DT, Z 19 DTH	1910	Rippenanzahl: 6	0-N1667	VB [DG]	
1.9 CDTi	07/05-11/14	Z 19 DT, Z 19 DTH	1910	ENGINE: 71111928→	0-N2030	VB [BT]	S
2.2	07/05-11/14	Z 22 YH	2198		0-N1588	VB [BT]	S

ZAFIRA Mk III (P12)

1.6 CNG	10/11-	A 16 XNT	1598	24x146	SK-1607	BTK	
1.8	10/11-	A 18 XEL, A 18 XER	1796	24x146	SK-1607	BTK	
2.0 CDTi	10/11-	A 20 DT, Y 20 DTJ, Z 20 DTJ, A 20 DTH, A 20 DTL	1956	24x199	SK-1586	BTK	
2.0 CDTi	10/11-	A 20 DT, Y 20 DTJ, Z 20 DTJ, A 20 DTH, A 20 DTL	1956	24x199	SK-1586AQ1	BTKW	
1.6 CNG	10/11-	A 16 XNT	1598		0-N1347	TB [TE]	
1.8	10/11-	A 18 XEL, A 18 XER	1796		0-N1347	TB [TE]	
2.0 BiTurbo CDTi, 2.0 CDTi	10/11-	A 20 DT, Y 20 DTJ, Z 20 DTJ, A 20 DTH, A 20 DTL, A 20 DTR	1956		0-N2149	TB [DG]	
1.4, 1.4 LPG	10/11-	A 14 NEL, A 14 NET, A 14 NET, B 14 NET	1364		0-N2170	VB [BT]	S
1.6 CDTi	03/13-	B 16 DTH	1598	⚡	0-N1649	VB [DG]	
1.6 CNG	10/11-	A 16 XNT	1598		0-N1799	VB [BT]	S
1.8	10/11-	A 18 XEL, A 18 XER	1796		0-N1799	VB [BT]	S
2.0 BiTurbo CDTi, 2.0 CDTi	10/11-	A 20 DT, Y 20 DTJ, Z 20 DTJ, A 20 DTH, A 20 DTL, A 20 DTR	1956	⚡	0-N1649	VB [DG]	
2.0 BiTurbo CDTi, 2.0 CDTi	10/11-	A 20 DT, Y 20 DTJ, Z 20 DTJ, A 20 DTH, A 20 DTL, A 20 DTR	1956	für Fahrzeuge mit elektrischer Servolenkung	0-N2254	VB [DG]	

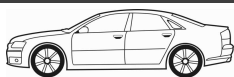

CM³



Art. Nr.



ohne Halter

ZAFIRA Mk III (P12)

2.0 CDTi	10/11-	A 20 DT, Y 20 DTJ, Z 20 DTJ, A 20 DTH, A 20 DTL	1956		0-N2087	VB [BT]	S
2.0 CDTi	10/11-	A 20 DT, Y 20 DTJ, Z 20 DTJ, A 20 DTH, A 20 DTL	1956		0-N2221	VB [DG]	



CM³



Art. Nr.



240 (P242, P244)

2.0	08/74-07/85	B 19 A, B 19 A, B 19 K, B 19 ET, B 20 A, B 200 K	1986	19x123	SK-1061	BTK
2.0	09/84-12/93	B 19 E, B 200 F, B 200 E	1986	19x123; → 12/1992	SK-1061	BTK
2.0	09/84-12/93	B 19 E, B 200 F, B 200 E	1986	19.05x123; 01/1993 →	SK-1172	BTK
2.1, 2.1 Turbo	08/74-07/84	B 21 A, B 21 E, B 21 ET	2127	19x123	SK-1061	BTK
2.3	08/78-12/89	B 23 E, B 230 E, B 230 K	2316	19x123	SK-1061	BTK
2.3	08/80-07/83	B 23 E, B 230 FX	2316	19x123; 10/1982 →	SK-1061	BTK
2.3	08/80-07/87	B 23 A, B 230 A, B 230 F	2315	19x123	SK-1061	BTK
2.3 i KAT	08/86-07/93	B 230 F	2316	19x123; → 12/1992	SK-1061	BTK
2.3 i KAT	08/86-07/93	B 230 F	2316	19.05x123	SK-1172	BTK
2.4 Diesel	08/78-08/93	D 24	2383	20x75; 25.4x119	SK-1129	BTK
2.4 Diesel	08/78-08/93	D 24	2383	25x119	SK-1129AQ1	BTKW
2.0	08/74-07/85	B 19 A, B 19 A, B 19 K, B 20 A, B 200 K	1986		0-N860	TB [TE]
2.1, 2.1 Turbo	08/74-07/84	B 21 A, B 21 E, B 21 ET	2127		0-N860	TB [TE]
2.3	08/80-07/87	B 23 A, B 230 A, B 230 F	2315		0-N860	TB [TE]
2.3, 2.3 i KAT	08/78-07/93	B 23 E, B 23 E, B 230 FX, B 230 E, B 230 F	2316		0-N860	TB [TE]
2.4 Diesel	08/78-08/93	D 24	2383		0-N807	TB [DG]

240 Kombi (P245)

2.0	08/74-07/85	B 19 A, B 19 ET, B 20 A, B 200 K	1986	19x123	SK-1061	BTK
2.0	08/80-12/84	B 19 A, B 19 K	1986	19x123; 10/1982 →	SK-1061	BTK
2.0	08/83-12/93	B 200 E, B 200 F	1986	19x123; → 12/1992	SK-1061	BTK
2.0	08/83-07/93	B 200 E	1986	19.05x123	SK-1172	BTK
2.0	09/88-12/93	B 200 F	1986	19.05x123; 01/1993 →	SK-1172	BTK
2.0 D	09/78-10/80	D 20	1985	20x75; 25.4x119	SK-1129	BTK
2.0 D	09/78-10/80	D 20	1985	25x119	SK-1129AQ1	BTKW
2.1, 2.1 Turbo	08/74-07/85	B 21 A, B 21 E, B 21 ET, B 21 F	2127	19x123	SK-1061	BTK
2.3	08/80-07/86	B 23 A, B 230 A	2315	19x123	SK-1061	BTK
2.3 i KAT	08/86-07/93	B 230 F	2316	19.05x123	SK-1172	BTK
2.3, 2.3 i KAT, 2.3 KAT	01/83-07/93	B 23 E, B 230 E, B 230 F, B 230 K	2316	19x123	SK-1061	BTK
2.4 Diesel	04/79-08/93	D 24	2383	20x75; 25.4x119	SK-1129	BTK
2.4 Diesel	04/79-08/93	D 24	2383	25x119	SK-1129AQ1	BTKW
2.0	08/74-07/85	B 19 A, B 19 A, B 19 K, B 20 A, B 200 K	1986		0-N860	TB [TE]
2.1, 2.1 Turbo	08/74-07/85	B 21 A, B 21 E, B 21 ET, B 21 F	2127		0-N860	TB [TE]
2.3	08/80-07/86	B 23 A, B 230 A	2315		0-N860	TB [TE]
2.3, 2.3 i KAT	01/83-07/93	B 23 E, B 230 E, B 230 F	2316		0-N860	TB [TE]
2.4 Diesel	04/79-08/93	D 24	2383		0-N807	TB [DG]

340-360 (343, 345)

1.6 Diesel	08/84-07/91	D 16	1596	25.4x153; :32768 →; Baumuster: 34_	SK-1012	BTK
1.6 Diesel	08/84-07/91	D 16	1596	25.4x153; : →32767	SK-1015	BTK
1.7	08/85-07/91	B 17 2 K	1721	19.05x124; : →51891	SK-1010	BTK
1.7	08/85-07/91	B 17 2 K	1721	19x125; :51892 →; Baumuster: 34_	SK-1011	BTK
2.0	08/80-07/89	B 19 A, B 19 A, B 200 K, B 19 E, B 200 E, B 200 E, B 200 F, B 200 F, B 200 K	1986	19x123	SK-1061	BTK
1.6 Diesel	08/84-07/91	D 16	1596	:32768 →	0-N173	TB [TE]
1.6 Diesel	08/84-07/91	D 16	1596	:32768 →	0-N854	TB [DG]
1.6 Diesel	08/84-07/91	D 16	1596	: →32767	0-N883	TB [TE]
1.6 Diesel	08/84-07/91	D 16	1596	: →32767	0-N887	TB [DG]
1.7	08/85-07/91	B 17 2 K	1721	:51892 →	0-N173	TB [TE]
1.7	08/85-07/91	B 17 2 K	1721	:51892 →	0-N854	TB [DG]
1.7	08/85-07/91	B 17 2 K	1721	: →51891	0-N856	TB [TE]
1.7	08/85-07/91	B 17 2 K	1721	: →51891	0-N887	TB [DG]
2.0	08/80-07/89	B 19 A, B 19 A, B 200 K, B 19 E, B 200 E, B 200 E, B 200 F, B 200 F, B 200 K	1986		0-N860	TB [TE]
2.1	08/81-07/82	B 21 E	2127		0-N860	TB [TE]

340-360 Stufenheck (344)

1.6 Diesel	08/84-07/91	D 16	1596	25.4x153; :32768 →; Baumuster: 34_	SK-1012	BTK
1.6 Diesel	08/84-07/91	D 16	1596	25.4x153; : →32767	SK-1015	BTK
1.7	08/85-07/91	B 17 2 K	1721	19.05x124; : →51891	SK-1010	BTK
1.7	08/85-07/91	B 17 2 K	1721	19x125; :51892 →; Baumuster: 34_	SK-1011	BTK
2.0	08/82-07/84	B 19 A	1986	19x123; 09/1983 →	SK-1061	BTK
2.0	08/83-07/90	B 19 A, B 19 E, B 200 E, B 200 EA, B 200 F, B 200 K	1986	19x123	SK-1061	BTK
1.6 Diesel	08/84-07/91	D 16	1596	:32768 →	0-N173	TB [TE]
1.6 Diesel	08/84-07/91	D 16	1596	:32768 →	0-N854	TB [DG]
1.6 Diesel	08/84-07/91	D 16	1596	: →32767	0-N883	TB [TE]

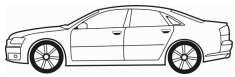

CM³



Art. Nr.



340-360 Stufenheck (344)

1.6 Diesel	08/84-07/91	D 16	1596	:→32767	0-N887	TB [DG]
1.7	08/85-07/91	B 17 2 K	1721	:51892→	0-N173	TB [TE]
1.7	08/85-07/91	B 17 2 K	1721	:51892→	0-N854	TB [DG]
1.7	08/85-07/91	B 17 2 K	1721	:→51891	0-N856	TB [TE]
1.7	08/85-07/91	B 17 2 K	1721	:→51891	0-N887	TB [DG]
2.0	08/82-07/90	B 19 A, B 19 E, B 200 E, B 200 EA, B 200 F, B 200 K	1986		0-N860	TB [TE]

440 K (445)

1.6	09/88-12/96	B 16 F	1596	19x125	SK-1011	BTK
1.7, 1.7 Turbo	08/88-12/96	B 18 EP, B 18 F, B 18 FP, B 18 FT, B 18 K, B 18 KP, B 18 KD, B 18 KP	1721	19x125	SK-1011	BTK
1.8	08/91-12/96	B 18 U	1794	19x125	SK-1011	BTK
1.9 Turbo-Diesel	07/94-12/96	D 19 T	1870	25.4x153	SK-1012	BTK
2.0	08/92-07/96	B 20 F	1998	19x127	SK-1036	BTK
1.6	09/88-12/96	B 16 F	1596		0-N173	TB [TE]
1.6	09/88-12/96	B 16 F	1596		0-N854	TB [DG]
1.7	08/88-07/89	B 18 F	1721	:01726→	0-N173	TB [TE]
1.7	08/88-07/89	B 18 F	1721	:01726→	0-N854	TB [DG]
1.7	08/88-07/89	B 18 F	1721	:→01725	0-N856	TB [TE]
1.7	08/88-07/89	B 18 F	1721	:→01725	0-N887	TB [DG]
1.7, 1.7 Turbo	08/88-12/96	B 18 EP, B 18 FP, B 18 FT, B 18 KP	1721		0-N173	TB [TE]
1.7, 1.7 Turbo	08/88-12/96	B 18 EP, B 18 FP, B 18 FT, B 18 KP	1721		0-N854	TB [DG]
1.8	08/91-12/96	B 18 U	1794		0-N173	TB [TE]
1.8	08/91-12/96	B 18 U	1794		0-N854	TB [DG]
1.9 Turbo-Diesel	07/94-12/96	D 19 T	1870		0-N173	TB [TE]
1.9 Turbo-Diesel	07/94-12/96	D 19 T	1870		0-N854	TB [DG]
2.0	08/92-07/96	B 20 F	1998		0-N173	TB [TE]
2.0	08/92-07/96	B 20 F	1998		0-N854	TB [DG]

460 L (464)

1.6	07/92-07/96	B 16 F	1596	19x125; 09/1993 →	SK-1011	BTK
1.7	09/88-07/96	B 18 KP	1721	19x125; 09/1989 →	SK-1011	BTK
1.7, 1.7 Turbo	08/89-07/96	B 18 E, B 18 EP, B 18 FT, B 18 KD, B 18 KP	1721	19x125	SK-1011	BTK
1.8	08/91-07/96	B 18 U	1794	19x125	SK-1011	BTK
1.9 Turbo-Diesel	07/94-07/96	D 19 T	1870	25.4x153	SK-1012	BTK
2.0	08/92-07/96	B 20 F	1998	19x127	SK-1036	BTK
1.6	07/92-07/96	B 16 F	1596		0-N173	TB [TE]
1.6	07/92-07/96	B 16 F	1596		0-N854	TB [DG]
1.7, 1.7 Turbo	09/88-07/96	B 18 E, B 18 EP, B 18 FT, B 18 KP	1721		0-N173	TB [TE]
1.7, 1.7 Turbo	09/88-07/96	B 18 EP, B 18 FT, B 18 KP	1721		0-N854	TB [DG]
1.8	08/91-07/96	B 18 U	1794		0-N173	TB [TE]
1.8	08/91-07/96	B 18 U	1794		0-N854	TB [DG]
1.9 Turbo-Diesel	07/94-07/96	D 19 T	1870		0-N173	TB [TE]
1.9 Turbo-Diesel	07/94-07/96	D 19 T	1870		0-N854	TB [DG]
2.0	08/92-07/96	B 20 F	1998		0-N173	TB [TE]
2.0	08/92-07/96	B 20 F	1998		0-N854	TB [DG]

480 E

1.7	04/86-07/89	B 18 E	1721	19x125	SK-1011	BTK
1.7	08/87-07/89	B 18 F	1721	19.05x124; :→1455, 1725	SK-1010	BTK
1.7	08/87-07/96	B 18 EP, B 18 F	1721	19x125; :1456, 1726→	SK-1011	BTK
1.7, 1.7 Turbo	08/86-07/96	B 18 E, B 18 EP, B 18 FT	1721	19.05x124	SK-1010	BTK
1.7, 1.7 Turbo	08/86-07/96	B 18 E, B 18 FT	1721	19x125; :16530→	SK-1011	BTK
2.0	08/92-09/95	B 20 F	1998	19x127	SK-1036	BTK
1.7	04/86-07/89	B 18 E	1721	:16530→	0-N173	TB [TE]
1.7	04/86-07/89	B 18 E	1721	:16530→	0-N854	TB [DG]
1.7	04/86-07/89	B 18 E	1721	:→16529	0-N856	TB [TE]
1.7	04/86-07/89	B 18 E	1721	:→16529	0-N887	TB [DG]
1.7	08/87-07/89	B 18 F	1721	:01726→	0-N173	TB [TE]
1.7	08/87-07/89	B 18 F	1721	:01726→	0-N854	TB [DG]
1.7	08/87-07/89	B 18 F	1721	:→01725	0-N856	TB [TE]
1.7	08/87-07/89	B 18 F	1721	:→01725	0-N887	TB [DG]
1.7	08/89-07/96	B 18 EP	1721		0-N173	TB [TE]
1.7	08/89-07/96	B 18 EP	1721		0-N854	TB [DG]
1.7 Turbo	08/87-07/96	B 18 FT	1721	:01456→	0-N173	TB [TE]
1.7 Turbo	08/87-07/96	B 18 FT	1721	:01456→	0-N854	TB [DG]
1.7 Turbo	08/87-07/96	B 18 FT	1721	:→01455	0-N856	TB [TE]



OPTIMAL®

VOLVO



CM³



Art. Nr.



480 E

1.7 Turbo	08/87-07/96	B 18 FT	1721	→01455	0-N887	TB [DG]
2.0	08/92-09/95	B 20 F	1998		0-N173	TB [TE]
2.0	08/92-09/95	B 20 F	1998		0-N854	TB [DG]

740 (744)

2.0	08/85-07/92	B 200 E, B 200 G	1986	19x123; 01/1988 →	SK-1061	BTK
2.0, 2.0 GLE, 2.0 Turbo	04/83-08/92	B 19 E, B 19 ET, B 200 ET, B 200 F, B 200 FT, B 200 K	1986	19x123	SK-1061	BTK
2.3	09/85-12/89	B 230 F	2315	19x123; 01/1988 →	SK-1061	BTK
2.3	08/87-07/92	B 230 F	2316	19x123; 01/1988 →	SK-1061	BTK
2.3, 2.3 GLE, 2.3 Turbo	08/83-08/91	B 23 A, B 230 F, B 23 E, B 230 A, B 230 E, B 230 ET, B 230 FB, B 230 FT, B 230 FT, B 230 GT, B 230 K	2316	19x123	SK-1061	BTK
2.4 Diesel, 2.4 TD	08/84-07/92	D 24, D 24 T, D 24 TIC	2383	20x75; 25.4x119	SK-1129	BTK
2.4 Diesel, 2.4 TD	08/84-07/92	D 24, D 24 T, D 24 TIC	2383	25x119	SK-1129AQ1	BTKW
2.3	09/85-12/89	B 230 F	2315		0-N860	TB [TE]
2.3	08/87-08/92	B 234 F	2316		0-N1231	TB [TE]
2.3	08/87-08/92	B 234 F	2316		0-N162	TB [TE]
2.3	08/87-08/92	B 234 F	2316	hydraulisch	0-N2315	TB [TE]
2.3	08/87-08/92	B 234 F	2316	mechanisch	0-N917	TB [TE]
2.3	08/87-08/92	B 234 F	2316	hydraulisch; Spannrollenbetätigung: hydraulisch	0-N960	TB [DG]
2.3, 2.3 Turbo	08/83-07/92	B 23 A, B 230 F, B 23 E, B 230 E, B 230 F, B 230 FB, B 230 FT, B 230 K	2316		0-N860	TB [TE]
2.4 Diesel	08/84-07/92	D 24	2383		0-N807	TB [DG]

740 Kombi (745)

2.0	08/85-07/92	B 200 E, B 200 E, B 200 G	1986	19x123; 01/1988 →	SK-1061	BTK
2.0	09/88-07/91	B 200 F, B 200 K	1986	19x123	SK-1061	BTK
2.3	08/85-07/92	B 230 E, B 230 F, B 230 K, B 234 F	2316	19x123; 01/1988 →	SK-1061	BTK
2.3	08/85-12/89	B 230 F	2315	19x123; 01/1988 →	SK-1061	BTK
2.3, 2.3 GLE, 2.3 Turbo	08/84-08/91	B 23 E, B 230 A, B 230 ET, B 230 F, B 230 FB, B 230 FT, B 230 FT, B 230 GT, B 234 F	2316	19x123	SK-1061	BTK
2.4 Diesel, 2.4 TD Interc., 2.4 Turbo-Diesel	08/85-07/92	D 24, D 24 T, D 24 TIC	2383	20x75; 25.4x119	SK-1129	BTK
2.4 Diesel, 2.4 TD Interc., 2.4 Turbo-Diesel	08/85-07/92	D 24, D 24 T, D 24 TIC	2383	25x119	SK-1129AQ1	BTKW
2.0	08/89-07/91	B 200 F	1986		0-N860	TB [TE]
2.0 16V	09/87-08/90	B 204 E	1986	Spannrollenbetätigung: hydraulisch	0-N2315	TB [TE]
2.3	08/85-12/89	B 230 F	2315		0-N860	TB [TE]
2.3	08/87-08/92	B 234 F	2316		0-N1231	TB [TE]
2.3	08/87-08/92	B 234 F	2316		0-N162	TB [TE]
2.3	08/87-08/92	B 234 F	2316	hydraulisch	0-N2315	TB [TE]
2.3	08/87-08/92	B 234 F	2316	mechanisch	0-N917	TB [TE]
2.3	08/87-08/92	B 234 F	2316	hydraulisch; Spannrollenbetätigung: hydraulisch	0-N960	TB [DG]
2.3, 2.3 Turbo	08/85-07/92	B 230 E, B 230 ET, B 230 F, B 230 FB, B 230 FT, B 230 FT, B 230 GT, B 230 K	2316		0-N860	TB [TE]
2.4 Diesel, 2.4 TD Interc., 2.4 Turbo-Diesel	08/85-07/92	D 24, D 24 T, D 24 TIC	2383		0-N807	TB [DG]

760 (704, 764)

2.3 Turbo	08/82-07/84	B 23 ET	2315	19x123	SK-1061	BTK
2.3, 2.3 Turbo	01/84-07/92	B 23 ET, B 230 ET, B 230 FT, B 230 K	2316	19x123	SK-1061	BTK
2.4 TD Interc., 2.4 Turbo Diesel	08/82-07/92	D 24 T, D 24 TIC	2383	20x75; 25.4x119	SK-1129	BTK
2.4 TD Interc., 2.4 Turbo Diesel	08/82-07/92	D 24 T, D 24 TIC	2383	25x119	SK-1129AQ1	BTKW
2.3 Turbo	08/82-07/84	B 23 ET	2315		0-N860	TB [TE]
2.3 Turbo	08/84-10/88	B 230 ET	2316		0-N860	TB [TE]
2.4 D, 2.4 TD Interc., 2.4 Turbo Diesel	01/82-07/92	D 24, D 24 T, D 24 TIC	2383		0-N807	TB [DG]

760 Kombi (704, 765)

2.3, 2.3 Turbo	08/84-08/90	B 230 ET, B 230 FT, B 230 K	2316	19x123	SK-1061	BTK
2.4 D	01/82-07/92	D 24	2383	20x75; 25.4x119; 01/1983 →	SK-1129	BTK
2.4 D	01/82-07/92	D 24	2383	25x119; 01/1983 →	SK-1129AQ1	BTKW
2.4 TD Interc.	08/87-07/92	D 24 TIC	2383	20x75; 25.4x119	SK-1129	BTK
2.4 TD Interc.	08/87-07/92	D 24 TIC	2383	25x119	SK-1129AQ1	BTKW
2.4 D, 2.4 TD Interc.	01/82-07/92	D 24, D 24 TIC	2383		0-N807	TB [DG]

780

2.4 D	04/86-07/90	D 24 TIC	2383	20x75; 25.4x119	SK-1129	BTK
2.4 D	04/86-07/90	D 24 TIC	2383	25x119	SK-1129AQ1	BTKW
2.4 D	04/86-07/90	D 24 TIC	2383		0-N807	TB [DG]



CM³



Art. Nr.



850 (LS)							
2.0	08/94-12/96	B 5202 S	1984	23x144; :131155→	SK-1270	BTK	
2.0	08/94-12/96	B 5202 S	1984	23x144; :131155→	SK-1270AQ1	BTKW	
2.0	08/94-12/96	B 5202 S	1984	21x139; →131154; mit Zubehör	SK-1573	BTK	
2.0 Turbo	09/93-10/96	B 5204 T2	1984	20x143; →131154; mit Zubehör	SK-1174	BTK	
2.0, 2.0 Turbo	06/91-12/96	B 5204 F, B 5204 FT, B 5204 T, B 5204 T2	1984	23x148; :131155→; mit Zubehör	SK-1103	BTK	
2.0, 2.0 Turbo	06/91-12/96	B 5204 F, B 5204 FT, B 5204 T2	1984	23x148; :131155→; mit Zubehör	SK-1103AQ1	BTKW	
2.0, 2.0 Turbo	06/91-12/96	B 5204 F, B 5204 FT, B 5204 T	1984	20x143; mit Zubehör	SK-1174	BTK	
2.3 T5, 2.3 T5-R	08/93-12/96	B 5234 FT, B 5234 T4	2319	20x143; mit Zubehör	SK-1174	BTK	
2.3, 2.3 T5 R	01/96-10/96	B 5234 FS, B 5234 T2	2319	20x143; →131154; mit Zubehör	SK-1174	BTK	
2.3, 2.3 T5, 2.3 T5 R, 2.3 T5-R, 2.3 Turbo R	08/93-10/97	B 5234 FS, B 5234 FT, B 5234 T2, B 5234 T4, B 5234 T5	2319	23x148; :131155→; mit Zubehör	SK-1103	BTK	
2.3, 2.3 T5, 2.3 T5 R, 2.3 T5-R, 2.3 Turbo R	08/93-10/97	B 5234 FS, B 5234 FT, B 5234 T2, B 5234 T4, B 5234 T5	2319	23x148; :131155→; mit Zubehör	SK-1103AQ1	BTKW	
2.4 GLE, 2.5	08/91-10/97	B 5254 S, B 5254 T	2435	23x148; :131155→; mit Zubehör	SK-1103	BTK	
2.4 GLE, 2.5	08/91-10/97	B 5254 S, B 5254 T	2435	23x148; :131155→; mit Zubehör	SK-1103AQ1	BTKW	
2.5	06/91-12/96	B 5252, B 5252 FS	2435	23x144; :131155→	SK-1270	BTK	
2.5	06/91-12/96	B 5252, B 5252 FS	2435	23x144; :131155→	SK-1270AQ1	BTKW	
2.5	06/91-12/96	B 5252, B 5252 FS	2435	21x139; →131154; mit Zubehör	SK-1573	BTK	
2.5	08/91-12/96	B 5254 S	2435	20x143; mit Zubehör	SK-1174	BTK	
2.5 TDI	08/95-12/96	D 5252 T	2461	25.4x120	SK-1526AQ2	BTKW	
2.5 TDI	08/95-12/96	D 5252 T	2461	26.5x122; 21x81; 12/1995 →; mit Zubehör	SK-1529	BTK	
2.5 TDI	08/95-12/96	D 5252 T	2461	26.5x122; mit Zubehör	SK-1725	BTK	
2.0	06/91-12/96	B 5202 S, B 5204 F	1984	→131034; mit Anbaumaterial	0-N919	TB [TE]	S
2.0	06/91-12/96	B 5202 S, B 5204 F	1984	→131034	0-N920	TB [DG]	
2.0	06/91-12/96	B 5202 S, B 5204 F	1984	:131035→	0-N930	TB [TE]	
2.0	06/91-12/96	B 5202 S, B 5204 F	1984	:131035→	0-N958	TB [DG]	
2.0 Turbo	08/93-12/96	B 5204 FT, B 5204 T	1984	→131154; mit Anbaumaterial	0-N919	TB [TE]	S
2.0 Turbo	08/93-12/96	B 5204 FT, B 5204 T	1984	→131154	0-N920	TB [DG]	
2.0 Turbo	08/93-12/96	B 5204 FT	1984	:131155→	0-N930	TB [TE]	
2.0 Turbo	08/93-12/96	B 5204 FT, B 5204 T, B 5204 T2	1984	:131155→	0-N958	TB [DG]	
2.0 Turbo	09/93-10/96	B 5204 T2	1984	:131155→	0-N930	TB [TE]	
2.3 T5	08/93-07/96	B 5234 FT	2319	→131034; mit Anbaumaterial	0-N919	TB [TE]	S
2.3 T5	08/93-07/96	B 5234 FT	2319	→131034	0-N920	TB [DG]	
2.3 T5	08/93-07/96	B 5234 FT	2319	:131035→	0-N930	TB [TE]	
2.3 T5	08/93-07/96	B 5234 FT	2319	:131035→	0-N958	TB [DG]	
2.3 T5-R	08/95-12/96	B 5234 T4	2319	→131154; mit Anbaumaterial	0-N919	TB [TE]	S
2.3 T5-R	08/95-12/96	B 5234 T4	2319	→131154	0-N920	TB [DG]	
2.3, 2.3 T5 R, 2.3 T5-R, 2.3 Turbo R	06/95-12/96	B 5234 FS, B 5234 T2, B 5234 T4, B 5234 T5	2319	:131155→	0-N930	TB [TE]	
2.3, 2.3 T5 R, 2.3 T5-R, 2.3 Turbo R	06/95-12/96	B 5234 FS, B 5234 T2, B 5234 T4, B 5234 T5	2319	:131155→	0-N958	TB [DG]	
2.4 GLE, 2.5	06/91-10/97	B 5252, B 5252 FS, B 5254 T	2435	:131155→	0-N930	TB [TE]	
2.4 GLE, 2.5	06/91-10/97	B 5252, B 5252 FS, B 5254 T	2435	:131155→	0-N958	TB [DG]	
2.5	06/91-12/96	B 5252, B 5252 FS	2435	→131154; mit Anbaumaterial	0-N919	TB [TE]	S
2.5	06/91-12/96	B 5252, B 5252 FS	2435	→131154	0-N920	TB [DG]	
2.5	08/91-12/96	B 5254 S	2435	→131034; mit Anbaumaterial	0-N919	TB [TE]	S
2.5	08/91-12/96	B 5254 S	2435	→131034	0-N920	TB [DG]	
2.5	08/91-12/96	B 5254 S	2435	:131035→	0-N930	TB [TE]	
2.5	08/91-12/96	B 5254 S	2435	:131035→	0-N958	TB [DG]	
2.5 TDI	08/95-12/96	D 5252 T	2461		0-N110	TB [TE]	
2.5 TDI	08/95-12/96	D 5252 T	2461		0-N116	TB [TE]	
2.5 TDI	08/95-12/96	D 5252 T	2461		0-N117	TB [TE]	
2.0, 2.0 Turbo	06/91-12/96	B 5202 S, B 5204 F, B 5204 FT, B 5204 T	1984		0-N1448	VB [DG]	
2.0, 2.0 Turbo	06/91-12/96	B 5202 S, B 5204 F, B 5204 FT, B 5204 T	1984		0-N1518	VB [BT]	S
2.0, 2.0 Turbo	06/91-12/96	B 5202 S, B 5204 F, B 5204 FT, B 5204 T, B 5204 T2	1984	:148582→	0-N2223	VB [VD]	
2.3 T5, 2.3 T5-R	08/93-12/96	B 5234 FT, B 5234 T4	2319		0-N1448	VB [DG]	
2.3 T5, 2.3 T5-R	08/93-12/96	B 5234 FT, B 5234 T4	2319		0-N1518	VB [BT]	S
2.3, 2.3 T5, 2.3 T5 R, 2.3 T5-R, 2.3 Turbo R	08/93-12/96	B 5234 FS, B 5234 FT, B 5234 T2, B 5234 T4, B 5234 T5	2319	:148582→	0-N2223	VB [VD]	
2.4 GLE, 2.5	08/91-10/97	B 5254 S, B 5254 T	2435	:148582→	0-N2223	VB [VD]	
2.5	06/91-12/96	B 5252, B 5252 FS, B 5254 S	2435		0-N1448	VB [DG]	
2.5	06/91-12/96	B 5252, B 5252 FS, B 5254 S	2435		0-N1518	VB [BT]	S
2.5	06/91-12/96	B 5252, B 5252 FS	2435	:131155→	0-N2223	VB [VD]	
2.5 TDI	08/95-12/96	D 5252 T	2461		0-N1424	VB [DG]	
2.5 TDI	08/95-12/96	D 5252 T	2461		0-N1953	VB [BT]	S



CM³



Art. Nr.



850 Kombi (LW)

2.0	08/94-12/96	B 5202 S	1984	23x144; :131155→	SK-1270	BTK	
2.0	08/94-12/96	B 5202 S	1984	23x144; :131155→	SK-1270AQ1	BTkW	
2.0	08/94-12/96	B 5202 S	1984	21x139; 12/1994 →; →131154; mit Zubehör	SK-1573	BTK	
2.0 Turbo	09/93-10/97	B 5204 T2	1984	23x148; :131155→; mit Zubehör	SK-1103	BTK	
2.0 Turbo	09/93-10/97	B 5204 T2	1984	20x143; →131154; mit Zubehör	SK-1174	BTK	
2.0, 2.0 Turbo	02/93-12/96	B 5204 F, B 5204 FT, B 5204 T	1984	23x148; 09/1993 →; :131155→; mit Zubehör	SK-1103	BTK	
2.0, 2.0 Turbo	02/93-10/97	B 5204 F, B 5204 FT, B 5204 T, B 5204 T2	1984	23x148; :131155→; mit Zubehör	SK-1103AQ1	BTkW	
2.0, 2.0 Turbo	02/93-12/96	B 5204 F, B 5204 FT, B 5204 T	1984	20x143; mit Zubehör	SK-1174	BTK	
2.3 T5	02/93-12/96	B 5234 FT	2319	23x148; 09/1993 →; :131155→; mit Zubehör	SK-1103	BTK	
2.3 T5, 2.3 T5-R	02/93-12/96	B 5234 FT, B 5234 T4	2319	20x143; mit Zubehör	SK-1174	BTK	
2.3 T5, 2.3 T5-R, 2.3 Turbo R	02/93-10/97	B 5234 FT, B 5234 T4, B 5234 T5	2319	23x148; :131155→; mit Zubehör	SK-1103AQ1	BTkW	
2.3, 2.3 T5-R, 2.3 Turbo R	06/95-10/97	B 5234 FS, B 5234 T4, B 5234 T5	2319	23x148; :131155→; mit Zubehör	SK-1103	BTK	
2.4 GLE, 2.5 AWD	09/93-10/97	B 5254 T	2435	23x148; :131155→; mit Zubehör	SK-1103	BTK	
2.4 GLE, 2.5, 2.5 AWD	09/92-10/97	B 5254 S, B 5254 T	2435	23x148; :131155→; mit Zubehör	SK-1103AQ1	BTkW	
2.5	08/92-12/96	B 5252, B 5252 FS	2435	23x144; :131155→	SK-1270	BTK	
2.5	08/92-12/96	B 5252, B 5252 FS	2435	23x144; :131155→	SK-1270AQ1	BTkW	
2.5	08/92-12/96	B 5252, B 5252 FS	2435	21x139; →131154; mit Zubehör	SK-1573	BTK	
2.5	09/92-12/96	B 5254 S	2435	23x148; 09/1993 →; :131155→; mit Zubehör	SK-1103	BTK	
2.5 TDI	08/95-12/96	D 5252 T	2461	25.4x120	SK-1526AQ2	BTkW	
2.5 TDI	08/95-12/96	D 5252 T	2461	26.5x122; 21x81; 12/1995 →; mit Zubehör	SK-1529	BTK	
2.5 TDI	08/95-12/96	D 5252 T	2461	26.5x122; mit Zubehör	SK-1725	BTK	
2.5, 2.5 AWD	09/92-12/96	B 5254 S, B 5254 T	2435	20x143; mit Zubehör	SK-1174	BTK	
2.0	02/93-12/96	B 5202 S, B 5204 F	1984	:131035→	0-N930	TB [TE]	
2.0 Turbo	02/93-12/96	B 5204 FT	1984	:131035→	0-N930	TB [TE]	
2.0 Turbo	09/93-10/97	B 5204 T2	1984	:131155→	0-N930	TB [TE]	
2.0 Turbo	09/93-10/97	B 5204 T2	1984	:131155→	0-N958	TB [DG]	
2.0, 2.0 Turbo	02/93-12/96	B 5202 S, B 5204 F, B 5204 FT, B 5204 T	1984	→131034; mit Anbaumaterial	0-N919	TB [TE]	S
2.0, 2.0 Turbo	02/93-12/96	B 5202 S, B 5204 F, B 5204 FT, B 5204 T	1984	→131034	0-N920	TB [DG]	
2.0, 2.0 Turbo	02/93-12/96	B 5202 S, B 5204 F, B 5204 FT, B 5204 T	1984	:131035→	0-N958	TB [DG]	
2.3 T5, 2.3 T5-R	02/93-12/96	B 5234 FT, B 5234 T4	2319	→131034; mit Anbaumaterial	0-N919	TB [TE]	S
2.3 T5, 2.3 T5-R	02/93-12/96	B 5234 FT, B 5234 T4	2319	→131034	0-N920	TB [DG]	
2.3 T5, 2.3 T5-R	02/93-12/96	B 5234 FT, B 5234 T4	2319	:131035→	0-N930	TB [TE]	
2.3 T5, 2.3 T5-R	02/93-12/96	B 5234 FT, B 5234 T4	2319	:131035→	0-N958	TB [DG]	
2.3, 2.3 T5 R, 2.3 Turbo R	06/95-10/97	B 5234 FS, B 5234 T2, B 5234 T5	2319	:131155→	0-N930	TB [TE]	
2.3, 2.3 T5 R, 2.3 Turbo R	06/95-10/97	B 5234 FS, B 5234 T2, B 5234 T5	2319	:131155→	0-N958	TB [DG]	
2.4 GLE, 2.5	08/92-10/97	B 5252, B 5252 FS, B 5254 T	2435	:131155→	0-N958	TB [DG]	
2.4 GLE, 2.5, 2.5 AWD	08/92-10/97	B 5252, B 5252 FS, B 5254 T	2435	:131155→	0-N930	TB [TE]	
2.5	08/92-12/96	B 5252, B 5252 FS	2435	→131154; mit Anbaumaterial	0-N919	TB [TE]	S
2.5	08/92-12/96	B 5252, B 5252 FS	2435	→131154	0-N920	TB [DG]	
2.5	09/92-12/96	B 5254 S	2435	:131035→	0-N930	TB [TE]	
2.5 TDI	08/95-12/96	D 5252 T	2461		0-N110	TB [TE]	
2.5 TDI	08/95-12/96	D 5252 T	2461		0-N116	TB [TE]	
2.5 TDI	08/95-12/96	D 5252 T	2461		0-N117	TB [TE]	
2.5, 2.5 AWD	09/92-12/96	B 5254 S, B 5254 T	2435	→131034; mit Anbaumaterial	0-N919	TB [TE]	S
2.5, 2.5 AWD	09/92-12/96	B 5254 S, B 5254 T	2435	→131034	0-N920	TB [DG]	
2.5, 2.5 AWD	09/92-12/96	B 5254 S, B 5254 T	2435	:131035→	0-N958	TB [DG]	
2.0, 2.0 Turbo	02/93-12/96	B 5202 S, B 5204 F, B 5204 FT, B 5204 T	1984		0-N143	VB [DG]	
2.0, 2.0 Turbo	02/93-12/96	B 5202 S, B 5204 F, B 5204 FT, B 5204 T	1984		0-N1518	VB [BT]	S
2.0, 2.0 Turbo	02/93-10/97	B 5202 S, B 5204 F, B 5204 FT, B 5204 T, B 5204 T2	1984	:148582→	0-N2223	VB [VD]	
2.3 T5, 2.3 T5-R	02/93-12/96	B 5234 FT, B 5234 T4	2319		0-N143	VB [DG]	
2.3 T5, 2.3 T5-R	02/93-12/96	B 5234 FT, B 5234 T4	2319		0-N1518	VB [BT]	S
2.3, 2.3 T5, 2.3 T5 R, 2.3 T5-R, 2.3 Turbo R	02/93-10/97	B 5234 FS, B 5234 FT, B 5234 T2, B 5234 T4, B 5234 T5	2319	:148582→	0-N2223	VB [VD]	
2.4 GLE, 2.5, 2.5 AWD	09/92-10/97	B 5254 S, B 5254 T	2435	:148582→	0-N2223	VB [VD]	
2.5	08/92-12/96	B 5252, B 5252 FS	2435	:131155→	0-N2223	VB [VD]	
2.5 TDI	08/95-12/96	D 5252 T	2461		0-N1424	VB [DG]	
2.5 TDI	08/95-12/96	D 5252 T	2461		0-N1953	VB [BT]	S
2.5, 2.5 AWD	08/92-12/96	B 5252, B 5252 FS, B 5254 S, B 5254 T	2435		0-N143	VB [DG]	
2.5, 2.5 AWD	08/92-12/96	B 5252, B 5252 FS, B 5254 S, B 5254 T	2435		0-N1518	VB [BT]	S

940 (944)

2.0	01/92-07/94	B 200 F	1986	19.05x123	SK-1172	BTK	
-----	-------------	---------	------	-----------	---------	-----	--

CM³

Art. Nr.



ohne Halter

940 (944)							
2.0 Turbo	08/90-12/94	B 200 FT	1986	19.05x123; 01/1993 →	SK-1172	BTK	
2.0, 2.0 Turbo	08/90-12/94	B 200 F, B 200 FT	1986	19x123; → 12/1992	SK-1061	BTK	
2.3	09/90-09/93	B 230 FT	2316	19.05x123; 01/1993 →	SK-1172	BTK	
2.3, 2.3 Turbo	08/90-12/94	B 230 FB, B 230 G, B 230 FD, B 230 FT, B 230 FT+	2316	19x123; → 12/1992	SK-1061	BTK	
2.3, 2.3 Turbo	08/90-12/94	B 230 FB, B 230 G, B 230 FD, B 230 FT, B 230 FT+	2316	19.05x123	SK-1172	BTK	
2.4 D, 2.4 TD Intercooler	08/90-12/94	D 24, D 24 TIC	2383	20x75; 25.4x119; → 12/1992	SK-1129	BTK	
2.4 D, 2.4 TD Intercooler	08/90-12/94	D 24, D 24 TIC	2383	25x119; → 12/1992	SK-1129AQ1	BTKW	
2.4 TD Intercooler	08/90-12/94	D 24 TIC	2383	25.4x120; 20x75; 01/1993 →	SK-1527	BTK	
2.4 Turbo Diesel	08/90-12/94	D 24 T	2383	20x75; 25.4x119	SK-1129	BTK	
2.4 Turbo Diesel	08/90-12/94	D 24 T	2383	25x119	SK-1129AQ1	BTKW	
2.0, 2.0 Turbo	08/90-12/94	B 200 F, B 200 FT	1986		0-N860	TB [TE]	
2.3	08/90-07/91	B 234 F, B 234 G	2316		0-N1231	TB [TE]	
2.3	08/90-07/91	B 234 F, B 234 G	2316		0-N162	TB [TE]	
2.3	08/90-07/91	B 234 F, B 234 G	2316		0-N2315	TB [TE]	
2.3	08/90-07/91	B 234 F, B 234 G	2316	Spannrollenbetätigung: hydraulisch	0-N960	TB [DG]	
2.3, 2.3 Turbo	08/90-12/94	B 230 FB, B 230 G, B 230 FD, B 230 FT, B 230 FT+	2316		0-N860	TB [TE]	
2.4 D	08/90-12/94	D 24	2383		0-N807	TB [DG]	
2.4 TD Intercooler	08/90-12/94	D 24 TIC	2383	ch.30004→	0-N1232	TB [TE]	
2.4 TD Intercooler	08/90-12/94	D 24 TIC	2383	ch.30004→	0-N163	TB [DG]	
2.4 TD Intercooler	08/90-12/94	D 24 TIC	2383	ch.→30003	0-N807	TB [DG]	
2.4 Turbo Diesel	08/90-12/94	D 24 T	2383	ch.11623→	0-N1232	TB [TE]	
2.4 Turbo Diesel	08/90-12/94	D 24 T	2383	ch.11623→	0-N163	TB [DG]	
2.4 Turbo Diesel	08/90-12/94	D 24 T	2383	11622	0-N807	TB [DG]	
940 [USA] Stufenheck							
2.0 CVVT Flex	01/91-12/95		2316		0-N2021	VB [DG]	
940 Kombi (945)							
2.0	01/92-07/94	B 200 F	1986	19.05x123	SK-1172	BTK	
2.0 Turbo	01/91-07/95	B 200 FT	1986	19.05x123; 01/1993 →	SK-1172	BTK	
2.0, 2.0 Turbo	01/91-07/95	B 200 F, B 200 FT	1986	19x123; → 12/1992	SK-1061	BTK	
2.3, 2.3 Turbo	08/90-12/94	B 230 FB, B 230 FD, B 230 FT, B 230 FT+	2316	19x123; → 12/1992	SK-1061	BTK	
2.3, 2.3 Turbo	08/90-12/94	B 230 FB, B 230 FD, B 230 FT, B 230 FT+	2316	19.05x123	SK-1172	BTK	
2.4 D, 2.4 Turbo Diesel	08/90-07/95	D 24, D 24 T	2383	20x75; 25.4x119	SK-1129	BTK	
2.4 D, 2.4 Turbo Diesel	08/90-07/95	D 24, D 24 T	2383	25x119	SK-1129AQ1	BTKW	
2.4 TD Intercooler	08/90-08/94	D 24 TIC	2383	20x75; 25.4x119; → 12/1992	SK-1129	BTK	
2.4 TD Intercooler	08/90-08/94	D 24 TIC	2383	25x119; → 12/1992	SK-1129AQ1	BTKW	
2.4 TD Intercooler	08/90-08/94	D 24 TIC	2383	25.4x120; 20x75; 01/1993 →	SK-1527	BTK	
2.0	01/92-07/94	B 200 F	1986		0-N860	TB [TE]	
2.3	08/90-07/91	B 234 F	2316		0-N1231	TB [TE]	
2.3	08/90-07/91	B 234 F	2316		0-N162	TB [TE]	
2.3	08/90-07/91	B 234 F	2316		0-N2315	TB [TE]	
2.3	08/90-07/91	B 234 F	2316	Spannrollenbetätigung: hydraulisch	0-N960	TB [DG]	
2.3, 2.3 Turbo	08/90-12/94	B 230 FB, B 230 FD, B 230 FT, B 230 FT+	2316		0-N860	TB [TE]	
2.4 D	08/90-07/95	D 24	2383		0-N807	TB [DG]	
2.4 TD Intercooler	08/90-08/94	D 24 TIC	2383	ch.30004→	0-N1232	TB [TE]	
2.4 TD Intercooler	08/90-08/94	D 24 TIC	2383	ch.30004→	0-N163	TB [DG]	
2.4 TD Intercooler	08/90-08/94	D 24 TIC	2383	ch.→30003	0-N807	TB [DG]	
2.4 Turbo Diesel	08/90-07/94	D 24 T	2383	ch.11623→	0-N1232	TB [TE]	
2.4 Turbo Diesel	08/90-07/94	D 24 T	2383	ch.11623→	0-N163	TB [DG]	
2.4 Turbo Diesel	08/90-07/94	D 24 T	2383	11622	0-N807	TB [DG]	
940 II (944)							
2.0, 2.0 Turbo	11/94-10/98	B 200 FT, B 200 G	1986	19.05x123	SK-1172	BTK	
2.3, 2.3 ti, 2.3 Turbo	08/94-12/98	B 230 FB, B 230 FD, B 230 FK, B 230 FT	2316	19.05x123	SK-1172	BTK	
2.4 TD Interc.	08/94-10/98	D 24 TIC	2383	25.4x120; 20x75	SK-1527	BTK	
2.0 Turbo	04/96-10/98	B 200 FT	1986		0-N860	TB [TE]	
2.3, 2.3 ti, 2.3 Turbo	08/94-10/98	B 230 FB, B 230 FD, B 230 FK, B 230 FT	2316		0-N860	TB [TE]	
2.4 TD Interc.	08/94-10/98	D 24 TIC	2383		0-N1232	TB [TE]	
2.4 TD Interc.	08/94-10/98	D 24 TIC	2383		0-N163	TB [DG]	
940 II Kombi (945)							
2.0 Turbo	04/96-10/98	B 200 FT	1986	19.05x123	SK-1172	BTK	
2.3, 2.3 ti, 2.3 Turbo	08/94-10/98	B 230 FB, B 230 FD, B 230 FK, B 230 FT	2316	19.05x123	SK-1172	BTK	
2.4 TD Interc.	08/94-10/98	D 24 TIC	2383	25.4x120; 20x75	SK-1527	BTK	



CM³



Art. Nr.



940 II Kombi (945)

2.0 Turbo	04/96-10/98	B 200 FT	1986		0-N860	TB [TE]	
2.3, 2.3 ti, 2.3 Turbo	08/94-10/98	B 230 FB, B 230 FD, B 230 FK, B 230 FT	2316		0-N860	TB [TE]	
2.4 TD Interc.	08/94-10/98	D 24 TIC	2383		0-N1232	TB [TE]	
2.4 TD Interc.	08/94-10/98	D 24 TIC	2383		0-N163	TB [DG]	

960 (964)

2.3 Turbo	09/90-08/93	B 230 FT	2316	19x123; → 12/1992	SK-1061	BTK	
2.3 Turbo	09/90-08/93	B 230 FT	2316	19.05x123; 01/1993 →	SK-1172	BTK	
2.4 TD Interc.	09/91-07/94	D 24 TIC	2383	20x75; 25.4x119; → 12/1992	SK-1129	BTK	
2.4 TD Interc.	09/91-07/94	D 24 TIC	2383	25x119; → 12/1992	SK-1129AQ1	BTKW	
2.4 TD Interc.	09/91-07/94	D 24 TIC	2383	25.4x120; 20x75; 01/1993 →	SK-1527	BTK	
2.9	08/90-07/94	B 6304 F, B 6304 FS, B 6304 G	2922	23x148; :131035→; mit Zubehör	SK-1103	BTK	
2.9	08/90-07/94	B 6304 F, B 6304 FS, B 6304 G	2922	23x148; :131035→; mit Zubehör	SK-1103AQ1	BTKW	
2.9	08/90-07/94	B 6304 F, B 6304 FS, B 6304 G	2922	20x143; mit Zubehör	SK-1174	BTK	
2.9	08/90-07/94	B 6304 F, B 6304 FS, B 6304 G	2922	28x152; 09/1993 →; mit Zubehör; Baumuster: 1995, 1996	SK-1265	BTK	
2.4 TD Interc.	09/91-07/94	D 24 TIC	2383	ch.30004→	0-N1232	TB [TE]	
2.4 TD Interc.	09/91-07/94	D 24 TIC	2383	ch.30004→	0-N163	TB [DG]	
2.4 TD Interc.	09/91-07/94	D 24 TIC	2383	ch.→30003	0-N807	TB [DG]	
2.9	08/90-07/94	B 6304 F, B 6304 FS, B 6304 G	2922	mit Anbaumaterial	0-N919	TB [TE]	S
2.9	08/90-07/94	B 6304 F, B 6304 FS, B 6304 G	2922		0-N920	TB [DG]	
2.9	08/90-07/94	B 6304 F, B 6304 FS, B 6304 G	2922	:131035→	0-N930	TB [TE]	
2.9	08/90-07/94	B 6304 F, B 6304 FS, B 6304 G	2922		0-N143	VB [DG]	

960 Kombi (965)

2.3 Turbo	09/90-08/93	B 230 FT	2316	19x123; → 12/1992	SK-1061	BTK	
2.3 Turbo	09/90-08/93	B 230 FT	2316	19.05x123; 01/1993 →	SK-1172	BTK	
2.4 TD Interc.	09/91-07/94	D 24 TIC	2383	20x75; 25.4x119	SK-1129	BTK	
2.4 TD Interc.	09/91-07/94	D 24 TIC	2383	25x119	SK-1129AQ1	BTKW	
2.4 TD Interc., 2.4 Tdi	09/90-07/94	D 24 TIC	2383	25.4x120; 20x75; 01/1993 →	SK-1527	BTK	
2.4 Tdi	09/90-08/93	D 24 TIC	2383	20x75; 25.4x119; → 12/1992	SK-1129	BTK	
2.4 Tdi	09/90-08/93	D 24 TIC	2383	25x119; → 12/1992	SK-1129AQ1	BTKW	
2.9	08/90-07/94	B 6304 F, B 6304 S	2922	23x148; :131035→; mit Zubehör	SK-1103	BTK	
2.9	08/90-07/94	B 6304 F, B 6304 S	2922	23x148; :131035→; mit Zubehör	SK-1103AQ1	BTKW	
2.9	08/90-07/94	B 6304 F, B 6304 S	2922	20x143; mit Zubehör	SK-1174	BTK	
2.9	08/90-07/94	B 6304 F, B 6304 S	2922	28x152; 09/1993 →; mit Zubehör; Baumuster: 1995, 1996	SK-1265	BTK	
2.4 TD Interc.	09/91-07/94	D 24 TIC	2383	ch.30004→	0-N1232	TB [TE]	
2.4 TD Interc.	09/91-07/94	D 24 TIC	2383	ch.30004→	0-N163	TB [DG]	
2.4 TD Interc.	09/91-07/94	D 24 TIC	2383	ch.→30003	0-N807	TB [DG]	
2.9	08/90-07/94	B 6304 F, B 6304 S	2922	mit Anbaumaterial	0-N919	TB [TE]	S
2.9	08/90-07/94	B 6304 F, B 6304 S	2922		0-N920	TB [DG]	
2.9	08/90-07/94	B 6304 F, B 6304 S	2922	:131035→	0-N930	TB [TE]	
2.9	08/90-07/94	B 6304 F, B 6304 S	2922		0-N143	VB [DG]	

960 II (964)

2.5	07/94-12/96	B 6254 S	2473	28x152; mit Zubehör; Baumuster: 1995, 1996	SK-1265	BTK	
2.9	07/94-12/96	B 6304 S	2922	23x148; mit Zubehör	SK-1103	BTK	
2.9	07/94-12/96	B 6304 S	2922	23x148; →1994; mit Zubehör	SK-1103AQ1	BTKW	
2.9	07/94-12/96	B 6304 S	2922	28x152; mit Zubehör; Baumuster: 1995, 1996	SK-1265	BTK	
2.5	07/94-12/96	B 6254 S	2473		0-N172	TB [DG]	
2.5	07/94-12/96	B 6254 S	2473	01/1995 →	0-N959	TB [TE]	
2.9	07/94-12/96	B 6304 S	2922		0-N172	TB [DG]	
2.9	07/94-12/96	B 6304 S	2922	01/1996 →	0-N959	TB [TE]	
2.5	07/94-12/96	B 6254 S	2473		0-N1308	VB [TE]	
2.5	07/94-12/96	B 6254 S	2473		0-N1406	VB [DG]	
2.9	07/94-12/96	B 6304 S	2922		0-N1308	VB [TE]	
2.9	07/94-12/96	B 6304 S	2922		0-N1406	VB [DG]	

960 II Kombi (965)

2.5	08/94-12/96	B 6254 S	2473	28x152; mit Zubehör; Baumuster: 1995, 1996	SK-1265	BTK	
2.9	09/94-12/96	B 6304 S	2922	23x148; mit Zubehör	SK-1103	BTK	
2.9	09/94-12/96	B 6304 S	2922	23x148; →1994; mit Zubehör	SK-1103AQ1	BTKW	
2.9	09/94-12/96	B 6304 S	2922	28x152; mit Zubehör; Baumuster: 1995, 1996	SK-1265	BTK	
2.5	08/94-12/96	B 6254 S	2473		0-N172	TB [DG]	



CM³



Art. Nr.



960 II Kombi (965)

2.5	08/94-12/96	B 6254 S	2473	01/1995 →	0-N959	TB [TE]	
2.9	09/94-12/96	B 6304 S	2922		0-N172	TB [DG]	
2.9	09/94-12/96	B 6304 S	2922	01/1996 →	0-N959	TB [TE]	
2.5	08/94-12/96	B 6254 S	2473		0-N1308	VB [TE]	
2.5	08/94-12/96	B 6254 S	2473		0-N1406	VB [DG]	
2.9	09/94-12/96	B 6304 S	2922		0-N1308	VB [TE]	
2.9	09/94-12/96	B 6304 S	2922		0-N1406	VB [DG]	

C30

1.6	10/06-12/12	B 4164 S3	1596	22x117; mit Zubehör	SK-1659	BTK	
1.6	10/06-12/12	B 4164 S3	1596	22x117; mit Zubehör	SK-1659AQ1	BTKW	
1.6 D	10/06-12/12	D 4164 T	1560	25x137	SK-1424	BTK	
1.6 D	10/06-12/12	D 4164 T	1560	25x137	SK-1424AQ1	BTKW	
1.6 D2	10/10-12/12	D 4162 T	1560	25x141	SK-1728	BTK	
1.6 D2	10/10-12/12	D 4162 T	1560	25x141	SK-1728AQ1	BTKW	
2.0 D	10/06-12/12	D 4204 T	1998	25.4x116	SK-1594	BTK	
2.0 D	10/06-12/12	D 4204 T	1998	25.4x116	SK-1594AQ1	BTKW	
2.4 i	10/06-12/12	B 5244 S4	2435	23x142; :→3887615	SK-1492	BTK	
2.4 i	10/06-12/12	B 5244 S4	2435	23x142; :→3887615	SK-1492AQ1	BTKW	
2.4 i	10/06-12/12	B 5244 S4	2435	23x142	SK-1666	BTK	
2.4 i	10/06-12/12	B 5244 S4	2435	23x142; :3887616→	SK-1666AQ1	BTKW	
D3, D4	10/10-12/12	D 5204 T, D 5204 T5	1984	28x132; :1046802→	SK-1608	BTK	
D5	10/06-12/12	D 5244 T13, D 5244 T8, D 5244 T9	2400	28x132	SK-1608	BTK	
D5	10/06-12/12	D 5244 T13, D 5244 T8, D 5244 T9	2400	28x132	SK-1608AQ1	BTKW	
T5	10/06-12/12	B 5254 T3, B 5254 T7	2521	23x142; :→3887615	SK-1492	BTK	
T5	10/06-12/12	B 5254 T3, B 5254 T7	2521	23x142; :→3887615	SK-1492AQ1	BTKW	
T5	10/06-12/12	B 5254 T3	2521	23x142; → 05/2007	SK-1666	BTK	
T5	10/06-12/12	B 5254 T3, B 5254 T7	2521	23x142; :3887616→	SK-1666AQ1	BTKW	
T5	03/07-12/12	B 5254 T7	2521	23x142; 06/2007 →	SK-1666	BTK	
1.6	10/06-12/12	B 4164 S3	1596		0-N1564	TB [TE]	
1.6 D	10/06-12/12	D 4164 T	1560		0-N1062	TB [TE]	
1.6 D	10/06-12/12	D 4164 T	1560		0-N1066	TB [DG]	
1.6 D2	10/10-12/12	D 4162 T	1560		0-N2224	TB [TE]	
1.6 D2	10/10-12/12	D 4162 T	1560		0-N2382	TB [DG]	
2.0 D	10/06-12/12	D 4204 T	1998		0-N1334	TB [DG]	
2.4 i	10/06-12/12	B 5244 S4	2435		0-N958	TB [DG]	
D3, D4	10/10-12/12	D 5204 T, D 5204 T5	1984		0-N1349	TB [TE]	
D3, D4	10/10-12/12	D 5204 T, D 5204 T5	1984		0-N1350	TB [DG]	
D5	10/06-12/12	D 5244 T13, D 5244 T8, D 5244 T9	2400		0-N1349	TB [TE]	
D5	10/06-12/12	D 5244 T13, D 5244 T8, D 5244 T9	2400		0-N1350	TB [DG]	
T5	10/06-12/12	B 5254 T3, B 5254 T7	2521	:→3887615	0-N1324	TB [TE]	
T5	10/06-12/12	B 5254 T3, B 5254 T7	2521	:3887616→	0-N1573	TB [TE]	
T5	10/06-12/12	B 5254 T3, B 5254 T7	2521		0-N958	TB [DG]	
1.6 D	10/06-12/12	D 4164 T	1560	ch.→196529	0-N1339	VB [BT]	S
1.8, 1.8 FlexFuel	10/06-12/12	B 4184 S11, B 4184 S8	1798	ch.→73764	0-N1639	VB [BT]	S
1.8, 1.8 FlexFuel	10/06-12/12	B 4184 S11, B 4184 S8	1798		0-N2353	VB [DG]	
2.0	10/06-12/12	B 4204 S3	1999	ch.→73764	0-N1639	VB [BT]	S
2.0 D	10/06-12/12	D 4204 T	1998		0-N1327	VB [BT]	
2.0 D	10/06-12/12	D 4204 T	1998		0-N2037	VB [BT]	S
2.0, 2.0 FlexFuel	10/06-12/12	B 4204 S3, B 4204 S4	1999		0-N2353	VB [DG]	
2.4 i	10/06-12/12	B 5244 S4	2435	:→4293284	0-N1554	VB [BT]	S
2.4 i	10/06-12/12	B 5244 S4	2435	:→4293284	0-N2096	VB [BT]	S
2.4 i	10/06-12/12	B 5244 S4	2435	:4293285→	0-N2109	VB [BT]	S
2.4 i	10/06-12/12	B 5244 S4	2435	:4293285→	0-N2190	VB [BT]	S
D3, D4	10/10-12/12	D 5204 T, D 5204 T5	1984	:→619467;	0-N2096	VB [BT]	S
D3, D4	10/10-12/12	D 5204 T, D 5204 T5	1984	:619468→;	0-N2109	VB [BT]	S
D3, D4	10/10-12/12	D 5204 T, D 5204 T5	1984	:619468→;	0-N2190	VB [BT]	S
D5	10/06-12/12	D 5244 T13, D 5244 T8, D 5244 T9	2400	:→619467	0-N1554	VB [BT]	S
D5	10/06-12/12	D 5244 T13, D 5244 T8, D 5244 T9	2400	:→619467	0-N2096	VB [BT]	S
D5	10/06-12/12	D 5244 T13, D 5244 T8, D 5244 T9	2400	:619468→	0-N2109	VB [BT]	S
D5	10/06-12/12	D 5244 T13, D 5244 T8, D 5244 T9	2400	:619468→	0-N2190	VB [BT]	S
T5	10/06-12/12	B 5254 T3, B 5254 T7	2521	:→4293284	0-N1554	VB [BT]	S
T5	10/06-12/12	B 5254 T3, B 5254 T7	2521	:→4293284	0-N2096	VB [BT]	S
T5	10/06-12/12	B 5254 T3, B 5254 T7	2521	:4293285→	0-N2109	VB [BT]	S
T5	10/06-12/12	B 5254 T3, B 5254 T7	2521	:4293285→;	0-N2190	VB [BT]	S



OPTIMAL®

VOLVO



CM³



Art. Nr.



C70 I Cabriolet

2.0 T	03/00-10/05	B 5204 T4	1984	23x142	SK-1491	BTK
2.0 T	03/00-10/05	B 5204 T4	1984	23x142; :→3192745	SK-1491AQ1	BTKW
2.0, 2.0 T	03/98-10/05	B 5204 T2, B 5204 T3	1984	23x148; :→1266127; mit Zubehör; Spannrollenbetätigung: hydraulisch	SK-1103	BTK
2.0, 2.0 T	03/98-10/05	B 5204 T2, B 5204 T3	1984	23x148; :→1266127; mit Zubehör; Spannrollenbetätigung: hydraulisch	SK-1103AQ1	BTKW
2.0, 2.0 T	03/98-10/05	B 5204 T2, B 5204 T3	1984	23x142; :1266128→	SK-1491	BTK
2.0, 2.0 T	03/98-10/05	B 5204 T2, B 5204 T3	1984	23x142; :1266128→; :→3192745; Spannrollenbetätigung: mechanisch	SK-1491AQ1	BTKW
2.0, 2.0 T	03/98-10/05	B 5204 T2, B 5204 T3, B 5204 T4	1984	23x142; :3192746→	SK-1492	BTK
2.0, 2.0 T	03/98-10/05	B 5204 T2, B 5204 T3, B 5204 T4	1984	23x142; :3192746→	SK-1492AQ1	BTKW
2.3 T5	07/02-10/05	B 5234 T9	2319	23x142	SK-1491	BTK
2.3 T5	07/02-10/05	B 5234 T9	2319	23x142; :→3192745	SK-1491AQ1	BTKW
2.3 T-5	03/98-10/05	B 5234 T3	2319	23x148; :→1266127; mit Zubehör; Spannrollenbetätigung: hydraulisch	SK-1103	BTK
2.3 T-5	03/98-10/05	B 5234 T3	2319	23x148; :→1266127; mit Zubehör; Spannrollenbetätigung: hydraulisch	SK-1103AQ1	BTKW
2.3 T-5	03/98-10/05	B 5234 T3	2319	23x142; :1266128→	SK-1491	BTK
2.3 T-5	03/98-10/05	B 5234 T3	2319	23x142; :1266128→; :→3192745; Spannrollenbetätigung: mechanisch	SK-1491AQ1	BTKW
2.3 T5, 2.3 T-5	03/98-10/05	B 5234 T3, B 5234 T9	2319	23x142; :3192746→	SK-1492	BTK
2.3 T5, 2.3 T-5	03/98-10/05	B 5234 T3, B 5234 T9	2319	23x142; :3192746→	SK-1492AQ1	BTKW
2.4 T	07/02-10/05	B 5244 T7	2435	23x142	SK-1491	BTK
2.4 T, 2.5, 2.5 T	03/98-10/05	B 5244 T, B 5254 T, B 5244 T7, B 5254 S	2435	23x142; :→3192745	SK-1491AQ1	BTKW
2.4 T, 2.5, 2.5 T	03/98-10/05	B 5244 T, B 5254 T, B 5244 T7, B 5254 S	2435	23x142; :3192746→	SK-1492	BTK
2.4 T, 2.5, 2.5 T	03/98-10/05	B 5244 T, B 5254 T, B 5244 T7, B 5254 S	2435	23x142; :3192746→	SK-1492AQ1	BTKW
2.5	06/98-10/05	B 5254 S	2435	23x148; :→1266127; mit Zubehör; Spannrollenbetätigung: hydraulisch	SK-1103	BTK
2.5	06/98-10/05	B 5254 S	2435	23x142; :1266128→	SK-1491	BTK
2.5 T	03/98-10/05	B 5244 T, B 5254 T	2435	23x148; :→1266127; mit Zubehör	SK-1103	BTK
2.5 T	03/98-10/05	B 5244 T	2435	23x142; 01/2000 →	SK-1491	BTK
2.0 T	03/00-10/05	B 5204 T4	1984		0-N137	TB [TE]
2.0, 2.0 T	03/98-10/05	B 5204 T2, B 5204 T3	1984	:1266128→	0-N137	TB [TE]
2.0, 2.0 T	03/98-10/05	B 5204 T2, B 5204 T3	1984	:→1266127	0-N930	TB [TE]
2.0, 2.0 T	03/98-10/05	B 5204 T2, B 5204 T3, B 5204 T4	1984		0-N958	TB [DG]
2.3 T5	07/02-10/05	B 5234 T9	2319		0-N137	TB [TE]
2.3 T-5	03/98-10/05	B 5234 T3	2319	:1266128→	0-N137	TB [TE]
2.3 T-5	03/98-10/05	B 5234 T3	2319	:→1266127	0-N930	TB [TE]
2.3 T5, 2.3 T-5	03/98-10/05	B 5234 T3, B 5234 T9	2319		0-N958	TB [DG]
2.4 T	07/02-10/05	B 5244 T7	2435		0-N137	TB [TE]
2.4 T, 2.5, 2.5 T	03/98-10/05	B 5244 T, B 5254 T, B 5244 T7, B 5254 S	2435		0-N958	TB [DG]
2.5, 2.5 T	03/98-10/05	B 5244 T, B 5254 T, B 5254 S	2435	:1266128→	0-N137	TB [TE]
2.5, 2.5 T	03/98-10/05	B 5244 T, B 5254 T, B 5254 S	2435	:→1266127	0-N930	TB [TE]
2.0 T	03/00-10/05	B 5204 T4	1984		0-N1529	VB [BT] S
2.0 T	03/00-10/05	B 5204 T4	1984	Rippenanzahl: 6;	0-N1647	VB [DG]
2.0, 2.0 T	03/98-10/05	B 5204 T2, B 5204 T3	1984	→ 12/1998	0-N1448	VB [DG]
2.0, 2.0 T	03/98-10/05	B 5204 T2, B 5204 T3	1984	→ 12/1998	0-N1518	VB [BT] S
2.0, 2.0 T	03/98-10/05	B 5204 T2, B 5204 T3	1984	01/1999 →	0-N1529	VB [BT] S
2.0, 2.0 T	03/98-10/05	B 5204 T2, B 5204 T3	1984	01/1999 →; Rippenanzahl: 6;	0-N1647	VB [DG]
2.0, 2.0 T	03/98-10/05	B 5204 T2, B 5204 T3	1984	:→1266127	0-N2223	VB [VD]
2.3 T5	07/02-10/05	B 5234 T9	2319		0-N1529	VB [BT] S
2.3 T5	07/02-10/05	B 5234 T9	2319	Rippenanzahl: 6;	0-N1647	VB [DG]
2.3 T-5	03/98-10/05	B 5234 T3	2319	→ 12/1998	0-N1448	VB [DG]
2.3 T-5	03/98-10/05	B 5234 T3	2319	→ 12/1998	0-N1518	VB [BT] S
2.3 T-5	03/98-10/05	B 5234 T3	2319	01/1999 →	0-N1529	VB [BT] S
2.3 T-5	03/98-10/05	B 5234 T3	2319	01/1999 →; Rippenanzahl: 6;	0-N1647	VB [DG]
2.3 T-5	03/98-10/05	B 5234 T3	2319	:→1266127	0-N2223	VB [VD]
2.4 T	07/02-10/05	B 5244 T7	2435		0-N1529	VB [BT] S
2.4 T	07/02-10/05	B 5244 T7	2435	Rippenanzahl: 6;	0-N1647	VB [DG]
2.5 T	03/98-10/05	B 5244 T, B 5254 T	2435	→ 12/1998	0-N1518	VB [BT] S
2.5, 2.5 T	03/98-10/05	B 5244 T, B 5254 T, B 5254 S	2435	→ 12/1998	0-N1448	VB [DG]
2.5, 2.5 T	03/98-10/05	B 5244 T, B 5254 T, B 5254 S	2435	01/1999 →	0-N1529	VB [BT] S
2.5, 2.5 T	03/98-10/05	B 5244 T, B 5254 T, B 5254 S	2435	01/1999 →; Rippenanzahl: 6;	0-N1647	VB [DG]
2.5, 2.5 T	03/98-10/05	B 5244 T, B 5254 T, B 5254 S	2435	:→1266127	0-N2223	VB [VD]

C70 I Coupe

2.0	03/97-09/02	B 5204 T2	1984	23x148; 03/1998 →; :→1266127; mit Zubehör; Spannrollenbetätigung: hydraulisch	SK-1103	BTK
-----	-------------	-----------	------	---	---------	-----

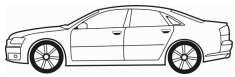

CM³



Art. Nr.



C70 I Coupe

2.0	03/97-09/02	B 5204 T2	1984	23x142; 03/1998 →; :1266128→	SK-1491	BTK	
2.0 T	03/97-09/02	B 5204 T3	1984	23x148; →1266127; mit Zubehör; Spannrollenbetätigung: hydraulisch	SK-1103	BTK	
2.0 T	03/97-09/02	B 5204 T3	1984	23x142; :1266128→	SK-1491	BTK	
2.0 T	03/00-09/02	B 5204 T4	1984	23x142	SK-1491	BTK	
2.0 T	03/00-09/02	B 5204 T4	1984	23x142; :→3192745	SK-1491AQ1	BTKW	
2.0, 2.0 T	03/97-09/02	B 5204 T2, B 5204 T3	1984	23x148; →1266127; mit Zubehör; Spannrollenbetätigung: hydraulisch	SK-1103AQ1	BTKW	
2.0, 2.0 T	03/97-09/02	B 5204 T2, B 5204 T3	1984	23x142; :1266128→; :→3192745; Spannrollenbetätigung: mechanisch	SK-1491AQ1	BTKW	
2.0, 2.0 T	03/97-09/02	B 5204 T2, B 5204 T3, B 5204 T4	1984	23x142; :3192746→	SK-1492	BTK	
2.0, 2.0 T	03/97-09/02	B 5204 T2, B 5204 T3, B 5204 T4	1984	23x142; :3192746→	SK-1492AQ1	BTKW	
2.3 T-5	03/97-09/02	B 5234 T3	2319	23x148; →1266127; mit Zubehör; Spannrollenbetätigung: hydraulisch	SK-1103	BTK	
2.3 T-5	03/97-09/02	B 5234 T3	2319	23x148; →1266127; mit Zubehör; Spannrollenbetätigung: hydraulisch	SK-1103AQ1	BTKW	
2.3 T-5	03/97-09/02	B 5234 T3	2319	23x142; :1266128→	SK-1491	BTK	
2.3 T-5	03/97-09/02	B 5234 T3	2319	23x142; :1266128→; :→3192745; Spannrollenbetätigung: mechanisch	SK-1491AQ1	BTKW	
2.3 T-5	03/97-09/02	B 5234 T3	2319	23x142; :3192746→	SK-1492	BTK	
2.3 T-5	03/97-09/02	B 5234 T3	2319	23x142; :3192746→	SK-1492AQ1	BTKW	
2.5	03/99-09/02	B 5244 S, B 5254 S, B 5254 S	2435	23x148; →1266127; mit Zubehör	SK-1103	BTK	
2.5	03/99-09/02	B 5254 S	2435	23x142	SK-1491	BTK	
2.5	03/99-09/02	B 5244 S, B 5254 S, B 5254 S	2435	23x142; :→3192745	SK-1491AQ1	BTKW	
2.5	05/99-09/02	B 5244 S	2435	23x142; 10/1999 →	SK-1491	BTK	
2.5 T	03/97-09/02	B 5244 T, B 5254 T	2435	23x148; →1266127; mit Zubehör; Spannrollenbetätigung: hydraulisch	SK-1103	BTK	
2.5 T	03/97-09/02	B 5244 T, B 5254 T	2435	23x148; →1266127; mit Zubehör; Spannrollenbetätigung: hydraulisch	SK-1103AQ1	BTKW	
2.5 T	03/97-09/02	B 5244 T, B 5254 T	2435	23x142; :1266128→	SK-1491	BTK	
2.5 T	03/97-09/02	B 5244 T, B 5254 T	2435	23x142; :1266128→; :→3192745; Spannrollenbetätigung: mechanisch	SK-1491AQ1	BTKW	
2.5, 2.5 T	03/97-09/02	B 5244 S, B 5254 S, B 5244 T, B 5254 T, B 5254 S	2435	23x142; :3192746→	SK-1492	BTK	
2.5, 2.5 T	03/97-09/02	B 5244 S, B 5254 S, B 5244 T, B 5254 T, B 5254 S	2435	23x142; :3192746→	SK-1492AQ1	BTKW	
2.0 T	03/00-09/02	B 5204 T4	1984		0-N137	TB [TE]	
2.0, 2.0 T	03/97-09/02	B 5204 T2, B 5204 T3	1984	:1266128→	0-N137	TB [TE]	
2.0, 2.0 T	03/97-09/02	B 5204 T2, B 5204 T3	1984	:→1266127	0-N930	TB [TE]	
2.0, 2.0 T	03/97-09/02	B 5204 T2, B 5204 T3, B 5204 T4	1984		0-N958	TB [DG]	
2.3 T-5	03/97-09/02	B 5234 T3	2319	:1266128→	0-N137	TB [TE]	
2.3 T-5	03/97-09/02	B 5234 T3	2319	:→1266127	0-N930	TB [TE]	
2.3 T-5	03/97-09/02	B 5234 T3	2319		0-N958	TB [DG]	
2.5, 2.5 T	03/97-09/02	B 5244 S, B 5254 S, B 5244 T, B 5254 T, B 5254 S	2435	:1266128→	0-N137	TB [TE]	
2.5, 2.5 T	03/97-09/02	B 5244 S, B 5254 S, B 5244 T, B 5254 T, B 5254 S	2435	:→1266127	0-N930	TB [TE]	
2.5, 2.5 T	03/97-09/02	B 5244 S, B 5254 S, B 5244 T, B 5254 T, B 5254 S	2435		0-N958	TB [DG]	
2.0 T	03/00-09/02	B 5204 T4	1984		0-N1529	VB [BT]	S
2.0 T	03/00-09/02	B 5204 T4	1984	Rippenanzahl: 6;	0-N1647	VB [DG]	
2.0, 2.0 T	03/97-09/02	B 5204 T2, B 5204 T3	1984	→ 12/1998	0-N1448	VB [DG]	
2.0, 2.0 T	03/97-09/02	B 5204 T2, B 5204 T3	1984	→ 12/1998	0-N1518	VB [BT]	S
2.0, 2.0 T	03/97-09/02	B 5204 T2, B 5204 T3	1984	01/1999 →	0-N1529	VB [BT]	S
2.0, 2.0 T	03/97-09/02	B 5204 T2, B 5204 T3	1984	01/1999 →; Rippenanzahl: 6;	0-N1647	VB [DG]	
2.0, 2.0 T	03/97-09/02	B 5204 T2, B 5204 T3	1984	:→1266127	0-N2223	VB [VD]	
2.3 T-5	03/97-09/02	B 5234 T3	2319	→ 12/1998	0-N1448	VB [DG]	
2.3 T-5	03/97-09/02	B 5234 T3	2319	→ 12/1998	0-N1518	VB [BT]	S
2.3 T-5	03/97-09/02	B 5234 T3	2319	01/1999 →	0-N1529	VB [BT]	S
2.3 T-5	03/97-09/02	B 5234 T3	2319	01/1999 →; Rippenanzahl: 6;	0-N1647	VB [DG]	
2.3 T-5	03/97-09/02	B 5234 T3	2319	:→1266127	0-N2223	VB [VD]	
2.5	03/99-09/02	B 5244 S, B 5254 S, B 5254 S	2435		0-N1529	VB [BT]	S
2.5	03/99-09/02	B 5244 S, B 5254 S, B 5254 S	2435	Rippenanzahl: 6;	0-N1647	VB [DG]	
2.5 T	03/97-09/02	B 5244 T, B 5254 T	2435	→ 12/1998	0-N1448	VB [DG]	
2.5 T	03/97-09/02	B 5244 T, B 5254 T	2435	→ 12/1998	0-N1518	VB [BT]	S
2.5 T	03/97-09/02	B 5244 T, B 5254 T	2435	01/1999 →	0-N1529	VB [BT]	S
2.5 T	03/97-09/02	B 5244 T, B 5254 T	2435	01/1999 →; Rippenanzahl: 6;	0-N1647	VB [DG]	
2.5, 2.5 T	03/97-09/02	B 5244 S, B 5254 S, B 5244 T, B 5254 T, B 5254 S	2435	:→1266127	0-N2223	VB [VD]	



OPTIMAL®

VOLVO



CM³



Art. Nr.



ohne Halter

C70 II Cabriolet

2.0 D	01/08-10/09	D 4204 T	1997	25.4x116	SK-1594	BTK
2.0 D	01/08-10/09	D 4204 T	1997	25.4x116	SK-1594AQ1	BTKW
2.4 D	03/07-06/13	D 5244 T9	2400	28x132; 06/2009 →	SK-1608	BTK
2.4, 2.4 i	03/06-10/09	B 5244 S4, B 5244 S5	2435	23x142; :→3887615	SK-1492	BTK
2.4, 2.4 i	03/06-10/09	B 5244 S4, B 5244 S5	2435	23x142; :→3887615	SK-1492AQ1	BTKW
2.4, 2.4 i	03/06-10/09	B 5244 S4, B 5244 S5	2435	23x142	SK-1666	BTK
2.4, 2.4 i	03/06-10/09	B 5244 S4, B 5244 S5	2435	23x142; :3887616→	SK-1666AQ1	BTKW
D5	03/06-06/13	D 5244 T13, D 5244 T8	2400	28x132	SK-1608	BTK
D5	03/06-06/13	D 5244 T13, D 5244 T8	2400	28x132	SK-1608AQ1	BTKW
T5	03/06-10/09	B 5254 T3, B 5254 T7	2521	23x142; :→3887615	SK-1492	BTK
T5	03/06-10/09	B 5254 T3, B 5254 T7	2521	23x142; :→3887615	SK-1492AQ1	BTKW
T5	03/06-10/09	B 5254 T3, B 5254 T7	2521	23x142	SK-1666	BTK
T5	03/06-10/09	B 5254 T3, B 5254 T7	2521	23x142; :3887616→	SK-1666AQ1	BTKW
2.0 D	01/08-10/09	D 4204 T	1997		0-N1334	TB [DG]
2.4, 2.4 i	03/06-10/09	B 5244 S4, B 5244 S5	2435	1186	0-N1324	TB [TE]
2.4, 2.4 i	03/06-10/09	B 5244 S4, B 5244 S5	2435	ch.1187→	0-N1573	TB [TE]
2.4, 2.4 i	03/06-10/09	B 5244 S4, B 5244 S5	2435		0-N958	TB [DG]
D3, D4	10/10-06/13	D 5204 T, D 5204 T5	1984		0-N1349	TB [TE]
D3, D4	10/10-06/13	D 5204 T, D 5204 T5	1984		0-N1350	TB [DG]
D5	03/06-06/13	D 5244 T13, D 5244 T8	2400		0-N1349	TB [TE]
D5	03/06-06/13	D 5244 T13, D 5244 T8	2400		0-N1350	TB [DG]
T5	03/06-10/09	B 5254 T3, B 5254 T7	2521	1186	0-N1324	TB [TE]
T5	03/06-10/09	B 5254 T3, B 5254 T7	2521	ch.1187→	0-N1573	TB [TE]
T5	03/06-10/09	B 5254 T3, B 5254 T7	2521		0-N958	TB [DG]
2.0 D	01/08-10/09	D 4204 T	1997		0-N1327	VB [BT]
2.0 D	01/08-10/09	D 4204 T	1997		0-N2037	VB [BT] S
2.4, 2.4 i	03/06-10/09	B 5244 S4, B 5244 S5	2435	:→4293284	0-N1554	VB [BT] S
2.4, 2.4 i	03/06-10/09	B 5244 S4, B 5244 S5	2435	:→4293284	0-N2096	VB [BT] S
2.4, 2.4 i	03/06-10/09	B 5244 S4, B 5244 S5	2435	:4293285→	0-N2109	VB [BT] S
2.4, 2.4 i	03/06-10/09	B 5244 S4, B 5244 S5	2435	:4293285→	0-N2190	VB [BT] S
D3, D4	10/10-06/13	D 5204 T, D 5204 T5	1984	:→619467;	0-N2096	VB [BT] S
D3, D4	10/10-06/13	D 5204 T, D 5204 T5	1984	:619468→;	0-N2109	VB [BT] S
D3, D4	10/10-06/13	D 5204 T, D 5204 T5	1984	:619468→;	0-N2190	VB [BT] S
D5	03/06-06/13	D 5244 T13, D 5244 T8	2400	:→619467	0-N1554	VB [BT] S
D5	03/06-06/13	D 5244 T13, D 5244 T8	2400	:→619467	0-N2096	VB [BT] S
D5	03/06-06/13	D 5244 T13, D 5244 T8	2400	:619468→	0-N2109	VB [BT] S
D5	03/06-06/13	D 5244 T13, D 5244 T8	2400	:619468→	0-N2190	VB [BT] S
T5	03/06-10/09	B 5254 T3, B 5254 T7	2521	:→4293284	0-N1554	VB [BT] S
T5	03/06-10/09	B 5254 T3, B 5254 T7	2521	:→4293284	0-N2096	VB [BT] S
T5	03/06-10/09	B 5254 T3, B 5254 T7	2521	:4293285→	0-N2109	VB [BT] S
T5	03/06-10/09	B 5254 T3, B 5254 T7	2521	:4293285→	0-N2190	VB [BT] S

S40 I (VS)

1.6	09/95-08/99	B 4164 S	1588	23x148; 03/1997 →; :→1266195; mit Zubehör; Spannrollenbetätigung: hydraulisch	SK-1103	BTK
1.6	09/95-08/99	B 4164 S	1588	23x148; :→1266195; mit Zubehör; Spannrollenbetätigung: hydraulisch	SK-1103AQ1	BTKW
1.6	09/95-08/99	B 4164 S	1588	23x142; 03/1997 →; :1266196→	SK-1491	BTK
1.6	09/95-08/99	B 4164 S	1588	23x142; :1266196→; Spannrollenbetätigung: mechanisch	SK-1491AQ1	BTKW
1.6	03/99-12/03	B 4164 S2	1587	23x148; :→1219110; mit Zubehör	SK-1103	BTK
1.6	03/99-12/03	B 4164 S2	1587	23x142; 10/1999 →	SK-1491	BTK
1.6	03/99-12/03	B 4164 S2	1587	23x142	SK-1491AQ1	BTKW
1.8	07/95-08/99	B 4184 S	1731	23x148; 11/1995 →; :→1266195; mit Zubehör; Spannrollenbetätigung: hydraulisch	SK-1103	BTK
1.8	07/95-08/99	B 4184 S	1731	23x148; :→1266195; mit Zubehör; Spannrollenbetätigung: hydraulisch	SK-1103AQ1	BTKW
1.8	07/95-08/99	B 4184 S3	1731	23x142; 11/1995 →	SK-1491	BTK
1.8	07/95-08/99	B 4184 S	1731	23x142; 11/1995 →; :1266196→; Spannrollenbetätigung: mechanisch	SK-1491	BTK
1.8	07/95-08/99	B 4184 S3	1731	23x142	SK-1491AQ1	BTKW
1.8	07/95-08/99	B 4184 S	1731	23x142; :1266196→; Spannrollenbetätigung: mechanisch	SK-1491AQ1	BTKW
1.8	03/99-12/03	B 4184 S2, B 4184 S9	1783	23x148; mit Zubehör; Spannrollenbetätigung: automatisch	SK-1103	BTK
1.8	03/99-12/03	B 4184 S2	1783	23x142; 10/1999 →	SK-1491	BTK
1.8	03/99-12/03	B 4184 S2, B 4184 S2, B 4184 S9	1783	23x142	SK-1491AQ1	BTKW
1.8	06/01-08/03	B 4184 S2	1783	23x142	SK-1491	BTK



CM³



Art. Nr.



S40 I (VS)

1.8 i	03/98-12/03	B 4184 SJ, B 4184 SM	1834	29x154	SK-1325	BTK
1.8 i	03/98-12/03	B 4184 SJ, B 4184 SM	1834	29x154	SK-1325AQ2	BTKW
1.9 DI	03/99-07/00	D 4192 T2	1870	26x153; beinhaltetete Rollen: 3; mit Zahnrad	SK-1084	BTK
1.9 DI	03/99-07/00	D 4192 T2	1870	26x153; beinhaltetete Rollen: 2	SK-1114	BTK
1.9 DI	07/00-12/03	D 4192 T3, D 4192 T4	1870	26x132	SK-1493	BTK
1.9 DI	07/00-12/03	D 4192 T3, D 4192 T4	1870	26x132	SK-1493AQ1	BTKW
1.9 DI	07/00-12/03	D 4192 T3, D 4192 T4	1870	26x132	SK-1493AQ2	BTKW
1.9 T4	05/97-07/00	B 4194 T	1855	23x148; 10/1997 →; :→1219753; mit Zubehör; Spannrollenbetätigung: hydraulisch	SK-1103	BTK
1.9 T4	05/97-07/00	B 4194 T	1855	23x148; :→1219753; mit Zubehör; Spannrollenbetätigung: hydraulisch	SK-1103AQ1	BTKW
1.9 T4	05/97-07/00	B 4194 T2	1855	23x142; 10/1997 →	SK-1491	BTK
1.9 T4	05/97-07/00	B 4194 T	1855	23x142; 10/1997 →; :1219754→; Spannrollenbetätigung: mechanisch	SK-1491	BTK
1.9 T4	05/97-07/00	B 4194 T2	1855	23x142	SK-1491AQ1	BTKW
1.9 T4	05/97-07/00	B 4194 T	1855	23x142; :1219754→; Spannrollenbetätigung: mechanisch	SK-1491AQ1	BTKW
1.9 TD	07/95-08/99	D 4192 T	1870	25.4x153; 01/1996 →; :→3534	SK-1705	BTK
1.9 TD	07/95-08/99	D 4192 T	1870	25.4x153; 01/1996 →; :3535→; :→20559; mit Zahnrad	SK-1707	BTK
2.0	07/95-08/99	B 4204 S	1948	23x148; :→1266195; mit Zubehör; Spannrollenbetätigung: hydraulisch	SK-1103	BTK
2.0	07/95-12/03	B 4204 S, B 4204 S2	1948	23x148; :→1219110; mit Zubehör	SK-1103	BTK
2.0	07/95-08/99	B 4204 S	1948	23x148; :→1266195; mit Zubehör; Spannrollenbetätigung: hydraulisch	SK-1103AQ1	BTKW
2.0	07/95-12/03	B4204S	1948	23x148; :→1266195; mit Zubehör; Spannrollenbetätigung: hydraulisch	SK-1103AQ1	BTKW
2.0	07/95-08/99	B 4204 S	1948	23x142; :1266196→	SK-1491	BTK
2.0	07/95-12/03	B 4204 S2	1948	23x142; 12/1999 →	SK-1491	BTK
2.0	07/95-08/99	B 4204 S	1948	23x142; :1266196→; Spannrollenbetätigung: mechanisch	SK-1491AQ1	BTKW
2.0	07/95-12/03	B 4204 S2	1948	23x142	SK-1491AQ1	BTKW
2.0	07/95-12/03	B4204S	1948	23x142; :1266196→; Spannrollenbetätigung: mechanisch	SK-1491AQ1	BTKW
2.0 T	10/97-12/03	B 4204 T	1948	23x148; :→1219753; mit Zubehör; Spannrollenbetätigung: hydraulisch	SK-1103	BTK
2.0 T	10/97-12/03	B 4204 T	1948	23x148; :→1219753; mit Zubehör; Spannrollenbetätigung: hydraulisch	SK-1103AQ1	BTKW
2.0 T	10/97-12/03	B 4204 T	1948	23x142; :1219754→	SK-1491	BTK
2.0 T	10/97-12/03	B 4204 T	1948	23x142; :1219754→; Spannrollenbetätigung: mechanisch	SK-1491AQ1	BTKW
2.0 T	07/00-06/01	B 4204 T3, B4204T2	1948	23x142	SK-1491	BTK
2.0 T	06/01-12/03	B 4204 T3	1948	23x142	SK-1491	BTK
2.0 T, 2.0 T4	07/00-12/03	B 4204 T2, B 4204 T3, B 4204 T3, B 4204 T5	1948	23x142	SK-1491AQ1	BTKW
2.0 T4	07/00-12/03	B 4204 T5	1948	23x142; 12/2000 →	SK-1491	BTK
1.6	09/95-08/99	B 4164 S	1588	:1266196→	0-N137	TB [TE]
1.6	09/95-08/99	B 4164 S	1588	:→1266195	0-N930	TB [TE]
1.6	09/95-08/99	B 4164 S	1588		0-N958	TB [DG]
1.6	03/99-12/03	B 4164 S2	1587		0-N137	TB [TE]
1.6	03/99-12/03	B 4164 S2	1587		0-N958	TB [DG]
1.8	07/95-08/99	B 4184 S, B 4184 S3	1731	:1266196→	0-N137	TB [TE]
1.8	07/95-08/99	B 4184 S, B 4184 S3	1731	:→1266195	0-N930	TB [TE]
1.8	07/95-08/99	B 4184 S, B 4184 S3	1731		0-N958	TB [DG]
1.8	03/99-12/03	B 4184 S2, B 4184 S2, B 4184 S9	1783		0-N137	TB [TE]
1.8	03/99-12/03	B 4184 S2, B 4184 S2, B 4184 S9	1783		0-N958	TB [DG]
1.8 i	03/98-12/03	B 4184 SJ, B 4184 SM	1834		0-N055	TB [DG]
1.8 i	03/98-12/03	B 4184 SJ, B 4184 SM	1834		0-N056	TB [TE]
1.9 DI	03/99-07/00	D 4192 T2	1870		0-N147	TB [DG]
1.9 DI	03/99-07/00	D 4192 T2	1870		0-N148	TB [DG]
1.9 DI	07/00-12/03	D 4192 T3, D 4192 T4	1870	mit Grundträger	0-N1173	TB [BT]
1.9 DI, 1.9 TD	07/95-07/00	D 4192 T, D 4192 T2	1870		0-N173	TB [TE]
1.9 T4	05/97-07/00	B 4194 T, B 4194 T2	1855	:1219753→	0-N137	TB [TE]
1.9 T4	05/97-07/00	B 4194 T, B 4194 T2	1855	:→1219752	0-N930	TB [TE]
1.9 T4	05/97-07/00	B 4194 T	1855		0-N958	TB [DG]
1.9 TD	07/95-08/99	D 4192 T	1870	:20560→	0-N147	TB [DG]
1.9 TD	07/95-08/99	D 4192 T	1870		0-N854	TB [DG]
2.0	07/95-12/03	B 4204 S, B 4204 S, B 4204 S2	1948	:1266196→	0-N137	TB [TE]
2.0	07/95-12/03	B 4204 S, B 4204 S, B 4204 S2	1948	:→1266195	0-N930	TB [TE]



CM³



Art. Nr.



ohne Halter

S40 I (VS)

2.0 T	10/97-12/03	B 4204 T	1948	:1219753→	0-N137	TB [TE]	
2.0 T	10/97-12/03	B 4204 T	1948	:→1219752	0-N930	TB [TE]	
2.0 T, 2.0 T4	07/00-12/03	B 4204 T2, B 4204 T3, B 4204 T3, B 4204 T5	1948		0-N137	TB [TE]	
2.0, 2.0 T, 2.0 T4	07/95-12/03	B 4204 S, B 4204 S, B 4204 S2, B 4204 T, B 4204 T2, B 4204 T3, B 4204 T3, B 4204 T5	1948		0-N958	TB [DG]	
1.6	09/95-08/99	B 4164 S	1588		0-N1425	VB [DG]	
1.6	09/95-08/99	B 4164 S	1588		0-N1558S	VB [TE]	
1.6	09/95-08/99	B 4164 S	1588	:→1266195	0-N2223	VB [VD]	
1.6	03/99-12/03	B 4164 S2	1587		0-N1529	VB [BT]	S
1.6	03/99-12/03	B 4164 S2	1587	Rippenanzahl: 6;	0-N1647	VB [DG]	
1.8	07/95-08/99	B 4184 S, B 4184 S3	1731		0-N1425	VB [DG]	
1.8	07/95-08/99	B 4184 S, B 4184 S3	1731		0-N1558S	VB [TE]	
1.8	07/95-08/99	B 4184 S, B 4184 S3	1731	:→1266195	0-N2223	VB [VD]	
1.8	03/99-12/03	B 4184 S2, B 4184 S9	1783		0-N1529	VB [BT]	S
1.8	03/99-12/03	B 4184 S2, B 4184 S9	1783	Rippenanzahl: 6;	0-N1647	VB [DG]	
1.9 DI	03/99-07/00	D 4192 T2	1870		0-N1470	VB [BT]	S
1.9 DI	03/99-07/00	D 4192 T2	1870		0-N1729	VB [DG]	
1.9 DI	07/00-12/03	D 4192 T3, D 4192 T4	1870		0-N1307	VB [DG]	
1.9 DI	07/00-12/03	D 4192 T3, D 4192 T4	1870		0-N1611	VB [BT]	S
1.9 DI	07/00-12/03	D 4192 T3, D 4192 T4	1870		0-N1802	VB [BT]	S
1.9 T4	05/97-07/00	B 4194 T, B 4194 T2	1855		0-N1425	VB [DG]	
1.9 T4	05/97-07/00	B 4194 T, B 4194 T2	1855		0-N1558S	VB [TE]	
1.9 T4	05/97-07/00	B 4194 T, B 4194 T2	1855	:→1219752	0-N2223	VB [VD]	
1.9 TD	07/95-08/99	D 4192 T	1870	:7795→	0-N1470	VB [BT]	S
1.9 TD	07/95-08/99	D 4192 T	1870	:→7794	0-N152	VB [BT]	S
1.9 TD	07/95-08/99	D 4192 T	1870		0-N1729	VB [DG]	
2.0	07/95-12/03	B 4204 S, B 4204 S, B 4204 S2	1948	:→1266195	0-N2223	VB [VD]	
2.0 T	10/97-12/03	B 4204 T	1948	:→1219752	0-N2223	VB [VD]	
2.0 T, 2.0 T4	07/00-12/03	B 4204 T2, B 4204 T3, B 4204 T3, B 4204 T5	1948		0-N1529	VB [BT]	S
2.0 T, 2.0 T4	07/00-12/03	B 4204 T2, B 4204 T3, B 4204 T3, B 4204 T5	1948	Rippenanzahl: 6;	0-N1647	VB [DG]	
2.0, 2.0 T	07/95-12/03	B 4204 S, B 4204 S, B 4204 S2, B 4204 T	1948		0-N1425	VB [DG]	
2.0, 2.0 T	07/95-12/03	B 4204 S, B 4204 S, B 4204 S2, B 4204 T	1948		0-N1558S	VB [TE]	

S40 II (MS)

1.6	01/05-	B 4164 S3	1596	22x117; 115002; mit Zubehör	SK-1077	BTK	
1.6	01/05-	B 4164 S3	1596	22x117; 115002; mit Zubehör	SK-1077AQ1	BTKW	
1.6	01/05-	B 4164 S3	1596	22x117; ch.115003→; 05/2005 →; mit Zubehör	SK-1659	BTK	
1.6	01/05-	B 4164 S3	1596	22x117; ch.115003→; mit Zubehör	SK-1659AQ1	BTKW	
1.6 D	01/05-	D 4164 T	1560	25x137	SK-1424	BTK	
1.6 D	01/05-	D 4164 T	1560	25x137	SK-1424AQ1	BTKW	
1.6 D2	10/10-	D 4162 T	1560	25x141	SK-1728	BTK	
1.6 D2	10/10-	D 4162 T	1560	25x141	SK-1728AQ1	BTKW	
2.0 D, 2.0 D4	01/04-	D 4204 T, D 4204 T2	1998	25.4x116	SK-1594	BTK	
2.0 D, 2.0 D4	01/04-	D 4204 T, D 4204 T2	1998	25.4x116	SK-1594AQ1	BTKW	
2.4 D5	03/06-	D 5244 T13, D 5244 T8	2400	28x132	SK-1608	BTK	
2.4 D5	03/06-	D 5244 T13, D 5244 T8	2400	28x132	SK-1608AQ1	BTKW	
2.4, 2.4 AWD	01/04-	B 5244 S4, B 5244 S5	2435	23x142; :→3887615	SK-1492	BTK	
2.4, 2.4 AWD	01/04-	B 5244 S4, B 5244 S5	2435	23x142; :→3887615	SK-1492AQ1	BTKW	
2.4, 2.4 AWD	01/04-	B 5244 S4, B 5244 S5	2435	23x142; :3887616→	SK-1666	BTK	
2.4, 2.4 AWD	01/04-	B 5244 S4, B 5244 S5	2435	23x142; :3887616→	SK-1666AQ1	BTKW	
D3	10/10-	D 5204 T5	1984	28x132; :1046802→	SK-1608	BTK	
T5, T5 AWD	01/04-	B 5254 T3, B 5254 T7	2521	23x142; :→3887615	SK-1492	BTK	
T5, T5 AWD	01/04-	B 5254 T3, B 5254 T7	2521	23x142; :→3887615	SK-1492AQ1	BTKW	
T5, T5 AWD	01/04-	B 5254 T3, B 5254 T7	2521	23x142; :3887616→	SK-1666	BTK	
T5, T5 AWD	01/04-	B 5254 T3, B 5254 T7	2521	23x142; :3887616→	SK-1666AQ1	BTKW	
1.6	01/05-	B 4164 S3	1596	ch.115003→	0-N1564	TB [TE]	
1.6	01/05-	B 4164 S3	1596	115002	0-N294	TB [TE]	
1.6 D	01/05-	D 4164 T	1560		0-N1062	TB [TE]	
1.6 D	01/05-	D 4164 T	1560		0-N1066	TB [DG]	
1.6 D2	10/10-	D 4162 T	1560		0-N2224	TB [TE]	
1.6 D2	10/10-	D 4162 T	1560		0-N2382	TB [DG]	
2.0 D, 2.0 D4	01/04-	D 4204 T, D 4204 T2	1998		0-N1334	TB [DG]	

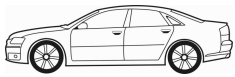

CM³



Art. Nr.



S40 II (MS)

2.4 D5	03/06-	D 5244 T13, D 5244 T8	2400		0-N1349	TB [TE]	
2.4 D5	03/06-	D 5244 T13, D 5244 T8	2400		0-N1350	TB [DG]	
2.4, 2.4 AWD	01/04-	B 5244 S4, B 5244 S5	2435	ch.→202464	0-N1324	TB [TE]	
2.4, 2.4 AWD	01/04-	B 5244 S4, B 5244 S5	2435	ch.202465→	0-N1573	TB [TE]	
2.4, 2.4 AWD	01/04-	B 5244 S4, B 5244 S5	2435		0-N958	TB [DG]	
D3, D4	10/10-	D 5204 T, D 5204 T5	1984		0-N1349	TB [TE]	
D3, D4	10/10-	D 5204 T, D 5204 T5	1984		0-N1350	TB [DG]	
T5, T5 AWD	01/04-	B 5254 T3, B 5254 T7	2521	ch.→202464	0-N1324	TB [TE]	
T5, T5 AWD	01/04-	B 5254 T3, B 5254 T7	2521	ch.202465→	0-N1573	TB [TE]	
T5, T5 AWD	01/04-	B 5254 T3, B 5254 T7	2521		0-N958	TB [DG]	
1.6 D	01/05-	D 4164 T	1560	ch.→503828	0-N1339	VB [BT]	S
1.8, 1.8 FlexFuel	04/04-	B 4184 S11, B 4184 S8	1798	ch.→73764	0-N1639	VB [BT]	S
1.8, 1.8 FlexFuel	04/04-	B 4184 S11, B 4184 S8	1798		0-N2353	VB [DG]	
2.0	10/06-	B 4204 S3	1999	ch.→73764	0-N1639	VB [BT]	S
2.0 D, 2.0 D4	01/04-	D 4204 T, D 4204 T2	1998		0-N1327	VB [BT]	
2.0 D, 2.0 D4	01/04-	D 4204 T, D 4204 T2	1998		0-N2037	VB [BT]	S
2.0 F	10/09-	B 4204 S4	1999	Rippenanzahl: 6	0-N1497	VB [BT]	S
2.0 F	10/09-	B 4204 S4	1999		0-N1991	VB [DG]	
2.0, 2.0 F	10/06-	B 4204 S3, B 4204 S4	1999		0-N2353	VB [DG]	
2.4 D5	03/06-	D 5244 T13, D 5244 T8	2400	:→619467	0-N1554	VB [BT]	S
2.4 D5	03/06-	D 5244 T13, D 5244 T8	2400	:→619467	0-N2096	VB [BT]	S
2.4 D5	03/06-	D 5244 T13, D 5244 T8	2400	:619468→	0-N2109	VB [BT]	S
2.4 D5	03/06-	D 5244 T13, D 5244 T8	2400	:619468→	0-N2190	VB [BT]	S
2.4, 2.4 AWD	01/04-	B 5244 S4, B 5244 S5	2435	:→4293284	0-N1554	VB [BT]	S
2.4, 2.4 AWD	01/04-	B 5244 S4, B 5244 S5	2435	:→4293284	0-N2096	VB [BT]	S
2.4, 2.4 AWD	01/04-	B 5244 S4, B 5244 S5	2435	:4293285→	0-N2109	VB [BT]	S
2.4, 2.4 AWD	01/04-	B 5244 S4, B 5244 S5	2435	:4293285→	0-N2190	VB [BT]	S
D3, D4	10/10-	D 5204 T, D 5204 T5	1984	:→619467;	0-N2096	VB [BT]	S
D3, D4	10/10-	D 5204 T, D 5204 T5	1984	:619468→;	0-N2109	VB [BT]	S
D3, D4	10/10-	D 5204 T, D 5204 T5	1984	:619468→;	0-N2190	VB [BT]	S
T5, T5 AWD	01/04-	B 5254 T3, B 5254 T7	2521	:→4293284	0-N1554	VB [BT]	S
T5, T5 AWD	01/04-	B 5254 T3, B 5254 T7	2521	:→4293284	0-N2096	VB [BT]	S
T5, T5 AWD	01/04-	B 5254 T3, B 5254 T7	2521	:4293285→	0-N2109	VB [BT]	S
T5, T5 AWD	01/04-	B 5254 T3, B 5254 T7	2521	:4293285→	0-N2190	VB [BT]	S

S60 I

2.0 T	07/00-04/10	B 5204 T5	1984	23x142; :→3188688	SK-1491	BTK	
2.0 T	07/00-04/10	B 5204 T5	1984	23x142; :→3188688	SK-1491AQ1	BTKW	
2.0 T	07/00-04/10	B 5204 T5	1984	23x142; :3188689→	SK-1492	BTK	
2.0 T	07/00-04/10	B 5204 T5	1984	23x142; :3188689→	SK-1492AQ1	BTKW	
2.3 T5, T5	07/00-04/10	B 5234 T3, B 5234 T7	2319	23x142; :→3188688	SK-1491	BTK	
2.3 T5, T5	07/00-04/10	B 5234 T3, B 5234 T7	2319	23x142; :→3188688	SK-1491AQ1	BTKW	
2.3 T5, T5	07/00-04/10	B 5234 T3, B 5234 T7	2319	23x142; :3188689→	SK-1492	BTK	
2.3 T5, T5	07/00-04/10	B 5234 T3, B 5234 T7	2319	23x142; :3188689→	SK-1492AQ1	BTKW	
2.4 AWD, 2.4 T5	02/04-04/10	B 5244 T5	2401	23x142; :→3188688	SK-1491	BTK	
2.4 AWD, 2.4 T5	02/04-04/10	B 5244 T5	2401	28x132; 2008→	SK-1608	BTK	
2.4 Bifuel	06/02-04/10	B 5244 SG	2435	23x142; :8188689→	SK-1492AQ1	BTKW	
2.4 D	09/05-04/10	D 5244 T5, D 5244 T7	2400	28x132	SK-1608	BTK	
2.4 D	09/05-04/10	D 5244 T5, D 5244 T7	2400	28x132	SK-1608AQ1	BTKW	
2.4 D, 2.4 D5	07/01-04/10	D 5244 T, D 5244 T2, D 5244 T4	2401	28x132	SK-1608	BTK	
2.4 D, 2.4 D5	07/01-04/10	D 5244 T, D 5244 T2, D 5244 T4	2401	28x132	SK-1608AQ1	BTKW	
2.4 T5	04/04-04/10	B 5244 T5	2401	23x142; :→3188688	SK-1491AQ1	BTKW	
2.4 T5	04/04-04/10	B 5244 T5	2401	23x142; :3188689→	SK-1492	BTK	
2.4 T5	04/04-04/10	B 5244 T5	2401	23x142; :3188689→	SK-1492AQ1	BTKW	
2.4, 2.4 Bifuel (LPG), 2.4 T, 2.4 T AWD	11/00-04/10	B 5244 S, B 5244 S2, B 5244 SG2, B 5244 T3	2435	23x142; :3188689→	SK-1492AQ1	BTKW	
2.4, 2.4 Bifuel, 2.4 Bifuel (LPG), 2.4 T, 2.4 T AWD	11/00-04/10	B 5244 S, B 5244 S2, B 5244 SG, B 5244 SG2, B 5244 T3	2435	23x142; :→3188688	SK-1491	BTK	
2.4, 2.4 Bifuel, 2.4 Bifuel (LPG), 2.4 T, 2.4 T AWD	11/00-04/10	B 5244 S, B 5244 S2, B 5244 SG, B 5244 SG2, B 5244 T3	2435	23x142; :→3188688	SK-1491AQ1	BTKW	
2.4, 2.4 Bifuel, 2.4 Bifuel (LPG), 2.4 T, 2.4 T AWD	11/00-04/10	B 5244 S, B 5244 S2, B 5244 SG, B 5244 SG2, B 5244 T3	2435	23x142; :3188689→	SK-1492	BTK	
2.5 T, 2.5 T AWD	02/04-04/10	B 5254 T2	2521	23x142; :→3188688	SK-1491	BTK	
2.5 T, 2.5 T AWD	02/04-04/10	B 5254 T2	2521	23x142; :→3188688	SK-1491AQ1	BTKW	
2.5 T, 2.5 T AWD, R 2.5 T AWD	03/03-04/10	B 5254 T2, B 5254 T4	2521	23x142; :3188689→	SK-1492	BTK	
2.5 T, 2.5 T AWD, R 2.5 T AWD	03/03-04/10	B 5254 T2, B 5254 T4	2521	23x142; :3188689→	SK-1492AQ1	BTKW	
R 2.5 T AWD	03/03-04/10	B 5254 T4	2521	23x142; 10/2003 →	SK-1491	BTK	



CM³



Art. Nr.



ohne Halter

S60 I

2.0 T	07/00-04/10	B 5204 T5	1984	:3188689→	0-N1324	TB [TE]	
2.0 T	07/00-04/10	B 5204 T5	1984	:→3188688	0-N137	TB [TE]	
2.0 T	07/00-04/10	B 5204 T5	1984		0-N958	TB [DG]	
2.3 T5, T5	07/00-04/10	B 5234 T3, B 5234 T7	2319	:3188689→	0-N1324	TB [TE]	
2.3 T5, T5	07/00-04/10	B 5234 T3, B 5234 T7	2319	:→3188688	0-N137	TB [TE]	
2.3 T5, T5	07/00-04/10	B 5234 T3, B 5234 T7	2319		0-N958	TB [DG]	
2.4 AWD, 2.4 T5	02/04-04/10	B 5244 T5	2401	:3188689→	0-N1324	TB [TE]	
2.4 AWD, 2.4 T5	02/04-04/10	B 5244 T5	2401	:→3188688	0-N137	TB [TE]	
2.4 AWD, 2.4 T5	02/04-04/10	B 5244 T5	2401		0-N958	TB [DG]	
2.4 D	09/05-04/10	D 5244 T5, D 5244 T7	2400		0-N1349	TB [TE]	
2.4 D	09/05-04/10	D 5244 T5, D 5244 T7	2400		0-N1350	TB [DG]	
2.4 D, 2.4 D5	07/01-04/10	D 5244 T, D 5244 T2, D 5244 T4	2401		0-N1349	TB [TE]	
2.4 D, 2.4 D5	07/01-04/10	D 5244 T, D 5244 T2, D 5244 T4	2401		0-N1350	TB [DG]	
2.4, 2.4 Bifuel, 2.4 T, 2.4 T AWD	11/00-04/10	B 5244 S, B 5244 S2, B 5244 SG, B 5244 T3	2435	:3188689→	0-N1324	TB [TE]	
2.4, 2.4 Bifuel, 2.4 T, 2.4 T AWD	11/00-04/10	B 5244 S, B 5244 S2, B 5244 SG, B 5244 T3	2435	:→3188688	0-N137	TB [TE]	
2.4, 2.4 Bifuel, 2.4 T, 2.4 T AWD	11/00-04/10	B 5244 S, B 5244 S2, B 5244 SG, B 5244 T3	2435		0-N958	TB [DG]	
2.5 AWD, 2.5 T, 2.5 T AWD, R 2,5 T AWD	03/03-04/10	B 5254 T2, B 5254 T4	2521	:3188689→	0-N1324	TB [TE]	
2.5 AWD, 2.5 T, 2.5 T AWD, R 2,5 T AWD	03/03-04/10	B 5254 T2, B 5254 T4	2521	:→3188688	0-N137	TB [TE]	
2.5 AWD, 2.5 T, 2.5 T AWD, R 2,5 T AWD	03/03-04/10	B 5254 T2, B 5254 T4	2521		0-N958	TB [DG]	
2.0 T	07/00-04/10	B 5204 T5	1984		0-N1529	VB [BT]	S
2.0 T	07/00-04/10	B 5204 T5	1984	Rippenanzahl: 6;	0-N1647	VB [DG]	
2.4 D	09/05-04/10	D 5244 T5, D 5244 T7	2400	:→349808	0-N1450	VB [DG]	
2.4 D	09/05-04/10	D 5244 T7	2400	:→349808	0-N1451	VB [DG]	
2.4 D	09/05-04/10	D 5244 T5, D 5244 T7	2400	:→349808	0-N1491S	VB [TE]	
2.4 D	09/05-04/10	D 5244 T5, D 5244 T7	2400	Rippenanzahl: 6;	0-N1647	VB [DG]	
2.4 D	09/05-04/10	D 5244 T5, D 5244 T7	2400	:349809→	0-N1979	VB [BT]	S
2.4 D, 2.4 D5	07/01-04/10	D 5244 T, D 5244 T2, D 5244 T4	2401	:→349808	0-N1450	VB [DG]	
2.4 D, 2.4 D5	07/01-04/10	D 5244 T, D 5244 T2, D 5244 T4	2401	:→349808	0-N1451	VB [DG]	
2.4 D, 2.4 D5	07/01-04/10	D 5244 T, D 5244 T2, D 5244 T4	2401	:→349808	0-N1491S	VB [TE]	
2.4 D, 2.4 D5, 2.4 T5	07/01-04/10	B 5244 T5, D 5244 T, D 5244 T2, D 5244 T4	2401	Rippenanzahl: 6;	0-N1647	VB [DG]	
2.4 D, 2.4 D5, 2.4 T5	07/01-04/10	B 5244 T5, D 5244 T, D 5244 T2, D 5244 T4	2401	:349809→	0-N1979	VB [BT]	S
2.4 T, 2.4 T AWD	11/00-04/10	B 5244 T3	2435	:349809→	0-N1979	VB [BT]	S
2.4 T5	04/04-04/10	B 5244 T5	2401		0-N1529	VB [BT]	S
2.4, 2.4 Bifuel, 2.4 T, 2.4 T AWD	11/00-04/10	B 5244 S, B 5244 S2, B 5244 SG, B 5244 T3	2435		0-N1529	VB [BT]	S
2.4, 2.4 Bifuel, 2.4 T, 2.4 T AWD	11/00-04/10	B 5244 S, B 5244 S2, B 5244 SG, B 5244 T3	2435	Rippenanzahl: 6;	0-N1647	VB [DG]	
2.5 T, 2.5 T AWD, R 2,5 T AWD	03/03-04/10	B 5254 T2, B 5254 T4	2521		0-N1529	VB [BT]	S
2.5 T, 2.5 T AWD, R 2,5 T AWD	03/03-04/10	B 5254 T2, B 5254 T4	2521	Rippenanzahl: 6;	0-N1647	VB [DG]	
T5	11/00-04/10	B 5234 T3	2319		0-N1529	VB [BT]	S
T5	11/00-04/10	B 5234 T3	2319	Rippenanzahl: 6;	0-N1647	VB [DG]	

S60 II

2.0 T	12/13-	B 5204 T8	1984	23x142	SK-1492AQ1	BTkW	
D3, D4	04/10-04/12	D 5204 T2, D 5204 T3, D 5204 T3	1984	28x132	SK-1608	BTK	
D5	04/10-	D 5244 T10	2400	28x132; → 05/2011	SK-1608	BTK	
D5 AWD	04/10-	D 5244 T10	2400	28x132	SK-1608	BTK	
D5, D5 AWD	06/11-	D 5244 T11, D 5244 T15, D 5244 T15, D 5244 T15	2400	28x132; :→1046801	SK-1608	BTK	
D5, D5 AWD	06/11-	D 5244 T11, D 5244 T15, D 5244 T15, D 5244 T15	2400	28x132	SK-1608AQ1	BTkW	
DRIVE / D2	01/11-	D 4162 T	1560	25x141	SK-1728	BTK	
DRIVE / D2	01/11-	D 4162 T	1560	25x141	SK-1728AQ1	BTkW	
D3	04/10-04/12	D 5204 T2, D 5204 T3	1984		0-N1349	TB [TE]	
D3	04/10-04/12	D 5204 T2, D 5204 T3	1984		0-N1350	TB [DG]	
D5, D5 AWD	04/10-	D 5244 T10, D 5244 T11, D 5244 T15, D 5244 T15, D 5244 T15	2400		0-N1349	TB [TE]	
D5, D5 AWD	04/10-	D 5244 T10, D 5244 T11, D 5244 T15, D 5244 T15, D 5244 T15	2400		0-N1350	TB [DG]	
DRIVE / D2	01/11-	D 4162 T	1560		0-N2224	TB [TE]	
DRIVE / D2	01/11-	D 4162 T	1560		0-N2382	TB [DG]	
T3, T4, T4F	04/10-	B 4164 T, B 4164 T2, B 4164 T3	1596		0-N2057	TB [TE]	
3.0 T AWD, T6 AWD	04/10-	B 6304 T3, B 6304 T4, B 6304 T4, B 6304 T5	2953		0-N2242	VB [BT]	S
3.0 T AWD, T6 AWD	04/10-	B 6304 T3, B 6304 T4, B 6304 T4, B 6304 T5	2953		0-N2243	VB [DG]	
D3	04/10-04/12	D5204T2	1984	:→884797	0-N1964	VB [BT]	S
D3	04/10-04/12	D5204T3	1984	:→1046801	0-N2204	VB [BT]	S
D3	04/10-04/12	D5204T2	1984	:884798→	0-N2204	VB [BT]	S



CM³



Art. Nr.



S60 II							
D3, D4	05/12-	D 5204 T3, D 5204 T7	1984	:1046802→	0-N1964	VB [BT]	S
D5	04/10-	D 5244 T10	2400		0-N2204	VB [BT]	S
D5 AWD	04/10-	D 5244 T10	2400	:884798→	0-N2204	VB [BT]	S
D5, D5 AWD	04/10-	D 5244 T10	2400	:→884797	0-N1964	VB [BT]	S
D5, D5 AWD	06/11-	D 5244 T11, D 5244 T15, D 5244 T15, D 5244 T15	2400	:1046802→	0-N1964	VB [BT]	S
D5, D5 AWD	06/11-	D 5244 T11, D 5244 T15, D 5244 T15, D 5244 T15	2400	:→1046801	0-N2204	VB [BT]	S
T3, T4, T4F	04/10-	B 4164 T, B 4164 T2, B 4164 T3	1596		0-N2269	VB [BT]	S
T3, T4, T4F	04/10-	B 4164 T, B 4164 T2, B 4164 T3	1596		0-N2363	VB [DG]	
S70 (LS)							
2.0	01/97-11/00	B 5204 T4	1984	23x148; 12/1998 →; :→1266127; mit Zubehör; Spannrollenbetätigung: hydraulisch	SK-1103	BTK	
2.0	01/97-11/00	B 5202 FS, B 5202 S	1984	23x144; :→1266127; Spannrollenbetätigung: hydraulisch	SK-1270	BTK	
2.0	01/97-11/00	B 5202 FS, B 5202 S	1984	23x144; :→1266127; Spannrollenbetätigung: hydraulisch	SK-1270AQ1	BTKW	
2.0	01/97-11/00	B 5204 T4	1984	23x142; 12/1998 →; :1266128→	SK-1491	BTK	
2.0	01/97-11/00	B 5202 FS, B 5202 S	1984	23x138; :1266128→	SK-1531	BTK	
2.0 Turbo	01/97-11/00	B 5204 T	1984	23x148; :→1266127; mit Zubehör	SK-1103	BTK	
2.0, 2.0 Turbo	01/97-11/00	B 5204 F, B 5204 T2, B 5204 T3	1984	23x148; :→1266127; mit Zubehör; Spannrollenbetätigung: hydraulisch	SK-1103	BTK	
2.0, 2.0 Turbo	01/97-11/00	B 5204 F, B 5204 T, B 5204 T2, B 5204 T3, B 5204 T4	1984	23x148; :→1266127; mit Zubehör; Spannrollenbetätigung: hydraulisch	SK-1103AQ1	BTKW	
2.0, 2.0 Turbo	01/97-11/00	B 5204 T2, B 5204 T3	1984	23x142; :1266128→	SK-1491	BTK	
2.0, 2.0 Turbo	01/97-11/00	B 5204 F, B 5204 T	1984	23x142; :1266128→; :→3192745	SK-1491	BTK	
2.0, 2.0 Turbo	01/97-11/00	B 5204 F, B 5204 T, B 5204 T2, B 5204 T3, B 5204 T4	1984	23x142; :1266128→; :→3192745; Spannrollenbetätigung: mechanisch	SK-1491AQ1	BTKW	
2.0, 2.0 Turbo	01/97-11/00	B 5204 F, B 5204 T, B 5204 T2, B 5204 T3, B 5204 T4	1984	23x142; :3192746→	SK-1492	BTK	
2.0, 2.0 Turbo	01/97-11/00	B 5204 F, B 5204 T, B 5204 T2, B 5204 T3, B 5204 T4	1984	23x142; :3192746→	SK-1492AQ1	BTKW	
2.3	11/96-11/00	B 5234 T3	2319	23x142; :1266128→; :→3192745; mit Feder; Spannrollenbetätigung: mechanisch	SK-1491	BTK	
2.3 T5 AWD	07/97-09/00	B 5234 T4	2319	23x148; mit Zubehör; Spannrollenbetätigung: automatisch	SK-1103	BTK	
2.3 T5 AWD	07/97-09/00	B 5234 T4	2319	23x142	SK-1491	BTK	
2.3 T5 R AWD	11/96-09/98	B 5234 T2	2319	23x148; :→1266127; mit Zubehör; Spannrollenbetätigung: automatisch	SK-1103	BTK	
2.3, 2.3 AWD, 2.3 T-5, 2.3 T5 AWD, 2.3 T5 R AWD, 2.3 Turbo	11/96-11/00	B 5234 FT+, B 5234 T2, B 5234 T3, B 5234 T7	2319	23x142; :1266128→	SK-1491	BTK	
2.3, 2.3 AWD, 2.3 T-5, 2.3 T5 AWD, 2.3 Turbo	11/96-11/00	B 5234 FT+, B 5234 T3, B 5234 T7	2319	23x148; :→1266127; mit Zubehör; Spannrollenbetätigung: hydraulisch	SK-1103	BTK	
2.3, 2.3 T-5, 2.3 T5 AWD, 2.3 Turbo	11/96-11/00	B 5234 FT+, B 5234 T3, B 5234 T7	2319	23x148; :→1266127; mit Zubehör; Spannrollenbetätigung: hydraulisch	SK-1103AQ1	BTKW	
2.3, 2.3 T-5, 2.3 T5 AWD, 2.3 Turbo	11/96-11/00	B 5234 FT+, B 5234 T3, B 5234 T7	2319	23x142; :1266128→; :→3192745; Spannrollenbetätigung: mechanisch	SK-1491AQ1	BTKW	
2.3, 2.3 T-5, 2.3 T5 AWD, 2.3 Turbo	11/96-11/00	B 5234 FT+, B 5234 T3, B 5234 T7	2319	23x142; :3192746→	SK-1492	BTK	
2.3, 2.3 T-5, 2.3 T5 AWD, 2.3 Turbo	11/96-11/00	B 5234 FT+, B 5234 T3, B 5234 T7	2319	23x142; :3192746→	SK-1492AQ1	BTKW	
2.4	01/97-11/00	B 5244 S, B 5254 S	2435	23x148; :→1266127; mit Zubehör	SK-1103	BTK	
2.4	01/97-11/00	B5254FS	2435	23x148; :→1266127; mit Zubehör	SK-1103AQ1	BTKW	
2.4	01/97-11/00	B 5244 S	2435	23x142	SK-1491	BTK	
2.4	01/97-11/00	B 5244 S, B 5254 S	2435	23x142; :1266128→; Spannrollenbetätigung: mechanisch	SK-1491	BTK	
2.4	01/97-11/00	B 5244 S	2435	23x142; :→3192745	SK-1491AQ1	BTKW	
2.4	01/97-11/00	B5254FS	2435	23x142; :1266128→; :→3192745	SK-1491AQ1	BTKW	
2.4	01/97-11/00	B 5244 S	2435	23x142; :3192746→	SK-1492	BTK	
2.4	01/97-11/00	B 5244 S	2435	23x142; :3192746→	SK-1492AQ1	BTKW	
2.4	01/97-11/00	B5254FS	2435	23x142; :3192746→	SK-1492AQ1	BTKW	
2.4	08/99-11/00	B 5244 S2	2435	23x142	SK-1491	BTK	
2.4 AWD, 2.5	11/96-11/00	B 5252 FS	2435	23x138; :1266128→	SK-1531	BTK	
2.4 AWD, 2.5 Bifuel	10/98-11/00	B 5244 S, B 5244 S2, B 5244 SG, B 5254 S, GB 5252 S	2435	23x142	SK-1491	BTK	
2.4 AWD, 2.5, 2.5 Bifuel	11/96-11/00	B 5252 FS, GB 5252 S	2435	23x144; :→1266127; Spannrollenbetätigung: hydraulisch	SK-1270	BTK	
2.4 AWD, 2.5, 2.5 Bifuel	11/96-11/00	B 5252 FS, GB 5252 S	2435	23x144; :→1266127; Spannrollenbetätigung: hydraulisch	SK-1270AQ1	BTKW	
2.4 Blu-Fuel	07/97-09/00	B 5244 SG	2435	23x142; 07/1999 →	SK-1491	BTK	
2.4 T5 AWD	11/96-04/99	B 5254 T	2435	23x148; :→1266127; mit Zubehör; Spannrollenbetätigung: hydraulisch	SK-1103	BTK	
2.4 T5 AWD	11/96-04/99	B 5254 T	2435	23x142; :1266128→	SK-1491	BTK	

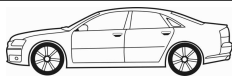

CM³



Art. Nr.



S70 (LS)

2.4 T5 AWD, 2.4 Turbo	11/96-11/00	B 5244 T, B 5254 T, B 5254 T	2435	23x148; :→1266127; mit Zubehör; Spannrollenbetätigung: hydraulisch	SK-1103AQ1	BTKW	
2.4 T5 AWD, 2.4 Turbo	11/96-11/00	B 5244 T, B 5254 T, B 5254 T	2435	23x142; :1266128→; :→3192745; Spannrollenbetätigung: mechanisch	SK-1491AQ1	BTKW	
2.4 Turbo	01/97-11/00	B 5254 T	2435	23x148; :→1266127; mit Zubehör; Spannrollenbetätigung: hydraulisch	SK-1103	BTK	
2.4 Turbo	01/97-11/00	B 5244 T	2435	23x142	SK-1491	BTK	
2.4 Turbo	01/97-11/00	B 5254 T	2435	23x142; :1266128→; Spannrollenbetätigung: mechanisch	SK-1491	BTK	
2.4, 2.4 AWD, 2.4 Blu-Fuel, 2.4 T5 AWD, 2.4 Turbo, 2.5, 2.5 Bifuel	11/96-11/00	B 5244 S, B 5244 S, B 5254 S, B 5244 S2, B 5244 S2, B 5244 SG, B 5244 SG, B 5244 T, B 5254 T, B 5254 S, B 5254 T	2435	23x142; :3192746→	SK-1492	BTK	
2.4, 2.4 AWD, 2.4 Blu-Fuel, 2.4 T5 AWD, 2.4 Turbo, 2.5, 2.5 Bifuel	11/96-11/00	B 5244 S, B 5244 S2, B 5244 S2, B 5244 SG, B 5244 SG, B 5244 T, B 5254 T, B 5254 S, B 5254 T	2435	23x142; :3192746→	SK-1492AQ1	BTKW	
2.4, 2.4 AWD, 2.4 Blu-Fuel, 2.5, 2.5 Bifuel	07/97-11/00	B 5244 S, B 5244 S2, B 5244 S2, B 5244 SG, B 5244 SG, B 5254 S	2435	23x142; :→3192745	SK-1491AQ1	BTKW	
2.5	06/98-11/00	B 5254 S	2435	23x142; 10/1998 →	SK-1491	BTK	
2.5 TDI	01/97-11/00	D 5252 T	2461	25.4x120	SK-1526AQ2	BTKW	
2.5 TDI	01/97-11/00	D 5252 T	2461	26.5x122; 21x81; mit Zubehör	SK-1529	BTK	
2.5 TDI	01/97-11/00	D 5252 T	2461	26.5x122; mit Zubehör	SK-1725	BTK	
2.5 TDi AWD	10/99-09/00	D 5252 T	2460	25.4x120	SK-1526AQ2	BTKW	
2.5 TDi AWD	10/99-09/00	D 5252 T	2460	26.5x122; 21x81; mit Zubehör	SK-1529	BTK	
2.5 TDi AWD	10/99-09/00	D 5252 T	2460	26.5x122; mit Zubehör	SK-1725	BTK	
2.0, 2.0 Turbo	01/97-11/00	B 5202 FS, B 5202 S, B 5204 F, B 5204 T, B 5204 T2, B 5204 T3, B 5204 T4	1984	:1266128→	0-N137	TB [TE]	
2.0, 2.0 Turbo	01/97-11/00	B 5202 FS, B 5202 S, B 5204 F, B 5204 T, B 5204 T2, B 5204 T3, B 5204 T4	1984	:→1266127	0-N930	TB [TE]	
2.0, 2.0 Turbo	01/97-11/00	B 5202 FS, B 5202 S, B 5204 F, B 5204 T, B 5204 T2, B 5204 T3, B 5204 T4	1984		0-N958	TB [DG]	
2.3 T5 R AWD	11/96-09/98	B 5234 T2	2319		0-N930	TB [TE]	
2.3 T-5, 2.3 T5 AWD, 2.3 Turbo	01/97-11/00	B 5234 FT+, B 5234 T3, B 5234 T4	2319	:1266128→	0-N137	TB [TE]	
2.3, 2.3 AWD	04/99-09/00	B 5234 T7	2319	:3192746→	0-N1324	TB [TE]	
2.3, 2.3 AWD	04/99-09/00	B 5234 T7	2319	:1266128→; :→3192745	0-N137	TB [TE]	
2.3, 2.3 AWD, 2.3 T-5, 2.3 T5 AWD, 2.3 T5 R AWD, 2.3 Turbo	11/96-11/00	B 5234 FT+, B 5234 T2, B 5234 T3, B 5234 T4, B 5234 T7	2319		0-N958	TB [DG]	
2.3, 2.3 AWD, 2.3 T-5, 2.3 T5 AWD, 2.3 Turbo	11/96-11/00	B 5234 FT+, B 5234 T3, B 5234 T4, B 5234 T7	2319	:→1266127	0-N930	TB [TE]	
2.4 AWD	11/96-05/99	B 5252 FS	2435	ch.→1266127	0-N930	TB [TE]	
2.4, 2.4 AWD, 2.4 Blu-Fuel, 2.4 T5 AWD, 2.4 Turbo, 2.5, 2.5 Bifuel	11/96-11/00	B 5244 S, B 5244 S, B 5254 S, B 5244 S2, B 5244 S2, B 5244 SG, B 5244 SG, B 5244 T, B 5254 T, B 5252 FS, B 5254 S, B 5254 T, GB 5252 S	2435		0-N958	TB [DG]	
2.4, 2.4 AWD, 2.4 Blu-Fuel, 2.5 Bifuel	07/97-11/00	B 5244 S, B 5244 S2, B 5244 S2, B 5244 SG, B 5244 SG	2435	:3192746→	0-N1324	TB [TE]	
2.4, 2.4 AWD, 2.4 Blu-Fuel, 2.5 Bifuel	07/97-11/00	B 5244 S, B 5244 S2, B 5244 S2, B 5244 SG, B 5244 SG	2435	:→3192745	0-N137	TB [TE]	
2.4, 2.4 AWD, 2.4 T5 AWD, 2.4 Turbo, 2.5, 2.5 Bifuel	11/96-11/00	B 5244 S, B 5254 S, B 5244 T, B 5254 T, B 5252 FS, B 5254 S, B 5254 T, GB 5252 S	2435	:1266128→	0-N137	TB [TE]	
2.4, 2.4 AWD, 2.4 T5 AWD, 2.4 Turbo, 2.5, 2.5 Bifuel	11/96-11/00	B 5244 S, B 5254 S, B 5244 T, B 5254 T, B 5252 FS, B 5254 S, B 5254 T, GB 5252 S	2435	:→1266127	0-N930	TB [TE]	
2.5 TDI	01/97-11/00	D 5252 T	2461		0-N110	TB [TE]	
2.5 TDI	01/97-11/00	D 5252 T	2461		0-N116	TB [TE]	
2.5 TDI	01/97-11/00	D 5252 T	2461		0-N117	TB [TE]	
2.5 TDi AWD	10/99-09/00	D 5252 T	2460		0-N110	TB [TE]	
2.5 TDi AWD	10/99-09/00	D 5252 T	2460		0-N116	TB [TE]	
2.5 TDi AWD	10/99-09/00	D 5252 T	2460		0-N117	TB [TE]	
2.0, 2.0 Turbo	01/97-11/00	B 5202 FS, B 5202 S, B 5204 T, B 5204 T2, B 5204 T3	1984	→ 12/1998	0-N1448	VB [DG]	
2.0, 2.0 Turbo	01/97-11/00	B 5202 FS, B 5202 S, B 5204 F, B 5204 T, B 5204 T2, B 5204 T3, B 5204 T4	1984	→ 12/1998	0-N1518	VB [BT]	S
2.0, 2.0 Turbo	01/97-11/00	B 5202 FS, B 5202 S, B 5204 F, B 5204 T, B 5204 T2, B 5204 T3, B 5204 T4	1984	01/1999 →	0-N1529	VB [BT]	S
2.0, 2.0 Turbo	01/97-11/00	B 5202 FS, B 5202 S, B 5204 F, B 5204 T, B 5204 T2, B 5204 T3, B 5204 T4	1984	01/1999 →; Rippenanzahl: 6;	0-N1647	VB [DG]	
2.0, 2.0 Turbo	01/97-11/00	B 5202 FS, B 5202 S, B 5204 F, B 5204 T, B 5204 T2, B 5204 T3, B 5204 T4	1984	:→1266127	0-N2223	VB [VD]	
2.3	04/99-09/00	B 5234 T7	2319		0-N1529	VB [BT]	S
2.3	04/99-09/00	B 5234 T7	2319	Rippenanzahl: 6;	0-N1647	VB [DG]	
2.3 T5 AWD, 2.3 T5 R AWD	11/96-09/98	B 5234 T2, B 5234 T3	2319		0-N2223	VB [VD]	
2.3 T-5, 2.3 Turbo	01/97-11/00	B 5234 FT+, B 5234 T3	2319	→ 12/1998	0-N1448	VB [DG]	
2.3 T-5, 2.3 Turbo	01/97-11/00	B 5234 FT+, B 5234 T3	2319	→ 12/1998	0-N1518	VB [BT]	S

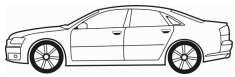

CM³



Art. Nr.



S70 (LS)							
2.3 T-5, 2.3 Turbo	01/97-11/00	B 5234 FT+, B 5234 T3	2319	01/1999 →		0-N1529	VB [BT] S
2.3 T-5, 2.3 Turbo	01/97-11/00	B 5234 FT+, B 5234 T3	2319	01/1999 →; Rippenanzahl: 6;		0-N1647	VB [DG]
2.3, 2.3 AWD, 2.3 T-5, 2.3 T5 AWD, 2.3 Turbo	01/97-11/00	B 5234 FT+, B 5234 T3, B 5234 T4, B 5234 T7	2319	: →1266127		0-N2223	VB [VD]
2.4 AWD	11/96-05/99	B 5252 FS	2435			0-N1308	VB [TE]
2.4 AWD	11/96-05/99	B 5252 FS	2435			0-N143	VB [DG]
2.4 AWD	11/96-05/99	B 5252 FS	2435			0-N1518	VB [BT] S
2.4 AWD, 2.5	06/98-11/00	B 5254 S	2435	→ 12/1998		0-N143	VB [DG]
2.4 AWD, 2.5 Bifuel	04/99-11/00	B 5244 S, B 5244 SG	2435	Rippenanzahl: 6;		0-N1647	VB [DG]
2.4, 2.4 AWD, 2.4 Blu-Fuel	07/97-11/00	B 5244 S, B 5244 S2, B 5244 S2, B 5244 SG	2435			0-N1450	VB [DG]
2.4, 2.4 AWD, 2.4 Blu-Fuel, 2.5 Bifuel	07/97-11/00	B 5244 S, B 5244 S2, B 5244 S2, B 5244 SG, B 5244 SG	2435			0-N1529	VB [BT] S
2.4, 2.4 AWD, 2.4 T5 AWD, 2.4 Turbo, 2.5, 2.5 Bifuel	11/96-11/00	B 5244 S, B 5254 S, B 5244 T, B 5254 T, B 5252 FS, B 5254 S, B 5254 T, GB 5252 S	2435	→ 12/1998		0-N1518	VB [BT] S
2.4, 2.4 AWD, 2.4 T5 AWD, 2.4 Turbo, 2.5, 2.5 Bifuel	11/96-11/00	B 5244 S, B 5254 S, B 5244 T, B 5254 T, B 5252 FS, B 5254 S, B 5254 T, GB 5252 S	2435	01/1999 →		0-N1529	VB [BT] S
2.4, 2.4 AWD, 2.4 T5 AWD, 2.4 Turbo, 2.5, 2.5 Bifuel	11/96-11/00	B 5244 S, B 5254 S, B 5244 T, B 5254 T, B 5252 FS, B 5254 S, B 5254 T, GB 5252 S	2435	01/1999 →; Rippenanzahl: 6;		0-N1647	VB [DG]
2.4, 2.4 AWD, 2.4 T5 AWD, 2.4 Turbo, 2.5, 2.5 Bifuel	11/96-11/00	B 5244 S, B 5254 S, B 5244 T, B 5254 T, B 5252 FS, B 5254 S, B 5254 T, GB 5252 S	2435	: →1266127		0-N2223	VB [VD]
2.4, 2.4 Turbo, 2.5	01/97-11/00	B 5244 S, B 5254 S, B 5244 T, B 5254 T, B 5252 FS, B 5254 S	2435	→ 12/1998		0-N1448	VB [DG]
2.5 TDI	01/97-11/00	D 5252 T	2461			0-N1424	VB [DG]
2.5 TDI	01/97-11/00	D 5252 T	2461			0-N1953	VB [BT] S
2.5 TDi AWD	10/99-09/00	D 5252 T	2460			0-N1424	VB [DG]
2.5 TDi AWD	10/99-09/00	D 5252 T	2460			0-N1953	VB [BT] S

S80 I (TS, XY)							
2.0 T	12/99-07/06	B 5204 T5	1984	23x142; : →3188688		SK-1491	BTK
2.0, 2.0 T	06/98-07/06	B 5204 T3, B 5204 T4	1984	23x142; 11/1998 →; : →3188688		SK-1491	BTK
2.0, 2.0 T	06/98-07/06	B 5204 T3, B 5204 T4, B 5204 T5	1984	23x142; : →3188688		SK-1491AQ1	BTKW
2.0, 2.0 T	06/98-07/06	B 5204 T3, B 5204 T4, B 5204 T5	1984	23x142; : 3188689 →		SK-1492	BTK
2.0, 2.0 T	06/98-07/06	B 5204 T3, B 5204 T4, B 5204 T5	1984	23x142; : 3188689 →		SK-1492AQ1	BTKW
2.3 R	04/00-08/05	B 5234 T7	2319	23x142; : →3188688		SK-1491	BTK
2.4 D, 2.4 D5	08/01-07/06	D 5244 T, D 5244 T2	2401	28x132		SK-1608	BTK
2.4 D, 2.4 D5	08/01-07/06	D 5244 T, D 5244 T2	2401	28x132		SK-1608AQ1	BTKW
2.4 T5 AWD	04/00-09/03	B 5244 T3	2435	23x142; 08/2000 →; : →3188688		SK-1491	BTK
2.4, 2.4 Bifuel, 2.4 Bifuel (LPG), 2.4 T	01/99-07/06	B 5244 S, B 5244 S2, B 5244 SG, B 5244 SG2, B 5244 T3	2435	23x142; : →3188688		SK-1491	BTK
2.4, 2.4 Bifuel, 2.4 Bifuel (LPG), 2.4 T, 2.4 T5 AWD	01/99-07/06	B 5244 S, B 5244 S2, B 5244 SG, B 5244 SG2, B 5244 T3	2435	23x142; : →3188688		SK-1491AQ1	BTKW
2.4, 2.4 Bifuel, 2.4 Bifuel (LPG), 2.4 T, 2.4 T5 AWD	01/99-07/06	B 5244 S, B 5244 S2, B 5244 SG, B 5244 SG2, B 5244 T3	2435	23x142; : 3188689 →		SK-1492	BTK
2.4, 2.4 Bifuel, 2.4 Bifuel (LPG), 2.4 T, 2.4 T5 AWD	01/99-07/06	B 5244 S, B 5244 S2, B 5244 SG, B 5244 SG2, B 5244 T3	2435	23x142; : 3188689 →		SK-1492AQ1	BTKW
2.5 T, 2.5 T AWD	03/03-07/06	B 5254 T2	2521	23x142; : →3188688		SK-1491	BTK
2.5 T, 2.5 T AWD	03/03-07/06	B 5254 T2	2521	23x142; : →3188688		SK-1491AQ1	BTKW
2.5 T, 2.5 T AWD	03/03-07/06	B 5254 T2	2521	23x142; : 3188689 →		SK-1492	BTK
2.5 T, 2.5 T AWD	03/03-07/06	B 5254 T2	2521	23x142; : 3188689 →		SK-1492AQ1	BTKW
2.5 TDI	01/99-07/06	D 5252 T	2461	25.4x120		SK-1526AQ2	BTKW
2.5 TDI	01/99-07/06	D 5252 T	2461	26.5x122; 21x81; mit Zubehör		SK-1529	BTK
2.5 TDI	01/99-07/06	D 5252 T	2461	26.5x122; mit Zubehör		SK-1725	BTK
2.8 T6	05/98-07/06	B 6284 T	2783	28x146		SK-1618	BTK
2.8 T6	05/98-07/06	B 6284 T	2783	28x152; → 10/2003		SK-1643	BTK
2.9	05/98-07/06	B 6304 S3	2922	28x146		SK-1618	BTK
2.9	03/99-07/06	B 6294 S	2922	28x146; 10/1999 →		SK-1618	BTK
2.9, 3.0	05/98-07/06	B 6294 S, B 6294 S2, B 6304 S3	2922	28x152; → 06/2004		SK-1643	BTK
3.0, 3.0 T6	06/01-07/06	B 6294 S2, B 6294 T	2922	28x146; 10/2001 →		SK-1618	BTK
3.0, 3.0 T6	06/01-07/06	B 6294 S2, B 6294 T	2922	28x146; Baumuster: -&t; 2003		SK-1747	BTK
2.0, 2.0 T	06/98-07/06	B 5204 T3, B 5204 T4, B 5204 T5	1984	: 3188689 →		0-N1324	TB [TE]
2.0, 2.0 T	06/98-07/06	B 5204 T3, B 5204 T4, B 5204 T5	1984	: →3188688		0-N137	TB [TE]
2.0, 2.0 T	06/98-07/06	B 5204 T3, B 5204 T4, B 5204 T5	1984			0-N958	TB [DG]
2.3 R	04/00-08/05	B 5234 T7	2319	: 3188689 →		0-N1324	TB [TE]
2.3 R	04/00-08/05	B 5234 T7	2319	: →3188688		0-N137	TB [TE]
2.3 R	04/00-08/05	B 5234 T7	2319			0-N958	TB [DG]
2.4 D, 2.4 D5	08/01-07/06	D 5244 T, D 5244 T2	2401			0-N1349	TB [TE]
2.4 D, 2.4 D5	08/01-07/06	D 5244 T, D 5244 T2	2401			0-N1350	TB [DG]



CM³



Art. Nr.



S80 I (TS, XY)

2.4, 2.4 Bifuel, 2.4 LTP, 2.4 T, 2.4 T5 AWD	01/99-07/06	B 5244 S, B 5244 S2, B 5244 SG2, B 5244 T3, B 5244 T4	2435	:3188689→	0-N1324	TB [TE]	
2.4, 2.4 Bifuel, 2.4 LTP, 2.4 T, 2.4 T5 AWD	01/99-07/06	B 5244 S, B 5244 S2, B 5244 SG2, B 5244 T3, B 5244 T4	2435	:→3188688	0-N137	TB [TE]	
2.4, 2.4 Bifuel, 2.4 LTP, 2.4 T, 2.4 T5 AWD	01/99-07/06	B 5244 S, B 5244 S2, B 5244 SG2, B 5244 T3, B 5244 T4	2435		0-N958	TB [DG]	
2.5 T, 2.5 T AWD	03/03-07/06	B 5254 T2	2521	:3188689→	0-N1324	TB [TE]	
2.5 T, 2.5 T AWD	03/03-07/06	B 5254 T2	2521	:→3188688	0-N137	TB [TE]	
2.5 T, 2.5 T AWD	03/03-07/06	B 5254 T2	2521		0-N958	TB [DG]	
2.5 TDI	01/99-07/06	D 5252 T	2461		0-N110	TB [TE]	
2.5 TDI	01/99-07/06	D 5252 T	2461		0-N116	TB [TE]	
2.5 TDI	01/99-07/06	D 5252 T	2461		0-N117	TB [TE]	
2.8 T6	05/98-07/06	B 6284 T	2783		0-N1350	TB [DG]	
2.8 T6	05/98-07/06	B 6284 T	2783	01/2000 → 12/2002	0-N1362	TB [TE]	
2.8 T6	05/98-07/06	B 6284 T	2783	→ 01/2000	0-N1382	TB [TE]	
2.8 T6	05/98-07/06	B 6284 T	2783	01/2003 →	0-N1884	TB [BT]	
2.9	05/98-07/06	B 6294 S, B 6304 S3	2922	01/2000 → 12/2002	0-N1362	TB [TE]	
2.9	05/98-07/06	B 6294 S, B 6304 S3	2922	→ 01/2000	0-N1382	TB [TE]	
2.9, 3.0, 3.0 T6	05/98-07/06	B 6294 S, B 6294 S2, B 6294 T, B 6304 S3	2922		0-N1350	TB [DG]	
2.9, 3.0, 3.0 T6	05/98-07/06	B 6294 S, B 6294 S2, B 6294 T, B 6304 S3	2922	01/2003 →	0-N1884	TB [BT]	
3.0, 3.0 T6	06/01-07/06	B 6294 S2, B 6294 T	2922	→ 12/2002	0-N1362	TB [TE]	
2.0, 2.0 T	06/98-07/06	B 5204 T3, B 5204 T4, B 5204 T5	1984		0-N1529	VB [BT]	S
2.0, 2.0 T	06/98-07/06	B 5204 T3, B 5204 T4, B 5204 T5	1984	Rippenanzahl: 6;	0-N1647	VB [DG]	
2.4 D, 2.4 D5	08/01-07/06	D 5244 T, D 5244 T2	2401	:→349808	0-N1450	VB [DG]	
2.4 D, 2.4 D5	08/01-07/06	D 5244 T, D 5244 T2	2401	:→349808	0-N1451	VB [DG]	
2.4 D, 2.4 D5	08/01-07/06	D 5244 T, D 5244 T2	2401	:→349808	0-N1491S	VB [TE]	
2.4 D, 2.4 D5	08/01-07/06	D 5244 T, D 5244 T2	2401	Rippenanzahl: 6;	0-N1647	VB [DG]	
2.4 D, 2.4 D5	08/01-07/06	D 5244 T, D 5244 T2	2401	:349809→	0-N1979	VB [BT]	S
2.4, 2.4 Bifuel, 2.4 T, 2.4 T5 AWD	01/99-07/06	B 5244 S, B 5244 S2, B 5244 SG2, B 5244 T3	2435		0-N1529	VB [BT]	S
2.4, 2.4 Bifuel, 2.4 T, 2.4 T5 AWD	01/99-07/06	B 5244 S, B 5244 S2, B 5244 SG2, B 5244 T3	2435	Rippenanzahl: 6;	0-N1647	VB [DG]	
2.5 T, 2.5 T AWD	03/03-07/06	B 5254 T2	2521		0-N1529	VB [BT]	S
2.5 T, 2.5 T AWD	03/03-07/06	B 5254 T2	2521	Rippenanzahl: 6;	0-N1647	VB [DG]	
2.5 TDI	01/99-07/06	D 5252 T	2461	116810	0-N1424	VB [DG]	
2.5 TDI	01/99-07/06	D 5252 T	2461		0-N1953	VB [BT]	S
2.8 T6	05/98-07/06	B 6284 T	2783		0-N1529	VB [BT]	S
2.8 T6	05/98-07/06	B 6284 T	2783	Rippenanzahl: 6;	0-N1647	VB [DG]	
2.9, 3.0, 3.0 T6	05/98-07/06	B 6294 S, B 6294 S2, B 6294 T, B 6304 S3	2922		0-N1529	VB [BT]	S
2.9, 3.0, 3.0 T6	05/98-07/06	B 6294 S, B 6294 S2, B 6294 T, B 6304 S3	2922	Rippenanzahl: 6;	0-N1647	VB [DG]	

S80 II (AS)

1.6 D DRIVe	01/10-	D 4164 T	1560	25x137	SK-1424	BTK	
1.6 D DRIVe	01/10-	D 4164 T	1560	25x137	SK-1424AQ1	BTKW	
1.6 DRIVe	06/11-	D 4162 T	1560	25x141	SK-1728	BTK	
1.6 DRIVe	06/11-	D 4162 T	1560	25x141	SK-1728AQ1	BTKW	
2.0 TDi	02/08-	D 4204 T	1997	25.4x116	SK-1594	BTK	
2.0 TDi	02/08-	D 4204 T	1997	25.4x116	SK-1594AQ1	BTKW	
2.4 D, D5	03/06-	D 5244 T, D 5244 T5, D 5244 T4	2400	28x132; 08/2006 →	SK-1608	BTK	
2.4 D, D5, D5 AWD	03/06-	D 5244 T, D 5244 T5, D 5244 T11, D 5244 T15, D 5244 T15, D 5244 T15, D 5244 T4	2400	28x132	SK-1608AQ1	BTKW	
2.4 D, D5, D5 AWD	01/10-	D 5244 T10, D 5244 T14	2400	28x132	SK-1608	BTK	
2.5 T	03/06-	B 5254 T6	2521	23x142; 08/2006 →	SK-1666	BTK	
2.5 T	01/12-	B 5254 T12, B 5254 T14	2497	23x142	SK-1492AQ1	BTKW	
2.5 T, 2.5 T FlexFuel	03/06-	B 5254 T10, B 5254 T11, B 5254 T6, B 5254 T8	2521	23x142	SK-1666AQ1	BTKW	
2.5 T, 2.5 T FlexFuel	05/08-	B 5254 T10, B 5254 T11, B 5254 T8	2521	23x142	SK-1666	BTK	
D3	01/10-	D 5204 T2, D 5204 T3	1984	28x132; 09/2010 → 12/2011	SK-1608	BTK	
D5 AWD	01/07-	D 5244 T4	2400	28x132; 03/2008 →	SK-1608	BTK	
D5, D5 AWD	06/11-	D 5244 T11, D 5244 T15, D 5244 T15, D 5244 T15	2400	28x132; :→1046801	SK-1608	BTK	
1.6 D DRIVe	01/10-	D 4164 T	1560		0-N1062	TB [TE]	
1.6 D DRIVe	01/10-	D 4164 T	1560		0-N1066	TB [DG]	
1.6 DRIVe	06/11-	D 4162 T	1560		0-N2224	TB [TE]	
1.6 DRIVe	06/11-	D 4162 T	1560		0-N2382	TB [DG]	
2.0 TDi	02/08-	D 4204 T	1997		0-N1334	TB [DG]	



CM³



Art. Nr.



S80 II (AS)

2.4 D, D5, D5 AWD	03/06-	D 5244 T, D 5244 T5, D 5244 T10, D 5244 T11, D 5244 T15, D 5244 T14, D 5244 T15, D 5244 T15, D 5244 T4	2400		0-N1349	TB [TE]	
2.4 D, D5, D5 AWD	03/06-	D 5244 T, D 5244 T5, D 5244 T10, D 5244 T11, D 5244 T15, D 5244 T14, D 5244 T15, D 5244 T15, D 5244 T4	2400		0-N1350	TB [DG]	
2.5 T, 2.5 T AWD, 2.5 T FlexFuel	03/06-	B 5254 T10, B 5254 T11, B 5254 T6, B 5254 T8	2521		0-N958	TB [DG]	
D3	01/10-	D 5204 T2, D 5204 T3	1984		0-N1349	TB [TE]	
D3	01/10-	D 5204 T2, D 5204 T3	1984		0-N1350	TB [DG]	
T4, T4F	10/10-	B 4164 T, B 4164 T2	1596		0-N2057	TB [TE]	
1.6 D DRIVe	01/10-	D 4164 T	1560	ch.→125483	0-N1339	VB [BT]	S
2.0 TDi	02/08-	D 4204 T	1997		0-N1327	VB [BT]	
2.0 TDi	02/08-	D 4204 T	1997		0-N1991	VB [DG]	
2.0 TDi	02/08-	D 4204 T	1997		0-N2042	VB [BT]	S
2.0, 2.0 FlexFuel	01/08-	B 4204 S3, B 4204 S4	1999	Rippenanzahl: 6	0-N1497	VB [BT]	S
2.0, 2.0 FlexFuel	01/08-	B 4204 S3, B 4204 S4	1999		0-N1991	VB [DG]	
2.4 D, D5, D5 AWD	03/06-	D 5244 T, D 5244 T5, D 5244 T10, D 5244 T11, D 5244 T15, D 5244 T14, D 5244 T15, D 5244 T15, D 5244 T4	2400	:→884797	0-N1964	VB [BT]	S
2.4 D, D5, D5 AWD	03/06-	D 5244 T, D 5244 T5, D 5244 T10, D 5244 T11, D 5244 T15, D 5244 T14, D 5244 T15, D 5244 T15, D 5244 T4	2400	:884798→	0-N2204	VB [BT]	S
2.5 T, 2.5 T AWD, 2.5 T FlexFuel	03/06-	B 5254 T10, B 5254 T11, B 5254 T6, B 5254 T8	2521		0-N1964	VB [BT]	S
3.2, 3.2 AWD	03/06-	B 6324 S, B 6324 S5	3192		0-N2242	VB [BT]	S
3.2, 3.2 AWD	03/06-	B 6324 S, B 6324 S5	3192		0-N2243	VB [DG]	
D3	01/10-	D5204T2	1984	:→884797	0-N1964	VB [BT]	S
D3	01/10-	D 5204 T3	1984	:1046802→	0-N1964	VB [BT]	S
D3	01/10-	D5204T3	1984	:→1046801	0-N2204	VB [BT]	S
D3	01/10-	D5204T2	1984	:884798→	0-N2204	VB [BT]	S
D3	05/12-	D 5204 T7	1984	:1046802→	0-N1964	VB [BT]	S
T4, T4F	10/10-	B 4164 T, B 4164 T2	1596		0-N2269	VB [BT]	S
T4, T4F	10/10-	B 4164 T, B 4164 T2	1596		0-N2363	VB [DG]	
T6 AWD	01/07-	B 6304 T2, B 6304 T4	2953		0-N2242	VB [BT]	S
T6 AWD	01/07-	B 6304 T2, B 6304 T4	2953		0-N2243	VB [DG]	

S90

2.5	11/96-10/98	B 6244 FS, B 6254 FS	2473	28x152; mit Zubehör	SK-1265	BTK	
2.9	01/97-05/98	B 6304 G, B 6304 S2	2922	28x152; mit Zubehör	SK-1265	BTK	
2.9	01/97-05/98	B 6304 G, B 6304 S2	2922		0-N172	TB [DG]	
2.9	01/97-05/98	B 6304 G, B 6304 S2	2922		0-N959	TB [TE]	
2.9	01/97-05/98	B 6304 G, B 6304 S2	2922		0-N1308	VB [TE]	
2.9	01/97-05/98	B 6304 G, B 6304 S2	2922		0-N1406	VB [DG]	

V40 Kombi (VW)

1.6	12/95-08/99	B 4164 S	1588	23x148; 03/1997 →; :→1266195; mit Zubehör; Spannrollenbetätigung: hydraulisch	SK-1103	BTK	
1.6	12/95-08/99	B 4164 S	1588	23x148; :→1266195; mit Zubehör; Spannrollenbetätigung: hydraulisch	SK-1103AQ1	BTKW	
1.6	12/95-08/99	B 4164 S	1588	23x142; 03/1997 →; :1266196→	SK-1491	BTK	
1.6	12/95-08/99	B 4164 S	1588	23x142; :1266196→; Spannrollenbetätigung: mechanisch	SK-1491AQ1	BTKW	
1.6	03/99-06/04	B 4164 S2	1587	23x142; 10/1999 →	SK-1491	BTK	
1.6	03/99-06/04	B 4164 S2	1587	23x142	SK-1491AQ1	BTKW	
1.8	07/95-08/99	B 4184 S	1731	23x148; 03/1996 →; :→1266195; mit Zubehör; Spannrollenbetätigung: hydraulisch	SK-1103	BTK	
1.8	07/95-08/99	B 4184 S	1731	23x148; :→1266195; mit Zubehör; Spannrollenbetätigung: hydraulisch	SK-1103AQ1	BTKW	
1.8	07/95-08/99	B 4184 S3	1731	23x142; 03/1996 →	SK-1491	BTK	
1.8	07/95-08/99	B 4184 S	1731	23x142; 03/1996 →; :1266196→; Spannrollenbetätigung: mechanisch	SK-1491	BTK	
1.8	07/95-08/99	B 4184 S3	1731	23x142	SK-1491AQ1	BTKW	
1.8	07/95-08/99	B 4184 S	1731	23x142; :1266196→; Spannrollenbetätigung: mechanisch	SK-1491AQ1	BTKW	
1.8	03/99-06/04	B 4184 S2	1783	23x142; 10/1999 →	SK-1491	BTK	
1.8	03/99-06/04	B 4184 S2, B 4184 S9	1783	23x142	SK-1491AQ1	BTKW	
1.8 i	03/98-06/04	B 4184 SJ, B 4184 SM	1834	29x154	SK-1325	BTK	
1.8 i	03/98-06/04	B 4184 SJ, B 4184 SM	1834	29x154	SK-1325AQ2	BTKW	
1.9 DI	03/99-07/00	D 4192 T2	1870	26x153; beinhalten Rollen: 3; mit Zahnrad	SK-1084	BTK	
1.9 DI	03/99-07/00	D 4192 T2	1870	26x153; beinhalten Rollen: 2	SK-1114	BTK	



CM³



Art. Nr.



V40 Kombi (VW)								
1.9 DI	07/00-06/04	D 4192 T3, D 4192 T4	1870	26x132	SK-1493	BTK		
1.9 DI	07/00-06/04	D 4192 T3, D 4192 T4	1870	26x132	SK-1493AQ1	BTKW		
1.9 DI	07/00-06/04	D 4192 T3, D 4192 T4	1870	26x132	SK-1493AQ2	BTKW		
1.9 T4	05/97-07/00	B 4194 T	1855	23x148; 10/1997 →; : →1219753; mit Zubehör; Spannrollenbetätigung: hydraulisch	SK-1103	BTK		
1.9 T4	05/97-07/00	B 4194 T	1855	23x148; : →1219753; mit Zubehör; Spannrollenbetätigung: hydraulisch	SK-1103AQ1	BTKW		
1.9 T4	05/97-07/00	B 4194 T2	1855	23x142	SK-1491	BTK		
1.9 T4	05/97-07/00	B 4194 T	1855	23x142; : 1219754 →; mit Feder; Spannrollenbetätigung: mechanisch	SK-1491	BTK		
1.9 T4	05/97-07/00	B 4194 T2	1855	23x142	SK-1491AQ1	BTKW		
1.9 T4	05/97-07/00	B 4194 T	1855	23x142; : 1219754 →; Spannrollenbetätigung: mechanisch	SK-1491AQ1	BTKW		
1.9 TD	07/95-08/99	D 4192 T	1870	25.4x153; 01/1996 →; →3534	SK-1705	BTK		
1.9 TD	07/95-08/99	D 4192 T	1870	25.4x153; 01/1996 →; : 3535 →; : →20559; mit Zahnrad	SK-1707	BTK		
2.0	07/95-08/99	B 4204 S	1948	23x148; 11/1996 →; : →1266195; mit Zubehör; Spannrollenbetätigung: hydraulisch	SK-1103	BTK		
2.0	07/95-06/04	B4204S	1948	23x148; : →1266195; mit Zubehör; Spannrollenbetätigung: hydraulisch	SK-1103AQ1	BTKW		
2.0	07/95-08/99	B 4204 S	1948	23x148; : →1266195; mit Zubehör; Spannrollenbetätigung: hydraulisch	SK-1103AQ1	BTKW		
2.0	07/95-06/04	B 4204 S, B 4204 S2	1948	23x142; 12/1999 →; : 1219111 →	SK-1491	BTK		
2.0	07/95-08/99	B 4204 S	1948	23x142; 11/1996 →; : 1266196 →	SK-1491	BTK		
2.0	07/95-06/04	B 4204 S2	1948	23x142	SK-1491AQ1	BTKW		
2.0	07/95-06/04	B4204S	1948	23x142; : 1266196 →; Spannrollenbetätigung: mechanisch	SK-1491AQ1	BTKW		
2.0	07/95-08/99	B 4204 S	1948	23x142; : 1266196 →	SK-1491AQ1	BTKW		
2.0 T	10/97-07/00	B 4204 T	1948	23x148; 06/1998 →; : →1219753; mit Zubehör; Spannrollenbetätigung: hydraulisch	SK-1103	BTK		
2.0 T	10/97-07/00	B 4204 T	1948	23x148; : →1219753; mit Zubehör; Spannrollenbetätigung: hydraulisch	SK-1103AQ1	BTKW		
2.0 T	10/97-07/00	B 4204 T	1948	23x142; 06/1998 →; : 1219754 →	SK-1491	BTK		
2.0 T	10/97-07/00	B 4204 T	1948	23x142; : 1219754 →; Spannrollenbetätigung: mechanisch	SK-1491AQ1	BTKW		
2.0 T	06/01-06/04	B 4204 T3	1948	23x142	SK-1491	BTK		
2.0 T, 2.0 T4	07/99-06/04	B 4204 T2, B 4204 T5	1948	23x142; : 1219111 →	SK-1491	BTK		
2.0 T, 2.0 T4	07/99-06/04	B 4204 T2, B 4204 T5	1948	23x142	SK-1491AQ1	BTKW		
2.0, 2.0 T	07/95-06/04	B 4204 S, B 4204 S2, B 4204 T2	1948	23x148; : →1219110; mit Zubehör	SK-1103	BTK		
1.6	12/95-08/99	B 4164 S	1588	: 1266196 →	0-N137	TB [TE]		
1.6	12/95-08/99	B 4164 S	1588	: →1266195	0-N930	TB [TE]		
1.6	12/95-08/99	B 4164 S	1588		0-N958	TB [DG]		
1.6	03/99-06/04	B 4164 S2	1587		0-N137	TB [TE]		
1.6	03/99-06/04	B 4164 S2	1587		0-N958	TB [DG]		
1.8	07/95-08/99	B 4184 S, B 4184 S3	1731	: 1266196 →	0-N137	TB [TE]		
1.8	07/95-08/99	B 4184 S, B 4184 S3	1731	: →1266195	0-N930	TB [TE]		
1.8	07/95-08/99	B 4184 S, B 4184 S3	1731		0-N958	TB [DG]		
1.8	03/99-06/04	B 4184 S2, B 4184 S9	1783		0-N137	TB [TE]		
1.8	03/99-06/04	B 4184 S2, B 4184 S9	1783		0-N958	TB [DG]		
1.8 i	03/98-06/04	B 4184 SJ, B 4184 SM	1834		0-N055	TB [DG]		
1.8 i	03/98-06/04	B 4184 SJ, B 4184 SM	1834		0-N056	TB [TE]		
1.9 DI	03/99-07/00	D 4192 T2	1870		0-N147	TB [DG]		
1.9 DI	03/99-07/00	D 4192 T2	1870		0-N148	TB [DG]		
1.9 DI	07/00-06/04	D 4192 T3, D 4192 T4	1870	mit Grundträger	0-N1173	TB [BT]		
1.9 DI, 1.9 TD	07/95-07/00	D 4192 T, D 4192 T2	1870		0-N173	TB [TE]		
1.9 T4	05/97-07/00	B 4194 T	1855	: 1219753 →	0-N137	TB [TE]		
1.9 T4	05/97-07/00	B 4194 T	1855	: →1219752	0-N930	TB [TE]		
1.9 T4	05/97-07/00	B 4194 T	1855		0-N958	TB [DG]		
1.9 TD	07/95-08/99	D 4192 T	1870	: 20560 →	0-N147	TB [DG]		
1.9 TD	07/95-08/99	D 4192 T	1870		0-N854	TB [DG]		
2.0	07/95-06/04	B 4204 S, B 4204 S2	1948	: 1266196 →	0-N137	TB [TE]		
2.0	07/95-06/04	B 4204 S, B 4204 S2	1948	: →1266195	0-N930	TB [TE]		
2.0 T	10/97-07/00	B 4204 T	1948	: 1219753 →	0-N137	TB [TE]		
2.0 T	10/97-07/00	B 4204 T	1948	: →1219752	0-N930	TB [TE]		
2.0 T, 2.0 T4	07/99-06/04	B 4204 T2, B 4204 T3, B 4204 T5	1948		0-N137	TB [TE]		
2.0, 2.0 T, 2.0 T4	07/95-06/04	B 4204 S, B 4204 S2, B 4204 T, B 4204 T2, B 4204 T3, B 4204 T5	1948		0-N958	TB [DG]		
1.6	12/95-08/99	B 4164 S	1588		0-N1425	VB [DG]		
1.6	12/95-08/99	B 4164 S	1588		0-N1558S	VB [TE]		

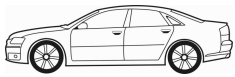

CM³



Art. Nr.



V40 Kombi (VW)

1.6	12/95-08/99	B 4164 S	1588	:→1266195	0-N2223	VB [VD]	
1.6	03/99-06/04	B 4164 S2	1587		0-N1529	VB [BT]	S
1.6	03/99-06/04	B 4164 S2	1587	Rippenanzahl: 6;	0-N1647	VB [DG]	
1.8	07/95-08/99	B 4184 S, B 4184 S3	1731		0-N1425	VB [DG]	
1.8	07/95-08/99	B 4184 S, B 4184 S3	1731		0-N1558S	VB [TE]	
1.8	07/95-08/99	B 4184 S, B 4184 S3	1731	:→1266195	0-N2223	VB [VD]	
1.8	03/99-06/04	B 4184 S2, B 4184 S9	1783		0-N1529	VB [BT]	S
1.8	03/99-06/04	B 4184 S2, B 4184 S9	1783	Rippenanzahl: 6;	0-N1647	VB [DG]	
1.9 DI	03/99-07/00	D 4192 T2	1870		0-N1470	VB [BT]	S
1.9 DI	03/99-07/00	D 4192 T2	1870		0-N1729	VB [DG]	
1.9 DI	07/00-06/04	D 4192 T3, D 4192 T4	1870		0-N1307	VB [DG]	
1.9 DI	07/00-06/04	D 4192 T3, D 4192 T4	1870		0-N1611	VB [BT]	S
1.9 DI	07/00-06/04	D 4192 T3, D 4192 T4	1870		0-N1802	VB [BT]	S
1.9 T4	05/97-07/00	B 4194 T	1855		0-N1425	VB [DG]	
1.9 T4	05/97-07/00	B 4194 T	1855		0-N1558S	VB [TE]	
1.9 T4	05/97-07/00	B 4194 T	1855	:→1219752	0-N2223	VB [VD]	
1.9 TD	07/95-08/99	D 4192 T	1870	:7795→	0-N1470	VB [BT]	S
1.9 TD	07/95-08/99	D 4192 T	1870	:→7794	0-N152	VB [BT]	S
1.9 TD	07/95-08/99	D 4192 T	1870		0-N1729	VB [DG]	
2.0	07/95-06/04	B 4204 S, B 4204 S2	1948	:→1266195	0-N2223	VB [VD]	
2.0 T	10/97-07/00	B 4204 T	1948	:→1219752	0-N2223	VB [VD]	
2.0 T, 2.0 T4	07/99-06/04	B 4204 T2, B 4204 T3, B 4204 T5	1948		0-N1529	VB [BT]	S
2.0 T, 2.0 T4	07/99-06/04	B 4204 T2, B 4204 T3, B 4204 T5	1948	Rippenanzahl: 6;	0-N1647	VB [DG]	
2.0, 2.0 T	07/95-06/04	B 4204 S, B 4204 S, B 4204 S2, B 4204 T	1948		0-N1425	VB [DG]	
2.0, 2.0 T	07/95-06/04	B 4204 S, B 4204 S, B 4204 S2, B 4204 T	1948		0-N1558S	VB [TE]	

V40 Schrägheck

D2	03/12-	D 4162 T	1560	25x141; Baumuster: Cross Country	SK-1728	BTK	
D2	03/12-	D 4162 T	1560	25x141; Baumuster: Cross Country	SK-1728AQ1	BTKW	
D3, D4	03/12-03/15	D 5204 T4, D 5204 T6	1984	28x132	SK-1608	BTK	
T4, T4 AWD, T5 AWD	03/13-	B 5204 T8, B 5204 T9	1984	23x142	SK-1492	BTK	
T4, T4 AWD, T5, T5 AWD	03/13-	B 5204 T8, B 5204 T9	1984	23x142	SK-1492AQ1	BTKW	
T5	12/12-	B 5254 T12	2497	23x142; Baumuster: Cross Country	SK-1492	BTK	
T5	12/12-	B 5254 T12, B 5254 T14	2497	23x142; Baumuster: Cross Country	SK-1492AQ1	BTKW	
T5	12/12-	B 5254 T12	2497	23x142	SK-1666	BTK	
T5 AWD	01/13-	B 5254 T12	2497	23x142	SK-1492	BTK	
T5 AWD	01/13-	B 5254 T12	2497	23x142	SK-1492AQ1	BTKW	
D2	03/12-	D 4162 T	1560		0-N2382	TB [DG]	
D3, D4	03/12-03/15	D 5204 T4, D 5204 T6	1984		0-N1349	TB [TE]	
D3, D4	03/12-03/15	D 5204 T4, D 5204 T6	1984		0-N1350	TB [DG]	
T2 GTDi, T3 GTDi, T4 GTDi	03/12-	B 4164 T, B 4164 T3, B 4164 T4	1596		0-N2057	TB [TE]	
D3, D4	03/12-03/15	D 5204 T4, D 5204 T6	1984		0-N2190	VB [BT]	S
T2 GTDi, T3 GTDi, T4 GTDi	03/12-	B 4164 T, B 4164 T3, B 4164 T4	1596		0-N2269	VB [BT]	S
T2 GTDi, T3 GTDi, T4 GTDi	03/12-	B 4164 T, B 4164 T3, B 4164 T4	1596		0-N2363	VB [DG]	

V50 (MW)

1.6	01/05-	B 4164 S3	1596	22x117; 115449; mit Zubehör	SK-1077	BTK	
1.6	01/05-	B 4164 S3	1596	22x117; 115449; mit Zubehör	SK-1077AQ1	BTKW	
1.6	01/05-	B 4164 S3	1596	22x117; ch.115450→; 05/2005 →; mit Zubehör	SK-1659	BTK	
1.6	01/05-	B 4164 S3	1596	22x117; ch.115450→; mit Zubehör	SK-1659AQ1	BTKW	
1.6 D	01/05-	D 4164 T	1560	25x137	SK-1424	BTK	
1.6 D	01/05-	D 4164 T	1560	25x137	SK-1424AQ1	BTKW	
1.6 D2	01/10-	D 4162 T	1560	25x141	SK-1728	BTK	
1.6 D2	01/10-	D 4162 T	1560	25x141	SK-1728AQ1	BTKW	
2.0 D	04/04-	D 4204 T	1998	25.4x116	SK-1594	BTK	
2.0 D	04/04-	D 4204 T	1998	25.4x116	SK-1594AQ1	BTKW	
2.4 D5, 2.4 Tdi	03/06-	D 5244 T13, D 5244 T8, D 5244 T9	2400	28x132	SK-1608	BTK	
2.4 D5, 2.4 Tdi	03/06-	D 5244 T13, D 5244 T8, D 5244 T9	2400	28x132	SK-1608AQ1	BTKW	
2.4, 2.4 AWD	04/04-	B 5244 S4, B 5244 S5	2435	23x142; :→3887615	SK-1492	BTK	
2.4, 2.4 AWD	04/04-	B 5244 S4, B 5244 S5	2435	23x142; :→3887615	SK-1492AQ1	BTKW	
2.4, 2.4 AWD	04/04-	B 5244 S4, B 5244 S5	2435	23x142; :3887616→	SK-1666	BTK	
2.4, 2.4 AWD	04/04-	B 5244 S4, B 5244 S5	2435	23x142; :3887616→	SK-1666AQ1	BTKW	
D3, D4	10/10-	D 5204 T, D 5204 T5	1984	28x132; :1046802→	SK-1608	BTK	
T5, T5 AWD	04/04-	B 5254 T3, B 5254 T7	2521	23x142; :→3887615	SK-1492	BTK	
T5, T5 AWD	04/04-	B 5254 T3, B 5254 T7	2521	23x142; :→3887615	SK-1492AQ1	BTKW	
T5, T5 AWD	04/04-	B 5254 T3, B 5254 T7	2521	23x142; :3887616→	SK-1666	BTK	



CM³



Art. Nr.



ohne Halter

V50 (MW)

T5, T5 AWD	04/04-	B 5254 T3, B 5254 T7	2521	23x142; :3887616→	SK-1666AQ1	BTKW	
1.6	01/05-	B 4164 S3	1596	ch.115450→	0-N1564	TB [TE]	
1.6 D	01/05-	D 4164 T	1560		0-N1062	TB [TE]	
1.6 D	01/05-	D 4164 T	1560		0-N1066	TB [DG]	
1.6 D2	01/10-	D 4162 T	1560		0-N2224	TB [TE]	
1.6 D2	01/10-	D 4162 T	1560		0-N2382	TB [DG]	
2.0 D	04/04-	D 4204 T	1998		0-N1334	TB [DG]	
2.4	04/04-	B 5244 S4, B 5244 S5	2435	ch.→206721	0-N1324	TB [TE]	
2.4	04/04-	B 5244 S4, B 5244 S5	2435	ch.206722→	0-N1573	TB [TE]	
2.4 AWD	08/06-	B 5244 S4	2435	ch.→202464	0-N1324	TB [TE]	
2.4 AWD	08/06-	B 5244 S4	2435	ch.202465→	0-N1573	TB [TE]	
2.4 D5, 2.4 Tdi	03/06-	D 5244 T13, D 5244 T8, D 5244 T9	2400		0-N1349	TB [TE]	
2.4 D5, 2.4 Tdi	03/06-	D 5244 T13, D 5244 T8, D 5244 T9	2400		0-N1350	TB [DG]	
2.4, 2.4 AWD	04/04-	B 5244 S4, B 5244 S5	2435		0-N958	TB [DG]	
D3, D4	10/10-	D 5204 T, D 5204 T5	1984		0-N1349	TB [TE]	
D3, D4	10/10-	D 5204 T, D 5204 T5	1984		0-N1350	TB [DG]	
T5, T5 AWD	04/04-	B 5254 T3, B 5254 T7	2521	ch.→206721	0-N1324	TB [TE]	
T5, T5 AWD	04/04-	B 5254 T3, B 5254 T7	2521	ch.206722→	0-N1573	TB [TE]	
T5, T5 AWD	04/04-	B 5254 T3, B 5254 T7	2521		0-N958	TB [DG]	
1.6 D	01/05-	D 4164 T	1560	ch.→554734	0-N1339	VB [BT]	S
1.8, 1.8 FlexFuel	04/04-	B 4184 S11, B 4184 S8	1798	ch.→73764	0-N1639	VB [BT]	S
1.8, 1.8 FlexFuel	04/04-	B 4184 S11, B 4184 S8	1798		0-N2353	VB [DG]	
2.0	10/06-	B 4204 S3	1999	ch.→73764	0-N1639	VB [BT]	S
2.0 D	04/04-	D 4204 T	1998		0-N1327	VB [BT]	
2.0 D	04/04-	D 4204 T	1998		0-N2037	VB [BT]	S
2.0, 2.0 FlexFuel	10/06-	B 4204 S3, B 4204 S4	1999		0-N2353	VB [DG]	
2.4 D5, 2.4 Tdi	03/06-	D 5244 T13, D 5244 T8, D 5244 T9	2400	:→619467	0-N1554	VB [BT]	S
2.4 D5, 2.4 Tdi	03/06-	D 5244 T13, D 5244 T8, D 5244 T9	2400	:→619467	0-N2096	VB [BT]	S
2.4 D5, 2.4 Tdi	03/06-	D 5244 T13, D 5244 T8, D 5244 T9	2400	:619468→	0-N2109	VB [BT]	S
2.4 D5, 2.4 Tdi	03/06-	D 5244 T13, D 5244 T8, D 5244 T9	2400	:619468→	0-N2190	VB [BT]	S
2.4, 2.4 AWD	04/04-	B 5244 S4, B 5244 S5	2435	:→4293284	0-N1554	VB [BT]	S
2.4, 2.4 AWD	04/04-	B 5244 S4, B 5244 S5	2435	:→4293284	0-N2096	VB [BT]	S
2.4, 2.4 AWD	04/04-	B 5244 S4, B 5244 S5	2435	:4293285→	0-N2109	VB [BT]	S
2.4, 2.4 AWD	04/04-	B 5244 S4, B 5244 S5	2435	:4293285→	0-N2190	VB [BT]	S
D3, D4	10/10-	D 5204 T, D 5204 T5	1984	:→619467;	0-N2096	VB [BT]	S
D3, D4	10/10-	D 5204 T, D 5204 T5	1984	:619468→;	0-N2109	VB [BT]	S
D3, D4	10/10-	D 5204 T, D 5204 T5	1984	:619468→;	0-N2190	VB [BT]	S
T5, T5 AWD	04/04-	B 5254 T3, B 5254 T7	2521	:→4293284	0-N1554	VB [BT]	S
T5, T5 AWD	04/04-	B 5254 T3, B 5254 T7	2521	:→4293284	0-N2096	VB [BT]	S
T5, T5 AWD	04/04-	B 5254 T3, B 5254 T7	2521	:4293285→	0-N2109	VB [BT]	S
T5, T5 AWD	04/04-	B 5254 T3, B 5254 T7	2521	:4293285→	0-N2190	VB [BT]	S

V60

1.6 DRIVe	06/11-	D 4162 T	1560	25x141	SK-1728	BTK	
1.6 DRIVe	06/11-	D 4162 T	1560	25x141	SK-1728AQ1	BTKW	
2.4 D5, 2.4 D5 AWD, 2.4 Hybrid AWD	06/11-	D 5244 T11, D 5244 T15, D 5244 T15, D 5244 T15, D82PHEV, D82PHEV	2400	28x132	SK-1608AQ1	BTKW	
2.4 D5, 2.4 D5 AWD, 2.4 Hybrid AWD, D5	06/11-	D 5244 T11, D 5244 T15, D 5244 T15, D 5244 T15, D 5244 T17, D82PHEV, D82PHEV	2400	28x132; :→1046801	SK-1608	BTK	
D3	09/10-	D 5204 T2, D 5204 T3	1984	28x132	SK-1608	BTK	
D5, D5 AWD	09/10-	D 5244 T10	2400	28x132	SK-1608	BTK	
1.6 DRIVe	06/11-	D 4162 T	1560		0-N2224	TB [TE]	
1.6 DRIVe	06/11-	D 4162 T	1560		0-N2382	TB [DG]	
2.4 D5, 2.4 D5 AWD, 2.4 Hybrid AWD, D5, D5 AWD	09/10-	D 5244 T10, D 5244 T11, D 5244 T15, D 5244 T15, D 5244 T15, D82PHEV, D82PHEV	2400		0-N1349	TB [TE]	
2.4 D5, 2.4 D5 AWD, 2.4 Hybrid AWD, D5, D5 AWD	09/10-	D 5244 T10, D 5244 T11, D 5244 T15, D 5244 T15, D 5244 T15, D82PHEV, D82PHEV	2400		0-N1350	TB [DG]	
D3	09/10-	D 5204 T2, D 5204 T3	1984		0-N1349	TB [TE]	
D3	09/10-	D 5204 T2, D 5204 T3	1984		0-N1350	TB [DG]	
T3, T4, T4F	09/10-	B 4164 T, B 4164 T2, B 4164 T3	1596		0-N2057	TB [TE]	
2.4 D5, 2.4 D5 AWD, 2.4 Hybrid AWD	06/11-	D 5244 T11, D 5244 T15, D 5244 T15, D 5244 T15, D82PHEV, D82PHEV	2400	:→1046801	0-N2204	VB [BT]	S
2.4 D5, 2.4 D5 AWD, 2.4 Hybrid AWD, D5	06/11-	D 5244 T11, D 5244 T15, D 5244 T15, D 5244 T15, D 5244 T17, D82PHEV, D82PHEV	2400	:1046802→	0-N1964	VB [BT]	S



CM³



Art. Nr.



V60								
3.0 T AWD, T6 AWD	09/10-	B 6304 T3, B 6304 T4, B 6304 T4, B 6304 T5	2953			0-N2242	VB [BT]	S
3.0 T AWD, T6 AWD	09/10-	B 6304 T3, B 6304 T4, B 6304 T4, B 6304 T5	2953			0-N2243	VB [DG]	
D3	09/10-	D5204T2	1984	:→884797		0-N1964	VB [BT]	S
D3	09/10-	D5204T3	1984	:→1046801		0-N2204	VB [BT]	S
D3	09/10-	D5204T2	1984	:884798→		0-N2204	VB [BT]	S
D3	12/12-	D 5204 T7	1984	:1046802→		0-N1964	VB [BT]	S
D5, D5 AWD	09/10-	D 5244 T10	2400	:→884797		0-N1964	VB [BT]	S
D5, D5 AWD	09/10-	D 5244 T10	2400			0-N2204	VB [BT]	S
T3, T4, T4F	09/10-	B 4164 T, B 4164 T2, B 4164 T3	1596			0-N2269	VB [BT]	S
T3, T4, T4F	09/10-	B 4164 T, B 4164 T2, B 4164 T3	1596			0-N2363	VB [DG]	
V70 I (LV)								
2.0	01/97-03/00	B 5202 S	1984	23x144; :→1266127; Spannrollenbetätigung: hydraulisch		SK-1270	BTK	
2.0	01/97-03/00	B 5202 S	1984	23x144; :→1266127; Spannrollenbetätigung: hydraulisch		SK-1270AQ1	BTKW	
2.0	01/97-03/00	B 5204 T4	1984	23x142; 12/1998 →		SK-1491	BTK	
2.0	01/97-03/00	B 5204 T4	1984	23x142		SK-1491AQ1	BTKW	
2.0	01/97-03/00	B 5204 T4	1984	23x142		SK-1492AQ1	BTKW	
2.0	01/97-03/00	B 5202 S	1984	23x138; :1266128→		SK-1531	BTK	
2.0, 2.0 Turbo, 2.0 Turbo AWD	01/97-03/00	B 5204 F, B 5204 T, B 5204 T2, B 5204 T3	1984	23x148; :→1266127; mit Zubehör; Spannrollenbetätigung: hydraulisch		SK-1103	BTK	
2.0, 2.0 Turbo, 2.0 Turbo AWD	01/97-03/00	B 5204 F, B 5204 T, B 5204 T2, B 5204 T3	1984	23x148; :→1266127; mit Zubehör; Spannrollenbetätigung: hydraulisch		SK-1103AQ1	BTKW	
2.0, 2.0 Turbo, 2.0 Turbo AWD	01/97-03/00	B 5204 F, B 5204 T, B 5204 T2, B 5204 T3	1984	23x142; :1266128→		SK-1491	BTK	
2.0, 2.0 Turbo, 2.0 Turbo AWD	01/97-03/00	B 5204 F, B 5204 T, B 5204 T2, B 5204 T3	1984	23x142; :1266128→; :→3192745; Spannrollenbetätigung: mechanisch		SK-1491AQ1	BTKW	
2.0, 2.0 Turbo, 2.0 Turbo AWD	01/97-03/00	B 5204 F, B 5204 T, B 5204 T2, B 5204 T3, B 5204 T4	1984	23x142; :3192746→		SK-1492	BTK	
2.0, 2.0 Turbo, 2.0 Turbo AWD	01/97-03/00	B 5204 F, B 5204 T, B 5204 T2, B 5204 T3	1984	23x142; :3192746→		SK-1492AQ1	BTKW	
2.3	11/96-11/00	B 5234 T3	2319	23x142; :1266128→; :→3192745; mit Feder; Spannrollenbetätigung: mechanisch		SK-1491	BTK	
2.3 AWD	12/98-02/00	B 5234 T7, B 5234 T8	2319	23x142; :→3192745		SK-1491AQ1	BTKW	
2.3 AWD, 2.3 T AWD, 2.3 T-5, 2.3 T-5 AWD, 2.3 Turbo	01/97-03/00	B 5234 FT+, B 5234 FT+, B 5234 T4, B 5234 T3	2319	23x142; :1266128→		SK-1491	BTK	
2.3, 2.3 AWD, 2.3 T AWD, 2.3 T-5, 2.3 T-5 AWD, 2.3 Turbo	11/96-11/00	B 5234 FT+, B 5234 FT+, B 5234 T4, B 5234 T3	2319	23x148; :→1266127; mit Zubehör; Spannrollenbetätigung: hydraulisch		SK-1103	BTK	
2.3, 2.3 AWD, 2.3 T AWD, 2.3 T-5, 2.3 T-5 AWD, 2.3 Turbo	11/96-11/00	B 5234 FT+, B 5234 FT+, B 5234 T4, B 5234 T3	2319	23x148; :→1266127; mit Zubehör; Spannrollenbetätigung: hydraulisch		SK-1103AQ1	BTKW	
2.3, 2.3 AWD, 2.3 T AWD, 2.3 T-5, 2.3 T-5 AWD, 2.3 Turbo	11/96-11/00	B 5234 FT+, B 5234 FT+, B 5234 T4, B 5234 T3	2319	23x142; :1266128→; :→3192745; Spannrollenbetätigung: mechanisch		SK-1491AQ1	BTKW	
2.3, 2.3 AWD, 2.3 T AWD, 2.3 T-5, 2.3 T-5 AWD, 2.3 Turbo	11/96-11/00	B 5234 FT+, B 5234 FT+, B 5234 T4, B 5234 T3, B 5234 T7, B 5234 T8	2319	23x142; :3192746→		SK-1492	BTK	
2.3, 2.3 AWD, 2.3 T AWD, 2.3 T-5, 2.3 T-5 AWD, 2.3 Turbo	11/96-11/00	B 5234 FT+, B 5234 FT+, B 5234 T4, B 5234 T3, B 5234 T7, B 5234 T8	2319	23x142; :3192746→		SK-1492AQ1	BTKW	
2.4	01/97-05/00	B 5244 S, B 5254 S	2435	23x148; :→1266127; mit Zubehör		SK-1103	BTK	
2.4	01/97-05/00	B5254FS	2435	23x148; :→1266127; mit Zubehör		SK-1103AQ1	BTKW	
2.4	01/97-05/00	B 5244 S	2435	23x142		SK-1491	BTK	
2.4	01/97-05/00	B 5244 S, B 5254 S	2435	23x142; :1266128→; Spannrollenbetätigung: mechanisch		SK-1491	BTK	
2.4	01/97-05/00	B 5244 S	2435	23x142; :→3192745		SK-1491AQ1	BTKW	
2.4	01/97-05/00	B5254FS	2435	23x142; :1266128→; :→3192745		SK-1491AQ1	BTKW	
2.4	01/97-05/00	B 5244 S	2435	23x142; :3192746→		SK-1492	BTK	
2.4	01/97-05/00	B 5244 S	2435	23x142; :3192746→		SK-1492AQ1	BTKW	
2.4	01/97-05/00	B5254FS	2435	23x142; :3192746→		SK-1492AQ1	BTKW	
2.4	08/99-05/00	B 5244 S2	2435	23x142		SK-1491	BTK	
2.4 AWD, 2.5 AWD	10/98-03/00	B 5244 T2, B 5254 S	2435	23x142		SK-1491	BTK	
2.4 Bifuel	08/99-03/00	B 5244 SG	2435	23x142; :→3188688		SK-1491	BTK	
2.4 Turbo	01/97-03/00	B 5244 T	2435	23x142		SK-1491	BTK	
2.4 Turbo	01/97-03/00	B 5254 T	2435	23x142; :1266128→; Spannrollenbetätigung: mechanisch		SK-1491	BTK	
2.4 Turbo, 2.5 Turbo AWD	01/97-05/00	B 5254 T	2435	23x148; :→1266127; mit Zubehör; Spannrollenbetätigung: hydraulisch		SK-1103	BTK	
2.4 Turbo, 2.5 Turbo AWD	01/97-05/00	B 5244 T, B 5254 T	2435	23x148; :→1266127; mit Zubehör; Spannrollenbetätigung: hydraulisch		SK-1103AQ1	BTKW	
2.4 Turbo, 2.5 Turbo AWD	01/97-05/00	B 5244 T, B 5254 T	2435	23x142; :1266128→; :→3192745; Spannrollenbetätigung: mechanisch		SK-1491AQ1	BTKW	
2.4, 2.4 AWD, 2.4 Bifuel, 2.4 Turbo, 2.5, 2.5 AWD, 2.5 Turbo AWD	01/97-05/00	B 5244 S, B 5254 S, B 5244 S2, B 5244 SG2, B 5244 SG, B 5244 T, B 5254 T, B 5244 T2, B 5254 S	2435	23x142; :3192746→		SK-1492	BTK	



OPTIMAL®

VOLVO

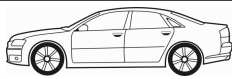

CM³



Art. Nr.



ohne Halter

V70 I (LV)

2.4, 2.4 AWD, 2.4 Bifuel, 2.4 Turbo, 2.5, 2.5 AWD, 2.5 Turbo AWD	01/97-05/00	B 5244 S2, B 5244 SG2, B 5244 SG, B 5244 T, B 5254 T, B 5244 T2, B 5254 S	2435	23x142; :3192746→	SK-1492AQ1	BTKW	
2.4, 2.4 AWD, 2.4 Bifuel, 2.5, 2.5 AWD	06/98-05/00	B 5244 S2, B 5244 SG2, B 5244 SG, B 5244 T2, B 5254 S	2435	23x142; :→3192745	SK-1491AQ1	BTKW	
2.5	01/97-03/00	B 5252 FS	2435	23x138; :1266128→	SK-1531	BTK	
2.5	06/98-03/00	B 5254 S	2435	23x142; 10/1998 →	SK-1491	BTK	
2.5 Bifuel	10/98-08/99	GB 5252 S	2435	23x138	SK-1531	BTK	
2.5 TDI	01/97-05/00	D 5252 T	2461	25.4x120	SK-1526AQ2	BTKW	
2.5 TDI	01/97-05/00	D 5252 T	2461	26.5x122; 21x81; mit Zubehör	SK-1529	BTK	
2.5 TDI	01/97-05/00	D 5252 T	2461	26.5x122; mit Zubehör	SK-1725	BTK	
2.5 TDi AWD	11/96-02/00	D 5252 T	2460	25.4x120	SK-1526AQ2	BTKW	
2.5 TDi AWD	11/96-02/00	D 5252 T	2460	26.5x122; 21x81; mit Zubehör	SK-1529	BTK	
2.5 TDi AWD	11/96-02/00	D 5252 T	2460	26.5x122; mit Zubehör	SK-1725	BTK	
2.5 Turbo AWD	01/97-05/00	B 5244 T, B 5254 T	2435	23x142; :1266128→; :→3192745; mit Feder; Spannrollenbetätigung: mechanisch	SK-1491	BTK	
2.5, 2.5 Bifuel	01/97-03/00	B 5252 FS, GB 5252 S	2435	23x144; :→1266127; Spannrollenbetätigung: hydraulisch	SK-1270	BTK	
2.5, 2.5 Bifuel	01/97-03/00	B 5252 FS, GB 5252 S	2435	23x144; :→1266127; Spannrollenbetätigung: hydraulisch	SK-1270AQ1	BTKW	
2.0, 2.0 Turbo, 2.0 Turbo AWD	01/97-03/00	B 5202 S, B 5204 F, B 5204 T, B 5204 T2, B 5204 T3, B 5204 T4	1984	:1266128→	0-N137	TB [TE]	
2.0, 2.0 Turbo, 2.0 Turbo AWD	01/97-03/00	B 5202 S, B 5204 F, B 5204 T, B 5204 T2, B 5204 T3, B 5204 T4	1984	:→1266127	0-N930	TB [TE]	
2.0, 2.0 Turbo, 2.0 Turbo AWD	01/97-03/00	B 5202 S, B 5204 F, B 5204 T, B 5204 T2, B 5204 T3, B 5204 T4	1984		0-N958	TB [DG]	
2.3 AWD	04/97-09/98	B 5234 T3	2319	:3192746→	0-N1324	TB [TE]	
2.3 AWD	04/97-09/98	B 5234 T3	2319	:1266128→; :→3192745	0-N137	TB [TE]	
2.3 AWD, 2.3 T AWD, 2.3 T-5, 2.3 T-5 AWD, 2.3 Turbo	01/97-03/00	B 5234 FT+, B 5234 FT+, B 5234 T4, B 5234 T3, B 5234 T7, B 5234 T8	2319	:1266128→	0-N137	TB [TE]	
2.3 AWD, 2.3 T AWD, 2.3 T-5, 2.3 T-5 AWD, 2.3 Turbo	01/97-03/00	B 5234 FT+, B 5234 FT+, B 5234 T4, B 5234 T3, B 5234 T7, B 5234 T8	2319		0-N958	TB [DG]	
2.3, 2.3 AWD, 2.3 T AWD, 2.3 T-5, 2.3 T-5 AWD, 2.3 Turbo	11/96-11/00	B 5234 FT+, B 5234 FT+, B 5234 T4, B 5234 T3, B 5234 T7, B 5234 T8	2319	:→1266127	0-N930	TB [TE]	
2.4 AWD	05/99-02/00	B 5244 T2	2435	:3192746→	0-N1324	TB [TE]	
2.4 AWD	05/99-02/00	B 5244 T2	2435	:→3192745	0-N137	TB [TE]	
2.4, 2.4 AWD, 2.4 Bifuel, 2.4 Turbo, 2.5, 2.5 AWD, 2.5 Bifuel, 2.5 Turbo AWD	01/97-05/00	B 5244 S, B 5254 S, B 5244 S2, B 5244 SG2, B 5244 SG, B 5244 T, B 5254 T, B 5244 T2, B 5252 FS, B 5254 S, GB 5252 S	2435		0-N958	TB [DG]	
2.4, 2.4 AWD, 2.4 Turbo, 2.5, 2.5 Bifuel, 2.5 Turbo AWD	01/97-05/00	B 5244 S, B 5254 S, B 5244 T, B 5254 T, B 5252 FS, B 5254 S, GB 5252 S	2435	:1266128→	0-N137	TB [TE]	
2.4, 2.4 AWD, 2.4 Turbo, 2.5, 2.5 Bifuel, 2.5 Turbo AWD	01/97-05/00	B 5244 S, B 5254 S, B 5244 T, B 5254 T, B 5252 FS, B 5254 S, GB 5252 S	2435	:→1266127	0-N930	TB [TE]	
2.4, 2.4 Bifuel, 2.5 AWD	03/99-05/00	B 5244 S2, B 5244 SG2, B 5244 SG, B 5244 T2	2435		0-N137	TB [TE]	
2.5 TDI	01/97-05/00	D 5252 T	2461		0-N110	TB [TE]	
2.5 TDI	01/97-05/00	D 5252 T	2461		0-N116	TB [TE]	
2.5 TDI	01/97-05/00	D 5252 T	2461		0-N117	TB [TE]	
2.5 TDi AWD	11/96-02/00	D 5252 T	2460		0-N110	TB [TE]	
2.5 TDi AWD	11/96-02/00	D 5252 T	2460		0-N116	TB [TE]	
2.5 TDi AWD	11/96-02/00	D 5252 T	2460		0-N117	TB [TE]	
2.0, 2.0 Turbo, 2.0 Turbo AWD	01/97-03/00	B 5202 S, B 5204 F, B 5204 T, B 5204 T2, B 5204 T3, B 5204 T4	1984	→ 12/1998	0-N143	VB [DG]	
2.0, 2.0 Turbo, 2.0 Turbo AWD	01/97-03/00	B 5204 T, B 5204 T2, B 5204 T3	1984	→ 12/1998	0-N1448	VB [DG]	
2.0, 2.0 Turbo, 2.0 Turbo AWD	01/97-03/00	B 5202 S, B 5204 F, B 5204 T, B 5204 T2, B 5204 T3, B 5204 T4	1984	→ 12/1998	0-N1518	VB [BT]	S
2.0, 2.0 Turbo, 2.0 Turbo AWD	01/97-03/00	B 5202 S, B 5204 F, B 5204 T, B 5204 T2, B 5204 T3, B 5204 T4	1984	01/1999 →	0-N1529	VB [BT]	S
2.0, 2.0 Turbo, 2.0 Turbo AWD	01/97-03/00	B 5202 S, B 5204 F, B 5204 T, B 5204 T2, B 5204 T3, B 5204 T4	1984	01/1999 →; Rippenanzahl: 6;	0-N1647	VB [DG]	
2.0, 2.0 Turbo, 2.0 Turbo AWD	01/97-03/00	B 5202 S, B 5204 F, B 5204 T, B 5204 T2, B 5204 T3, B 5204 T4	1984	:→1266127	0-N2223	VB [VD]	
2.3 AWD	04/97-09/98	B 5234 T3	2319		0-N143	VB [DG]	
2.3 AWD	04/97-09/98	B 5234 T3	2319		0-N1518	VB [BT]	S
2.3 AWD	04/97-09/98	B 5234 T3	2319	:1266127→	0-N2223	VB [VD]	
2.3 AWD, 2.3 T AWD, 2.3 T-5, 2.3 T-5 AWD, 2.3 Turbo	01/97-03/00	B 5234 FT+, B 5234 FT+, B 5234 T4, B 5234 T3, B 5234 T7, B 5234 T8	2319	:→1266127	0-N2223	VB [VD]	
2.3 T AWD, 2.3 T-5, 2.3 T-5 AWD, 2.3 Turbo	01/97-03/00	B 5234 FT+, B 5234 FT+, B 5234 T4, B 5234 T3	2319	→ 12/1998	0-N143	VB [DG]	
2.3 T AWD, 2.3 T-5, 2.3 T-5 AWD, 2.3 Turbo	01/97-03/00	B 5234 FT+, B 5234 FT+, B 5234 T4, B 5234 T3	2319	→ 12/1998	0-N1518	VB [BT]	S
2.3 T AWD, 2.3 T-5, 2.3 T-5 AWD, 2.3 Turbo	01/97-03/00	B 5234 FT+, B 5234 FT+, B 5234 T4, B 5234 T3	2319	01/1999 →	0-N1529	VB [BT]	S



CM³



Art. Nr.



V70 I (LV)									
2.3 T AWD, 2.3 T-5, 2.3 T-5 AWD, 2.3 Turbo	01/97-03/00	B 5234 FT+, B 5234 FT+, B 5234 T4, B 5234 T3	2319	01/1999 →; Rippenanzahl: 6;	0-N1647	VB [DG]			
2.3 T-5, 2.3 T-5 AWD	01/97-03/00	B 5234 T3	2319	→ 12/1998	0-N1448	VB [DG]			
2.4, 2.4 AWD, 2.4 Turbo, 2.5, 2.5 Bifuel, 2.5 Turbo AWD	01/97-05/00	B 5244 S, B 5254 S, B 5244 T, B 5254 T, B 5252 FS, B 5254 S, GB 5252 S	2435	→ 12/1998	0-N143	VB [DG]			
2.4, 2.4 AWD, 2.4 Turbo, 2.5, 2.5 Bifuel, 2.5 Turbo AWD	01/97-05/00	B 5244 S, B 5254 S, B 5244 T, B 5254 T, B 5252 FS, B 5254 S, GB 5252 S	2435	→ 12/1998	0-N1518	VB [BT]	S		
2.4, 2.4 AWD, 2.4 Turbo, 2.5, 2.5 Bifuel, 2.5 Turbo AWD	01/97-05/00	B 5244 S, B 5254 S, B 5244 T, B 5254 T, B 5252 FS, B 5254 S, GB 5252 S	2435	01/1999 →	0-N1529	VB [BT]	S		
2.4, 2.4 AWD, 2.4 Turbo, 2.5, 2.5 Bifuel, 2.5 Turbo AWD	01/97-05/00	B 5244 S, B 5254 S, B 5244 T, B 5254 T, B 5252 FS, B 5254 S, GB 5252 S	2435	01/1999 →; Rippenanzahl: 6;	0-N1647	VB [DG]			
2.4, 2.4 AWD, 2.4 Turbo, 2.5, 2.5 Bifuel, 2.5 Turbo AWD	01/97-05/00	B 5244 S, B 5254 S, B 5244 T, B 5254 T, B 5252 FS, B 5254 S, GB 5252 S	2435	: → 1266127	0-N2223	VB [VD]			
2.4, 2.4 Bifuel, 2.5 AWD	03/99-05/00	B 5244 S2, B 5244 SG2, B 5244 SG, B 5244 T2	2435		0-N1529	VB [BT]	S		
2.4, 2.4 Bifuel, 2.5 AWD	03/99-05/00	B 5244 S2, B 5244 SG2, B 5244 SG, B 5244 T2	2435	Rippenanzahl: 6;	0-N1647	VB [DG]			
2.5 TDI	01/97-05/00	D 5252 T	2461		0-N1424	VB [DG]			
2.5 TDI	01/97-05/00	D 5252 T	2461		0-N1953	VB [BT]	S		
2.5 TDi AWD	11/96-02/00	D 5252 T	2460		0-N1424	VB [DG]			
2.5 TDi AWD	11/96-02/00	D 5252 T	2460		0-N1953	VB [BT]	S		
V70 II (SW)									
2.0 T	07/01-08/07	B 5204 T5	1984	23x142; : → 3188688	SK-1491	BTK			
2.0 T	07/01-08/07	B 5204 T5	1984	23x142; : → 3188688; Spannrollenbetätigung: mechanisch	SK-1491AQ1	BTKW			
2.0 T	07/01-08/07	B 5204 T5	1984	23x142; : 3188689 →	SK-1492	BTK			
2.0 T	07/01-08/07	B 5204 T5	1984	23x142; : 3188689 →	SK-1492AQ1	BTKW			
2.3	10/00-09/04	B 5234 T7	2319	23x148; : → 1266127; mit Zubehör; Spannrollenbetätigung: hydraulisch	SK-1103AQ1	BTKW			
2.3	10/00-09/04	B 5234 T7	2319	23x142; : 1266128 →	SK-1491	BTK			
2.3	10/00-09/04	B 5234 T7	2319	23x142; : 1266128 →; : → 3188688; Spannrollenbetätigung: mechanisch	SK-1491AQ1	BTKW			
2.3 T5	03/00-08/04	B 5234 T3	2319	23x142; : 1266128 →	SK-1491	BTK			
2.3 T5	03/00-08/04	B 5234 T3, B 5234 T4	2319	23x142; : → 3188688	SK-1491AQ1	BTKW			
2.3, 2.3 T5	03/00-09/04	B 5234 T3, B 5234 T4, B 5234 T7	2319	23x148; : → 1266127; mit Zubehör; Spannrollenbetätigung: hydraulisch	SK-1103	BTK			
2.3, 2.3 T5	03/00-09/04	B 5234 T3, B 5234 T4, B 5234 T7	2319	23x142; : 3188689 →	SK-1492	BTK			
2.3, 2.3 T5	03/00-09/04	B 5234 T3, B 5234 T4, B 5234 T7	2319	23x142; : 3188689 →	SK-1492AQ1	BTKW			
2.4	03/00-08/07	B 5244 S2	2435	23x142; 03/2001 →; : → 3188688	SK-1491	BTK			
2.4	03/00-08/07	B 5244 S	2435	23x142; ch. → 3188688; 03/2001 → 07/2007	SK-1491	BTK			
2.4 Bifuel, 2.4 Bifuel (LPG)	09/01-08/07	B 5244 SG, B 5244 SG2, B 5244 SG2, B 5244 SG2	2435	23x142; : → 3188688	SK-1491	BTK			
2.4 D	05/05-08/07	D 5244 T7	2400	28x132	SK-1608	BTK			
2.4 D	05/05-08/07	D 5244 T7	2400	28x132	SK-1608AQ1	BTKW			
2.4 D, 2.4 D5, 2.4 D5 AWD	08/01-08/07	D 5244 T, D 5244 T2, D 5244 T5, D 5244 T, D 5244 T5, D 5244 T2, D 5244 T4	2401	28x132	SK-1608	BTK			
2.4 D, 2.4 D5, 2.4 D5 AWD	08/01-08/07	D 5244 T, D 5244 T2, D 5244 T5, D 5244 T, D 5244 T5, D 5244 T2, D 5244 T4	2401	28x132	SK-1608AQ1	BTKW			
2.4 T, 2.4 T AWD	03/00-08/03	B 5244 T3	2435	23x142; : 1266128 →	SK-1491	BTK			
2.4 T5	04/04-08/07	B 5244 T5	2401	23x142; 02/2006 →; : → 3188688	SK-1491	BTK			
2.4 T5	04/04-08/07	B 5244 T5	2401	23x142; : 3188688	SK-1491AQ1	BTKW			
2.4 T5	04/04-08/07	B 5244 T5	2401	23x142; : 3188689 →	SK-1492	BTK			
2.4 T5	04/04-08/07	B 5244 T5	2401	23x142; : 3188689 →	SK-1492AQ1	BTKW			
2.4, 2.4 AWD	03/00-09/03	B 5254 S	2435	23x142	SK-1491	BTK			
2.4, 2.4 AWD	03/00-09/03	B 5254 S	2435	23x142; : → 3192745	SK-1491AQ1	BTKW			
2.4, 2.4 AWD	03/00-09/03	B 5254 S	2435	23x142; : 3192746 →	SK-1492	BTK			
2.4, 2.4 AWD	03/00-09/03	B 5254 S	2435	23x142; : 3192746 →	SK-1492AQ1	BTKW			
2.4, 2.4 Bifuel, 2.4 Bifuel (LPG), 2.4 T, 2.4 T AWD	03/00-08/07	B 5244 S, B 5244 S2, B 5244 SG, B 5244 SG2, B 5244 SG2, B 5244 SG2, B 5244 T3	2435	23x142; : → 3188688	SK-1491AQ1	BTKW			
2.4, 2.4 Bifuel, 2.4 Bifuel (LPG), 2.4 T, 2.4 T AWD	03/00-08/07	B 5244 S, B 5244 S2, B 5244 SG, B 5244 SG2, B 5244 SG2, B 5244 SG2, B 5244 T3	2435	23x142; : 3188689 →	SK-1492	BTK			
2.4, 2.4 Bifuel, 2.4 Bifuel (LPG), 2.4 T, 2.4 T AWD	03/00-08/07	B 5244 S, B 5244 S2, B 5244 SG, B 5244 SG2, B 5244 SG2, B 5244 SG2, B 5244 T3	2435	23x142; : 3188689 →	SK-1492AQ1	BTKW			
2.5 T, 2.5 T AWD	09/02-08/07	B 5254 T2	2521	23x142; : → 3188688	SK-1491AQ1	BTKW			
2.5 T, 2.5 T AWD, R 2.5 T AWD	09/02-08/07	B 5254 T2, B 5254 T4	2521	23x142; : → 3188688	SK-1491	BTK			
2.5 T, 2.5 T AWD, R 2.5 T AWD	09/02-08/07	B 5254 T2, B 5254 T4	2521	23x142; : 3188689 →	SK-1492	BTK			
2.5 T, 2.5 T AWD, R 2.5 T AWD	09/02-08/07	B 5254 T2, B 5254 T4	2521	23x142; : 3188689 →	SK-1492AQ1	BTKW			
2.5 TDI	03/00-08/07	D 5252 T	2461	25.4x120	SK-1526AQ2	BTKW			
2.5 TDI	03/00-08/07	D 5252 T	2461	26.5x122; 21x81; mit Zubehör	SK-1529	BTK			
2.5 TDI	03/00-08/07	D 5252 T	2461	26.5x122; mit Zubehör	SK-1725	BTK			

CM³

Art. Nr.



ohne Halter

V70 II (SW)

2.0 T	07/01-08/07	B 5204 T5	1984	:3188689→	0-N1324	TB [TE]	
2.0 T	07/01-08/07	B 5204 T5	1984	:→3188688	0-N137	TB [TE]	
2.0 T	07/01-08/07	B 5204 T5	1984		0-N958	TB [DG]	
2.3, 2.3 AWD, 2.3 T5	03/00-09/04	B 5234 T3, B 5234 T4, B 5234 T7, B 5234 T7, B 5234 T8	2319	:3188689→	0-N1324	TB [TE]	
2.3, 2.3 AWD, 2.3 T5	03/00-09/04	B 5234 T3, B 5234 T4, B 5234 T7, B 5234 T7, B 5234 T8	2319	:→3188688	0-N137	TB [TE]	
2.3, 2.3 AWD, 2.3 T5	03/00-09/04	B 5234 T3, B 5234 T4, B 5234 T7, B 5234 T7, B 5234 T8	2319		0-N958	TB [DG]	
2.4 D	05/05-08/07	D 5244 T7	2400		0-N1349	TB [TE]	
2.4 D	05/05-08/07	D 5244 T7	2400		0-N1350	TB [DG]	
2.4 D, 2.4 D5, 2.4 D5 AWD	08/01-08/07	D 5244 T, D 5244 T2, D 5244 T5, D 5244 T, D 5244 T5, D 5244 T2, D 5244 T4	2401		0-N1349	TB [TE]	
2.4 D, 2.4 D5, 2.4 D5 AWD	08/01-08/07	D 5244 T, D 5244 T2, D 5244 T5, D 5244 T, D 5244 T5, D 5244 T2, D 5244 T4	2401		0-N1350	TB [DG]	
2.4 T5	04/04-08/07	B 5244 T5	2401	:3188689→	0-N1324	TB [TE]	
2.4 T5	04/04-08/07	B 5244 T5	2401	:→3188688	0-N137	TB [TE]	
2.4 T5	04/04-08/07	B 5244 T5	2401		0-N958	TB [DG]	
2.4, 2.4 AWD, 2.4 Bifuel, 2.4 T, 2.4 T AWD	03/00-08/07	B 5244 S, B 5244 S2, B 5244 SG, B 5244 SG2, B 5244 T3, B 5254 S	2435	:3188689→	0-N1324	TB [TE]	
2.4, 2.4 AWD, 2.4 Bifuel, 2.4 T, 2.4 T AWD	03/00-08/07	B 5244 S, B 5244 S2, B 5244 SG, B 5244 SG2, B 5244 T3, B 5254 S	2435	:→3188688	0-N137	TB [TE]	
2.4, 2.4 AWD, 2.4 Bifuel, 2.4 T, 2.4 T AWD	03/00-08/07	B 5244 S, B 5244 S2, B 5244 SG, B 5244 SG2, B 5244 T3, B 5254 S	2435		0-N958	TB [DG]	
2.5 R Sport, 2.5 T, 2.5 T AWD, R 2.5 T AWD	09/02-08/07	B 5254 T2, B 5254 T4	2521	:3188689→	0-N1324	TB [TE]	
2.5 R Sport, 2.5 T, 2.5 T AWD, R 2.5 T AWD	09/02-08/07	B 5254 T2, B 5254 T4	2521	:→3188688	0-N137	TB [TE]	
2.5 R Sport, 2.5 T, 2.5 T AWD, R 2.5 T AWD	09/02-08/07	B 5254 T2, B 5254 T4	2521		0-N958	TB [DG]	
2.5 TDI	03/00-08/07	D 5252 T	2461		0-N110	TB [TE]	
2.5 TDI	03/00-08/07	D 5252 T	2461		0-N116	TB [TE]	
2.5 TDI	03/00-08/07	D 5252 T	2461		0-N117	TB [TE]	
2.0 T	07/01-08/07	B 5204 T5	1984		0-N1529	VB [BT]	S
2.0 T	07/01-08/07	B 5204 T5	1984	Rippenanzahl: 6;	0-N1647	VB [DG]	
2.3 T5	03/00-08/04	B 5234 T3, B 5234 T4	2319		0-N1529	VB [BT]	S
2.3 T5	03/00-08/04	B 5234 T3, B 5234 T4	2319	Rippenanzahl: 6;	0-N1647	VB [DG]	
2.4 D	05/05-08/07	D 5244 T7	2400	:→349808	0-N1450	VB [DG]	
2.4 D	05/05-08/07	D 5244 T7	2400	:→349808	0-N1451	VB [DG]	
2.4 D	05/05-08/07	D 5244 T7	2400	:→349808	0-N1491S	VB [TE]	
2.4 D	05/05-08/07	D 5244 T7	2400	Rippenanzahl: 6;	0-N1647	VB [DG]	
2.4 D	05/05-08/07	D 5244 T7	2400	:349809→	0-N1979	VB [BT]	S
2.4 D, 2.4 D5, 2.4 D5 AWD	08/01-08/07	D 5244 T, D 5244 T2, D 5244 T5, D 5244 T, D 5244 T5, D 5244 T2, D 5244 T4	2401	:→349808	0-N1450	VB [DG]	
2.4 D, 2.4 D5, 2.4 D5 AWD	08/01-08/07	D 5244 T, D 5244 T2, D 5244 T5, D 5244 T, D 5244 T5, D 5244 T2, D 5244 T4	2401	:→349808	0-N1451	VB [DG]	
2.4 D, 2.4 D5, 2.4 D5 AWD	08/01-08/07	D 5244 T, D 5244 T2, D 5244 T5, D 5244 T, D 5244 T5, D 5244 T2, D 5244 T4	2401	:→349808	0-N1491S	VB [TE]	
2.4 D, 2.4 D5, 2.4 D5 AWD, 2.4 T5	08/01-08/07	B 5244 T5, D 5244 T, D 5244 T2, D 5244 T5, D 5244 T, D 5244 T5, D 5244 T2, D 5244 T4	2401	Rippenanzahl: 6;	0-N1647	VB [DG]	
2.4 D, 2.4 D5, 2.4 D5 AWD, 2.4 T5	08/01-08/07	B 5244 T5, D 5244 T, D 5244 T2, D 5244 T5, D 5244 T, D 5244 T5, D 5244 T2, D 5244 T4	2401	:349809→	0-N1979	VB [BT]	S
2.4 T, 2.4 T AWD	03/00-08/03	B 5244 T3	2435	:349809→	0-N1979	VB [BT]	S
2.4 T5	04/04-08/07	B 5244 T5	2401		0-N1529	VB [BT]	S
2.4, 2.4 Bifuel, 2.4 T, 2.4 T AWD	03/00-08/07	B 5244 S, B 5244 S2, B 5244 SG, B 5244 SG2, B 5244 T3	2435		0-N1529	VB [BT]	S
2.4, 2.4 Bifuel, 2.4 T, 2.4 T AWD	03/00-08/07	B 5244 S, B 5244 S2, B 5244 SG, B 5244 SG2, B 5244 T3	2435	Rippenanzahl: 6;	0-N1647	VB [DG]	
2.5 T, 2.5 T AWD, R 2.5 T AWD	09/02-08/07	B 5254 T2, B 5254 T4	2521		0-N1529	VB [BT]	S
2.5 T, 2.5 T AWD, R 2.5 T AWD	09/02-08/07	B 5254 T2, B 5254 T4	2521	Rippenanzahl: 6;	0-N1647	VB [DG]	
2.5 TDI	03/00-08/07	D 5252 T	2461		0-N1424	VB [DG]	
2.5 TDI	03/00-08/07	D 5252 T	2461		0-N1953	VB [BT]	S

V70 III (BW)

1.6 D	01/10-	D 4164 T	1560	25x137	SK-1424	BTK	
1.6 D	01/10-	D 4164 T	1560	25x137	SK-1424AQ1	BTKW	
1.6 DRiVe	06/11-	D 4162 T	1560	25x141	SK-1728	BTK	
1.6 DRiVe	06/11-	D 4162 T	1560	25x141	SK-1728AQ1	BTKW	
2.0 BiFuel	03/13-	B 5204 T9	1984	23x142	SK-1492	BTK	

CM³

Art. Nr.



ohne Halter

V70 III (BW)							
2.0 BiFuel	03/13-	B 5204 T9	1984	23x142		SK-1492AQ1	BTKW
2.0 D	10/07-	D 4204 T	1997	25.4x116; Baumuster: BW		SK-1594	BTK
2.0 D	10/07-	D 4204 T	1997	25.4x116		SK-1594AQ1	BTKW
2.4 D, D5, D5 AWD	08/07-	D 5244 T10, D 5244 T14, D 5244 T4, D 5244 T5	2400	28x132		SK-1608	BTK
2.4 D, D5, D5 AWD	08/07-	D 5244 T11, D 5244 T15, D 5244 T4, D 5244 T5	2400	28x132		SK-1608AQ1	BTKW
2.5 T, 2.5 T FlexiFuel	08/07-	B 5254 T10, B 5254 T11, B 5254 T6, B 5254 T8	2521	23x142		SK-1666	BTK
2.5 T, 2.5 T FlexiFuel	08/07-	B 5254 T10, B 5254 T11, B 5254 T6, B 5254 T8	2521	23x142		SK-1666AQ1	BTKW
D3	03/10-	D 5204 T2, D 5204 T3	1984	28x132; → 12/2011		SK-1608	BTK
D4 AWD, D5, D5 AWD	06/11-	D 5244 T11, D 5244 T15, D 5244 T17	2400	28x132; → 1046801		SK-1608	BTK
1.6 D	01/10-	D 4164 T	1560			0-N1062	TB [TE]
1.6 D	01/10-	D 4164 T	1560			0-N1066	TB [DG]
1.6 DRIVe	06/11-	D 4162 T	1560			0-N2224	TB [TE]
1.6 DRIVe	06/11-	D 4162 T	1560			0-N2382	TB [DG]
1.6 T4F, T4	10/10-	B 4164 T, B 4164 T2	1596			0-N2057	TB [TE]
2.0 D	10/07-	D 4204 T	1997			0-N1334	TB [DG]
2.4 D, D5, D5 AWD	08/07-	D 5244 T10, D 5244 T11, D 5244 T15, D 5244 T14, D 5244 T4, D 5244 T5	2400			0-N1349	TB [TE]
2.4 D, D5, D5 AWD	08/07-	D 5244 T10, D 5244 T11, D 5244 T15, D 5244 T14, D 5244 T4, D 5244 T5	2400			0-N1350	TB [DG]
2.5 T, 2.5 T FlexiFuel	08/07-	B 5254 T10, B 5254 T11, B 5254 T6, B 5254 T8	2521			0-N958	TB [DG]
D3	03/10-	D 5204 T2, D 5204 T3	1984			0-N1349	TB [TE]
D3	03/10-	D 5204 T2, D 5204 T3	1984			0-N1350	TB [DG]
1.6 D	01/10-	D 4164 T	1560	ch. → 147629		0-N1339	VB [BT] S
1.6 T4F, T4	10/10-	B 4164 T, B 4164 T2	1596			0-N2269	VB [BT] S
1.6 T4F, T4	10/10-	B 4164 T, B 4164 T2	1596			0-N2363	VB [DG]
2.0 D	10/07-	D 4204 T	1997			0-N1327	VB [BT]
2.0 D	10/07-	D 4204 T	1997			0-N1991	VB [DG]
2.0 D	10/07-	D 4204 T	1997			0-N2042	VB [BT] S
2.0, 2.0 FlexiFuel	10/07-	B 4204 S3, B 4204 S4	1999	Rippenanzahl: 6		0-N1497	VB [BT] S
2.0, 2.0 FlexiFuel	10/07-	B 4204 S3, B 4204 S4	1999			0-N1991	VB [DG]
2.4 D, D5, D5 AWD	08/07-	D 5244 T10, D 5244 T14, D 5244 T4, D 5244 T5	2400	: → 884797		0-N1964	VB [BT] S
2.4 D, D5, D5 AWD	08/07-	D 5244 T10, D 5244 T11, D 5244 T15, D 5244 T14, D 5244 T4, D 5244 T5	2400	: 884798 →		0-N2204	VB [BT] S
2.5 T, 2.5 T FlexiFuel	08/07-	B 5254 T10, B 5254 T11, B 5254 T6, B 5254 T8	2521			0-N1964	VB [BT] S
3.2, 3.2 AWD	08/07-	B 6324 S, B 6324 S5	3192			0-N2242	VB [BT] S
3.2, 3.2 AWD	08/07-	B 6324 S, B 6324 S5	3192			0-N2243	VB [DG]
D3	03/10-	D 5204 T2, D 5204 T3	1984	: → 884797		0-N1964	VB [BT] S
D3	03/10-	D 5204 T7	1984	: 1046802 →		0-N1964	VB [BT] S
D3	03/10-	D5204T3	1984	: → 1046801		0-N2204	VB [BT] S
D3	03/10-	D5204T2	1984	: 884798 →		0-N2204	VB [BT] S
D5, D5 AWD	06/11-	D 5244 T11, D 5244 T15	2400	: → 1046801		0-N1964	VB [BT] S
T6 AWD	08/07-	B 6304 T2, B 6304 T4	2953			0-N2242	VB [BT] S
T6 AWD	08/07-	B 6304 T2, B 6304 T4	2953			0-N2243	VB [DG]
V90 Kombi							
2.5	11/96-10/98	B 6244 FS, B 6254 FS	2473	28x152; mit Zubehör		SK-1265	BTK
2.9	01/97-12/98	B 6304 G, B 6304 S2	2922	28x152; mit Zubehör		SK-1265	BTK
2.9	01/97-12/98	B 6304 G, B 6304 S2	2922			0-N172	TB [DG]
2.9	01/97-12/98	B 6304 G, B 6304 S2	2922			0-N959	TB [TE]
2.9	01/97-12/98	B 6304 G, B 6304 S2	2922			0-N1308	VB [TE]
2.9	01/97-12/98	B 6304 G, B 6304 S2	2922			0-N1406	VB [DG]
XC60							
2.4 D AWD, D5 AWD	05/08-	D 5244 T11, D 5244 T15, D 5244 T16, D 5244 T17, D 5244 T5, D 5244 T4	2400	28x132		SK-1608AQ1	BTKW
2.4 D, 2.4 D AWD, D5 AWD	05/08-06/11	D 5244 T10, D 5244 T11, D 5244 T15, D 5244 T14, D 5244 T16, D 5244 T17, D 5244 T5, D 5244 T4	2400	28x132		SK-1608	BTK
D3	03/10-	D 5204 T2, D 5204 T3	1984	28x132; → 12/2011		SK-1608	BTK
T5 AWD	04/14-	B 5254 T12	2497	23x142		SK-1492	BTK
T5 AWD	04/14-	B 5254 T12	2497	23x142		SK-1492AQ1	BTKW



OPTIMAL®

VOLVO



CM³



Art. Nr.



XC60

2.4 D, 2.4 D AWD, D5, D5 AWD	05/08-06/11	D 5244 T10, D 5244 T11, D 5244 T15, D 5244 T14, D 5244 T15, D 5244 T15, D 5244 T16, D 5244 T17, D 5244 T5, D 5244 T4	2400		0-N1349	TB [TE]	
2.4 D, 2.4 D AWD, D5, D5 AWD	05/08-06/11	D 5244 T10, D 5244 T11, D 5244 T15, D 5244 T14, D 5244 T15, D 5244 T15, D 5244 T16, D 5244 T17, D 5244 T5, D 5244 T4	2400		0-N1350	TB [DG]	
D3	03/10-	D 5204 T2, D 5204 T3	1984		0-N1349	TB [TE]	
D3	03/10-	D 5204 T2, D 5204 T3	1984		0-N1350	TB [DG]	
2.4 D, 2.4 D AWD, D5 AWD	05/08-06/11	D 5244 T10, D 5244 T14, D 5244 T16, D 5244 T17, D 5244 T5, D 5244 T4	2400	:→884797	0-N1964	VB [BT]	S
2.4 D, 2.4 D AWD, D5 AWD	05/08-06/11	D 5244 T10, D 5244 T14, D 5244 T16, D 5244 T17, D 5244 T5, D 5244 T4	2400	:884798→	0-N2204	VB [BT]	S
3.2 AWD	07/09-	B 6324 S, B 6324 S5	3192		0-N2242	VB [BT]	S
3.2 AWD	07/09-	B 6324 S, B 6324 S5	3192		0-N2243	VB [DG]	
D3	03/10-	D5204T2	1984	:→884797	0-N1964	VB [BT]	S
D3	03/10-	D5204T3	1984	:→1046801	0-N2204	VB [BT]	S
D3	03/10-	D5204T2	1984	:884798→	0-N2204	VB [BT]	S
D3	04/12-	D 5204 T7	1984	:1046802→	0-N1964	VB [BT]	S
D5, D5 AWD	06/11-	D 5244 T11, D 5244 T15, D 5244 T15, D 5244 T15	2400	:1046802→	0-N1964	VB [BT]	S
D5, D5 AWD	06/11-	D 5244 T11, D 5244 T15, D 5244 T15, D 5244 T15	2400	:→1046801	0-N2204	VB [BT]	S
T6 AWD	05/08-	B 6304 T2, B 6304 T3, B 6304 T4, B 6304 T4	2953		0-N2242	VB [BT]	S
T6 AWD	05/08-	B 6304 T2, B 6304 T3, B 6304 T4, B 6304 T4	2953		0-N2243	VB [DG]	

XC60 [USA]

3.2 AWD	01/10-12/10		3192		0-N2242	VB [BT]	S
3.2 AWD	01/10-12/10		3192		0-N2243	VB [DG]	

XC70 CROSS COUNTRY

2.4 D5 AWD	12/05-08/07	D 5244 T4	2401	28x132	SK-1608AQ1	BTKW	
2.4 D5 AWD, 2.4 D5 XC AWD	09/02-08/07	D 5244 T, D 5244 T4	2401	28x132	SK-1608	BTK	
2.4 D5 XC AWD	09/02-08/07	D 5244 T	2401	28x132; → 08/2005	SK-1608AQ1	BTKW	
2.4 T XC AWD	11/97-09/02	B 5254 T	2435	23x148; :→1266127; mit Zubehör; Spannrollenbetätigung: hydraulisch	SK-1103	BTK	
2.4 T XC AWD	11/97-09/02	B 5254 T	2435	23x148; :→1266127; mit Zubehör; Spannrollenbetätigung: hydraulisch	SK-1103AQ1	BTKW	
2.4 T XC AWD	11/97-09/02	B 5254 T	2435	23x142; :1266128→	SK-1491	BTK	
2.4 T XC AWD	11/97-09/02	B 5254 T	2435	23x142; :1266128→; :→3192745; Spannrollenbetätigung: mechanisch	SK-1491AQ1	BTKW	
2.4 T XC AWD	11/97-09/02	B 5254 T	2435	23x142; :3192746→	SK-1492	BTK	
2.4 T XC AWD	11/97-09/02	B 5254 T	2435	23x142; :3192746→	SK-1492AQ1	BTKW	
2.4 T XC AWD	03/00-09/02	B 5244 T3	2435	23x142; 10/2000 →	SK-1491	BTK	
2.4 T XC AWD	03/00-09/02	B 5244 T3	2435	23x142; :→3188688	SK-1491AQ1	BTKW	
2.4 T XC AWD	03/00-09/02	B 5244 T3	2435	23x142; :3188689→	SK-1492	BTK	
2.4 T XC AWD	03/00-09/02	B 5244 T3	2435	23x142; :3188689→	SK-1492AQ1	BTKW	
2.5 T XC AWD	09/02-08/07	B 5254 T2	2521	23x142; 07/2003 →	SK-1491	BTK	
2.5 T XC AWD	09/02-08/07	B 5254 T2	2521	23x142; :→3188688	SK-1491	BTK	
2.5 T XC AWD	09/02-08/07	B 5254 T2	2521	23x142; :→3188688	SK-1491AQ1	BTKW	
2.5 T XC AWD	09/02-08/07	B 5254 T2	2521	23x142; :3188689→	SK-1492	BTK	
2.5 T XC AWD	09/02-08/07	B 5254 T2	2521	23x142; :3188689→	SK-1492AQ1	BTKW	
2.4 AWD, 2.4 T XC AWD	11/97-09/03	B 5244 T3, B 5254 T	2435		0-N958	TB [DG]	
2.4 AWD, 2.4 T XC AWD	03/00-09/03	B 5244 T3	2435	:3188689→	0-N1324	TB [TE]	
2.4 AWD, 2.4 T XC AWD	03/00-09/03	B 5244 T3	2435	:→3188688	0-N137	TB [TE]	
2.4 D5 AWD, 2.4 D5 XC AWD	09/02-08/07	D 5244 T, D 5244 T4	2401		0-N1349	TB [TE]	
2.4 D5 AWD, 2.4 D5 XC AWD	09/02-08/07	D 5244 T, D 5244 T4	2401		0-N1350	TB [DG]	
2.4 T XC AWD	11/97-09/02	B 5254 T	2435	:3192746→	0-N1324	TB [TE]	
2.4 T XC AWD	11/97-09/02	B 5254 T	2435	:→3192745	0-N137	TB [TE]	
2.4 T XC AWD	11/97-09/02	B 5254 T	2435	:→1266127	0-N930	TB [TE]	
2.5 T XC AWD	09/02-08/07	B 5254 T2	2521	:3188689→	0-N1324	TB [TE]	
2.5 T XC AWD	09/02-08/07	B 5254 T2	2521	:→3188688	0-N137	TB [TE]	
2.5 T XC AWD	09/02-08/07	B 5254 T2	2521		0-N958	TB [DG]	
2.4 D5 AWD, 2.4 D5 XC AWD	09/02-08/07	D 5244 T, D 5244 T4	2401	:→349808	0-N1450	VB [DG]	
2.4 D5 AWD, 2.4 D5 XC AWD	09/02-08/07	D 5244 T, D 5244 T4	2401	:→349808	0-N1451	VB [DG]	
2.4 D5 AWD, 2.4 D5 XC AWD	09/02-08/07	D 5244 T, D 5244 T4	2401	:→349808	0-N1491S	VB [TE]	
2.4 D5 AWD, 2.4 D5 XC AWD	09/02-08/07	D 5244 T, D 5244 T4	2401	Rippenanzahl: 6;	0-N1647	VB [DG]	
2.4 D5 AWD, 2.4 D5 XC AWD	09/02-08/07	D 5244 T, D 5244 T4	2401	:349809→	0-N1979	VB [BT]	S
2.4 T XC AWD	11/97-09/02	B 5254 T	2435		0-N1308	VB [TE]	

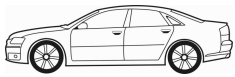

CM³



Art. Nr.



XC70 CROSS COUNTRY

2.4 T XC AWD	11/97-09/02	B 5254 T	2435		0-N143	VB [DG]	
2.4 T XC AWD	11/97-09/02	B 5254 T	2435		0-N1518	VB [BT]	S
2.4 T XC AWD	11/97-09/02	B 5254 T	2435		0-N2223	VB [VD]	
2.4 T XC AWD	03/00-09/02	B 5244 T3	2435		0-N1529	VB [BT]	S
2.4 T XC AWD	03/00-09/02	B 5244 T3	2435	Rippenanzahl: 6;	0-N1647	VB [DG]	
2.5 T XC AWD	09/02-08/07	B 5254 T2	2521		0-N1529	VB [BT]	S
2.5 T XC AWD	09/02-08/07	B 5254 T2	2521	Rippenanzahl: 6;	0-N1647	VB [DG]	

XC70 II

2.4 D AWD, D5 AWD	08/07-	D 5244 T11, D 5244 T15, D 5244 T16, D 5244 T17, D 5244 T5, D 5244 T4	2400	28x132		SK-1608AQ1	BTKW
2.4 D, 2.4 D AWD, D5 AWD	08/07-	D 5244 T10, D 5244 T11, D 5244 T15, D 5244 T14, D 5244 T16, D 5244 T17, D 5244 T5, D 5244 T4	2400	28x132		SK-1608	BTK
D3, D3 AWD	08/11-	D 5204 T2, D 5204 T2, D 5204 T3	1984	28x132; → 12/2011		SK-1608	BTK
2.4 D, 2.4 D AWD, D5 AWD	08/07-	D 5244 T10, D 5244 T11, D 5244 T15, D 5244 T14, D 5244 T16, D 5244 T17, D 5244 T5, D 5244 T4	2400			0-N1349	TB [TE]
2.4 D, 2.4 D AWD, D5 AWD	08/07-	D 5244 T10, D 5244 T11, D 5244 T15, D 5244 T14, D 5244 T16, D 5244 T17, D 5244 T5, D 5244 T4	2400			0-N1350	TB [DG]
D3, D3 AWD	08/11-	D 5204 T2, D 5204 T2, D 5204 T3	1984			0-N1349	TB [TE]
D3, D3 AWD	08/11-	D 5204 T2, D 5204 T2, D 5204 T3	1984			0-N1350	TB [DG]
2.4 D, 2.4 D AWD, D5 AWD	08/07-	D 5244 T10, D 5244 T14, D 5244 T16, D 5244 T17, D 5244 T5, D 5244 T4	2400	:→884797		0-N1964	VB [BT] S
2.4 D, 2.4 D AWD, D5 AWD	08/07-	D 5244 T11, D 5244 T15, D 5244 T14, D 5244 T16, D 5244 T17, D 5244 T5	2400	:884798 →		0-N2204	VB [BT] S
3.2, 3.2 AWD	08/07-	B 6324 S, B 6324 S5	3192			0-N2242	VB [BT] S
3.2, 3.2 AWD	08/07-	B 6324 S, B 6324 S5	3192			0-N2243	VB [DG]
D3	08/11-	D5204T3	1984	:→1046801		0-N2204	VB [BT] S
D3	08/11-	D5204T2	1984	:884798 →		0-N2204	VB [BT] S
D3 AWD	08/11-	D 5204 T2	1984	:884798 →		0-N2204	VB [BT] S
D3, D3 AWD	08/11-	D 5204 T2, D 5204 T2, D 5204 T3	1984	:→884797		0-N1964	VB [BT] S
D5 AWD	08/07-	D 5244 T10, D 5244 T4	2400			0-N2204	VB [BT] S
D5 AWD	06/11-	D 5244 T11, D 5244 T15	2400			0-N1964	VB [BT] S
T6 AWD	01/08-	B 6304 T2, B 6304 T4	2953			0-N2242	VB [BT] S
T6 AWD	01/08-	B 6304 T2, B 6304 T4	2953			0-N2243	VB [DG]

XC90 I

2.5 T	10/02-	B 5254 T2	2521	23x142; :→3188688		SK-1491	BTK
2.5 T	10/02-	B 5254 T2	2521	23x142; :→3188688		SK-1491AQ1	BTKW
2.5 T	10/02-	B 5254 T2	2521	23x142; :3188689 →		SK-1492	BTK
2.5 T	10/02-	B 5254 T2	2521	23x142; :3188689 →		SK-1492AQ1	BTKW
D5	10/02-	D 5244 T, D 5244 T5, D 5244 T4	2401	28x132		SK-1608	BTK
D5	10/02-	D 5244 T, D 5244 T5, D 5244 T4	2401	28x132		SK-1608AQ1	BTKW
D5	04/09-	D 5244 T18, D 5244 T5	2400	28x132		SK-1608	BTK
D5	04/09-	D 5244 T18, D 5244 T5	2400	28x132		SK-1608AQ1	BTKW
T6	10/02-	B 6294 T	2922	28x146		SK-1747	BTK
2.5 T	10/02-	B 5254 T2	2521	:3188689 →		0-N1324	TB [TE]
2.5 T	10/02-	B 5254 T2	2521	:→3188688		0-N137	TB [TE]
2.5 T	10/02-	B 5254 T2	2521			0-N958	TB [DG]
D5	10/02-	D 5244 T, D 5244 T5, D 5244 T4	2401			0-N1349	TB [TE]
D5	10/02-	D 5244 T, D 5244 T5, D 5244 T4	2401			0-N1350	TB [DG]
D5	04/09-	D 5244 T18, D 5244 T5	2400			0-N1349	TB [TE]
D5	04/09-	D 5244 T18, D 5244 T5	2400			0-N1350	TB [DG]
T6	10/02-	B 6294 T	2922			0-N1350	TB [DG]
T6	10/02-	B 6294 T	2922			0-N1884	TB [BT]
2.5 T	10/02-	B 5254 T2	2521			0-N1529	VB [BT] S
2.5 T	10/02-	B 5254 T2	2521	Rippenanzahl: 6;		0-N1647	VB [DG]
3.2	05/06-	B 6324 S, B 6324 S5	3192			0-N2242	VB [BT] S
3.2	05/06-	B 6324 S, B 6324 S5	3192			0-N2243	VB [DG]
D5	10/02-	D 5244 T, D 5244 T5, D 5244 T4	2401	:→349808		0-N1450	VB [DG]
D5	10/02-	D 5244 T, D 5244 T5, D 5244 T4	2401	:→349808		0-N1451	VB [DG]
D5	10/02-	D 5244 T, D 5244 T5, D 5244 T4	2401	:→349808		0-N1491S	VB [TE]
D5	10/02-	D 5244 T, D 5244 T5, D 5244 T4	2401	Rippenanzahl: 6;		0-N1647	VB [DG]
D5	10/02-	D 5244 T, D 5244 T5, D 5244 T4	2401	:349809 →		0-N1979	VB [BT] S
D5	04/09-	D 5244 T5	2400	:→349808		0-N1450	VB [DG]
D5	04/09-	D 5244 T18, D 5244 T5	2400	:→349808		0-N1491S	VB [TE]
D5	04/09-	D 5244 T5	2400	Rippenanzahl: 6;		0-N1647	VB [DG]



OPTIMAL®

VOLVO

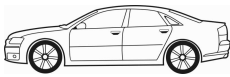

CM³



Art. Nr.



ohne Halter

XC90 I

D5	04/09-	D 5244 T18, D 5244 T5	2400	:349809→	0-N1979	VB [BT]	S
T6	10/02-	B 6294 T	2922		0-N1450	VB [DG]	
T6	10/02-	B 6294 T	2922		0-N1529	VB [BT]	S
T6	10/02-	B 6294 T	2922	Rippenanzahl: 6;	0-N1647	VB [DG]	

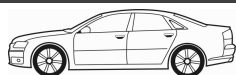

CM³



Art. Nr.



ohne Halter

AMAROK (2H_, S1B)							
2.0 BiTDI, 2.0 BiTDI 4motion	09/10-	CDCA	1968	25x160; → 11/2010	SK-1695	BTK	
2.0 BiTDI, 2.0 BiTDI 4motion	09/10-	CDCA	1968	25x160; → 11/2010	SK-1695AQ1	BTKW	
2.0 BiTDI, 2.0 BiTDI 4motion	09/10-	CDCA	1968	25x160; 12/2010 →	SK-1727	BTK	
2.0 BiTDI, 2.0 BiTDI 4motion	09/10-	CDCA	1968	25x160; → 11/2010	SK-1727AQ2	BTKW	
2.0 TDI, 2.0 TDI 4motion	09/10-	CDBA, CNFA	1968	25x160; → 02/2011	SK-1695	BTK	
2.0 TDI, 2.0 TDI 4motion	09/10-	CDBA, CNFA	1968	25x160; → 02/2011	SK-1695AQ1	BTKW	
2.0 TDI, 2.0 TDI 4motion	09/10-	CDBA, CNFA	1968	25x160; 02/2011 →	SK-1727	BTK	
2.0 TDI, 2.0 TDI 4motion	09/10-	CDBA	1968	25x160; → 11/2010	SK-1727AQ2	BTKW	
2.0 TDI, 2.0 TDI 4motion	11/11-	CNEA, CSHA, CNFB	1968	25x160	SK-1727	BTK	
2.0 BiTDI, 2.0 BiTDI 4motion, 2.0 TDI, 2.0 TDI 4motion	09/10-	CDBA, CNFA, CDCA, CNEA, CSHA, CNFB	1968		0-N131	TB [DG]	
2.0 BiTDI, 2.0 BiTDI 4motion, 2.0 TDI, 2.0 TDI 4motion	09/10-	CDBA, CNFA, CDCA	1968		0-N2025	TB [DG]	
2.0 BiTDI, 2.0 BiTDI 4motion, 2.0 TDI, 2.0 TDI 4motion	09/10-	CDBA, CNFA, CDCA, CNEA, CSHA	1968		0-N2200	TB [DG]	
2.0 BiTDI, 2.0 BiTDI 4motion, 2.0 TDI, 2.0 TDI 4motion	09/10-	CDBA, CNFA, CDCA, CNEA, CSHA	1968		0-N1534	VB [BT]	S
2.0 BiTDI, 2.0 BiTDI 4motion, 2.0 TDI, 2.0 TDI 4motion	09/10-	CDBA, CNFA, CDCA	1968		0-N1738	VB [DG]	
2.0 TDI, 2.0 TDI 4motion	06/12-	CNFB	1968	→ 01/2014; für OE: 038903315AH	0-N1534	VB [BT]	S
2.0 TDI, 2.0 TDI 4motion	06/12-	CNFB	1968	02/2014 →; für OE: 038903315AM	0-N1534	VB [BT]	S
2.0 TSI	12/10-	CFPA	1984		0-N2026	VB [TE]	S
2.0 TSI	12/10-	CFPA	1984		0-N2027	VB [DG]	
NEW BEETLE Cabriolet (1Y7)							
1.4	01/03-09/10	BCA	1390	20x130; 17x58; beinhaltete Rollen: 4	SK-1511	BTK	
1.4	01/03-09/10	BCA	1390	20x130; 17x58; beinhaltete Rollen: 4	SK-1511AQ1	BTKW	
1.6	01/03-09/10	BFS	1595	23x138; Baumuster: 1Y7	SK-1109	BTK	
1.6	01/03-09/10	BFS	1595	23x138	SK-1109AQ1	BTKW	
1.8 T	01/03-09/10	AWU, AWV, BKF	1781	23x150	SK-1660	BTK	
1.8 T	01/03-09/10	AWU, AWV, BKF	1781	23x150	SK-1660AQ1	BTKW	
1.8 T	01/03-09/10	AWU, AWV, BKF	1781	23x150	SK-1710	BTK	
1.9 TDI	06/03-09/10	AXR, BSW	1896	30x120; mit Zubehör	SK-1372	BTK	
1.9 TDI	06/03-09/10	AXR, BSW	1896	30x120	SK-1372AQ2	BTKW	
2.0	09/02-10/10	AZJ, BDC, BEV, BGD	1984	23x138; Baumuster: 1Y7	SK-1109	BTK	
2.0	09/02-10/10	AQY, AZJ, BDC, BDC, BEV, BGD, BGD, BGD	1984	23x138	SK-1109AQ2	BTKW	
1.4	01/03-09/10	BCA	1390		0-N1262	TB [DG]	
1.4	01/03-09/10	BCA	1390		0-N1263	TB [TE]	
1.4	01/03-09/10	BCA	1390		0-N158	TB [TE]	
1.4	01/03-09/10	BCA	1390		0-N164	TB [DG]	
1.6	01/03-09/10	BFS	1595		0-N157	TB [TE]	
1.8 T	01/03-09/10	AWU, AWV, BKF	1781		0-N1042	TB [TE]	
1.8 T	01/03-09/10	AWU, AWV, BKF	1781		0-N1237	TB [BT]	
1.8 T	01/03-09/10	AWU, AWV, BKF	1781		0-N1316	TB [DG]	
1.9 TDI	06/03-09/10	AXR, BSW	1896		0-N1045	TB [TE]	
1.9 TDI	06/03-09/10	AXR, BSW	1896		0-N1046	TB [DG]	
2.0	09/02-10/10	AQY, AZJ, BDC, BDC, BEV, BGD, BGD, BGD	1984		0-N157	TB [TE]	
1.4	01/03-09/10	BCA	1390	✳	0-N1445	VB [BT]	S
1.4	01/03-09/10	BCA	1390	✳	0-N1539	VB [BT]	S
1.9 TDI	06/03-09/10	AXR, BSW	1896		0-N1494	VB [BT]	S
2.5	07/05-09/10	BPR, BPS	2480		0-N1893	VB [BT]	S
BEETLE (5C1)							
1.6 TDI	10/11-	CAYC	1598	25x160	SK-1727	BTK	
1.6 TDI	10/11-	CAYC	1598	25x160	SK-1727AQ2	BTKW	
2.0 TDI	04/11-	CFFB, CJAA	1968	30x160	SK-1694	BTK	
2.0 TDI	04/11-	CJAA	1968	30x160; → 04/2012	SK-1694AQ1	BTKW	
2.0 TDI	04/11-	CJAA	1968	30x160; 05/2012 →	SK-1694AQ2	BTKW	
2.0 TDI	04/11-	CFFB	1968	25x160	SK-1695	BTK	
2.0 TDI	04/11-	CFFB	1968	25x160	SK-1727AQ2	BTKW	
1.6 TDI	10/11-	CAYC	1598		0-N131	TB [DG]	
1.6 TDI	10/11-	CAYC	1598		0-N2200	TB [DG]	
2.0 TDI	04/11-	CFFB, CJAA, CUUB, CVCA	1968		0-N131	TB [DG]	
2.0 TDI	04/11-	CFFB, CJAA	1968		0-N2200	TB [DG]	
2.0 TDI	07/14-	CUUB, CVCA	1968		0-N2314	TB [TE]	
1.2 TSI	07/11-	CBZB	1197	✳	0-N1733	VB [BT]	S

CM³

Art. Nr.



ohne Halter

BEETLE (5C1)

1.2 TSI	07/11-	CBZB	1197	✳	0-N2121	VB [DG]	
1.4 TSI	10/11-	CAVD, CNWA, CTHD, CTKA	1390		0-N2092	VB [BT]	S
1.4 TSI	10/11-	CAVD, CNWA, CTHD, CTKA	1390	✳	0-N2111	VB [BT]	S
1.6 TDI	10/11-	CAYC	1598		0-N1534	VB [BT]	S
2.0 TDI	04/11-	CFFB, CJAA	1968		0-N1534	VB [BT]	S
2.0 TSI	04/11-	CBFA, CCTA, CCZA	1984		0-N1832	VB [BT]	S
2.5	04/11-	CBTA, CBUA, CCCA	2480		0-N1893	VB [BT]	S

BEETLE Cabriolet (5C7)

1.6 TDI	12/11-	CAYC	1598	25x160	SK-1727	BTK	
1.6 TDI	12/11-	CAYC	1598	25x160	SK-1727AQ2	BTKW	
2.0 TDI	04/12-	CFFB	1968	25x160	SK-1695	BTK	
2.0 TDI	04/12-	CFFB	1968	25x160	SK-1727AQ2	BTKW	
1.6 TDI	12/11-	CAYC	1598		0-N131	TB [DG]	
2.0 TDI	04/12-	CFFB, CJAA, CUUB, CVCA, DELA	1968		0-N131	TB [DG]	
2.0 TDI	09/14-	CUUB, CVCA, DELA	1968		0-N2314	TB [TE]	
1.2 TSI	12/11-	CBZB, CYVD	1197	✳	0-N1733	VB [BT]	S
1.4 TSI	12/11-	CAVD, CNWA, CTHD, CTKA	1390		0-N2092	VB [BT]	S
1.4 TSI	12/11-	CAVD, CNWA, CTHD, CTKA	1390	✳	0-N2111	VB [BT]	S
1.6 TDI	12/11-	CAYC	1598		0-N1534	VB [BT]	S
2.0 TDI	04/12-	CFFB, CJAA	1968		0-N1534	VB [BT]	S

BORA (1J2)

1.4 16V	03/00-05/05	APE, AXP, BCA	1390	20x130; 17x58; beinhaltetete Rollen: 4	SK-1511	BTK	
1.4 16V	03/00-05/05	AHW	1390	20x130; 17x58; :160001→; beinhaltetete Rollen: 4	SK-1511	BTK	
1.4 16V	03/00-05/05	AKQ	1390	20x130; 17x58; :242001→; beinhaltetete Rollen: 4	SK-1511	BTK	
1.4 16V	03/00-05/05	APE, AXP, BCA	1390	20x130; 17x58; beinhaltetete Rollen: 4	SK-1511AQ1	BTKW	
1.4 16V	03/00-05/05	AHW	1390	20x130; 17x58; :AHW160001→; beinhaltetete Rollen: 4	SK-1511AQ1	BTKW	
1.4 16V	03/00-05/05	AKQ	1390	20x130; 17x58; :AKQ242001→; beinhaltetete Rollen: 4	SK-1511AQ1	BTKW	
1.4 16V	03/00-05/05	AKQ	1390	20x130; 17x58; → 05/2000; :→AKQ242000	SK-1585	BTK	
1.4 16V	03/00-05/05	AHW	1390	20x130; 17x58; :→AHW160000	SK-1585	BTK	
1.4 16V	03/00-05/05	AHW, AKQ	1390	20x130; 17x58; :→160000, 242000	SK-1585AQ1	BTKW	
1.6	10/98-05/05	AEH, AKL, APF	1595	23x138; Baumuster: 1J2	SK-1109	BTK	
1.6	10/98-05/05	AEH, AKL, APF	1595	23x138	SK-1109AQ1	BTKW	
1.6	08/00-05/05	AVU, BFQ	1595	23x138; Baumuster: 1J2	SK-1109	BTK	
1.6	08/00-05/05	AVU	1595	23x138	SK-1109AQ1	BTKW	
1.6 16V, 1.6 FSI	05/00-05/05	ATN, AUS, AZD, BCB, BAD	1598	20x130; 17x58; beinhaltetete Rollen: 4	SK-1511	BTK	
1.6 16V, 1.6 FSI	05/00-05/05	ATN, AUS, AZD, BCB, BAD	1598	20x130; 17x58; beinhaltetete Rollen: 4	SK-1511AQ2	BTKW	
1.8	10/98-05/05	AGN, BAF	1781	23x150; ch.→1J-Y-850000; 02/1999 →; mit Spanndämpfer, Spannrolle	SK-1337	BTK	
1.8	10/98-05/05	AGN, BAF	1781	23x150; ch.→1J-Y-850000; 02/1999 →; mit Spanndämpfer, Spannrolle	SK-1337AQ1	BTKW	
1.8	10/98-05/05	AGN, BAF	1781	23x150; ch.1J-Y-850001→; 02/1999 →	SK-1660	BTK	
1.8	10/98-05/05	AGN, BAF	1781	23x150; ch.1J-Y-850001→; 02/1999 →	SK-1660AQ1	BTKW	
1.8	10/98-05/05	AGN, BAF	1781	23x150; ch.→1J-Y-850000; 02/1999 →	SK-1709	BTK	
1.8	10/98-05/05	AGN, BAF	1781	23x150; ch.1J-Y-850001→; 02/1999 →	SK-1710	BTK	
1.8 4motion, 1.8 T	02/99-05/05	AGN, AUQ	1781	23x150; ch.→1J-Y-850000; mit Spanndämpfer, Spannrolle	SK-1337	BTK	
1.8 4motion, 1.8 T	02/99-05/05	AGN, AUQ	1781	23x150; ch.→1J-Y-850000; mit Spanndämpfer, Spannrolle	SK-1337AQ1	BTKW	
1.8 4motion, 1.8 T	02/99-05/05	AGN, AUQ	1781	23x150; ch.1J-Y-850001→	SK-1660	BTK	
1.8 4motion, 1.8 T	02/99-05/05	AGN, AUQ	1781	23x150; ch.1J-Y-850001→	SK-1660AQ1	BTKW	
1.8 4motion, 1.8 T	02/99-05/05	AGN, AUQ	1781	23x150; ch.→1J-Y-850000	SK-1709	BTK	
1.8 4motion, 1.8 T	02/99-05/05	AGN, AUQ	1781	23x150; ch.1J-Y-850001→	SK-1710	BTK	
1.8 T	05/00-05/05	AGU, AUM	1781	23x150; ch.→1J-Y-850000; mit Spanndämpfer, Spannrolle	SK-1337	BTK	
1.8 T	05/00-05/05	AGU, AUM	1781	23x150; ch.→1J-Y-850000; mit Spanndämpfer, Spannrolle	SK-1337AQ1	BTKW	
1.8 T	05/00-05/05	AGU, AUM	1781	23x150; ch.1J-Y-850001→	SK-1660	BTK	
1.8 T	05/00-05/05	AGU, AUM	1781	23x150; ch.1J-Y-850001→	SK-1660AQ1	BTKW	
1.8 T	05/00-05/05	AGU, AUM	1781	23x150; ch.→1J-Y-850000	SK-1709	BTK	
1.8 T	05/00-05/05	AGU, AUM	1781	23x150; ch.1J-Y-850001→	SK-1710	BTK	
1.9 SDI	10/98-05/05	AGP, AQM	1896	25x141; :→AGP400000, AQM030000; mit Zubehör	SK-1110	BTK	



CM³



Art. Nr.



ohne Halter

BORA (1J2)

1.9 SDI	10/98-05/05	AQM	1896	25x141; :→AQM030001→; :→AQM045000; mit Zubehör	SK-1111	BTK
1.9 SDI	10/98-05/05	AQM	1896	25x141; :→AQM030001→; :→AQM045000; mit Zubehör	SK-1111AQ1	BTKW
1.9 SDI	10/98-05/05	AGP, AQM	1896	25x141; :→AGP400001, AQM045001→; mit Zubehör	SK-1258	BTK
1.9 SDI	10/98-05/05	AGP	1896	25x141; :→AGP400001→; mit Zubehör	SK-1258AQ1	BTKW
1.9 SDI	10/98-05/05	AQM	1896	25x141; :→AQM045001→; mit Zubehör	SK-1258AQ1	BTKW
1.9 SDI	10/98-05/05	AGP	1896	25x141; :→AGP400000	SK-1259	BTK
1.9 SDI	10/98-05/05	AQM	1896	25x141; :→AQM030000	SK-1259	BTK
1.9 TDI	10/98-05/05	AGR	1896	25x141; :→AGR565000; mit Zubehör	SK-1111	BTK
1.9 TDI	10/98-05/05	ALH	1896	25x141; :→ALH500000; mit Zubehör;	SK-1111	BTK
1.9 TDI	10/98-06/01	AHF, ASV	1896	25x141; :→AHF006065; mit Zubehör	SK-1111	BTK
1.9 TDI	10/98-05/05	AGR	1896	25x141; :→AGR565000; mit Zubehör	SK-1111AQ1	BTKW
1.9 TDI	10/98-05/05	ALH	1896	25x141; :→ALH500000; mit Zubehör	SK-1111AQ1	BTKW
1.9 TDI	10/98-06/01	AHF, ASV	1896	25x141; :→AHF595000; mit Zubehör	SK-1111AQ1	BTKW
1.9 TDI	10/98-05/05	AGR, ALH	1896	25x141; :→AGR565001, ALH500001→; mit Zubehör	SK-1258	BTK
1.9 TDI	10/98-06/01	AHF, ASV	1896	25x141; :→AHF595001, ASV150001→; mit Zubehör	SK-1258	BTK
1.9 TDI	10/98-05/05	AGR	1896	25x141; :→AGR565001→; mit Zubehör	SK-1258AQ1	BTKW
1.9 TDI	10/98-05/05	ALH	1896	25x141; :→ALH500001→; mit Zubehör	SK-1258AQ1	BTKW
1.9 TDI	10/98-06/01	AHF, ASV	1896	25x141; :→AHF595001→; mit Zubehör	SK-1258AQ1	BTKW
1.9 TDI	09/00-05/05	ATD, AXR	1896	30x120; ch.1J-2-592783, 1J-2D352774→; :→AXR010001→; mit Zubehör	SK-1372	BTK
1.9 TDI	09/00-05/05	ATD, AXR	1896	30x120; ch.→1J-2-592782, 1J-2-D352773; mit Zubehör; Baumuster: 1J2	SK-1582	BTK
1.9 TDI	09/00-05/05	ATD, AXR	1896	30x120; ch.→1J-2-592782, 1J-2-D352773; mit Spanndämpfer, Spannrolle; mit Zubehör; Baumuster: 1J2	SK-1583	BTK
1.9 TDI 4motion	11/98-04/02	AGR	1896	25x141; :→AGR565000; mit Zubehör	SK-1111	BTK
1.9 TDI 4motion	11/98-04/02	AGR	1896	25x141; :→ALH500000; mit Zubehör;	SK-1111	BTK
1.9 TDI 4motion	11/98-04/02	AGR	1896	25x141; :→AGR565000; mit Zubehör	SK-1111AQ1	BTKW
1.9 TDI 4motion	11/98-04/02	AGR	1896	25x141; :→ALH500000; mit Zubehör	SK-1111AQ1	BTKW
1.9 TDI 4motion	11/98-04/02	AGR	1896	25x141; :→AGR565001, ALH500001→; mit Zubehör	SK-1258	BTK
1.9 TDI 4motion	11/98-04/02	AGR	1896	25x141; :→AGR565001→; mit Zubehör	SK-1258AQ1	BTKW
1.9 TDI 4motion	11/98-04/02	AGR	1896	25x141; :→ALH500001→; mit Zubehör	SK-1258AQ1	BTKW
1.9 TDI 4motion	09/00-05/05	ATD	1896	30x120; ch.→1J-2-592782, 1J-2-D352773; 05/2001 →; mit Zubehör; Baumuster: 1J2	SK-1582	BTK
1.9 TDI 4motion	09/00-05/05	ATD	1896	30x120; ch.→1J-2-592782, 1J-2-D352773; 05/2001 →; mit Spanndämpfer, Spannrolle; mit Zubehör; Baumuster: 1J2	SK-1583	BTK
1.9 TDI, 1.9 TDI 4motion	12/98-01/02	AUY	1896	30x120; ch.1J-2-592783, 1J-2D352774→; mit Zubehör	SK-1372	BTK
1.9 TDI, 1.9 TDI 4motion	12/98-01/02	AJM	1896	30x120; :→AJM185670; mit Spanndämpfer, Spannrolle; mit Zubehör; Baumuster: 1J2	SK-1378	BTK
1.9 TDI, 1.9 TDI 4motion	12/98-01/02	AJM	1896	30x120; :→AJM185670; mit Spanndämpfer, Spannrolle	SK-1378AQ1	BTKW
1.9 TDI, 1.9 TDI 4motion	12/98-01/02	AJM	1896	30x120; :→AJM185670; ohne Spanndämpfer, Spannrolle; mit Zubehör; Baumuster: 1J2	SK-1388	BTK
1.9 TDI, 1.9 TDI 4motion	12/98-01/02	AJM	1896	30x120; :→AJM185670; ohne Spanndämpfer, Spannrolle; mit Zubehör	SK-1388AQ1	BTKW
1.9 TDI, 1.9 TDI 4motion	12/98-01/02	AUY	1896	30x120; ch.→1J-2-592782, 1J-2-D352773; mit Zubehör	SK-1582	BTK
1.9 TDI, 1.9 TDI 4motion	12/98-01/02	AJM, AUY	1896	30x120; :→AJM185671→; mit Zubehör	SK-1582	BTK
1.9 TDI, 1.9 TDI 4motion	12/98-01/02	AUY	1896	30x120; ch.→1J2592782, 2D352773; ohne Spanndämpfer, Spannrolle; mit Zubehör	SK-1582AQ1	BTKW
1.9 TDI, 1.9 TDI 4motion	12/98-01/02	AJM, AUY	1896	30x120; :→AJM185671→; ohne Spanndämpfer, Spannrolle; mit Zubehör	SK-1582AQ1	BTKW
1.9 TDI, 1.9 TDI 4motion	12/98-01/02	AUY	1896	30x120; ch.→1J-2-592782, 1J-2-D352773; mit Spanndämpfer, Spannrolle; mit Zubehör	SK-1583	BTK
1.9 TDI, 1.9 TDI 4motion	12/98-01/02	AJM, AUY	1896	30x120; :→AJM185671→; mit Spanndämpfer, Spannrolle; mit Zubehör	SK-1583	BTK
1.9 TDI, 1.9 TDI 4motion	12/98-01/02	AUY	1896	30x120; ch.→1J2592782, 2D352773; mit Spanndämpfer, Spannrolle; mit Zubehör	SK-1583AQ1	BTKW
1.9 TDI, 1.9 TDI 4motion	12/98-01/02	AJM, AUY	1896	30x120; :→AJM185671→; mit Spanndämpfer, Spannrolle; mit Zubehör	SK-1583AQ1	BTKW
1.9 TDI, 1.9 TDI 4motion	05/00-05/05	ARL, ATD	1896	30x120; ch.1J-2-592783, 1J-2D352774→; mit Zubehör	SK-1372	BTK
1.9 TDI, 1.9 TDI 4motion	05/00-05/05	ARL	1896	30x120; ch.1J-2-592783, 1J-2D-352774→	SK-1372AQ3	BTKW



CM³



Art. Nr.



ohne Halter

BORA (1J2)

1.9 TDI, 1.9 TDI 4motion	05/00-05/05	ARL	1896	30x120; ch.→1J-2-592782, 1J-2-D352773; 09/2000 →; mit Zubehör; Baumuster: 1J2	SK-1582	BTK
1.9 TDI, 1.9 TDI 4motion	05/00-05/05	ARL	1896	30x120; ch.→1J-2-592782, 1J-2-D352773; 09/2000 →; mit Spanndämpfer, Spannrolle; mit Zubehör; Baumuster: 1J2	SK-1583	BTK
1.9 TDI, 1.9 TDI 4motion	09/00-05/05	ASZ, ATD, ATD, AXR	1896	30x120; ch.1J-2-592783, 1J-2D-352774→	SK-1372AQ2	BTKW
1.9 TDI, 1.9 TDI 4motion	09/00-05/05	ASZ, ATD, ATD, AXR	1896	30x120; ch.→1J2592782, 2D352773; ohne Spanndämpfer, Spannrolle; mit Zubehör	SK-1582AQ1	BTKW
1.9 TDI, 1.9 TDI 4motion	09/00-05/05	ASZ, ATD, ATD, AXR	1896	30x120; ch.→1J2592782, 2D352773; mit Spanndämpfer, Spannrolle; mit Zubehör	SK-1583AQ1	BTKW
1.9 TDI, 1.9 TDI 4motion	11/00-05/05	ASZ	1896	30x120; 01/2003 →; mit Zubehör	SK-1372	BTK
1.9 TDI, 1.9 TDI 4motion	11/00-05/05	ASZ	1896	30x120; ch.→1J-2-592782, 1J-2-D352773; 04/2001 →; mit Zubehör; Baumuster: 1J2	SK-1582	BTK
1.9 TDI, 1.9 TDI 4motion	11/00-05/05	ASZ	1896	30x120; ch.→1J-2-592782, 1J-2-D352773; 04/2001 →; mit Spanndämpfer, Spannrolle; mit Zubehör; Baumuster: 1J2	SK-1583	BTK
2.0	10/98-05/05	APK, AQY, AZG, AZJ	1984	23x138; Baumuster: 1J2	SK-1109	BTK
2.0 4motion	04/00-05/05	AZH, AZJ	1984	23x138; Baumuster: 1J2	SK-1109	BTK
2.0, 2.0 4motion	10/98-05/05	APK, AQY, AZG, AZH, AZJ, BBW, AZH, AZJ	1984	23x138	SK-1109AQ2	BTKW
1.4 16V	03/00-05/05	AHW, AKQ, APE, AXP, BCA	1390		0-N1262	TB [DG]
1.4 16V	03/00-05/05	APE, AXP, BCA	1390		0-N1263	TB [TE]
1.4 16V	03/00-05/05	AHW	1390	:160001→	0-N1263	TB [TE]
1.4 16V	03/00-05/05	AKQ	1390	:242001→	0-N1263	TB [TE]
1.4 16V	03/00-05/05	AHW, AKQ, APE, AXP, BCA	1390		0-N158	TB [TE]
1.4 16V	03/00-05/05	AHW	1390	:→160000	0-N159	TB [TE]
1.4 16V	03/00-05/05	AKQ	1390	:→242000	0-N159	TB [TE]
1.4 16V	03/00-05/05	AHW, AKQ, APE, AXP, BCA	1390		0-N164	TB [DG]
1.6	10/98-05/05	AEH, AKL, APF, AVU, BFQ, BJH, AWB	1595		0-N157	TB [TE]
1.6 16V, 1.6 FSI	05/00-05/05	ATN, AUS, AZD, BCB, BAD	1598		0-N1262	TB [DG]
1.6 16V, 1.6 FSI	05/00-05/05	ATN, AUS, AZD, BCB, BAD	1598		0-N1263	TB [TE]
1.6 16V, 1.6 FSI	05/00-05/05	ATN, AUS, AZD, BCB, BAD	1598		0-N158	TB [TE]
1.6 16V, 1.6 FSI	05/00-05/05	ATN, AUS, AZD, BCB, BAD	1598		0-N164	TB [DG]
1.8	10/98-05/05	AGN, BAF	1781	ch.1J-Y-850001→; 02/1999 →	0-N1042	TB [TE]
1.8	10/98-05/05	AGN, BAF	1781	ch.→1J-Y-850000; 02/1999 →	0-N1654	TB [TE]
1.8 4motion, 1.8 T	02/99-05/05	AGN, AUQ	1781	ch.1J-Y-850001→	0-N1042	TB [TE]
1.8 4motion, 1.8 T	02/99-05/05	AGN, AUQ	1781	ch.→1J-Y-850000	0-N1654	TB [TE]
1.8 T	05/00-05/05	AGU, AUM	1781	ch.1J-Y-850001→	0-N1042	TB [TE]
1.8 T	05/00-05/05	AGU, AUM	1781	ch.→1J-Y-850000	0-N1654	TB [TE]
1.8, 1.8 4motion, 1.8 T	10/98-05/05	AGN, AGN, BAF, AGU, ARX, AUM, BAE, AUQ	1781		0-N1237	TB [BT]
1.8, 1.8 4motion, 1.8 T	10/98-05/05	AGN, AGN, BAF, AGU, ARX, AUM, BAE, AUQ	1781		0-N1316	TB [DG]
1.9 SDI	10/98-05/05	AGP, AQM	1896		0-N107	TB [TE]
1.9 SDI	10/98-05/05	AQM	1896	:030000→	0-N167	TB [DG]
1.9 SDI	10/98-05/05	AGP	1896	:400000→	0-N167	TB [DG]
1.9 SDI, 1.9 TDI, 1.9 TDI 4motion	10/98-05/05	AGP, AQM, AGR, AGR, ALH, AHF, ASV	1896		0-N131	TB [DG]
1.9 SDI, 1.9 TDI, 1.9 TDI 4motion	10/98-05/05	AGP, AQM, AGR, AGR, ALH, AHF, ASV	1896		0-N166	TB [DG]
1.9 TDI	10/98-05/05	AGR, ALH	1896		0-N107	TB [TE]
1.9 TDI	10/98-06/01	AHF, ASV	1896		0-N107	TB [TE]
1.9 TDI	09/00-05/05	ATD	1896	ch.1J-2-525001, 1J-2D352774→	0-N1045	TB [TE]
1.9 TDI	09/00-05/05	AXR	1896	:010001→	0-N1045	TB [TE]
1.9 TDI	09/00-05/05	AXR	1896	:010001→	0-N1046	TB [DG]
1.9 TDI	09/00-05/05	ATD	1896	ch.→1J-2-525000, 1J-2-D352773	0-N1048	TB [TE]
1.9 TDI	09/00-05/05	AXR	1896	:→010000	0-N1048	TB [TE]
1.9 TDI	09/00-05/05	ATD	1896	ch.→1J-2-525000, 1J-2-D352773	0-N1268	TB [DG]
1.9 TDI	09/00-05/05	AXR	1896	:→010000	0-N1268	TB [DG]
1.9 TDI	09/00-05/05	ATD	1896	ch.→1J-2-525000, 1J-2-D352773	0-N1274	TB [BT]
1.9 TDI	09/00-05/05	AXR	1896	:→010000	0-N1274	TB [BT]
1.9 TDI 4motion	11/98-04/02	AGR	1896		0-N107	TB [TE]
1.9 TDI 4motion	09/00-05/05	ATD	1896	:010001→	0-N1045	TB [TE]
1.9 TDI 4motion	09/00-05/05	ATD	1896	:010001→	0-N1046	TB [DG]
1.9 TDI 4motion	09/00-05/05	ATD	1896	:→010000	0-N1048	TB [TE]
1.9 TDI 4motion	09/00-05/05	ATD	1896	:→010000	0-N1268	TB [DG]
1.9 TDI 4motion	09/00-05/05	ATD	1896	:→010000	0-N1274	TB [BT]
1.9 TDI, 1.9 TDI 4motion	10/98-05/05	AGR, AGR, ALH, AHF, ASV	1896		0-N167	TB [DG]
1.9 TDI, 1.9 TDI 4motion	12/98-01/02	AUY	1896		0-N1048	TB [TE]
1.9 TDI, 1.9 TDI 4motion	12/98-01/02	AJM	1896	:185671→	0-N1048	TB [TE]
1.9 TDI, 1.9 TDI 4motion	12/98-01/02	AJM	1896	:→185670	0-N1049	TB [BT]



CM³



Art. Nr.



BORA (1J2)

1.9 TDI, 1.9 TDI 4motion	12/98-01/02	AJM	1896	:→185670; mit Anbaumaterial	0-N1265	TB [TE]	
1.9 TDI, 1.9 TDI 4motion	12/98-01/02	AJM, AUY	1896		0-N1268	TB [DG]	
1.9 TDI, 1.9 TDI 4motion	12/98-01/02	AUY	1896		0-N1274	TB [BT]	
1.9 TDI, 1.9 TDI 4motion	12/98-01/02	AJM	1896	:185671→	0-N1274	TB [BT]	
1.9 TDI, 1.9 TDI 4motion	05/00-05/05	ARL, ASZ, ATD	1896	ch.1J-2-525001, 1J-2D352774→	0-N1045	TB [TE]	
1.9 TDI, 1.9 TDI 4motion	05/00-05/05	ARL, ASZ	1896	ch.1J-2-525001, 1J-2D352774→	0-N1046	TB [DG]	
1.9 TDI, 1.9 TDI 4motion	05/00-05/05	ARL, ASZ, ATD	1896	ch.→1J-2-525000, 1J-2-D352773	0-N1048	TB [TE]	
1.9 TDI, 1.9 TDI 4motion	05/00-05/05	ARL, ASZ, ATD	1896	ch.→1J-2-525000, 1J-2-D352773	0-N1268	TB [DG]	
1.9 TDI, 1.9 TDI 4motion	05/00-05/05	ARL, ASZ, ATD	1896	ch.→1J-2-525000, 1J-2-D352773	0-N1274	TB [BT]	
1.9 TDI, 1.9 TDI 4motion	09/00-05/05	ATD	1896	ch.1J-2-525001, 1J-2D352774→	0-N1046	TB [DG]	
2.0, 2.0 4motion	10/98-05/05	APK, AQY, AZG, AZH, AZJ, BBW, AZH, AZJ	1984		0-N157	TB [TE]	
1.4 16V	03/00-05/05	AHW, AKQ, APE, AXP, BCA	1390		0-N1310	VB [DG]	
1.4 16V	03/00-05/05	AHW, AKQ, APE, AXP, BCA	1390	für Fahrzeuge mit Servolenkung	0-N1445	VB [BT]	S
1.4 16V	03/00-05/05	AHW, AKQ, APE, AXP, BCA	1390	, für Fahrzeuge mit Servolenkung	0-N1539	VB [BT]	S
1.6	10/98-05/05	AEH, AKL, APF	1595		0-N1041	VB [BT]	S
1.6	08/00-05/05	AVU	1595		0-N1041	VB [BT]	S
1.6 16V, 1.6 FSI	05/00-05/05	ATN, AUS, AZD, BCB, BAD	1598		0-N1310	VB [DG]	
1.6 16V, 1.6 FSI	05/00-05/05	ATN, AUS, AZD, BCB, BAD	1598	für Fahrzeuge mit Servolenkung	0-N1445	VB [BT]	S
1.6 16V, 1.6 FSI	05/00-05/05	ATN, AUS, AZD, BCB, BAD	1598	, für Fahrzeuge mit Servolenkung	0-N1539	VB [BT]	S
1.8	10/98-05/05	AGN	1781		0-N1041	VB [BT]	S
1.8 4motion, 1.8 T 4motion	02/99-05/05	AGN, ARX	1781		0-N1041	VB [BT]	S
1.8 T	05/00-05/05	AGU, ARX, AUM	1781		0-N1041	VB [BT]	S
1.9 SDI	10/98-05/05	AGP, AQM	1896		0-N1606	VB [BT]	S
1.9 SDI, 1.9 TDI, 1.9 TDI 4motion	10/98-05/05	AGP, AQM, AGR, AGR, ALH, AHF, ASV	1896		0-N174	VB [DG]	
1.9 TDI	10/98-06/01	AHF	1896		0-N1538	VB [BT]	S
1.9 TDI	10/98-06/01	ASV	1896		0-N1606	VB [BT]	S
1.9 TDI	09/00-05/05	ATD	1896	→ 12/2002; Rippenanzahl: 5	0-N1441	VB [BT]	S
1.9 TDI	09/00-05/05	AXR	1896		0-N1494	VB [BT]	S
1.9 TDI	09/00-05/05	ATD	1896	01/2003 →	0-N1494	VB [BT]	S
1.9 TDI	09/00-05/05	ATD	1896	→ 12/2002	0-N2047	VB [DG]	
1.9 TDI	09/00-05/05	ATD	1896	→ 12/2002	0-N2139	VB [VD]	
1.9 TDI 4motion	09/00-05/05	ATD	1896	→ 12/2002; Rippenanzahl: 5	0-N1441	VB [BT]	S
1.9 TDI 4motion	09/00-05/05	ATD	1896	01/2003 →	0-N1494	VB [BT]	S
1.9 TDI 4motion	09/00-05/05	ATD	1896	→ 12/2002	0-N2047	VB [DG]	
1.9 TDI 4motion	09/00-05/05	ATD	1896	→ 12/2002	0-N2139	VB [VD]	
1.9 TDI, 1.9 TDI 4motion	10/98-05/05	AGR, AGR, ALH	1896		0-N1538	VB [BT]	S
1.9 TDI, 1.9 TDI 4motion	12/98-01/02	AUY	1896	Rippenanzahl: 5	0-N1441	VB [BT]	S
1.9 TDI, 1.9 TDI 4motion	12/98-01/02	AJM	1896		0-N1494	VB [BT]	S
1.9 TDI, 1.9 TDI 4motion	12/98-01/02	AUY	1896		0-N2047	VB [DG]	
1.9 TDI, 1.9 TDI 4motion	12/98-01/02	AUY	1896		0-N2139	VB [VD]	
1.9 TDI, 1.9 TDI 4motion	05/00-05/05	ARL, ASZ	1896		0-N1494	VB [BT]	S
2.0	10/98-05/05	APK, AQY	1984		0-N1041	VB [BT]	S
2.3 V5, 2.3 V5 4motion	10/98-10/00	AGZ	2324	Rippenanzahl: 6	0-N2017	VB [BT]	S
2.3 V5, 2.3 V5 4motion	10/00-05/05	AQN	2324	Rippenanzahl: 6	0-N1496S	VB [TE]	
2.8 V6 4motion	03/99-05/05	AQP, AUE, BDE	2792	Rippenanzahl: 6	0-N1496S	VB [TE]	
2.8 V6 4motion	03/99-05/05	AQP, AUE, BDE	2792	Rippenanzahl: 7	0-N1657	VB [BT]	S

BORA Kombi (1J6)

1.4 16V	09/01-05/05	APE, AXP, BCA	1390	20x130; 17x58; beinhaltetete Rollen: 4	SK-1511	BTK	
1.4 16V	09/01-05/05	AHW	1390	20x130; 17x58; :160001→; beinhaltetete Rollen: 4	SK-1511	BTK	
1.4 16V	09/01-05/05	AKQ	1390	20x130; 17x58; :242001→; beinhaltetete Rollen: 4	SK-1511	BTK	
1.4 16V	09/01-05/05	AXP, BCA	1390	20x130; 17x58; beinhaltetete Rollen: 4	SK-1511AQ1	BTKW	
1.4 16V	09/01-05/05	AHW	1390	20x130; 17x58; :AHW160001→; beinhaltetete Rollen: 4	SK-1511AQ1	BTKW	
1.4 16V	09/01-05/05	AHW	1390	20x130; 17x58; →AHW160000	SK-1585	BTK	
1.4 16V	09/01-05/05	AHW, AKQ	1390	20x130; 17x58; :→160000, 242000	SK-1585AQ1	BTKW	
1.6	05/99-05/05	AEH, AKL	1595	23x138; Baumuster: 1J6	SK-1109	BTK	
1.6	05/99-05/05	AEH, AKL, APF	1595	23x138	SK-1109AQ1	BTKW	
1.6	08/00-05/05	AVU, BFQ	1595	23x138; Baumuster: 1J6	SK-1109	BTK	
1.6	08/00-05/05	AVU	1595	23x138	SK-1109AQ1	BTKW	
1.6 16V, 1.6 FSI	02/00-05/05	ATN, AUS, AZD, BCB, BAD	1598	20x130; 17x58; beinhaltetete Rollen: 4	SK-1511	BTK	
1.6 16V, 1.6 FSI	02/00-05/05	ATN, AUS, AZD, BCB, BAD	1598	20x130; 17x58; beinhaltetete Rollen: 4	SK-1511AQ2	BTKW	
1.8 4motion, 1.8 T	05/99-05/05	AGN, AUQ	1781	23x150; ch.→1J-Y-850000; mit Spanndämpfer, Spannrolle	SK-1337	BTK	

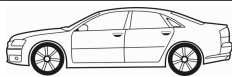

CM³



Art. Nr.



ohne Halter

BORA Kombi (1J6)

1.8 4motion, 1.8 T	05/99-05/05	AGN, AUQ	1781	23x150; ch.→1J-Y-850000; mit Spanndämpfer, Spannrolle	SK-1337AQ1	BTKW
1.8 4motion, 1.8 T	05/99-05/05	AGN, AUQ	1781	23x150; ch.1J-Y-850001→	SK-1660	BTK
1.8 4motion, 1.8 T	05/99-05/05	AGN, AUQ	1781	23x150; ch.1J-Y-850001→	SK-1660AQ1	BTKW
1.8 4motion, 1.8 T	05/99-05/05	AGN, AUQ	1781	23x150; ch.→1J-Y-850000	SK-1709	BTK
1.8 4motion, 1.8 T	05/99-05/05	AGN, AUQ	1781	23x150; ch.1J-Y-850001→	SK-1710	BTK
1.8 T	05/00-05/05	AGU, AUM	1781	23x150; ch.→1J-Y-850000; mit Spanndämpfer, Spannrolle	SK-1337	BTK
1.8 T	05/00-05/05	AGU, AUM	1781	23x150; ch.→1J-Y-850000; mit Spanndämpfer, Spannrolle	SK-1337AQ1	BTKW
1.8 T	05/00-05/05	AGU, AUM	1781	23x150; ch.1J-Y-850001→	SK-1660	BTK
1.8 T	05/00-05/05	AGU, AUM	1781	23x150; ch.1J-Y-850001→	SK-1660AQ1	BTKW
1.8 T	05/00-05/05	AGU, AUM	1781	23x150; ch.→1J-Y-850000	SK-1709	BTK
1.8 T	05/00-05/05	AGU, AUM	1781	23x150; ch.1J-Y-850001→	SK-1710	BTK
1.9 TDI	05/99-06/01	AHF, ASV	1896	25x141; →AHF006065; mit Zubehör	SK-1111	BTK
1.9 TDI	05/99-06/01	AHF, ASV	1896	25x141; →AHF595000; mit Zubehör	SK-1111AQ1	BTKW
1.9 TDI	05/99-06/01	AHF, ASV	1896	25x141; AHF595001→; mit Zubehör	SK-1258	BTK
1.9 TDI	05/99-06/01	AHF, ASV	1896	25x141; AHF595001→; mit Zubehör	SK-1258AQ1	BTKW
1.9 TDI	09/00-05/05	ATD, AXR	1896	30x120; ch.1J-2-592783, 1J-2D352774→; AXR010001→; mit Zubehör	SK-1372	BTK
1.9 TDI	09/00-05/05	ATD, AXR	1896	30x120; ch.→1J-2-592782, 1J-2-D352773; mit Zubehör; Baumuster: 1J6	SK-1582	BTK
1.9 TDI	09/00-05/05	ATD, AXR	1896	30x120; ch.→1J-2-592782, 1J-2-D352773; mit Spanndämpfer, Spannrolle; mit Zubehör; Baumuster: 1J6	SK-1583	BTK
1.9 TDI	07/04-05/05	AGR, ALH	1896	25x141; →AGR565000; mit Zubehör	SK-1111	BTK
1.9 TDI	07/04-05/05	AGR, ALH	1896	25x141; →ALH500000; mit Zubehör	SK-1111	BTK
1.9 TDI	07/04-05/05	AGR, ALH	1896	25x141; →AGR565000; mit Zubehör	SK-1111AQ1	BTKW
1.9 TDI	07/04-05/05	AGR, ALH	1896	25x141; →ALH500000; mit Zubehör	SK-1111AQ1	BTKW
1.9 TDI	07/04-05/05	AGR, ALH	1896	25x141; AGR565001, ALH500001→; mit Zubehör	SK-1258	BTK
1.9 TDI	07/04-05/05	AGR	1896	25x141; AGR565001→; mit Zubehör	SK-1258AQ1	BTKW
1.9 TDI	07/04-05/05	ALH	1896	25x141; ALH500001→; mit Zubehör	SK-1258AQ1	BTKW
1.9 TDI 4motion	09/00-05/05	ATD	1896	30x120; ch.1J-2-592783, 1J-2D352774→; AXR010001→; mit Zubehör	SK-1372	BTK
1.9 TDI 4motion	11/00-05/05	ASZ	1896	30x120; ch.→1J-2-592782, 1J-2-D352773; 04/2001 →; mit Zubehör; Baumuster: 1J6	SK-1582	BTK
1.9 TDI 4motion	11/00-05/05	ASZ	1896	30x120; ch.→1J-2-592782, 1J-2-D352773; 04/2001 →; mit Spanndämpfer, Spannrolle; mit Zubehör; Baumuster: 1J6	SK-1583	BTK
1.9 TDI, 1.9 TDI 4motion	05/99-06/01	AUY	1896	30x120; ch.1J-2-592783, 1J-2D352774→; mit Zubehör	SK-1372	BTK
1.9 TDI, 1.9 TDI 4motion	05/99-06/01	AUY	1896	30x120; ch.1J-2-592783, 1J-2D-352774→	SK-1372AQ2	BTKW
1.9 TDI, 1.9 TDI 4motion	05/99-06/01	AJM	1896	30x120; →AJM185670; mit Spanndämpfer, Spannrolle; mit Zubehör; Baumuster: 1J6	SK-1378	BTK
1.9 TDI, 1.9 TDI 4motion	05/99-06/01	AJM	1896	30x120; →AJM185670; mit Spanndämpfer, Spannrolle	SK-1378AQ1	BTKW
1.9 TDI, 1.9 TDI 4motion	05/99-06/01	AJM	1896	30x120; →AJM185670; ohne Spanndämpfer, Spannrolle; mit Zubehör; Baumuster: 1J6	SK-1388	BTK
1.9 TDI, 1.9 TDI 4motion	05/99-06/01	AJM	1896	30x120; →AJM185670; ohne Spanndämpfer, Spannrolle; mit Zubehör	SK-1388AQ1	BTKW
1.9 TDI, 1.9 TDI 4motion	05/99-06/01	AUY	1896	30x120; ch.→1J-2-592782, 1J-2-D352773; mit Zubehör	SK-1582	BTK
1.9 TDI, 1.9 TDI 4motion	05/99-06/01	AJM, AUY	1896	30x120; AJM185671→; mit Zubehör	SK-1582	BTK
1.9 TDI, 1.9 TDI 4motion	05/99-06/01	AUY	1896	30x120; ch.→1J2592782, 2D352773; ohne Spanndämpfer, Spannrolle; mit Zubehör	SK-1582AQ1	BTKW
1.9 TDI, 1.9 TDI 4motion	05/99-06/01	AJM, AUY	1896	30x120; AJM185671→; ohne Spanndämpfer, Spannrolle; mit Zubehör	SK-1582AQ1	BTKW
1.9 TDI, 1.9 TDI 4motion	05/99-06/01	AUY	1896	30x120; ch.→1J-2-592782, 1J-2-D352773; mit Spanndämpfer, Spannrolle; mit Zubehör	SK-1583	BTK
1.9 TDI, 1.9 TDI 4motion	05/99-06/01	AJM, AUY	1896	30x120; AJM185671→; mit Spanndämpfer, Spannrolle; mit Zubehör	SK-1583	BTK
1.9 TDI, 1.9 TDI 4motion	05/99-06/01	AUY	1896	30x120; ch.→1J2592782, 2D352773; mit Spanndämpfer, Spannrolle; mit Zubehör	SK-1583AQ1	BTKW
1.9 TDI, 1.9 TDI 4motion	05/99-06/01	AJM, AUY	1896	30x120; AJM185671→; mit Spanndämpfer, Spannrolle; mit Zubehör	SK-1583AQ1	BTKW
1.9 TDI, 1.9 TDI 4motion	09/00-05/05	ASZ, ATD, ATD, AXR	1896	30x120; ch.1J-2-592783, 1J-2D-352774→	SK-1372AQ2	BTKW
1.9 TDI, 1.9 TDI 4motion	09/00-05/05	ARL, ASZ, ATD	1896	30x120; ch.→1J-2-592782, 1J-2-D352773; mit Zubehör; Baumuster: 1J6	SK-1582	BTK
1.9 TDI, 1.9 TDI 4motion	09/00-05/05	ASZ, ATD, ATD, AXR	1896	30x120; ch.→1J2592782, 2D352773; ohne Spanndämpfer, Spannrolle; mit Zubehör	SK-1582AQ1	BTKW

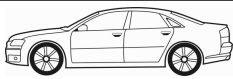

CM³



Art. Nr.



BORA Kombi (1J6)

1.9 TDI, 1.9 TDI 4motion	09/00-05/05	ARL, ASZ, ATD	1896	30x120; ch.→1J-2-592782, 1J-2-D352773; mit Spanndämpfer, Spannrolle; mit Zubehör; Baumuster: 1J6	SK-1583	BTK
1.9 TDI, 1.9 TDI 4motion	09/00-05/05	ASZ, ATD, ATD, AXR	1896	30x120; ch.→1J2592782, 2D352773; mit Spanndämpfer, Spannrolle; mit Zubehör	SK-1583AQ1	BTKW
1.9 TDI, 1.9 TDI 4motion	11/00-05/05	ASZ	1896	30x120; 01/2003 →; mit Zubehör	SK-1372	BTK
1.9 TDI, 1.9 TDI 4motion	05/01-05/05	ARL	1896	30x120; ch.1J-2-592783, 1J-2D352774 →; mit Zubehör	SK-1372	BTK
1.9 TDI, 1.9 TDI 4motion	05/01-05/05	ARL	1896	30x120; ch.1J-2-592783, 1J-2D-352774 →	SK-1372AQ3	BTKW
2.0	05/99-05/05	APK, AQY, AZJ	1984	23x138; Baumuster: 1J6	SK-1109	BTK
2.0 4motion	04/00-05/05	AZH, AZJ	1984	23x138; Baumuster: 1J6	SK-1109	BTK
2.0, 2.0 4motion	05/99-05/05	APK, AQY, AZG, AZH, AZJ, AZH, AZJ	1984	23x138	SK-1109AQ2	BTKW
1.4 16V	09/01-05/05	AHW, AXP, BCA	1390		0-N1262	TB [DG]
1.4 16V	09/01-05/05	AXP, BCA	1390		0-N1263	TB [TE]
1.4 16V	09/01-05/05	AHW	1390	ENGINE:160001 →	0-N1263	TB [TE]
1.4 16V	09/01-05/05	AKQ	1390	ENGINE:242001 →	0-N1263	TB [TE]
1.4 16V	09/01-05/05	AHW, AXP, BCA	1390		0-N158	TB [TE]
1.4 16V	09/01-05/05	AHW	1390	ENGINE: →160000	0-N159	TB [TE]
1.4 16V	09/01-05/05	AKQ	1390	ENGINE: →242000	0-N159	TB [TE]
1.4 16V	09/01-05/05	AHW, AXP, BCA	1390		0-N164	TB [DG]
1.6	05/99-05/05	AEH, AKL, APF, AVU, BFQ	1595		0-N157	TB [TE]
1.6 16V, 1.6 FSI	02/00-05/05	ATN, AUS, AZD, BCB, BAD	1598		0-N1262	TB [DG]
1.6 16V, 1.6 FSI	02/00-05/05	ATN, AUS, AZD, BCB, BAD	1598		0-N1263	TB [TE]
1.6 16V, 1.6 FSI	02/00-05/05	ATN, AUS, AZD, BCB, BAD	1598		0-N158	TB [TE]
1.6 16V, 1.6 FSI	02/00-05/05	ATN, AUS, AZD, BCB, BAD	1598		0-N164	TB [DG]
1.8 4motion, 1.8 T	05/99-05/05	AGN, AUQ	1781	ch.1J-Y-850001 →	0-N1042	TB [TE]
1.8 4motion, 1.8 T	05/99-05/05	AGN, AGU, ARX, AUM, AUQ	1781		0-N1237	TB [BT]
1.8 4motion, 1.8 T	05/99-05/05	AGN, AGU, ARX, AUM, AUQ	1781		0-N1316	TB [DG]
1.8 4motion, 1.8 T	05/99-05/05	AGN, AUQ	1781	ch.→1J-Y-850000	0-N1654	TB [TE]
1.8 T	05/00-05/05	AGU, AUM	1781	ch.1J-Y-850001 →	0-N1042	TB [TE]
1.8 T	05/00-05/05	AGU, AUM	1781	ch.→1J-Y-850000	0-N1654	TB [TE]
1.9 TDI	05/99-06/01	AHF, ASV	1896		0-N107	TB [TE]
1.9 TDI	05/99-05/05	AGR, ALH, AHF, ASV	1896		0-N131	TB [DG]
1.9 TDI	05/99-05/05	AGR, ALH, AHF, ASV	1896		0-N166	TB [DG]
1.9 TDI	05/99-05/05	AGR, ALH, AHF, ASV	1896		0-N167	TB [DG]
1.9 TDI	09/00-05/05	ATD	1896	ch.1J-2-525001, 1J-2D352774 →	0-N1045	TB [TE]
1.9 TDI	09/00-05/05	AXR	1896	ENGINE:010001 →	0-N1045	TB [TE]
1.9 TDI	09/00-05/05	ATD	1896	ch.1J-2-525001, 1J-2D352774 →	0-N1046	TB [DG]
1.9 TDI	09/00-05/05	AXR	1896	ENGINE:010001 →	0-N1046	TB [DG]
1.9 TDI	09/00-05/05	ATD	1896	ch.→1J-2-525000, 1J-2-D352773	0-N1048	TB [TE]
1.9 TDI	09/00-05/05	AXR	1896	ENGINE: →010000	0-N1048	TB [TE]
1.9 TDI	09/00-05/05	ATD	1896	ch.→1J-2-525000, 1J-2-D352773	0-N1268	TB [DG]
1.9 TDI	09/00-05/05	AXR	1896	ENGINE: →010000	0-N1268	TB [DG]
1.9 TDI	09/00-05/05	ATD	1896	ch.→1J-2-525000, 1J-2-D352773	0-N1274	TB [BT]
1.9 TDI	09/00-05/05	AXR	1896	ENGINE: →010000	0-N1274	TB [BT]
1.9 TDI	07/04-05/05	AGR, ALH	1896		0-N107	TB [TE]
1.9 TDI 4motion	09/00-05/05	ATD	1896	ENGINE:010001 →	0-N1045	TB [TE]
1.9 TDI 4motion	09/00-05/05	ATD	1896	ENGINE:010001 →	0-N1046	TB [DG]
1.9 TDI 4motion	09/00-05/05	ATD	1896	ENGINE: →010000	0-N1048	TB [TE]
1.9 TDI 4motion	09/00-05/05	ATD	1896	ENGINE: →010000	0-N1268	TB [DG]
1.9 TDI 4motion	09/00-05/05	ATD	1896	ENGINE: →010000	0-N1274	TB [BT]
1.9 TDI, 1.9 TDI 4motion	05/99-06/01	AUY	1896		0-N1048	TB [TE]
1.9 TDI, 1.9 TDI 4motion	05/99-06/01	AJM	1896	ENGINE:185671 →	0-N1048	TB [TE]
1.9 TDI, 1.9 TDI 4motion	05/99-06/01	AJM	1896	ENGINE: →185670	0-N1049	TB [BT]
1.9 TDI, 1.9 TDI 4motion	05/99-06/01	AJM	1896	ENGINE: →185670; mit Anbaumaterial	0-N1265	TB [TE]
1.9 TDI, 1.9 TDI 4motion	05/99-06/01	AJM, AUY	1896		0-N1268	TB [DG]
1.9 TDI, 1.9 TDI 4motion	05/99-06/01	AUY	1896		0-N1274	TB [BT]
1.9 TDI, 1.9 TDI 4motion	05/99-06/01	AJM	1896	ENGINE:185671 →	0-N1274	TB [BT]
1.9 TDI, 1.9 TDI 4motion	09/00-05/05	ARL, ASZ, ATD	1896	ch.1J-2-525001, 1J-2D352774 →	0-N1045	TB [TE]
1.9 TDI, 1.9 TDI 4motion	09/00-05/05	ARL, ASZ, ATD	1896	ch.1J-2-525001, 1J-2D352774 →	0-N1046	TB [DG]
1.9 TDI, 1.9 TDI 4motion	09/00-05/05	ARL, ASZ, ATD	1896	ch.→1J-2-525000, 1J-2-D352773	0-N1048	TB [TE]
1.9 TDI, 1.9 TDI 4motion	09/00-05/05	ARL, ASZ, ATD	1896	ch.→1J-2-525000, 1J-2-D352773	0-N1268	TB [DG]
1.9 TDI, 1.9 TDI 4motion	09/00-05/05	ARL, ASZ, ATD	1896	ch.→1J-2-525000, 1J-2-D352773	0-N1274	TB [BT]
2.0, 2.0 4motion	05/99-05/05	APK, AQY, AZG, AZH, AZJ, AZH, AZJ	1984		0-N157	TB [TE]
1.4 16V	09/01-05/05	AHW, AXP, BCA	1390	⚙	0-N1310	VB [DG]
1.4 16V	09/01-05/05	AHW, AXP, BCA	1390	für Fahrzeuge mit Servolenkung	0-N1445	VB [BT] S

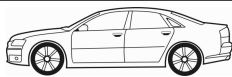

CM³



Art. Nr.



BORA Kombi (1J6)

1.4 16V	09/01-05/05	AHW, AXP, BCA	1390	⊗		0-N1539	VB [BT]	S
1.6	05/99-05/05	AEH, AKL	1595			0-N1041	VB [BT]	S
1.6	08/00-05/05	AVU	1595			0-N1041	VB [BT]	S
1.6 16V, 1.6 FSI	02/00-05/05	ATN, AUS, AZD, BCB, BAD	1598	⊗		0-N1310	VB [DG]	
1.6 16V, 1.6 FSI	02/00-05/05	ATN, AUS, AZD, BCB, BAD	1598		für Fahrzeuge mit Servolenkung	0-N1445	VB [BT]	S
1.6 16V, 1.6 FSI	02/00-05/05	ATN, AUS, AZD, BCB, BAD	1598	⊗	für Fahrzeuge mit Servolenkung	0-N1539	VB [BT]	S
1.8 4motion, 1.8 T	05/99-05/05	AGN, AGU, ARX, AUM	1781			0-N1041	VB [BT]	S
1.9 TDI	05/99-06/01	AHF	1896			0-N1538	VB [BT]	S
1.9 TDI	05/99-06/01	ASV	1896			0-N1606	VB [BT]	S
1.9 TDI	05/99-05/05	AGR, ALH, AHF, ASV	1896			0-N174	VB [DG]	
1.9 TDI	09/00-05/05	ATD	1896		→ 12/2002; Rippenanzahl: 5	0-N1441	VB [BT]	S
1.9 TDI	09/00-05/05	AXR	1896			0-N1494	VB [BT]	S
1.9 TDI	09/00-05/05	ATD	1896		01/2003 →	0-N1494	VB [BT]	S
1.9 TDI	09/00-05/05	ATD	1896		→ 12/2002	0-N2047	VB [DG]	
1.9 TDI	09/00-05/05	ATD	1896		→ 12/2002	0-N2139	VB [VD]	
1.9 TDI	07/04-05/05	AGR, ALH	1896			0-N1538	VB [BT]	S
1.9 TDI 4motion	09/00-05/05	ATD	1896		→ 12/2002; Rippenanzahl: 5	0-N1441	VB [BT]	S
1.9 TDI 4motion	09/00-05/05	ATD	1896		01/2003 →	0-N1494	VB [BT]	S
1.9 TDI 4motion	09/00-05/05	ATD	1896		→ 12/2002	0-N2047	VB [DG]	
1.9 TDI 4motion	09/00-05/05	ATD	1896		→ 12/2002	0-N2139	VB [VD]	
1.9 TDI, 1.9 TDI 4motion	05/99-06/01	AUY	1896		Rippenanzahl: 5	0-N1441	VB [BT]	S
1.9 TDI, 1.9 TDI 4motion	05/99-06/01	AJM	1896			0-N1494	VB [BT]	S
1.9 TDI, 1.9 TDI 4motion	05/99-06/01	AUY	1896			0-N2047	VB [DG]	
1.9 TDI, 1.9 TDI 4motion	05/99-06/01	AUY	1896			0-N2139	VB [VD]	
1.9 TDI, 1.9 TDI 4motion	11/00-05/05	ARL, ASZ	1896			0-N1494	VB [BT]	S
2.0	05/99-05/05	APK, AQY	1984			0-N1041	VB [BT]	S
2.3 V5, 2.3 V5 4motion	05/99-10/00	AGZ	2324		Rippenanzahl: 6	0-N2017	VB [BT]	S
2.3 V5, 2.3 V5 4motion	10/00-05/05	AQN	2324		Rippenanzahl: 6	0-N1496S	VB [TE]	
2.8 V6 4motion	05/99-05/05	AQP, AUE, BDE	2792		Rippenanzahl: 7	0-N1657	VB [BT]	S
2.8 V6 4motion, 2.8 VR6	05/99-05/05	AQP, AUE, BDE, AUE	2792		Rippenanzahl: 6	0-N1496S	VB [TE]	

CADDY I (14)

1.5	08/82-07/83	JB	1457		18x121; mit Zubehör	SK-1026	BTK	
1.6	10/82-10/83	EM	1588		18x121; mit Zubehör	SK-1026	BTK	
1.6	01/83-07/92	EW	1595		18x121; 08/1983 →; mit Zubehör	SK-1026	BTK	
1.6 D	08/82-07/92	JK, ME	1588		25x135; mit Zubehör	SK-1001	BTK	
1.8	08/85-07/92	JH	1781		18x121; mit Zubehör	SK-1026	BTK	
1.5	08/82-07/83	JB	1457			0-N805	TB [TE]	
1.6	10/82-10/83	EM	1588			0-N805	TB [TE]	
1.6	01/83-07/92	EW	1595			0-N805	TB [TE]	
1.6 D	08/82-07/92	JK, ME	1588			0-N806	TB [TE]	
1.8	08/85-07/92	JH	1781			0-N805	TB [TE]	

CADDY II Kasten (9K9A)

1.4	08/00-01/04	AUA	1390		20x130; 17x58; beinhaltete Rollen: 4	SK-1511	BTK	
1.4	08/00-01/04	AUA	1390		20x130; 17x58; beinhaltete Rollen: 4	SK-1511AQ1	BTKW	
1.7 SDI	07/96-09/00	AHB	1716		25.4x137; mit Zubehör	SK-1425	BTK	
1.9 D	11/95-01/04	1Y	1896		25.4x137; →705902; mit Zubehör	SK-1029	BTK	
1.9 D	11/95-01/04	1Y	1896		25x141; →AYQ005517; mit Zubehör	SK-1111	BTK	
1.9 D	11/95-01/04	1Y	1896		25x141; →AYQ005517; mit Zubehör	SK-1111AQ1	BTKW	
1.9 D	11/95-01/04	1Y	1896		25x141; :AYQ005518→; mit Zubehör	SK-1258	BTK	
1.9 D	11/95-01/04	1Y	1896		25x141; :AQY005518→; mit Zubehör	SK-1258AQ1	BTKW	
1.9 D	11/95-01/04	1Y	1896		25.4x137; mit Zubehör	SK-1425	BTK	
1.9 D, 1.9 SDI	11/95-01/04	1Y, AEY, AYQ	1896		25.4x137; mit Zubehör	SK-1122	BTK	
1.9 SDI	11/95-01/04	AYQ	1896		25x141; →AYQ005517; mit Zubehör	SK-1111	BTK	
1.9 SDI	11/95-01/04	AYQ	1896		25x141; →AYQ005517; mit Zubehör	SK-1111AQ1	BTKW	
1.9 SDI	11/95-01/04	AYQ	1896		25x141; :AYQ005518→; mit Zubehör	SK-1258	BTK	
1.9 SDI	11/95-01/04	AQY	1896		25x141; :AQY005518→; mit Zubehör	SK-1258AQ1	BTKW	
1.9 SDI	11/95-01/04	AEY	1896		25.4x137; mit Zubehör	SK-1425	BTK	
1.9 TDI	09/96-01/04	AHU, ALE	1896		25x137; mit Zubehör	SK-1098	BTK	
1.9 TDI	09/96-01/04	ALH	1896		25x141; →ALH500000; mit Zubehör	SK-1111	BTK	
1.9 TDI	09/96-01/04	1Z, AHU, ALE, ALH	1896		25x141; →ALH500000; mit Zubehör	SK-1111AQ1	BTKW	
1.9 TDI	09/96-01/04	1Z	1896		25.4x137; → 06/2003; mit Zubehör	SK-1122	BTK	
1.9 TDI	09/96-01/04	ALH	1896		25x141; :ALH500001→; mit Zubehör	SK-1258	BTK	
1.9 TDI	09/96-01/04	1Z, AHU, ALE, ALH	1896		25x141; :ALH500001→; mit Zubehör	SK-1258AQ1	BTKW	
60 1.4	11/95-01/04	AEX, APQ	1390		19x135; mit Zubehör	SK-1131	BTK	



CM³



Art. Nr.



CADDY II Kasten (9K9A)							
60 1.4	11/95-01/04	AEX, APQ	1390	19x135; mit Zubehör	SK-1131AQ1	BTKW	
60 1.4	11/95-01/04	AUD	1390	19x135; mit Zubehör	SK-1592	BTK	
60 1.4	11/95-01/04	AUD	1390	19x135; mit Zubehör	SK-1592AQ1	BTKW	
75 1.6	11/95-05/97	1F	1595	18x121; mit Zubehör	SK-1026	BTK	
75 1.6	11/95-09/00	AEE	1598	19x137; 06/1997 →; mit Zubehör; Baumuster: 9K9_	SK-1074	BTK	
75 1.6	11/95-09/00	ALM	1598	19x137	SK-1074AQ1	BTKW	
1.4	08/00-01/04	AUA	1390		0-N1262	TB [DG]	
1.4	08/00-01/04	AUA	1390		0-N1263	TB [TE]	
1.4	08/00-01/04	AUA	1390		0-N158	TB [TE]	
1.4	08/00-01/04	AUA	1390		0-N164	TB [DG]	
1.7 SDI	07/96-09/00	AHB	1716		0-N104	TB [TE]	
1.7 SDI	07/96-09/00	AHB	1716		0-N128	TB [DG]	
1.9 D, 1.9 TDI	11/95-01/04	1Y, 1Z, AHU, ALH	1896		0-N104	TB [TE]	
1.9 SDI	11/95-01/04	AEY	1896		0-N104	TB [TE]	
1.9 SDI	11/95-01/04	AYQ	1896		0-N107	TB [TE]	
1.9 SDI	11/95-01/04	AEY	1896		0-N128	TB [DG]	
1.9 SDI	11/95-01/04	AYQ	1896		0-N131	TB [DG]	
1.9 SDI	11/95-01/04	AYQ	1896		0-N166	TB [DG]	
1.9 SDI	11/95-01/04	AYQ	1896		0-N167	TB [DG]	
1.9 TDI	09/96-01/04	ALH	1896		0-N107	TB [TE]	
1.9 TDI	09/96-01/04	1Z, AHU, ALH	1896		0-N128	TB [DG]	
1.9 TDI	09/96-01/04	ALH	1896		0-N131	TB [DG]	
1.9 TDI	09/96-01/04	ALH	1896		0-N166	TB [DG]	
1.9 TDI	09/96-01/04	ALH	1896		0-N167	TB [DG]	
60 1.4	11/95-01/04	AEX, AKV, APQ	1390		0-N106	TB [TE]	
60 1.4	11/95-01/04	AUD	1390		0-N1331	TB [TE]	
75 1.6	11/95-09/00	AEE	1598		0-N106	TB [TE]	
75 1.6	11/95-05/97	1F	1595		0-N805	TB [TE]	
1.4, 60 1.4	11/95-01/04	AEX, APQ, AUD, AUA	1390	für Fahrzeuge mit Servolenkung	0-N1445	VB [BT]	S
1.4, 60 1.4	11/95-01/04	AEX, APQ, AUD, AUA	1390	☼	0-N1459	VB [BT]	S
1.7 SDI	07/96-09/00	AHB	1716		0-N1417	VB [TE]	
1.7 SDI	07/96-09/00	AHB	1716		0-N1609	VB [BT]	
1.9 D	11/95-01/04	1Y	1896		0-N1417	VB [TE]	
1.9 D	11/95-01/04	1Y	1896		0-N1609	VB [BT]	
1.9 SDI	11/95-01/04	AEY	1896		0-N1417	VB [TE]	
1.9 SDI	11/95-01/04	AYQ	1896		0-N1606	VB [BT]	S
1.9 SDI	11/95-01/04	AEY	1896		0-N1609	VB [BT]	
1.9 SDI	11/95-01/04	AYQ	1896	☼	0-N174	VB [DG]	
1.9 TDI	09/96-01/04	1Z, AHU, ALE	1896		0-N1417	VB [TE]	
1.9 TDI	09/96-01/04	1Z, AHU, ALE	1896		0-N1609	VB [BT]	
1.9 TDI	09/96-01/04	ALH	1896	☼	0-N174	VB [DG]	
75 1.6	11/95-05/97	1F	1595		0-N1417	VB [TE]	
75 1.6	11/95-09/00	AEE	1598	für Fahrzeuge mit Servolenkung	0-N1445	VB [BT]	S
75 1.6	11/95-09/00	AEE	1598	☼	0-N1459	VB [BT]	S
75 1.6	11/95-05/97	1F	1595		0-N1660	VB [BT]	
CADDY II Kombi (9K9B)							
1.4	11/95-01/04	AEX, APQ	1390	19x135; mit Zubehör	SK-1131	BTK	
1.4	11/95-01/04	AEX, APQ	1390	19x135; mit Zubehör	SK-1131AQ1	BTKW	
1.4	11/95-01/04	AUD	1390	19x135; mit Zubehör	SK-1592	BTK	
1.4	11/95-01/04	AUD	1390	19x135; mit Zubehör	SK-1592AQ1	BTKW	
1.4 16V	08/00-01/04	AUA	1390	20x130; 17x58; beinhalten Rollen: 4	SK-1511	BTK	
1.4 16V	08/00-01/04	AUA	1390	20x130; 17x58; beinhalten Rollen: 4	SK-1511AQ1	BTKW	
1.6	11/95-05/97	1F	1595	18x121; mit Zubehör	SK-1026	BTK	
1.6	06/97-09/00	AEE	1598	19x137; mit Zubehör; Baumuster: 9K9_	SK-1074	BTK	
1.6	06/97-09/00	ALM	1598	19x137	SK-1074AQ1	BTKW	
1.7 SDI	07/96-09/00	AHB	1716	25.4x137; mit Zubehör	SK-1425	BTK	
1.9 D	11/95-01/04	1Y	1896	25.4x137; ☼ →705902; mit Zubehör	SK-1029	BTK	
1.9 D	11/95-01/04	1Y	1896	25x141; ☼ ☼ →AYQ005517; mit Zubehör	SK-1111	BTK	
1.9 D	11/95-01/04	1Y	1896	25x141; ☼ ☼ →AYQ005517; mit Zubehör	SK-1111AQ1	BTKW	
1.9 D	11/95-01/04	1Y	1896	25x141; ☼ ☼ AYQ005518 →; mit Zubehör	SK-1258	BTK	
1.9 D	11/95-01/04	1Y	1896	25x141; ☼ ☼ AYQ005518 →; mit Zubehör	SK-1258AQ1	BTKW	
1.9 D	11/95-01/04	1Y	1896	25.4x137; mit Zubehör	SK-1425	BTK	
1.9 D, 1.9 SDI	11/95-01/04	1Y, AEY, AYQ	1896	25.4x137; mit Zubehör	SK-1122	BTK	
1.9 SDI	11/95-01/04	AYQ	1896	25x141; ☼ ☼ →AYQ005517; mit Zubehör	SK-1111	BTK	



CM³



Art. Nr.



CADDY II Kombi (9K9B)

1.9 SDI	11/95-01/04	AYQ	1896	25x141; :→AYQ005517; mit Zubehör	SK-1111AQ1	BTKW	
1.9 SDI	11/95-01/04	AYQ	1896	25x141; :AYQ005518→; mit Zubehör	SK-1258	BTK	
1.9 SDI	11/95-01/04	AQY	1896	25x141; :AQY005518→; mit Zubehör	SK-1258AQ1	BTKW	
1.9 SDI	11/95-01/04	AEY	1896	25.4x137; mit Zubehör	SK-1425	BTK	
1.9 TDI	10/96-01/04	AHU, ALE	1896	25x137; mit Zubehör	SK-1098	BTK	
1.9 TDI	10/96-01/04	ALH	1896	25x141; :→ALH500000; mit Zubehör	SK-1111	BTK	
1.9 TDI	10/96-01/04	AHU, ALE, ALH	1896	25x141; :→ALH500000; mit Zubehör	SK-1111AQ1	BTKW	
1.9 TDI	10/96-01/04	AHU, ALE, ALH	1896	25.4x137; → 06/2003; mit Zubehör	SK-1122	BTK	
1.9 TDI	10/96-01/04	ALH	1896	25x141; :ALH500001→; mit Zubehör	SK-1258	BTK	
1.9 TDI	10/96-01/04	AHU, ALE, ALH	1896	25x141; :ALH500001→; mit Zubehör	SK-1258AQ1	BTKW	
1.4	11/95-01/04	AEX, AKV, APQ	1390		0-N106	TB [TE]	
1.4	11/95-01/04	AUD	1390		0-N1331	TB [TE]	
1.4 16V	08/00-01/04	AUA	1390		0-N1262	TB [DG]	
1.4 16V	08/00-01/04	AUA	1390		0-N1263	TB [TE]	
1.4 16V	08/00-01/04	AUA	1390		0-N158	TB [TE]	
1.4 16V	08/00-01/04	AUA	1390		0-N164	TB [DG]	
1.6	11/95-05/97	1F	1595		0-N805	TB [TE]	
1.6	06/97-09/00	AEE	1598		0-N106	TB [TE]	
1.7 SDI	07/96-09/00	AHB	1716		0-N104	TB [TE]	
1.7 SDI	07/96-09/00	AHB	1716		0-N128	TB [DG]	
1.9 D	11/95-01/04	1Y	1896		0-N104	TB [TE]	
1.9 SDI	11/95-01/04	AEY	1896		0-N104	TB [TE]	
1.9 SDI	11/95-01/04	AYQ	1896		0-N107	TB [TE]	
1.9 SDI	11/95-01/04	AEY	1896		0-N128	TB [DG]	
1.9 SDI	11/95-01/04	AYQ	1896		0-N131	TB [DG]	
1.9 SDI	11/95-01/04	AYQ	1896		0-N166	TB [DG]	
1.9 SDI	11/95-01/04	AYQ	1896		0-N167	TB [DG]	
1.9 TDI	10/96-01/04	AHU, ALE	1896		0-N104	TB [TE]	
1.9 TDI	10/96-01/04	ALH	1896		0-N107	TB [TE]	
1.9 TDI	10/96-01/04	AHU, ALE	1896		0-N128	TB [DG]	
1.9 TDI	10/96-01/04	ALH	1896		0-N131	TB [DG]	
1.9 TDI	10/96-01/04	ALH	1896		0-N166	TB [DG]	
1.9 TDI	10/96-01/04	ALH	1896		0-N167	TB [DG]	
1.4, 1.4 16V	11/95-01/04	AEX, AKV, APQ, AUD, AUA	1390	für Fahrzeuge mit Servolenkung	0-N1445	VB [BT]	S
1.4, 1.4 16V	11/95-01/04	AEX, AKV, APQ, AUD, AUA	1390		0-N1459	VB [BT]	S
1.6	11/95-05/97	1F	1595		0-N1417	VB [TE]	
1.6	11/95-05/97	1F	1595		0-N1660	VB [BT]	
1.6	06/97-09/00	AEE	1598	für Fahrzeuge mit Servolenkung	0-N1445	VB [BT]	S
1.6	06/97-09/00	AEE	1598		0-N1459	VB [BT]	S
1.7 SDI	07/96-09/00	AHB	1716		0-N1417	VB [TE]	
1.7 SDI	07/96-09/00	AHB	1716		0-N1609	VB [BT]	
1.9 D	11/95-01/04	1Y	1896		0-N1417	VB [TE]	
1.9 D	11/95-01/04	1Y	1896		0-N1609	VB [BT]	
1.9 SDI	11/95-01/04	AEY	1896		0-N1417	VB [TE]	
1.9 SDI	11/95-01/04	AYQ	1896		0-N1606	VB [BT]	S
1.9 SDI	11/95-01/04	AEY	1896		0-N1609	VB [BT]	
1.9 SDI	11/95-01/04	AYQ	1896		0-N174	VB [DG]	
1.9 TDI	10/96-01/04	AHU, ALE	1896		0-N1417	VB [TE]	
1.9 TDI	10/96-01/04	AHU, ALE	1896		0-N1609	VB [BT]	
1.9 TDI	10/96-01/04	ALH	1896		0-N174	VB [DG]	

CADDY II Pick-up (9U7)

1.6	06/96-12/00	AEE	1598	19x137; mit Zubehör; Baumuster: 9U7	SK-1074	BTK	
1.6	06/96-12/00	ALM	1598	19x137	SK-1074AQ1	BTKW	
1.9 D	06/96-12/00	AEF	1896	23x137; mit Zubehör	SK-1512	BTK	
1.6	06/96-12/00	AEE	1598		0-N106	TB [TE]	
1.9 D	06/96-12/00	AEF	1896		0-N111	TB [TE]	
1.6	06/96-12/00	AEE	1598	für Fahrzeuge mit Servolenkung	0-N1445	VB [BT]	S
1.6	06/96-12/00	AEE	1598		0-N1459	VB [BT]	S
1.9 D	06/96-12/00	AEF	1896		0-N1675	VB [TE]	
1.9 D	06/96-12/00	AEF	1896		0-N1920	VB [BT]	
1.9 D	06/96-12/00	AEF	1896	für Artikelnummer:0-N1920	0-N1925	VB [BT]	

CADDY III Kasten (2KA, 2KH, 2CA, 2CH)

1.4	03/04-05/06	BCA	1390	20x130; 17x58; ch.→2K-6-150000; beinhaltete Rollen: 4	SK-1511	BTK	
1.4 16V	05/06-08/10	BUD	1390	20x130; 17x58; beinhaltete Rollen: 4	SK-1511	BTK	



CM³



Art. Nr.



ohne Halter

CADDY III Kasten (2KA, 2KH, 2CA, 2CH)

1.4, 1.4 16V	03/04-08/10	BCA, BUD	1390	20x130; 17x58; beinhaltetete Rollen: 4	SK-1511AQ1	BTKW	
1.6	04/04-	BSE, BSF	1595	23x138; 11/2007 →; Baumuster: 2KH	SK-1109	BTK	
1.6	04/04-	BGU, BSE, BSF	1595	23x138; Baumuster: 2KA	SK-1109	BTK	
1.6	04/04-	BGU	1595	23x138	SK-1109AQ1	BTKW	
1.6 BiFuel	05/11-	CHGA	1595	23x138	SK-1109	BTK	
1.6 BiFuel	05/11-	CHGA	1595	23x138	SK-1109AQ1	BTKW	
1.6 TDI	08/10-	CAYD, CAYE	1598	25x160; → 11/2010	SK-1695	BTK	
1.6 TDI	08/10-	CAYD, CAYE	1598	25x160; → 11/2010	SK-1695AQ1	BTKW	
1.6 TDI	08/10-	CAYD, CAYE	1598	25x160; → 11/2010; Baumuster: Caddy Maxi	SK-1695AQ1	BTKW	
1.6 TDI	08/10-	CAYD, CAYE	1598	25x160; 12/2010 →	SK-1727	BTK	
1.6 TDI	08/10-	CAYD, CAYE	1598	25x160; → 11/2010	SK-1727AQ2	BTKW	
1.9 TDI	09/05-08/10	BSU	1896	30x120	SK-1372AQ1	BTKW	
1.9 TDI, 1.9 TDI 4motion	04/04-08/10	BJB, BLS, BLS, BSU	1896	30x120; mit Zubehör	SK-1372	BTK	
1.9 TDI, 1.9 TDI 4motion	04/04-08/10	BJB, BLS, BLS	1896	30x120; Baumuster: Caddy Maxi	SK-1372AQ1	BTKW	
2.0 EcoFuel	04/06-	BSX	1984	23x138; Baumuster: 2KH	SK-1109	BTK	
2.0 EcoFuel	04/06-	BSX	1984	23x138	SK-1109AQ2	BTKW	
2.0 SDI	03/04-08/10	BDJ, BST	1968	30x120	SK-1372AQ1	BTKW	
2.0 SDI, 2.0 TDI	03/04-08/10	BDJ, BST, BMM	1968	30x120; mit Zubehör	SK-1372	BTK	
2.0 TDI	09/07-08/10	BMM	1968	30x120; Baumuster: Caddy Maxi	SK-1372AQ2	BTKW	
2.0 TDI	08/10-	CLCA	1968	25x160	SK-1727AQ2	BTKW	
2.0 TDI	05/12-	CFJA	1968	25x160	SK-1727AQ2	BTKW	
2.0 TDI 16V, 2.0 TDI 16V 4motion	11/10-	CFHC	1968	25x160; → 11/2010	SK-1727AQ2	BTKW	
2.0 TDI 4motion	08/10-	CFHF	1968	25x160; → 11/2010	SK-1727AQ2	BTKW	
2.0 TDI, 2.0 TDI 16V, 2.0 TDI 16V 4motion, 2.0 TDI 4motion	08/10-	CFHC, CFHC, CLCB, CFHE, CFHF, CLCA	1968	25x160; → 11/2010	SK-1695AQ1	BTKW	
2.0 TDI, 2.0 TDI 16V, 2.0 TDI 16V 4motion, 2.0 TDI 4motion	08/10-	CFHC, CFHC, CLCB, CFHE, CFHF, CLCA	1968	25x160; → 11/2010; Baumuster: Caddy Maxi	SK-1695AQ1	BTKW	
2.0 TDI, 2.0 TDI 16V, 2.0 TDI 16V 4motion, 2.0 TDI 4motion	08/10-	CFHC, CFHC, CLCB, CFHE, CFHF, CLCA	1968	25x160; 12/2010 →	SK-1727	BTK	
2.0 TDI, 2.0 TDI 4motion	08/10-	CFHF, CLCA	1968	25x160; → 11/2010	SK-1695	BTK	
2.0 TDI, 2.0 TDI 4motion	11/10-	CFHE	1968	25x160	SK-1727AQ2	BTKW	
2.0 TDI, 2.0 TDI 4motion	12/10-	CFHE, CFJA	1968	25x160	SK-1727	BTK	
1.4	03/04-05/06	BCA	1390		0-N164	TB [DG]	
1.4 16V	05/06-08/10	BUD	1390	ch.→2K-6-150000	0-N164	TB [DG]	
1.4, 1.4 16V	03/04-08/10	BCA, BUD	1390		0-N1262	TB [DG]	
1.4, 1.4 16V	03/04-08/10	BCA, BUD	1390		0-N1263	TB [TE]	
1.4, 1.4 16V	03/04-08/10	BCA, BUD	1390		0-N158	TB [TE]	
1.6	04/04-	BGU, BSE, BSF	1595		0-N157	TB [TE]	
1.6 TDI	08/10-	CAYD, CAYE	1598		0-N131	TB [DG]	
1.6 TDI	08/10-	CAYD, CAYE	1598		0-N2025	TB [DG]	
1.6 TDI	08/10-	CAYD, CAYE	1598		0-N2200	TB [DG]	
1.9 TDI, 1.9 TDI 4motion	04/04-08/10	BJB, BLS, BLS, BSU	1896		0-N1045	TB [TE]	
1.9 TDI, 1.9 TDI 4motion	04/04-08/10	BJB, BLS, BLS, BSU	1896		0-N1046	TB [DG]	
2.0 EcoFuel	04/06-	BSX	1984		0-N157	TB [TE]	
2.0 SDI, 2.0 TDI	03/04-08/10	BDJ, BST, BMM	1968		0-N1045	TB [TE]	
2.0 SDI, 2.0 TDI	03/04-08/10	BDJ, BST, BMM	1968		0-N1046	TB [DG]	
2.0 TDI, 2.0 TDI 16V, 2.0 TDI 16V 4motion, 2.0 TDI 4motion	08/10-	CFHC, CFHC, CLCB, CFHE, CFHF, CFJA, CLCA	1968		0-N131	TB [DG]	
2.0 TDI, 2.0 TDI 16V, 2.0 TDI 16V 4motion, 2.0 TDI 4motion	08/10-	CFHC, CFHC, CLCB, CFHE, CFHF	1968		0-N2025	TB [DG]	
2.0 TDI, 2.0 TDI 16V, 2.0 TDI 16V 4motion, 2.0 TDI 4motion	08/10-	CFHC, CFHC, CLCB, CFHE, CFHF, CFJA, CLCA	1968		0-N2200	TB [DG]	
1.2 TSI	09/10-	CBZA, CBZB	1197	☼	0-N1733	VB [BT]	S
1.2 TSI	09/10-	CBZA, CBZB	1197	☼	0-N2121	VB [DG]	
1.4, 1.4 16V	03/04-08/10	BCA, BUD	1390	☼	0-N1445	VB [BT]	S
1.6 TDI	08/10-	CAYD, CAYE	1598		0-N1534	VB [BT]	S
1.9 TDI	04/04-08/10	BJB	1896	ch.→2K-5-150000	0-N1530	VB [BT]	S
1.9 TDI	04/04-08/10	BJB	1896	ch.2K-6-000001→	0-N1531	VB [BT]	S
1.9 TDI	04/04-08/10	BLS	1896	ch.5P-6-000001→	0-N1531	VB [BT]	S
1.9 TDI 4motion	11/08-08/10	BLS	1896		0-N1531	VB [BT]	S
2.0 SDI	03/04-08/10	BDJ, BST	1968		0-N1530	VB [BT]	S
2.0 TDI, 2.0 TDI 16V, 2.0 TDI 16V 4motion, 2.0 TDI 4motion	08/10-	CFHC, CFHC, CLCB, CFHE, CFHF, CFJA, CLCA	1968		0-N1534	VB [BT]	S

CADDY III Kombi (2KB, 2KJ, 2CB, 2CJ)

1.4	03/04-05/06	BCA	1390	20x130; 17x58; ch.→2K-6-150000; beinhaltetete Rollen: 4	SK-1511	BTK	
1.4 16V	05/06-08/10	BUD	1390	20x130; 17x58; beinhaltetete Rollen: 4	SK-1511	BTK	



OPTIMAL®

VW



CM³



Art. Nr.



ohne Halter

CADDY III Kombi (2KB, 2KJ, 2CB, 2CJ)

1.4, 1.4 16V	03/04-08/10	BCA, BUD	1390	20x130; 17x58; beinhaltete Rollen: 4	SK-1511AQ1	BTKW
1.6	04/04-	BSE, BSF	1595	23x138; 11/2007 →; Baumuster: 2KJ	SK-1109	BTK
1.6	04/04-	BGU, BSE, BSF	1595	23x138; Baumuster: 2KB	SK-1109	BTK
1.6	04/04-	BGU	1595	23x138	SK-1109AQ1	BTKW
1.6	03/05-	BRY	1595	23x138	SK-1109AQ2	BTKW
1.6 BiFuel	05/11-	CHGA	1595	23x138	SK-1109AQ1	BTKW
1.6 TDI	08/10-	CAYD, CAYE	1598	25x160; → 11/2010	SK-1695	BTK
1.6 TDI	08/10-	CAYD, CAYE	1598	25x160; → 11/2010	SK-1695AQ1	BTKW
1.6 TDI	08/10-	CAYD	1598	25x160; → 11/2010; Baumuster: Caddy Maxi	SK-1695AQ1	BTKW
1.6 TDI	08/10-	CAYD, CAYE	1598	25x160; 12/2010 →	SK-1727	BTK
1.6 TDI	08/10-	CAYD, CAYE	1598	25x160; → 11/2010	SK-1727AQ2	BTKW
1.6, 1.6 BiFuel	03/05-	BRY, CHGA	1595	23x138	SK-1109	BTK
1.9 TDI	09/05-08/10	BSU	1896	30x120	SK-1372AQ1	BTKW
1.9 TDI, 1.9 TDI 4motion	04/04-08/10	BJB, BLS, BLS, BSU	1896	30x120; mit Zubehör	SK-1372	BTK
1.9 TDI, 1.9 TDI 4motion	04/04-08/10	BJB, BLS, BLS	1896	30x120; Baumuster: Caddy Maxi	SK-1372AQ1	BTKW
2.0 EcoFuel	04/06-	BSX	1984	23x138; Baumuster: 2KJ	SK-1109	BTK
2.0 EcoFuel	04/06-	BSX	1984	23x138	SK-1109AQ2	BTKW
2.0 SDI	03/04-08/10	BDJ, BST	1968	30x120	SK-1372AQ1	BTKW
2.0 SDI, 2.0 TDI	03/04-08/10	BDJ, BST, BMM	1968	30x120; mit Zubehör	SK-1372	BTK
2.0 TDI	09/07-08/10	BMM	1968	30x120; Baumuster: Caddy Maxi	SK-1372AQ2	BTKW
2.0 TDI	08/10-	CLCA	1968	25x160	SK-1727AQ2	BTKW
2.0 TDI	05/12-	CFJA	1968	25x160	SK-1727	BTK
2.0 TDI	05/12-	CFJA	1968	25x160	SK-1727AQ2	BTKW
2.0 TDI 16V, 2.0 TDI 16V 4motion	11/10-	CFHC	1968	25x160; → 11/2010	SK-1727AQ2	BTKW
2.0 TDI 4motion	08/10-	CFHF	1968	25x160; → 11/2010	SK-1727AQ2	BTKW
2.0 TDI, 2.0 TDI 16V, 2.0 TDI 16V 4motion, 2.0 TDI 4motion	08/10-	CFHC, CFHC, CLCB, CFHF, CLCA	1968	25x160; → 11/2010	SK-1695AQ1	BTKW
2.0 TDI, 2.0 TDI 16V, 2.0 TDI 16V 4motion, 2.0 TDI 4motion	08/10-	CFHC, CFHC, CLCB, CFHF, CLCA	1968	25x160; → 11/2010; Baumuster: Caddy Maxi	SK-1695AQ1	BTKW
2.0 TDI, 2.0 TDI 16V, 2.0 TDI 16V 4motion, 2.0 TDI 4motion	08/10-	CFHC, CFHC, CLCB, CFHF, CLCA	1968	25x160; 12/2010 →	SK-1727	BTK
2.0 TDI, 2.0 TDI 4motion	08/10-	CFHF, CLCA	1968	25x160; → 11/2010	SK-1695	BTK
1.4	03/04-05/06	BCA	1390		0-N164	TB [DG]
1.4, 1.4 16V	03/04-08/10	BCA, BUD	1390		0-N1262	TB [DG]
1.4, 1.4 16V	03/04-08/10	BCA, BUD	1390		0-N1263	TB [TE]
1.4, 1.4 16V	03/04-08/10	BCA, BUD	1390		0-N158	TB [TE]
1.6	04/04-	BGU, BSE, BSF	1595		0-N157	TB [TE]
1.6 TDI	08/10-	CAYD, CAYE	1598		0-N131	TB [DG]
1.6 TDI	08/10-	CAYD, CAYE	1598		0-N2025	TB [DG]
1.6 TDI	08/10-	CAYD, CAYE	1598		0-N2200	TB [DG]
1.9 TDI, 1.9 TDI 4motion	04/04-08/10	BJB, BLS, BLS, BSU	1896		0-N1045	TB [TE]
1.9 TDI, 1.9 TDI 4motion	04/04-08/10	BJB, BLS, BLS, BSU	1896		0-N1046	TB [DG]
2.0 EcoFuel	04/06-	BSX	1984		0-N157	TB [TE]
2.0 SDI, 2.0 TDI	03/04-08/10	BDJ, BST, BMM	1968		0-N1045	TB [TE]
2.0 SDI, 2.0 TDI	03/04-08/10	BDJ, BST, BMM	1968		0-N1046	TB [DG]
2.0 TDI 16V, 2.0 TDI 16V 4motion, 2.0 TDI 4motion	08/10-	CFHC, CFHC, CLCB, CFHF	1968		0-N2025	TB [DG]
2.0 TDI, 2.0 TDI 16V, 2.0 TDI 16V 4motion, 2.0 TDI 4motion	08/10-	CFHC, CFHC, CLCB, CFHF, CFJA, CLCA	1968		0-N131	TB [DG]
2.0 TDI, 2.0 TDI 16V, 2.0 TDI 16V 4motion, 2.0 TDI 4motion	08/10-	CFHC, CFHC, CLCB, CFHF, CFJA, CLCA	1968		0-N2200	TB [DG]
1.2 TSI	09/10-	CBZA, CBZB	1197	⊛	0-N1733	VB [BT] S
1.2 TSI	09/10-	CBZA, CBZB	1197	⊛	0-N2121	VB [DG]
1.4, 1.4 16V	03/04-08/10	BCA, BUD	1390	⊛	0-N1445	VB [BT] S
1.6 TDI	08/10-	CAYD, CAYE	1598		0-N1534	VB [BT] S
1.9 TDI	04/04-08/10	BJB	1896	ch.→2K-5-150000	0-N1530	VB [BT] S
1.9 TDI	04/04-08/10	BJB	1896	ch.2K-6-000001→	0-N1531	VB [BT] S
1.9 TDI	04/04-08/10	BLS	1896	ch.5P-6-000001→	0-N1531	VB [BT] S
1.9 TDI, 1.9 TDI 4motion	09/05-08/10	BLS, BSU	1896		0-N1531	VB [BT] S
2.0 SDI	03/04-08/10	BDJ, BST	1968	ch.→2K-5-150000	0-N1530	VB [BT] S
2.0 SDI	03/04-08/10	BDJ, BST	1968	ch.2K-6-000001→	0-N1531	VB [BT] S
2.0 TDI	09/07-08/10	BMM	1968		0-N1531	VB [BT] S
2.0 TDI, 2.0 TDI 16V, 2.0 TDI 16V 4motion, 2.0 TDI 4motion	08/10-	CFHC, CFHC, CLCB, CFHF, CFJA, CLCA	1968		0-N1534	VB [BT] S
CC (358)						
2.0 TDI	11/11-	CFFA, CFFB	1968	25x160	SK-1727AQ2	BTKW
2.0 TDI, 2.0 TDI 4motion	11/11-	CFFA, CFFB, CFGB, CFGB, CLLA, CFGC	1968	25x160	SK-1727	BTK



CM³



Art. Nr.



CC (358)							
2.0 TDI, 2.0 TDI 4motion	11/11-	CFFB, CFGB, CFGB, CLLA, CFGC	1968	25x160		SK-1727AQ2	BTKW
2.0 TDI, 2.0 TDI 4motion	11/11-	CFFA, CFFB, CFGB, CFGB, CLLA, CFGC	1968			0-N131	TB [DG]
2.0 TDI, 2.0 TDI 4motion	11/11-	CFFA, CFFB, CFGB, CFGB, CLLA, CFGC	1968			0-N2200	TB [DG]
1.4 TSI, 1.4 TSI MultiFuel	11/11-	CKMA, CTHD	1390			0-N2092	VB [BT] S
1.4 TSI, 1.4 TSI MultiFuel	11/11-	CKMA, CTHD	1390	*		0-N2111	VB [BT] S
1.8 TSI	11/11-	CDA, CDAB	1798			0-N1832	VB [BT] S
2.0 TDI, 2.0 TDI 4motion	11/11-	CFFA, CFFB, CFGB, CFGB, CLLA, CFGC	1968			0-N1534	VB [BT] S
2.0 TSI	11/11-	CBFA, CCTA, CCZB	1984			0-N1832	VB [BT] S
3.6 FSI 4motion	11/11-	BWS	3597			0-N2209	VB [BT] S

CORRADO (53I)							
1.8 16V	04/89-07/92	KR	1781	25x147; :→KR131261		SK-1047	BTK
1.8 16V	04/89-07/92	KR	1781	25x147; :131262→; Baumuster: 509		SK-1124	BTK
1.8 G60	09/88-09/93	PG	1781	18x121; mit Zubehör		SK-1026	BTK
2.0 i	04/93-12/95	2E, ADY	1984	18x124; mit Zubehör		SK-1120	BTK
2.0 i 16V	08/91-12/95	9A	1984	25x147; :→9A131261		SK-1047	BTK
2.0 i 16V	08/91-12/95	9A	1984	25x147; → 05/1995; :131262→; Baumuster: 509		SK-1124	BTK
1.8 16V	04/89-07/92	KR	1781			0-N808	TB [TE]
1.8 G60	09/88-09/93	PG	1781			0-N805	TB [TE]
2.0 i	04/93-12/95	2E, ADY	1984			0-N805	TB [TE]
2.0 i 16V	08/91-12/95	9A	1984	:131262→		0-N129	TB [TE]
2.0 i 16V	08/91-12/95	9A	1984			0-N808	TB [TE]
1.8 G60	09/88-09/93	PG	1781			0-N1311	VB [DG]
2.0 i, 2.0 i 16V	08/91-12/95	2E, ADY, 9A	1984			0-N1417	VB [TE]
2.9 VR6	08/91-12/95	ABV	2861	Rippenanzahl: 7		0-N1657	VB [BT] S

CRAFTER 30-35 Bus (2E_)							
2.0 TDI, 2.0 TDI 4motion	05/11-	CKTB, CKTC, CKUB, CSNA, CSLB	1968	25x160		SK-1727	BTK
2.0 TDI, 2.0 TDI 4motion	05/11-	CKTB, CKTC, CKUB, CSNA, CKUC	1968	25x160		SK-1727AQ2	BTKW
2.5 TDI	04/06-07/11	BJJ, CEBA, BJK, CEBB, BJL, CECA, BJM, CECB	2461	26x141; mit Zubehör		SK-1686	BTK
2.5 TDI	04/06-07/11	BJJ, CEBA, BJK, CEBB, BJL, CECA, BJM, CECB	2461	26x141; mit Zubehör; Baumuster: Crafter 30		SK-1686AQ1	BTKW
2.5 TDI	04/06-07/11	BJJ, CEBA, BJK, CEBB, BJL, CECA, BJM, CECB	2461	26x141; mit Zubehör; Baumuster: Crafter 35		SK-1686AQ1	BTKW
2.0 TDI, 2.0 TDI 4motion	05/11-	CKTB, CKTC, CKUB, CSNA, CKUC	1968			0-N131	TB [DG]
2.0 TDI, 2.0 TDI 4motion	05/11-	CKTB, CKTC, CKUB, CSNA, CKUC	1968			0-N2200	TB [DG]
2.5 TDI	04/06-07/11	BJJ, CEBA, BJK, CEBB, BJL, CECA, BJM, CECB	2461			0-N116	TB [TE]
2.5 TDI	04/06-07/11	BJJ, CEBA, BJK, CEBB, BJL, CECA, BJM, CECB	2461			0-N131	TB [DG]
2.5 TDI	04/06-07/11	BJJ, CEBA, BJK, CEBB, BJL, CECA, BJM, CECB	2461			0-N166	TB [DG]
2.0 TDI	05/11-	CKTB, CKTC, CKUB, CSNA	1968	Baumuster: + XTR AC COMPR, Crafter 30		0-N2288	VB [BT] S
2.0 TDI	05/11-	CKTB, CKTC, CKUB, CSNA	1968	Baumuster: + XTR AC COMPR, Crafter 35		0-N2288	VB [BT] S
2.0 TDI	05/11-	CKTB, CKTC, CKUB, CSNA	1968	Baumuster: Crafter 30; für Fahrzeuge mit zwei Generatoren		0-N2288	VB [BT] S
2.0 TDI	05/11-	CKTB, CKTC, CKUB, CSNA	1968	Baumuster: Crafter 35; für Fahrzeuge mit zwei Generatoren		0-N2288	VB [BT] S
2.0 TDI 4motion	11/11-	CKUB, CSNA	1968	Baumuster: + XTR AC COMPR		0-N2288	VB [BT] S
2.0 TDI 4motion	11/11-	CKUB, CSNA	1968	für Fahrzeuge mit zwei Generatoren		0-N2288	VB [BT] S
2.0 TDI, 2.0 TDI 4motion	05/11-	CKTB, CKTC, CKUB, CSNA, CKUC	1968			0-N1534	VB [BT] S
2.5 TDI	04/06-07/11	BJJ, CEBA, BJK, CEBB, BJL, CECA, BJM, CECB	2461			0-N1906	VB [DG]
2.5 TDI	04/06-07/11	BJJ, CEBA, BJK, CEBB, BJL, CECA, BJM, CECB	2461	*		0-N1915	VB [DG]
2.5 TDI	04/06-07/11	BJJ, CEBA, BJK, CEBB, BJL, CECA, BJM, CECB	2461			0-N1943	VB [VD]
2.5 TDI	04/06-07/11	BJJ, CEBA, BJK, CEBB, BJL, CECA, BJM, CECB	2461			0-N1954	VB [BT] S

CRAFTER 30-50 Kasten (2E_)							
2.0 TDI, 2.0 TDI 4motion	05/11-	CKTB, CKTC, CKUB, CSNA, CKUC, CSLB	1968	25x160		SK-1727	BTK
2.0 TDI, 2.0 TDI 4motion	05/11-	CKTB, CKTC, CKUB, CSNA, CKUC	1968	25x160		SK-1727AQ2	BTKW
2.5 TDI	04/06-07/11	BJJ, CEBA, BJK, CEBB, BJL, CECA, BJM, CECB	2461	26x141; mit Zubehör		SK-1686	BTK
2.5 TDI	04/06-07/11	BJJ, CEBA, BJK, CEBB, BJL, CECA, BJM, CECB	2461	26x141; mit Zubehör; Baumuster: Crafter 28		SK-1686AQ1	BTKW
2.5 TDI	04/06-07/11	BJJ, CEBA, BJK, CEBB, BJL, CECA, BJM, CECB	2461	26x141; mit Zubehör; Baumuster: Crafter 30		SK-1686AQ1	BTKW



CM³



Art. Nr.



CRAFTER 30-50 Kasten (2E_)

2.5 TDI	04/06-07/11	BJJ, CEBA, BJK, CEBB, BJL, CECA, BJM, CECB	2461	26x141; mit Zubehör; Baumuster: Crafter 32	SK-1686AQ1	BTKW	
2.5 TDI	04/06-07/11	BJJ, CEBA, BJK, CEBB, BJL, CECA, BJM, CECB	2461	26x141; mit Zubehör; Baumuster: Crafter 35	SK-1686AQ1	BTKW	
2.5 TDI	04/06-07/11	BJK, CEBB, BJL, CECA, BJM, CECB	2461	26x141; mit Zubehör; Baumuster: Crafter 46	SK-1686AQ1	BTKW	
2.5 TDI	04/06-07/11	BJK, CEBB, BJL, CECA, BJM, CECB	2461	26x141; mit Zubehör; Baumuster: Crafter 50	SK-1686AQ1	BTKW	
2.0 TDI, 2.0 TDI 4motion	05/11-	CKTB, CKTC, CKUB, CSNA, CKUC	1968		0-N131	TB [DG]	
2.0 TDI, 2.0 TDI 4motion	05/11-	CKTB, CKTC, CKUB, CSNA, CKUC	1968		0-N2200	TB [DG]	
2.5 TDI	04/06-07/11	BJJ, CEBA, BJK, CEBB, BJL, CECA, BJM, CECB	2461		0-N116	TB [TE]	
2.5 TDI	04/06-07/11	BJJ, CEBA, BJK, CEBB, BJL, CECA, BJM, CECB	2461		0-N131	TB [DG]	
2.5 TDI	04/06-07/11	BJJ, CEBA, BJK, CEBB, BJL, CECA, BJM, CECB	2461		0-N166	TB [DG]	
2.0 TDI	05/11-	CKTB, CKTC, CKUB, CSNA, CKUC	1968	Baumuster: + XTR AC COMPR, Crafter 28	0-N2288	VB [BT]	S
2.0 TDI	05/11-	CKTB, CKTC, CKUB, CSNA, CKUC	1968	Baumuster: + XTR AC COMPR, Crafter 30	0-N2288	VB [BT]	S
2.0 TDI	05/11-	CKTB, CKTC, CKUB, CSNA, CKUC	1968	Baumuster: + XTR AC COMPR, Crafter 32	0-N2288	VB [BT]	S
2.0 TDI	05/11-	CKTB, CKTC, CKUB, CSNA, CKUC	1968	Baumuster: + XTR AC COMPR, Crafter 35	0-N2288	VB [BT]	S
2.0 TDI	05/11-	CKTB, CKTC, CKUB, CSNA, CKUC	1968	Baumuster: + XTR AC COMPR, Crafter 46	0-N2288	VB [BT]	S
2.0 TDI	05/11-	CKTB, CKTC, CKUB, CSNA, CKUC	1968	Baumuster: + XTR AC COMPR, Crafter 50	0-N2288	VB [BT]	S
2.0 TDI	05/11-	CKTB, CKTC, CKUB, CSNA, CKUC	1968	Baumuster: Crafter 28; für Fahrzeuge mit zwei Generatoren	0-N2288	VB [BT]	S
2.0 TDI	05/11-	CKTB, CKTC, CKUB, CSNA, CKUC	1968	Baumuster: Crafter 30; für Fahrzeuge mit zwei Generatoren	0-N2288	VB [BT]	S
2.0 TDI	05/11-	CKTB, CKTC, CKUB, CSNA, CKUC	1968	Baumuster: Crafter 32; für Fahrzeuge mit zwei Generatoren	0-N2288	VB [BT]	S
2.0 TDI	05/11-	CKTB, CKTC, CKUB, CSNA, CKUC	1968	Baumuster: Crafter 35; für Fahrzeuge mit zwei Generatoren	0-N2288	VB [BT]	S
2.0 TDI	05/11-	CKTB, CKTC, CKUB, CSNA, CKUC	1968	Baumuster: Crafter 46; für Fahrzeuge mit zwei Generatoren	0-N2288	VB [BT]	S
2.0 TDI	05/11-	CKTB, CKTC, CKUB, CSNA, CKUC	1968	Baumuster: Crafter 50; für Fahrzeuge mit zwei Generatoren	0-N2288	VB [BT]	S
2.0 TDI 4motion	11/11-	CKUB, CSNA	1968	Baumuster: + XTR AC COMPR	0-N2288	VB [BT]	S
2.0 TDI 4motion	11/11-	CKUB, CSNA	1968	für Fahrzeuge mit zwei Generatoren	0-N2288	VB [BT]	S
2.0 TDI, 2.0 TDI 4motion	05/11-	CKTB, CKTC, CKUB, CSNA, CKUC	1968		0-N1534	VB [BT]	S
2.5 TDI	04/06-07/11	BJJ, CEBA, BJK, CEBB, BJL, CECA, BJM, CECB	2461		0-N1906	VB [DG]	
2.5 TDI	04/06-07/11	BJJ, CEBA, BJK, CEBB, BJL, CECA, BJM, CECB	2461	✳	0-N1915	VB [DG]	
2.5 TDI	04/06-07/11	BJJ, CEBA, BJK, CEBB, BJL, CECA, BJM, CECB	2461		0-N1943	VB [VD]	
2.5 TDI	04/06-07/11	BJJ, CEBA, BJK, CEBB, BJL, CECA, BJM, CECB	2461		0-N1954	VB [BT]	S

CRAFTER 30-50 Pritsche/Fahrgestell (2F_)

2.0 TDI, 2.0 TDI 4motion	05/11-	CKTB, CKTC, CKUB, CSNA, CKUC, CSLB	1968	25x160	SK-1727	BTK	
2.0 TDI, 2.0 TDI 4motion	05/11-	CKTB, CKTC, CKUB, CSNA, CKUC	1968	25x160	SK-1727AQ2	BTKW	
2.5 TDI	04/06-07/11	BJJ, CEBA, BJK, CEBB, BJL, CECA, BJM, CECB	2461	26x141; mit Zubehör	SK-1686	BTK	
2.5 TDI	04/06-07/11	BJJ, CEBA, BJK, CEBB, BJL, CECA, BJM, CECB	2461	26x141; mit Zubehör; Baumuster: Crafter 28	SK-1686AQ1	BTKW	
2.5 TDI	04/06-07/11	BJJ, CEBA, BJK, CEBB, BJL, CECA, BJM, CECB	2461	26x141; mit Zubehör; Baumuster: Crafter 30	SK-1686AQ1	BTKW	
2.5 TDI	04/06-07/11	BJJ, CEBA, BJK, CEBB, BJL, CECA, BJM, CECB	2461	26x141; mit Zubehör; Baumuster: Crafter 32	SK-1686AQ1	BTKW	
2.5 TDI	04/06-07/11	BJJ, CEBA, BJK, CEBB, BJL, CECA, BJM, CECB	2461	26x141; mit Zubehör; Baumuster: Crafter 35	SK-1686AQ1	BTKW	
2.5 TDI	04/06-07/11	BJK, CEBB, BJL, CECA, BJM, CECB	2461	26x141; mit Zubehör; Baumuster: Crafter 46	SK-1686AQ1	BTKW	
2.5 TDI	04/06-07/11	BJK, CEBB, BJL, CECA, BJM, CECB	2461	26x141; mit Zubehör; Baumuster: Crafter 50	SK-1686AQ1	BTKW	
2.0 TDI, 2.0 TDI 4motion	05/11-	CKTB, CKTC, CKUB, CSNA, CKUC	1968		0-N131	TB [DG]	
2.0 TDI, 2.0 TDI 4motion	05/11-	CKTB, CKTC, CKUB, CSNA, CKUC	1968		0-N2200	TB [DG]	
2.5 TDI	04/06-07/11	BJJ, CEBA, BJK, CEBB, BJL, CECA, BJM, CECB	2461		0-N116	TB [TE]	
2.5 TDI	04/06-07/11	BJJ, CEBA, BJK, CEBB, BJL, CECA, BJM, CECB	2461		0-N131	TB [DG]	
2.5 TDI	04/06-07/11	BJJ, CEBA, BJK, CEBB, BJL, CECA, BJM, CECB	2461		0-N166	TB [DG]	
2.0 TDI	05/11-	CKTB, CKUB, CSNA, CKUC	1968	Baumuster: + XTR AC COMPR, Crafter 28	0-N2288	VB [BT]	S
2.0 TDI	05/11-	CKTB, CKTC, CKUB, CSNA, CKUC	1968	Baumuster: + XTR AC COMPR, Crafter 30	0-N2288	VB [BT]	S
2.0 TDI	05/11-	CKTB, CKTC, CKUB, CSNA, CKUC	1968	Baumuster: + XTR AC COMPR, Crafter 32	0-N2288	VB [BT]	S
2.0 TDI	05/11-	CKTB, CKTC, CKUB, CSNA, CKUC	1968	Baumuster: + XTR AC COMPR, Crafter 35	0-N2288	VB [BT]	S
2.0 TDI	05/11-	CKTB, CKUB, CSNA, CKUC	1968	Baumuster: + XTR AC COMPR, Crafter 46	0-N2288	VB [BT]	S

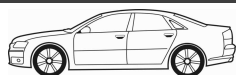

CM³



Art. Nr.



CRAFTER 30-50 Pritsche/Fahrgestell (2F_)							
2.0 TDI	05/11-	CKTB, CKTC, CKUB, CSNA, CKUC	1968	Baumuster: + XTR AC COMPR, Crafter 50	0-N2288	VB [BT]	S
2.0 TDI	05/11-	CKTB, CKUB, CSNA, CKUC	1968	Baumuster: Crafter 28; für Fahrzeuge mit zwei Generatoren	0-N2288	VB [BT]	S
2.0 TDI	05/11-	CKTB, CKTC, CKUB, CSNA, CKUC	1968	Baumuster: Crafter 30; für Fahrzeuge mit zwei Generatoren	0-N2288	VB [BT]	S
2.0 TDI	05/11-	CKTB, CKTC, CKUB, CSNA, CKUC	1968	Baumuster: Crafter 32; für Fahrzeuge mit zwei Generatoren	0-N2288	VB [BT]	S
2.0 TDI	05/11-	CKTB, CKTC, CKUB, CSNA, CKUC	1968	Baumuster: Crafter 35; für Fahrzeuge mit zwei Generatoren	0-N2288	VB [BT]	S
2.0 TDI	05/11-	CKTB, CKUB, CSNA, CKUC	1968	Baumuster: Crafter 46; für Fahrzeuge mit zwei Generatoren	0-N2288	VB [BT]	S
2.0 TDI	05/11-	CKTB, CKTC, CKUB, CSNA, CKUC	1968	Baumuster: Crafter 50; für Fahrzeuge mit zwei Generatoren	0-N2288	VB [BT]	S
2.0 TDI 4motion	11/11-	CKUB, CSNA	1968	Baumuster: + XTR AC COMPR	0-N2288	VB [BT]	S
2.0 TDI 4motion	11/11-	CKUB, CSNA	1968	für Fahrzeuge mit zwei Generatoren	0-N2288	VB [BT]	S
2.0 TDI, 2.0 TDI 4motion	05/11-	CKTB, CKTC, CKUB, CSNA, CKUC	1968		0-N1534	VB [BT]	S
2.5 TDI	04/06-07/11	BJJ, CEBA, BJK, CEBB, BJL, CECA, BJM, CECB	2461		0-N1906	VB [DG]	
2.5 TDI	04/06-07/11	BJJ, CEBA, BJK, CEBB, BJL, CECA, BJM, CECB	2461	✳	0-N1915	VB [DG]	
2.5 TDI	04/06-07/11	BJJ, CEBA, BJK, CEBB, BJL, CECA, BJM, CECB	2461		0-N1943	VB [VD]	
2.5 TDI	04/06-07/11	BJJ, CEBA, BJK, CEBB, BJL, CECA, BJM, CECB	2461		0-N1954	VB [BT]	S
EOS (1F7, 1F8)							
2.0 FSI	03/06-05/08	BVY, BVZ	1984	23x148	SK-1724	BTK	
2.0 FSI	03/06-05/08	BVY, BVZ	1984	23x148	SK-1724AQ2	BTKW	
2.0 TDI	06/06-05/08	BMM	1968	30x120; mit Zubehör	SK-1372	BTK	
2.0 TDI	06/06-05/08	BMM	1968	30x120	SK-1372AQ2	BTKW	
2.0 TDI	11/10-	CFFA	1968	25x160; → 11/2010	SK-1695AQ1	BTKW	
2.0 TDI	11/10-	CFFA	1968	25x160	SK-1727	BTK	
2.0 TDI	11/10-	CFFA, CFFB	1968	25x160	SK-1727AQ2	BTKW	
2.0 TDI 16V	05/08-	CBAB, CFFB	1968	30x160; → 11/2010	SK-1694	BTK	
2.0 TDI 16V	05/08-	CBAB	1968	30x160	SK-1694AQ1	BTKW	
2.0 TDI 16V	05/08-	CFFB	1968	25x160	SK-1727	BTK	
2.0 TDI 16V	05/08-	CFFA, CFFB	1968	25x160; → 11/2010	SK-1727AQ2	BTKW	
2.0 TFSI	03/06-	BPY, BWA	1984	23x148	SK-1724	BTK	
2.0 TFSI	03/06-	BPY, BWA	1984	23x148	SK-1724AQ1	BTKW	
1.4 TSI	11/13-	CXSB	1390		0-N2313	TB [TE]	
1.4 TSI	11/13-	CHPB	1395		0-N2313	TB [TE]	
1.4 TSI	11/13-	CXSB	1390		0-N2381	TB [DG]	
1.4 TSI	11/13-	CHPB	1395		0-N2381	TB [DG]	
2.0 FSI	03/06-05/08	BVY, BVZ	1984		0-N1316	TB [DG]	
2.0 FSI	03/06-05/08	BVY, BVZ	1984		0-N1346	TB [DG]	
2.0 FSI	03/06-05/08	BVY, BVZ	1984		0-N2208	TB [TE]	
2.0 TDI	06/06-05/08	BMM	1968		0-N1045	TB [TE]	
2.0 TDI	06/06-05/08	BMM	1968		0-N1046	TB [DG]	
2.0 TDI	11/10-	CFFA	1968		0-N131	TB [DG]	
2.0 TDI	11/10-	CFFA	1968		0-N2025	TB [DG]	
2.0 TDI	11/10-	CFFA	1968		0-N2200	TB [DG]	
2.0 TDI 16V	05/08-	CBAB	1968		0-N1046	TB [DG]	
2.0 TDI 16V	05/08-	CBAB	1968		0-N1268	TB [DG]	
2.0 TDI 16V	05/08-	CFFB	1968		0-N131	TB [DG]	
2.0 TDI 16V	05/08-	CBAB	1968		0-N1336	TB [DG]	
2.0 TDI 16V	05/08-	CBAB	1968		0-N1905	TB [BT]	
2.0 TDI 16V	05/08-	CFFB	1968		0-N2025	TB [DG]	
2.0 TDI 16V	05/08-	CFFB	1968		0-N2200	TB [DG]	
2.0 TFSI	03/06-	BPY, BWA	1984		0-N1316	TB [DG]	
2.0 TFSI	03/06-	BPY, BWA	1984		0-N1346	TB [DG]	
2.0 TFSI	03/06-	BWA, BPY	1984		0-N2208	TB [TE]	
1.4 TSI	11/07-	CAXA	1390	†; ✳	0-N1454	VB [DG]	
1.4 TSI	11/07-	CAXA	1390	✳	0-N1525	VB [BT]	S
1.4 TSI	11/07-	CAXA	1390	✳	0-N1733	VB [BT]	S
1.4 TSI	05/08-	CAVD, CTHD	1390	✳	0-N2050	VB [DG]	
1.4 TSI	05/08-	CAVD, CTHD	1390	✳	0-N2091	VB [BT]	S
1.4 TSI	05/08-	CAVD, CTHD	1390	✳	0-N2092	VB [BT]	S
1.4 TSI	05/08-	CAVD, CTHD	1390	✳	0-N2111	VB [BT]	S
1.4 TSI	05/08-	CAVD, CTHD	1390	Rippenanzahl: 6	0-N2133	VB [DG]	



CM³



Art. Nr.



EOS (1F7, 1F8)

1.6 FSI	06/06-05/08	BLF	1598	†	0-N1454	VB [DG]	
1.6 FSI	06/06-05/08	BLF	1598		0-N1525	VB [BT]	S
1.6 FSI	06/06-05/08	BLF	1598	✳	0-N1733	VB [BT]	S
2.0 TDI	06/06-05/08	BMM	1968		0-N1531	VB [BT]	S
2.0 TDI	11/10-	CFFA	1968		0-N1534	VB [BT]	S
2.0 TDI 16V	05/08-	CBAB, CFFB	1968		0-N1534	VB [BT]	S
2.0 TFSI	03/06-	BWA	1984		0-N1656	VB [BT]	S
2.0 TFSI	03/06-	CAWB, CBFA, CCTA, CCZA	1984		0-N1832	VB [BT]	S
2.0 TSI	11/09-	CCZB	1984		0-N1832	VB [BT]	S
3.2 V6	06/06-05/09	BUB, CBRA	3189		0-N1715	VB [DG]	
3.2 V6	06/06-05/09	BUB, CBRA	3189		0-N2209	VB [BT]	S
3.6 V6	05/09-11/10	CDVA	3597		0-N1715	VB [DG]	
3.6 V6	05/09-11/10	CDVA	3597		0-N2209	VB [BT]	S

FOX (5Z1, 5Z3)

1.4	04/05-	BKR	1390	19x135; mit Zubehör	SK-1592	BTK	
1.4 TDI	04/05-	BNM	1422	30x120; mit Zubehör	SK-1372	BTK	
1.4 TDI	04/05-	BNM	1422	30x120	SK-1372AQ1	BTKW	
1.6	10/03-	BAH, BJA, BLH, BPA, CCRA, CFZA	1598	19x135; mit Zubehör	SK-1592	BTK	
1.4	04/05-	BKR	1390		0-N1331	TB [TE]	
1.4 TDI	04/05-	BNM	1422		0-N1045	TB [TE]	
1.4 TDI	04/05-	BNM	1422		0-N1046	TB [DG]	
1.6, 1.6 Total Flex	10/03-	BAH, BJA, BLH, BPA, CCRA, CFZA, BJA, BPA, CCRA	1598		0-N1331	TB [TE]	
1.2	04/05-	BMD, CHFB, CHFA	1198		0-N1908	VB [BT]	S
1.2	04/05-	BMD, CHFB, CHFA	1198	✳	0-N1909	VB [DG]	
1.4	04/05-	BKR	1390		0-N1445	VB [BT]	S
1.4 TDI	04/05-	BNM	1422		0-N1704	VB [BT]	S
1.6, 1.6 Total Flex	10/03-	BAH, BJA, BLH, BPA, CCRA, CFZA, BJA, BPA, CCRA	1598	ch.→5Z-64-157000, 5Z-6P-002625; für Fahrzeuge mit Servolenkung	0-N1445	VB [BT]	S

GOL II

1.0	09/97-05/02	AFR, AZP	999	ch.5X-4P-123865→	0-N1258	TB [TE]	
1.0	09/97-05/02	AFR, AZP	999	ch.5X-4T-178067→	0-N1258	TB [TE]	
1.0	09/97-05/02	AFR, AZP	999	ch.5X-4P-123865→	0-N165	TB [DG]	
1.0	09/97-05/02	AFR, AZP	999	ch.5X-4T-178067→	0-N165	TB [DG]	
1.0	09/97-05/02	AFR, AZP	999	✳	0-N1605	VB [DG]	
1.0	09/97-05/02	AFR, AZP	999	✳, für Fahrzeuge mit Servolenkung	0-N1890	VB [BT]	S

GOL IV

1.0	10/05-05/08	BTY	999	19x135; mit Zubehör	SK-1592	BTK	
1.0	10/05-05/08	BTY	999		0-N1331	TB [TE]	
1.0	10/05-05/08	BTY	999	✳	0-N1605	VB [DG]	
1.0	10/05-05/08	BTY	999	✳	0-N1885	VB [BT]	
1.0	10/05-05/08	BTY	999	✳	0-N1885S1	VB [TE]	
1.0	10/05-05/08	BTY	999	✳	0-N1885S2	VB [TE]	

GOLF I (17)

1.5	04/74-12/75	FH	1471	18x121; mit Zubehör	SK-1026	BTK	
1.5	08/77-07/83	JB	1457	18x121; mit Zubehör	SK-1026	BTK	
1.5 D	08/76-07/80	CK	1471	25x135; mit Zubehör	SK-1001	BTK	
1.6	01/83-02/84	EW, HN	1595	18x121; mit Zubehör	SK-1026	BTK	
1.6 D	08/80-07/83	CR, JK	1588	25x135; mit Zubehör	SK-1001	BTK	
1.6 TD	03/82-07/83	CY	1588	25x135; 08/1982 →; mit Zubehör	SK-1001	BTK	
1.6, 1.6 GTI	08/75-02/84	EG, EM, EM, EM, FN, FN, FP, FT	1588	18x121; mit Zubehör	SK-1026	BTK	
1.8 GTI	08/82-12/83	DX, JJ, JJ	1781	18x121; mit Zubehör	SK-1026	BTK	
1.5	04/74-12/75	FH	1471		0-N805	TB [TE]	
1.5	08/77-07/83	JB	1457		0-N805	TB [TE]	
1.5 D	08/76-07/80	CK	1471		0-N806	TB [TE]	
1.6	01/83-02/84	EW, HN	1595		0-N805	TB [TE]	
1.6 D, 1.6 TD	08/80-07/83	CR, JK, CY	1588		0-N806	TB [TE]	
1.6, 1.6 GTI	08/75-02/84	EG, EM, EM, EM, FN, FN, FP, FT	1588		0-N805	TB [TE]	
1.8 GTI	08/82-12/83	DX, JJ, JJ	1781		0-N805	TB [TE]	

GOLF I Cabriolet (155)

1.5	01/79-11/83	JB	1457	18x121; 12/1979 →; mit Zubehör	SK-1026	BTK	
1.6	08/79-07/82	EG	1588	18x121; mit Zubehör	SK-1026	BTK	
1.6	08/83-04/92	EW, HN, RE	1595	18x121; mit Zubehör	SK-1026	BTK	
1.8	08/82-04/93	2H, DX, DX, EV, PB, EX, JH	1781	18x121; mit Zubehör	SK-1026	BTK	



CM³



Art. Nr.



GOLF I Cabriolet (155)						
1.5	01/79-11/83	JB	1457		0-N805	TB [TE]
1.6	08/79-07/82	EG	1588		0-N805	TB [TE]
1.6	08/83-04/92	EW, HN, RE	1595		0-N805	TB [TE]
1.8	08/82-04/93	2H, DX, DX, EV, PB, EX, JH	1781		0-N805	TB [TE]
GOLF II (19E, 1G1)						
1.3 KAT	06/86-12/92	NZ	1272	19x128; 10/1990 →; :NZ200001→	R-1190AQ1	BTKW
1.6	08/83-12/92	ABN, EZ, HM, HM, PN, RF	1595	18x121; mit Zubehör	SK-1026	BTK
1.6 D, 1.6 TD	08/83-10/91	JP, ME, JR, MF, RA, SB	1588	25x135; mit Zubehör	SK-1001	BTK
1.6 TD	08/89-10/91	1V	1589	25x135; mit Zubehör	SK-1001	BTK
1.8 GTI 16V	02/86-10/91	KR, PL	1781	25x147	SK-1047	BTK
1.8, 1.8 GTI, 1.8 GTI G60, 1.8 GTI G60 Syncro, 1.8 GTI KAT, 1.8 i KAT, 1.8 i Syncro KAT, 1.8 Syncro	08/83-12/91	1H, PG, 1P, DX, EV, GZ, GZ, PB, GU, GX, GU, GX, HV, HV, GX, RP, HT, RV, PF, PG, RD, RH, RP	1781	18x121; mit Zubehör	SK-1026	BTK
1.6	08/83-07/92	HM	1595		0-N805	TB [TE]
1.6	02/86-12/92	PN, RF	1595		0-N805	TB [TE]
1.6 D, 1.6 TD	08/83-10/91	JP, ME, JR, MF, RA, SB	1588		0-N806	TB [TE]
1.6 TD	08/89-10/91	1V	1589		0-N806	TB [TE]
1.8 GTI 16V	02/86-10/91	KR, PL	1781		0-N808	TB [TE]
1.8, 1.8 GTI, 1.8 GTI G60, 1.8 GTI G60 Syncro, 1.8 GTI KAT, 1.8 i KAT, 1.8 i Syncro KAT, 1.8 Syncro	08/83-12/91	1H, PG, 1P, DX, EV, GZ, GZ, PB, GU, GX, GU, GX, HV, HV, GX, RP, HT, RV, PF, PG, RD, RH, RP	1781		0-N805	TB [TE]
GOLF III (1H1)						
1.4	10/91-08/97	ABD	1390	19x128	R-1190AQ1	BTKW
1.4	10/91-08/97	AEX	1390	19x135; mit Zubehör	SK-1131	BTK
1.4	10/91-08/97	AEX	1390	19x135; mit Zubehör	SK-1131AQ1	BTKW
1.4	11/91-08/97	ABD, AEX	1390	19x128	R-1190AQ1	BTKW
1.6	09/92-08/97	ABU	1598	19x133; → 12/1994	R-1257AQ1	BTKW
1.6	09/92-08/97	AEA, AEE	1598	19x137; mit Zubehör	SK-1074	BTK
1.6	09/92-08/97	AEA, AEE	1598	19x137; 01/1995 →	SK-1074AQ1	BTKW
1.6	07/95-08/97	AEK, AFT, AKS	1595	18x121; mit Zubehör	SK-1090	BTK
1.8, 1.8 Syncro	11/91-08/97	AAM, ABS, ACC, ADZ, ABS, ADZ	1781	18x121; R...; → 07/1994; mit Zubehör	SK-1026	BTK
1.8, 1.8 Syncro	11/91-08/97	AAM, ABS, ACC, ADZ, ABS, ADZ	1781	18x121; 07/1994 →; mit Zubehör	SK-1090	BTK
1.9 D	11/91-08/97	1Y	1896	25.4x137; → 07/1994; :→1Y378364; mit Zubehör	SK-1029	BTK
1.9 D	11/91-08/97	1Y	1896	25.4x137; 07/1994 →; :378365→; mit Zubehör	SK-1122	BTK
1.9 SDI, 1.9 TDI	07/95-08/97	AEY, AFN	1896	25x137; mit Zubehör	SK-1098	BTK
1.9 TD,GTD	11/91-08/97	AAZ	1896	25.4x137; → 07/1994; :→AAZ552765; mit Zubehör	SK-1029	BTK
1.9 TD,GTD	11/91-08/97	AAZ	1896	25.4x137; 07/1994 →; :AAZ552766→; mit Zubehör	SK-1122	BTK
1.9 TDI	09/93-08/97	1Z	1896	25.4x137; → 07/1994; :→1Z289575; mit Zubehör	SK-1069	BTK
1.9 TDI	09/93-08/97	1Z, AHU, ALE	1896	25x137; 07/1994 →; :289576→; mit Zubehör	SK-1098	BTK
1.9 TDI Syncro	08/95-08/97	1Z	1896	25.4x137; :→1Z289575; mit Zubehör	SK-1069	BTK
1.9 TDI Syncro	08/95-08/97	1Z, AHU, ALE	1896	25x137; :289576→; mit Zubehör	SK-1098	BTK
2.0	11/91-08/97	2E, AGG, AKR	1984	18x124; mit Zubehör	SK-1120	BTK
2.0 GL, 2.0 Syncro	08/95-09/97	AEP, AGG	1984	18x124; mit Zubehör	SK-1120	BTK
2.0 GTI 16V	08/92-08/97	ABF	1984	25x151; 03/1994 →; :ABF020922→	SK-1104	BTK
2.0 GTI 16V	08/92-08/97	ABF	1984	25x151; → 03/1994; :→ABF020922	SK-1123	BTK
1.4	10/91-08/97	AEX, APQ	1390		0-N106	TB [TE]
1.4	11/91-08/97	AEX	1390		0-N106	TB [TE]
1.6	09/92-08/97	AEA, AEE	1598		0-N106	TB [TE]
1.6	07/95-08/97	AEK, AFT, AKS	1595		0-N805	TB [TE]
1.8, 1.8 Syncro	11/91-08/97	AAM, ABS, ACC, ADZ, ABS, ADZ	1781		0-N805	TB [TE]
1.9 D	11/91-08/97	1Y	1896	:378365→	0-N104	TB [TE]
1.9 D	11/91-08/97	1Y	1896	:→378364	0-N806	TB [TE]
1.9 D, 1.9 SDI, 1.9 TDI, 1.9 TDI Syncro	11/91-08/97	1Y, 1Z, AHU, ALE, AEY, AFN	1896		0-N128	TB [DG]
1.9 SDI, 1.9 TDI	07/95-08/97	AEY, AFN	1896		0-N104	TB [TE]
1.9 TD,GTD	11/91-08/97	AAZ	1896	:552766→	0-N104	TB [TE]
1.9 TD,GTD	11/91-08/97	AAZ	1896	:→552765	0-N806	TB [TE]
1.9 TDI, 1.9 TDI Syncro	09/93-08/97	1Z	1896	:→289575	0-N103	TB [TE]
1.9 TDI, 1.9 TDI Syncro	09/93-08/97	AHU, ALE	1896		0-N104	TB [TE]
1.9 TDI, 1.9 TDI Syncro	09/93-08/97	1Z	1896	:289576→	0-N104	TB [TE]
2.0 GTI 16V	08/92-08/97	ABF	1984	:020923→	0-N129	TB [TE]
2.0 GTI 16V	08/92-08/97	ABF	1984	:→020922	0-N808	TB [TE]

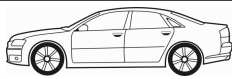

CM³



Art. Nr.



ohne Halter

GOLF III (1H1)

2.0, 2.0 GL, 2.0 Syncro	11/91-09/97	2E, ABA, ADY, AGG, AKR, AEP, AGG	1984		0-N805	TB [TE]	
1.4	10/91-08/97	ABD	1390	ch.1H-S-120 001→; für Fahrzeuge mit Servolenkung	0-N1445	VB [BT]	S
1.4	10/91-08/97	AEX, APQ	1390	für Fahrzeuge mit Servolenkung	0-N1445	VB [BT]	S
1.4	10/91-08/97	ABD	1390	ch.→1H-S-120000; für Fahrzeuge mit Servolenkung	0-N1459	VB [BT]	S
1.4	11/91-08/97	AEX	1390	für Fahrzeuge mit Servolenkung	0-N1445	VB [BT]	S
1.6	09/92-08/97	AEA, AEE	1598		0-N1417	VB [TE]	
1.6	09/92-08/97	ABU	1598	ch.1H-S-120 001→; für Fahrzeuge mit Servolenkung	0-N1445	VB [BT]	S
1.6	09/92-08/97	AEA, AEE	1598	für Fahrzeuge mit Servolenkung	0-N1445	VB [BT]	S
1.6	09/92-08/97	ABU	1598	ch.→1H-S-120000	0-N1459	VB [BT]	S
1.6	09/92-08/97	AEA, AEE	1598		0-N1660	VB [BT]	
1.6	07/95-08/97	AEK, AFT, AKS	1595		0-N1417	VB [TE]	
1.6	07/95-08/97	AEK, AFT, AKS	1595		0-N1660	VB [BT]	
1.8, 1.8 Syncro	11/91-08/97	AAM, ABS, ACC, ADZ, ABS, ADZ	1781		0-N1417	VB [TE]	
1.8, 1.8 Syncro	11/91-08/97	AAM, ABS, ACC, ADZ, ABS, ADZ	1781		0-N1660	VB [BT]	
1.9 D, 1.9 SDI, 1.9 TD,GTD, 1.9 TDI, 1.9 TDI Syncro	11/91-08/97	1Y, 1Z, AHU, ALE, AAZ, AEY, AFN	1896		0-N1417	VB [TE]	
1.9 D, 1.9 SDI, 1.9 TD,GTD, 1.9 TDI, 1.9 TDI Syncro	11/91-08/97	1Y, 1Z, AHU, ALE, AAZ, AEY, AFN	1896		0-N1609	VB [BT]	
2.0, 2.0 GL, 2.0 GTI 16V, 2.0 Syncro	11/91-09/97	2E, ABA, ADY, AGG, AKR, ABF, AEP, AGG	1984		0-N1417	VB [TE]	
2.0, 2.0 GTI 16V, 2.0 Syncro	11/91-08/97	2E, ABA, ADY, AGG, AKR, ABF, AGG	1984		0-N1660	VB [BT]	
2.8 VR6	01/92-08/97	AAA	2792	Rippenanzahl: 7	0-N1657	VB [BT]	S
2.8 VR6	08/95-09/97	AAA	2792	Rippenanzahl: 7;	0-N1657	VB [BT]	S
2.8 VR6	08/95-09/97	AAA	2792	Rippenanzahl: 7;	0-N1657	VB [BT]	S
2.9 VR6 Syncro	10/94-08/97	ABV	2861	Rippenanzahl: 7	0-N1657	VB [BT]	S

GOLF III Cabriolet (1E7)

1.6	10/94-05/98	AEK, AFT, AKS	1595	18x121; mit Zubehör	SK-1090	BTK	
1.8	07/93-05/98	AAM, ABS, ADZ	1781	18x121; R...; → 07/1994; mit Zubehör	SK-1026	BTK	
1.8	07/93-05/98	AAM, ABS, ADZ	1781	18x121; 07/1994 →; mit Zubehör	SK-1090	BTK	
1.9 TDI	08/95-05/98	1Z, AHU, ALE, AFN	1896	25x137; mit Zubehör	SK-1098	BTK	
2.0	07/93-05/98	ADY, AGG, AKR	1984	18x124; mit Zubehör	SK-1120	BTK	
1.6	10/94-05/98	AEK, AFT, AKS	1595		0-N805	TB [TE]	
1.8	07/93-05/98	AAM, ABS, ADZ	1781		0-N805	TB [TE]	
1.9 TDI	08/95-05/98	1Z	1896	:→289575	0-N103	TB [TE]	
1.9 TDI	08/95-05/98	AHU, ALE	1896		0-N104	TB [TE]	
1.9 TDI	08/95-05/98	1Z	1896	:289576→	0-N104	TB [TE]	
1.9 TDI	08/95-05/98	1Z, AHU, ALE, AFN	1896		0-N128	TB [DG]	
1.9 TDI	07/96-05/98	AFN	1896		0-N104	TB [TE]	
2.0	07/93-05/98	2E, ADY, AGG, AKR	1984		0-N805	TB [TE]	
1.6	10/94-05/98	AEK, AFT, AKS	1595		0-N1417	VB [TE]	
1.6	10/94-05/98	AEK, AFT, AKS	1595		0-N1660	VB [BT]	
1.8	07/93-05/98	AAM, ABS, ADZ	1781		0-N1417	VB [TE]	
1.8	07/93-05/98	AAM, ABS, ADZ	1781		0-N1660	VB [BT]	
1.9 TDI	08/95-05/98	1Z, AHU, ALE, AFN	1896		0-N1417	VB [TE]	
1.9 TDI	08/95-05/98	1Z, AHU, ALE, AFN	1896		0-N1609	VB [BT]	
2.0	07/93-05/98	2E, ADY, AGG, AKR	1984		0-N1417	VB [TE]	
2.0	07/93-05/98	2E, ADY, AGG, AKR	1984		0-N1660	VB [BT]	

GOLF III Variant (1H5)

1.4	07/93-04/99	ABD	1390	19x128	R-1190AQ1	BTKW	
1.4	07/93-04/99	ABD	1390	19x128; 11/1993 →	R-1190AQ1	BTKW	
1.4	07/93-04/99	AEX, APQ	1390	19x135; mit Zubehör	SK-1131	BTK	
1.4	07/93-04/99	AEX, APQ	1390	19x135; mit Zubehör	SK-1131AQ1	BTKW	
1.6	07/94-04/99	AEK, AFT, AKS	1595	18x121; mit Zubehör	SK-1090	BTK	
1.8	07/93-04/99	AAM, ANN, ABS, ADZ, ANP	1781	18x121; R...; → 07/1994; mit Zubehör	SK-1026	BTK	
1.8	07/93-04/99	AAM, ANN, ABS, ADZ, ANP	1781	18x121; 07/1994 →; mit Zubehör	SK-1090	BTK	
1.8 Syncro	10/94-04/99	ADZ	1781	18x121; 05/1996 →; mit Zubehör	SK-1090	BTK	
1.9 D	07/93-04/99	1Y	1896	25.4x137; → 07/1994; :→1Y378364; mit Zubehör	SK-1029	BTK	
1.9 D	07/93-04/99	1Y	1896	25.4x137; 07/1994 →; :378365→; mit Zubehör	SK-1122	BTK	
1.9 SDI, 1.9 TDI	07/95-04/99	AEY, AFN	1896	25x137; mit Zubehör	SK-1098	BTK	
1.9 TD	07/93-04/99	AAZ	1896	25.4x137; → 07/1994; :→AAZ552765; mit Zubehör	SK-1029	BTK	
1.9 TD	07/93-04/99	AAZ	1896	25.4x137; 07/1994 →; :AAZ552766→; mit Zubehör	SK-1122	BTK	

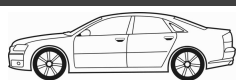

CM³



Art. Nr.



GOLF III Variant (1H5)

1.9 TDI	03/94-04/99	1Z	1896	25.4x137; → 07/1994; : →1Z289575; mit Zubehör	SK-1069	BTK	
1.9 TDI	03/94-04/99	1Z, AHU, ALE	1896	25x137; 07/1994 →; :289576→; mit Zubehör	SK-1098	BTK	
1.9 TDI Syncro	07/95-04/99	1Z	1896	25.4x137; :→289575; mit Zubehör	SK-1069	BTK	
1.9 TDI Syncro	07/95-04/99	1Z, AHU, ALE	1896	25x137; :289576→; mit Zubehör	SK-1098	BTK	
2.0, 2.0 Syncro	07/93-04/99	2E, ADY, AGG, AKR, AEP, AGG	1984	18x124; mit Zubehör	SK-1120	BTK	
1.4	07/93-04/99	AEX, APQ	1390		0-N106	TB [TE]	
1.6	07/94-04/99	AEK, AFT, AKS	1595		0-N805	TB [TE]	
1.8, 1.8 Syncro	07/93-04/99	AAM, ANN, ABS, ADZ, ANP, ADZ	1781		0-N805	TB [TE]	
1.9 D	07/93-04/99	1Y	1896	:378365→	0-N104	TB [TE]	
1.9 D	07/93-04/99	1Y	1896	:→378364	0-N806	TB [TE]	
1.9 D, 1.9 SDI, 1.9 TDI, 1.9 TDI Syncro	07/93-04/99	1Y, 1Z, AHU, ALE, AEY, AFN	1896		0-N128	TB [DG]	
1.9 SDI, 1.9 TDI	07/95-04/99	AEY, AFN	1896		0-N104	TB [TE]	
1.9 TD	07/93-04/99	AAZ	1896	:552766→	0-N104	TB [TE]	
1.9 TD	07/93-04/99	AAZ	1896	:→552765	0-N806	TB [TE]	
1.9 TDI, 1.9 TDI Syncro	03/94-04/99	1Z	1896	:→289575	0-N103	TB [TE]	
1.9 TDI, 1.9 TDI Syncro	03/94-04/99	AHU, ALE	1896		0-N104	TB [TE]	
1.9 TDI, 1.9 TDI Syncro	03/94-04/99	1Z	1896	:289576→	0-N104	TB [TE]	
2.0, 2.0 Syncro	07/93-04/99	2E, ADY, AGG, AKR, AEP, AGG	1984		0-N805	TB [TE]	
1.4	07/93-04/99	ABD	1390	ch.1H-S-120 001→; für Fahrzeuge mit Servolenkung	0-N1445	VB [BT]	S
1.4	07/93-04/99	ABD	1390	ch.1H-S-120001→; für Fahrzeuge mit Servolenkung	0-N1445	VB [BT]	S
1.4	07/93-04/99	AEX, APQ	1390	für Fahrzeuge mit Servolenkung	0-N1445	VB [BT]	S
1.4	07/93-04/99	ABD	1390	ch.→1H-S-120000; für Fahrzeuge mit Servolenkung	0-N1459	VB [BT]	S
1.6	07/94-04/99	AEK, AFT, AKS	1595		0-N1417	VB [TE]	
1.6	07/94-04/99	AEK, AFT, AKS	1595		0-N1660	VB [BT]	
1.8, 1.8 Syncro	07/93-04/99	AAM, ANN, ABS, ADZ, ANP, ADZ	1781		0-N1417	VB [TE]	
1.8, 1.8 Syncro	07/93-04/99	AAM, ANN, ABS, ADZ, ANP, ADZ	1781		0-N1660	VB [BT]	
1.9 D, 1.9 SDI, 1.9 TD, 1.9 TDI, 1.9 TDI Syncro	07/93-04/99	1Y, 1Z, AHU, ALE, AAZ, AEY, AFN	1896		0-N1417	VB [TE]	
1.9 D, 1.9 SDI, 1.9 TD, 1.9 TDI, 1.9 TDI Syncro	07/93-04/99	1Y, 1Z, AHU, ALE, AAZ, AEY, AFN	1896		0-N1609	VB [BT]	
2.0, 2.0 Syncro	07/93-04/99	2E, ADY, AGG, AKR, AEP, AGG	1984		0-N1417	VB [TE]	
2.0, 2.0 Syncro	07/93-04/99	2E, ADY, AGG, AKR, AGG	1984		0-N1660	VB [BT]	
2.9 VR6 Syncro	10/94-04/99	ABV	2861	Rippenanzahl: 7	0-N1657	VB [BT]	S

GOLF IV (1J1)

1.4 16V	08/97-06/05	APE, AXP	1390	20x130; 17x58; beinhaltetete Rollen: 4	SK-1511	BTK	
1.4 16V	08/97-06/05	BCA	1390	20x130; 17x58; ch.→1J-6-050000; beinhaltetete Rollen: 4	SK-1511	BTK	
1.4 16V	08/97-06/05	AHW	1390	20x130; 17x58; ch.→1J-6-050000; :164201→; beinhaltetete Rollen: 4	SK-1511	BTK	
1.4 16V	08/97-06/05	AKQ	1390	20x130; 17x58; :241245→; beinhaltetete Rollen: 4	SK-1511	BTK	
1.4 16V	08/97-06/05	APE, AXP, BCA	1390	20x130; 17x58; beinhaltetete Rollen: 4	SK-1511AQ1	BTKW	
1.4 16V	08/97-06/05	AHW, AKQ	1390	20x130; 17x58; :AHW160001, AKQ242001→; beinhaltetete Rollen: 4	SK-1511AQ1	BTKW	
1.4 16V	08/97-06/05	AHW, AKQ	1390	20x130; 17x58; → 09/2003; :→AHW160000, AKQ242000	SK-1585	BTK	
1.4 16V	08/97-06/05	AHW, AKQ	1390	20x130; 17x58; :→160000, 242000	SK-1585AQ1	BTKW	
1.6	08/97-05/04	AEH, AKL, APF	1595	23x138; Baumuster: 1J1	SK-1109	BTK	
1.6	08/97-06/05	AEH, AKL, APF, AVU, BFQ, BJH	1595	23x138	SK-1109AQ1	BTKW	
1.6	08/00-06/05	AVU, BFQ	1595	23x138; Baumuster: 1J1	SK-1109	BTK	
1.6	02/01-06/01	BAH	1598	23x138	SK-1109	BTK	
1.6 16V, 1.6 FSI	02/00-06/05	ATN, AUS, AZD, BCB, BAD	1598	20x130; 17x58; beinhaltetete Rollen: 4	SK-1511	BTK	
1.6 16V, 1.6 FSI	02/00-06/05	ATN, AUS, AZD, BCB, BAD	1598	20x130; 17x58; beinhaltetete Rollen: 4	SK-1511AQ2	BTKW	
1.8	10/97-09/99	ACC	1781	18x121; mit Zubehör	SK-1090	BTK	
1.8 4motion, 1.8 T GTI	05/98-06/05	AGN, AUQ	1781	23x150; ch.→1J-Y-850000	SK-1709	BTK	
1.8 4motion, 1.8 T GTI	05/98-06/05	AGN, AUQ	1781	23x150; ch.1J-Y-850001→	SK-1710	BTK	
1.8, 1.8 4motion, 1.8 T, 1.8 T GTI	08/97-06/05	AGN, AGN, BAF, AGU, AQA, ARZ, AUM, AWD, AUQ	1781	23x150; ch.→1J-Y-850000; mit Spanndämpfer, Spannrolle	SK-1337	BTK	
1.8, 1.8 4motion, 1.8 T, 1.8 T GTI	08/97-06/05	AGN, AGN, BAF, AGU, AQA, ARZ, AUM, AWD, AUQ	1781	23x150; ch.→1J-Y-850000; mit Spanndämpfer, Spannrolle	SK-1337AQ1	BTKW	
1.8, 1.8 4motion, 1.8 T, 1.8 T GTI	08/97-06/05	AGN, AGN, BAF, AGU, AQA, ARZ, AUM, AWD, AUQ	1781	23x150; ch.1J-Y-850001→	SK-1660	BTK	
1.8, 1.8 4motion, 1.8 T, 1.8 T GTI	08/97-06/05	AGN, AGN, BAF, AGU, AQA, ARZ, AUM, AWD, AUQ	1781	23x150; ch.1J-Y-850001→	SK-1660AQ1	BTKW	



OPTIMAL®

VW



CM³



Art. Nr.



ohne Halter

GOLF IV (1J1)

1.8, 1.8 T	08/97-06/05	AGN, BAF, AGU, AQA, ARZ, AUM, AWD	1781	23x150; ch.→1J-Y-850000; 10/1997 →	SK-1709	BTK
1.8, 1.8 T	08/97-06/05	AGN, BAF, AGU, AQA, ARZ, AUM, AWD	1781	23x150; ch.1J-Y-850001→; 10/1997 →	SK-1710	BTK
1.9 SDI	08/97-06/05	AGP, AQM	1896	25x141; →AGP400000, AQM030000; mit Zubehör	SK-1110	BTK
1.9 SDI	08/97-06/05	AGP, AQM	1896	25x141; →AQM030001→; →AQM045000; mit Zubehör	SK-1111	BTK
1.9 SDI	08/97-06/05	AQM	1896	25x141; →AQM030001→; →AQM045000; mit Zubehör	SK-1111AQ1	BTKW
1.9 SDI	08/97-06/05	AGP, AQM	1896	25x141; →AGP400001, AQM045001→; mit Zubehör	SK-1258	BTK
1.9 SDI	08/97-06/05	AGP	1896	25x141; →AGP400001→; mit Zubehör	SK-1258AQ1	BTKW
1.9 SDI	08/97-06/05	AQM	1896	25x141; →AQM045001→; mit Zubehör	SK-1258AQ1	BTKW
1.9 SDI	08/97-06/05	AGP, AQM	1896	25x141; →AGP400000	SK-1259	BTK
1.9 SDI	08/97-06/05	AGP, AQM	1896	25x141; →AQM030000	SK-1259	BTK
1.9 TD	10/97-09/99	AAZ	1896	25.4x137; →552765; mit Zubehör	SK-1029	BTK
1.9 TD	10/97-09/99	AAZ	1896	25.4x137; →552766→; mit Zubehör	SK-1122	BTK
1.9 TDI	08/97-05/04	AHF, ASV	1896	25x141; →AHF006065; mit Zubehör	SK-1111	BTK
1.9 TDI	08/97-05/04	AHF, ASV	1896	25x141; →ASV150000; mit Zubehör	SK-1111	BTK
1.9 TDI	08/97-05/04	AHF, ASV	1896	25x141; →AHF595000, ASV150000; mit Zubehör	SK-1111AQ1	BTKW
1.9 TDI	08/97-05/04	AHF, ASV	1896	25x141; →AHF595001, ASV150001→; mit Zubehör	SK-1258	BTK
1.9 TDI	08/97-05/04	AHF, ASV	1896	25x141; →AHF595001, ASV150001→; mit Zubehör	SK-1258AQ1	BTKW
1.9 TDI	10/97-05/04	AGR, ALH	1896	25x141; →ALH500000; mit Zubehör	SK-1111	BTK
1.9 TDI	10/97-05/04	AGR, ALH	1896	25x141; →AGR565001, ALH500001→; mit Zubehör	SK-1258	BTK
1.9 TDI	12/98-06/01	AUY	1896	30x120; ch.1J-2-592783, 1J-2D352774→; 05/1999 →; mit Zubehör	SK-1372	BTK
1.9 TDI	12/98-06/01	AJM	1896	30x120; 05/1999 →; →AJM185670; mit Spanndämpfer, Spannrolle; mit Zubehör; Baumuster: 1J1	SK-1378	BTK
1.9 TDI	12/98-06/01	AJM	1896	30x120; 05/1999 →; →AJM185670; ohne Spanndämpfer, Spannrolle; mit Zubehör; Baumuster: 1J1	SK-1388	BTK
1.9 TDI	12/98-06/01	AJM	1896	30x120; 05/1999 →; →AJM185671→; mit Zubehör	SK-1582	BTK
1.9 TDI	12/98-06/01	AUY	1896	30x120; ch.→1J-2-592782, 1J-2-D352773; 05/1999 →; mit Zubehör	SK-1582	BTK
1.9 TDI	12/98-06/01	AJM	1896	30x120; 05/1999 →; →AJM185671→; mit Spanndämpfer, Spannrolle; mit Zubehör	SK-1583	BTK
1.9 TDI	12/98-06/01	AUY	1896	30x120; ch.→1J-2-592782, 1J-2-D352773; 05/1999 →; mit Spanndämpfer, Spannrolle; mit Zubehör	SK-1583	BTK
1.9 TDI	09/00-06/05	ATD, AXR	1896	30x120; ch.1J-2B123079, 1J-2D352774, 1J-2P394001, 1J-2U403277, 1J-2W592783→; →AXR025001→; mit Zubehör	SK-1372	BTK
1.9 TDI	09/00-06/05	ATD	1896	30x120; ch.1J-2-592783, 1J-2D-352774→	SK-1372AQ2	BTKW
1.9 TDI	09/00-06/05	AXR	1896	30x120; →AXR010001→	SK-1372AQ2	BTKW
1.9 TDI	09/00-06/05	ATD	1896	30x120; ch.→1J-2-592782, 1J-2-D352773; mit Zubehör	SK-1582	BTK
1.9 TDI	09/00-06/05	AXR	1896	30x120; →AXR010000; mit Zubehör	SK-1582	BTK
1.9 TDI	09/00-06/05	ATD	1896	30x120; ch.→1J2592782, 2D352773; ohne Spanndämpfer, Spannrolle; mit Zubehör	SK-1582AQ1	BTKW
1.9 TDI	09/00-06/05	AXR	1896	30x120; →AXR010000; mit Zubehör	SK-1582AQ1	BTKW
1.9 TDI	09/00-06/05	ATD	1896	30x120; ch.→1J-2-592782, 1J-2-D352773; mit Spanndämpfer, Spannrolle; mit Zubehör	SK-1583	BTK
1.9 TDI	09/00-06/05	AXR	1896	30x120; →AXR010000; mit Spanndämpfer, Spannrolle; mit Zubehör	SK-1583	BTK
1.9 TDI	09/00-06/05	ATD	1896	30x120; ch.→1J2592782, 2D352773; mit Spanndämpfer, Spannrolle; mit Zubehör	SK-1583AQ1	BTKW
1.9 TDI 4motion	07/98-04/02	AGR, ALH	1896	25x141; →AGR565001→; mit Zubehör	SK-1258	BTK
1.9 TDI 4motion	09/99-06/01	AJM, AUY	1896	30x120; ch.1J-2-592783, 1J-2D352774→; 01/2000 →; mit Zubehör	SK-1372	BTK
1.9 TDI 4motion	09/99-06/01	AJM	1896	30x120; →185670; mit Spanndämpfer, Spannrolle; mit Zubehör	SK-1378	BTK
1.9 TDI 4motion	09/99-06/01	AJM	1896	30x120; →185670; ohne Spanndämpfer, Spannrolle; mit Zubehör	SK-1388	BTK
1.9 TDI 4motion	09/99-06/01	AUY	1896	30x120; ch.→1J-2-592782, 1J-2-D352773; 01/2000 →; mit Zubehör; Baumuster: 1J1	SK-1582	BTK
1.9 TDI 4motion	09/99-06/01	AUY	1896	30x120; ch.→1J-2-592782, 1J-2-D352773; 01/2000 →; mit Spanndämpfer, Spannrolle; mit Zubehör; Baumuster: 1J1	SK-1583	BTK



CM³



Art. Nr.



ohne Halter

GOLF IV (1J1)

1.9 TDI 4motion	09/00-06/05	ATD	1896	30x120; ch.1J-2B123079, 1J-2D352774, 1J-2P394001, 1J2U403277, 1J-2W592783→; :AXR021001→; mit Zubehör	SK-1372	BTK
1.9 TDI 4motion	09/00-06/05	ATD	1896	30x120; ch.1J-2-592783, 1J-2D-352774→	SK-1372AQ2	BTKW
1.9 TDI 4motion	09/00-06/05	ATD	1896	30x120; ch.→1J-2-592782, 1J-2-D352773; mit Zubehör; Baumuster: 1J1	SK-1582	BTK
1.9 TDI 4motion	09/00-06/05	ATD	1896	30x120; ch.→1J2592782, 2D352773; ohne Spanndämpfer, Spannrolle; mit Zubehör	SK-1582AQ1	BTKW
1.9 TDI 4motion	09/00-06/05	ATD	1896	30x120; ch.→1J-2-592782, 1J-2-D352773; mit Spanndämpfer, Spannrolle; mit Zubehör; Baumuster: 1J1	SK-1583	BTK
1.9 TDI 4motion	09/00-06/05	ATD	1896	30x120; ch.→1J2592782, 2D352773; mit Spanndämpfer, Spannrolle; mit Zubehör	SK-1583AQ1	BTKW
1.9 TDI, 1.9 TDI 4motion	10/97-05/04	AGR, ALH	1896	25x141; :→AGR565000; mit Zubehör	SK-1111	BTK
1.9 TDI, 1.9 TDI 4motion	10/97-05/04	AGR, ALH	1896	25x141; :→AGR565000, ALH500000; mit Zubehör	SK-1111AQ1	BTKW
1.9 TDI, 1.9 TDI 4motion	10/97-05/04	AGR, ALH	1896	25x141; :AGR565001, ALH500001→; mit Zubehör	SK-1258AQ1	BTKW
1.9 TDI, 1.9 TDI 4motion	12/98-06/01	AUY	1896	30x120; ch.1J-2-592783, 1J-2D-352774→	SK-1372AQ2	BTKW
1.9 TDI, 1.9 TDI 4motion	12/98-06/01	AJM	1896	30x120; :→AJM185670; mit Spanndämpfer, Spannrolle	SK-1378AQ1	BTKW
1.9 TDI, 1.9 TDI 4motion	12/98-06/01	AJM	1896	30x120; :→AJM185670; ohne Spanndämpfer, Spannrolle; mit Zubehör	SK-1388AQ1	BTKW
1.9 TDI, 1.9 TDI 4motion	12/98-06/01	AUY	1896	30x120; ch.→1J2592782, 2D352773; ohne Spanndämpfer, Spannrolle; mit Zubehör	SK-1582AQ1	BTKW
1.9 TDI, 1.9 TDI 4motion	12/98-06/01	AJM	1896	30x120; :AJM185671→; ohne Spanndämpfer, Spannrolle; mit Zubehör	SK-1582AQ1	BTKW
1.9 TDI, 1.9 TDI 4motion	12/98-06/01	AUY	1896	30x120; ch.→1J2592782, 2D352773; mit Spanndämpfer, Spannrolle; mit Zubehör	SK-1583AQ1	BTKW
1.9 TDI, 1.9 TDI 4motion	12/98-06/01	AJM	1896	30x120; :AJM185671→; mit Spanndämpfer, Spannrolle; mit Zubehör	SK-1583AQ1	BTKW
1.9 TDI, 1.9 TDI 4motion	02/00-06/05	ARL, ASZ	1896	30x120; ch.1J-2B123079, 1J-2D352774, 1J-2P394001, 1J2U403277, 1J-2W592783→; mit Zubehör	SK-1372	BTK
1.9 TDI, 1.9 TDI 4motion	02/00-06/05	ARL	1896	30x120; 02/2002 →	SK-1372AQ3	BTKW
1.9 TDI, 1.9 TDI 4motion	02/00-06/05	ARL	1896	30x120; 09/2000 → 02/2002; mit Zubehör; Baumuster: 1J1	SK-1582	BTK
1.9 TDI, 1.9 TDI 4motion	02/00-06/05	ARL	1896	30x120; 09/2000 → 02/2002; mit Spanndämpfer, Spannrolle; mit Zubehör; Baumuster: 1J1	SK-1583	BTK
1.9 TDI, 1.9 TDI 4motion	11/00-06/05	ASZ	1896	30x120; 02/2002 →	SK-1372AQ2	BTKW
1.9 TDI, 1.9 TDI 4motion	11/00-06/05	ASZ	1896	30x120; 04/2001 → 02/2002; mit Zubehör; Baumuster: 1J1	SK-1582	BTK
1.9 TDI, 1.9 TDI 4motion	11/00-06/05	ASZ	1896	30x120; → 02/2002; ohne Spanndämpfer, Spannrolle; mit Zubehör	SK-1582AQ1	BTKW
1.9 TDI, 1.9 TDI 4motion	11/00-06/05	ASZ	1896	30x120; 04/2001 → 02/2002; mit Spanndämpfer, Spannrolle; mit Zubehör; Baumuster: 1J1	SK-1583	BTK
1.9 TDI, 1.9 TDI 4motion	11/00-06/05	ASZ	1896	30x120; → 02/2002; mit Spanndämpfer, Spannrolle; mit Zubehör	SK-1583AQ1	BTKW
2.0	07/98-05/04	APK, AQY, AZG	1984	23x138; Baumuster: 1J1	SK-1109	BTK
2.0	07/98-05/04	APK, AQY, AZG, AZJ, BER	1984	23x138	SK-1109AQ2	BTKW
2.0 4motion	10/00-06/05	AZH, AZJ	1984	23x138; Baumuster: 1J1	SK-1109	BTK
2.0 4motion	10/00-06/05	AZH, AZJ	1984	23x138	SK-1109AQ2	BTKW
1.4 16V	08/97-06/05	AHW, AKQ, APE, AXP, BCA	1390		0-N1262	TB [DG]
1.4 16V	08/97-06/05	APE, AXP, BCA	1390		0-N1263	TB [TE]
1.4 16V	08/97-06/05	AHW	1390	:160001→	0-N1263	TB [TE]
1.4 16V	08/97-06/05	AKQ	1390	:242001→	0-N1263	TB [TE]
1.4 16V	08/97-06/05	AHW, AKQ, APE, AXP, BCA	1390		0-N158	TB [TE]
1.4 16V	08/97-06/05	AHW	1390	:→160000	0-N159	TB [TE]
1.4 16V	08/97-06/05	AKQ	1390	:→242000	0-N159	TB [TE]
1.4 16V	08/97-06/05	AHW, AKQ, APE, AXP, BCA	1390		0-N164	TB [DG]
1.6	08/97-06/05	AEH, AKL, APF, AVU, BFG, BJH	1595		0-N157	TB [TE]
1.6	02/01-06/01	BAH	1598		0-N1331	TB [TE]
1.6 16V, 1.6 FSI	02/00-06/05	ATN, AUS, AZD, BCB, BAD	1598		0-N1262	TB [DG]
1.6 16V, 1.6 FSI	02/00-06/05	ATN, AUS, AZD, BCB, BAD	1598		0-N1263	TB [TE]
1.6 16V, 1.6 FSI	02/00-06/05	ATN, AUS, AZD, BCB, BAD	1598		0-N158	TB [TE]
1.6 16V, 1.6 FSI	02/00-06/05	ATN, AUS, AZD, BCB, BAD	1598		0-N164	TB [DG]
1.8	10/97-09/99	ACC	1781		0-N805	TB [TE]
1.8 4motion, 1.8 T GTI	05/98-06/05	AGN, AUQ	1781	ch.1J-Y-850001→	0-N1042	TB [TE]
1.8 4motion, 1.8 T GTI	05/98-06/05	AGN, AUQ	1781	ch.→1J-Y-850000	0-N1654	TB [TE]



CM³

**Art. Nr.****ohne Halter**

GOLF IV (1J1)

1.8, 1.8 4motion, 1.8 T, 1.8 T GTI	08/97-06/05	AGN, AGN, BAF, AGU, AQA, ARZ, AUM, AWD, AUQ	1781		0-N1237	TB [BT]	
1.8, 1.8 4motion, 1.8 T, 1.8 T GTI	08/97-06/05	AGN, AGN, BAF, AGU, AQA, ARZ, AUM, AWD, AUQ	1781		0-N1316	TB [DG]	
1.8, 1.8 T	08/97-06/05	AGN, BAF, AGU, AQA, ARZ, AUM, AWD	1781	ch.1J-Y-850001→; 10/1997 →	0-N1042	TB [TE]	
1.8, 1.8 T	08/97-06/05	AGN, BAF, AGU, AQA, ARZ, AUM, AWD	1781	ch.→1J-Y-850000; 10/1997 →	0-N1654	TB [TE]	
1.9 SDI	08/97-06/05	AQM	1896	:→029999	0-N107	TB [TE]	
1.9 SDI	08/97-06/05	AGP	1896	:→400000	0-N107	TB [TE]	
1.9 SDI	08/97-06/05	AQM	1896	:030000→	0-N107	TB [TE]	
1.9 SDI	08/97-06/05	AGP	1896	:400001→	0-N107	TB [TE]	
1.9 SDI	08/97-06/05	AQM	1896	:030001→	0-N167	TB [DG]	
1.9 SDI	08/97-06/05	AGP	1896	:400001→	0-N167	TB [DG]	
1.9 SDI, 1.9 TDI, 1.9 TDI 4motion	08/97-06/05	AGP, AQM, AGR, ALH, AHF, ASV	1896		0-N131	TB [DG]	
1.9 SDI, 1.9 TDI, 1.9 TDI 4motion	08/97-06/05	AGP, AQM, AGR, ALH, AHF, ASV	1896		0-N166	TB [DG]	
1.9 TD	10/97-09/99	AAZ	1896		0-N104	TB [TE]	
1.9 TDI	08/97-05/04	AHF, ASV	1896		0-N107	TB [TE]	
1.9 TDI	09/00-06/05	ATD	1896	ch.1J-2B123079, 1J-2D352774, 1J2U403277, 1J-2W525001→	0-N1045	TB [TE]	
1.9 TDI	09/00-06/05	AXR	1896	:010001→	0-N1045	TB [TE]	
1.9 TDI	09/00-06/05	ATD	1896	ch.1J-2B123079, 1J-2D352774, 1J2U403277, 1J-2W525001→	0-N1046	TB [DG]	
1.9 TDI	09/00-06/05	AXR	1896	:010001→	0-N1046	TB [DG]	
1.9 TDI	09/00-06/05	ATD	1896	ch.→1J-2B123078, 1J-2-D352773, 1J-2P394000, 1J-2U403276, 1J-2W525000	0-N1048	TB [TE]	
1.9 TDI	09/00-06/05	AXR	1896	:→010000	0-N1048	TB [TE]	
1.9 TDI	09/00-06/05	ATD	1896	ch.→1J-2B123078, 1J-2-D352773, 1J-2P394000, 1J-2U403276, 1J-2W525000	0-N1268	TB [DG]	
1.9 TDI	09/00-06/05	AXR	1896	:→010000	0-N1268	TB [DG]	
1.9 TDI	09/00-06/05	ATD	1896	ch.→1J-2B123078, 1J-2-D352773, 1J-2P394000, 1J-2U403276, 1J-2W525000	0-N1274	TB [BT]	
1.9 TDI	09/00-06/05	AXR	1896	:→010000	0-N1274	TB [BT]	
1.9 TDI 4motion	09/00-06/05	ATD	1896	:010001→	0-N1045	TB [TE]	
1.9 TDI 4motion	09/00-06/05	ATD	1896	:010001→	0-N1046	TB [DG]	
1.9 TDI 4motion	09/00-06/05	ATD	1896	:→010000	0-N1048	TB [TE]	
1.9 TDI 4motion	09/00-06/05	ATD	1896	:→010000	0-N1268	TB [DG]	
1.9 TDI 4motion	09/00-06/05	ATD	1896	:→010000	0-N1274	TB [BT]	
1.9 TDI, 1.9 TDI 4motion	08/97-05/04	AGR, ALH, AHF, ASV	1896		0-N167	TB [DG]	
1.9 TDI, 1.9 TDI 4motion	10/97-05/04	AGR, ALH	1896		0-N107	TB [TE]	
1.9 TDI, 1.9 TDI 4motion	12/98-06/01	AUY	1896		0-N1048	TB [TE]	
1.9 TDI, 1.9 TDI 4motion	12/98-06/01	AJM	1896	:185671→	0-N1048	TB [TE]	
1.9 TDI, 1.9 TDI 4motion	12/98-06/01	AJM	1896	:→185670	0-N1049	TB [BT]	
1.9 TDI, 1.9 TDI 4motion	12/98-06/01	AJM	1896	:→185670; mit Anbaumaterial	0-N1265	TB [TE]	
1.9 TDI, 1.9 TDI 4motion	12/98-06/01	AJM, AUY	1896		0-N1268	TB [DG]	
1.9 TDI, 1.9 TDI 4motion	12/98-06/01	AUY	1896		0-N1274	TB [BT]	
1.9 TDI, 1.9 TDI 4motion	12/98-06/01	AJM	1896	:185671→	0-N1274	TB [BT]	
1.9 TDI, 1.9 TDI 4motion	02/00-06/05	ARL, ASZ, ATD	1896	ch.1J-2B123079, 1J-2D352774, 1J2U403277, 1J-2W525001→	0-N1045	TB [TE]	
1.9 TDI, 1.9 TDI 4motion	02/00-06/05	ARL, ASZ, ATD	1896	ch.1J-2B123079, 1J-2D352774, 1J2U403277, 1J-2W525001→	0-N1046	TB [DG]	
1.9 TDI, 1.9 TDI 4motion	02/00-06/05	ARL, ASZ, ATD	1896	ch.→1J-2B123078, 1J-2-D352773, 1J-2P394000, 1J-2U403276, 1J-2W525000	0-N1048	TB [TE]	
1.9 TDI, 1.9 TDI 4motion	02/00-06/05	ARL, ASZ, ATD	1896	ch.→1J-2B123078, 1J-2-D352773, 1J-2P394000, 1J-2U403276, 1J-2W525000	0-N1268	TB [DG]	
1.9 TDI, 1.9 TDI 4motion	02/00-06/05	ARL, ASZ, ATD	1896	ch.→1J-2B123078, 1J-2-D352773, 1J-2P394000, 1J-2U403276, 1J-2W525000	0-N1274	TB [BT]	
2.0	07/98-05/04	APK, AQY, AZG, AZJ, BER	1984		0-N131	TB [DG]	
2.0, 2.0 4motion	07/98-06/05	APK, AQY, AZG, AZJ, BER, AZH, AZJ	1984		0-N157	TB [TE]	
1.4 16V	08/97-06/05	AHW, AKQ, APE, AXP, BCA	1390	☼	0-N1310	VB [DG]	
1.4 16V	08/97-06/05	AHW, AKQ, APE, AXP, BCA	1390	für Fahrzeuge mit Servolenkung	0-N1445	VB [BT]	S
1.4 16V	08/97-06/05	AHW, AKQ, APE, AXP, BCA	1390	☼, für Fahrzeuge mit Servolenkung	0-N1539	VB [BT]	S
1.6	08/97-05/04	AEH, AKL, APF	1595		0-N1041	VB [BT]	S
1.6	08/00-06/05	AVU	1595		0-N1041	VB [BT]	S
1.6	02/01-06/01	BAH	1598		0-N1041	VB [BT]	S
1.6 16V	02/00-06/05	ATN, AUS, AZD, BCB	1598	☼, für Fahrzeuge mit Servolenkung	0-N1539	VB [BT]	S
1.6 16V, 1.6 FSI	02/00-06/05	ATN, AUS, AZD, BCB, BAD	1598	☼	0-N1310	VB [DG]	
1.6 16V, 1.6 FSI	02/00-06/05	ATN, AUS, AZD, BCB, BAD	1598	für Fahrzeuge mit Servolenkung	0-N1445	VB [BT]	S
1.6 FSI	01/02-06/05	BAD	1598	☼	0-N1539	VB [BT]	S
1.8	08/97-06/05	AGN	1781		0-N1041	VB [BT]	S



CM³



Art. Nr.



GOLF IV (1J1)

1.8	10/97-09/99	ACC	1781		0-N1417	VB [TE]	
1.8 4motion	05/98-06/05	AGN	1781		0-N1041	VB [BT]	S
1.8 T	08/97-06/05	AGU, ARZ, AUM	1781		0-N1041	VB [BT]	S
1.9 SDI	08/97-06/05	AGP, AQM	1896		0-N1606	VB [BT]	S
1.9 SDI, 1.9 TDI, 1.9 TDI 4motion	08/97-06/05	AGP, AQM, AGR, ALH, AHF, ASV	1896		0-N174	VB [DG]	
1.9 TD	10/97-09/99	AAZ	1896		0-N1417	VB [TE]	
1.9 TDI	09/00-06/05	ATD	1896	→ 12/2002; Rippenanzahl: 5	0-N1441	VB [BT]	S
1.9 TDI	09/00-06/05	AXR	1896		0-N1494	VB [BT]	S
1.9 TDI	09/00-06/05	ATD	1896	01/2003 →	0-N1494	VB [BT]	S
1.9 TDI	09/00-06/05	ATD	1896	→ 12/2002	0-N2047	VB [DG]	
1.9 TDI	09/00-06/05	ATD	1896	→ 12/2002	0-N2139	VB [VD]	
1.9 TDI 4motion	09/00-06/05	ATD	1896	→ 12/2002; Rippenanzahl: 5	0-N1441	VB [BT]	S
1.9 TDI 4motion	09/00-06/05	ATD	1896	01/2003 →	0-N1494	VB [BT]	S
1.9 TDI 4motion	09/00-06/05	ATD	1896	→ 12/2002	0-N2047	VB [DG]	
1.9 TDI 4motion	09/00-06/05	ATD	1896	→ 12/2002	0-N2139	VB [VD]	
1.9 TDI, 1.9 TDI 4motion	08/97-05/04	AGR, ALH, AHF, ASV	1896		0-N1538	VB [BT]	S
1.9 TDI, 1.9 TDI 4motion	12/98-06/01	AUY	1896	Rippenanzahl: 5	0-N1441	VB [BT]	S
1.9 TDI, 1.9 TDI 4motion	12/98-06/01	AJM	1896		0-N1494	VB [BT]	S
1.9 TDI, 1.9 TDI 4motion	12/98-06/01	AJM, AUY	1896		0-N2047	VB [DG]	
1.9 TDI, 1.9 TDI 4motion	12/98-06/01	AJM, AUY	1896		0-N2139	VB [VD]	
1.9 TDI, 1.9 TDI 4motion	02/00-06/05	ARL, ASZ	1896		0-N1494	VB [BT]	S
2.0	07/98-05/04	APK, AQY	1984		0-N1041	VB [BT]	S
2.3 V5, 2.3 V5 4motion	08/97-10/00	AGZ	2324	ch.1J-W-000001→; Rippenanzahl: 6	0-N2017	VB [BT]	S
2.3 V5, 2.3 V5 4motion	10/00-06/05	AQN	2324	Rippenanzahl: 6	0-N1496S	VB [TE]	
2.8 V6 4motion	03/99-06/05	AQP, AUE, BDE	2792	Rippenanzahl: 6	0-N1496S	VB [TE]	
2.8 V6 4motion	03/99-06/05	AQP, AUE	2792	Rippenanzahl: 7; *	0-N1657	VB [BT]	S
3.2 R32 4motion	09/02-06/05	BFH, BML	3189	Rippenanzahl: 6	0-N1496S	VB [TE]	

GOLF IV Cabriolet (1E7)

1.6	06/98-06/02	AFT, AKS	1595	18x121; mit Zubehör	SK-1090	BTK	
1.8	06/98-06/02	ADZ, ANP	1781	18x121; mit Zubehör	SK-1026	BTK	
1.8	06/98-06/02	AAM, ANN, ADZ, ANP	1781	18x121; mit Zubehör	SK-1090	BTK	
1.9 TDI	06/98-06/02	AFN, AVG, AHU, ALE	1896	25x137; mit Zubehör	SK-1098	BTK	
2.0	06/98-06/02	ADY, AGG, AKR	1984	18x124; mit Zubehör	SK-1120	BTK	
1.6	06/98-06/02	AFT, AKS	1595		0-N805	TB [TE]	
1.8	06/98-06/02	AAM, ANN, ADZ, ANP	1781		0-N805	TB [TE]	
1.9 TDI	06/98-06/02	AFN, AVG, AHU, ALE	1896		0-N104	TB [TE]	
1.9 TDI	06/98-06/02	AFN, AVG, AHU, ALE	1896		0-N128	TB [DG]	
2.0	06/98-06/02	ATU, AWF, AWG	1984		0-N132	TB [TE]	
2.0	06/98-06/02	AGG, AKR	1984		0-N805	TB [TE]	
1.6	06/98-06/02	AFT, AKS	1595		0-N1417	VB [TE]	
1.6	06/98-06/02	AFT, AKS	1595		0-N1660	VB [BT]	
1.8	06/98-06/02	AAM, ANN, ADZ, ANP	1781		0-N1417	VB [TE]	
1.8	06/98-06/02	AAM, ANN, ADZ, ANP	1781		0-N1660	VB [BT]	
1.9 TDI	06/98-06/02	AFN, AVG, AHU, ALE	1896		0-N1417	VB [TE]	
1.9 TDI	06/98-06/02	AFN, AVG, AHU, ALE	1896		0-N1609	VB [BT]	
2.0	06/98-06/02	AGG, AKR, ATU, AWF, AWG	1984		0-N1417	VB [TE]	
2.0	06/98-06/02	AGG, AKR, ATU, AWF, AWG	1984		0-N1660	VB [BT]	

GOLF IV Variant (1J5)

1.4 16V	05/99-06/06	APE, AXP	1390	20x130; 17x58; beinhalten Rollen: 4	SK-1511	BTK	
1.4 16V	05/99-06/06	BCA	1390	20x130; 17x58; ch.→1J-6-050000; beinhalten Rollen: 4	SK-1511	BTK	
1.4 16V	05/99-06/06	AHW	1390	20x130; 17x58; ch.→1J-6-050000; :164201→; beinhalten Rollen: 4	SK-1511	BTK	
1.4 16V	05/99-06/06	AKQ	1390	20x130; 17x58; :241245→; beinhalten Rollen: 4	SK-1511	BTK	
1.4 16V	05/99-06/06	APE, AXP, BCA	1390	20x130; 17x58; beinhalten Rollen: 4	SK-1511AQ1	BTKW	
1.4 16V	05/99-06/06	AHW, AKQ	1390	20x130; 17x58; :AHW160001, AKQ242001→; beinhalten Rollen: 4	SK-1511AQ1	BTKW	
1.4 16V	05/99-06/06	AKQ	1390	20x130; 17x58; → 08/2000; :→AKQ242000	SK-1585	BTK	
1.4 16V	05/99-06/06	AHW	1390	20x130; 17x58; :→AHW160000	SK-1585	BTK	
1.4 16V	05/99-06/06	AHW, AKQ	1390	20x130; 17x58; :→160000, 242000	SK-1585AQ1	BTKW	
1.6	05/99-04/02	AEH, AKL, APF	1595	23x138; Baumuster: 1J5	SK-1109	BTK	
1.6	05/99-06/06	AEH, AKL, APF, AVU, BFQ	1595	23x138	SK-1109AQ1	BTKW	
1.6	08/00-06/06	AVU, BFQ	1595	23x138; Baumuster: 1J5	SK-1109	BTK	
1.6 16V, 1.6 FSI	02/00-06/06	ATN, AUS, AZD, BCB, BAD	1598	20x130; 17x58; beinhalten Rollen: 4	SK-1511	BTK	



OPTIMAL®

VW



CM³



Art. Nr.



GOLF IV Variant (1J5)

1.6 16V, 1.6 FSI	02/00-06/06	ATN, AUS, AZD, BCB, BAD	1598	20x130; 17x58; beinhaltetete Rollen: 4	SK-1511AQ2	BTKW
1.8 4motion, 1.8 T	05/99-06/06	AGN, AGU, AQA, ARZ, AUM, AWD	1781	23x150; ch.→1J-Y-850000; mit Spanndämpfer, Spannrolle	SK-1337	BTK
1.8 4motion, 1.8 T	05/99-06/06	AGN, AGU, AQA, ARZ, AUM, AWD	1781	23x150; ch.→1J-Y-850000; mit Spanndämpfer, Spannrolle	SK-1337AQ1	BTKW
1.8 4motion, 1.8 T	05/99-06/06	AGN, AGU, AQA, ARZ, AUM, AWD	1781	23x150; ch.1J-Y-850001→	SK-1660	BTK
1.8 4motion, 1.8 T	05/99-06/06	AGN, AGU, AQA, ARZ, AUM, AWD	1781	23x150; ch.1J-Y-850001→	SK-1660AQ1	BTKW
1.8 4motion, 1.8 T	05/99-06/06	AGN, AGU, AQA, ARZ, AUM, AWD	1781	23x150; ch.→1J-Y-850000	SK-1709	BTK
1.8 4motion, 1.8 T	05/99-06/06	AGN, AGU, AQA, ARZ, AUM, AWD	1781	23x150; ch.1J-Y-850001→	SK-1710	BTK
1.9 SDI	05/99-06/06	AGP, AQM	1896	25x141; :→AQM030000; mit Zubehör	SK-1110	BTK
1.9 SDI	05/99-06/06	AGP, AQM	1896	25x141; :AQM030001→; :→AQM045000; mit Zubehör	SK-1111	BTK
1.9 SDI	05/99-06/06	AQM	1896	25x141; :AQM030001→; :→AQM045000; mit Zubehör	SK-1111AQ1	BTKW
1.9 SDI	05/99-06/06	AGP, AQM	1896	25x141; :AQM045001→; mit Zubehör	SK-1258	BTK
1.9 SDI	05/99-06/06	AGP, AQM	1896	25x141; :AQM045001→; mit Zubehör	SK-1258AQ1	BTKW
1.9 SDI	05/99-06/06	AGP, AQM	1896	25x141; :→AGP400000	SK-1259	BTK
1.9 SDI	05/99-06/06	AGP, AQM	1896	25x141; :→AQM030000	SK-1259	BTK
1.9 TDI	05/99-06/01	AHF, ASV	1896	25x141; :→AHF006065; mit Zubehör	SK-1111	BTK
1.9 TDI	05/99-06/01	AHF, ASV	1896	25x141; :→ASV150000; mit Zubehör	SK-1111	BTK
1.9 TDI	05/99-06/01	AHF, ASV	1896	25x141; :→AHF595000, ASV150000; mit Zubehör	SK-1111AQ1	BTKW
1.9 TDI	05/99-06/01	AHF, ASV	1896	25x141; :AHF595001, ASV150001→; mit Zubehör	SK-1258	BTK
1.9 TDI	05/99-06/01	AHF, ASV	1896	25x141; :AHF595001→; mit Zubehör	SK-1258AQ1	BTKW
1.9 TDI	08/99-06/01	AUY	1896	30x120; ch.1J-2-592783, 1J-2D352774→; mit Zubehör	SK-1372	BTK
1.9 TDI	08/99-06/01	AJM	1896	30x120; :→AJM185670; mit Spanndämpfer, Spannrolle; mit Zubehör; Baumuster: 1J5	SK-1378	BTK
1.9 TDI	08/99-06/01	AJM	1896	30x120; :→AJM185670; ohne Spanndämpfer, Spannrolle; mit Zubehör; Baumuster: 1J5	SK-1388	BTK
1.9 TDI	08/99-06/01	AUY	1896	30x120; mit Zubehör	SK-1582	BTK
1.9 TDI	08/99-06/01	AJM	1896	30x120; :AJM185671→; mit Zubehör	SK-1582	BTK
1.9 TDI	08/99-06/01	AUY	1896	30x120; mit Spanndämpfer, Spannrolle; mit Zubehör	SK-1583	BTK
1.9 TDI	08/99-06/01	AJM	1896	30x120; :AJM185671→; mit Spanndämpfer, Spannrolle; mit Zubehör	SK-1583	BTK
1.9 TDI	09/00-06/06	ATD, AXR	1896	30x120; ch.1J-2B123079, 1J-2D352774, 1J-2P394001, 1J2U403277, 1J-2W592783→; :AXR021001→; mit Zubehör	SK-1372	BTK
1.9 TDI	09/00-06/06	ATD	1896	30x120; ch.1J-2-592783, 1J-2D-352774→	SK-1372AQ2	BTKW
1.9 TDI	09/00-06/06	AXR	1896	30x120; :AXR010001→	SK-1372AQ2	BTKW
1.9 TDI	09/00-06/06	ATD	1896	30x120; mit Zubehör	SK-1582	BTK
1.9 TDI	09/00-06/06	AXR	1896	30x120; :→AXR010000; mit Zubehör	SK-1582	BTK
1.9 TDI	09/00-06/06	ATD	1896	30x120; ch.→1J2592782, 2D352773; ohne Spanndämpfer, Spannrolle; mit Zubehör	SK-1582AQ1	BTKW
1.9 TDI	09/00-06/06	AXR	1896	30x120; :→AXR010000; mit Zubehör	SK-1582AQ1	BTKW
1.9 TDI	09/00-06/06	ATD	1896	30x120; mit Spanndämpfer, Spannrolle; mit Zubehör	SK-1583	BTK
1.9 TDI	09/00-06/06	AXR	1896	30x120; :→AXR010000; mit Spanndämpfer, Spannrolle; mit Zubehör	SK-1583	BTK
1.9 TDI	09/00-06/06	ATD	1896	30x120; ch.→1J2592782, 2D352773; mit Spanndämpfer, Spannrolle; mit Zubehör	SK-1583AQ1	BTKW
1.9 TDI 4motion	05/99-06/01	AJM	1896	30x120; ch.1J-2-592783, 1J-2D352774→; 01/2000 →; mit Zubehör	SK-1372	BTK
1.9 TDI 4motion	05/99-06/01	AJM	1896	30x120; :→185670; mit Spanndämpfer, Spannrolle; mit Zubehör	SK-1378	BTK
1.9 TDI 4motion	05/99-06/01	AJM	1896	30x120; :→185670; ohne Spanndämpfer, Spannrolle; mit Zubehör	SK-1388	BTK
1.9 TDI 4motion	05/99-06/01	AJM	1896	30x120; 01/2000 →; mit Zubehör; Baumuster: 1J5	SK-1582	BTK
1.9 TDI 4motion	05/99-06/01	AJM	1896	30x120; 01/2000 →; mit Spanndämpfer, Spannrolle; mit Zubehör; Baumuster: 1J5	SK-1583	BTK
1.9 TDI 4motion	09/00-06/06	ATD	1896	30x120; ch.1J-2B123079, 1J-2D352774, 1J-2P394001, 1J2U403277, 1J-2W592783→; :AXR021001→; mit Zubehör	SK-1372	BTK
1.9 TDI 4motion	09/00-06/06	ATD	1896	30x120; ch.1J-2-592783, 1J-2D-352774→	SK-1372AQ2	BTKW
1.9 TDI 4motion	09/00-06/06	ATD	1896	30x120; mit Zubehör; Baumuster: 1J5	SK-1582	BTK
1.9 TDI 4motion	09/00-06/06	ATD	1896	30x120; ch.→1J2592782, 2D352773; ohne Spanndämpfer, Spannrolle; mit Zubehör	SK-1582AQ1	BTKW



CM³



Art. Nr.



ohne Halter

GOLF IV Variant (1J5)

1.9 TDI 4motion	09/00-06/06	ATD	1896	30x120; mit Spanndämpfer, Spannrolle; mit Zubehör; Baumuster: 1J5	SK-1583	BTK
1.9 TDI 4motion	09/00-06/06	ATD	1896	30x120; ch.→1J2592782, 2D352773; mit Spanndämpfer, Spannrolle; mit Zubehör	SK-1583AQ1	BTKW
1.9 TDI 4motion	05/02-06/05	ARL	1896	30x120; mit Zubehör	SK-1372	BTK
1.9 TDI 4motion	05/02-06/05	ARL	1896	30x120	SK-1372AQ3	BTKW
1.9 TDI, 1.9 TDI 4motion	05/99-05/06	AGR, ALH	1896	25x141; →AGR565000; mit Zubehör	SK-1111	BTK
1.9 TDI, 1.9 TDI 4motion	05/99-05/06	AGR, ALH	1896	25x141; →ALH500000; mit Zubehör;	SK-1111	BTK
1.9 TDI, 1.9 TDI 4motion	05/99-05/06	AGR, ALH	1896	25x141; →AGR565000, ALH500000; mit Zubehör	SK-1111AQ1	BTKW
1.9 TDI, 1.9 TDI 4motion	05/99-05/06	AGR, ALH	1896	25x141; →AGR565001, ALH500001→; mit Zubehör	SK-1258	BTK
1.9 TDI, 1.9 TDI 4motion	05/99-05/06	AGR, ALH	1896	25x141; →AGR565001, ALH500001→; mit Zubehör	SK-1258AQ1	BTKW
1.9 TDI, 1.9 TDI 4motion	05/99-06/01	AUY	1896	30x120; ch.1J-2-592783, 1J-2D-352774→	SK-1372AQ2	BTKW
1.9 TDI, 1.9 TDI 4motion	05/99-06/01	AJM	1896	30x120; →AJM185670; mit Spanndämpfer, Spannrolle	SK-1378AQ1	BTKW
1.9 TDI, 1.9 TDI 4motion	05/99-06/01	AJM	1896	30x120; →AJM185670; ohne Spanndämpfer, Spannrolle; mit Zubehör	SK-1388AQ1	BTKW
1.9 TDI, 1.9 TDI 4motion	05/99-06/01	AUY	1896	30x120; ch.→1J2592782, 2D352773; ohne Spanndämpfer, Spannrolle; mit Zubehör	SK-1582AQ1	BTKW
1.9 TDI, 1.9 TDI 4motion	05/99-06/01	AJM	1896	30x120; →AJM185671→; ohne Spanndämpfer, Spannrolle; mit Zubehör	SK-1582AQ1	BTKW
1.9 TDI, 1.9 TDI 4motion	05/99-06/01	AUY	1896	30x120; ch.→1J2592782, 2D352773; mit Spanndämpfer, Spannrolle; mit Zubehör	SK-1583AQ1	BTKW
1.9 TDI, 1.9 TDI 4motion	05/99-06/01	AJM	1896	30x120; →AJM185671→; mit Spanndämpfer, Spannrolle; mit Zubehör	SK-1583AQ1	BTKW
1.9 TDI, 1.9 TDI 4motion	11/00-06/06	ASZ	1896	30x120; ch.1J-2B123079, 1J-2D352774, 1J-2P394001, 1J2U403277, 1J-2W592783→; mit Zubehör	SK-1372	BTK
1.9 TDI, 1.9 TDI 4motion	11/00-06/06	ASZ	1896	30x120; 02/2002 →	SK-1372AQ2	BTKW
1.9 TDI, 1.9 TDI 4motion	11/00-06/06	ASZ	1896	30x120; 04/2001 → 02/2002; mit Zubehör; Baumuster: 1J5	SK-1582	BTK
1.9 TDI, 1.9 TDI 4motion	11/00-06/06	ASZ	1896	30x120; → 02/2002; ohne Spanndämpfer, Spannrolle; mit Zubehör	SK-1582AQ1	BTKW
1.9 TDI, 1.9 TDI 4motion	11/00-06/06	ASZ	1896	30x120; 04/2001 → 02/2002; mit Spanndämpfer, Spannrolle; mit Zubehör; Baumuster: 1J5	SK-1583	BTK
1.9 TDI, 1.9 TDI 4motion	11/00-06/06	ASZ	1896	30x120; → 02/2002; mit Spanndämpfer, Spannrolle; mit Zubehör	SK-1583AQ1	BTKW
2.0	05/99-06/06	APK, AQY, AZJ	1984	23x138; Baumuster: 1J5	SK-1109	BTK
2.0 4motion	10/00-06/06	AZH, AZJ	1984	23x138; Baumuster: 1J5	SK-1109	BTK
2.0 Bi-Fuel	02/02-06/06	BEH	1984	23x138; Baumuster: 1J5	SK-1109	BTK
2.0, 2.0 4motion, 2.0 Bi-Fuel	05/99-06/06	APK, AQY, AZJ, AZH, AZJ, BEH	1984	23x138	SK-1109AQ2	BTKW
1.4 16V	05/99-06/06	AHW, AKQ, APE, AXP, BCA	1390		0-N1262	TB [DG]
1.4 16V	05/99-06/06	APE, AXP, BCA	1390		0-N1263	TB [TE]
1.4 16V	05/99-06/06	AHW	1390	:160001→	0-N1263	TB [TE]
1.4 16V	05/99-06/06	AKQ	1390	:242001→	0-N1263	TB [TE]
1.4 16V	05/99-06/06	AHW, AKQ, APE, AXP, BCA	1390		0-N158	TB [TE]
1.4 16V	05/99-06/06	AHW	1390	:→160000	0-N159	TB [TE]
1.4 16V	05/99-06/06	AKQ	1390	:→242000	0-N159	TB [TE]
1.4 16V	05/99-06/06	AHW, AKQ, APE, AXP, BCA	1390		0-N164	TB [DG]
1.6	05/99-06/06	AEH, AKL, APF, AVU, BFQ	1595		0-N157	TB [TE]
1.6 16V, 1.6 FSI	02/00-06/06	ATN, AUS, AZD, BCB, BAD	1598		0-N1262	TB [DG]
1.6 16V, 1.6 FSI	02/00-06/06	ATN, AUS, AZD, BCB, BAD	1598		0-N1263	TB [TE]
1.6 16V, 1.6 FSI	02/00-06/06	ATN, AUS, AZD, BCB, BAD	1598		0-N158	TB [TE]
1.6 16V, 1.6 FSI	02/00-06/06	ATN, AUS, AZD, BCB, BAD	1598		0-N164	TB [DG]
1.8 4motion, 1.8 T	05/99-06/06	AGN, AGU, AQA, ARZ, AUM, AWD	1781	ch.1J-Y-850001→	0-N1042	TB [TE]
1.8 4motion, 1.8 T	05/99-06/06	AGN, AGU, AQA, ARZ, AUM, AWD	1781		0-N1237	TB [BT]
1.8 4motion, 1.8 T	05/99-06/06	AGN, AGU, AQA, ARZ, AUM, AWD	1781		0-N1316	TB [DG]
1.8 4motion, 1.8 T	05/99-06/06	AGN, AGU, AQA, ARZ, AUM, AWD	1781	ch.→1J-Y-850000	0-N1654	TB [TE]
1.9 SDI	05/99-06/06	AQM	1896	:→029999	0-N107	TB [TE]
1.9 SDI	05/99-06/06	AGP	1896	:→400000	0-N107	TB [TE]
1.9 SDI	05/99-06/06	AQM	1896	:045001→	0-N107	TB [TE]
1.9 SDI	05/99-06/06	AGP	1896	:400001→	0-N107	TB [TE]
1.9 SDI	05/99-06/06	AQM	1896	:030001→	0-N167	TB [DG]
1.9 SDI	05/99-06/06	AGP	1896	:400001→	0-N167	TB [DG]
1.9 SDI, 1.9 TDI, 1.9 TDI 4motion	05/99-06/06	AGP, AQM, AGR, ALH, AHF, ASV	1896		0-N131	TB [DG]
1.9 SDI, 1.9 TDI, 1.9 TDI 4motion	05/99-06/06	AGP, AQM, AGR, ALH, AHF, ASV	1896		0-N166	TB [DG]
1.9 TDI	05/99-06/01	AHF, ASV	1896		0-N107	TB [TE]



OPTIMAL®

VW

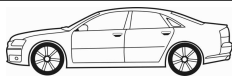

CM³



Art. Nr.



ohne Halter

GOLF IV Variant (1J5)

1.9 TDI	08/99-06/01	AUY	1896		0-N1048	TB [TE]	
1.9 TDI	08/99-06/01	AJM	1896	:→185670	0-N1049	TB [BT]	
1.9 TDI	08/99-06/01	AJM	1896	:→185670; mit Anbaumaterial	0-N1265	TB [TE]	
1.9 TDI	08/99-06/01	AUY	1896		0-N1274	TB [BT]	
1.9 TDI	08/99-06/01	AJM	1896	:185671→	0-N1274	TB [BT]	
1.9 TDI	09/00-06/06	ATD	1896	ch.1J-2B123079, 1J-2D352774, 1J2U403277, 1J-2W525001→	0-N1045	TB [TE]	
1.9 TDI	09/00-06/06	AXR	1896	:010001→	0-N1045	TB [TE]	
1.9 TDI	09/00-06/06	ATD	1896	ch.1J-2B123079, 1J-2D352774, 1J2U403277, 1J-2W525001→	0-N1046	TB [DG]	
1.9 TDI	09/00-06/06	AXR	1896	:010001→	0-N1046	TB [DG]	
1.9 TDI	09/00-06/06	ATD	1896	ch.→1J-2B123078, 1J-2-D352773, 1J-2P394000, 1J-2U403276, 1J-2W525000	0-N1048	TB [TE]	
1.9 TDI	09/00-06/06	AXR	1896	:→010000	0-N1048	TB [TE]	
1.9 TDI	09/00-06/06	ATD	1896	ch.→1J-2B123078, 1J-2-D352773, 1J-2P394000, 1J-2U403276, 1J-2W525000	0-N1268	TB [DG]	
1.9 TDI	09/00-06/06	AXR	1896	:→010000	0-N1268	TB [DG]	
1.9 TDI	09/00-06/06	ATD	1896	ch.→1J-2B123078, 1J-2-D352773, 1J-2P394000, 1J-2U403276, 1J-2W525000	0-N1274	TB [BT]	
1.9 TDI	09/00-06/06	AXR	1896	:→010000	0-N1274	TB [BT]	
1.9 TDI 4motion	05/99-06/01	AJM	1896	:→185670	0-N1049	TB [BT]	
1.9 TDI 4motion	05/99-06/01	AJM	1896	:→185670; mit Anbaumaterial	0-N1265	TB [TE]	
1.9 TDI 4motion	05/99-06/01	AJM	1896	:185671→	0-N1274	TB [BT]	
1.9 TDI 4motion	09/00-06/06	ATD	1896	:010001→	0-N1045	TB [TE]	
1.9 TDI 4motion	09/00-06/06	ATD	1896	:010001→	0-N1046	TB [DG]	
1.9 TDI 4motion	09/00-06/06	ATD	1896	:→010000	0-N1048	TB [TE]	
1.9 TDI 4motion	09/00-06/06	ATD	1896	:→010000	0-N1268	TB [DG]	
1.9 TDI 4motion	09/00-06/06	ATD	1896	:→010000	0-N1274	TB [BT]	
1.9 TDI, 1.9 TDI 4motion	05/99-06/01	AJM	1896	:185671→	0-N1048	TB [TE]	
1.9 TDI, 1.9 TDI 4motion	05/99-05/06	AGR, ALH	1896		0-N107	TB [TE]	
1.9 TDI, 1.9 TDI 4motion	05/99-06/01	AJM, AJM, AUY	1896		0-N1268	TB [DG]	
1.9 TDI, 1.9 TDI 4motion	05/99-05/06	AGR, ALH, AHF, ASV	1896		0-N167	TB [DG]	
1.9 TDI, 1.9 TDI 4motion	09/00-06/06	ASZ, ATD	1896	ch.1J-2B123079, 1J-2D352774, 1J2U403277, 1J-2W525001→	0-N1045	TB [TE]	
1.9 TDI, 1.9 TDI 4motion	09/00-06/06	ASZ, ATD	1896	ch.1J-2B123079, 1J-2D352774, 1J2U403277, 1J-2W525001→	0-N1046	TB [DG]	
1.9 TDI, 1.9 TDI 4motion	09/00-06/06	ASZ, ATD	1896	ch.→1J-2B123078, 1J-2-D352773, 1J-2P394000, 1J-2U403276, 1J-2W525000	0-N1048	TB [TE]	
1.9 TDI, 1.9 TDI 4motion	09/00-06/06	ASZ, ATD	1896	ch.→1J-2B123078, 1J-2-D352773, 1J-2P394000, 1J-2U403276, 1J-2W525000	0-N1268	TB [DG]	
1.9 TDI, 1.9 TDI 4motion	09/00-06/06	ASZ, ATD	1896	ch.→1J-2B123078, 1J-2-D352773, 1J-2P394000, 1J-2U403276, 1J-2W525000	0-N1274	TB [BT]	
2.0, 2.0 4motion	05/99-06/06	APK, AQY, AZJ, AZH, AZJ	1984		0-N157	TB [TE]	
1.4 16V	05/99-06/06	AHW, AKQ, APE, AXP, BCA	1390		0-N1310	VB [DG]	
1.4 16V	05/99-06/06	AHW, AKQ, APE, AXP, BCA	1390	für Fahrzeuge mit Servolenkung	0-N1445	VB [BT]	S
1.4 16V	05/99-06/06	AHW, AKQ, APE, AXP, BCA	1390	, für Fahrzeuge mit Servolenkung	0-N1539	VB [BT]	S
1.6	05/99-06/06	AEH, AKL, APF, AVU, BFQ	1595		0-N1041	VB [BT]	S
1.6 16V	02/00-06/06	ATN, AUS, AZD, BCB	1598	, für Fahrzeuge mit Servolenkung	0-N1539	VB [BT]	S
1.6 16V, 1.6 FSI	02/00-06/06	ATN, AUS, AZD, BCB, BAD	1598		0-N1310	VB [DG]	
1.6 16V, 1.6 FSI	02/00-06/06	ATN, AUS, AZD, BCB, BAD	1598	für Fahrzeuge mit Servolenkung	0-N1445	VB [BT]	S
1.6 FSI	01/02-06/06	BAD	1598		0-N1539	VB [BT]	S
1.8 4motion	05/99-06/06	AGN	1781		0-N1041	VB [BT]	S
1.8 T	05/00-06/06	AGU, AUM	1781		0-N1041	VB [BT]	S
1.9 SDI	05/99-06/06	AGP, AQM	1896		0-N1606	VB [BT]	S
1.9 SDI, 1.9 TDI, 1.9 TDI 4motion	05/99-06/06	AGP, AQM, AGR, ALH, AHF, ASV	1896		0-N174	VB [DG]	
1.9 TDI	08/99-06/01	AUY	1896	Rippenanzahl: 5	0-N1441	VB [BT]	S
1.9 TDI	08/99-06/01	AJM	1896		0-N1494	VB [BT]	S
1.9 TDI	09/00-06/06	ATD	1896	→ 12/2002; Rippenanzahl: 5	0-N1441	VB [BT]	S
1.9 TDI	09/00-06/06	AXR	1896		0-N1494	VB [BT]	S
1.9 TDI	09/00-06/06	ATD	1896	01/2003 →	0-N1494	VB [BT]	S
1.9 TDI	09/00-06/06	ATD	1896	→ 12/2002	0-N2047	VB [DG]	
1.9 TDI	09/00-06/06	ATD	1896	→ 12/2002	0-N2139	VB [VD]	
1.9 TDI 4motion	05/99-06/01	AJM	1896	Rippenanzahl: 5	0-N1441	VB [BT]	S
1.9 TDI 4motion	09/00-06/06	ATD	1896	→ 12/2002; Rippenanzahl: 5	0-N1441	VB [BT]	S
1.9 TDI 4motion	09/00-06/06	ATD	1896	01/2003 →	0-N1494	VB [BT]	S
1.9 TDI 4motion	09/00-06/06	ATD	1896	→ 12/2002	0-N2047	VB [DG]	
1.9 TDI 4motion	09/00-06/06	ATD	1896	→ 12/2002	0-N2139	VB [VD]	
1.9 TDI, 1.9 TDI 4motion	05/99-06/06	AJM, ASZ	1896		0-N1494	VB [BT]	S



CM³



Art. Nr.



GOLF IV Variant (1J5)							
1.9 TDI, 1.9 TDI 4motion	05/99-05/06	AGR, ALH, AHF, ASV	1896			0-N1538	VB [BT] S
1.9 TDI, 1.9 TDI 4motion	05/99-06/01	AJM, AJM, AUJ	1896			0-N2047	VB [DG]
1.9 TDI, 1.9 TDI 4motion	05/99-06/01	AJM, AJM, AUJ	1896			0-N2139	VB [VD]
2.0	05/99-06/06	APK, AQY	1984			0-N1041	VB [BT] S
2.3 V5, 2.3 V5 4motion	05/99-06/06	AGZ	2324	ch.1J-W-000001→; Rippenanzahl: 6		0-N2017	VB [BT] S
2.3 V5, 2.3 V5 4motion	10/00-06/06	AQN	2324	Rippenanzahl: 6		0-N1496S	VB [TE]
2.8 V6 4motion	05/99-06/06	AQP, AUE, BDE	2792	Rippenanzahl: 6		0-N1496S	VB [TE]
2.8 V6 4motion	05/99-06/06	AQP, AUE	2792	Rippenanzahl: 7; *		0-N1657	VB [BT] S

GOLF V (1K1)							
1.4 16V	10/03-05/06	BCA	1390	20x130; 17x58; ch.→1K-6-250000; beinhaltenete Rollen: 4		SK-1511	BTK
1.4 16V	10/03-11/08	BCA, BUD	1390	20x130; 17x58; beinhaltenete Rollen: 4		SK-1511AQ1	BTKW
1.4 16V	05/06-11/08	BUD	1390	20x130; 17x58; beinhaltenete Rollen: 4		SK-1511	BTK
1.6	01/04-11/08	BGU, BSE, BSF	1595	23x138; Baumuster: 1K1		SK-1109	BTK
1.6 MultiFuel	10/07-11/08	CCSA	1595	23x138; Baumuster: 1K1		SK-1109	BTK
1.6, 1.6 MultiFuel	01/04-11/08	BGU, BSE, BSF, CCSA	1595	23x138		SK-1109AQ1	BTKW
1.9 TDI, 1.9 TDI 4motion	10/03-11/08	BKC, BLS, BXE, BRU, BXF, BXJ	1896	30x120; mit Zubehör		SK-1372	BTK
1.9 TDI, 1.9 TDI 4motion	10/03-11/08	BKC, BLS, BXE, BRU, BXF, BXJ	1896	30x120		SK-1372AQ1	BTKW
2.0	08/06-11/08	BHY, CBPA	1984	23x138		SK-1109	BTK
2.0	08/06-11/08	BHY, CBPA	1984	23x138		SK-1109AQ2	BTKW
2.0 FSI	01/04-11/08	AXW	1984	23x145; mit Zubehör		SK-1599	BTK
2.0 FSI	01/04-11/08	AXW	1984	23x145; mit Zubehör		SK-1599AQ1	BTKW
2.0 FSI	01/04-11/08	BLR, BLX, BLY, BVX, BVY, BVZ	1984	23x148		SK-1724	BTK
2.0 FSI	01/04-11/08	BLR, BLX, BLY, BVX, BVY, BVZ	1984	23x148		SK-1724AQ2	BTKW
2.0 FSI 4motion	08/04-11/08	BLX, BVX	1984	23x148		SK-1724AQ2	BTKW
2.0 FSI 4motion, 2.0 GTI	08/04-12/08	BLX, BVX, BYD	1984	23x148		SK-1724	BTK
2.0 GTI	10/04-02/09	AXX, BPY, BWA	1984	23x148		SK-1724	BTK
2.0 GTI	10/04-02/09	AXX, BPY, BWA	1984	23x148		SK-1724AQ1	BTKW
2.0 GTI	09/06-12/08	BYD	1984	23x148		SK-1724AQ1	BTKW
2.0 SDI	01/04-11/08	BDK	1968	30x120		SK-1372AQ1	BTKW
2.0 SDI, 2.0 TDI, 2.0 TDI 4motion	01/04-11/08	BDK, BMM	1968	30x120; mit Zubehör		SK-1372	BTK
2.0 TDI	10/03-11/08	CBDA, CBDB	1968	30x160		SK-1694	BTK
2.0 TDI	10/03-11/08	CBDA, CBDB	1968	30x160		SK-1694AQ1	BTKW
2.0 TDI	11/05-11/08	BMN	1968	30x141; mit Zubehör		SK-1668	BTK
2.0 TDI	11/05-11/08	BMN	1968	30x141		SK-1668AQ1	BTKW
2.0 TDI, 2.0 TDI 16V, 2.0 TDI 16V 4motion	10/03-11/08	AZV, BKD	1968	30x141; ch.→1K-6-250000; mit Zubehör		SK-1595	BTK
2.0 TDI, 2.0 TDI 16V, 2.0 TDI 16V 4motion	10/03-11/08	AZV, BKD	1968	30x141; ch.→1K6250000; mit Zubehör		SK-1595AQ1	BTKW
2.0 TDI, 2.0 TDI 16V, 2.0 TDI 16V 4motion	10/03-11/08	AZV, BKD	1968	30x141; ch.1K-7-000001→; mit Zubehör		SK-1668	BTK
2.0 TDI, 2.0 TDI 16V, 2.0 TDI 16V 4motion	10/03-11/08	AZV, BKD	1968	30x141; ch.1K-7-000001→		SK-1668AQ1	BTKW
2.0 TDI, 2.0 TDI 4motion	08/04-11/08	BMM	1968	30x120		SK-1372AQ2	BTKW
1.4 16V	10/03-11/08	BCA, BUD	1390			0-N1262	TB [DG]
1.4 16V	10/03-11/08	BCA, BUD	1390			0-N1263	TB [TE]
1.4 16V	10/03-11/08	BCA, BUD	1390			0-N158	TB [TE]
1.4 16V	10/03-05/06	BCA	1390	ch.→1K-6-650000		0-N164	TB [DG]
1.6, 1.6 MultiFuel	01/04-11/08	BGU, BSE, BSF, CCSA	1595			0-N157	TB [TE]
1.9 SDI	12/05-11/08	BGG	1896			0-N104	TB [TE]
1.9 TDI, 1.9 TDI 4motion	10/03-11/08	BKC, BLS, BXE, BRU, BXF, BXJ	1896			0-N1045	TB [TE]
1.9 TDI, 1.9 TDI 4motion	10/03-11/08	BKC, BLS, BXE, BRU, BXF, BXJ	1896			0-N1046	TB [DG]
2.0 FSI	01/04-11/08	AXW	1984			0-N1340	TB [TE]
2.0 FSI	01/04-11/08	AXW	1984			0-N1341	TB [DG]
2.0 FSI	01/04-11/08	BLR, BLX, BLY, BVX, BVY, BVZ	1984			0-N1346	TB [DG]
2.0 FSI	01/04-11/08	BLX, BLR, BLY, BVX, BVY, BVZ	1984			0-N2208	TB [TE]
2.0 FSI 4motion, 2.0 GTI	08/04-12/08	BLX, BVX, BYD	1984			0-N1346	TB [DG]
2.0 FSI 4motion, 2.0 GTI	08/04-12/08	BLX, BVX, BYD	1984			0-N2208	TB [TE]
2.0 FSI, 2.0 FSI 4motion, 2.0 GTI	01/04-12/08	AXW, BLR, BLX, BLY, BVX, BVY, BVZ, BLX, BVX, BYD	1984			0-N1316	TB [DG]
2.0 GTI	10/04-02/09	AXX, BPY, BWA	1984			0-N1316	TB [DG]
2.0 GTI	10/04-02/09	AXX, BPY, BWA	1984			0-N1346	TB [DG]
2.0 GTI	10/04-02/09	AXX, BWA, BPY	1984			0-N2208	TB [TE]
2.0 SDI, 2.0 TDI, 2.0 TDI 16V, 2.0 TDI 16V 4motion, 2.0 TDI 4motion	10/03-11/08	BDK, BKD, BMM, BMN	1968			0-N1046	TB [DG]
2.0 SDI, 2.0 TDI, 2.0 TDI 4motion	01/04-11/08	BDK, BMM	1968			0-N1045	TB [TE]
2.0 TDI	10/03-11/08	AZV, CBDA	1968			0-N1046	TB [DG]
2.0 TDI	10/03-11/08	CBDA	1968			0-N1336	TB [DG]
2.0 TDI	10/03-11/08	AZV	1968	ch.→1K-6-250000		0-N1336	TB [DG]
2.0 TDI	10/03-11/08	AZV	1968	ch.1K-7-000001→		0-N1575	TB [DG]

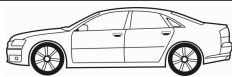

CM³



Art. Nr.



ohne Halter

GOLF V (1K1)

2.0 TDI	10/03-11/08	CBDA	1968		0-N1905	TB [BT]	
2.0 TDI	11/05-11/08	BMN	1968		0-N1575	TB [DG]	
2.0 TDI 16V, 2.0 TDI 16V 4motion	10/03-11/08	BKD	1968	ch.→1K-6-250000	0-N1336	TB [DG]	
2.0 TDI 16V, 2.0 TDI 16V 4motion	10/03-11/08	BKD	1968	ch.1K-7-000001→	0-N1575	TB [DG]	
2.0 TDI, 2.0 TDI 16V, 2.0 TDI 16V 4motion	10/03-11/08	AZV, BKD, BMN	1968		0-N1335	TB [TE]	
1.4 16V	10/03-05/06	BCA	1390		0-N1445	VB [BT]	S
1.4 16V	05/06-11/08	BUD	1390	☼	0-N1445	VB [BT]	S
1.4 FSI	10/03-07/06	BKG, BLN	1390	†; ☼	0-N1454	VB [DG]	
1.4 FSI, 1.4 TSI	10/03-11/08	BKG, BLN, CAXA	1390	☼	0-N1525	VB [BT]	S
1.4 FSI, 1.4 TSI	10/03-11/08	BKG, BLN, CAXA	1390	☼	0-N1733	VB [BT]	S
1.4 TSI	11/05-11/08	BLG, BMY	1390	☼	0-N2050	VB [DG]	
1.4 TSI	11/05-11/08	BLG, BMY	1390	☼	0-N2091	VB [BT]	S
1.4 TSI	11/05-11/08	BLG, BMY	1390		0-N2092	VB [BT]	S
1.4 TSI	11/05-11/08	BLG, BMY	1390	☼	0-N2111	VB [BT]	S
1.4 TSI	11/05-11/08	BLG, BMY	1390	Rippenanzahl: 6	0-N2133	VB [DG]	
1.4 TSI	05/07-11/08	CAXA	1390	†; ☼	0-N1454	VB [DG]	
1.6 FSI	10/03-07/08	BAG, BLF, BLP	1598	†; ☼	0-N1454	VB [DG]	
1.6 FSI	10/03-07/08	BAG, BLF, BLP	1598	☼	0-N1525	VB [BT]	S
1.6 FSI	10/03-07/08	BAG, BLF, BLP	1598	☼	0-N1733	VB [BT]	S
1.9 TDI	05/04-11/08	BRU	1896	ch.→1K-6-000000	0-N1530	VB [BT]	S
1.9 TDI	05/04-11/08	BXF, BXJ	1896		0-N1531	VB [BT]	S
1.9 TDI	05/04-11/08	BRU	1896	ch.1K-6-000001→	0-N1531	VB [BT]	S
1.9 TDI, 1.9 TDI 4motion	10/03-11/08	BKC, BLS, BXE	1896		0-N1531	VB [BT]	S
2.0 GTI	10/04-02/09	AXX, BWA	1984	ch.1K-6-00001→	0-N1656	VB [BT]	S
2.0 GTI	10/04-02/09	CAWB, CBFA, CCTA	1984		0-N1832	VB [BT]	S
2.0 GTI	09/06-12/08	BYD	1984		0-N1656	VB [BT]	S
2.0 SDI, 2.0 TDI, 2.0 TDI 16V, 2.0 TDI 16V 4motion	10/03-11/08	BDK, BKD, BMN	1968		0-N1530	VB [BT]	S
2.0 TDI	10/03-11/08	AZV	1968		0-N1530	VB [BT]	S
2.0 TDI	10/03-11/08	CBAB, CFFB	1968		0-N1534	VB [BT]	S
2.0 TDI, 2.0 TDI 4motion	08/04-11/08	BMM	1968		0-N1531	VB [BT]	S
3.2, 3.2 R32 4motion	09/05-11/08	BUB, BUB, CBRA	3189		0-N1715	VB [DG]	
3.2, 3.2 R32 4motion	09/05-11/08	BUB, BUB, CBRA	3189		0-N2209	VB [BT]	S

GOLF V Variant (1K5)

1.4	06/07-07/09	BUD	1390	20x130; 17x58; beinhaltete Rollen: 4	SK-1511	BTK	
1.4	06/07-07/09	BUD	1390	20x130; 17x58; beinhaltete Rollen: 4	SK-1511AQ1	BTKW	
1.6	06/07-07/09	BSE, BSF	1595	23x138; Baumuster: 1K5	SK-1109	BTK	
1.6 MultiFuel	11/07-07/09	CCSA	1595	23x138; Baumuster: 1K5	SK-1109	BTK	
1.6, 1.6 MultiFuel	06/07-07/09	BGU, BSE, BSF, CCSA, CCSA	1595	23x138	SK-1109AQ1	BTKW	
1.9 TDI, 1.9 TDI 4motion	06/07-07/09	BLS, BLS, BXE	1896	30x120; mit Zubehör	SK-1372	BTK	
1.9 TDI, 1.9 TDI 4motion	06/07-07/09	BLS, BLS, BXE	1896	30x120	SK-1372AQ1	BTKW	
2.0	06/07-07/09	BWA	1984	23x148	SK-1724	BTK	
2.0	06/07-07/09	BWA	1984	23x148	SK-1724AQ1	BTKW	
2.0 TDI	06/07-07/09	BMM	1968	30x120; mit Zubehör	SK-1372	BTK	
2.0 TDI	06/07-07/09	BMM	1968	30x120	SK-1372AQ2	BTKW	
2.0 TDI 16V	06/07-07/09	BKD	1968	30x141; ch.→1K-6-250000; mit Zubehör	SK-1595	BTK	
2.0 TDI 16V	06/07-07/09	BKD	1968	30x141; ch.→1K6250000; mit Zubehör	SK-1595AQ1	BTKW	
2.0 TDI 16V	06/07-07/09	BKD	1968	30x141; ch.1K-7-000001→; mit Zubehör	SK-1668	BTK	
2.0 TDI 16V	06/07-07/09	BKD	1968	30x141; ch.1K-7-000001→	SK-1668AQ1	BTKW	
2.0 TDI 16V	06/07-07/09	CBDB	1968	30x160; → 12/2009	SK-1694	BTK	
2.0 TDI 16V	06/07-07/09	CBDB	1968	30x160; → 04/2012	SK-1694AQ1	BTKW	
2.0 TDI 16V	06/07-07/09	CBDB	1968	30x160	SK-1694AQ2	BTKW	
2.0 TDI, 2.0 TDI 4motion	06/07-07/09	AZV	1968	30x141; ch.→1K-6-250000; mit Zubehör	SK-1595	BTK	
2.0 TDI, 2.0 TDI 4motion	06/07-07/09	AZV	1968	30x141; mit Zubehör	SK-1668	BTK	
1.4	06/07-07/09	BUD	1390		0-N1262	TB [DG]	
1.4	06/07-07/09	BUD	1390		0-N1263	TB [TE]	
1.4	06/07-07/09	BUD	1390		0-N158	TB [TE]	
1.6, 1.6 MultiFuel	06/07-07/09	BGU, BSE, BSF, CCSA, CCSA	1595		0-N157	TB [TE]	
1.9 TDI, 1.9 TDI 4motion	06/07-07/09	BLS, BLS, BXE	1896		0-N1045	TB [TE]	
1.9 TDI, 1.9 TDI 4motion	06/07-07/09	BLS, BLS, BXE	1896		0-N1046	TB [DG]	
2.0	06/07-07/09	BWA	1984		0-N1316	TB [DG]	
2.0	06/07-07/09	BWA	1984		0-N1346	TB [DG]	
2.0	06/07-07/09	BWA	1984		0-N2208	TB [TE]	
2.0 TDI	06/07-07/09	BMM	1968		0-N1045	TB [TE]	
2.0 TDI 16V	06/07-07/09	BKD, CBDB	1968		0-N1046	TB [DG]	



CM³



Art. Nr.



ohne Halter

GOLF V Variant (1K5)

2.0 TDI 16V	06/07-07/09	CBDB	1968		0-N1268	TB [DG]	
2.0 TDI 16V	06/07-07/09	BKD	1968		0-N1335	TB [TE]	
2.0 TDI 16V	06/07-07/09	CBDB	1968		0-N1336	TB [DG]	
2.0 TDI 16V	06/07-07/09	BKD	1968	ch.→1K-6-250000	0-N1336	TB [DG]	
2.0 TDI 16V	06/07-07/09	BKD	1968	ch.1K-7-000001→	0-N1575	TB [DG]	
2.0 TDI 16V	06/07-07/09	CBDB	1968		0-N1905	TB [BT]	
2.0 TDI, 2.0 TDI 4motion	06/07-07/09	AZV, BMM	1968		0-N1046	TB [DG]	
2.0 TDI, 2.0 TDI 4motion	06/07-07/09	AZV	1968		0-N1335	TB [TE]	
2.0 TDI, 2.0 TDI 4motion	06/07-07/09	AZV	1968	ch.→1K-6-250000	0-N1336	TB [DG]	
2.0 TDI, 2.0 TDI 4motion	06/07-07/09	AZV	1968	ch.1K-7-000001→	0-N1575	TB [DG]	
1.4	06/07-07/09	BUD	1390	☼	0-N1445	VB [BT]	S
1.4 TSI	06/07-07/09	CAXA	1390	†; ☼	0-N1454	VB [DG]	
1.4 TSI	06/07-07/09	CAXA	1390	☼	0-N1525	VB [BT]	S
1.4 TSI	06/07-07/09	CAXA	1390	☼	0-N1733	VB [BT]	S
1.4 TSI	06/07-07/09	BLG, BMY, CAVD	1390	☼	0-N2050	VB [DG]	
1.4 TSI	06/07-07/09	BLG, BMY, CAVD	1390	☼	0-N2091	VB [BT]	S
1.4 TSI	06/07-07/09	BLG, BMY, CAVD	1390		0-N2092	VB [BT]	S
1.4 TSI	06/07-07/09	BLG, BMY, CAVD	1390	☼	0-N2111	VB [BT]	S
1.4 TSI	06/07-07/09	BLG, BMY, CAVD	1390	Rippenanzahl: 6	0-N2133	VB [DG]	
1.9 TDI 4motion	01/08-07/09	BLS	1896		0-N1534	VB [BT]	S
1.9 TDI, 1.9 TDI 4motion	06/07-07/09	BLS, BLS, BXE	1896		0-N1531	VB [BT]	S
2.0	06/07-07/09	BWA	1984	ch.1K-6-000001→	0-N1656	VB [BT]	S
2.0	06/07-07/09	CAWB, CCTA	1984		0-N1832	VB [BT]	S
2.0 TDI	06/07-07/09	BMM	1968		0-N1531	VB [BT]	S
2.0 TDI 16V	06/07-07/09	BKD	1968		0-N1530	VB [BT]	S
2.0 TDI 16V	06/07-07/09	CBAB, CFFB	1968		0-N1534	VB [BT]	S
2.0 TDI, 2.0 TDI 4motion	06/07-07/09	AZV	1968		0-N1530	VB [BT]	S

GOLF PLUS (5M1, 521)

1.4 16V	01/05-11/06	BCA	1390	20x130; 17x58; ch.→1K-6-650000; beinhaltetete Rollen: 4	SK-1511	BTK	
1.4 16V	01/05-12/13	BCA, BUD, CGGA	1390	20x130; 17x58; beinhaltetete Rollen: 4	SK-1511AQ1	BTKW	
1.4 16V	05/06-12/13	BUD, CGGA	1390	20x130; 17x58; beinhaltetete Rollen: 4	SK-1511	BTK	
1.6	05/05-12/13	BSE, BSF, CCSA	1595	23x138; Baumuster: 5M1, 521	SK-1109	BTK	
1.6 BiFuel	05/09-12/13	CHGA	1595	23x138; Baumuster: 5M1, 521	SK-1109	BTK	
1.6 MultiFuel	11/07-12/13	CCSA	1595	23x138; Baumuster: 5M1, 521	SK-1109	BTK	
1.6 TDI	02/09-12/13	CAYB, CAYC	1598	25x160	SK-1695	BTK	
1.6 TDI	02/09-12/13	CAYB, CAYC	1598	25x160; → 11/2010	SK-1695AQ1	BTKW	
1.6 TDI	02/09-12/13	CAYC	1598	25x160	SK-1727AQ2	BTKW	
1.6, 1.6 BiFuel, 1.6 MultiFuel	05/05-12/13	BSE, BSF, CCSA, CMXA, CCSA, CMXA, CHGA	1595	23x138	SK-1109AQ1	BTKW	
1.9 TDI	01/05-01/09	BKC, BLS, BXE, BRU, BXF, BXJ	1896	30x120; mit Zubehör	SK-1372	BTK	
1.9 TDI	01/05-01/09	BKC, BLS, BXE, BRU, BXF, BXJ	1896	30x120	SK-1372AQ1	BTKW	
2.0 FSI	05/05-06/08	BLR, BLY, BVY, BVZ	1984	23x148	SK-1724	BTK	
2.0 FSI	05/05-06/08	BLR, BLY, BVY, BVZ	1984	23x148	SK-1724AQ2	BTKW	
2.0 TDI	05/05-05/07	BEE	1968	30x141; mit Zubehör	SK-1595	BTK	
2.0 TDI	05/05-05/07	BEE	1968	30x141; mit Zubehör	SK-1595AQ1	BTKW	
2.0 TDI	05/05-12/13	CBDA, CBDB	1968	30x160	SK-1694	BTK	
2.0 TDI	05/05-12/13	CBDA, CBDB	1968	30x160	SK-1694AQ1	BTKW	
2.0 TDI	05/05-12/13	CFHB	1968	25x160; → 11/2010	SK-1727AQ1	BTKW	
2.0 TDI	12/05-05/11	BMM	1968	30x120; mit Zubehör	SK-1372	BTK	
2.0 TDI	12/05-05/11	BMM	1968	30x120	SK-1372AQ2	BTKW	
2.0 TDI	01/09-12/13	CBDC	1968	30x160; → 11/2010	SK-1694	BTK	
2.0 TDI	01/09-12/13	CBDB, CBDC	1968	30x160	SK-1694AQ1	BTKW	
2.0 TDI	01/09-12/13	CLCA	1968	25x160; → 11/2010	SK-1695	BTK	
2.0 TDI	01/09-12/13	CLCA	1968	25x160; → 11/2010	SK-1695AQ1	BTKW	
2.0 TDI	01/09-12/13	CLCA	1968	25x160; 12/2010 →	SK-1727	BTK	
2.0 TDI	01/09-12/13	CLCA	1968	25x160; → 11/2010	SK-1727AQ1	BTKW	
2.0 TDI	01/09-12/13	CLCA	1968	25x160; 2012→	SK-1727AQ2	BTKW	
2.0 TDI 16V	01/05-12/13	CBDB	1968	30x160	SK-1694	BTK	
2.0 TDI 16V	01/05-12/13	CBDB	1968	30x160	SK-1694AQ1	BTKW	
2.0 TDI 16V	01/05-12/13	CFHB, CFHC	1968	25x160; → 11/2010	SK-1727AQ1	BTKW	
2.0 TDI, 2.0 TDI 16V	01/05-12/13	AZV, CBDA, CFHB, BKD, CBDB, CFHC	1968	30x141; ch.→1K-6-650000; mit Zubehör	SK-1595	BTK	
2.0 TDI, 2.0 TDI 16V	01/05-12/13	AZV, CBDA, CFHB, BKD, CBDB, CFHC	1968	30x141; ch.→1K6650000; mit Zubehör	SK-1595AQ1	BTKW	
2.0 TDI, 2.0 TDI 16V	01/05-12/13	AZV, CBDA, CFHB, BKD, CBDB, CFHC	1968	30x141; ch.1K-7-500001→; mit Zubehör	SK-1668	BTK	
2.0 TDI, 2.0 TDI 16V	01/05-12/13	AZV, CBDA, CFHB, BKD, CBDB, CFHC	1968	30x141; ch.1K-7-500001→	SK-1668AQ1	BTKW	



OPTIMAL®

VW

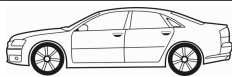

CM³



Art. Nr.



GOLF PLUS (5M1, 521)

2.0 TDI, 2.0 TDI 16V	01/05-12/13	CFHB, CFHC	1968	25x160; 2012→	SK-1727AQ2	BTKW	
1.4 16V	01/05-12/13	BCA, BUD, CGGA	1390		0-N1262	TB [DG]	
1.4 16V	01/05-12/13	BCA, BUD, CGGA	1390		0-N1263	TB [TE]	
1.4 16V	01/05-12/13	BCA, BUD, CGGA	1390		0-N158	TB [TE]	
1.4 16V	01/05-11/06	BCA	1390	ch.→1K-6-650000	0-N164	TB [DG]	
1.6 TDI	02/09-12/13	CAYB, CAYC	1598		0-N131	TB [DG]	
1.6 TDI	02/09-12/13	CAYB	1598	ch.1K-9-900001→	0-N2025	TB [DG]	
1.6 TDI	02/09-12/13	CAYB, CAYC	1598		0-N2200	TB [DG]	
1.6 TDI	03/09-12/13	CAYC	1598		0-N2025	TB [DG]	
1.6, 1.6 BiFuel, 1.6 MultiFuel	05/05-12/13	BSE, BSF, CCSA, CMXA, CCSA, CMXA, CHGA	1595		0-N157	TB [TE]	
1.9 SDI	12/05-12/13	BGG	1896		0-N104	TB [TE]	
1.9 TDI	01/05-01/09	BKC, BLS, BXE, BRU, BXF, BXJ	1896		0-N1045	TB [TE]	
1.9 TDI	01/05-01/09	BKC, BLS, BXE, BRU, BXF, BXJ	1896		0-N1046	TB [DG]	
2.0 FSI	05/05-06/08	BLR, BLY, BVY, BVZ	1984		0-N1316	TB [DG]	
2.0 FSI	05/05-06/08	BLR, BLY, BVY, BVZ	1984		0-N1346	TB [DG]	
2.0 FSI	05/05-06/08	BLR, BLY, BVY, BVZ	1984		0-N2208	TB [TE]	
2.0 TDI	05/05-12/13	AZV, CBDA	1968		0-N1046	TB [DG]	
2.0 TDI	05/05-12/13	CFHB	1968	→ 11/2010	0-N1046	TB [DG]	
2.0 TDI	05/05-12/13	CBDA	1968		0-N1268	TB [DG]	
2.0 TDI	05/05-12/13	CFHB	1968		0-N131	TB [DG]	
2.0 TDI	05/05-12/13	AZV	1968		0-N1335	TB [TE]	
2.0 TDI	05/05-12/13	CBDA	1968		0-N1336	TB [DG]	
2.0 TDI	05/05-12/13	AZV	1968	ch.→1K-6-650000	0-N1336	TB [DG]	
2.0 TDI	05/05-12/13	AZV	1968	ch.1K-7-500001→	0-N1575	TB [DG]	
2.0 TDI	05/05-12/13	CBDA	1968		0-N1905	TB [BT]	
2.0 TDI	05/05-12/13	CFHB	1968		0-N2025	TB [DG]	
2.0 TDI	05/05-12/13	CFHB	1968	12/2010 →	0-N2200	TB [DG]	
2.0 TDI	12/05-05/11	BMM	1968		0-N1045	TB [TE]	
2.0 TDI	12/05-05/11	BMM	1968		0-N1046	TB [DG]	
2.0 TDI	01/09-12/13	CBDC	1968		0-N1046	TB [DG]	
2.0 TDI	01/09-12/13	CLCA	1968	→ 11/2010	0-N1046	TB [DG]	
2.0 TDI	01/09-12/13	CBDC	1968		0-N1268	TB [DG]	
2.0 TDI	01/09-12/13	CLCA	1968		0-N131	TB [DG]	
2.0 TDI	01/09-12/13	CBDC	1968		0-N1336	TB [DG]	
2.0 TDI	01/09-12/13	CBDC	1968		0-N1905	TB [BT]	
2.0 TDI	01/09-12/13	CLCA	1968		0-N2025	TB [DG]	
2.0 TDI	01/09-12/13	CLCA	1968	12/2010 →	0-N2200	TB [DG]	
2.0 TDI 16V	01/05-12/13	BKD, CBDB	1968		0-N1046	TB [DG]	
2.0 TDI 16V	01/05-12/13	CFHC	1968	→ 11/2010	0-N1046	TB [DG]	
2.0 TDI 16V	01/05-12/13	CBDB	1968		0-N1268	TB [DG]	
2.0 TDI 16V	01/05-12/13	CFHC	1968		0-N131	TB [DG]	
2.0 TDI 16V	01/05-12/13	BKD	1968		0-N1335	TB [TE]	
2.0 TDI 16V	01/05-12/13	CBDB	1968		0-N1336	TB [DG]	
2.0 TDI 16V	01/05-12/13	BKD	1968	ch.→1K-6-650000	0-N1336	TB [DG]	
2.0 TDI 16V	01/05-12/13	BKD	1968	ch.1K-7-500001→	0-N1575	TB [DG]	
2.0 TDI 16V	01/05-12/13	CBDB	1968		0-N1905	TB [BT]	
2.0 TDI 16V	01/05-12/13	CFHC	1968		0-N2025	TB [DG]	
2.0 TDI 16V	01/05-12/13	CFHC	1968	12/2010 →	0-N2200	TB [DG]	
1.2 TSI	11/09-12/13	CBZA, CBZB	1197	☼	0-N1733	VB [BT]	S
1.2 TSI	11/09-12/13	CBZA, CBZB	1197	☼	0-N2121	VB [DG]	
1.4 16V	01/05-12/13	BCA, BUD, CGGA	1390	☼	0-N1445	VB [BT]	S
1.4 FSI	07/05-11/06	BLN	1390	☼; ☼	0-N1454	VB [DG]	
1.4 FSI, 1.4 TSI	07/05-12/13	BLN, CAXA	1390	☼	0-N1525	VB [BT]	S
1.4 FSI, 1.4 TSI	07/05-12/13	BLN, CAXA	1390	☼	0-N1733	VB [BT]	S
1.4 TSI	05/06-12/13	BLG, BMY, CAVD, CNWA	1390	☼	0-N2050	VB [DG]	
1.4 TSI	05/06-12/13	BLG, BMY, CAVD, CNWA	1390	☼	0-N2091	VB [BT]	S
1.4 TSI	05/06-12/13	BLG, BMY, CAVD, CNWA	1390	☼	0-N2092	VB [BT]	S
1.4 TSI	05/06-12/13	BLG, BMY, CAVD, CNWA	1390	☼	0-N2111	VB [BT]	S
1.4 TSI	05/06-12/13	BLG, BMY, CAVD, CNWA	1390	Rippenanzahl: 6	0-N2133	VB [DG]	
1.4 TSI	06/07-12/13	CAXA	1390	☼; ☼	0-N1454	VB [DG]	
1.6 FSI	01/05-05/08	BLF	1598	☼; ☼	0-N1454	VB [DG]	
1.6 FSI	01/05-05/08	BLF	1598	☼	0-N1525	VB [BT]	S
1.6 FSI	01/05-05/08	BLF	1598	☼	0-N1733	VB [BT]	S
1.6 TDI	02/09-12/13	CAYB, CAYC	1598		0-N1534	VB [BT]	S

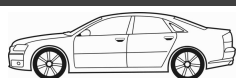

CM³



Art. Nr.



GOLF PLUS (5M1, 521)							
1.9 TDI	01/05-01/09	BKC	1896	ch.→1K-6-000000	0-N1530	VB [BT]	S
1.9 TDI	01/05-01/09	BLS, BXE	1896		0-N1531	VB [BT]	S
1.9 TDI	01/05-01/09	BKC	1896	ch.1K-6-000001→	0-N1531	VB [BT]	S
1.9 TDI	05/05-12/08	BRU	1896	ch.→1K-6-000000	0-N1530	VB [BT]	S
1.9 TDI	05/05-12/08	BXF, BXJ	1896		0-N1531	VB [BT]	S
1.9 TDI	05/05-12/08	BRU	1896	ch.1K-6-000001→	0-N1531	VB [BT]	S
2.0 TDI	05/05-12/13	AZV	1968		0-N1530	VB [BT]	S
2.0 TDI	12/05-05/11	BMM	1968		0-N1531	VB [BT]	S
2.0 TDI	01/09-12/13	CBAB, CFFB	1968		0-N1534	VB [BT]	S
2.0 TDI 16V	01/05-12/13	BKD	1968		0-N1530	VB [BT]	S
2.0 TDI, 2.0 TDI 16V	01/05-12/13	CBAB, CBDA, CFFB	1968		0-N1534	VB [BT]	S

GOLF VI (5K1)							
1.4	10/08-11/12	CGGA	1390	20x130; 17x58; beinhaltetete Rollen: 4	SK-1511	BTK	
1.4	10/08-11/12	CGGA	1390	20x130; 17x58; beinhaltetete Rollen: 4	SK-1511AQ1	BTKW	
1.6	10/08-11/12	BSE, BSF, CCSA, CMXA	1595	23x138; Baumuster: 5K1	SK-1109	BTK	
1.6 BiFuel	03/09-11/12	CHGA	1595	23x138; Baumuster: 5K1	SK-1109	BTK	
1.6 MultiFuel	10/08-11/12	CCSA, CMXA	1595	23x138; 05/2010 →	SK-1109	BTK	
1.6 MultiFuel	10/08-11/12	CCSA, CMXA	1595	23x138; 05/2010 →	SK-1109AQ1	BTKW	
1.6 TDI	02/09-11/12	CAYB, CAYC	1598	25x160	SK-1695	BTK	
1.6 TDI	02/09-11/12	CAYB, CAYC	1598	25x160; → 11/2010	SK-1695AQ1	BTKW	
1.6 TDI	02/09-11/12	CAYC	1598	25x160	SK-1727AQ2	BTKW	
1.6, 1.6 BiFuel	10/08-11/12	BSE, BSF, CCSA, CMXA, CHGA	1595	23x138	SK-1109AQ1	BTKW	
2.0 GTi, 2.0 R 4motion	11/09-11/13	CDLA, CDLC, CRZA, CDLF, CDLG	1984	23x148	SK-1724	BTK	
2.0 GTi, 2.0 R 4motion	11/09-11/13	CDLA, CDLC, CRZA, CDLF, CDLG	1984	23x148	SK-1724AQ1	BTKW	
2.0 TDI	10/08-05/13	CBAB, CJAA	1968	30x160	SK-1694	BTK	
2.0 TDI	10/08-11/12	CBAA	1968	30x160	SK-1694	BTK	
2.0 TDI	10/08-11/12	CBDC, CLCA	1968	30x160; → 05/2011	SK-1694	BTK	
2.0 TDI	10/08-11/12	CBAA, CJAA	1968	30x160	SK-1694AQ1	BTKW	
2.0 TDI	10/08-11/12	CBDC	1968	30x160	SK-1694AQ1	BTKW	
2.0 TDI	10/08-05/13	CFFB	1968	25x160; → 11/2012	SK-1695	BTK	
2.0 TDI	10/08-11/12	CFFA	1968	25x160	SK-1695	BTK	
2.0 TDI	10/08-11/12	CFFA	1968	25x160; → 11/2010	SK-1695AQ1	BTKW	
2.0 TDI	10/08-11/12	CFFA	1968	25x160; → 11/2010	SK-1727AQ1	BTKW	
2.0 TDI	10/08-11/12	CLCA	1968	25x160; → 11/2010	SK-1727AQ1	BTKW	
2.0 TDI	10/08-11/12	CLCA	1968	25x160; 2012→	SK-1727AQ2	BTKW	
2.0 TDI	04/09-11/12	CBBB	1968	30x160	SK-1694	BTK	
2.0 TDI	04/09-11/12	CBBB	1968	30x160	SK-1694AQ2	BTKW	
2.0 TDI	04/09-11/12	CFGB	1968	25x160	SK-1695	BTK	
2.0 TDI	04/09-11/12	CFGB	1968	25x160; → 11/2010	SK-1695AQ1	BTKW	
2.0 TDI	04/09-11/12	CFGB	1968	25x160; → 11/2010	SK-1727AQ2	BTKW	
2.0 TDI 4motion	05/09-11/12	CBAB	1968	30x160	SK-1694	BTK	
2.0 TDI 4motion	05/09-11/12	CFFB	1968	25x160	SK-1695	BTK	
2.0 TDI, 2.0 TDI 4motion	10/08-05/13	CBAB, CJAA	1968	30x160	SK-1694AQ1	BTKW	
2.0 TDI, 2.0 TDI 4motion	10/08-05/13	CFFB	1968	25x160; → 11/2010	SK-1695AQ1	BTKW	
2.0 TDI, 2.0 TDI 4motion	10/08-05/13	CFFB	1968	25x160; → 11/2010	SK-1727AQ1	BTKW	
2.0 TDI, 2.0 TDI 4motion	10/08-05/13	CFFA, CFFB	1968	25x160; 2012→	SK-1727AQ2	BTKW	
1.4	10/08-11/12	CGGA	1390		0-N1262	TB [DG]	
1.4	10/08-11/12	CGGA	1390		0-N1263	TB [TE]	
1.4	10/08-11/12	CGGA	1390		0-N158	TB [TE]	
1.6 TDI	02/09-11/12	CAYB, CAYC	1598		0-N131	TB [DG]	
1.6 TDI	02/09-11/12	CAYB, CAYC	1598		0-N2025	TB [DG]	
1.6 TDI	02/09-11/12	CAYB, CAYC	1598		0-N2200	TB [DG]	
1.6, 1.6 BiFuel, 1.6 MultiFuel	10/08-11/12	BSE, BSF, CCSA, CMXA, CCSA, CMXA, CHGA	1595		0-N157	TB [TE]	
2.0 GTi, 2.0 R 4motion	11/09-11/13	CDLA, CDLC, CRZA, CDLF, CDLG	1984		0-N1316	TB [DG]	
2.0 GTi, 2.0 R 4motion	11/09-11/13	CDLA, CDLC, CRZA, CDLF, CDLG	1984		0-N1346	TB [DG]	
2.0 GTi, 2.0 R 4motion	11/09-11/13	CDLA, CDLC, CRZA, CDLF, CDLG	1984		0-N2208	TB [TE]	
2.0 TDI	10/08-05/13	CBAB, CJAA	1968		0-N1046	TB [DG]	
2.0 TDI	10/08-05/13	CFFB	1968	→ 10/2010	0-N1046	TB [DG]	
2.0 TDI	10/08-11/12	CBAA	1968		0-N1046	TB [DG]	
2.0 TDI	10/08-11/12	CBDC	1968		0-N1046	TB [DG]	
2.0 TDI	10/08-11/12	CFFA	1968	→ 11/2010	0-N1046	TB [DG]	
2.0 TDI	10/08-11/12	CLCA	1968	→ 11/2010	0-N1046	TB [DG]	
2.0 TDI	10/08-05/13	CBAB, CJAA	1968		0-N1268	TB [DG]	
2.0 TDI	10/08-11/12	CBAA	1968		0-N1268	TB [DG]	



OPTIMAL®

VW



CM³



Art. Nr.



ohne Halter

GOLF VI (5K1)

2.0 TDI	10/08-11/12	CBDC	1968			0-N1268	TB [DG]	
2.0 TDI	10/08-11/12	CFFA	1968			0-N131	TB [DG]	
2.0 TDI	10/08-11/12	CLCA	1968			0-N131	TB [DG]	
2.0 TDI	10/08-05/13	CBAB, CJAA	1968			0-N1336	TB [DG]	
2.0 TDI	10/08-11/12	CBAA	1968			0-N1336	TB [DG]	
2.0 TDI	10/08-11/12	CBDC	1968			0-N1336	TB [DG]	
2.0 TDI	10/08-05/13	CBAB, CJAA	1968			0-N1905	TB [BT]	
2.0 TDI	10/08-11/12	CBAA	1968			0-N1905	TB [BT]	
2.0 TDI	10/08-11/12	CBDC	1968			0-N1905	TB [BT]	
2.0 TDI	10/08-05/13	CFFB, CJAA	1968			0-N2025	TB [DG]	
2.0 TDI	10/08-11/12	CFFA	1968			0-N2025	TB [DG]	
2.0 TDI	10/08-11/12	CLCA	1968			0-N2025	TB [DG]	
2.0 TDI	10/08-11/12	CFFA	1968	12/2010 →		0-N2200	TB [DG]	
2.0 TDI	10/08-11/12	CLCA	1968	12/2010 →		0-N2200	TB [DG]	
2.0 TDI	04/09-11/12	CBBB	1968			0-N1046	TB [DG]	
2.0 TDI	04/09-11/12	CFGB	1968	→ 10/2010		0-N1046	TB [DG]	
2.0 TDI	04/09-11/12	CBBB	1968			0-N1268	TB [DG]	
2.0 TDI	04/09-11/12	CFGB	1968			0-N131	TB [DG]	
2.0 TDI	04/09-11/12	CBBB	1968			0-N1336	TB [DG]	
2.0 TDI	04/09-11/12	CBBB	1968			0-N1905	TB [BT]	
2.0 TDI	04/09-11/12	CFGB	1968			0-N2025	TB [DG]	
2.0 TDI	04/09-11/12	CFGB	1968	12/2010 →		0-N2200	TB [DG]	
2.0 TDI 4motion	05/09-11/12	CBAB	1968			0-N1046	TB [DG]	
2.0 TDI 4motion	05/09-11/12	CFFB	1968	→ 11/2010		0-N1046	TB [DG]	
2.0 TDI 4motion	05/09-11/12	CBAB	1968			0-N1268	TB [DG]	
2.0 TDI 4motion	05/09-11/12	CBAB	1968			0-N1336	TB [DG]	
2.0 TDI 4motion	05/09-11/12	CBAB	1968			0-N1905	TB [BT]	
2.0 TDI 4motion	05/09-11/12	CFFB	1968			0-N2025	TB [DG]	
2.0 TDI, 2.0 TDI 4motion	10/08-05/13	CFFB	1968			0-N131	TB [DG]	
2.0 TDI, 2.0 TDI 4motion	10/08-05/13	CFFB	1968	12/2010 →		0-N2200	TB [DG]	
1.2 TSI	11/08-11/12	CBZA, CBZB	1197	⚠		0-N1733	VB [BT]	S
1.2 TSI	11/08-11/12	CBZA, CBZB	1197	⚠		0-N2121	VB [DG]	
1.4	10/08-11/12	CGGA	1390	⚠		0-N1445	VB [BT]	S
1.4 TSI	10/08-11/12	CAXA	1390	⚠; ⚠		0-N1454	VB [DG]	
1.4 TSI	10/08-11/12	CAXA	1390	⚠		0-N1525	VB [BT]	S
1.4 TSI	10/08-11/12	CAXA	1390	⚠		0-N1733	VB [BT]	S
1.4 TSI	10/08-11/12	CAVD, CNWA, CTHD, CTKA	1390	⚠		0-N2050	VB [DG]	
1.4 TSI	10/08-11/12	CAVD, CNWA, CTHD, CTKA	1390	⚠		0-N2091	VB [BT]	S
1.4 TSI	10/08-11/12	CAVD, CNWA, CTHD, CTKA	1390	⚠		0-N2092	VB [BT]	S
1.4 TSI	10/08-11/12	CAVD, CNWA, CTHD, CTKA	1390	⚠		0-N2111	VB [BT]	S
1.4 TSI	10/08-11/12	CAVD, CNWA, CTHD, CTKA	1390	Rippenanzahl: 6		0-N2133	VB [DG]	
1.6 TDI	02/09-11/12	CAYB, CAYC	1598			0-N1534	VB [BT]	S
1.8 TSI	06/09-01/11	CDA	1798			0-N1832	VB [BT]	S
2.0 GTi	04/09-11/13	CBFA, CCTA, CCZA, CCZB	1984			0-N1832	VB [BT]	S
2.0 GTi, 2.0 R 4motion	11/09-11/13	CDLA, CDLC, CRZA, CDLF, CDLG	1984			0-N1656	VB [BT]	S
2.0 TDI, 2.0 TDI 4motion	10/08-05/13	CBAB, CFFB	1968			0-N1534	VB [BT]	S

GOLF VI Cabriolet (517)

1.6 TDI	03/11-	CAYC	1598	25x160		SK-1695	BTK	
1.6 TDI	03/11-	CAYC	1598	25x160		SK-1727AQ2	BTKW	
2.0 R	01/13-	CDLA	1984	23x148		SK-1724	BTK	
2.0 R	01/13-	CDLA	1984	23x148		SK-1724AQ1	BTKW	
2.0 TDI	11/11-	CFHC	1968	25x160		SK-1727	BTK	
2.0 TDI	11/11-	CFHC	1968	25x160		SK-1727AQ2	BTKW	
1.2 TSI 16V	11/13-	CYVD	1197			0-N2313	TB [TE]	
1.2 TSI 16V	11/13-	CYVD	1197			0-N2381	TB [DG]	
1.6 TDI	03/11-	CAYC	1598			0-N131	TB [DG]	
1.6 TDI	03/11-	CAYC	1598			0-N2025	TB [DG]	
1.6 TDI	03/11-	CAYC	1598			0-N2200	TB [DG]	
2.0 R	01/13-	CDLA	1984			0-N2208	TB [TE]	
2.0 TDI	11/11-	CFHC, CUUB	1968			0-N131	TB [DG]	
2.0 TDI	11/11-	CFHC	1968			0-N2200	TB [DG]	
2.0 TDI	11/13-	CUUB	1968			0-N2314	TB [TE]	
1.2 TSI	03/11-	CBZB	1197	⚠		0-N1733	VB [BT]	S
1.2 TSI	03/11-	CBZB	1197	⚠		0-N2121	VB [DG]	
1.4 TSI	03/11-	CAVD, CNWA, CTHD, CTKA	1390	⚠		0-N2050	VB [DG]	

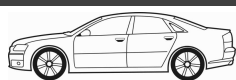

CM³



Art. Nr.



GOLF VI Cabriolet (517)							
1.4 TSI	03/11-	CAVD, CNWA, CTHD, CTKA	1390	✳		0-N2091	VB [BT] S
1.4 TSI	03/11-	CAVD, CNWA, CTHD, CTKA	1390			0-N2092	VB [BT] S
1.4 TSI	03/11-	CAVD, CNWA, CTHD, CTKA	1390	✳		0-N2111	VB [BT] S
1.4 TSI	03/11-	CAVD, CNWA, CTHD, CTKA	1390		Rippenanzahl: 6	0-N2133	VB [DG]
1.4 TSI	11/11-	CAXA	1390	✳		0-N1525	VB [BT] S
1.4 TSI	11/11-	CAXA	1390	✳		0-N1733	VB [BT] S
1.6 TDI	03/11-	CAYC	1598			0-N1534	VB [BT] S
2.0 TDI	11/11-	CFHC	1968			0-N1534	VB [BT] S
2.0 TDI	11/13-	CUUB	1968	✳		0-N2288	VB [BT] S
2.0 TSI	11/11-	CCZB	1984			0-N1832	VB [BT] S

GOLF VI Variant (AJ5)							
1.4	07/09-07/13	BUD	1390	20x130; 17x58; beinhaltetete Rollen: 4		SK-1511	BTK
1.4	07/09-07/13	BUD, CGGA	1390	20x130; 17x58; beinhaltetete Rollen: 4		SK-1511AQ1	BTKW
1.6	07/09-07/13	BSE, BSF, CCSA, CMXA	1595	23x138; Baumuster: AJ5		SK-1109	BTK
1.6 MultiFuel	07/10-07/13	CMXA	1595	23x138		SK-1109	BTK
1.6 TDI, 1.6 TDI 4motion	07/09-07/13	CAYB, CAYC	1598	25x160		SK-1695	BTK
1.6 TDI, 1.6 TDI 4motion	07/09-07/13	CAYB, CAYC	1598	25x160; → 11/2010		SK-1695AQ1	BTKW
1.6 TDI, 1.6 TDI 4motion	07/09-07/13	CAYC	1598	25x160; 12/2010 →		SK-1727	BTK
1.6 TDI, 1.6 TDI 4motion	07/09-07/13	CAYC	1598	25x160		SK-1727AQ2	BTKW
1.6, 1.6 MultiFuel	07/09-07/13	BSE, BSF, CCSA, CMXA, CMXA	1595	23x138		SK-1109AQ1	BTKW
2.0 TDI	07/09-07/13	BMM	1968	30x120; mit Zubehör		SK-1372	BTK
2.0 TDI	07/09-07/13	CBDA, CBDB	1968	30x160		SK-1694	BTK
2.0 TDI	07/09-07/13	CBDA, CBDB	1968	30x160; → 04/2012		SK-1694AQ1	BTKW
2.0 TDI	07/09-07/13	CBDA, CBDB	1968	30x160; 05/2012 →		SK-1694AQ2	BTKW
2.0 TDI	07/09-07/13	CFHB	1968	25x160; → 11/2010		SK-1695AQ1	BTKW
2.0 TDI	01/10-07/13	CLCA	1968	25x160; → 11/2010		SK-1695	BTK
2.0 TDI	01/10-07/13	CLCA	1968	25x160; → 11/2010		SK-1695AQ1	BTKW
2.0 TDI	01/10-07/13	CLCA	1968	25x160; 12/2010 →		SK-1727	BTK
2.0 TDI	01/10-07/13	CLCA	1968	25x160		SK-1727AQ2	BTKW
2.0 TDI 16V	07/09-07/13	CBDB	1968	30x160		SK-1694	BTK
2.0 TDI 16V	07/09-07/13	CBDB	1968	30x160; → 04/2012		SK-1694AQ1	BTKW
2.0 TDI 16V	07/09-07/13	CBDB	1968	30x160; 05/2012 →		SK-1694AQ2	BTKW
2.0 TDI 16V	07/09-07/13	CFHC	1968	25x160; → 11/2010		SK-1695AQ1	BTKW
2.0 TDI 16V	07/09-07/13	CFHC	1968	25x160; 12/2010 →		SK-1727	BTK
2.0 TDI, 2.0 TDI 16V	07/09-07/13	CFHB, CFHC	1968	25x160		SK-1727AQ2	BTKW
1.4	07/09-07/13	BUD, CGGA	1390			0-N1262	TB [DG]
1.4	07/09-07/13	BUD, CGGA	1390			0-N1263	TB [TE]
1.4	07/09-07/13	BUD, CGGA	1390			0-N158	TB [TE]
1.6 TDI, 1.6 TDI 4motion	07/09-07/13	CAYB, CAYC	1598			0-N131	TB [DG]
1.6 TDI, 1.6 TDI 4motion	07/09-07/13	CAYB, CAYC	1598			0-N2025	TB [DG]
1.6 TDI, 1.6 TDI 4motion	07/09-07/13	CAYB, CAYC	1598			0-N2200	TB [DG]
1.6, 1.6 MultiFuel	07/09-07/13	BSE, BSF, CCSA, CMXA, CMXA	1595			0-N157	TB [TE]
2.0 TDI	07/09-07/13	BMM	1968			0-N1045	TB [TE]
2.0 TDI	07/09-07/13	BMM	1968			0-N1046	TB [DG]
2.0 TDI	07/09-07/13	CBDA	1968			0-N1046	TB [DG]
2.0 TDI	07/09-07/13	CFHB	1968	→ 11/2010		0-N1046	TB [DG]
2.0 TDI	07/09-07/13	CBDA	1968			0-N1268	TB [DG]
2.0 TDI	07/09-07/13	CFHB	1968			0-N131	TB [DG]
2.0 TDI	07/09-07/13	CBDA	1968			0-N1336	TB [DG]
2.0 TDI	07/09-07/13	CBDA	1968			0-N1905	TB [BT]
2.0 TDI	07/09-07/13	CFHB	1968			0-N2025	TB [DG]
2.0 TDI	07/09-07/13	CFHB	1968	12/2010 →		0-N2200	TB [DG]
2.0 TDI	01/10-07/13	CLCA	1968			0-N131	TB [DG]
2.0 TDI 16V	07/09-07/13	CBDB	1968			0-N1046	TB [DG]
2.0 TDI 16V	07/09-07/13	CFHC	1968	→ 11/2010		0-N1046	TB [DG]
2.0 TDI 16V	07/09-07/13	CBDB	1968			0-N1268	TB [DG]
2.0 TDI 16V	07/09-07/13	CFHC	1968			0-N131	TB [DG]
2.0 TDI 16V	07/09-07/13	CBDB	1968			0-N1336	TB [DG]
2.0 TDI 16V	07/09-07/13	CBDB	1968			0-N1905	TB [BT]
2.0 TDI 16V	07/09-07/13	CFHC	1968			0-N2025	TB [DG]
2.0 TDI 16V	07/09-07/13	CFHC	1968	12/2010 →		0-N2200	TB [DG]
1.2 TSI	07/09-07/13	CBZA, CBZB	1197	✳		0-N1733	VB [BT] S
1.2 TSI	07/09-07/13	CBZA, CBZB	1197	✳		0-N2121	VB [DG]
1.4	07/09-07/13	BUD, CGGA	1390	✳		0-N1445	VB [BT] S
1.4 TSI	07/09-07/13	CAXA	1390	†; ✳		0-N1454	VB [DG]



OPTIMAL®

VW

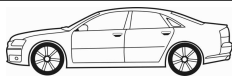

CM³



Art. Nr.



GOLF VI Variant (AJ5)							
1.4 TSI	07/09-07/13	CAXA	1390	☼	0-N1525	VB [BT]	S
1.4 TSI	07/09-07/13	CAXA	1390	☼	0-N1733	VB [BT]	S
1.4 TSI	07/09-07/13	CAVD, CNWA, CTHD, CTKA	1390	☼	0-N2050	VB [DG]	
1.4 TSI	07/09-07/13	CAVD, CNWA, CTHD, CTKA	1390	☼	0-N2091	VB [BT]	S
1.4 TSI	07/09-07/13	CAVD, CNWA, CTHD, CTKA	1390		0-N2092	VB [BT]	S
1.4 TSI	07/09-07/13	CAVD, CNWA, CTHD, CTKA	1390	☼	0-N2111	VB [BT]	S
1.4 TSI	07/09-07/13	CAVD, CNWA, CTHD, CTKA	1390	Rippenanzahl: 6	0-N2133	VB [DG]	
1.6 TDI, 1.6 TDI 4motion	07/09-07/13	CAYB, CAYC	1598		0-N1534	VB [BT]	S
2.0 TDI	07/09-07/13	BMM	1968		0-N1531	VB [BT]	S
2.0 TDI	07/09-07/13	CBAB, CBDA, CFFB	1968		0-N1534	VB [BT]	S
2.0 TDI	01/10-07/13	CLCA	1968		0-N1534	VB [BT]	S
2.0 TDI 16V	07/09-07/13	CBAB, CFFB	1968		0-N1534	VB [BT]	S
GOLF SPORTSVAN (AM1)							
1.2 TSI	04/14-	CYVA, CYVB	1197		0-N2313	TB [TE]	
1.2 TSI	04/14-	CYVA, CYVB	1197		0-N2381	TB [DG]	
1.4 TSI, 1.4 TSI MultiFuel	02/14-	CPVB, CPVB, CZCA, CZDA	1395		0-N2313	TB [TE]	
1.4 TSI, 1.4 TSI MultiFuel	02/14-	CPVB, CPVB, CZCA, CZDA	1395		0-N2381	TB [DG]	
1.6	05/14-	CWVA	1598		0-N2313	TB [TE]	
1.6	05/14-	CWVA	1598		0-N2381	TB [DG]	
1.6 TDI	02/14-	CRKA, CXXA, CRKB, CXXB, DBKA	1598		0-N131	TB [DG]	
1.6 TDI	02/14-	CRKA, CXXA, CRKB, CXXB, DBKA	1598		0-N2314	TB [TE]	
2.0 TDI	02/14-	CRLB, CRVA	1968		0-N131	TB [DG]	
2.0 TDI	02/14-	CRLB, CRVA	1968		0-N2314	TB [TE]	
1.6 TDI	02/14-	CRKA, CXXA, CRKB, CXXB, DBKA	1598	☼	0-N2288	VB [BT]	S
2.0 TDI	02/14-	CRLB, CRVA	1968	☼	0-N2288	VB [BT]	S
GOLF VII (5G1, BE1)							
1.2 TSI	08/12-	CJZA, CJZB, CYVA, CYVB	1197		0-N2313	TB [TE]	
1.2 TSI	08/12-	CJZA, CJZB, CYVA, CYVB	1197		0-N2381	TB [DG]	
1.4 GTE Hybrid, 1.4 TGI, 1.4 TSI, 1.4 TSI E85-100, 1.4 TSI MultiFuel	11/12-	CHPA, CPTA, CHPB, CZDA, CZEA, CMBA, CPVA, CPVA, CXSA, CPVA, CPVB, CPVB, CZCA, CPWA, CZBA, CUKB	1395		0-N2313	TB [TE]	
1.4 GTE Hybrid, 1.4 TGI, 1.4 TSI, 1.4 TSI E85-100, 1.4 TSI MultiFuel	11/12-	CHPA, CPTA, CHPB, CZDA, CZEA, CMBA, CPVA, CPVA, CXSA, CPVA, CPVB, CPVB, CZCA, CPWA, CZBA, CUKB	1395		0-N2381	TB [DG]	
1.6	05/14-	CWVA	1598		0-N2313	TB [TE]	
1.6	05/14-	CWVA	1598		0-N2381	TB [DG]	
1.6 TDI, 1.6 TDI 4motion	08/12-	CLHA, CLHB, CRKA, CXXA, CRKB, CXXB	1598		0-N131	TB [DG]	
1.6 TDI, 1.6 TDI 4motion	08/12-	CLHA, CLHB, CRKA, CXXA, CRKB, CXXB	1598		0-N2314	TB [TE]	
2.0 GTD, 2.0 TDI, 2.0 TDI 4motion	08/12-	CKFC, CRBC, CRLB, CRMB, CKFC, CRBC, CRLB, CRMB, CRUA, CRBB, CRVC, CRVA, CYKB, CUNA	1968		0-N131	TB [DG]	
2.0 GTD, 2.0 TDI, 2.0 TDI 4motion	08/12-	CKFC, CRBC, CRLB, CRMB, CKFC, CRBC, CRLB, CRMB, CRUA, CRBB, CRVC, CRVA, CYKB, CUNA	1968		0-N2314	TB [TE]	
1.6 TDI	01/13-	CRKB	1598	☼	0-N2288	VB [BT]	S
1.6 TDI	04/13-	CLHB	1598	☼	0-N2288	VB [BT]	S
1.6 TDI, 1.6 TDI 4motion	08/12-	CLHA, CRKB, CXXB	1598	☼	0-N2288	VB [BT]	S
2.0 GTD, 2.0 TDI, 2.0 TDI 4motion	11/12-	CKFC, CRBC, CRLB, CRMB, CKFC, CRBC, CRLB, CRMB, CRUA, CRVA, CYKB, CUNA	1968	☼	0-N2288	VB [BT]	S
GOLF VII Kombi (BA5)							
1.2 TSI	05/13-	CJZA, CJZB, CYVA, CYVB	1197		0-N2313	TB [TE]	
1.2 TSI	05/13-	CJZA, CJZB, CYVA, CYVB	1197		0-N2381	TB [DG]	
1.4 TGI, 1.4 TSI, 1.4 TSI MultiFuel	04/13-	CHPA, CHPB, CZDA, CPVA, CPVA, CXSA, CPVB, CPVB, CZCA, CPWA	1395		0-N2313	TB [TE]	
1.4 TGI, 1.4 TSI, 1.4 TSI MultiFuel	04/13-	CHPA, CHPB, CZDA, CPVA, CPVA, CXSA, CPVB, CPVB, CZCA, CPWA	1395		0-N2381	TB [DG]	
1.6	05/14-	CWVA	1598		0-N2313	TB [TE]	
1.6	05/14-	CWVA	1598		0-N2381	TB [DG]	
1.6 TDI, 1.6 TDI 4motion	05/13-	CLHA, CLHB, CRKA, CXXA, CRKB, CXXB	1598		0-N131	TB [DG]	
1.6 TDI, 1.6 TDI 4motion	05/13-	CLHA, CLHB, CRKA, CXXA, CRKB, CXXB	1598		0-N2314	TB [TE]	
2.0 TDI, 2.0 TDI 4motion	04/13-	CRBC, CRLB, CRLB, CRMB, CRBC, CRLB, CRMB, CRUA, CRLD, CRVA, CYKB	1968		0-N131	TB [DG]	
2.0 TDI, 2.0 TDI 4motion	04/13-	CRBC, CRLB, CRLB, CRMB, CRBC, CRLB, CRMB, CRUA, CRLD, CRVA, CYKB	1968		0-N2314	TB [TE]	
1.6 TDI	05/13-	CLHB	1598	☼	0-N2288	VB [BT]	S
1.6 TDI	05/13-	CRKB	1598	☼	0-N2288	VB [BT]	S
1.6 TDI 4motion	05/13-	CRKB, CXXB	1598	Baumuster: Golf Alltrack	0-N2288	VB [BT]	S



CM³



Art. Nr.



GOLF VII Kombi (BA5)							
1.6 TDI 4motion	05/13-	CRKB, CXXB	1598	Baumuster: Golf Estate, Golf Variant; ☼	0-N2288	VB [BT]	S
1.6 TDI, 1.6 TDI 4motion	05/13-	CLHA	1598	☼	0-N2288	VB [BT]	S
2.0 TDI	04/13-	CRBC, CRLB, CRMB, CRUA, CRLD, CRVA, CYKB	1968	☼	0-N2288	VB [BT]	S
2.0 TDI 4motion	04/13-	CRBC, CRLB, CRLB, CRMB	1968	Baumuster: Golf Alltrack	0-N2288	VB [BT]	S
2.0 TDI 4motion	04/13-	CRBC, CRLB, CRLB, CRMB	1968	Baumuster: Golf Estate, Golf Variant; ☼	0-N2288	VB [BT]	S
ILTIS (183)							
1.6 TD	08/87-12/88	1C	1588	25x135; mit Zubehör	SK-1001	BTK	
1.7	03/79-12/88	WL, YX	1714	18x121; mit Zubehör	SK-1026	BTK	
1.6 TD	08/87-12/88	1C	1588		0-N806	TB [TE]	
1.7	03/79-12/88	WL, YX	1714		0-N805	TB [TE]	
JETTA I (16)							
1.5	08/78-02/84	JB	1457	18x121; mit Zubehör	SK-1026	BTK	
1.5 D	08/78-07/80	CK	1471	25x135; 08/1979 →; mit Zubehör	SK-1001	BTK	
1.6	08/78-02/84	FR	1588	18x121; 08/1980 →; mit Zubehör	SK-1026	BTK	
1.6	08/82-07/83	EW	1595	18x121; mit Zubehör	SK-1026	BTK	
1.6 D, 1.6 TD	08/80-02/84	CR, JK, CY	1588	25x135; mit Zubehör	SK-1001	BTK	
1.6, 1.6 GLI	08/78-07/83	EG, EM	1588	18x121; mit Zubehör	SK-1026	BTK	
1.8	08/82-02/84	DX, JJ, JJ	1781	18x121; mit Zubehör	SK-1026	BTK	
1.5	08/78-02/84	JB	1457		0-N805	TB [TE]	
1.5 D	08/78-07/80	CK	1471		0-N806	TB [TE]	
1.6 D, 1.6 TD	08/80-02/84	CR, JK, CY	1588		0-N806	TB [TE]	
1.6, 1.6 GLI	08/78-02/84	EG, EM, FR	1588		0-N805	TB [TE]	
1.8	08/82-02/84	DX, JJ, JJ	1781		0-N805	TB [TE]	
JETTA II (19E, 1G2, 165)							
1.3 KAT	06/87-12/91	2G	1272	19x128; 10/1990 →; :262740→	R-1190AQ1	BTKW	
1.6	01/84-07/92	ABN, EZ, HM, HM, PN, RF	1595	18x121; mit Zubehör	SK-1026	BTK	
1.6 D, 1.6 TD	01/84-10/91	JP, ME, JR, MF, RA, SB	1588	25x135; mit Zubehör	SK-1001	BTK	
1.6 TD	01/90-10/91	1V	1589	25x135; mit Zubehör	SK-1001	BTK	
1.8 16V	08/86-10/91	KR, PL	1781	25x147	SK-1047	BTK	
1.8, 1.8 KAT, 1.8 Syncro	01/84-10/91	1P, EV, GZ, GZ, PB, GU, GX, HV, HV, GU, RP, GX, RP, PF, RD, RH	1781	18x121; mit Zubehör	SK-1026	BTK	
1.6	01/84-07/92	EZ	1595		0-N805	TB [TE]	
1.6	03/86-10/91	PN, RF	1595		0-N805	TB [TE]	
1.6 D, 1.6 TD	01/84-10/91	JP, ME, JR, MF, RA, SB	1588		0-N806	TB [TE]	
1.6 TD	01/90-10/91	1V	1589		0-N806	TB [TE]	
1.8 16V	08/86-10/91	KR, PL	1781		0-N808	TB [TE]	
1.8, 1.8 KAT, 1.8 Syncro	01/84-10/91	1P, EV, GZ, GZ, PB, GU, GX, HV, HV, GU, RP, GX, RP, PF, RD, RH	1781		0-N805	TB [TE]	
JETTA III (1K2)							
1.6	10/05-10/10	BSE, BSF, CCSA	1595	23x138; Baumuster: 1K2	SK-1109	BTK	
1.6	10/05-10/10	BSE	1595	23x138	SK-1109AQ1	BTKW	
1.6 MultiFuel	01/08-10/10	CCSA	1595	23x138; Baumuster: 1K2	SK-1109	BTK	
1.6 MultiFuel	01/08-10/10	CCSA	1595	23x138	SK-1109AQ1	BTKW	
1.6 TDI	06/09-10/10	CAYB, CAYC	1598	25x160	SK-1695	BTK	
1.6 TDI	06/09-10/10	CAYB, CAYC	1598	25x160	SK-1695AQ1	BTKW	
1.6 TDI	06/09-10/10	CAYC	1598	25x160; →2010	SK-1727AQ1	BTKW	
1.6 TDI	06/09-10/10	CAYC	1598	25x160; 2011→	SK-1727AQ2	BTKW	
1.6 TDI	12/09-10/10	CAYC	1598	25x160	SK-1727AQ2	BTKW	
1.9 TDI	08/05-10/10	BKC, BLS, BXE	1896	30x120; mit Zubehör	SK-1372	BTK	
1.9 TDI	08/05-10/10	BKC, BLS, BXE	1896	30x120	SK-1372AQ1	BTKW	
2.0 FSI	08/05-10/10	BLR, BLX, BLY, BVY, BVZ	1984	23x148	SK-1724	BTK	
2.0 FSI	08/05-10/10	BLR, BLX, BLY, BVY, BVZ	1984	23x148	SK-1724AQ2	BTKW	
2.0 TDI	09/05-10/10	AZV	1968	30x141; ch.→1K-6-899000; mit Zubehör	SK-1595	BTK	
2.0 TDI	09/05-10/10	AZV	1968	30x141; ch.→1K6899000; mit Zubehör	SK-1595AQ1	BTKW	
2.0 TDI	09/05-10/10	AZV	1968	30x141; ch.1K-7-000001→; mit Zubehör	SK-1668	BTK	
2.0 TDI	09/05-10/10	AZV	1968	30x141; ch.1K-7-000001→	SK-1668AQ1	BTKW	
2.0 TDI	09/05-10/10	CBDA	1968	30x160	SK-1694	BTK	
2.0 TDI	09/05-10/10	CBDA, CBDB, CJAA	1968	30x160	SK-1694AQ1	BTKW	
2.0 TDI	10/05-10/10	BMM	1968	30x120; mit Zubehör	SK-1372	BTK	
2.0 TDI	10/05-10/10	BMM	1968	30x120	SK-1372AQ2	BTKW	
2.0 TDI	10/06-10/10	BMN	1968	30x141; mit Zubehör	SK-1668	BTK	
2.0 TDI	10/06-10/10	BMN	1968	30x141	SK-1668AQ1	BTKW	
2.0 TDI	10/06-10/10	CEGA	1968	30x160	SK-1694	BTK	



OPTIMAL®

VW



CM³



Art. Nr.



ohne Halter

JETTA III (1K2)

2.0 TDI 16V	08/05-10/10	BKD	1968	30x141; ch.→1K-6-899000; mit Zubehör	SK-1595	BTK	
2.0 TDI 16V	08/05-10/10	BKD	1968	30x141; ch.→1K6899000; mit Zubehör	SK-1595AQ1	BTKW	
2.0 TDI 16V	08/05-10/10	BKD	1968	30x141; ch.1K-7-000001→; mit Zubehör	SK-1668	BTK	
2.0 TDI 16V	08/05-10/10	BKD	1968	30x141; ch.1K-7-000001→	SK-1668AQ1	BTKW	
2.0 TDI 16V	08/05-10/10	CBDB	1968	30x160	SK-1694	BTK	
2.0 TDI 16V	08/05-10/10	CBDB, CJAA	1968	30x160	SK-1694AQ1	BTKW	
2.0 TFSI	10/05-10/10	BWA	1984	23x148	SK-1724	BTK	
2.0 TFSI	10/05-10/10	BWA	1984	23x148	SK-1724AQ1	BTKW	
1.6 TDI	06/09-10/10	CAYB, CAYC	1598		0-N131	TB [DG]	
1.6 TDI	06/09-10/10	CAYB, CAYC	1598		0-N2025	TB [DG]	
1.6 TDI	06/09-10/10	CAYB, CAYC	1598		0-N2200	TB [DG]	
1.6, 1.6 MultiFuel	10/05-10/10	BGU, BSE, BSF, CCSA, CCSA	1595		0-N157	TB [TE]	
1.9 TDI	08/05-10/10	BKC, BLS, BXE	1896		0-N1045	TB [TE]	
1.9 TDI	08/05-10/10	BKC, BLS, BXE	1896		0-N1046	TB [DG]	
2.0 FSI	08/05-10/10	BLR, BLX, BLY, BVY, BVZ	1984		0-N1316	TB [DG]	
2.0 FSI	08/05-10/10	BLR, BLX, BLY, BVY, BVZ	1984		0-N1346	TB [DG]	
2.0 FSI	08/05-10/10	BLR, BLX, BLY, BVY, BVZ	1984		0-N2208	TB [TE]	
2.0 TDI	09/05-10/10	AZV, CBDA	1968		0-N1046	TB [DG]	
2.0 TDI	09/05-10/10	CBDA	1968		0-N1268	TB [DG]	
2.0 TDI	09/05-10/10	AZV	1968		0-N1335	TB [TE]	
2.0 TDI	09/05-10/10	CBDA	1968		0-N1336	TB [DG]	
2.0 TDI	09/05-10/10	AZV	1968	ch.→1K-6-899000	0-N1336	TB [DG]	
2.0 TDI	09/05-10/10	AZV	1968	ch.1K-7-000001→	0-N1575	TB [DG]	
2.0 TDI	09/05-10/10	CBDA	1968		0-N1905	TB [BT]	
2.0 TDI	10/05-10/10	BMM	1968		0-N1045	TB [TE]	
2.0 TDI	10/05-10/10	BMM	1968		0-N1046	TB [DG]	
2.0 TDI	10/06-10/10	CEGA	1968		0-N1046	TB [DG]	
2.0 TDI	10/06-10/10	CEGA	1968		0-N1268	TB [DG]	
2.0 TDI	10/06-10/10	BMN, CEGA	1968		0-N1335	TB [TE]	
2.0 TDI	10/06-10/10	CEGA	1968		0-N1336	TB [DG]	
2.0 TDI	10/06-10/10	BMN	1968		0-N1575	TB [DG]	
2.0 TDI	10/06-10/10	CEGA	1968		0-N1905	TB [BT]	
2.0 TDI 16V	08/05-10/10	BKD, CBDB, CJAA	1968		0-N1046	TB [DG]	
2.0 TDI 16V	08/05-10/10	CBDB, CJAA	1968		0-N1268	TB [DG]	
2.0 TDI 16V	08/05-10/10	BKD	1968		0-N1335	TB [TE]	
2.0 TDI 16V	08/05-10/10	CBDB, CJAA	1968		0-N1336	TB [DG]	
2.0 TDI 16V	08/05-10/10	BKD	1968	ch.→1K-6-899000	0-N1336	TB [DG]	
2.0 TDI 16V	08/05-10/10	BKD	1968	ch.1K-7-000001→	0-N1575	TB [DG]	
2.0 TDI 16V	08/05-10/10	CBDB, CJAA	1968		0-N1905	TB [BT]	
2.0 TDI 16V	08/05-10/10	CJAA	1968		0-N2025	TB [DG]	
2.0 TFSI	10/05-10/10	BPY, BWA	1984		0-N1316	TB [DG]	
2.0 TFSI	10/05-10/10	BPY, BWA	1984		0-N1346	TB [DG]	
2.0 TFSI	10/05-10/10	AXX, BWA, BPY	1984		0-N2208	TB [TE]	
1.4 TSI	07/06-10/10	BLG, CAVD	1390		0-N2050	VB [DG]	
1.4 TSI	07/06-10/10	BMV	1390	☞	0-N2050	VB [DG]	
1.4 TSI	07/06-10/10	BLG, BMV, CAVD	1390	☞	0-N2091	VB [BT]	S
1.4 TSI	07/06-10/10	BLG, BMV, CAVD	1390	☞	0-N2092	VB [BT]	S
1.4 TSI	07/06-10/10	BLG, BMV, CAVD	1390	☞	0-N2111	VB [BT]	S
1.4 TSI	05/07-10/10	CAXA	1390	☞; ☞	0-N1454	VB [DG]	
1.4 TSI	05/07-10/10	CAXA	1390	☞	0-N1525	VB [BT]	S
1.4 TSI	05/07-10/10	CAXA	1390	☞	0-N1733	VB [BT]	S
1.6 FSI	09/05-10/10	BLF	1598	☞; ☞	0-N1454	VB [DG]	
1.6 FSI	09/05-10/10	BLF	1598	☞	0-N1525	VB [BT]	S
1.6 FSI	09/05-10/10	BLF	1598	☞	0-N1733	VB [BT]	S
1.6 TDI	06/09-10/10	CAYB, CAYC	1598		0-N1534	VB [BT]	S
1.9 TDI	08/05-10/10	BKC, BLS, BXE	1896		0-N1531	VB [BT]	S
2.0 TDI	09/05-10/10	AZV	1968		0-N1530	VB [BT]	S
2.0 TDI	10/05-10/10	BMM	1968		0-N1531	VB [BT]	S
2.0 TDI	10/06-10/10	BMN	1968		0-N1530	VB [BT]	S
2.0 TDI	10/06-10/10	BMN, CEGA	1968		0-N1534	VB [BT]	S
2.0 TDI 16V	08/05-10/10	BKD	1968		0-N1530	VB [BT]	S
2.0 TDI, 2.0 TDI 16V	08/05-10/10	CBAB, CFFB	1968		0-N1534	VB [BT]	S
2.0 TFSI	10/05-10/10	BPY, BWA	1984		0-N1656	VB [BT]	S
2.0 TFSI	10/05-10/10	CAWB, CBFA, CCTA, CCZA	1984		0-N1832	VB [BT]	S
2.0 TFSI	03/08-10/10	CAWA	1984		0-N1832	VB [BT]	S

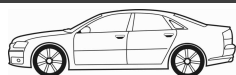

CM³



Art. Nr.



ohne Halter

JETTA III (1K2)							
2.5 FSI	01/06-10/10	BGP, BTK	2480			0-N1892	VB [BT] S
2.5 FSI	01/06-10/10	BGP, BTK, CBTA, CBUA, CCCA, CCCA	2480			0-N1893	VB [BT] S

JETTA IV (162, 163)							
1.6 TDI	02/11-	CAYC	1598	25x160		SK-1695	BTK
1.6 TDI	02/11-	CAYC	1598	25x160		SK-1727AQ2	BTKW
2.0	06/10-	CBPA, CKJA	1984	23x138		SK-1109	BTK
2.0	06/10-	CBPA, CKJA	1984	23x138		SK-1109AQ2	BTKW
2.0 TDI	10/10-	CFFB, CFHC, CJAA, CLCB, CLCA	1968	25x160		SK-1695	BTK
2.0 TDI	10/10-	CLCA	1968	25x160		SK-1695AQ1	BTKW
2.0 TDI	10/10-	CLCA	1968	25x160		SK-1727AQ2	BTKW
2.0 TDI	02/11-	CJAA	1968	30x160		SK-1694	BTK
2.0 TDI	02/11-	CJAA	1968	30x160; → 04/2012		SK-1694AQ1	BTKW
2.0 TDI	02/11-	CJAA	1968	30x160; 05/2012 →		SK-1694AQ2	BTKW
2.0 TDI	02/11-	CLCB	1968	25x160		SK-1695AQ1	BTKW
2.0 TDI	02/11-	CFFB, CFHC, CLCA, CLCB	1968	25x160		SK-1727AQ2	BTKW
1.4 TSI Hybrid	04/11-	CNLA, CRJA	1395			0-N2381	TB [DG]
1.4 TSI, 1.4 TSI Hybrid	04/11-	CNLA, CRJA, CZCA, CZDA, CZTA	1395			0-N2313	TB [TE]
1.6	03/13-	CFNB	1598			0-N2313	TB [TE]
1.6 TDI	02/11-	CAYC	1598			0-N131	TB [DG]
1.6 TDI	02/11-	CAYC	1598			0-N2025	TB [DG]
1.6 TDI	02/11-	CAYC	1598			0-N2200	TB [DG]
2.0	06/10-	CBPA, CKJA	1984			0-N157	TB [TE]
2.0 TDI	10/10-	CLCA, CUUB	1968			0-N131	TB [DG]
2.0 TDI	10/10-	CLCA	1968			0-N2025	TB [DG]
2.0 TDI	10/10-	CLCA	1968			0-N2200	TB [DG]
2.0 TDI	02/11-	CJAA	1968			0-N1046	TB [DG]
2.0 TDI	02/11-	CJAA	1968			0-N1268	TB [DG]
2.0 TDI	02/11-	CFFB, CFHC, CLCB	1968			0-N131	TB [DG]
2.0 TDI	02/11-	CJAA	1968			0-N1336	TB [DG]
2.0 TDI	02/11-	CJAA	1968			0-N1905	TB [BT]
2.0 TDI	02/11-	CFFB, CFHC, CLCB	1968			0-N2025	TB [DG]
2.0 TDI	02/11-	CFFB, CFHC, CLCB	1968			0-N2200	TB [DG]
2.0 TDI	08/14-	CUUB	1968			0-N2314	TB [TE]
1.2 TSI	02/11-	CBZB	1197	✳		0-N1733	VB [BT] S
1.2 TSI	02/11-	CBZB	1197	✳		0-N2121	VB [DG]
1.4 TSI	04/11-	CAVD, CTHD	1390			0-N2050	VB [DG]
1.4 TSI	04/11-07/14	CAVA, CTHA, CAVD, CTHD	1390	✳		0-N2091	VB [BT] S
1.4 TSI	04/11-07/14	CAVA, CTHA, CAVD, CTHD	1390			0-N2092	VB [BT] S
1.4 TSI	04/11-07/14	CAVA, CTHA, CAVD, CTHD	1390	✳		0-N2111	VB [BT] S
1.4 TSI	05/11-	CAXA, CMSB	1390	✳		0-N1525	VB [BT] S
1.4 TSI	05/11-	CAXA, CMSB	1390	✳		0-N1733	VB [BT] S
1.6	12/11-	CFNA, CLRA, CFNB	1598	✳		0-N1733	VB [BT] S
1.6, 1.6 TDI	02/11-	CAYC, CFNA, CLRA	1598			0-N1534	VB [BT] S
2.0	06/10-	CBPA, CKJA	1984			0-N1656	VB [BT] S
2.0 TDI	10/10-	CFFB, CFHC, CJAA, CLCB, CLCA	1968			0-N1534	VB [BT] S
2.0 TDI	10/10-	CLCA	1968			0-N2288	VB [BT] S
2.0 TDI	08/14-	CUUB	1968	✳		0-N2288	VB [BT] S
2.0 TSI	12/10-	CBFA, CCTA, CCZA	1984			0-N1832	VB [BT] S
2.5 FSI	04/10-	CBTA, CBUA, CCCA	2480			0-N1893	VB [BT] S

NEW BEETLE (9C1, 1C1)							
1.4	11/01-09/10	BCA	1390	20x130; 17x58; beinhaltetete Rollen: 4		SK-1511	BTK
1.4	11/01-09/10	BCA	1390	20x130; 17x58; beinhaltetete Rollen: 4		SK-1511AQ1	BTKW
1.6	10/99-09/00	AWH	1595	23x138; Baumuster: 9C1, 1C1		SK-1109	BTK
1.6	10/99-09/10	AWH, AYD, BFS	1595	23x138		SK-1109AQ1	BTKW
1.6	06/00-09/10	AYD, BFS	1595	23x138; Baumuster: 9C1, 1C1		SK-1109	BTK
1.8 T	10/99-09/10	AGU	1781	23x150; ch.→1J-Y-850000; mit Spanndämpfer, Spannrolle		SK-1337	BTK
1.8 T	10/99-09/10	APH	1781	23x150; ⁽¹⁷⁸¹⁾ →APH028500; mit Spanndämpfer, Spannrolle		SK-1337	BTK
1.8 T	10/99-09/10	AVC	1781	23x150; ⁽¹⁷⁸¹⁾ →AVC003000; mit Spanndämpfer, Spannrolle		SK-1337	BTK
1.8 T	10/99-09/10	AGU	1781	23x150; ch.→1J-Y-850000; mit Spanndämpfer, Spannrolle		SK-1337AQ1	BTKW
1.8 T	10/99-09/10	APH	1781	23x150; ⁽¹⁷⁸¹⁾ →APH028500; mit Spanndämpfer, Spannrolle		SK-1337AQ1	BTKW

CM³

Art. Nr.



NEW BEETLE (9C1, 1C1)

1.8 T	10/99-09/10	AVC	1781	23x150; :→AVC003000; mit Spanndämpfer, Spannrolle	SK-1337AQ1	BTKW	
1.8 T	10/99-09/10	AWU, AWW, BKF	1781	23x150	SK-1660	BTK	
1.8 T	10/99-09/10	AGU	1781	23x150; ch.1J-Y-850001→	SK-1660	BTK	
1.8 T	10/99-09/10	APH	1781	23x150; :APH028501→	SK-1660	BTK	
1.8 T	10/99-09/10	AVC	1781	23x150; :AVC003001→	SK-1660	BTK	
1.8 T	10/99-09/10	AWU, AWW	1781	23x150	SK-1660AQ1	BTKW	
1.8 T	10/99-09/10	AGU	1781	23x150; ch.1J-Y-850001→	SK-1660AQ1	BTKW	
1.8 T	10/99-09/10	APH	1781	23x150; :APH028501→	SK-1660AQ1	BTKW	
1.8 T	10/99-09/10	AVC	1781	23x150; :AVC003001→	SK-1660AQ1	BTKW	
1.8 T	10/99-09/10	AGU	1781	23x150; ch.→1J-Y-850000	SK-1709	BTK	
1.8 T	10/99-09/10	APH	1781	23x150; :→APH028500	SK-1709	BTK	
1.8 T	10/99-09/10	AVC	1781	23x150; :→AVC003000	SK-1709	BTK	
1.8 T	10/99-09/10	AWU, AWW, BKF	1781	23x150	SK-1710	BTK	
1.8 T	10/99-09/10	AGU	1781	23x150; ch.1J-Y-850001→	SK-1710	BTK	
1.8 T	10/99-09/10	APH	1781	23x150; :APH028501→	SK-1710	BTK	
1.8 T	10/99-09/10	AVC	1781	23x150; :AVC003001→	SK-1710	BTK	
1.8 T	11/01-06/05	AWP, BNU	1781	23x150	SK-1660	BTK	
1.8 T	11/01-06/05	AWP, BNU	1781	23x150	SK-1660AQ1	BTKW	
1.8 T	11/01-06/05	AWP, BNU	1781	23x150	SK-1710	BTK	
1.9 TDI	01/98-06/04	ALH	1896	25x141; :→ALH500000; mit Zubehör;	SK-1111	BTK	
1.9 TDI	01/98-06/04	ALH	1896	25x141; :→ALH500000; mit Zubehör	SK-1111AQ1	BTKW	
1.9 TDI	01/98-06/04	ALH	1896	25x141; :ALH500001→; mit Zubehör	SK-1258	BTK	
1.9 TDI	01/98-06/04	ALH	1896	25x141; :ALH500001→; mit Zubehör	SK-1258AQ1	BTKW	
1.9 TDI	02/01-09/10	ATD, BEW	1896	30x120; ch.9C-2-613921→; mit Zubehör	SK-1372	BTK	
1.9 TDI	02/01-09/10	ATD, BEW	1896	30x120; ch.9C-2-613921→	SK-1372AQ2	BTKW	
1.9 TDI	02/01-09/10	ATD, BEW	1896	30x120; ch.→9C-2-613920; 07/2001 →; mit Zubehör; Baumuster: 9C1, 1C1	SK-1582	BTK	
1.9 TDI	02/01-09/10	ATD, BEW	1896	30x120; ch.→9C-2-613920; ohne Spanndämpfer, Spannrolle; mit Zubehör	SK-1582AQ1	BTKW	
1.9 TDI	02/01-09/10	ATD, BEW	1896	30x120; ch.→9C-2-613920; 07/2001 →; mit Spanndämpfer, Spannrolle; mit Zubehör; Baumuster: 9C1, 1C1	SK-1583	BTK	
1.9 TDI	02/01-09/10	ATD, BEW	1896	30x120; ch.→9C-2-613920; mit Spanndämpfer, Spannrolle; mit Zubehör	SK-1583AQ1	BTKW	
1.9 TDI	07/05-09/10	BSW	1896	30x120; mit Zubehör	SK-1372	BTK	
1.9 TDI	07/05-09/10	BSW	1896	30x120	SK-1372AQ2	BTKW	
2.0	01/98-09/10	AEG, APK, AQY, AZG	1984	23x138; Baumuster: 9C1, 1C1	SK-1109	BTK	
2.0	01/98-09/10	AEG, APK, AQY, AVH, AZG, AZJ, BEJ, BER, BEV, BHP, CBPA	1984	23x138	SK-1109AQ2	BTKW	
1.4	11/01-09/10	BCA	1390		0-N1262	TB [DG]	
1.4	11/01-09/10	BCA	1390		0-N1263	TB [TE]	
1.4	11/01-09/10	BCA	1390		0-N158	TB [TE]	
1.4	11/01-09/10	BCA	1390		0-N164	TB [DG]	
1.6	10/99-09/10	AWH, AYD, BFS	1595		0-N157	TB [TE]	
1.8 T	10/99-09/10	AWU, AWW, BKF	1781		0-N1042	TB [TE]	
1.8 T	10/99-09/10	AGU, APH, AVC, AWU, AWW, BKF	1781	:APH028501→	0-N1042	TB [TE]	
1.8 T	10/99-09/10	AGU, APH, AVC, AWU, AWW, BKF, AWP, BNU	1781		0-N1237	TB [BT]	
1.8 T	10/99-09/10	AGU, APH, AVC, AWU, AWW, BKF, AWP, BNU	1781		0-N1316	TB [DG]	
1.8 T	10/99-09/10	AGU, APH, AVC, AWU, AWW, BKF	1781	:→APH028500	0-N1654	TB [TE]	
1.8 T	11/01-06/05	AWP, BNU	1781		0-N1042	TB [TE]	
1.9 TDI	01/98-06/04	ALH	1896		0-N107	TB [TE]	
1.9 TDI	01/98-06/04	ALH	1896		0-N131	TB [DG]	
1.9 TDI	01/98-06/04	ALH	1896		0-N166	TB [DG]	
1.9 TDI	01/98-06/04	ALH	1896		0-N167	TB [DG]	
1.9 TDI	02/01-09/10	ATD, BEW	1896	ch.9C-2-613921→	0-N1045	TB [TE]	
1.9 TDI	02/01-09/10	ATD, BEW	1896	ch.9C-2-613921→	0-N1046	TB [DG]	
1.9 TDI	02/01-09/10	ATD, BEW	1896	ch.→9C-2-613920	0-N1048	TB [TE]	
1.9 TDI	02/01-09/10	ATD, BEW	1896	ch.→9C-2-613920	0-N1268	TB [DG]	
1.9 TDI	02/01-09/10	ATD, BEW	1896	ch.→9C-2-613920	0-N1274	TB [BT]	
1.9 TDI	07/05-09/10	BSW	1896		0-N1045	TB [TE]	
1.9 TDI	07/05-09/10	BSW	1896		0-N1046	TB [DG]	
2.0	01/98-09/10	AEG, APK, AQY, AVH, AZG, AZJ, BEJ, BER, BEV, BHP, CBPA	1984		0-N157	TB [TE]	
1.4	11/01-09/10	BCA	1390		0-N1445	VB [BT]	S
1.4	11/01-09/10	BCA	1390		0-N1539	VB [BT]	S



CM³



Art. Nr.



ohne Halter

NEW BEETLE (9C1, 1C1)

1.6	10/99-09/00	AWH	1595		0-N1041	VB [BT]	S
1.8 T	10/99-09/10	APH, AVC	1781		0-N1041	VB [BT]	S
1.9 TDI	01/98-06/04	ALH	1896		0-N1538	VB [BT]	S
1.9 TDI	01/98-06/04	ALH	1896		0-N174	VB [DG]	
1.9 TDI	02/01-09/10	ATD, BEW, BSW	1896		0-N1494	VB [BT]	S
2.0	01/98-09/10	AEG, AQY	1984		0-N1041	VB [BT]	S
2.3 V5	10/00-09/10	AQN	2324	Rippenanzahl: 6	0-N1496S	VB [TE]	
2.5	07/05-09/10	BPR, BPS	2480	→ 09/2010	0-N1893	VB [BT]	S
RSI 3.2 4motion	04/00-05/01	AXJ	3188	Rippenanzahl: 6	0-N1496S	VB [TE]	

LT 28-35 I Bus (281-363)

2.0	04/75-09/83	CH	1984	18x121; mit Zubehör; Baumuster: LT 28	SK-1026	BTK	
2.4 D	08/89-06/96	1S, ACT	2383	20x75; 25.4x119; 08/1991 →	SK-1129	BTK	
2.4 D	08/89-06/96	1S	2383	25x119	SK-1129AQ1	BTKW	
2.4 D, 2.4 TD	01/79-08/92	1G, CP, DW, DV	2383	20x75; 25.4x119	SK-1129	BTK	
2.4 D, 2.4 TD	01/79-08/92	1G, CP, DW, DV	2383	25x119	SK-1129AQ1	BTKW	
2.4 TD	09/92-06/96	ACL	2383	25.4x120; 20x75	SK-1527	BTK	
2.0	04/75-09/83	CH	1984		0-N805	TB [TE]	
2.4 D	08/89-06/96	ACT	2383		0-N1232	TB [TE]	
2.4 D	08/89-06/96	ACT	2383		0-N163	TB [DG]	
2.4 D	08/89-06/96	1S	2383		0-N807	TB [DG]	
2.4 D, 2.4 TD	01/79-08/92	1G, CP, DW, DV	2383		0-N807	TB [DG]	
2.4 TD	09/92-06/96	ACL	2383		0-N1232	TB [TE]	
2.4 TD	09/92-06/96	ACL	2383		0-N163	TB [DG]	
2.4, 2.4 i	12/82-06/96	1E, DL	2383	ch.28-F-000001→	0-N807	TB [DG]	

LT 28-35 I Kasten (281-363)

2.0	04/75-09/83	CH	1984	18x121; mit Zubehör; Baumuster: LT 28, LT 31	SK-1026	BTK	
2.4 D	07/90-05/96	1S	2383	25x119	SK-1129AQ1	BTKW	
2.4 D, 2.4 TD	01/79-05/96	1G, 1S, ACT, CP, DW, DV	2383	20x75; 25.4x119	SK-1129	BTK	
2.4 D, 2.4 TD	01/79-08/92	1G, CP, DW, DV	2383	25x119	SK-1129AQ1	BTKW	
2.4 TD, 2.4 TD Syncro	06/92-05/96	ACL	2383	25.4x120; 20x75	SK-1527	BTK	
2.0	04/75-09/83	CH	1984		0-N805	TB [TE]	
2.4 D	07/90-05/96	ACT	2383		0-N1232	TB [TE]	
2.4 D	07/90-05/96	ACT	2383		0-N163	TB [DG]	
2.4 D	07/90-05/96	1S	2383		0-N807	TB [DG]	
2.4 D, 2.4 TD	01/79-08/92	1G, CP, DW, DV	2383		0-N807	TB [DG]	
2.4 TD	06/92-05/96	ACL	2383		0-N1232	TB [TE]	
2.4 TD	06/92-05/96	ACL	2383		0-N163	TB [DG]	
2.4, 2.4 i	12/82-06/96	1E, DL	2383	ch.28-F-000001→	0-N807	TB [DG]	

LT 28-35 I Pritsche/Fahrgestell (281-363)

2.0	04/75-09/83	CH	1984	18x121; mit Zubehör; Baumuster: LT 28, LT 31	SK-1026	BTK	
2.4 D	08/90-06/96	1S	2383	25x119	SK-1129AQ1	BTKW	
2.4 D	08/90-06/96	ACT	2383	25.4x120; 20x75	SK-1527	BTK	
2.4 D	08/90-06/96	1S, ACT	2383	25.4x120; 20x75; 08/1992 →	SK-1527	BTK	
2.4 D, 2.4 D Syncro, 2.4 TD, 2.4 TD Syncro	12/78-09/93	1G, 1S, CP, DW, DV, DW	2383	20x75; 25.4x119	SK-1129	BTK	
2.4 D, 2.4 D Syncro, 2.4 TD, 2.4 TD Syncro	12/78-09/93	1G, 1S, CP, DW, DV, DW	2383	25x119	SK-1129AQ1	BTKW	
2.4 TD	08/90-08/92	1G	2383	20x75; 25.4x119; 08/1991 →	SK-1129	BTK	
2.4 TD, 2.4 TD Syncro	08/92-06/96	ACL	2383	25.4x120; 20x75	SK-1527	BTK	
2.0	04/75-09/83	CH	1984		0-N805	TB [TE]	
2.4 D	08/90-06/96	ACT	2383		0-N1232	TB [TE]	
2.4 D	08/90-06/96	ACT	2383		0-N163	TB [DG]	
2.4 D	08/90-06/96	1S	2383		0-N807	TB [DG]	
2.4 D, 2.4 D Syncro, 2.4 TD	12/78-09/93	1G, 1S, CP, DW, DV, DW	2383		0-N807	TB [DG]	
2.4 TD	08/92-06/96	ACL	2383		0-N1232	TB [TE]	
2.4 TD	08/92-06/96	ACL	2383		0-N163	TB [DG]	
2.4, 2.4 i	12/82-06/96	1E, DL	2383	ch.28-F-000001→	0-N807	TB [DG]	

LT 28-35 II Bus (2DB, 2DE, 2DK)

2.5 SDI	07/96-07/06	AGX	2461	26.5x122; 21x81; mit Zubehör; Baumuster: LT 28, LT 35	SK-1529	BTK	
2.5 SDI	07/96-07/06	AGX	2461	26.5x122; mit Zubehör	SK-1529AQ1	BTKW	
2.5 SDI	07/96-07/06	AGX	2461	26.5x122; mit Zubehör	SK-1725	BTK	
2.5 SDI	07/96-07/06	AGX	2461	26.5x122; mit Zubehör	SK-1725AQ1	BTKW	



CM³



Art. Nr.



LT 28-35 II Bus (2DB, 2DE, 2DK)

2.5 TDI	05/96-08/99	AHD	2461	26.5x122; 21x81; 12/1996 →; mit Zubehör; Baumuster: LT 46	SK-1526	BTK	
2.5 TDI	05/96-08/99	AHD	2461	26.5x122; 21x81; mit Zubehör; Baumuster: LT 28, LT 35	SK-1526	BTK	
2.5 TDI	05/96-07/06	AHD, ANJ, AVR, APA, BBE, BBF	2461	26.5x122; 21x81; mit Zubehör	SK-1526AQ1	BTKW	
2.5 TDI	05/99-07/06	ANJ, AVR	2461	26.5x122; 21x81; 05/2001 →; mit Zubehör; Baumuster: LT 32	SK-1526	BTK	
2.5 TDI	05/99-07/06	ANJ, AVR, APA	2461	26.5x122; 21x81; mit Zubehör; Baumuster: LT 28, LT 35, LT 46	SK-1526	BTK	
2.5 TDI	05/01-07/06	BBE, BBF	2461	26.5x122; 21x81; mit Zubehör; Baumuster: LT 28, LT 32, LT 35, LT 46	SK-1526	BTK	
2.5 SDI	07/96-07/06	AGX	2461		0-N116	TB [TE]	
2.5 SDI, 2.5 TDI	05/96-07/06	AGX, AHD, ANJ, AVR, APA, BBE, BBF	2461		0-N110	TB [TE]	
2.5 SDI, 2.5 TDI	05/96-07/06	AGX, AHD, ANJ, AVR, APA, BBE, BBF	2461		0-N117	TB [TE]	
2.5 TDI	05/96-07/06	AHD, ANJ, AVR, APA, BBE, BBF	2461		0-N109	TB [TE]	
2.3	05/96-07/06	AGL	2295		0-N1703	VB [BT]	
2.3	05/96-07/06	AGL	2295		0-N1833	VB [TE]	
2.3	05/96-07/06	AGL	2295	→ 11/2001	0-N1951	VB [VD]	
2.3	05/96-07/06	AGL	2295		0-N2418	VB [BT]	
2.5 SDI, 2.5 TDI	05/96-07/06	AGX, AHD, ANJ, AVR, APA, BBE, BBF	2461		0-N1311	VB [DG]	
2.5 SDI, 2.5 TDI	05/96-07/06	AGX, AHD, ANJ, AVR, APA, BBE, BBF	2461	Rippenanzahl: 6	0-N1313	VB [TE]	
2.5 SDI, 2.5 TDI	05/96-07/06	AGX, AHD, ANJ, AVR, APA, BBE, BBF	2461	für OE: 074 145 278D, 074 145 299A	0-N1542S	VB [TE]	
2.5 SDI, 2.5 TDI	05/96-07/06	AGX, AHD, ANJ, AVR, APA, BBE, BBF	2461		0-N1800	VB [VD]	
2.8 TDi	05/01-06/06	AUH, BCQ	2799		0-N2350	VB [DG]	
2.8 TDi	05/01-06/06	AUH, BCQ	2799		0-N2391	VB [BT]	s

LT 28-46 II Kasten (2DA, 2DD, 2DH)

2.5 SDI	09/96-07/06	AGX	2461	26.5x122; 21x81; mit Zubehör; Baumuster: LT 28, LT 35	SK-1529	BTK	
2.5 SDI	09/96-07/06	AGX	2461	26.5x122; mit Zubehör	SK-1529AQ1	BTKW	
2.5 SDI	09/96-07/06	AGX	2461	26.5x122; mit Zubehör	SK-1725	BTK	
2.5 SDI	09/96-07/06	AGX	2461	26.5x122; mit Zubehör	SK-1725AQ1	BTKW	
2.5 TDI	05/96-08/99	AHD	2461	26.5x122; 21x81; 12/1996 →; mit Zubehör; Baumuster: LT 46	SK-1526	BTK	
2.5 TDI	05/96-08/99	AHD	2461	26.5x122; 21x81; mit Zubehör; Baumuster: LT 28, LT 35	SK-1526	BTK	
2.5 TDI	05/96-07/06	AHD, ANJ, AVR, APA, BBE, BBF	2461	26.5x122; 21x81; mit Zubehör	SK-1526AQ1	BTKW	
2.5 TDI	05/99-07/06	ANJ, AVR	2461	26.5x122; 21x81; 05/2001 →; mit Zubehör; Baumuster: LT 32	SK-1526	BTK	
2.5 TDI	05/99-07/06	ANJ, AVR, APA	2461	26.5x122; 21x81; mit Zubehör; Baumuster: LT 28, LT 35, LT 46	SK-1526	BTK	
2.5 TDI	05/01-07/06	BBE, BBF	2461	26.5x122; 21x81; mit Zubehör; Baumuster: LT 28, LT 32, LT 35, LT 46	SK-1526	BTK	
2.5 SDI	09/96-07/06	AGX	2461		0-N116	TB [TE]	
2.5 SDI, 2.5 TDI	05/96-07/06	AGX, AHD, ANJ, AVR, APA, BBE, BBF	2461		0-N110	TB [TE]	
2.5 SDI, 2.5 TDI	05/96-07/06	AGX, AHD, ANJ, AVR, APA, BBE, BBF	2461		0-N117	TB [TE]	
2.5 TDI	05/96-07/06	AHD, ANJ, AVR, APA, BBE, BBF	2461		0-N109	TB [TE]	
2.3	05/96-07/06	AGL	2295		0-N1703	VB [BT]	
2.3	05/96-07/06	AGL	2295		0-N1833	VB [TE]	
2.3	05/96-07/06	AGL	2295	→ 11/2001	0-N1951	VB [VD]	
2.3	05/96-07/06	AGL	2295		0-N2418	VB [BT]	
2.5 SDI, 2.5 TDI	05/96-07/06	AGX, AHD, ANJ, AVR, APA, BBE, BBF	2461		0-N1311	VB [DG]	
2.5 SDI, 2.5 TDI	05/96-07/06	AGX, AHD, ANJ, AVR, APA, BBE, BBF	2461	Rippenanzahl: 6	0-N1313	VB [TE]	
2.5 SDI, 2.5 TDI	05/96-07/06	AGX, AHD, ANJ, AVR, APA, BBE, BBF	2461	für OE: 074 145 278D, 074 145 299A	0-N1542S	VB [TE]	
2.5 SDI, 2.5 TDI	05/96-07/06	AGX, AHD, ANJ, AVR, APA, BBE, BBF	2461		0-N1800	VB [VD]	
2.8 TDI	07/97-07/06	AGK, ATA	2799		0-N846	VB [TE]	
2.8 TDI	04/02-07/06	AUH, BCQ	2799		0-N2350	VB [DG]	
2.8 TDI	04/02-07/06	AUH, BCQ	2799		0-N2391	VB [BT]	s

LT 28-46 II Pritsche/Fahrgestell (2DC, 2DF, 2DG, 2DL, 2DM)

2.5 SDI	09/96-07/06	AGX	2461	26.5x122; 21x81; mit Zubehör; Baumuster: LT 28, LT 35	SK-1529	BTK	
2.5 SDI	09/96-07/06	AGX	2461	26.5x122; mit Zubehör	SK-1529AQ1	BTKW	
2.5 SDI	09/96-07/06	AGX	2461	26.5x122; mit Zubehör	SK-1725	BTK	
2.5 SDI	09/96-07/06	AGX	2461	26.5x122; mit Zubehör	SK-1725AQ1	BTKW	
2.5 TDI	06/96-08/99	AHD	2461	26.5x122; 21x81; 12/1996 →; mit Zubehör; Baumuster: LT 46	SK-1526	BTK	
2.5 TDI	06/96-08/99	AHD	2461	26.5x122; 21x81; mit Zubehör; Baumuster: LT 28, LT 35	SK-1526	BTK	
2.5 TDI	06/96-07/06	AHD, ANJ, AVR, APA, BBE, BBF	2461	26.5x122; 21x81; mit Zubehör	SK-1526AQ1	BTKW	



CM³



Art. Nr.



ohne Halter

LT 28-46 II Pritsche/Fahrgestell (2DC, 2DF, 2DG, 2DL, 2DM)

2.5 TDI	05/99-07/06	ANJ, AVR, BBF	2461	26.5x122; 21x81; 06/2003 →; mit Zubehör; Baumuster: LT 46	SK-1526	BTK
2.5 TDI	05/99-07/06	ANJ, AVR, APA, BBE, BBF	2461	26.5x122; 21x81; mit Zubehör; Baumuster: LT 28, LT 35, LT 46	SK-1526	BTK
2.5 TDI	05/01-07/06	BBE	2461	26.5x122; 21x81; 06/2003 →; mit Zubehör; Baumuster: LT 35	SK-1526	BTK
2.5 SDI	09/96-07/06	AGX	2461		0-N116	TB [TE]
2.5 SDI, 2.5 TDI	06/96-07/06	AGX, AHD, ANJ, AVR, APA, BBE, BBF	2461		0-N110	TB [TE]
2.5 SDI, 2.5 TDI	06/96-07/06	AGX, AHD, ANJ, AVR, APA, BBE, BBF	2461		0-N117	TB [TE]
2.5 TDI	06/96-07/06	AHD, ANJ, AVR, APA, BBE, BBF	2461		0-N109	TB [TE]
2.3	06/96-07/06	AGL	2295		0-N1703	VB [BT]
2.3	06/96-07/06	AGL	2295		0-N1833	VB [TE]
2.3	06/96-07/06	AGL	2295	→ 11/2001	0-N1951	VB [VD]
2.3	06/96-07/06	AGL	2295		0-N2418	VB [BT]
2.5 SDI, 2.5 TDI	06/96-07/06	AGX, AHD, ANJ, AVR, APA, BBE, BBF	2461		0-N1311	VB [DG]
2.5 SDI, 2.5 TDI	06/96-07/06	AGX, AHD, ANJ, AVR, APA, BBE, BBF	2461	Rippenanzahl: 6	0-N1313	VB [TE]
2.5 SDI, 2.5 TDI	06/96-07/06	AGX, AHD, ANJ, AVR, APA, BBE, BBF	2461	für OE: 074 145 278D, 074 145 299A	0-N1542S	VB [TE]
2.5 SDI, 2.5 TDI	06/96-07/06	AGX, AHD, ANJ, AVR, APA, BBE, BBF	2461		0-N1800	VB [VD]
2.8 TDI	07/97-07/06	AGK, ATA	2799		0-N846	VB [TE]
2.8 TDI	04/02-07/06	AUH, BCQ	2799		0-N2350	VB [DG]
2.8 TDI	04/02-07/06	AUH, BCQ	2799		0-N2391	VB [BT] S

LT 40-55 I Kasten (291-512)

2.0	04/75-09/83	CH	1984	18x121; mit Zubehör; Baumuster: LT 40	SK-1026	BTK
2.4 D	07/90-05/96	1S	2383	25x119	SK-1129AQ1	BTKW
2.4 D	07/90-05/96	ACT	2383	25.4x120; 20x75; 08/1991 →	SK-1527	BTK
2.4 D	07/90-05/96	1S, ACT	2383	25.4x120; 20x75; 08/1992 →	SK-1527	BTK
2.4 D 4WD	01/79-03/86	DW	2383	20x75; 25.4x119; 04/1979 →	SK-1129	BTK
2.4 D, 2.4 D 4WD, 2.4 TD	01/79-08/92	1G, CP, DW, DV, DW	2383	25x119	SK-1129AQ1	BTKW
2.4 D, 2.4 TD, 2.4 TD 4WD	08/78-08/92	CP, DW, DV	2383	20x75; 25.4x119	SK-1129	BTK
2.4 TD	08/88-08/92	1G	2383	20x75; 25.4x119; 08/1991 →	SK-1129	BTK
2.4 TD 4WD	08/78-07/92	DV	2383	25x119; 12/1982 →	SK-1129AQ1	BTKW
2.4 TD, 2.4 TD Syncro	06/92-05/96	ACL	2383	25.4x120; 20x75	SK-1527	BTK
2.0	04/75-09/83	CH	1984		0-N805	TB [TE]
2.4 D	07/90-05/96	ACT	2383		0-N1232	TB [TE]
2.4 D	07/90-05/96	ACT	2383		0-N163	TB [DG]
2.4 D	07/90-05/96	1S	2383		0-N807	TB [DG]
2.4 D, 2.4 D 4WD, 2.4 TD, 2.4 TD 4WD	08/78-08/92	1G, CP, DW, DV, DW	2383		0-N807	TB [DG]
2.4 TD	06/92-05/96	ACL	2383		0-N1232	TB [TE]
2.4 TD	06/92-05/96	ACL	2383		0-N163	TB [DG]
2.4, 2.4 4WD, 2.4 i	12/82-06/96	1E, DL	2383	ch.28-F-000001→	0-N807	TB [DG]

LT 40-55 I Pritsche/Fahrgestell (293-909)

2.0	04/75-09/83	CH	1984	18x121; mit Zubehör; Baumuster: LT 40, LT 45	SK-1026	BTK
2.4 D	08/90-06/96	1S	2383	25x119	SK-1129AQ1	BTKW
2.4 D	08/90-06/96	ACT	2383	25.4x120; 20x75	SK-1527	BTK
2.4 D, 2.4 TD	08/90-06/96	1S, ACT, ACL	2383	25.4x120; 20x75; 08/1992 →	SK-1527	BTK
2.4 D, 2.4 TD, 2.4 TD Syncro	12/78-09/93	1G, CP, DW, DV	2383	20x75; 25.4x119	SK-1129	BTK
2.4 D, 2.4 TD, 2.4 TD Syncro	12/78-09/93	1G, CP, DW, DV	2383	25x119	SK-1129AQ1	BTKW
2.4 TD Syncro	08/92-04/96	ACL	2383	25.4x120; 20x75	SK-1527	BTK
2.0	04/75-09/83	CH	1984		0-N805	TB [TE]
2.4 D	08/90-06/96	ACT	2383		0-N1232	TB [TE]
2.4 D	08/90-06/96	ACT	2383		0-N163	TB [DG]
2.4 D	08/90-06/96	1S	2383		0-N807	TB [DG]
2.4 D, 2.4 TD	12/78-09/93	1G, CP, DW, DV	2383		0-N807	TB [DG]
2.4 i	03/94-06/96	1E	2383	ch.28-F-000001→	0-N807	TB [DG]
2.4 TD	08/92-06/96	ACL	2383		0-N1232	TB [TE]
2.4 TD	08/92-06/96	ACL	2383		0-N163	TB [DG]

LUPO (6X1, 6E1)

1.0	09/98-07/05	AER, ALD, ALL, ANV, AUC	999	19x135; ch.→6X-Y-060000; mit Zubehör	SK-1131	BTK
1.0	09/98-07/05	AER, ALD, ALL, ANV, AUC	999	19x135; ch.→6X-Y-060000; mit Zubehör	SK-1131AQ2	BTKW
1.0	09/98-07/05	AER, ALD, ALL, ANV, AUC	999	19x135; ch.6X-Y-060001→; mit Zubehör	SK-1592	BTK
1.0	09/98-07/05	AER, ALD, ALL, ANV, AUC	999	19x135; ch.6X-Y-060001→; mit Zubehör	SK-1592AQ1	BTKW
1.2 TDI 3L	07/99-07/05	AYZ	1191	30x117; ohne Spanndämpfer, Spannrolle; Baumuster: 6X1, 6E1	SK-1603	BTK
1.2 TDI 3L	07/99-07/05	ANY, AYZ	1191	30x117; ohne Spanndämpfer, Spannrolle	SK-1603AQ1	BTKW



CM³



Art. Nr.



LUPO (6X1, 6E1)

1.2 TDI 3L	07/99-07/05	AYZ	1191	30x117; mit Spanndämpfer, Spannrolle; Baumuster: 6X1, 6E1	SK-1604	BTK
1.2 TDI 3L	07/99-07/05	ANY, AYZ	1191	30x117; mit Spanndämpfer, Spannrolle	SK-1604AQ1	BTKW
1.4	10/00-07/05	AUD	1390	19x135; ch.→6X-Y-060000; mit Zubehör	SK-1131	BTK
1.4	10/00-07/05	AUD	1390	19x135; ch.→6X-Y-060000; mit Zubehör	SK-1131AQ2	BTKW
1.4	10/00-07/05	AUD	1390	19x135; ch.6X-Y-060001→; mit Zubehör	SK-1592	BTK
1.4	10/00-07/05	AUD	1390	19x135; mit Zubehör	SK-1592AQ1	BTKW
1.4 16V	09/98-07/05	APE, AUA, BBY	1390	20x130; 17x58; beinhalten Rollen: 4	SK-1511	BTK
1.4 16V	09/98-07/05	AHW	1390	20x130; 17x58; :164201→; beinhalten Rollen: 4	SK-1511	BTK
1.4 16V	09/98-07/05	AKQ	1390	20x130; 17x58; :241245→; beinhalten Rollen: 4	SK-1511	BTK
1.4 16V	09/98-07/05	APE, AUA, BBY	1390	20x130; 17x58; beinhalten Rollen: 4	SK-1511AQ1	BTKW
1.4 16V	09/98-07/05	AHW	1390	20x130; 17x58; :AHW160001→; beinhalten Rollen: 4	SK-1511AQ1	BTKW
1.4 16V	09/98-07/05	AKQ	1390	20x130; 17x58; :AKQ242001→; beinhalten Rollen: 4	SK-1511AQ1	BTKW
1.4 16V	09/98-07/05	AKQ	1390	20x130; 17x58; → 06/1999; :→AKQ242000	SK-1585	BTK
1.4 16V	09/98-07/05	AHW	1390	20x130; 17x58; 05/1999 →; :→AHW160000	SK-1585	BTK
1.4 16V	09/98-07/05	AHW, AKQ	1390	20x130; 17x58; :→160000, 242000	SK-1585AQ1	BTKW
1.4 16V, 1.4 FSI	08/99-07/05	AFK, AQQ, AUB, ARR	1390	20x130; 17x58; beinhalten Rollen: 4	SK-1511	BTK
1.4 16V, 1.4 FSI	08/99-07/05	AFK, AQQ, AUB, ARR	1390	20x130; 17x58; beinhalten Rollen: 4	SK-1511AQ1	BTKW
1.4 TDI	01/99-07/05	AMF	1422	30x120; ch.6X-2-015001→; mit Zubehör	SK-1372	BTK
1.4 TDI	01/99-07/05	AMF	1422	30x120; ch.6X-2-040001→; ch.→6X-2-100000	SK-1372AQ1	BTKW
1.4 TDI	01/99-07/05	AMF	1422	30x120; ch.6X-2-100001→	SK-1372AQ1	BTKW
1.4 TDI	01/99-07/05	AMF	1422	30x120; 05/1999 →; :→AMF011494; mit Spanndämpfer, Spannrolle; mit Zubehör; Baumuster: 6X1, 6E1	SK-1378	BTK
1.4 TDI	01/99-07/05	AMF	1422	30x120; 05/1999 →; :→AMF011494; ohne Spanndämpfer, Spannrolle; mit Zubehör; Baumuster: 6X1, 6E1	SK-1388	BTK
1.4 TDI	01/99-07/05	AMF	1422	30x120; 015000; 05/1999 →; :AMF011495→; mit Zubehör; Baumuster: 6X1, 6E1	SK-1582	BTK
1.4 TDI	01/99-07/05	AMF	1422	30x120; 040000; :AMF011495→; ohne Spanndämpfer, Spannrolle; mit Zubehör	SK-1582AQ2	BTKW
1.4 TDI	01/99-07/05	AMF	1422	30x120; 015000; 05/1999 →; :AMF011495→; mit Spanndämpfer, Spannrolle; mit Zubehör; Baumuster: 6X1, 6E1	SK-1583	BTK
1.4 TDI	01/99-07/05	AMF	1422	30x120; 040000; :AMF011495→; mit Spanndämpfer, Spannrolle; mit Zubehör	SK-1583AQ2	BTKW
1.6 GTI	09/00-07/05	AVY	1598	20x130; 17x58; beinhalten Rollen: 4	SK-1511	BTK
1.6 GTI	09/00-07/05	AVY	1598	20x130; 17x58; beinhalten Rollen: 4	SK-1511AQ2	BTKW
1.7 SDI	09/98-07/05	AKU	1716	23x137; mit Zubehör	SK-1106	BTK
1.0	09/98-07/05	AER, ALD, ALL, ANV, AUC	999	ch.→6X-Y-060000	0-N106	TB [TE]
1.0	09/98-07/05	AER, ALD, ALL, ANV, AUC	999	ch.6X-Y-060001→	0-N1331	TB [TE]
1.2 TDI 3L	07/99-07/05	ANY, AYZ	1191		0-N1048	TB [TE]
1.2 TDI 3L	07/99-07/05	ANY, AYZ	1191		0-N1268	TB [DG]
1.2 TDI 3L	07/99-07/05	ANY, AYZ	1191		0-N1344	TB [BT]
1.4	10/00-07/05	AUD	1390		0-N1331	TB [TE]
1.4 16V	09/98-07/05	APE, AUA, BBY	1390		0-N1263	TB [TE]
1.4 16V	09/98-07/05	AHW	1390	:160001→	0-N1263	TB [TE]
1.4 16V	09/98-07/05	AKQ	1390	:242001→	0-N1263	TB [TE]
1.4 16V	09/98-07/05	AHW	1390	:→160000	0-N159	TB [TE]
1.4 16V	09/98-07/05	AKQ	1390	:→242000	0-N159	TB [TE]
1.4 16V, 1.4 FSI	09/98-07/05	AFK, AQQ, AUB, AHW, AKQ, APE, AUA, BBY, ARR	1390		0-N1262	TB [DG]
1.4 16V, 1.4 FSI	09/98-07/05	AFK, AQQ, AUB, AHW, AKQ, APE, AUA, BBY, ARR	1390		0-N158	TB [TE]
1.4 16V, 1.4 FSI	09/98-07/05	AFK, AQQ, AUB, AHW, AKQ, APE, AUA, BBY, ARR	1390		0-N164	TB [DG]
1.4 16V, 1.4 FSI	08/99-07/05	AFK, AQQ, AUB, ARR	1390		0-N1263	TB [TE]
1.4 TDI	01/99-07/05	AMF	1422	ch.6X-2-015001→	0-N1045	TB [TE]
1.4 TDI	01/99-07/05	AMF	1422	ch.6X-2-015001→	0-N1046	TB [DG]
1.4 TDI	01/99-07/05	AMF	1422	ch.→6X-2-015000; :011495→	0-N1048	TB [TE]
1.4 TDI	01/99-07/05	AMF	1422	:→011494	0-N1049	TB [BT]
1.4 TDI	01/99-07/05	AMF	1422	:→011494; mit Anbaumaterial	0-N1265	TB [TE]



CM³



Art. Nr.



LUPO (6X1, 6E1)							
1.4 TDI	01/99-07/05	AMF	1422	ch.→6X-2-015000	0-N1268	TB [DG]	
1.4 TDI	01/99-07/05	AMF	1422	ch.→6X-2-015000; :011495→	0-N1274	TB [BT]	
1.6 GTI	09/00-07/05	AVY	1598		0-N1262	TB [DG]	
1.6 GTI	09/00-07/05	AVY	1598		0-N1263	TB [TE]	
1.6 GTI	09/00-07/05	AVY	1598		0-N158	TB [TE]	
1.6 GTI	09/00-07/05	AVY	1598		0-N164	TB [DG]	
1.7 SDI	09/98-07/05	AKU	1716		0-N111	TB [TE]	
1.7 SDI	09/98-07/05	AKU	1716		0-N128	TB [DG]	
1.0	09/98-07/05	AER, ALD, ALL, ANV, AUC	999		0-N1445	VB [BT]	S
1.0	09/98-07/05	AHT	999		0-N1675	VB [TE]	
1.0	10/98-05/00	AHT	997		0-N1675	VB [TE]	
1.0	10/98-05/00	AHT	997		0-N2065	VB [TE]	S
1.0	10/98-05/00	AHT	997	, für Fahrzeuge mit Servolenkung	0-N2066	VB [BT]	
1.2 TDI 3L	07/99-07/05	ANY, AYZ	1191		0-N1704	VB [BT]	S
1.4 FSI	02/01-07/05	ARR	1390		0-N1445	VB [BT]	S
1.4 TDI	01/99-07/05	AMF	1422		0-N1041	VB [BT]	S
1.4 TDI	01/99-07/05	AMF	1422	ch.6X-2-015001→	0-N1704	VB [BT]	S
1.4, 1.4 16V	09/98-07/05	AFK, AQQ, AUB, AHW, AKQ, APE, AUA, BBY, AUD	1390	für Fahrzeuge mit Servolenkung	0-N1445	VB [BT]	S
1.6 GTI	09/00-07/05	AVY	1598		0-N1445	VB [BT]	S
1.7 SDI	09/98-07/05	AKU	1716		0-N1675	VB [TE]	
1.7 SDI	09/98-07/05	AKU	1716		0-N1920	VB [BT]	
1.7 SDI	09/98-07/05	AKU	1716	für Artikelnummer:0-N1920	0-N1925	VB [BT]	
PARATI III							
1.9 SDI	08/02-	BGG	1896	25.4x137; → 05/2008; mit Zubehör	SK-1122	BTK	
1.0	08/02-	ASW	999	ch.5X-4P-123865→	0-N1258	TB [TE]	
1.0	08/02-	ASW	999	ch.5X-4T-178067→	0-N1258	TB [TE]	
1.0	08/02-	AZP	999		0-N1262	TB [DG]	
1.0	08/02-	AZP	999		0-N1263	TB [TE]	
1.0	08/02-	AZP	999		0-N158	TB [TE]	
1.0	08/02-	AZP	999		0-N164	TB [DG]	
1.0	08/02-	ASW	999	ch.5X-4P-123865→	0-N165	TB [DG]	
1.0	08/02-	ASW	999	ch.5X-4T-178067→	0-N165	TB [DG]	
1.8	08/02-	UDH	1781		0-N805	TB [TE]	
1.9 SDI	08/02-	BGG	1896		0-N104	TB [TE]	
1.0	08/02-	ASW, AZP	999		0-N1605	VB [DG]	
1.0	08/02-	ASW, AZP	999	, für Fahrzeuge mit Servolenkung	0-N1890	VB [BT]	S
1.8	08/02-	UDH	1781		0-N1885	VB [BT]	
1.8	08/02-	UDH	1781		0-N1885S1	VB [TE]	
1.8	08/02-	UDH	1781		0-N1885S2	VB [TE]	
1.8	08/02-	UDH	1781		0-N1886	VB [BT]	
1.8	08/02-	UDH	1781		0-N1886S1	VB [TE]	
1.8	08/02-	UDH	1781		0-N1886S2	VB [TE]	
PASSAT (32)							
1.3	05/73-01/78	ZA, ZF	1297	18x121; mit Zubehör	SK-1026	BTK	
1.3	05/73-07/80	FY	1272	18x121; → 12/1977; mit Zubehör	SK-1026	BTK	
1.5	05/73-12/75	ZC	1471	18x121; 08/1974 →; mit Zubehör	SK-1026	BTK	
1.5	07/73-12/75	YJ, ZB	1471	18x121; mit Zubehör	SK-1026	BTK	
1.5 D	08/77-07/80	CK	1471	25x135; mit Zubehör	SK-1001	BTK	
1.6, 1.6 GLi	08/75-07/80	FS, YP, YS	1588	18x121; mit Zubehör	SK-1026	BTK	
1.3	05/73-01/78	ZA, ZF	1297		0-N805	TB [TE]	
1.5	05/73-12/75	YJ, ZB, ZC	1471		0-N805	TB [TE]	
1.5 D	08/77-07/80	CK	1471		0-N806	TB [TE]	
1.6, 1.6 GLi	08/75-07/80	FS, YP, YS	1588		0-N805	TB [TE]	
PASSAT Variant (33)							
1.3	05/73-01/78	ZA, ZF	1297	18x121; mit Zubehör	SK-1026	BTK	
1.5	10/73-12/75	YJ, ZB, ZC	1471	18x121; mit Zubehör	SK-1026	BTK	
1.5 D	02/77-07/80	CK	1471	25x135; 08/1977 →; mit Zubehör	SK-1001	BTK	
1.6 D	02/79-07/80	CR	1588	25x135; mit Zubehör	SK-1001	BTK	
1.6, 1.6 i	08/75-07/80	YN, YP, YS	1588	18x121; mit Zubehör	SK-1026	BTK	
1.3	05/73-01/78	ZA, ZF	1297		0-N805	TB [TE]	
1.5	10/73-12/75	YJ, ZB, ZC	1471		0-N805	TB [TE]	
1.5 D	02/77-07/80	CK	1471		0-N806	TB [TE]	
1.6 D	02/79-07/80	CR	1588		0-N806	TB [TE]	



CM³



Art. Nr.



PASSAT Variant (33)

1.6, 1.6 i	08/75-07/80	YN, YP, YS	1588		0-N805	TB [TE]	
------------	-------------	------------	------	--	--------	---------	--

PASSAT (32B)

1.3	08/80-07/86	FZ	1272	18x121; 01/1981 →; mit Zubehör	SK-1026	BTK	
1.3	08/80-07/86	EP, EU, EU	1297	18x121; 08/1983 →; mit Zubehör	SK-1026	BTK	
1.6	08/80-03/88	WV, YN	1588	18x121; 01/1981 →; mit Zubehör	SK-1026	BTK	
1.6	08/80-03/88	DT	1595	18x121; 08/1983 →; mit Zubehör	SK-1026	BTK	
1.6	01/81-03/88	PP, YP	1588	18x121; mit Zubehör	SK-1026	BTK	
1.6	02/86-03/88	RL	1595	18x121; 08/1986 →; mit Zubehör	SK-1026	BTK	
1.6 D	08/80-03/88	CR, JK	1588	25x135; 01/1981 →; mit Zubehör	SK-1001	BTK	
1.6 TD	04/82-03/88	CY, RA	1588	25x135; mit Zubehör	SK-1001	BTK	
1.8	01/83-03/88	DS, JN, JV	1781	18x121; 08/1983 →; mit Zubehör	SK-1026	BTK	
1.8	12/83-03/88	DZ, RM	1781	18x121; mit Zubehör	SK-1026	BTK	
1.3	08/80-07/86	EP, EU, EU	1297		0-N805	TB [TE]	
1.6	08/80-03/88	PP, WV, YN, YP	1588		0-N805	TB [TE]	
1.6	08/80-03/88	DT, RL	1595		0-N805	TB [TE]	
1.6 D, 1.6 TD	08/80-03/88	CR, JK, CY, RA	1588		0-N806	TB [TE]	
1.8	01/83-03/88	DS, JN, JV, DZ, RM	1781		0-N805	TB [TE]	
2.0	08/83-03/88	HP, HP, JS	1994		0-N807	TB [DG]	
2.2	01/85-03/88	KV, KX	2226		0-N807	TB [DG]	

PASSAT Variant (32B)

1.3	08/80-07/86	FZ	1272	18x121; 08/1981 →; mit Zubehör	SK-1026	BTK	
1.3	08/80-07/86	EP, EU, EU	1297	18x121; 08/1983 →; mit Zubehör	SK-1026	BTK	
1.6	08/80-03/88	WV, YN	1588	18x121; 01/1981 →; mit Zubehör	SK-1026	BTK	
1.6	08/80-03/88	DT	1595	18x121; 08/1983 →; mit Zubehör	SK-1026	BTK	
1.6	01/81-03/88	PP, YP	1588	18x121; mit Zubehör	SK-1026	BTK	
1.6	02/86-03/88	RL	1595	18x121; 08/1986 →; mit Zubehör	SK-1026	BTK	
1.6 D	08/80-03/88	CR, JK	1588	25x135; 08/1981 →; mit Zubehör	SK-1001	BTK	
1.6 TD	04/82-03/88	CY	1588	25x135; mit Zubehör	SK-1001	BTK	
1.8	01/83-03/88	DS, JN, JV	1781	18x121; 08/1983 →; mit Zubehör	SK-1026	BTK	
1.8, 1.8 Syncro	12/83-03/88	DS, JN, DZ, RM	1781	18x121; mit Zubehör	SK-1026	BTK	
1.3	08/80-07/86	EP, EU, EU	1297		0-N805	TB [TE]	
1.6	08/80-03/88	PP, WV, YN, YP	1588		0-N805	TB [TE]	
1.6	08/80-03/88	DT, RL	1595		0-N805	TB [TE]	
1.6 D, 1.6 TD	08/80-03/88	CR, JK, CY	1588		0-N806	TB [TE]	
1.8, 1.8 Syncro	01/83-03/88	DS, JN, DS, JN, JV, DZ, RM	1781		0-N805	TB [TE]	
2.0, 2.0 Syncro	08/83-03/88	HP, HP, JS, JS	1994		0-N807	TB [DG]	
2.2, 2.2 Syncro	01/85-03/88	JT, KV, KX	2226		0-N807	TB [DG]	

PASSAT Stufenheck (32B)

1.6	01/85-03/88	RL	1595	18x121; 08/1986 →; mit Zubehör	SK-1026	BTK	
1.6	01/85-03/88	DT	1595	18x121; mit Zubehör	SK-1026	BTK	
1.6	08/87-03/88	PP	1588	18x121; mit Zubehör	SK-1026	BTK	
1.6 TD	01/85-03/88	CY	1588	25x135; mit Zubehör	SK-1001	BTK	
1.8	01/85-03/88	DS, JN, RM	1781	18x121; mit Zubehör	SK-1026	BTK	
1.6	01/85-03/88	DT, RL	1595		0-N805	TB [TE]	
1.6	08/87-03/88	PP	1588		0-N805	TB [TE]	
1.6 TD	01/85-03/88	CY	1588		0-N806	TB [TE]	
1.8	01/85-03/88	DS, JN, RM	1781		0-N805	TB [TE]	
2.2	01/85-03/88	KX	2226		0-N807	TB [DG]	

PASSAT (3A2, 35I)

1.6	02/88-09/91	1F, EZ, ABN, EZ	1595	18x121; mit Zubehör	SK-1026	BTK	
1.6	10/94-08/96	AEK, AFT	1595	18x121; 08/1995 →; mit Zubehör	SK-1026	BTK	
1.6 TD	08/88-09/93	RA, SB	1588	25x135; mit Zubehör	SK-1001	BTK	
1.8	02/88-08/96	AAM, ABS, ADZ, RP, PB, PF	1781	18x121; mit Zubehör	SK-1026	BTK	
1.8	08/90-08/96	AAM	1781	18x121; 08/1994 →; mit Zubehör	SK-1090	BTK	
1.8 16V, 1.8 GL	04/88-09/93	KR	1781	25x147	SK-1047	BTK	
1.8 G60 Syncro	08/88-08/96	PG	1781	18x121; 09/1989 →; mit Zubehör	SK-1026	BTK	
1.9 D, 1.9 TD	05/89-08/96	1Y, AAZ	1896	25.4x137; mit Zubehör	SK-1029	BTK	
1.9 TD	03/91-08/96	AAZ	1896	25.4x137; :552766 →; mit Zubehör	SK-1122	BTK	
1.9 TDI	10/93-08/96	1Z, AHU	1896	25.4x137; → 07/1994; : →1Z289575; mit Zubehör	SK-1069	BTK	
1.9 TDI	10/93-08/96	1Z, AHU	1896	25x137; 07/1994 →; :289576 →; mit Zubehör	SK-1098	BTK	
1.9 TDI	03/96-08/96	AFN	1896	25x137; mit Zubehör	SK-1098	BTK	
2.0 16V	08/88-09/93	9A	1984	25x147	SK-1047	BTK	



CM³



Art. Nr.



ohne Halter

PASSAT (3A2, 35I)							
2.0 16V	01/94-08/96	ABF	1984	25x151	SK-1104	BTK	
2.0 16V	01/94-08/96	ABF	1984	25x151; → 03/1994	SK-1123	BTK	
2.0, 2.0 Syncro	02/90-08/96	2E, ABA, ABA, ABA, ADY, AGG, 2E, ADY, AGG, AEP	1984	18x124; mit Zubehör	SK-1120	BTK	
1.6	02/88-08/96	1F, EZ, ABN, EZ, AEK, AFT	1595		0-N805	TB [TE]	
1.6 TD	08/88-09/93	RA, SB	1588		0-N806	TB [TE]	
1.8 16V, 1.8 GL	04/88-09/93	KR	1781		0-N808	TB [TE]	
1.8, 1.8 G60 Syncro	02/88-08/96	AAM, ABS, ADZ, RP, PB, PF, PG	1781		0-N805	TB [TE]	
1.9 D	05/89-10/93	1Y	1896		0-N806	TB [TE]	
1.9 TD	03/91-08/96	AAZ	1896	:552766→	0-N104	TB [TE]	
1.9 TD	03/91-08/96	AAZ	1896	:→552765	0-N806	TB [TE]	
1.9 TDI	10/93-08/96	1Z	1896	:→289575	0-N103	TB [TE]	
1.9 TDI	10/93-08/96	AHU	1896		0-N104	TB [TE]	
1.9 TDI	10/93-08/96	1Z	1896	:289576→	0-N104	TB [TE]	
1.9 TDI	10/93-08/96	1Z, AHU, AFN	1896		0-N128	TB [DG]	
1.9 TDI	03/96-08/96	AFN	1896		0-N104	TB [TE]	
2.0 16V	08/88-09/93	9A	1984		0-N808	TB [TE]	
2.0 16V	01/94-08/96	ABF	1984	:020923→	0-N129	TB [TE]	
2.0 16V	01/94-08/96	ABF	1984	:→020922	0-N808	TB [TE]	
2.0, 2.0 Syncro	09/89-08/96	2E, ABA, ABA, ABA, ADY, AGG, 2E, ADY, AGG, AEP	1984		0-N805	TB [TE]	
1.6	10/94-08/96	AEK, AFT	1595		0-N1417	VB [TE]	
1.6	10/94-08/96	AEK, AFT	1595		0-N1660	VB [BT]	
1.8	02/88-08/96	AAM, ABS, ADZ, RP	1781		0-N1417	VB [TE]	
1.8	02/88-08/96	ABS, ADZ	1781		0-N1660	VB [BT]	
1.8	08/90-08/96	AAM	1781		0-N1660	VB [BT]	
1.9 D, 1.9 TD, 1.9 TDI	05/89-08/96	1Y, 1Z, AHU, AAZ, AFN	1896		0-N1417	VB [TE]	
1.9 D, 1.9 TD, 1.9 TDI	05/89-08/96	1Y, 1Z, AHU, AAZ, AFN	1896		0-N1609	VB [BT]	
1.9 TDI	10/93-08/96	AHU	1896	Rippenanzahl: 4	0-N1317	VB [TE]	S
1.9 TDI	03/96-08/96	AFN	1896	Rippenanzahl: 4	0-N1317	VB [TE]	S
2.0, 2.0 16V, 2.0 Syncro	09/89-08/96	2E, ABA, ABA, ABA, ADY, AGG, 2E, ADY, AGG, ABF, AEP	1984		0-N1417	VB [TE]	
2.0, 2.0 16V, 2.0 Syncro	02/90-08/96	2E, ABA, ABA, ABA, ADY, AGG, 2E, ADY, AGG, ABF, AEP	1984		0-N1660	VB [BT]	
2.8 VR6	06/91-08/96	AAA	2792	Rippenanzahl: 7	0-N1657	VB [BT]	S
PASSAT Variant (3A5, 35I)							
1.6	04/88-12/95	1F, EZ, AEK, AFT, EZ	1595	18x121; mit Zubehör	SK-1026	BTK	
1.6 TD	08/88-09/93	RA, SB	1588	25x135; mit Zubehör	SK-1001	BTK	
1.8	02/88-05/97	AAM, ABS, ADZ, RP, PB, PF	1781	18x121; mit Zubehör	SK-1026	BTK	
1.8	08/90-05/97	AAM	1781	18x121; 08/1994 →; mit Zubehör	SK-1090	BTK	
1.8 16V	04/88-12/89	KR	1781	25x147	SK-1047	BTK	
1.8 G60 Syncro	08/88-05/97	PG	1781	18x121; 09/1989 →; mit Zubehör	SK-1026	BTK	
1.9 D, 1.9 TD	05/89-05/97	1Y, AAZ	1896	25.4x137; mit Zubehör	SK-1029	BTK	
1.9 TD	03/91-05/97	AAZ	1896	25.4x137; :552766→; mit Zubehör	SK-1122	BTK	
1.9 TDI	10/93-05/97	1Z, AHU	1896	25.4x137; → 07/1994; :→1Z289575; mit Zubehör	SK-1069	BTK	
1.9 TDI	10/93-05/97	1Z, AHU	1896	25x137; 07/1994 →; :289576→; mit Zubehör	SK-1098	BTK	
1.9 TDI	03/96-05/97	AFN	1896	25x137; mit Zubehör	SK-1098	BTK	
2.0 16V	08/88-09/93	9A	1984	25x147	SK-1047	BTK	
2.0 16V	01/94-05/97	ABF	1984	25x151; → 10/1996	SK-1104	BTK	
2.0 16V	01/94-05/97	ABF	1984	25x151; → 03/1994	SK-1123	BTK	
2.0, 2.0 Syncro	02/90-05/97	2E, ADY, AGG, AEP	1984	18x124; mit Zubehör	SK-1120	BTK	
1.6	04/88-12/95	1F, EZ, AEK, AFT, EZ	1595		0-N805	TB [TE]	
1.6 TD	08/88-09/93	RA, SB	1588		0-N806	TB [TE]	
1.8, 1.8 16V	04/88-09/93	KR	1781		0-N808	TB [TE]	
1.8, 1.8 G60 Syncro	02/88-05/97	AAM, ABS, ADZ, RP, PB, PF, PG	1781		0-N805	TB [TE]	
1.9 D	05/89-10/93	1Y	1896		0-N806	TB [TE]	
1.9 TD	03/91-05/97	AAZ	1896	:552766→	0-N104	TB [TE]	
1.9 TD	03/91-05/97	AAZ	1896	:→552765	0-N806	TB [TE]	
1.9 TDI	10/93-05/97	1Z	1896	:→289575	0-N103	TB [TE]	
1.9 TDI	10/93-05/97	AHU	1896		0-N104	TB [TE]	
1.9 TDI	10/93-05/97	1Z	1896	:289576→	0-N104	TB [TE]	
1.9 TDI	10/93-05/97	1Z, AHU, AFN	1896		0-N128	TB [DG]	
1.9 TDI	03/96-05/97	AFN	1896		0-N104	TB [TE]	
2.0 16V	08/88-09/93	9A	1984		0-N808	TB [TE]	



CM³



Art. Nr.



ohne Halter

PASSAT Variant (3A5, 35I)

2.0 16V	01/94-05/97	ABF	1984	:020923→	0-N129	TB [TE]	
2.0 16V	01/94-05/97	ABF	1984	:→020922	0-N808	TB [TE]	
2.0, 2.0 Syncro	02/90-05/97	2E, ADY, AGG, AEP	1984		0-N805	TB [TE]	
1.6	07/94-12/95	AEK, AFT	1595		0-N1417	VB [TE]	
1.6	07/94-12/95	AEK, AFT	1595		0-N1660	VB [BT]	
1.8	02/88-05/97	AAM, ABS, ADZ, RP	1781		0-N1417	VB [TE]	
1.8	02/88-05/97	ABS, ADZ	1781		0-N1660	VB [BT]	
1.8	08/90-05/97	AAM	1781		0-N1660	VB [BT]	
1.9 D, 1.9 TD, 1.9 TDI	05/89-05/97	1Y, 1Z, AHU, AAZ, AFN	1896		0-N1417	VB [TE]	
1.9 D, 1.9 TD, 1.9 TDI	05/89-05/97	1Y, 1Z, AHU, AAZ, AFN	1896		0-N1609	VB [BT]	
1.9 TDI	10/93-05/97	AHU	1896	Rippenanzahl: 4	0-N1317	VB [TE]	S
1.9 TDI	03/96-05/97	AFN	1896	Rippenanzahl: 4	0-N1317	VB [TE]	S
2.0, 2.0 16V, 2.0 Syncro	02/90-05/97	2E, ADY, AGG, ABF, AEP	1984		0-N1417	VB [TE]	
2.0, 2.0 16V, 2.0 Syncro	02/90-05/97	2E, ADY, AGG, ABF, AEP	1984		0-N1660	VB [BT]	
2.8 VR6	06/91-05/97	AAA	2792	Rippenanzahl: 7	0-N1657	VB [BT]	S
2.9 VR6 Syncro	01/94-05/97	ABV	2861	Rippenanzahl: 7	0-N1657	VB [BT]	S

PASSAT (3B2)

1.6	10/96-11/00	ADP	1595	18x121; mit Zubehör	SK-1101	BTK	
1.6	10/96-11/00	AHL, ANA, ARM	1595	23x138	SK-1109	BTK	
1.6	10/96-11/00	AHL, ANA, ARM	1595	23x138	SK-1109AQ1	BTKW	
1.8	10/96-11/00	ADR, APT, ARG	1781	25x153; mit Zubehör; Baumuster: 3B2	SK-1346	BTK	
1.8	01/97-11/00	AFY	1781	25x153; mit Zubehör; Baumuster: 3B2	SK-1346	BTK	
1.8 Syncro/4motion	10/96-11/00	ADR	1781	25x153; mit Zubehör; Baumuster: 3B2	SK-1346	BTK	
1.8 T	10/96-11/00	AEB, ANB, APU, AWT	1781	25x153; mit Zubehör; Baumuster: 3B2	SK-1346	BTK	
1.8 T	10/96-11/00	AWT	1781	23x150; ohne Spanndämpfer, Spannrolle; mit Zubehör	SK-1640	BTK	
1.8 T	10/96-11/00	AWT	1781	23x150; ohne Spanndämpfer, Spannrolle; mit Zubehör	SK-1640AQ1	BTKW	
1.8, 1.8 Syncro/4motion, 1.8 T	10/96-11/00	ADR, APT, ARG, AEB, ANB, APU, AFY	1781	25x153; mit Spanndämpfer, Spannrolle; mit Zubehör	SK-1638	BTK	
1.9 TDI	10/96-11/00	AFN, AVG	1896	25x137; mit Zubehör	SK-1098	BTK	
1.9 TDI	10/96-11/00	AHU	1896	25x137; mit Zubehör	SK-1098	BTK	
1.9 TDI	10/96-11/00	AHH, AHU	1896	25x137; ch.3B-V-000001→; 05/1998 → 04/1999; mit Zubehör	SK-1593	BTK	
1.9 TDI	08/98-11/00	AJM	1896	30x120; 01/1999 →; :→AJM185670; mit Spanndämpfer, Spannrolle; mit Zubehör; Baumuster: 3B2	SK-1378	BTK	
1.9 TDI	08/98-11/00	AJM, ATJ	1896	30x120; 01/1999 →; :→AJM185670; ohne Spanndämpfer, Spannrolle; mit Zubehör; Baumuster: 3B2	SK-1388	BTK	
1.9 TDI	08/98-11/00	ATJ	1896	30x120; 01/1999 →; mit Zubehör	SK-1582	BTK	
1.9 TDI	08/98-11/00	AJM	1896	30x120; 01/1999 →; :AJM185671→; mit Zubehör	SK-1582	BTK	
1.9 TDI	08/98-11/00	ATJ	1896	30x120; 01/1999 →; mit Spanndämpfer, Spannrolle; mit Zubehör	SK-1583	BTK	
1.9 TDI	08/98-11/00	AJM	1896	30x120; 01/1999 →; :AJM185671→; mit Spanndämpfer, Spannrolle; mit Zubehör	SK-1583	BTK	
1.9 TDI	02/00-11/00	AVB	1896	30x120; mit Zubehör; Baumuster: 3B2	SK-1582	BTK	
1.9 TDI	02/00-11/00	AVB	1896	30x120; ohne Spanndämpfer, Spannrolle; mit Zubehör	SK-1582AQ1	BTKW	
1.9 TDI	02/00-11/00	AVB	1896	30x120; mit Spanndämpfer, Spannrolle; mit Zubehör; Baumuster: 3B2	SK-1583	BTK	
1.9 TDI	02/00-11/00	AVB	1896	30x120; mit Spanndämpfer, Spannrolle; mit Zubehör	SK-1583AQ1	BTKW	
1.9 TDI 4motion	08/99-11/00	AJM	1896	30x120; :→AJM185670; mit Spanndämpfer, Spannrolle; mit Zubehör; Baumuster: 3B2	SK-1378	BTK	
1.9 TDI 4motion	08/99-11/00	AJM, ATJ	1896	30x120; :→AJM185670; ohne Spanndämpfer, Spannrolle; mit Zubehör; Baumuster: 3B2	SK-1388	BTK	
1.9 TDI 4motion	08/99-11/00	ATJ	1896	30x120; mit Zubehör	SK-1582	BTK	
1.9 TDI 4motion	08/99-11/00	AJM	1896	30x120; :AJM185671→; mit Zubehör	SK-1582	BTK	
1.9 TDI 4motion	08/99-11/00	ATJ	1896	30x120; mit Spanndämpfer, Spannrolle; mit Zubehör	SK-1583	BTK	
1.9 TDI 4motion	08/99-11/00	AJM	1896	30x120; :AJM185671→; mit Spanndämpfer, Spannrolle; mit Zubehör	SK-1583	BTK	
1.9 TDI Syncro/4motion	10/96-11/00	AFN, AVG	1896	25x137; 05/1997 →; mit Zubehör	SK-1098	BTK	
1.9 TDI, 1.9 TDI 4motion	08/98-11/00	AJM	1896	30x120; :→AJM185670; mit Spanndämpfer, Spannrolle	SK-1378AQ1	BTKW	
1.9 TDI, 1.9 TDI 4motion	08/98-11/00	AJM	1896	30x120; :→AJM185670; ohne Spanndämpfer, Spannrolle; mit Zubehör	SK-1388AQ1	BTKW	



CM³



Art. Nr.



ohne Halter

PASSAT (3B2)							
1.9 TDI, 1.9 TDI 4motion	08/98-11/00	ATJ	1896	30x120; ohne Spanndämpfer, Spannrolle; mit Zubehör	SK-1582AQ1	BTKW	
1.9 TDI, 1.9 TDI 4motion	08/98-11/00	AJM, ATJ, ATJ	1896	30x120; :AJM185671→; ohne Spanndämpfer, Spannrolle; mit Zubehör	SK-1582AQ1	BTKW	
1.9 TDI, 1.9 TDI 4motion	08/98-11/00	ATJ	1896	30x120; mit Spanndämpfer, Spannrolle; mit Zubehör	SK-1583AQ1	BTKW	
1.9 TDI, 1.9 TDI 4motion	08/98-11/00	AJM, ATJ, ATJ	1896	30x120; :AJM185671→; mit Spanndämpfer, Spannrolle; mit Zubehör	SK-1583AQ1	BTKW	
2.5 TDI	07/98-11/00	AFB, AKN	2496	32x207; 24x87; ohne Spanndämpfer, Spannrolle; mit Zubehör; Baumuster: 3B2	SK-1375	BTK	
2.5 TDI	07/98-11/00	AFB, AKN	2496	32x207; 24x87; mit Spanndämpfer, Spannrolle; mit Zubehör	SK-1633	BTK	
2.5 TDI Syncro/4motion	12/98-11/00	AFB, AKN	2496	32x207; 24x87; 08/1999 →; ohne Spanndämpfer, Spannrolle; mit Zubehör; Baumuster: 3B2	SK-1375	BTK	
2.5 TDI Syncro/4motion	12/98-11/00	AFB, AKN	2496	32x207; 24x87; 08/1999 →; mit Spanndämpfer, Spannrolle; mit Zubehör	SK-1633	BTK	
2.5 TDI, 2.5 TDI Syncro/4motion	07/98-11/00	AFB, AKN	2496	30x207; 24x87; mit Spanndämpfer, Spannrolle; mit Zubehör	SK-1621AQ1	BTKW	
2.5 TDI, 2.5 TDI Syncro/4motion	07/98-11/00	AKN	2496	32x207; 24x87; mit Spanndämpfer, Spannrolle; mit Zubehör	SK-1633AQ1	BTKW	
2.8 Syncro	05/97-09/99	AGE	2771	30x253; mit Spanndämpfer, Spannrolle; mit Zubehör	SK-1377	BTK	
2.8 V6	08/96-11/00	AMX, APR, AQD	2771	30x253; 01/1999 →; mit Spanndämpfer, Spannrolle; mit Zubehör; Baumuster: 3B2	SK-1377	BTK	
2.8 V6	08/96-11/00	ACK, AHA, APR, AQD	2771	30x253; 01/1999 →; ohne Spanndämpfer, Spannrolle; mit Zubehör	SK-1383	BTK	
2.8 V6	05/97-09/99	AGE	2771	30x253; mit Spanndämpfer, Spannrolle; mit Zubehör; Baumuster: 3B2	SK-1377	BTK	
2.8 V6	05/97-11/00	AGE, ATX, BBG	2771	30x253; ohne Spanndämpfer, Spannrolle; mit Zubehör	SK-1383	BTK	
2.8 V6	09/99-11/00	ATX	2771	30x253; mit Spanndämpfer, Spannrolle; mit Zubehör; Baumuster: 3B2	SK-1377	BTK	
2.8 V6 Syncro/4motion	10/96-11/00	ACK, ALC, AMX, APR	2771	30x253; 06/1997 →; mit Spanndämpfer, Spannrolle; mit Zubehör; Baumuster: 3B2	SK-1377	BTK	
2.8 V6 Syncro/4motion	10/96-11/00	ACK, AHA, ALG, APR, AQD	2771	30x253; 06/1997 →; ohne Spanndämpfer, Spannrolle; mit Zubehör	SK-1383	BTK	
2.8 V6, 2.8 V6 Syncro/4motion	08/96-11/00	ACK, AHA, ALG, APR, AQD, ACK, AHA, APR, AQD, AGE, ATX, BBG	2771	30x253; mit Spanndämpfer, Spannrolle; mit Zubehör	SK-1377AQ1	BTKW	
2.8 V6, 2.8 V6 Syncro/4motion	08/96-11/00	ACK, AHA, ALG, APR, AQD, ACK, AHA, APR, AQD, AGE	2771	30x253; ch.→3B-X-500000; mit Zubehör	SK-1383AQ1	BTKW	
1.6	10/96-11/00	ADP	1595		0-N132	TB [TE]	
1.6	10/96-11/00	AHL, ANA, ARM	1595		0-N157	TB [TE]	
1.6	10/96-11/00	ADP, AHL, ANA, ARM	1595		0-N1822	TB [BT]	S
1.8	01/97-11/00	AFY	1781	:010001→	0-N1236	TB [TE]	
1.8	01/97-11/00	AFY	1781	:010001→	0-N1276	TB [BT]	
1.8 T	10/96-11/00	AWT	1781		0-N1050	TB [TE]	
1.8 T	10/96-11/00	AEB	1781		0-N1236	TB [TE]	
1.8 T	10/96-11/00	ANB, APU	1781	:020001→	0-N1236	TB [TE]	
1.8 T	10/96-11/00	AEB	1781		0-N1276	TB [BT]	
1.8 T	10/96-11/00	ANB, APU	1781	:020001→	0-N1276	TB [BT]	
1.8, 1.8 Syncro/4motion, 1.8 T	10/96-11/00	ADR, APT, ARG, AEB, ANB, APU, AFY	1781		0-N131	TB [DG]	
1.8, 1.8 Syncro/4motion, 1.8 T Syncro	10/96-11/00	ADR, APT, ARG, AEB	1781		0-N1236	TB [TE]	
1.8, 1.8 Syncro/4motion, 1.8 T Syncro	10/96-11/00	ADR, APT, ARG, AEB	1781		0-N1276	TB [BT]	
1.8, 1.8 Syncro/4motion, 1.8 T, 1.8 T Syncro	10/96-12/01	ADR, APT, ARG, AEB, AEB, ANB, APU, AFY	1781		0-N1822	TB [BT]	S
1.9 TDI	10/96-11/00	AHU	1896		0-N104	TB [TE]	
1.9 TDI	10/96-11/00	AHH	1896		0-N1332	TB [TE]	
1.9 TDI	02/00-11/00	AVB	1896		0-N1048	TB [TE]	
1.9 TDI	02/00-11/00	AVB	1896		0-N1274	TB [BT]	
1.9 TDI, 1.9 TDI 4motion	08/98-11/00	ATJ	1896		0-N1048	TB [TE]	
1.9 TDI, 1.9 TDI 4motion	08/98-11/00	AJM	1896	:185671→	0-N1048	TB [TE]	
1.9 TDI, 1.9 TDI 4motion	08/98-11/00	AJM	1896	:→185670	0-N1049	TB [BT]	
1.9 TDI, 1.9 TDI 4motion	08/98-11/00	AJM	1896	:→185670; mit Anbaumaterial	0-N1265	TB [TE]	
1.9 TDI, 1.9 TDI 4motion	08/98-11/00	AJM, ATJ, ATJ, AVB	1896		0-N1268	TB [DG]	
1.9 TDI, 1.9 TDI 4motion	08/98-11/00	ATJ	1896		0-N1274	TB [BT]	
1.9 TDI, 1.9 TDI 4motion	08/98-11/00	AJM	1896	:185671→	0-N1274	TB [BT]	
1.9 TDI, 1.9 TDI Syncro/4motion	10/96-11/00	AFN, AVG	1896		0-N104	TB [TE]	
1.9 TDI, 1.9 TDI Syncro/4motion	10/96-11/00	AFN, AVG, AHH, AHU	1896		0-N128	TB [DG]	
2.0, 2.0 4motion	04/00-11/00	ASU, ASU, AUZ	1984		0-N157	TB [TE]	
2.0, 2.0 4motion	04/00-11/00	ASU, ASU, AUZ	1984		0-N1822	TB [BT]	S

CM³

Art. Nr.

**PASSAT (3B2)**

2.5 TDI, 2.5 TDI Syncro/4motion	07/98-11/00	AFB, AKN	2496			0-N1266	TB [TE]	
2.5 TDI, 2.5 TDI Syncro/4motion	07/98-11/00	AFB, AKN	2496			0-N1363	TB [TE]	
2.5 TDI, 2.5 TDI Syncro/4motion	07/98-11/00	AFB, AKN	2496			0-N1364	TB [BT]	
2.5 TDI, 2.5 TDI Syncro/4motion	07/98-11/00	AFB, AKN	2496			0-N168	TB [DG]	
2.5 TDI, 2.5 TDI Syncro/4motion	07/98-11/00	AFB, AKN	2496			0-N201	TB [BT]	
2.8 Syncro, 2.8 V6, 2.8 V6 Syncro/4motion	08/96-11/00	ACK, AHA, ALG, APR, AQD, ACK, AHA, APR, AQD, AGE, ATX, BBG	2771			0-N1238	TB [TE]	
2.8 Syncro, 2.8 V6, 2.8 V6 Syncro/4motion	08/96-11/00	ACK, AHA, ALG, APR, AQD, ACK, AHA, APR, AQD, AGE, ATX, BBG	2771			0-N1275	TB [BT]	
2.8 Syncro, 2.8 V6, 2.8 V6 Syncro/4motion	08/96-11/00	ACK, AHA, ALG, APR, AQD, ACK, AHA, APR, AQD, AGE, ATX, BBG	2771			0-N1371	TB [TE]	
2.8 Syncro, 2.8 V6, 2.8 V6 Syncro/4motion	08/96-11/00	ACK, AHA, ALG, APR, AQD, ACK, AHA, APR, AQD, AGE, ATX, BBG	2771			0-N2001	TB [DG]	
1.6	10/96-11/00	ADP, AHL, ANA, ARM	1595	Rippenanzahl: 4		0-N1317	VB [TE]	S
1.8, 1.8 Syncro/4motion, 1.8 T, 1.8 T Syncro	10/96-11/00	ADR, APT, ARG, AEB, AEB, ANB, APU, AFY	1781	Rippenanzahl: 4		0-N1317	VB [TE]	S
1.9 TDI, 1.9 TDI 4motion	08/98-11/00	AJM, ATJ, ATJ, AVB	1896	Rippenanzahl: 5		0-N1441	VB [BT]	S
1.9 TDI, 1.9 TDI 4motion	08/98-11/00	AJM, ATJ, ATJ, AVB	1896			0-N2047	VB [DG]	
1.9 TDI, 1.9 TDI 4motion	08/98-11/00	AJM, ATJ, ATJ, AVB	1896			0-N2139	VB [VD]	
1.9 TDI, 1.9 TDI 4motion, 1.9 TDI Syncro/4motion	10/96-11/00	AFN, AVG, AHH, AHU, AJM, ATJ, ATJ, AVB	1896	Rippenanzahl: 4		0-N1317	VB [TE]	S
1.9 TDI, 1.9 TDI Syncro/4motion	10/96-11/00	AFN, AVG, AHH, AHU	1896	Rippenanzahl: 5		0-N1432	VB [TE]	S
2.0, 2.0 4motion	04/00-11/00	ASU, ASU, AUZ	1984	Rippenanzahl: 4		0-N1317	VB [TE]	S
2.3 VR5, 2.3 VR5 Syncro/4motion	10/96-11/00	AGZ	2324	✳		0-N1715	VB [DG]	
2.5 TDI, 2.5 TDI Syncro/4motion	07/98-11/00	AFB, AKN	2496			0-N1005	VB [TE]	
2.5 TDI, 2.5 TDI Syncro/4motion	07/98-11/00	AFB, AKN	2496			0-N1308	VB [TE]	
2.5 TDI, 2.5 TDI Syncro/4motion	07/98-11/00	AFB, AKN	2496			0-N1315	VB [DG]	
2.5 TDI, 2.5 TDI Syncro/4motion	07/98-11/00	AFB, AKN	2496	Rippenanzahl: 6		0-N1431	VB [DG]	
2.5 TDI, 2.5 TDI Syncro/4motion	07/98-11/00	AFB, AKN	2496			0-N1947	VB [VD]	
2.5 TDI, 2.5 TDI Syncro/4motion	07/98-11/00	AFB, AKN	2496			0-N2196	VB [BT]	
2.5 TDI, 2.5 TDI Syncro/4motion	07/98-11/00	AFB, AKN	2496			0-N2258	VB [BT]	
2.5 TDI, 2.5 TDI Syncro/4motion	07/98-11/00	AFB, AKN	2496			0-N2417	VB [BT]	
2.8 V6, 2.8 V6 Syncro/4motion	08/96-11/00	ACK, AHA, ALG, APR, AQD, ACK, AHA, APR, AQD	2771			0-N1083	VB [BT]	S

PASSAT Variant (3B5)

1.6	06/97-11/00	ADP	1595	18x121; mit Zubehör		SK-1101	BTK	
1.6	06/97-11/00	AHL, ANA, ARM	1595	23x138		SK-1109	BTK	
1.6	06/97-11/00	AHL, ANA, ARM	1595	23x138		SK-1109AQ1	BTKW	
1.8	06/97-11/00	ADR, APT, ARG	1781	25x153; mit Zubehör; Baumuster: 3B5		SK-1346	BTK	
1.8	06/97-11/00	AFY	1781	25x153; mit Zubehör; Baumuster: 3B5		SK-1346	BTK	
1.8 Syncro/4motion	06/97-11/00	ADR	1781	25x153; mit Zubehör; Baumuster: 3B5		SK-1346	BTK	
1.8 T	06/97-11/00	AEB, AWT	1781	25x153; mit Zubehör; Baumuster: 3B5		SK-1346	BTK	
1.8 T	06/97-11/00	AEB	1781	25x153; mit Spanndämpfer, Spannrolle; mit Zubehör		SK-1638	BTK	
1.8 T	06/97-11/00	AWT	1781	23x150; ohne Spanndämpfer, Spannrolle; mit Zubehör		SK-1640	BTK	
1.8 T	06/97-11/00	AWT	1781	23x150; ohne Spanndämpfer, Spannrolle; mit Zubehör		SK-1640AQ1	BTKW	
1.8, 1.8 Syncro/4motion	06/97-11/00	ADR, APT, ARG, AFY	1781	25x153; mit Spanndämpfer, Spannrolle; mit Zubehör		SK-1638	BTK	
1.9 TDI	06/97-11/00	AHU	1896	25x137; mit Zubehör		SK-1098	BTK	
1.9 TDI	06/97-11/00	AHH, AHU	1896	25x137; ch.3B-V-000001→; 05/1998 → 04/1999; mit Zubehör		SK-1593	BTK	
1.9 TDI	08/98-11/00	AJM	1896	30x120; 01/1999 →; →AJM185670; mit Spanndämpfer, Spannrolle; mit Zubehör; Baumuster: 3B5		SK-1378	BTK	
1.9 TDI	08/98-11/00	AJM, ATJ	1896	30x120; 01/1999 →; →AJM185670; ohne Spanndämpfer, Spannrolle; mit Zubehör; Baumuster: 3B5		SK-1388	BTK	
1.9 TDI	08/98-11/00	ATJ	1896	30x120; 01/1999 →; mit Zubehör		SK-1582	BTK	
1.9 TDI	08/98-11/00	AJM	1896	30x120; 01/1999 →; →AJM185671→; mit Zubehör		SK-1582	BTK	
1.9 TDI	08/98-11/00	ATJ	1896	30x120; 01/1999 →; mit Spanndämpfer, Spannrolle; mit Zubehör		SK-1583	BTK	
1.9 TDI	08/98-11/00	AJM	1896	30x120; 01/1999 →; →AJM185671→; mit Spanndämpfer, Spannrolle; mit Zubehör		SK-1583	BTK	
1.9 TDI	02/00-11/00	AVB	1896	30x120; mit Zubehör; Baumuster: 3B5		SK-1582	BTK	
1.9 TDI	02/00-11/00	AVB	1896	30x120; ohne Spanndämpfer, Spannrolle; mit Zubehör		SK-1582AQ1	BTKW	



CM³



Art. Nr.



ohne Halter

PASSAT Variant (3B5)							
1.9 TDI	02/00-11/00	AVB	1896	30x120; mit Spanndämpfer, Spannrolle; mit Zubehör; Baumuster: 3B5	SK-1583	BTK	
1.9 TDI	02/00-11/00	AVB	1896	30x120; mit Spanndämpfer, Spannrolle; mit Zubehör	SK-1583AQ1	BTKW	
1.9 TDI 4motion	08/99-11/00	ATJ	1896	30x120; :→AJM185670; mit Spanndämpfer, Spannrolle; mit Zubehör; Baumuster: 3B5	SK-1378	BTK	
1.9 TDI 4motion	08/99-11/00	ATJ	1896	30x120; :→AJM185670; ohne Spanndämpfer, Spannrolle; mit Zubehör; Baumuster: 3B5	SK-1388	BTK	
1.9 TDI 4motion	08/99-11/00	ATJ	1896	30x120; :AJM185671→; mit Zubehör	SK-1582	BTK	
1.9 TDI 4motion	08/99-11/00	ATJ	1896	30x120; :AJM185671→; mit Spanndämpfer, Spannrolle; mit Zubehör	SK-1583	BTK	
1.9 TDI, 1.9 TDI 4motion	08/98-11/00	AJM	1896	30x120; :→AJM185670; mit Spanndämpfer, Spannrolle	SK-1378AQ1	BTKW	
1.9 TDI, 1.9 TDI 4motion	08/98-11/00	AJM	1896	30x120; :→AJM185670; ohne Spanndämpfer, Spannrolle; mit Zubehör	SK-1388AQ1	BTKW	
1.9 TDI, 1.9 TDI 4motion	08/98-11/00	ATJ	1896	30x120; ohne Spanndämpfer, Spannrolle; mit Zubehör	SK-1582AQ1	BTKW	
1.9 TDI, 1.9 TDI 4motion	08/98-11/00	AJM, ATJ, ATJ	1896	30x120; :AJM185671→; ohne Spanndämpfer, Spannrolle; mit Zubehör	SK-1582AQ1	BTKW	
1.9 TDI, 1.9 TDI 4motion	08/98-11/00	ATJ	1896	30x120; mit Spanndämpfer, Spannrolle; mit Zubehör	SK-1583AQ1	BTKW	
1.9 TDI, 1.9 TDI 4motion	08/98-11/00	AJM, ATJ, ATJ	1896	30x120; :AJM185671→; mit Spanndämpfer, Spannrolle; mit Zubehör	SK-1583AQ1	BTKW	
1.9 TDI, 1.9 TDI Syncro/4motion	06/97-11/00	AFN, AVG	1896	25x137; mit Zubehör	SK-1098	BTK	
2.5 TDI, 2.5 TDI Syncro/4motion	07/98-11/00	AFB, AKN	2496	32x207; 24x87; ohne Spanndämpfer, Spannrolle; mit Zubehör; Baumuster: 3B5	SK-1375	BTK	
2.5 TDI, 2.5 TDI Syncro/4motion	07/98-11/00	AFB, AKN	2496	30x207; 24x87; mit Spanndämpfer, Spannrolle; mit Zubehör	SK-1621AQ1	BTKW	
2.5 TDI, 2.5 TDI Syncro/4motion	07/98-11/00	AFB, AKN	2496	32x207; 24x87; mit Spanndämpfer, Spannrolle; mit Zubehör	SK-1633	BTK	
2.5 TDI, 2.5 TDI Syncro/4motion	07/98-11/00	AKN	2496	32x207; 24x87; mit Spanndämpfer, Spannrolle; mit Zubehör	SK-1633AQ1	BTKW	
2.8 Syncro	05/97-09/99	AGE	2771	30x253; mit Spanndämpfer, Spannrolle; mit Zubehör	SK-1377	BTK	
2.8 V6	06/97-11/00	AMX, APR, AQD	2771	30x253; 01/1999 →; mit Spanndämpfer, Spannrolle; mit Zubehör; Baumuster: 3B5	SK-1377	BTK	
2.8 V6	06/97-11/00	ACK, AHA, APR, AQD	2771	30x253; 01/1999 →; ohne Spanndämpfer, Spannrolle; mit Zubehör	SK-1383	BTK	
2.8 V6	09/97-09/99	AGE	2771	30x253; mit Spanndämpfer, Spannrolle; mit Zubehör; Baumuster: 3B5	SK-1377	BTK	
2.8 V6	09/99-11/00	ATX	2771	30x253; mit Spanndämpfer, Spannrolle; mit Zubehör; Baumuster: 3B5	SK-1377	BTK	
2.8 V6 Syncro/4motion	06/97-11/00	ACK, ALG, AMX, APR	2771	30x253; mit Spanndämpfer, Spannrolle; mit Zubehör; Baumuster: 3B5	SK-1377	BTK	
2.8 V6, 2.8 V6 Syncro/4motion	06/97-11/00	ACK, AHA, ALG, APR, AQD, ACK, AHA, APR, AQD, AGE, ATX, BBG	2771	30x253; mit Spanndämpfer, Spannrolle; mit Zubehör	SK-1377AQ1	BTKW	
2.8 V6, 2.8 V6 Syncro/4motion	06/97-11/00	ACK, AHA, ALG, APR, AQD, AGE, ATX, BBG	2771	30x253; ohne Spanndämpfer, Spannrolle; mit Zubehör	SK-1383	BTK	
2.8 V6, 2.8 V6 Syncro/4motion	06/97-11/00	ACK, AHA, ALG, APR, AQD, ACK, AHA, APR, AQD, AGE	2771	30x253; ch. →3B-X-500000; mit Zubehör	SK-1383AQ1	BTKW	
1.6	06/97-11/00	ADP	1595		0-N132	TB [TE]	
1.6	06/97-11/00	AHL, ANA, ARM	1595		0-N157	TB [TE]	
1.6	06/97-11/00	ADP, AHL, ANA, ARM	1595		0-N1822	TB [BT]	S
1.8	06/97-11/00	AFY	1781	:010001→	0-N1236	TB [TE]	
1.8	06/97-11/00	AFY	1781	:010001→	0-N1276	TB [BT]	
1.8 T	06/97-11/00	AWT	1781		0-N1050	TB [TE]	
1.8 T	06/97-11/00	AEB	1781		0-N1236	TB [TE]	
1.8 T	06/97-11/00	ANB, APU	1781	:020001→	0-N1236	TB [TE]	
1.8 T	06/97-11/00	AEB	1781		0-N1276	TB [BT]	
1.8 T	06/97-11/00	ANB, APU	1781	:020001→	0-N1276	TB [BT]	
1.8, 1.8 Syncro/4motion	06/97-11/00	ADR, APT, ARG	1781		0-N1236	TB [TE]	
1.8, 1.8 Syncro/4motion	06/97-11/00	ADR, APT, ARG	1781		0-N1276	TB [BT]	
1.8, 1.8 Syncro/4motion, 1.8 T	06/97-11/00	ADR, APT, ARG, AEB, ANB, APU, AFY	1781		0-N131	TB [DG]	
1.8, 1.8 Syncro/4motion, 1.8 T	06/97-12/01	ADR, APT, ARG, AEB, ANB, APU, AFY	1781		0-N1822	TB [BT]	S
1.9 TDI	06/97-11/00	AHU	1896		0-N104	TB [TE]	
1.9 TDI	06/97-11/00	AHH	1896		0-N1332	TB [TE]	
1.9 TDI	08/98-11/00	ATJ	1896		0-N1048	TB [TE]	
1.9 TDI	08/98-11/00	AJM	1896	:185671→	0-N1048	TB [TE]	
1.9 TDI	08/98-11/00	AJM	1896	:→185670	0-N1049	TB [BT]	
1.9 TDI	08/98-11/00	AJM	1896	:→185670; mit Anbaumaterial	0-N1265	TB [TE]	

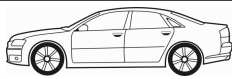

CM³



Art. Nr.



PASSAT Variant (3B5)

1.9 TDI	08/98-11/00	ATJ	1896		0-N1274	TB [BT]	
1.9 TDI	08/98-11/00	AJM	1896	185671 →	0-N1274	TB [BT]	
1.9 TDI	02/00-11/00	AVB	1896		0-N1048	TB [TE]	
1.9 TDI	02/00-11/00	AVB	1896		0-N1274	TB [BT]	
1.9 TDI 4motion	08/99-11/00	ATJ	1896	185671 →	0-N1048	TB [TE]	
1.9 TDI 4motion	08/99-11/00	ATJ	1896	→ 185670	0-N1049	TB [BT]	
1.9 TDI 4motion	08/99-11/00	ATJ	1896	→ 185670; mit Anbaumaterial	0-N1265	TB [TE]	
1.9 TDI 4motion	08/99-11/00	ATJ	1896	185671 →	0-N1274	TB [BT]	
1.9 TDI, 1.9 TDI 4motion	08/98-11/00	AJM, ATJ, ATJ, AVB	1896		0-N1268	TB [DG]	
1.9 TDI, 1.9 TDI Syncro/4motion	06/97-11/00	AFN, AVG	1896		0-N104	TB [TE]	
1.9 TDI, 1.9 TDI Syncro/4motion	06/97-11/00	AFN, AVG, AHH, AHU	1896		0-N128	TB [DG]	
2.0, 2.0 4motion	04/00-11/00	ASU, AUZ	1984		0-N157	TB [TE]	
2.0, 2.0 4motion	04/00-11/00	ASU, AUZ	1984		0-N1822	TB [BT]	S
2.5 TDI, 2.5 TDI Syncro/4motion	07/98-11/00	AFB, AKN	2496		0-N1266	TB [TE]	
2.5 TDI, 2.5 TDI Syncro/4motion	07/98-11/00	AFB, AKN	2496		0-N1363	TB [TE]	
2.5 TDI, 2.5 TDI Syncro/4motion	07/98-11/00	AFB, AKN	2496		0-N1364	TB [BT]	
2.5 TDI, 2.5 TDI Syncro/4motion	07/98-11/00	AFB, AKN	2496		0-N168	TB [DG]	
2.5 TDI, 2.5 TDI Syncro/4motion	07/98-11/00	AFB, AKN	2496		0-N201	TB [BT]	
2.8 Syncro, 2.8 V6, 2.8 V6 Syncro/4motion	05/97-11/00	ACK, AHA, ALG, APR, AQD, ACK, AHA, APR, AQD, AGE, ATX, BBG	2771		0-N1238	TB [TE]	
2.8 Syncro, 2.8 V6, 2.8 V6 Syncro/4motion	05/97-11/00	ACK, AHA, ALG, APR, AQD, ACK, AHA, APR, AQD, AGE, ATX, BBG	2771		0-N1275	TB [BT]	
2.8 Syncro, 2.8 V6, 2.8 V6 Syncro/4motion	05/97-11/00	ACK, AHA, ALG, APR, AQD, ACK, AHA, APR, AQD, AGE, ATX, BBG	2771		0-N1371	TB [TE]	
2.8 Syncro, 2.8 V6, 2.8 V6 Syncro/4motion	05/97-11/00	ACK, AHA, ALG, APR, AQD, ACK, AHA, APR, AQD, AGE, ATX, BBG	2771		0-N2001	TB [DG]	
1.6	06/97-11/00	ADP, AHL, ANA, ARM	1595	Rippenanzahl: 4	0-N1317	VB [TE]	S
1.8, 1.8 Syncro/4motion, 1.8 T	06/97-11/00	ADR, APT, ARG, AEB, ANB, APU, AFY	1781	Rippenanzahl: 4	0-N1317	VB [TE]	S
1.9 TDI, 1.9 TDI 4motion	08/98-11/00	AJM, ATJ, ATJ, AVB	1896	Rippenanzahl: 5	0-N1441	VB [BT]	S
1.9 TDI, 1.9 TDI 4motion	08/98-11/00	AJM, ATJ, ATJ, AVB	1896		0-N2047	VB [DG]	
1.9 TDI, 1.9 TDI 4motion	08/98-11/00	AJM, ATJ, ATJ, AVB	1896		0-N2139	VB [VD]	
1.9 TDI, 1.9 TDI 4motion, 1.9 TDI Syncro/4motion	06/97-11/00	AFN, AVG, AHH, AHU, AJM, ATJ, ATJ, AVB	1896	Rippenanzahl: 4	0-N1317	VB [TE]	S
1.9 TDI, 1.9 TDI Syncro/4motion	06/97-11/00	AFN, AVG, AHH, AHU	1896	Rippenanzahl: 5	0-N1432	VB [TE]	S
2.0, 2.0 4motion	04/00-11/00	ASU, AUZ	1984	Rippenanzahl: 4	0-N1317	VB [TE]	S
2.3 VR5, 2.3 VR5 Syncro/4motion	06/97-11/00	AGZ	2324	*	0-N1715	VB [DG]	
2.5 TDI, 2.5 TDI Syncro/4motion	07/98-11/00	AFB, AKN	2496		0-N1005	VB [TE]	
2.5 TDI, 2.5 TDI Syncro/4motion	07/98-11/00	AFB, AKN	2496		0-N1308	VB [TE]	
2.5 TDI, 2.5 TDI Syncro/4motion	07/98-11/00	AFB, AKN	2496		0-N1315	VB [DG]	
2.5 TDI, 2.5 TDI Syncro/4motion	07/98-11/00	AFB, AKN	2496	Rippenanzahl: 6	0-N1431	VB [DG]	
2.5 TDI, 2.5 TDI Syncro/4motion	07/98-11/00	AFB, AKN	2496		0-N1947	VB [VD]	
2.5 TDI, 2.5 TDI Syncro/4motion	07/98-11/00	AFB, AKN	2496		0-N2196	VB [BT]	
2.5 TDI, 2.5 TDI Syncro/4motion	07/98-11/00	AFB, AKN	2496		0-N2258	VB [BT]	
2.5 TDI, 2.5 TDI Syncro/4motion	07/98-11/00	AFB, AKN	2496		0-N2417	VB [BT]	
2.8 V6, 2.8 V6 Syncro/4motion	06/97-11/00	ACK, AHA, ALG, APR, AQD, ACK, AHA, APR, AQD	2771		0-N1083	VB [BT]	S

PASSAT (3B3)

1.6	11/00-05/05	ALZ	1595	23x138; Baumuster: 3B3	SK-1109	BTK	
1.6	11/00-05/05	ALZ	1595	23x138	SK-1109AQ1	BTKW	
1.8 T 20V	11/00-05/05	ANB, APU, AWT	1781	25x153; mit Zubehör; Baumuster: 3B3	SK-1346	BTK	
1.8 T 20V	11/00-05/05	AWL, AWT	1781	25x153; mit Spanndämpfer, Spannrolle; mit Zubehör	SK-1638	BTK	
1.8 T 20V	11/00-05/05	AWT	1781	23x150; ohne Spanndämpfer, Spannrolle; mit Zubehör	SK-1640	BTK	
1.8 T 20V	11/00-05/05	AWT	1781	23x150; ohne Spanndämpfer, Spannrolle; mit Zubehör	SK-1640AQ1	BTKW	
1.8 T, 1.8 T 20V, 1.8 T 4motion	11/00-05/05	AWL, AWT, AWM	1781	23x150; mit Zubehör	SK-1726	BTK	
1.9 TDI	11/00-05/05	AVF, AWX	1896	30x120; ch.3B-3-000001 →; 2003 →; mit Zubehör	SK-1372	BTK	
1.9 TDI	11/00-05/05	AVF, AWX	1896	30x120; → 07/2002; mit Zubehör; Baumuster: 3B3	SK-1582	BTK	
1.9 TDI	11/00-05/05	AVF, AWX	1896	30x120; → 07/2002; mit Spanndämpfer, Spannrolle; mit Zubehör; Baumuster: 3B3	SK-1583	BTK	
1.9 TDI, 1.9 TDI 4motion	11/00-05/05	AVB, AVF	1896	30x120; ch.3B-3-000001 →; 2003 →; mit Zubehör	SK-1372	BTK	
1.9 TDI, 1.9 TDI 4motion	11/00-05/05	AVB, AVF, AVF, AWX	1896	30x120; 08/2002 →	SK-1372AQ2	BTKW	
1.9 TDI, 1.9 TDI 4motion	11/00-05/05	AVB, AVF	1896	30x120; → 07/2002; mit Zubehör; Baumuster: 3B3	SK-1582	BTK	

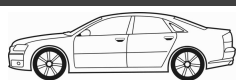

CM³



Art. Nr.



PASSAT (3B3)							
1.9 TDI, 1.9 TDI 4motion	11/00-05/05	AVB, AVF, AVF, AWX	1896	30x120; → 07/2002; ohne Spanndämpfer, Spannrolle; mit Zubehör	SK-1582AQ1	BTKW	
1.9 TDI, 1.9 TDI 4motion	11/00-05/05	AVB, AVF	1896	30x120; → 07/2002; mit Spanndämpfer, Spannrolle; mit Zubehör; Baumuster: 3B3	SK-1583	BTK	
1.9 TDI, 1.9 TDI 4motion	11/00-05/05	AVB, AVF, AVF, AWX	1896	30x120; → 07/2002; mit Spanndämpfer, Spannrolle; mit Zubehör	SK-1583AQ1	BTKW	
2.0	11/00-05/05	AZM	1984	23x138; Baumuster: 3B3	SK-1109	BTK	
2.0	11/01-05/05	ALT	1984	23x150; ohne Spanndämpfer, Spannrolle; mit Zubehör	SK-1640	BTK	
2.0	11/01-05/05	ALT	1984	23x150; ohne Spanndämpfer, Spannrolle; mit Zubehör	SK-1640AQ2	BTKW	
2.0	11/01-05/05	ALT	1984	23x150; mit Zubehör	SK-1726	BTK	
2.0	11/01-05/05	ALT	1984	23x150; mit Zubehör	SK-1726AQ2	BTKW	
2.0 4motion	11/00-05/05	AZM	1984	23x138; Baumuster: 3B3	SK-1109	BTK	
2.0 TDI	12/03-05/05	BGW	1968	30x120; mit Zubehör	SK-1372	BTK	
2.0 TDI	12/03-05/05	BGW, BHW	1968	30x120	SK-1372AQ2	BTKW	
2.0, 2.0 4motion	11/00-05/05	AZM, AZM, BFF	1984	23x138	SK-1109AQ2	BTKW	
2.5 TDI	05/03-05/05	BDG	2496	30x207; 24x87; ohne Spanndämpfer, Spannrolle; mit Zubehör; Baumuster: 3B3	SK-1619	BTK	
2.5 TDI	05/03-05/05	BDG	2496	30x207; 24x87; mit Spanndämpfer, Spannrolle; mit Zubehör; Baumuster: 3B3	SK-1621	BTK	
2.5 TDI 4motion	01/03-05/05	BAU, BDH	2496	30x207; 24x87; ohne Spanndämpfer, Spannrolle; mit Zubehör; Baumuster: 3B3	SK-1619	BTK	
2.5 TDI 4motion	01/03-05/05	BAU, BDH	2496	30x207; 24x87; mit Spanndämpfer, Spannrolle; mit Zubehör; Baumuster: 3B3	SK-1621	BTK	
2.5 TDI, 2.5 TDI 4motion	11/00-05/05	AFB, AKN	2496	32x207; 24x87; ohne Spanndämpfer, Spannrolle; mit Zubehör; Baumuster: 3B3	SK-1375	BTK	
2.5 TDI, 2.5 TDI 4motion	11/00-05/05	AFB, AKN, BAU, BDH, BDG	2496	30x207; 24x87; mit Spanndämpfer, Spannrolle; mit Zubehör	SK-1621AQ1	BTKW	
2.5 TDI, 2.5 TDI 4motion	11/00-05/05	AFB, AKN	2496	32x207; 24x87; mit Spanndämpfer, Spannrolle; mit Zubehör	SK-1633	BTK	
2.5 TDI, 2.5 TDI 4motion	11/00-05/05	AKN	2496	32x207; 24x87; mit Spanndämpfer, Spannrolle; mit Zubehör	SK-1633AQ1	BTKW	
2.5 TDI, 2.5 TDI 4motion	01/03-05/05	BAU, BDH, BDG	2496	30x207; 24x87; nur in Verbindung mit: 078 121 113 F; mit Zubehör	SK-1619AQ2	BTKW	
2.5 TDI, 2.5 TDI 4motion	01/03-05/05	BAU, BDH, BDG	2496	32x207; 24x87; mit Spanndämpfer, Spannrolle; mit Zubehör	SK-1633AQ1	BTKW	
2.8 4motion	11/00-05/05	AMX, APR, ATQ	2771	30x253; mit Spanndämpfer, Spannrolle; mit Zubehör; Baumuster: 3B3	SK-1377	BTK	
2.8 4motion	11/00-05/05	AMX, ATQ	2771	30x253; mit Spanndämpfer, Spannrolle; mit Zubehör	SK-1377AQ1	BTKW	
2.8 4motion	11/00-05/05	AMX, ATQ	2771	30x253; ohne Spanndämpfer, Spannrolle; mit Zubehör	SK-1383	BTK	
1.6	11/00-05/05	ALZ	1595		0-N157	TB [TE]	
1.6	11/00-05/05	ALZ	1595		0-N1822	TB [BT]	S
1.8	03/03-03/05	APT	1781		0-N1236	TB [TE]	
1.8	03/03-03/05	APT	1781		0-N1276	TB [BT]	
1.8	03/03-03/05	APT	1781		0-N131	TB [DG]	
1.8 T 20V	11/00-05/05	AWT	1781		0-N1050	TB [TE]	
1.8 T 20V	11/00-05/05	AWT	1781		0-N1051	TB [BT]	S
1.8 T, 1.8 T 20V, 1.8 T 4motion	11/00-05/05	AWL, AWT, AWM	1781		0-N1316	TB [DG]	
1.8 T, 1.8 T 4motion	02/01-05/05	AWM	1781		0-N1051	TB [BT]	S
1.8, 1.8 T, 1.8 T 20V, 1.8 T 4motion	11/00-05/05	APT, AWL, AWT, AWM	1781		0-N1822	TB [BT]	S
1.9 TDI, 1.9 TDI 4motion	11/00-05/05	AVB, AVF, AVF, AWX	1896	01/2003 →	0-N1045	TB [TE]	
1.9 TDI, 1.9 TDI 4motion	11/00-05/05	AVB, AVF, AVF, AWX	1896	01/2003 →	0-N1046	TB [DG]	
1.9 TDI, 1.9 TDI 4motion	11/00-05/05	AVB, AVF, AVF, AWX	1896	→ 12/2002	0-N1048	TB [TE]	
1.9 TDI, 1.9 TDI 4motion	11/00-05/05	AVB, AVF, AVF, AWX	1896	→ 12/2002	0-N1268	TB [DG]	
1.9 TDI, 1.9 TDI 4motion	11/00-05/05	AVB, AVF, AVF, AWX	1896	→ 12/2002	0-N1274	TB [BT]	
2.0	11/01-05/05	ALT	1984		0-N1050	TB [TE]	
2.0	11/01-05/05	ALT	1984		0-N1051	TB [BT]	S
2.0	11/01-05/05	ALT	1984		0-N1316	TB [DG]	
2.0 TDI	12/03-05/05	BGW	1968		0-N1045	TB [TE]	
2.0 TDI	12/03-05/05	BGW, BHW	1968		0-N1046	TB [DG]	
2.0, 2.0 4motion	11/00-05/05	AZM, AZM, BFF	1984		0-N157	TB [TE]	
2.0, 2.0 4motion	11/00-05/05	ALT, AZM, AZM, BFF	1984		0-N1822	TB [BT]	S
2.5 TDI, 2.5 TDI 4motion	11/00-05/05	AFB, AKN, BAU, BDH, BDG	2496		0-N1266	TB [TE]	
2.5 TDI, 2.5 TDI 4motion	11/00-05/05	AFB, AKN, BAU, BDH, BDG	2496		0-N1363	TB [TE]	
2.5 TDI, 2.5 TDI 4motion	11/00-05/05	AFB, AKN, BAU, BDH, BDG	2496		0-N1364	TB [BT]	
2.5 TDI, 2.5 TDI 4motion	11/00-05/05	AFB, AKN, BAU, BDH, BDG	2496		0-N168	TB [DG]	
2.5 TDI, 2.5 TDI 4motion	11/00-05/05	AFB, AKN, BAU, BDH, BDG	2496		0-N201	TB [BT]	

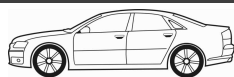

CM³



Art. Nr.



PASSAT (3B3)							
2.8 4motion	11/00-05/05	AMX, ATQ	2771			0-N1238	TB [TE]
2.8 4motion	11/00-05/05	AMX, ATQ	2771			0-N1275	TB [BT]
2.8 4motion	11/00-05/05	AMX, ATQ	2771			0-N1371	TB [TE]
2.8 4motion	11/00-05/05	AMX, ATQ	2771			0-N2001	TB [DG]
1.6	11/00-05/05	ALZ	1595	Rippenanzahl: 4		0-N1317	VB [TE] S
1.8, 1.8 T, 1.8 T 20V, 1.8 T 4motion	11/00-05/05	APT, AWL, AWT, AWM	1781	Rippenanzahl: 4		0-N1317	VB [TE] S
1.9 TDI, 1.9 TDI 4motion	11/00-05/05	AVB, AVF, AVF, AWX	1896	Rippenanzahl: 4		0-N1317	VB [TE] S
1.9 TDI, 1.9 TDI 4motion	11/00-05/05	AVB, AVF, AVF, AWX	1896	Rippenanzahl: 5		0-N1441	VB [BT] S
1.9 TDI, 1.9 TDI 4motion	11/00-05/05	AVB, AVF, AVF, AWX	1896			0-N2047	VB [DG]
1.9 TDI, 1.9 TDI 4motion	11/00-05/05	AVB, AVF, AVF, AWX	1896			0-N2139	VB [VD]
2.0 TDI	12/03-05/05	BGW	1968	Rippenanzahl: 4		0-N1317	VB [TE] S
2.0 TDI	12/03-05/05	BGW, BHW	1968	Rippenanzahl: 5		0-N1441	VB [BT] S
2.0 TDI	12/03-05/05	BGW, BHW	1968			0-N2047	VB [DG]
2.0 TDI	12/03-05/05	BGW, BHW	1968			0-N2139	VB [VD]
2.0, 2.0 4motion	11/00-05/05	ALT, AZM, AZM, BFF	1984	Rippenanzahl: 4		0-N1317	VB [TE] S
2.3 V5, 2.3 V5 4motion	11/00-05/05	AZX	2324	*		0-N1715	VB [DG]
2.5 TDI, 2.5 TDI 4motion	11/00-05/05	AFB, AKN, BAU, BDH, BDG	2496			0-N1005	VB [TE]
2.5 TDI, 2.5 TDI 4motion	11/00-05/05	AFB, AKN, BAU, BDH, BDG	2496			0-N1308	VB [TE]
2.5 TDI, 2.5 TDI 4motion	11/00-05/05	AFB, AKN, BAU, BDH, BDG	2496			0-N1315	VB [DG]
2.5 TDI, 2.5 TDI 4motion	11/00-05/05	AFB, AKN, BAU, BDH, BDG	2496	Rippenanzahl: 6		0-N1431	VB [DG]
2.5 TDI, 2.5 TDI 4motion	11/00-05/05	AFB, AKN, BAU, BDH, BDG	2496			0-N1947	VB [VD]
2.5 TDI, 2.5 TDI 4motion	11/00-05/05	AFB, AKN, BAU, BDH, BDG	2496			0-N2196	VB [BT]
2.5 TDI, 2.5 TDI 4motion	11/00-05/05	AFB, AKN, BAU, BDH, BDG	2496			0-N2258	VB [BT]
2.5 TDI, 2.5 TDI 4motion	11/00-05/05	AFB, AKN, BAU, BDH, BDG	2496			0-N2417	VB [BT]
2.8 4motion	11/00-05/05	AMX, ATQ	2771			0-N1083	VB [BT] S
4.0 W8 4motion	09/01-09/04	BDN, BDP, BDP	3999	Rippenanzahl: 7		0-N2127	VB [DG]

PASSAT Variant (3B6)							
1.6	11/00-05/05	ALZ	1595	23x138; Baumuster: 3B6		SK-1109	BTK
1.6	11/00-05/05	ALZ	1595	23x138		SK-1109AQ1	BTKW
1.8 4motion, 1.8 T, 1.8 T 20V	11/00-08/05	AWM, AWT	1781	23x150; mit Zubehör		SK-1726	BTK
1.8 T 20V	11/00-05/05	AWT	1781	25x153; mit Zubehör; Baumuster: 3B6		SK-1346	BTK
1.8 T 20V	11/00-05/05	AWT	1781	25x153; mit Spanndämpfer, Spannrolle; mit Zubehör		SK-1638	BTK
1.8 T 20V	11/00-05/05	AWT	1781	23x150; ohne Spanndämpfer, Spannrolle; mit Zubehör		SK-1640	BTK
1.8 T 20V	11/00-05/05	AWT	1781	23x150; ohne Spanndämpfer, Spannrolle; mit Zubehör		SK-1640AQ1	BTKW
1.9 TDI	11/00-05/05	AVF, AWX	1896	30x120; ch.3B-3-000001→; 2003→; mit Zubehör		SK-1372	BTK
1.9 TDI	11/00-05/05	AVF, AWX	1896	30x120; → 07/2002; mit Zubehör; Baumuster: 3B6		SK-1582	BTK
1.9 TDI	11/00-05/05	AVF, AWX	1896	30x120; → 07/2002; mit Spanndämpfer, Spannrolle; mit Zubehör; Baumuster: 3B6		SK-1583	BTK
1.9 TDI, 1.9 TDI 4motion	11/00-05/05	AVB, AVF	1896	30x120; ch.3B-3-000001→; 2003→; mit Zubehör		SK-1372	BTK
1.9 TDI, 1.9 TDI 4motion	11/00-05/05	AVB, AVF, AVF, AWX	1896	30x120; 08/2002 →		SK-1372AQ2	BTKW
1.9 TDI, 1.9 TDI 4motion	11/00-05/05	AVB, AVF	1896	30x120; → 07/2002; mit Zubehör; Baumuster: 3B6		SK-1582	BTK
1.9 TDI, 1.9 TDI 4motion	11/00-05/05	AVB, AVF, AVF, AWX	1896	30x120; → 07/2002; ohne Spanndämpfer, Spannrolle; mit Zubehör		SK-1582AQ1	BTKW
1.9 TDI, 1.9 TDI 4motion	11/00-05/05	AVB, AVF	1896	30x120; → 07/2002; mit Spanndämpfer, Spannrolle; mit Zubehör; Baumuster: 3B6		SK-1583	BTK
1.9 TDI, 1.9 TDI 4motion	11/00-05/05	AVB, AVF, AVF, AWX	1896	30x120; → 07/2002; mit Spanndämpfer, Spannrolle; mit Zubehör		SK-1583AQ1	BTKW
2.0	11/01-05/05	ALT	1984	23x150; ohne Spanndämpfer, Spannrolle; mit Zubehör		SK-1640	BTK
2.0	11/01-05/05	ALT	1984	23x150; ohne Spanndämpfer, Spannrolle; mit Zubehör		SK-1640AQ2	BTKW
2.0	11/01-05/05	ALT	1984	23x150; mit Zubehör		SK-1726	BTK
2.0	11/01-05/05	ALT	1984	23x150; mit Zubehör		SK-1726AQ2	BTKW
2.0 TDI	12/03-05/05	BGW	1968	30x120; mit Zubehör		SK-1372	BTK
2.0 TDI	12/03-05/05	BGW, BHW	1968	30x120		SK-1372AQ2	BTKW
2.0, 2.0 4motion	11/00-05/05	AZM	1984	23x138; Baumuster: 3B6		SK-1109	BTK
2.0, 2.0 4motion	11/00-05/05	AZM	1984	23x138		SK-1109AQ2	BTKW
2.5 TDI	05/03-05/05	BDG	2496	30x207; 24x87; ohne Spanndämpfer, Spannrolle; mit Zubehör; Baumuster: 3B6		SK-1619	BTK
2.5 TDI	05/03-05/05	BDG	2496	30x207; 24x87; mit Spanndämpfer, Spannrolle; mit Zubehör; Baumuster: 3B6		SK-1621	BTK

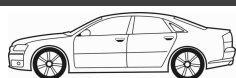

CM³



Art. Nr.



PASSAT Variant (3B6)

2.5 TDI 4motion	01/03-05/05	BAU, BDH	2496	30x207; 24x87; ohne Spanndämpfer, Spannrolle; mit Zubehör; Baumuster: 3B6	SK-1619	BTK	
2.5 TDI 4motion	01/03-05/05	BAU, BDH	2496	30x207; 24x87; mit Spanndämpfer, Spannrolle; mit Zubehör; Baumuster: 3B6	SK-1621	BTK	
2.5 TDI, 2.5 TDI 4motion	11/00-05/05	AFB, AKN	2496	32x207; 24x87; ohne Spanndämpfer, Spannrolle; mit Zubehör; Baumuster: 3B6	SK-1375	BTK	
2.5 TDI, 2.5 TDI 4motion	11/00-05/05	AFB, AKN, BAU, BDH, BDG	2496	30x207; 24x87; mit Spanndämpfer, Spannrolle; mit Zubehör	SK-1621AQ1	BTKW	
2.5 TDI, 2.5 TDI 4motion	11/00-05/05	AFB, AKN	2496	32x207; 24x87; mit Spanndämpfer, Spannrolle; mit Zubehör	SK-1633	BTK	
2.5 TDI, 2.5 TDI 4motion	11/00-05/05	AKN	2496	32x207; 24x87; mit Spanndämpfer, Spannrolle; mit Zubehör	SK-1633AQ1	BTKW	
2.5 TDI, 2.5 TDI 4motion	01/03-05/05	BAU, BDH, BDG	2496	30x207; 24x87; nur in Verbindung mit: 078 121 113 F; mit Zubehör	SK-1619AQ2	BTKW	
2.5 TDI, 2.5 TDI 4motion	01/03-05/05	BAU, BDH, BDG	2496	32x207; 24x87; mit Spanndämpfer, Spannrolle; mit Zubehör	SK-1633AQ1	BTKW	
2.8 4motion	11/00-05/05	AMX, APR, ATQ	2771	30x253; mit Spanndämpfer, Spannrolle; mit Zubehör; Baumuster: 3B6	SK-1377	BTK	
2.8 4motion	11/00-05/05	AMX, ATQ	2771	30x253; mit Spanndämpfer, Spannrolle; mit Zubehör	SK-1377AQ1	BTKW	
2.8 4motion	11/00-05/05	AMX, ATQ	2771	30x253; ohne Spanndämpfer, Spannrolle; mit Zubehör	SK-1383	BTK	
1.6	11/00-05/05	ALZ	1595		0-N157	TB [TE]	
1.6	11/00-05/05	ALZ	1595		0-N1822	TB [BT]	S
1.8 4motion, 1.8 T, 1.8 T 20V	11/00-08/05	AWM, AWT	1781		0-N1051	TB [BT]	S
1.8 4motion, 1.8 T, 1.8 T 20V	11/00-08/05	AWM, AWT	1781		0-N1316	TB [DG]	
1.8 4motion, 1.8 T, 1.8 T 20V	11/00-08/05	AWM, AWT	1781		0-N1822	TB [BT]	S
1.8 T 20V	11/00-05/05	AWT	1781		0-N1050	TB [TE]	
1.9 TDI, 1.9 TDI 4motion	11/00-05/05	AVB, AVF, AVF, AWX	1896	01/2003 →	0-N1045	TB [TE]	
1.9 TDI, 1.9 TDI 4motion	11/00-05/05	AVB, AVF, AVF, AWX	1896	01/2003 →	0-N1046	TB [DG]	
1.9 TDI, 1.9 TDI 4motion	11/00-05/05	AVB, AVF, AVF, AWX	1896	→ 12/2002	0-N1048	TB [TE]	
1.9 TDI, 1.9 TDI 4motion	11/00-05/05	AVB, AVF, AVF, AWX	1896	→ 12/2002	0-N1268	TB [DG]	
1.9 TDI, 1.9 TDI 4motion	11/00-05/05	AVB, AVF, AVF, AWX	1896	→ 12/2002	0-N1274	TB [BT]	
2.0	11/01-05/05	ALT	1984		0-N1050	TB [TE]	
2.0	11/01-05/05	ALT	1984		0-N1051	TB [BT]	S
2.0	11/01-05/05	ALT	1984		0-N1316	TB [DG]	
2.0 TDI	12/03-05/05	BGW	1968		0-N1045	TB [TE]	
2.0 TDI	12/03-05/05	BGW, BHW	1968		0-N1046	TB [DG]	
2.0, 2.0 4motion	11/00-05/05	AZM	1984		0-N157	TB [TE]	
2.0, 2.0 4motion	11/00-05/05	ALT, AZM	1984		0-N1822	TB [BT]	S
2.5 TDI, 2.5 TDI 4motion	11/00-05/05	AFB, AKN, BAU, BDH, BDG	2496		0-N1266	TB [TE]	
2.5 TDI, 2.5 TDI 4motion	11/00-05/05	AFB, AKN, BAU, BDH, BDG	2496		0-N1363	TB [TE]	
2.5 TDI, 2.5 TDI 4motion	11/00-05/05	AFB, AKN, BAU, BDH, BDG	2496		0-N1364	TB [BT]	
2.5 TDI, 2.5 TDI 4motion	11/00-05/05	AFB, AKN, BAU, BDH, BDG	2496		0-N168	TB [DG]	
2.5 TDI, 2.5 TDI 4motion	11/00-05/05	AFB, AKN, BAU, BDH, BDG	2496		0-N201	TB [BT]	
2.8 4motion	11/00-05/05	AMX, ATQ	2771		0-N1238	TB [TE]	
2.8 4motion	11/00-05/05	AMX, ATQ	2771		0-N1275	TB [BT]	
2.8 4motion	11/00-05/05	AMX, ATQ	2771		0-N1371	TB [TE]	
2.8 4motion	11/00-05/05	AMX, ATQ	2771		0-N2001	TB [DG]	
1.6	11/00-05/05	ALZ	1595	Rippenanzahl: 4	0-N1317	VB [TE]	S
1.8 4motion, 1.8 T, 1.8 T 20V	11/00-08/05	AWM, AWT	1781	Rippenanzahl: 4	0-N1317	VB [TE]	S
1.9 TDI, 1.9 TDI 4motion	11/00-05/05	AVB, AVF, AVF, AWX	1896	Rippenanzahl: 4	0-N1317	VB [TE]	S
1.9 TDI, 1.9 TDI 4motion	11/00-05/05	AVB, AVF, AVF, AWX	1896	Rippenanzahl: 5	0-N1441	VB [BT]	S
1.9 TDI, 1.9 TDI 4motion	11/00-05/05	AVB, AVF, AVF, AWX	1896		0-N2047	VB [DG]	
1.9 TDI, 1.9 TDI 4motion	11/00-05/05	AVB, AVF, AVF, AWX	1896		0-N2139	VB [VD]	
2.0 TDI	12/03-05/05	BGW, BHW	1968	Rippenanzahl: 4	0-N1317	VB [TE]	S
2.0 TDI	12/03-05/05	BGW, BHW	1968	Rippenanzahl: 5	0-N1441	VB [BT]	S
2.0 TDI	12/03-05/05	BGW, BHW	1968		0-N2047	VB [DG]	
2.0 TDI	12/03-05/05	BGW, BHW	1968		0-N2139	VB [VD]	
2.0, 2.0 4motion	11/00-05/05	ALT, AZM	1984	Rippenanzahl: 4	0-N1317	VB [TE]	S
2.3 VR5, 2.3 VR5 4motion	11/00-05/05	AZX	2324	*	0-N1715	VB [DG]	
2.5 TDI, 2.5 TDI 4motion	11/00-05/05	AFB, AKN, BAU, BDH, BDG	2496		0-N1005	VB [TE]	
2.5 TDI, 2.5 TDI 4motion	11/00-05/05	AFB, AKN, BAU, BDH, BDG	2496		0-N1308	VB [TE]	
2.5 TDI, 2.5 TDI 4motion	11/00-05/05	AFB, AKN, BAU, BDH, BDG	2496		0-N1315	VB [DG]	
2.5 TDI, 2.5 TDI 4motion	11/00-05/05	AFB, AKN, BAU, BDH, BDG	2496	Rippenanzahl: 6	0-N1431	VB [DG]	
2.5 TDI, 2.5 TDI 4motion	11/00-05/05	AFB, AKN, BAU, BDH, BDG	2496		0-N1947	VB [VD]	
2.5 TDI, 2.5 TDI 4motion	11/00-05/05	AFB, AKN, BAU, BDH, BDG	2496		0-N2196	VB [BT]	
2.5 TDI, 2.5 TDI 4motion	11/00-05/05	AFB, AKN, BAU, BDH, BDG	2496		0-N2258	VB [BT]	



CM³



Art. Nr.



ohne Halter

PASSAT Variant (3B6)

2.5 TDI, 2.5 TDI 4motion	11/00-05/05	AFB, AKN, BAU, BDH, BDG	2496		0-N2417	VB [BT]	
2.8 4motion	11/00-05/05	AMX, ATQ	2771		0-N1083	VB [BT]	S
4.0 W8 4motion	09/01-09/04	BDN, BDP, BDP	3999	Rippenanzahl: 7	0-N2127	VB [DG]	

PASSAT (3C2)

1.6	05/05-07/10	BSE, BSF	1595	23x138; Baumuster: 3C2	SK-1109	BTK	
1.6	05/05-07/10	BSE, BSF	1595	23x138	SK-1109AQ1	BTKW	
1.6 TDI	08/09-07/10	CAYC	1598	25x160	SK-1695	BTK	
1.6 TDI	08/09-07/10	CAYC	1598	25x160	SK-1695AQ1	BTKW	
1.6 TDI	08/09-07/10	CAYC	1598	25x160; ch.→3C-B-050000	SK-1727AQ1	BTKW	
1.6 TDI	08/09-07/10	CAYC	1598	25x160; ch.3C-B-200 001→	SK-1727AQ2	BTKW	
1.9 TDI	03/05-11/08	BKC, BLS, BXE	1896	30x120; mit Zubehör	SK-1372	BTK	
1.9 TDI	03/05-11/08	BKC, BLS, BXE	1896	30x120	SK-1372AQ1	BTKW	
2.0 BlueTDI, 2.0 TDI	11/08-11/10	CBAC, CBDC	1968	30x160	SK-1694AQ1	BTKW	
2.0 BlueTDI, 2.0 TDI 4motion	01/09-11/10	CBAC, CBBB	1968	30x160; → 11/2010	SK-1694	BTK	
2.0 FSI	07/05-07/10	AXX, BPY, BWA	1984	23x148	SK-1724	BTK	
2.0 FSI	07/05-07/10	AXX, BPY, BWA	1984	23x148	SK-1724AQ1	BTKW	
2.0 FSI, 2.0 FSI 4motion	03/05-07/10	BLR, BLY, BVY, BVZ, BLX, BLY, BVX	1984	23x148	SK-1724	BTK	
2.0 FSI, 2.0 FSI 4motion	03/05-07/10	BLR, BLY, BVY, BVZ, BLX, BLY, BVX	1984	23x148	SK-1724AQ2	BTKW	
2.0 TDI	03/05-11/10	BMA	1968	30x141; ch.→3C-6-300000; mit Zubehör	SK-1595	BTK	
2.0 TDI	03/05-11/10	BMA	1968	30x141; ch.→3C-6-300000; mit Zubehör	SK-1595AQ1	BTKW	
2.0 TDI	03/05-11/10	BMA	1968	30x141; ch.3C-7-000001→; mit Zubehör	SK-1668	BTK	
2.0 TDI	03/05-11/10	BMA	1968	30x141; ch.3C-7-000001→	SK-1668AQ1	BTKW	
2.0 TDI	03/05-11/10	CBAA	1968	30x160; → 11/2009	SK-1694	BTK	
2.0 TDI	03/05-11/10	CBAA	1968	30x160	SK-1694AQ1	BTKW	
2.0 TDI	08/05-05/09	BUZ, BVE, BWV	1968	30x141; ch.→3C-6-300000; mit Zubehör	SK-1595	BTK	
2.0 TDI	08/05-07/10	BMR	1968	30x141; ch.→3C-6-300000; 02/2006 →; mit Zubehör	SK-1595	BTK	
2.0 TDI	08/05-05/09	BUZ, BVE, BWV	1968	30x141; ch.→3C-6-300000; mit Zubehör	SK-1595AQ1	BTKW	
2.0 TDI	08/05-07/10	BMR	1968	30x141; ch.→3C-6-300000; mit Zubehör	SK-1595AQ1	BTKW	
2.0 TDI	08/05-05/09	BUZ, BVE, BWV	1968	30x141; ch.3C-7-000001→; mit Zubehör	SK-1668	BTK	
2.0 TDI	08/05-07/10	BMR	1968	30x141; ch.3C-7-000001→; 02/2006 →; mit Zubehör	SK-1668	BTK	
2.0 TDI	08/05-05/09	BUZ, BVE, BWV	1968	30x141; ch.3C-7-000001→	SK-1668AQ1	BTKW	
2.0 TDI	08/05-07/10	BMR	1968	30x141; ch.3C-7-000001→	SK-1668AQ1	BTKW	
2.0 TDI	08/05-07/10	CBBB	1968	30x160; 02/2006 → 11/2010	SK-1694	BTK	
2.0 TDI	08/05-07/10	CBBB	1968	30x160	SK-1694AQ2	BTKW	
2.0 TDI	11/08-07/10	CBDC	1968	30x160	SK-1694	BTK	
2.0 TDI 16V, 2.0 TDI 16V 4motion	03/05-08/10	BKP	1968	30x141; ch.→3C-6-300000; mit Zubehör	SK-1595	BTK	
2.0 TDI 16V, 2.0 TDI 16V 4motion	03/05-08/10	BKP	1968	30x141; ch.→3C-6-300000; mit Zubehör	SK-1595AQ1	BTKW	
2.0 TDI 16V, 2.0 TDI 16V 4motion	03/05-08/10	BKP	1968	30x141; ch.3C-7-000001→; mit Zubehör	SK-1668	BTK	
2.0 TDI 16V, 2.0 TDI 16V 4motion	03/05-08/10	BKP	1968	30x141; ch.3C-7-000001→	SK-1668AQ1	BTKW	
2.0 TDI 16V, 2.0 TDI 16V 4motion	03/05-08/10	CBAB	1968	30x160; → 07/2010	SK-1694	BTK	
2.0 TDI 16V, 2.0 TDI 16V 4motion	03/05-08/10	CBAB	1968	30x160	SK-1694AQ1	BTKW	
2.0 TDI 4motion	05/09-07/10	CBBB	1968	30x160	SK-1694AQ2	BTKW	
2.0 TDI, 2.0 TDI 4motion	03/05-05/09	BMP	1968	30x120; mit Zubehör	SK-1372	BTK	
2.0 TDI, 2.0 TDI 4motion	03/05-05/09	BMP	1968	30x120	SK-1372AQ2	BTKW	
1.6	05/05-07/10	BSE, BSF	1595		0-N157	TB [TE]	
1.6 TDI	08/09-07/10	CAYC	1598		0-N131	TB [DG]	
1.6 TDI	08/09-07/10	CAYC	1598		0-N2025	TB [DG]	
1.6 TDI	08/09-07/10	CAYC	1598		0-N2200	TB [DG]	
1.9 TDI	03/05-11/08	BKC, BLS, BXE	1896		0-N1045	TB [TE]	
1.9 TDI	03/05-11/08	BKC, BLS, BXE	1896		0-N1046	TB [DG]	
2.0 BlueTDI, 2.0 TDI, 2.0 TDI 16V 4motion, 2.0 TDI 4motion	03/05-11/10	BKP, CBAB, BMP, BUZ, BVE, BWV, CBAC, CBBB, CBDC	1968		0-N1046	TB [DG]	
2.0 BlueTDI, 2.0 TDI, 2.0 TDI 4motion	11/08-11/10	CBAC, CBBB, CBDC	1968		0-N1268	TB [DG]	
2.0 BlueTDI, 2.0 TDI, 2.0 TDI 4motion	11/08-11/10	CBAC, CBBB, CBDC	1968		0-N1336	TB [DG]	
2.0 BlueTDI, 2.0 TDI, 2.0 TDI 4motion	11/08-11/10	CBAC, CBBB, CBDC	1968		0-N1905	TB [BT]	
2.0 FSI	07/05-07/10	AXX, BPY, BWA	1984		0-N1316	TB [DG]	
2.0 FSI	07/05-07/10	AXX, BPY, BWA	1984		0-N1346	TB [DG]	
2.0 FSI	07/05-07/10	AXX, BWA, BPY	1984		0-N2208	TB [TE]	
2.0 FSI, 2.0 FSI 4motion	03/05-07/10	BLR, BLY, BVY, BVZ, BLX, BLY, BVX	1984		0-N1316	TB [DG]	
2.0 FSI, 2.0 FSI 4motion	03/05-07/10	BLR, BLY, BVY, BVZ, BLX, BLY, BVX	1984		0-N1346	TB [DG]	
2.0 FSI, 2.0 FSI 4motion	03/05-07/10	BLR, BLY, BVY, BVZ, BLX, BLY, BVX	1984		0-N2208	TB [TE]	
2.0 TDI	03/05-11/10	BMA, CBAA	1968		0-N1046	TB [DG]	
2.0 TDI	03/05-11/10	CBAA	1968		0-N1268	TB [DG]	
2.0 TDI	03/05-11/10	BMA	1968		0-N1335	TB [TE]	



CM³



Art. Nr.



ohne Halter

PASSAT (3C2)							
2.0 TDI	03/05-11/10	CBAA	1968		0-N1336	TB [DG]	
2.0 TDI	03/05-11/10	BMA	1968	ch.→3C-6-300000	0-N1336	TB [DG]	
2.0 TDI	03/05-11/10	BMA	1968	ch.3C-7-000001→	0-N1575	TB [DG]	
2.0 TDI	03/05-11/10	CBAA	1968		0-N1905	TB [BT]	
2.0 TDI	08/05-07/10	BMR, CBBB	1968		0-N1046	TB [DG]	
2.0 TDI	08/05-07/10	CBBB	1968		0-N1268	TB [DG]	
2.0 TDI	08/05-05/09	BUZ, BVE, BWV	1968		0-N1335	TB [TE]	
2.0 TDI	08/05-07/10	BMR	1968		0-N1335	TB [TE]	
2.0 TDI	08/05-05/09	BUZ, BVE, BWV	1968	ch.→3C-6-300000	0-N1336	TB [DG]	
2.0 TDI	08/05-07/10	CBBB	1968		0-N1336	TB [DG]	
2.0 TDI	08/05-07/10	BMR	1968	ch.→3C-6-300000	0-N1336	TB [DG]	
2.0 TDI	08/05-05/09	BUZ, BVE, BWV	1968	ch.3C-7-000001→	0-N1575	TB [DG]	
2.0 TDI	08/05-07/10	BMR	1968	ch.3C-7-000001→	0-N1575	TB [DG]	
2.0 TDI	08/05-07/10	CBBB	1968		0-N1905	TB [BT]	
2.0 TDI 16V	03/05-07/10	BKP, CBAB	1968		0-N1046	TB [DG]	
2.0 TDI 16V, 2.0 TDI 16V 4motion	03/05-08/10	CBAB	1968		0-N1268	TB [DG]	
2.0 TDI 16V, 2.0 TDI 16V 4motion	03/05-08/10	BKP	1968		0-N1335	TB [TE]	
2.0 TDI 16V, 2.0 TDI 16V 4motion	03/05-08/10	CBAB	1968		0-N1336	TB [DG]	
2.0 TDI 16V, 2.0 TDI 16V 4motion	03/05-08/10	BKP	1968	ch.→3C-6-300000	0-N1336	TB [DG]	
2.0 TDI 16V, 2.0 TDI 16V 4motion	03/05-08/10	BKP	1968	ch.3C-7-000001→	0-N1575	TB [DG]	
2.0 TDI 16V, 2.0 TDI 16V 4motion	03/05-08/10	CBAB	1968		0-N1905	TB [BT]	
2.0 TDI, 2.0 TDI 4motion	03/05-05/09	BMP	1968		0-N1045	TB [TE]	
1.4 TSI	05/07-07/10	CAXA	1390	⚠; ⚡	0-N1454	VB [DG]	
1.4 TSI	05/07-07/10	CAXA	1390	⚡	0-N1525	VB [BT]	S
1.4 TSI	05/07-07/10	CAXA	1390	⚡	0-N1733	VB [BT]	S
1.4 TSI EcoFuel	01/09-07/10	CDGA	1390	⚡	0-N2091	VB [BT]	S
1.4 TSI EcoFuel	01/09-07/10	CDGA	1390		0-N2092	VB [BT]	S
1.4 TSI EcoFuel	01/09-07/10	CDGA	1390	⚡	0-N2111	VB [BT]	S
1.6 FSI	03/05-06/08	BLF	1598	⚠; ⚡	0-N1454	VB [DG]	
1.6 FSI	03/05-06/08	BLF	1598	⚡	0-N1525	VB [BT]	S
1.6 FSI	03/05-06/08	BLF	1598	⚡	0-N1733	VB [BT]	S
1.6 TDI	08/09-07/10	CAYC	1598		0-N1534	VB [BT]	S
1.8 TSI	05/07-07/10	BZB, CDAA, CDAB, CGYA	1798		0-N1832	VB [BT]	S
1.9 TDI	03/05-11/08	BKC	1896		0-N1530	VB [BT]	S
1.9 TDI	03/05-11/08	BLS, BXE	1896		0-N1531	VB [BT]	S
2.0 BlueTDI, 2.0 TDI, 2.0 TDI 16V, 2.0 TDI 16V 4motion, 2.0 TDI 4motion	03/05-11/10	CBAB, CFFB	1968		0-N1534	VB [BT]	S
2.0 FSI	07/05-07/10	AXX, BPY, BWA	1984		0-N1656	VB [BT]	S
2.0 FSI	07/05-07/10	CAWB, CBFA, CCTA, CCZA	1984		0-N1832	VB [BT]	S
2.0 FSI	08/07-07/10	CCTB	1984		0-N1832	VB [BT]	S
2.0 TDI	03/05-11/10	BMA	1968		0-N1530	VB [BT]	S
2.0 TDI	08/05-05/09	BUZ, BVE, BWV	1968		0-N1530	VB [BT]	S
2.0 TDI	08/05-07/10	BMR	1968		0-N1530	VB [BT]	S
2.0 TDI	11/08-07/10	CBDC	1968		0-N1534	VB [BT]	S
2.0 TDI 16V, 2.0 TDI 16V 4motion	03/05-08/10	BKP	1968		0-N1530	VB [BT]	S
2.0 TDI, 2.0 TDI 4motion	03/05-05/09	BMP	1968		0-N1531	VB [BT]	S
3.2 FSI 4motion	11/05-07/10	AXZ	3168		0-N1715	VB [DG]	
3.2 FSI 4motion	11/05-07/10	AXZ	3168		0-N2209	VB [BT]	S
3.6 R36 4motion	04/07-07/10	BWS	3597		0-N1715	VB [DG]	
3.6 R36 4motion	04/07-07/10	BWS	3597		0-N2209	VB [BT]	S
PASSAT (3G2)							
1.6 TDI	08/14-	DCXA, DCZA	1598	⚡	0-N2288	VB [BT]	S
2.0 TDI, 2.0 TDI 4motion	08/14-	CRLB, DFGA, CUA A	1968		0-N1534	VB [BT]	S
2.0 TDI, 2.0 TDI 4motion	08/14-	CRLB, DFGA, CUA A, DDA A, DFCA	1968	⚡	0-N2288	VB [BT]	S
PASSAT Variant (3C5)							
1.6	08/05-11/10	BSE, BSF	1595	23x138; Baumuster: 3C5	SK-1109	BTK	
1.6	08/05-11/10	BSE, BSF	1595	23x138	SK-1109AQ1	BTKW	
1.6 TDI	08/09-11/10	CAYC	1598	25x160	SK-1695	BTK	
1.6 TDI	08/09-11/10	CAYC	1598	25x160	SK-1695AQ1	BTKW	
1.6 TDI	08/09-11/10	CAYC	1598	25x160; ch.→3C-B-050000	SK-1727AQ1	BTKW	
1.6 TDI	08/09-11/10	CAYC	1598	25x160; ch.3C-B-200 001→	SK-1727AQ2	BTKW	
1.9 TDI	08/05-11/08	BKC, BLS, BXE	1896	30x120; mit Zubehör	SK-1372	BTK	
1.9 TDI	08/05-11/08	BKC, BLS, BXE	1896	30x120	SK-1372AQ1	BTKW	
2.0 BlueTDI	01/09-11/10	CBAC	1968	30x160; → 11/2010	SK-1694	BTK	
2.0 BlueTDI, 2.0 TDI	11/08-11/10	CBAC, CBDC	1968	30x160	SK-1694AQ1	BTKW	

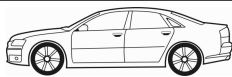

CM³

**Art. Nr.****ohne Halter**

PASSAT Variant (3C5)

2.0 FSI	08/05-11/10	AXX, BPY, BWA	1984	23x148	SK-1724	BTK
2.0 FSI	08/05-11/10	AXX, BPY, BWA	1984	23x148	SK-1724AQ1	BTkW
2.0 FSI, 2.0 FSI 4motion	08/05-11/10	BLR, BLY, BVY, BVZ, BLX, BLY, BVX	1984	23x148	SK-1724	BTK
2.0 FSI, 2.0 FSI 4motion	08/05-11/10	BLR, BLY, BVY, BVZ, BLX, BLY, BVX	1984	23x148	SK-1724AQ2	BTkW
2.0 TDI	08/05-05/09	BUZ, BVE, BWV	1968	30x141; ch.→3C-6-300000; mit Zubehör	SK-1595	BTK
2.0 TDI	08/05-11/10	BMR	1968	30x141; ch.→3C-6-300000; 02/2006 →; mit Zubehör	SK-1595	BTK
2.0 TDI	08/05-11/10	BMA	1968	30x141; ch.→3C-6-300000; mit Zubehör	SK-1595	BTK
2.0 TDI	08/05-05/09	BUZ, BVE, BWV	1968	30x141; ch.→3C-6-300000; mit Zubehör	SK-1595AQ1	BTkW
2.0 TDI	08/05-11/10	BMA	1968	30x141; ch.→3C-6-300000; mit Zubehör	SK-1595AQ1	BTkW
2.0 TDI	08/05-11/10	BMR	1968	30x141; ch.→3C-6-300000; mit Zubehör	SK-1595AQ1	BTkW
2.0 TDI	08/05-05/09	BUZ, BVE, BWV	1968	30x141; ch.3C-7-000001→; mit Zubehör	SK-1668	BTK
2.0 TDI	08/05-11/10	BMR	1968	30x141; ch.3C-7-000001→; 02/2006 →; mit Zubehör	SK-1668	BTK
2.0 TDI	08/05-11/10	BMA	1968	30x141; ch.3C-7-000001→; mit Zubehör	SK-1668	BTK
2.0 TDI	08/05-05/09	BUZ, BVE, BWV	1968	30x141; ch.3C-7-000001→	SK-1668AQ1	BTkW
2.0 TDI	08/05-11/10	BMA	1968	30x141; ch.3C-7-000001→	SK-1668AQ1	BTkW
2.0 TDI	08/05-11/10	BMR	1968	30x141; ch.3C-7-000001→	SK-1668AQ1	BTkW
2.0 TDI	08/05-11/10	CBAA	1968	30x160; → 11/2009	SK-1694	BTK
2.0 TDI	08/05-11/10	CBBB	1968	30x160; 02/2006 → 11/2010	SK-1694	BTK
2.0 TDI	08/05-11/10	CBAA	1968	30x160	SK-1694AQ1	BTkW
2.0 TDI	08/05-11/10	CBBB	1968	30x160	SK-1694AQ2	BTkW
2.0 TDI	11/08-11/10	CBDC	1968	30x160	SK-1694	BTK
2.0 TDI 16V	08/05-11/10	BKP	1968	30x141; ch.3C-7-300001→	SK-1668AQ1	BTkW
2.0 TDI 16V 4motion	08/05-11/10	BKP	1968	30x141; ch.3C-7-000001→	SK-1668AQ1	BTkW
2.0 TDI 16V, 2.0 TDI 16V 4motion	08/05-11/10	BKP	1968	30x141; ch.→3C-6-300000; mit Zubehör	SK-1595	BTK
2.0 TDI 16V, 2.0 TDI 16V 4motion	08/05-11/10	BKP	1968	30x141; ch.→3C-6-300000; mit Zubehör	SK-1595AQ1	BTkW
2.0 TDI 16V, 2.0 TDI 16V 4motion	08/05-11/10	BKP	1968	30x141; ch.3C-7-000001→; mit Zubehör	SK-1668	BTK
2.0 TDI 16V, 2.0 TDI 16V 4motion	08/05-11/10	CBAB	1968	30x160; → 11/2010	SK-1694	BTK
2.0 TDI 16V, 2.0 TDI 16V 4motion	08/05-11/10	CBAB	1968	30x160	SK-1694AQ1	BTkW
2.0 TDI 4motion	05/09-11/10	CBBB	1968	30x160; 11/2009 → 11/2010	SK-1694	BTK
2.0 TDI 4motion	05/09-11/10	CBBB	1968	30x160	SK-1694AQ2	BTkW
2.0 TDI, 2.0 TDI 4motion	08/05-05/09	BMP	1968	30x120; mit Zubehör	SK-1372	BTK
2.0 TDI, 2.0 TDI 4motion	08/05-05/09	BMP	1968	30x120	SK-1372AQ2	BTkW
1.6	08/05-11/10	BSE, BSF	1595		0-N157	TB [TE]
1.6 TDI	08/09-11/10	CAYC	1598		0-N131	TB [DG]
1.6 TDI	08/09-11/10	CAYC	1598		0-N2025	TB [DG]
1.6 TDI	08/09-11/10	CAYC	1598		0-N2200	TB [DG]
1.9 TDI	08/05-11/08	BKC, BLS, BXE	1896		0-N1045	TB [TE]
1.9 TDI	08/05-11/08	BKC, BLS, BXE	1896		0-N1046	TB [DG]
2.0 BlueTDI, 2.0 TDI, 2.0 TDI 4motion	08/05-11/10	BMP, BUZ, BVE, BWV, CBAC, CBBB, CBDC	1968		0-N1046	TB [DG]
2.0 BlueTDI, 2.0 TDI, 2.0 TDI 4motion	11/08-11/10	CBAC, CBBB, CBDC	1968		0-N1268	TB [DG]
2.0 BlueTDI, 2.0 TDI, 2.0 TDI 4motion	11/08-11/10	CBAC, CBBB, CBDC	1968		0-N1336	TB [DG]
2.0 BlueTDI, 2.0 TDI, 2.0 TDI 4motion	11/08-11/10	CBAC, CBBB, CBDC	1968		0-N1905	TB [BT]
2.0 FSI	08/05-11/10	AXX, BPY, BWA	1984		0-N1316	TB [DG]
2.0 FSI	08/05-11/10	AXX, BPY, BWA	1984		0-N1346	TB [DG]
2.0 FSI	08/05-11/10	AXX, BWA, BPY	1984		0-N2208	TB [TE]
2.0 FSI, 2.0 FSI 4motion	08/05-11/10	BLR, BLY, BVY, BVZ, BLX, BLY, BVX	1984		0-N1316	TB [DG]
2.0 FSI, 2.0 FSI 4motion	08/05-11/10	BLR, BLY, BVY, BVZ, BLX, BLY, BVX	1984		0-N1346	TB [DG]
2.0 FSI, 2.0 FSI 4motion	08/05-11/10	BLR, BLY, BVY, BVZ, BLX, BLY, BVX	1984		0-N2208	TB [TE]
2.0 TDI	08/05-02/06	BVD	1968		0-N1045	TB [TE]
2.0 TDI	08/05-11/10	BMA, CBAA	1968		0-N1046	TB [DG]
2.0 TDI	08/05-11/10	BMR, CBBB	1968		0-N1046	TB [DG]
2.0 TDI	08/05-11/10	CBAA	1968		0-N1268	TB [DG]
2.0 TDI	08/05-11/10	CBBB	1968		0-N1268	TB [DG]
2.0 TDI	08/05-02/06	BVE	1968		0-N1335	TB [TE]
2.0 TDI	08/05-05/09	BUZ, BWV	1968		0-N1335	TB [TE]
2.0 TDI	08/05-11/10	BMA	1968		0-N1335	TB [TE]
2.0 TDI	08/05-11/10	BMR	1968		0-N1335	TB [TE]
2.0 TDI	08/05-05/09	BUZ, BVE, BWV	1968	ch.→3C-6-300000	0-N1336	TB [DG]
2.0 TDI	08/05-11/10	CBAA	1968		0-N1336	TB [DG]
2.0 TDI	08/05-11/10	CBBB	1968		0-N1336	TB [DG]
2.0 TDI	08/05-11/10	BMA	1968	ch.→3C-6-300000	0-N1336	TB [DG]
2.0 TDI	08/05-11/10	BMR	1968	ch.→3C-6-300000	0-N1336	TB [DG]
2.0 TDI	08/05-05/09	BUZ, BVE, BWV	1968	ch.3C-7-000001→	0-N1575	TB [DG]



CM³



Art. Nr.



PASSAT Variant (3C5)							
2.0 TDI	08/05-11/10	BMA	1968	ch.3C-7-000001→	0-N1575	TB [DG]	
2.0 TDI	08/05-11/10	BMR	1968	ch.3C-7-000001→	0-N1575	TB [DG]	
2.0 TDI	08/05-11/10	CBAA	1968		0-N1905	TB [BT]	
2.0 TDI	08/05-11/10	CBBB	1968		0-N1905	TB [BT]	
2.0 TDI 16V, 2.0 TDI 16V 4motion	08/05-11/10	BKP, CBAB	1968		0-N1046	TB [DG]	
2.0 TDI 16V, 2.0 TDI 16V 4motion	08/05-11/10	CBAB	1968		0-N1268	TB [DG]	
2.0 TDI 16V, 2.0 TDI 16V 4motion	08/05-11/10	BKP	1968		0-N1335	TB [TE]	
2.0 TDI 16V, 2.0 TDI 16V 4motion	08/05-11/10	CBAB	1968		0-N1336	TB [DG]	
2.0 TDI 16V, 2.0 TDI 16V 4motion	08/05-11/10	BKP	1968	ch.→3C-6-300000	0-N1336	TB [DG]	
2.0 TDI 16V, 2.0 TDI 16V 4motion	08/05-11/10	BKP	1968	ch.3C-7-000001→	0-N1575	TB [DG]	
2.0 TDI 16V, 2.0 TDI 16V 4motion	08/05-11/10	CBAB	1968		0-N1905	TB [BT]	
2.0 TDI, 2.0 TDI 4motion	08/05-05/09	BMP	1968		0-N1045	TB [TE]	
1.4 TSI	05/07-11/10	CAXA	1390	☰; ☼	0-N1454	VB [DG]	
1.4 TSI	05/07-11/10	CAXA	1390	☼	0-N1525	VB [BT]	S
1.4 TSI	05/07-11/10	CAXA	1390	☼	0-N1733	VB [BT]	S
1.4 TSI EcoFuel	01/09-11/10	CDGA	1390	☼	0-N2091	VB [BT]	S
1.4 TSI EcoFuel	01/09-11/10	CDGA	1390		0-N2092	VB [BT]	S
1.4 TSI EcoFuel	01/09-11/10	CDGA	1390	☼	0-N2111	VB [BT]	S
1.6 FSI	08/05-06/08	BLF	1598	☰; ☼	0-N1454	VB [DG]	
1.6 FSI	08/05-06/08	BLF	1598	☼	0-N1525	VB [BT]	S
1.6 FSI	08/05-06/08	BLF	1598	☼	0-N1733	VB [BT]	S
1.6 TDI	08/09-11/10	CAYC	1598		0-N1534	VB [BT]	S
1.8 TSI	05/07-10/11	BZB, CDA, CDAB, CGYA	1798		0-N1832	VB [BT]	S
1.9 TDI	08/05-11/08	BKC	1896		0-N1530	VB [BT]	S
1.9 TDI	08/05-11/08	BLS, BXE	1896		0-N1531	VB [BT]	S
2.0 BlueTDI, 2.0 TDI	11/08-11/10	CBAC, CBDC	1968		0-N1534	VB [BT]	S
2.0 FSI	08/05-11/10	AXX, BPY, BWA	1984		0-N1656	VB [BT]	S
2.0 FSI	08/05-11/10	CAWB, CBFA, CCTA, CCZA	1984		0-N1832	VB [BT]	S
2.0 FSI	08/07-11/10	CCTB	1984		0-N1832	VB [BT]	S
2.0 TDI	08/05-05/09	BUZ, BVE, BWV	1968		0-N1530	VB [BT]	S
2.0 TDI	08/05-11/10	BMA	1968		0-N1530	VB [BT]	S
2.0 TDI	08/05-11/10	BMR	1968		0-N1530	VB [BT]	S
2.0 TDI 16V, 2.0 TDI 16V 4motion	08/05-11/10	BKP	1968		0-N1530	VB [BT]	S
2.0 TDI, 2.0 TDI 16V, 2.0 TDI 16V 4motion, 2.0 TDI 4motion	08/05-11/10	CBAB, CFFB	1968		0-N1534	VB [BT]	S
2.0 TDI, 2.0 TDI 4motion	08/05-05/09	BMP	1968		0-N1531	VB [BT]	S
3.2 FSI 4motion	11/05-11/10	AXZ	3168		0-N1715	VB [DG]	
3.2 FSI 4motion	11/05-11/10	AXZ	3168		0-N2209	VB [BT]	S
3.6 R36 4motion	04/07-11/10	BWS	3597		0-N1715	VB [DG]	
3.6 R36 4motion	04/07-11/10	BWS	3597		0-N2209	VB [BT]	S
PASSAT Variant (3G5)							
1.6 TDI	08/14-	DCXA, DCZA	1598	☼	0-N2288	VB [BT]	S
2.0 TDI, 2.0 TDI 4motion	08/14-	CRLB, DFGA, CUAA	1968		0-N1534	VB [BT]	S
2.0 TDI, 2.0 TDI 4motion	08/14-	CRLB, DFGA, CUAA, DDA, DFCA	1968	☼	0-N2288	VB [BT]	S
PASSAT CC (357)							
2.0 BlueTDI	05/09-11/10	CBAC	1968	30x160	SK-1694AQ1	BTKW	
2.0 BlueTDI, 2.0 TDI	05/08-05/11	CBAC, CBBA	1968	30x160	SK-1694	BTK	
2.0 TDI	05/08-05/11	CBBA	1968	30x160	SK-1694AQ2	BTKW	
2.0 TDI	06/08-01/12	CBBB	1968	30x160; 08/2008 →	SK-1694	BTK	
2.0 TDI	06/08-05/11	CBAA	1968	30x160	SK-1694	BTK	
2.0 TDI	06/08-05/11	CBAA	1968	30x160	SK-1694AQ1	BTKW	
2.0 TDI	06/08-01/12	CFGB, CLLA	1968	25x160; → 01/2012	SK-1695	BTK	
2.0 TDI	06/08-05/11	CFFA	1968	25x160	SK-1695	BTK	
2.0 TDI	06/08-01/12	CFGB, CLLA	1968	25x160; → 11/2010	SK-1695AQ1	BTKW	
2.0 TDI	06/08-05/11	CFFA	1968	25x160; → 11/2010	SK-1695AQ1	BTKW	
2.0 TDI 4motion	11/09-01/12	CBBB	1968	30x160	SK-1694	BTK	
2.0 TDI 4motion	11/09-01/12	CFGB	1968	25x160; → 01/2012	SK-1695	BTK	
2.0 TDI 4motion	11/09-01/12	CFGB	1968	25x160; → 11/2010	SK-1695AQ1	BTKW	
2.0 TDI, 2.0 TDI 4motion	06/08-01/12	CBAB	1968	30x160	SK-1694	BTK	
2.0 TDI, 2.0 TDI 4motion	06/08-01/12	CBAB	1968	30x160	SK-1694AQ1	BTKW	
2.0 TDI, 2.0 TDI 4motion	06/08-01/12	CBBB	1968	30x160	SK-1694AQ2	BTKW	
2.0 TDI, 2.0 TDI 4motion	06/08-01/12	CFFB	1968	25x160; → 01/2012	SK-1695	BTK	
2.0 TDI, 2.0 TDI 4motion	06/08-01/12	CFFB	1968	25x160; → 11/2010	SK-1695AQ1	BTKW	
2.0 TDI, 2.0 TDI 4motion	06/08-01/12	CFFA, CFFB	1968	25x160; → 11/2010	SK-1727AQ2	BTKW	
2.0 TDI, 2.0 TDI 4motion	06/08-01/12	CFGB	1968	25x160; → 11/2010	SK-1727AQ2	BTKW	



OPTIMAL®

VW

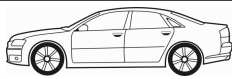

CM³



Art. Nr.



ohne Halter

PASSAT CC (357)

2.0 BlueTDI, 2.0 TDI	05/08-05/11	CBAC, CBBA	1968		0-N1046	TB [DG]	
2.0 BlueTDI, 2.0 TDI	05/08-05/11	CBAC, CBBA	1968		0-N1268	TB [DG]	
2.0 BlueTDI, 2.0 TDI	05/08-05/11	CBAC, CBBA	1968		0-N1336	TB [DG]	
2.0 BlueTDI, 2.0 TDI	05/08-05/11	CBAC, CBBA	1968		0-N1905	TB [BT]	
2.0 TDI	06/08-01/12	CFFB	1968	→ 10/2010	0-N1046	TB [DG]	
2.0 TDI	06/08-01/12	CFGB, CLLA	1968	→ 10/2010	0-N1046	TB [DG]	
2.0 TDI	06/08-05/11	CBAA	1968		0-N1046	TB [DG]	
2.0 TDI	06/08-05/11	CFFA	1968	→ 10/2010	0-N1046	TB [DG]	
2.0 TDI	06/08-05/11	CBAA	1968		0-N1268	TB [DG]	
2.0 TDI	06/08-01/12	CFGB, CLLA	1968		0-N131	TB [DG]	
2.0 TDI	06/08-05/11	CFFA	1968		0-N131	TB [DG]	
2.0 TDI	06/08-05/11	CBAA	1968		0-N1336	TB [DG]	
2.0 TDI	06/08-05/11	CBAA	1968		0-N1905	TB [BT]	
2.0 TDI	06/08-01/12	CFGB, CLLA	1968		0-N2025	TB [DG]	
2.0 TDI	06/08-05/11	CFFA	1968		0-N2025	TB [DG]	
2.0 TDI	06/08-01/12	CFGB, CLLA	1968	12/2010 →	0-N2200	TB [DG]	
2.0 TDI	06/08-05/11	CFFA	1968	12/2010 →	0-N2200	TB [DG]	
2.0 TDI 4motion	08/09-01/12	CFFB	1968	→ 11/2010	0-N1046	TB [DG]	
2.0 TDI 4motion	11/09-01/12	CFGB	1968	→ 11/2010	0-N1046	TB [DG]	
2.0 TDI 4motion	11/09-01/12	CFGB	1968		0-N131	TB [DG]	
2.0 TDI 4motion	11/09-01/12	CFGB	1968		0-N2025	TB [DG]	
2.0 TDI 4motion	11/09-01/12	CFGB	1968	12/2010 →	0-N2200	TB [DG]	
2.0 TDI, 2.0 TDI 4motion	06/08-01/12	CBAB	1968		0-N1046	TB [DG]	
2.0 TDI, 2.0 TDI 4motion	06/08-01/12	CBAB	1968		0-N1046	TB [DG]	
2.0 TDI, 2.0 TDI 4motion	06/08-01/12	CBAB	1968		0-N1268	TB [DG]	
2.0 TDI, 2.0 TDI 4motion	06/08-01/12	CBAB	1968		0-N1268	TB [DG]	
2.0 TDI, 2.0 TDI 4motion	06/08-01/12	CFFB	1968		0-N131	TB [DG]	
2.0 TDI, 2.0 TDI 4motion	06/08-01/12	CBAB	1968		0-N1336	TB [DG]	
2.0 TDI, 2.0 TDI 4motion	06/08-01/12	CBAB	1968		0-N1336	TB [DG]	
2.0 TDI, 2.0 TDI 4motion	06/08-01/12	CBAB	1968		0-N1905	TB [BT]	
2.0 TDI, 2.0 TDI 4motion	06/08-01/12	CBAB	1968		0-N1905	TB [BT]	
2.0 TDI, 2.0 TDI 4motion	06/08-01/12	CFFB	1968		0-N2025	TB [DG]	
2.0 TDI, 2.0 TDI 4motion	06/08-01/12	CFFB	1968	12/2010 →	0-N2200	TB [DG]	
1.4 TSI MultiFuel	01/11-01/12	CKMA	1390	✳	0-N2091	VB [BT]	S
1.4 TSI MultiFuel	01/11-01/12	CKMA	1390		0-N2092	VB [BT]	S
1.4 TSI MultiFuel	01/11-01/12	CKMA	1390	✳	0-N2111	VB [BT]	S
1.8 TSI	06/08-01/12	BZB, CDA, CDAB, CGYA	1798		0-N1832	VB [BT]	S
2.0 BlueTDI, 2.0 TDI	05/08-05/11	CBAA, CFFA, CBAC, CBBA	1968		0-N1534	VB [BT]	S
2.0 TDI, 2.0 TDI 4motion	06/08-01/12	CBAB, CFFB	1968		0-N1534	VB [BT]	S
2.0 TSI	06/08-01/12	CAWB, CBFA, CCTA, CCZA, CCZB	1984		0-N1832	VB [BT]	S
3.6 FSI 4motion	06/08-01/12	BLV, CNNA, BWS	3597		0-N1715	VB [DG]	
3.6 FSI 4motion	06/08-01/12	BLV, CNNA, BWS	3597		0-N2209	VB [BT]	S

PASSAT (362)

1.6 TDI	08/10-12/14	CAYC	1598	25x160	SK-1695	BTK	
1.6 TDI	08/10-12/14	CAYC	1598	25x160; → 11/2010	SK-1695AQ1	BTKW	
1.6 TDI	08/10-12/14	CAYC	1598	25x160; ch.→3C-B-050000; → 11/2010	SK-1727AQ1	BTKW	
1.6 TDI	08/10-12/14	CAYC	1598	25x160; ch.3C-B-200 001→ 11/2010	SK-1727AQ2	BTKW	
2.0 TDI	08/10-12/14	CFFA, CFFB, CFGB, CLLA	1968	25x160; → 11/2010	SK-1695	BTK	
2.0 TDI	08/10-12/14	CFFA	1968	25x160	SK-1695AQ1	BTKW	
2.0 TDI	08/10-12/14	CFFA, CFFB	1968	25x160	SK-1727AQ2	BTKW	
2.0 TDI, 2.0 TDI 4motion	08/10-12/14	CFFB, CFGB, CLLA	1968	25x160; → 11/2010	SK-1695AQ1	BTKW	
2.0 TDI, 2.0 TDI 4motion	08/10-12/14	CFFA, CFFB, CFGB, CLLA	1968	25x160; 12/2010 →	SK-1727	BTK	
2.0 TDI, 2.0 TDI 4motion	08/10-12/14	CFFA, CFFB	1968	25x160; → 11/2010	SK-1727AQ2	BTKW	
2.0 TDI, 2.0 TDI 4motion	08/10-12/14	CFGB, CLLA	1968	25x160; → 11/2010	SK-1727AQ2	BTKW	
2.0 TDI, 2.0 TDI 4motion	12/12-12/14	CFGC	1968	25x160	SK-1727	BTK	
2.0 TDI, 2.0 TDI 4motion	12/12-12/14	CFGC	1968	25x160	SK-1727AQ2	BTKW	
1.6 TDI	08/10-12/14	CAYC	1598		0-N131	TB [DG]	
1.6 TDI	08/10-12/14	CAYC	1598		0-N2025	TB [DG]	
1.6 TDI	08/10-12/14	CAYC	1598		0-N2200	TB [DG]	
2.0 TDI, 2.0 TDI 4motion	08/10-12/14	CFGB, CLLA	1968	→ 11/2010	0-N1046	TB [DG]	
2.0 TDI, 2.0 TDI 4motion	08/10-12/14	CFFA, CFFB, CFGB, CLLA, CFGC	1968		0-N131	TB [DG]	
2.0 TDI, 2.0 TDI 4motion	08/10-12/14	CFFA, CFFB, CFGB, CLLA	1968		0-N2025	TB [DG]	
2.0 TDI, 2.0 TDI 4motion	08/10-12/14	CFFA, CFFB, CFGB, CLLA	1968		0-N2200	TB [DG]	
1.4 TSI	08/10-12/14	CAXA	1390	✳	0-N1454	VB [DG]	
1.4 TSI	08/10-12/14	CAXA	1390	✳	0-N1525	VB [BT]	S

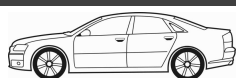

CM³



Art. Nr.



PASSAT (362)							
1.4 TSI	08/10-12/14	CAXA	1390	✳		0-N1733	VB [BT] S
1.4 TSI EcoFuel, 1.4 TSI MultiFuel	08/10-12/14	CDGA, CKMA	1390	✳		0-N2091	VB [BT] S
1.4 TSI EcoFuel, 1.4 TSI MultiFuel	08/10-12/14	CDGA, CKMA	1390			0-N2092	VB [BT] S
1.4 TSI EcoFuel, 1.4 TSI MultiFuel	08/10-12/14	CDGA, CKMA	1390	✳		0-N2111	VB [BT] S
1.6 TDI	08/10-12/14	CAYC	1598			0-N1534	VB [BT] S
1.8 TSI	08/10-12/14	CDA, CDAB	1798			0-N1832	VB [BT] S
2.0 TDI, 2.0 TDI 4motion	08/10-12/14	CFFA, CFFB, CFGB, CLLA, CFGC	1968			0-N1534	VB [BT] S
2.0 TSI	11/10-12/14	CCZB	1984			0-N1832	VB [BT] S
3.6 FSI 4motion	01/11-12/14	BWS	3597			0-N1715	VB [DG]
3.6 FSI 4motion	01/11-12/14	BWS	3597			0-N2209	VB [BT] S

PASSAT Variant (365)							
1.6 TDI	08/10-12/14	CAYC	1598	25x160		SK-1695	BTK
1.6 TDI	08/10-12/14	CAYC	1598	25x160; → 11/2010		SK-1695AQ1	BTKW
1.6 TDI	08/10-12/14	CAYC	1598	25x160; ch.→3C-B-050000; → 11/2010		SK-1727AQ1	BTKW
1.6 TDI	08/10-12/14	CAYC	1598	25x160; ch.3C-B-200 001→ 11/2010		SK-1727AQ2	BTKW
2.0 TDI	08/10-12/14	CFFA, CFFB	1968	25x160		SK-1727AQ2	BTKW
2.0 TDI, 2.0 TDI 4motion	08/10-12/14	CFFA, CFFB, CFGB, CLLA	1968	25x160; → 11/2010		SK-1695	BTK
2.0 TDI, 2.0 TDI 4motion	08/10-12/14	CFFA, CFFB, CFGB, CLLA	1968	25x160; → 11/2010		SK-1695AQ1	BTKW
2.0 TDI, 2.0 TDI 4motion	08/10-12/14	CFFA, CFFB, CFGB, CLLA	1968	25x160; 12/2010 →		SK-1727	BTK
2.0 TDI, 2.0 TDI 4motion	08/10-12/14	CFFA, CFFB	1968	25x160; → 11/2010		SK-1727AQ2	BTKW
2.0 TDI, 2.0 TDI 4motion	08/10-12/14	CFGB, CLLA	1968	25x160; → 11/2010		SK-1727AQ2	BTKW
2.0 TDI, 2.0 TDI 4motion	12/12-12/14	CFGC	1968	25x160		SK-1727	BTK
2.0 TDI, 2.0 TDI 4motion	12/12-12/14	CFGC	1968	25x160		SK-1727AQ2	BTKW
1.6 TDI	08/10-12/14	CAYC	1598	→ 11/2010		0-N1046	TB [DG]
1.6 TDI	08/10-12/14	CAYC	1598			0-N131	TB [DG]
1.6 TDI	08/10-12/14	CAYC	1598			0-N2025	TB [DG]
1.6 TDI	08/10-12/14	CAYC	1598			0-N2200	TB [DG]
2.0 TDI, 2.0 TDI 4motion	08/10-12/14	CFFA, CFFB, CFGB, CLLA, CFGC	1968			0-N131	TB [DG]
2.0 TDI, 2.0 TDI 4motion	08/10-12/14	CFFA, CFFB, CFGB, CLLA	1968			0-N2025	TB [DG]
2.0 TDI, 2.0 TDI 4motion	08/10-12/14	CFFA, CFFB, CFGB, CLLA	1968			0-N2200	TB [DG]
1.4 TSI	08/10-12/14	CAXA	1390	✳; ✳		0-N1454	VB [DG]
1.4 TSI	08/10-12/14	CAXA	1390	✳		0-N1525	VB [BT] S
1.4 TSI	08/10-12/14	CAXA	1390	✳		0-N1733	VB [BT] S
1.4 TSI EcoFuel, 1.4 TSI MultiFuel	08/10-12/14	CDGA, CKMA	1390	✳		0-N2091	VB [BT] S
1.4 TSI EcoFuel, 1.4 TSI MultiFuel	08/10-12/14	CDGA, CKMA	1390			0-N2092	VB [BT] S
1.4 TSI EcoFuel, 1.4 TSI MultiFuel	08/10-12/14	CDGA, CKMA	1390	✳		0-N2111	VB [BT] S
1.6 TDI	08/10-12/14	CAYC	1598			0-N1534	VB [BT] S
1.8 TSI	08/10-12/14	CDA, CDAB	1798			0-N1832	VB [BT] S
2.0 TDI, 2.0 TDI 4motion	08/10-12/14	CFFA, CFFB, CFGB, CLLA, CFGC	1968			0-N1534	VB [BT] S
2.0 TSI	11/10-12/14	CCZB	1984			0-N1832	VB [BT] S
3.6 FSI 4motion	01/11-12/14	BWS	3597			0-N1715	VB [DG]
3.6 FSI 4motion	01/11-12/14	BWS	3597			0-N2209	VB [BT] S

PASSAT ALLTRACK (365)							
2.0 TDI, 2.0 TDI 4motion	01/12-12/14	CFFB, CFGB, CFGC	1968	25x160		SK-1727	BTK
2.0 TDI, 2.0 TDI 4motion	01/12-12/14	CFFB, CFGB, CFGC	1968	25x160		SK-1727AQ2	BTKW
2.0 TDI 4motion	01/13-12/14	CFGC	1968			0-N131	TB [DG]
1.8 TSI	01/12-12/14	CDA, CDAB	1798			0-N1832	VB [BT] S
2.0 TDI, 2.0 TDI 4motion	01/12-12/14	CFFB, CFGB, CFGC	1968			0-N1534	VB [BT] S
2.0 TSI 4motion	01/12-12/14	CCZB	1984			0-N1832	VB [BT] S

PHAETON (3D_)							
3.0 V6 TDI 4motion	09/04-	BMK	2967	24x83; mit Zubehör		SK-1597	BTK
3.0 V6 TDI 4motion	06/07-	CARA, CARB, CEXA, CEXB	2967	24x82		SK-1720	BTK
4.2 V8 4motion	05/03-	BGH, BGJ	4172	30x253		SK-1386	BTK
4.2 V8 4motion	05/03-	BGH, BGJ	4172	30x253		SK-1386AQ1	BTKW
3.0 V6 TDI 4motion	09/04-	BMK, CARA, CARB, CEXA	2967			0-N1337	TB [TE]
3.0 V6 TDI 4motion	06/07-	CARA, CARB, CEXA	2967			0-N131	TB [DG]
4.2 V8 4motion	05/03-	BGH, BGJ	4172			0-N1568	TB [TE]
4.2 V8 4motion	05/03-	BGH, BGJ	4172			0-N1569	TB [BT]
4.2 V8 4motion	05/03-	BGH, BGJ	4172			0-N1570	TB [DG]
4.2 V8 4motion	05/03-	BGH, BGJ	4172			0-N169	TB [DG]
3.0 V6 TDI 4motion	09/04-	BMK	2967	Rippenanzahl: 6		0-N1431	VB [DG]
3.0 V6 TDI 4motion	09/04-	BMK	2967	→ 12/2007		0-N1907	VB [DG]
3.0 V6 TDI 4motion	09/04-	BMK, CARA	2967			0-N1918	VB [BT] S
3.0 V6 TDI 4motion	06/07-	CARA, CARB, CEXA	2967			0-N1795	VB [DG]



CM³



Art. Nr.



ohne Halter

PHAETON (3D_)

3.0 V6 TDI 4motion	11/08-	CEXA	2967		0-N1918	VB [BT]	S
3.2 V6, 3.2 V6 4motion	04/02-	AYT, BKL, BKL, BRK	3189	Rippenanzahl: 6	0-N1496S	VB [TE]	
3.2 V6, 3.2 V6 4motion	04/02-	AYT, BKL, BKL, BRK	3189		0-N1740	VB [DG]	
3.6 V6 4motion	11/08-	CHNA, CMVA	3597		0-N2110	VB [DG]	
4.2 V8 4motion	05/03-	BGH, BGJ	4172		0-N2134	VB [DG]	
4.2 V8 4motion	05/03-	BGH, BGJ	4172		0-N2137	VB [TE]	S
6.0 W12 4motion	04/02-	BAN, BRN, BTT	5998	Rippenanzahl: 7	0-N2127	VB [DG]	

POLO (86C, 80)

1.0, 1.0 KAT	08/85-09/94	AAU	1043	19x128; :AAU015868→	R-1190AQ1	BTKW	
1.0, 1.0 KAT	08/85-09/94	AAK, AAU, ACM, HZ	1043	19x128; :HZ786023→	R-1190AQ1	BTKW	
1.3	08/83-07/88	HK, MH	1272	19x128; :262740→	R-1190AQ1	BTKW	
1.3 KAT	07/87-09/94	AAV	1272	19x128	R-1190AQ1	BTKW	
1.3 KAT	07/87-09/94	2G	1272	19x128; :262740→	R-1190AQ1	BTKW	
1.3, 1.3 KAT	09/82-03/91	3F, GK	1272	19x128; :008527→	R-1190AQ1	BTKW	
1.3, 1.3 KAT	08/83-09/94	NZ	1272	19x128; :NZ200001→	R-1190AQ1	BTKW	

POLO CLASSIC (86C, 80)

1.0	01/85-09/94	AAU	1043	19x128; 08/1985 →; :AAU015868→	R-1190AQ1	BTKW	
1.0	01/85-09/94	HZ	1043	19x128; 08/1985 →; :HZ786023→	R-1190AQ1	BTKW	
1.3 KAT	07/87-09/94	MH, NZ	1272	19x128; :262740→	R-1190AQ1	BTKW	
1.3 KAT	07/87-09/94	NZ	1272	19x128; :NZ200001→	R-1190AQ1	BTKW	

POLO Coupe (86C, 80)

1.0, 1.0 KAT	08/85-09/94	AAU	1043	19x128; :AAU015868→	R-1190AQ1	BTKW	
1.0, 1.0 KAT	08/85-09/94	AAK, AAU, ACM, HZ	1043	19x128; :HZ786023→	R-1190AQ1	BTKW	
1.3	08/83-06/87	HK, MH	1272	19x128; :262740→	R-1190AQ1	BTKW	
1.3 G40	01/87-09/94	PY	1272	19x128; :PY002178→	R-1190AQ1	BTKW	
1.3 KAT	07/87-08/94	AAV	1272	19x128	R-1190AQ1	BTKW	
1.3 KAT	07/87-08/94	2G	1272	19x128; :262740→	R-1190AQ1	BTKW	
1.3, 1.3 KAT	09/82-09/94	3F, GK	1272	19x128; :008527→	R-1190AQ1	BTKW	
1.3, 1.3 KAT	08/83-08/94	NZ	1272	19x128; :NZ200001→	R-1190AQ1	BTKW	

POLO Kasten (86CF)

1.0	08/92-07/94	AAU	1043	19x128; :AAU015868→	R-1190AQ1	BTKW	
1.0	08/92-07/94	AAU	1043	19x128; :HZ786023→	R-1190AQ1	BTKW	
1.0	08/92-07/94	AAU	1043	19x132	SK-1344	BTK	
1.3	08/92-07/94	NZ	1272	19x128	R-1190AQ1	BTKW	

POLO (6N1)

1.7 SDI, 60 1.7 SDI	04/97-10/99	AHG, AKU	1716	23x137; mit Zubehör	SK-1106	BTK	
100 1.4 16V	04/96-10/99	AFH	1390	20x130; 17x58; beinhaltetete Rollen: 4	SK-1511	BTK	
100 1.4 16V	04/96-10/99	AFH	1390	20x130; 17x58; beinhaltetete Rollen: 4	SK-1511AQ1	BTKW	
100 1.4 16V	04/96-10/99	AFH	1390	25x149	SK-1635	BTK	
100 1.4 16V	04/96-10/99	AFH	1390	25x149	SK-1635AQ1	BTKW	
120 1.6 16V GTI	09/98-10/99	AJV	1598	20x130; 17x58; :005001→; beinhaltetete Rollen: 4	SK-1511	BTK	
120 1.6 16V GTI	09/98-10/99	AJV	1598	20x130; 17x58; :005001→; beinhaltetete Rollen: 4	SK-1511AQ2	BTKW	
120 1.6 16V GTI	09/98-10/99	AJV	1598	20x130; 17x58; :→AJV005000	SK-1585	BTK	
45 1.0	10/94-09/96	AEV	1043	19x132	SK-1344	BTK	
45 1.0	10/94-09/96	AEV	1043	19x132	SK-1344AQ1	BTKW	
50 1.0	09/96-10/99	AER, ALL	999	19x135; ch.→6N-Y-600000; mit Zubehör	SK-1131	BTK	
50 1.0	09/96-10/99	AER, ALL	999	19x135; ch.→6N-Y-600000; mit Zubehör	SK-1131AQ2	BTKW	
50 1.0	09/96-10/99	AER, ALL	999	19x135; ch.6N-Y-600001→; mit Zubehör	SK-1592	BTK	
55 1.3	10/94-07/95	ADX	1296	19x135; mit Zubehör; Baumuster: 6N1	SK-1131	BTK	
55 1.3	10/94-07/95	ADX	1296	19x135; mit Zubehör	SK-1131AQ1	BTKW	
55 1.4	08/95-10/99	ANX	1390	19x135; ch.→6N-Y-600000; 01/1998 →; mit Zubehör	SK-1131	BTK	
55 1.4	08/95-10/99	ANX	1390	19x135; 01/1998 →; mit Zubehör	SK-1131AQ1	BTKW	
55 1.4	08/95-10/99	AEX	1390	19x135; ch.→ch.→6N-Y-600000; 01/1998 →; mit Zubehör	SK-1131AQ2	BTKW	
55 1.4	08/95-10/99	AEX	1390	19x135; ch.6N-Y-600001→; 01/1998 →; mit Zubehör	SK-1592	BTK	
60 1.4	07/95-10/99	AEX, AKV, APQ	1390	19x135; ch.→6N-Y-600000; mit Zubehör	SK-1131	BTK	
60 1.4	07/95-10/99	AEX, AKV, APQ	1390	19x135; mit Zubehör	SK-1131AQ1	BTKW	
60 1.4	07/95-10/99	AEX, AKV, APQ	1390	19x135; ch.→6N-Y-600000; mit Zubehör	SK-1131AQ2	BTKW	
60 1.4	07/95-10/99	AEX, AKV, APQ	1390	19x135; ch.6N-Y-600001→; mit Zubehör	SK-1592	BTK	
64 1.9 D, 64 1.9 SDI	10/94-10/99	AEF, AGD	1896	23x137; mit Zubehör	SK-1106	BTK	
64 1.9 D, 64 1.9 SDI	10/94-10/99	AEF, AGD	1896	23x137; mit Zubehör	SK-1512	BTK	

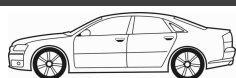

CM³



Art. Nr.



POLO (6N1)							
75 1.6	10/94-10/99	AEA, AEE	1598	19x137; mit Zubehör; Baumuster: 6N1	SK-1074	BTK	
75 1.6	10/94-10/99	AEA, AEE, AHS	1598	19x137	SK-1074AQ1	BTKW	
1.7 SDI, 60 1.7 SDI	04/97-10/99	AHG, AKU	1716		0-N111	TB [TE]	
1.7 SDI, 60 1.7 SDI	04/97-10/99	AHG, AKU	1716		0-N128	TB [DG]	
100 1.4 16V	04/96-10/99	AFH	1390		0-N1258	TB [TE]	
100 1.4 16V	04/96-10/99	AFH	1390		0-N165	TB [DG]	
120 1.6 16V GTI	09/98-10/99	AJV	1598		0-N1262	TB [DG]	
120 1.6 16V GTI	09/98-10/99	AJV	1598	:005000→	0-N1263	TB [TE]	
120 1.6 16V GTI	09/98-10/99	AJV	1598		0-N158	TB [TE]	
120 1.6 16V GTI	09/98-10/99	AJV	1598	:→005000	0-N159	TB [TE]	
120 1.6 16V GTI	09/98-10/99	AJV	1598		0-N164	TB [DG]	
45 1.0	10/94-09/96	AEV	1043		0-N105	TB [TE]	
50 1.0	09/96-10/99	AER, ALL	999		0-N106	TB [TE]	
55 1.3	10/94-07/95	ADX	1296		0-N106	TB [TE]	
55 1.4, 60 1.4	07/95-10/99	AEX, AEX, AKV, APQ	1390		0-N106	TB [TE]	
64 1.9 D, 64 1.9 SDI	10/94-10/99	AEF, AGD	1896		0-N111	TB [TE]	
64 1.9 SDI	07/96-10/99	AGD	1896		0-N128	TB [DG]	
75 1.6	10/94-10/99	AEA, AEE, AHS	1598		0-N106	TB [TE]	
1.7 SDI, 60 1.7 SDI	04/97-10/99	AHG, AKU	1716		0-N1675	VB [TE]	
1.7 SDI, 60 1.7 SDI	04/97-10/99	AHG, AKU	1716		0-N1920	VB [BT]	
1.7 SDI, 60 1.7 SDI	04/97-10/99	AHG, AKU	1716	für Artikelnummer:0-N1920	0-N1925	VB [BT]	
100 1.4 16V	04/96-10/99	AFH	1390	✳	0-N1445	VB [BT]	S
120 1.6 16V GTI	09/98-10/99	AJV	1598		0-N1445	VB [BT]	S
45 1.0	10/94-09/96	AEV	1043	✳, für Fahrzeuge mit Servolenkung	0-N1445	VB [BT]	S
50 1.0	09/96-10/99	AER, ALL	999		0-N1445	VB [BT]	S
55 1.3	10/94-07/95	ADX	1296	✳, für Fahrzeuge mit Servolenkung	0-N1445	VB [BT]	S
55 1.4	08/95-10/99	AEX	1390	für Fahrzeuge mit Servolenkung	0-N1445	VB [BT]	S
55 1.4	08/95-10/99	AEX	1390	✳	0-N1459	VB [BT]	S
60 1.4	07/95-10/99	AEX, AKV, APQ	1390	für Fahrzeuge mit Servolenkung, ✳	0-N1445	VB [BT]	S
60 1.4	07/95-10/99	AEX, AKV, APQ	1390	✳, für Fahrzeuge mit Servolenkung	0-N1459	VB [BT]	S
64 1.9 D, 64 1.9 SDI	10/94-10/99	AEF, AGD	1896		0-N1675	VB [TE]	
64 1.9 D, 64 1.9 SDI	10/94-10/99	AEF, AGD	1896		0-N1920	VB [BT]	
64 1.9 D, 64 1.9 SDI	10/94-10/99	AEF, AGD	1896	für Artikelnummer:0-N1920	0-N1925	VB [BT]	
75 1.6	10/94-10/99	AEA, AEE, AHS	1598	✳, für Fahrzeuge mit Servolenkung	0-N1445	VB [BT]	S
POLO CLASSIC (6KV2)							
100 1.6	12/95-09/01	AFT	1595	18x121; 05/1996 →; mit Zubehör	SK-1090	BTK	
100 1.6	12/95-09/01	AEH, AFT, AKL, APF, AUR	1595	23x138; 05/1996 →; Baumuster: 6KV2	SK-1109	BTK	
100 1.6	12/95-09/01	AEH, AKL, APF, AUR	1595	23x138	SK-1109AQ1	BTKW	
110 1.9 TDI	06/98-01/02	AFN	1896	25x137; mit Zubehör	SK-1098	BTK	
110 1.9 TDI	06/98-01/02	AFN, ASV	1896	25x141; 09/1999 →; :→ASV150000; mit Zubehör	SK-1111	BTK	
110 1.9 TDI	06/98-01/02	AFN, ASV	1896	25x141; 09/1999 →; :→ASV150000; mit Zubehör	SK-1111AQ1	BTKW	
110 1.9 TDI	06/98-01/02	AFN, ASV	1896	25x141; 09/1999 →; :ASV150001→; mit Zubehör	SK-1258	BTK	
110 1.9 TDI	06/98-01/02	AFN, ASV	1896	25x141; 09/1999 →; :ASV150001→; mit Zubehör	SK-1258AQ1	BTKW	
54 1.4	01/98-08/99	ANX	1390	19x135; mit Zubehör; Baumuster: 6KV2	SK-1131	BTK	
54 1.4	01/98-08/99	ANX	1390	19x135; mit Zubehör	SK-1131AQ1	BTKW	
57 1.7 SDI	07/97-09/01	AKW	1716	25.4x137; 12/1997 →; mit Zubehör	SK-1425	BTK	
60 1.4	12/95-09/01	AEX, AKK, AKV, APQ	1390	19x135; :→AKK127806; mit Zubehör	SK-1131	BTK	
60 1.4	12/95-09/01	AEX, AKV, APQ	1390	19x135; mit Zubehör	SK-1131AQ1	BTKW	
60 1.4	12/95-09/01	AKK	1390	19x135; :→AKK127806; mit Zubehör	SK-1131AQ2	BTKW	
60 1.4	12/95-09/01	ANW, AUD	1390	19x135; mit Zubehör	SK-1592	BTK	
60 1.4	12/95-09/01	AKK	1390	19x135; :AKK127807→; mit Zubehör	SK-1592	BTK	
60 1.4	12/95-09/01	AKK, ANW, AUD	1390	19x135; :128807→; mit Zubehör	SK-1592AQ1	BTKW	
64 1.9 SDI	12/95-08/99	AEY	1896	25.4x137; mit Zubehör	SK-1122	BTK	
64 1.9 SDI	12/95-08/99	AEY	1896	25.4x137; mit Zubehör	SK-1425	BTK	
68 1.9 SDI	08/99-01/02	AGP, AQM	1896	25x141; :→AGP229903, AQM004132; mit Zubehör	SK-1110	BTK	
68 1.9 SDI	08/99-01/02	AGP, AQM	1896	25x141; :AGP229904→; :→AGP595000; mit Zubehör	SK-1111	BTK	
68 1.9 SDI	08/99-01/02	AGP, AQM	1896	25x141; :AQM004133→; :→AQM045000; mit Zubehör	SK-1111	BTK	
68 1.9 SDI	08/99-01/02	AGP	1896	25x141; :AGP229904→; :→AGP595000; mit Zubehör	SK-1111AQ1	BTKW	



OPTIMAL®

VW



CM³



Art. Nr.



POLO CLASSIC (6KV2)

68 1.9 SDI	08/99-01/02	AQM	1896	25x141; :AQM004133→; :→AQM045000; mit Zubehör	SK-1111AQ1	BTKW	
68 1.9 SDI	08/99-01/02	AGP, AQM	1896	25x141; :AGP595001, AQM045001→; mit Zubehör	SK-1258	BTK	
68 1.9 SDI	08/99-01/02	AGP	1896	25x141; :AGP595001→; mit Zubehör	SK-1258AQ1	BTKW	
68 1.9 SDI	08/99-01/02	AQM	1896	25x141; :AQM045001→; mit Zubehör	SK-1258AQ1	BTKW	
68 1.9 SDI	08/99-01/02	AGP, AQM	1896	25x141; :→AGP229903, AQM004132	SK-1259	BTK	
75 1.4 16V	10/99-09/01	APE, AUA	1390	20x130; 17x58; beinhalten Rollen: 4	SK-1511	BTK	
75 1.4 16V	10/99-09/01	APE, AUA	1390	20x130; 17x58; beinhalten Rollen: 4	SK-1511AQ1	BTKW	
75 1.6	11/95-09/97	1F	1595	18x121; mit Zubehör	SK-1026	BTK	
75 1.6	11/95-09/01	AEE, ALM	1598	19x137; 09/1997 →; mit Zubehör; Baumuster: 6KV2	SK-1074	BTK	
75 1.6	11/95-09/01	ALM	1598	19x137	SK-1074AQ1	BTKW	
90 1.8	01/97-09/01	ABS, ADD, ADZ	1781	18x121; mit Zubehör	SK-1090	BTK	
90 1.9 TDI	09/96-09/01	AHU, ALE	1896	25x137; mit Zubehör	SK-1098	BTK	
90 1.9 TDI	09/96-09/01	AGR	1896	25x141; :→AGR565000; mit Zubehör	SK-1111	BTK	
90 1.9 TDI	09/96-09/01	ALH	1896	25x141; :→ALH500000; mit Zubehör	SK-1111	BTK	
90 1.9 TDI	09/96-09/01	AGR	1896	25x141; 09/1999 →; :→AGR565000; mit Zubehör	SK-1111AQ1	BTKW	
90 1.9 TDI	09/96-09/01	ALH	1896	25x141; 09/1999 →; :→ALH500000; mit Zubehör	SK-1111AQ1	BTKW	
90 1.9 TDI	09/96-09/01	AGR, ALH	1896	25x141; :AGR565001, ALH500001→; mit Zubehör	SK-1258	BTK	
90 1.9 TDI	09/96-09/01	AGR	1896	25x141; 09/1999 →; :AGR565001→; mit Zubehör	SK-1258AQ1	BTKW	
90 1.9 TDI	09/96-09/01	ALH	1896	25x141; 09/1999 →; :ALH500001→; mit Zubehör	SK-1258AQ1	BTKW	
1.9 SDI, 64 1.9 D, 64 1.9 SDI	12/95-09/01	1Y, AEY	1896		0-N104	TB [TE]	
1.9 SDI, 64 1.9 D, 64 1.9 SDI	12/95-09/01	1Y, AEY	1896		0-N128	TB [DG]	
100 1.6	12/95-09/01	AEH, AKL, APF, AUR	1595		0-N157	TB [TE]	
100 1.6	12/95-09/01	AFT	1595		0-N805	TB [TE]	
110 1.9 TDI	06/98-01/02	AFN	1896		0-N104	TB [TE]	
110 1.9 TDI	06/98-01/02	ASV	1896		0-N107	TB [TE]	
110 1.9 TDI	06/98-01/02	AFN	1896		0-N128	TB [DG]	
110 1.9 TDI	06/98-01/02	ASV	1896		0-N131	TB [DG]	
110 1.9 TDI	06/98-01/02	ASV	1896		0-N166	TB [DG]	
110 1.9 TDI	06/98-01/02	ASV	1896		0-N167	TB [DG]	
54 1.4	01/98-08/99	ANX	1390		0-N106	TB [TE]	
57 1.7 SDI	07/97-09/01	AKW	1716		0-N104	TB [TE]	
57 1.7 SDI	07/97-09/01	AKW	1716		0-N128	TB [DG]	
60 1.4	12/95-09/01	AEX, AKV, ANX, APQ	1390		0-N106	TB [TE]	
60 1.4	12/95-09/01	AKK	1390	:→127806	0-N106	TB [TE]	
60 1.4	12/95-09/01	ANW, AUD	1390		0-N1331	TB [TE]	
60 1.4	12/95-09/01	AKK	1390	:127807→	0-N1331	TB [TE]	
68 1.9 SDI	08/99-01/02	AGP, AQM	1896		0-N107	TB [TE]	
68 1.9 SDI	08/99-01/02	AGP, AQM	1896		0-N131	TB [DG]	
68 1.9 SDI	08/99-01/02	AGP, AQM	1896		0-N166	TB [DG]	
68 1.9 SDI	08/99-01/02	AQM	1896	:004059→	0-N167	TB [DG]	
68 1.9 SDI	08/99-01/02	AGP	1896	:229903→	0-N167	TB [DG]	
75 1.4 16V	10/99-09/01	APE, AUA	1390		0-N1262	TB [DG]	
75 1.4 16V	10/99-09/01	APE, AUA	1390		0-N1263	TB [TE]	
75 1.4 16V	10/99-09/01	APE, AUA	1390		0-N158	TB [TE]	
75 1.4 16V	10/99-09/01	APE, AUA	1390		0-N164	TB [DG]	
75 1.6	11/95-09/01	AEE, ALM	1598		0-N106	TB [TE]	
75 1.6	11/95-09/97	1F	1595		0-N805	TB [TE]	
90 1.8	01/97-09/01	ABS, ADD, ADZ	1781		0-N805	TB [TE]	
90 1.9 TDI	09/96-09/01	AHU, ALE	1896		0-N104	TB [TE]	
90 1.9 TDI	09/96-09/01	AGR, ALH	1896		0-N107	TB [TE]	
90 1.9 TDI	09/96-09/01	AHU, ALE	1896		0-N128	TB [DG]	
90 1.9 TDI	09/96-09/01	AGR, ALH	1896		0-N131	TB [DG]	
90 1.9 TDI	09/96-09/01	AGR, ALH	1896		0-N166	TB [DG]	
90 1.9 TDI	09/96-09/01	AGR, ALH	1896		0-N167	TB [DG]	
1.9 SDI, 64 1.9 D, 64 1.9 SDI	12/95-09/01	1Y, AEY	1896		0-N1417	VB [TE]	
100 1.6	12/95-09/01	AEH, AKL, APF	1595		0-N1041	VB [BT]	S
100 1.6	12/95-09/01	AFT	1595		0-N1417	VB [TE]	
100 1.6	12/95-09/01	AFT	1595		0-N1660	VB [BT]	
110 1.9 TDI	06/98-01/02	AFN	1896		0-N1417	VB [TE]	



CM³



Art. Nr.



POLO CLASSIC (6KV2)							
110 1.9 TDI	06/98-01/02	ASV	1896			0-N1538	VB [BT] S
110 1.9 TDI	06/98-01/02	AFN	1896			0-N1609	VB [BT]
110 1.9 TDI	06/98-01/02	ASV	1896			0-N174	VB [DG]
54 1.4, 60 1.4, 75 1.4 16V	12/95-09/01	AEX, AKK, AKV, ANW, APQ, AUD, ANX, APE, AUA	1390	für Fahrzeuge mit Servolenkung		0-N1445	VB [BT] S
54 1.4, 60 1.4, 75 1.4 16V	12/95-09/01	AEX, AKK, AKV, ANW, APQ, AUD, ANX, APE, AUA	1390	☼		0-N1459	VB [BT] S
57 1.7 SDI	07/97-09/01	AKW	1716			0-N1417	VB [TE]
57 1.7 SDI	07/97-09/01	AKW	1716			0-N1609	VB [BT]
64 1.9 D, 64 1.9 SDI	12/95-08/99	1Y, AEY	1896			0-N1609	VB [BT]
68 1.9 SDI	08/99-01/02	AGP, AQM	1896			0-N1606	VB [BT] S
68 1.9 SDI	08/99-01/02	AGP, AQM	1896			0-N174	VB [DG]
75 1.6	11/95-09/97	1F	1595			0-N1417	VB [TE]
75 1.6	11/95-09/01	AEE, ALM	1598	für Fahrzeuge mit Servolenkung		0-N1445	VB [BT] S
75 1.6	11/95-09/01	AEE, ALM	1598	☼		0-N1459	VB [BT] S
75 1.6	11/95-09/01	AEE, ALM	1598			0-N1660	VB [BT]
75 1.6	11/95-09/97	1F	1595			0-N1660	VB [BT]
90 1.8	01/97-09/01	ABS, ADD, ADZ	1781			0-N1417	VB [TE]
90 1.8	01/97-09/01	ABS, ADD, ADZ	1781			0-N1660	VB [BT]
90 1.9 TDI	09/96-09/01	AHU, ALE	1896			0-N1417	VB [TE]
90 1.9 TDI	09/96-09/01	AGR, ALH	1896			0-N1538	VB [BT] S
90 1.9 TDI	09/96-09/01	AHU, ALE	1896			0-N1609	VB [BT]
90 1.9 TDI	09/96-09/01	AGR, ALH	1896			0-N174	VB [DG]
POLO Kasten (6NF)							
1.0	10/94-12/99	AEV, AEV	1043	19x132		SK-1344	BTK
1.0	10/94-12/99	AEV, AEV	1043	19x132		SK-1344AQ1	BTKW
1.4	05/98-12/99	AEX	1390	19x135; mit Zubehör		SK-1131	BTK
1.4	05/98-12/99	AEX, APQ	1390	19x135; mit Zubehör		SK-1131AQ1	BTKW
1.7 SDI	08/97-12/99	AKU	1716	23x137; mit Zubehör		SK-1106	BTK
1.9 D, 1.9 SDI	10/94-12/99	AEF, AGD	1896	25.4x137; mit Zubehör		SK-1425	BTK
1.9 D, 1.9 SDI	10/94-12/99	AEF, AGD	1896	23x137; mit Zubehör		SK-1512	BTK
1.9 SDI	07/96-12/99	AGD	1896	23x137; mit Zubehör		SK-1106	BTK
1.4	05/98-12/99	AEX, APQ	1390			0-N106	TB [TE]
1.7 SDI	08/97-12/99	AKU	1716			0-N111	TB [TE]
1.7 SDI	08/97-12/99	AKU	1716			0-N128	TB [DG]
1.9 D, 1.9 SDI	10/94-12/99	AEF, AGD	1896			0-N111	TB [TE]
1.9 SDI	07/96-12/99	AGD	1896			0-N128	TB [DG]
1.4	05/98-12/99	AEX, APQ	1390	für Fahrzeuge mit Servolenkung		0-N1445	VB [BT] S
1.4	05/98-12/99	AEX, APQ	1390	☼		0-N1459	VB [BT] S
1.7 SDI	08/97-12/99	AKU	1716			0-N1675	VB [TE]
1.7 SDI	08/97-12/99	AKU	1716			0-N1920	VB [BT]
1.7 SDI	08/97-12/99	AKU	1716	für Artikelnummer:0-N1920		0-N1925	VB [BT]
1.9 D, 1.9 SDI	10/94-12/99	AEF, AGD	1896			0-N1675	VB [TE]
1.9 D, 1.9 SDI	10/94-12/99	AEF, AGD	1896			0-N1920	VB [BT]
1.9 D, 1.9 SDI	10/94-12/99	AEF, AGD	1896	für Artikelnummer:0-N1920		0-N1925	VB [BT]
POLO Variant (6KV5)							
1.4	05/97-09/01	AEX, AKK, AKV, APQ	1390	19x135; ☼:→AKK127806; mit Zubehör		SK-1131	BTK
1.4	05/97-09/01	AEX, AKV, APQ	1390	19x135; mit Zubehör		SK-1131AQ1	BTKW
1.4	05/97-09/01	AKK	1390	19x135; ☼:→AKK127806; mit Zubehör		SK-1131AQ2	BTKW
1.4	05/97-09/01	ANW	1390	19x135; mit Zubehör		SK-1592	BTK
1.4	05/97-09/01	AKK	1390	19x135; ☼:AKK127807→; mit Zubehör		SK-1592	BTK
1.4	05/97-09/01	AKK, ANW	1390	19x135; ☼:128807→; mit Zubehör		SK-1592AQ1	BTKW
1.4	12/98-09/01	AKP	1390	19x135; ch.→6N-Y-600000; mit Zubehör		SK-1131	BTK
1.4	12/98-09/01	AKP	1390	19x135; ch.→6N-Y-600000; mit Zubehör		SK-1131AQ2	BTKW
1.4	12/98-09/01	AKP	1390	19x135; ch.6N-Y-600001→; mit Zubehör		SK-1592	BTK
1.4	12/98-09/01	AKP	1390	19x135; ch.6N-Y-600001→; mit Zubehör		SK-1592AQ1	BTKW
1.4 16V	10/99-09/01	APE, AUA	1390	20x130; 17x58; beinhaltetete Rollen: 4		SK-1511	BTK
1.4 16V	10/99-09/01	APE, AUA	1390	20x130; 17x58; beinhaltetete Rollen: 4		SK-1511AQ1	BTKW
1.6	05/97-09/01	AEE, ALM	1598	19x137; mit Zubehör; Baumuster: 6KV5		SK-1074	BTK
1.6	05/97-09/01	ALM	1598	19x137		SK-1074AQ1	BTKW
1.6	05/97-09/01	AFT	1595	18x121; mit Zubehör		SK-1090	BTK
1.6	05/97-09/01	AEH, AFT, AKL, APF, AUR	1595	23x138; Baumuster: 6KV5		SK-1109	BTK
1.6	05/97-09/01	AEH, AKL, APF, AUR	1595	23x138		SK-1109AQ1	BTKW
1.7 SDI	08/97-09/01	AKW	1716	25.4x137; 12/1997 →; mit Zubehör		SK-1425	BTK
1.8	05/97-09/01	ADZ	1781	18x121; mit Zubehör		SK-1090	BTK



OPTIMAL®

VW



CM³



Art. Nr.



ohne Halter

POLO Variant (6KV5)

1.9 SDI	06/97-09/01	AEY	1896	25.4x137; → 08/1999; mit Zubehör	SK-1425	BTK
1.9 SDI	08/99-09/01	AGP, AQM	1896	25x141; :→AGP229903, AQM004132; mit Zubehör	SK-1110	BTK
1.9 SDI	08/99-09/01	AGP, AQM	1896	25x141; :AGP229904→; :→AGP595000; mit Zubehör	SK-1111	BTK
1.9 SDI	08/99-09/01	AGP, AQM	1896	25x141; :AQM004133→; :→AQM045000; mit Zubehör	SK-1111	BTK
1.9 SDI	08/99-09/01	AGP	1896	25x141; :AGP229904→; :→AGP595000; mit Zubehör	SK-1111AQ1	BTKW
1.9 SDI	08/99-09/01	AQM	1896	25x141; :AQM004133→; :→AQM045000; mit Zubehör	SK-1111AQ1	BTKW
1.9 SDI	08/99-09/01	AGP, AQM	1896	25x141; :AGP595001, AQM045001→; mit Zubehör	SK-1258	BTK
1.9 SDI	08/99-09/01	AGP	1896	25x141; :AGP595001→; mit Zubehör	SK-1258AQ1	BTKW
1.9 SDI	08/99-09/01	AQM	1896	25x141; :AQM045001→; mit Zubehör	SK-1258AQ1	BTKW
1.9 SDI	08/99-09/01	AGP, AQM	1896	25x141; :→AGP229903, AQM004132	SK-1259	BTK
1.9 TDI	05/97-09/01	AHU, ALE	1896	25x137; mit Zubehör	SK-1098	BTK
1.9 TDI	05/97-09/01	AGR	1896	25x141; :→AGR565000; mit Zubehör	SK-1111	BTK
1.9 TDI	05/97-09/01	ALH	1896	25x141; :→ALH500000; mit Zubehör	SK-1111	BTK
1.9 TDI	05/97-09/01	AGR	1896	25x141; 09/1999 →; :→AGR565000; mit Zubehör	SK-1111AQ1	BTKW
1.9 TDI	05/97-09/01	ALH	1896	25x141; 09/1999 →; :→ALH500000; mit Zubehör	SK-1111AQ1	BTKW
1.9 TDI	05/97-09/01	AGR, ALH	1896	25x141; :AGR565001, ALH500001→; mit Zubehör	SK-1258	BTK
1.9 TDI	05/97-09/01	AGR	1896	25x141; 09/1999 →; :AGR565001→; mit Zubehör	SK-1258AQ1	BTKW
1.9 TDI	05/97-09/01	ALH	1896	25x141; 09/1999 →; :ALH500001→; mit Zubehör	SK-1258AQ1	BTKW
1.9 TDI	06/98-09/01	AFN	1896	25x137; mit Zubehör	SK-1098	BTK
1.9 TDI	06/98-09/01	ASV	1896	25x141; :→ASV150000; mit Zubehör	SK-1111	BTK
1.9 TDI	06/98-09/01	AFN, ASV	1896	25x141; 09/1999 →; :→ASV150000; mit Zubehör	SK-1111AQ1	BTKW
1.9 TDI	06/98-09/01	ASV	1896	25x141; :ASV150001→; mit Zubehör	SK-1258	BTK
1.9 TDI	06/98-09/01	AFN, ASV	1896	25x141; 09/1999 →; :ASV150001→; mit Zubehör	SK-1258AQ1	BTKW
1.4	05/97-09/01	AEX, AKV, ANX, APQ	1390		0-N106	TB [TE]
1.4	05/97-09/01	AKK	1390	:→127806	0-N106	TB [TE]
1.4	05/97-09/01	ANW, AUD	1390		0-N1331	TB [TE]
1.4	05/97-09/01	AKK	1390	:127807→	0-N1331	TB [TE]
1.4	12/98-09/01	AKP	1390	ch.→6N-Y-600000	0-N106	TB [TE]
1.4	12/98-09/01	AKP	1390	ch.6N-Y-600001→	0-N1331	TB [TE]
1.4 16V	10/99-09/01	APE, AUA	1390		0-N1262	TB [DG]
1.4 16V	10/99-09/01	APE, AUA	1390		0-N1263	TB [TE]
1.4 16V	10/99-09/01	APE, AUA	1390		0-N158	TB [TE]
1.4 16V	10/99-09/01	APE, AUA	1390		0-N164	TB [DG]
1.6	05/97-09/01	AEE, ALM	1598		0-N106	TB [TE]
1.6	05/97-09/01	AEH, AKL, APF, AUR	1595		0-N157	TB [TE]
1.6	05/97-09/01	AFT	1595		0-N805	TB [TE]
1.7 SDI	08/97-09/01	AKW	1716		0-N104	TB [TE]
1.7 SDI	08/97-09/01	AKW	1716		0-N128	TB [DG]
1.8	05/97-09/01	ADZ	1781		0-N805	TB [TE]
1.9 SDI	06/97-09/01	AEY	1896		0-N104	TB [TE]
1.9 SDI	06/97-09/01	AEY	1896		0-N128	TB [DG]
1.9 SDI	08/99-09/01	AQM	1896	:→004131	0-N107	TB [TE]
1.9 SDI	08/99-09/01	AGP	1896	:→229902	0-N107	TB [TE]
1.9 SDI	08/99-09/01	AQM	1896	:004059→	0-N107	TB [TE]
1.9 SDI	08/99-09/01	AGP	1896	:229903→	0-N107	TB [TE]
1.9 SDI	08/99-09/01	AGP, AQM	1896		0-N131	TB [DG]
1.9 SDI	08/99-09/01	AGP, AQM	1896		0-N166	TB [DG]
1.9 SDI	08/99-09/01	AQM	1896	:004059→	0-N167	TB [DG]
1.9 SDI	08/99-09/01	AGP	1896	:229903→	0-N167	TB [DG]
1.9 TDI	05/97-09/01	AHU, ALE	1896		0-N104	TB [TE]
1.9 TDI	05/97-09/01	AGR, ALH	1896		0-N107	TB [TE]
1.9 TDI	05/97-09/01	AHU, ALE	1896		0-N128	TB [DG]
1.9 TDI	05/97-09/01	AGR, ALH	1896		0-N131	TB [DG]
1.9 TDI	05/97-09/01	AGR, ALH	1896		0-N166	TB [DG]
1.9 TDI	05/97-09/01	AGR, ALH	1896		0-N167	TB [DG]
1.9 TDI	06/98-09/01	AFN	1896		0-N104	TB [TE]



CM³



Art. Nr.



ohne Halter

POLO Variant (6KV5)							
1.9 TDI	06/98-09/01	ASV	1896		0-N107	TB [TE]	
1.9 TDI	06/98-09/01	AFN	1896		0-N128	TB [DG]	
1.9 TDI	06/98-09/01	ASV	1896		0-N131	TB [DG]	
1.9 TDI	06/98-09/01	ASV	1896		0-N166	TB [DG]	
1.9 TDI	06/98-09/01	ASV	1896		0-N167	TB [DG]	
1.4	12/98-09/01	AKP	1390	☼, für Fahrzeuge mit Servolenkung	0-N1445	VB [BT]	S
1.4, 1.4 16V	05/97-09/01	AEX, AKK, AKV, ANW, APQ, AUD, APE, AUA	1390	für Fahrzeuge mit Servolenkung	0-N1445	VB [BT]	S
1.4, 1.4 16V	05/97-09/01	AEX, AKK, AKV, ANW, APQ, AUD, APE, AUA	1390	☼	0-N1459	VB [BT]	S
1.6	05/97-09/01	AEH, AKL, APF	1595		0-N1041	VB [BT]	S
1.6	05/97-09/01	AFT	1595		0-N1417	VB [TE]	
1.6	05/97-09/01	AEE, ALM	1598	für Fahrzeuge mit Servolenkung	0-N1445	VB [BT]	S
1.6	05/97-09/01	AEE, ALM	1598	☼	0-N1459	VB [BT]	S
1.6	05/97-09/01	AFT	1595		0-N1660	VB [BT]	
1.7 SDI	08/97-09/01	AKW	1716		0-N1417	VB [TE]	
1.7 SDI	08/97-09/01	AKW	1716		0-N1609	VB [BT]	
1.8	05/97-09/01	ADZ	1781		0-N1417	VB [TE]	
1.8	05/97-09/01	ADZ	1781		0-N1660	VB [BT]	
1.9 SDI	06/97-09/01	AEY	1896		0-N1417	VB [TE]	
1.9 SDI	06/97-09/01	AEY	1896		0-N1609	VB [BT]	
1.9 SDI	08/99-09/01	AGP, AQM	1896		0-N1606	VB [BT]	S
1.9 SDI	08/99-09/01	AGP, AQM	1896		0-N174	VB [DG]	
1.9 TDI	05/97-09/01	AHU, ALE	1896		0-N1417	VB [TE]	
1.9 TDI	05/97-09/01	AGR, ALH	1896		0-N1538	VB [BT]	S
1.9 TDI	05/97-09/01	AHU, ALE	1896		0-N1609	VB [BT]	
1.9 TDI	05/97-09/01	AGR, ALH	1896		0-N174	VB [DG]	
1.9 TDI	06/98-09/01	AFN	1896		0-N1417	VB [TE]	
1.9 TDI	06/98-09/01	ASV	1896		0-N1538	VB [BT]	S
1.9 TDI	06/98-09/01	AFN	1896		0-N1609	VB [BT]	
1.9 TDI	06/98-09/01	ASV	1896		0-N174	VB [DG]	
POLO (6N2)							
1.0	10/99-09/01	ALD, AUC	999	19x135; ch.→6N-Y-600000; mit Zubehör	SK-1131	BTK	
1.0	10/99-09/01	ALD, AUC	999	19x135; ch.→6N-Y-600000; mit Zubehör	SK-1131AQ2	BTKW	
1.0	10/99-09/01	ALD, AUC	999	19x135; ch.6N-Y-600001→; mit Zubehör	SK-1592	BTK	
1.4	10/99-09/01	AKK, AUD	1390	19x135; ch.→6N-Y-600000; mit Zubehör	SK-1131	BTK	
1.4	10/99-09/01	AKP, ANX	1390	19x135; ch.→6N-Y-600000; mit Zubehör	SK-1131	BTK	
1.4	10/99-09/01	AKK, AUD	1390	19x135; mit Zubehör	SK-1131AQ1	BTKW	
1.4	10/99-09/01	ANX	1390	19x135; mit Zubehör	SK-1131AQ1	BTKW	
1.4	10/99-09/01	AKK, AUD	1390	19x135; 06/2000 →; : →AKK127806; mit Zubehör	SK-1131AQ2	BTKW	
1.4	10/99-09/01	AKK, AUD	1390	19x135; ch.→6N-Y-600000; mit Zubehör	SK-1131AQ2	BTKW	
1.4	10/99-09/01	AKP	1390	19x135; ch.→6N-Y-600000; mit Zubehör	SK-1131AQ2	BTKW	
1.4	10/99-09/01	AKK, AUD	1390	19x135; ch.6N-Y-600001→; mit Zubehör	SK-1592	BTK	
1.4	10/99-09/01	AKP	1390	19x135; ch.6N-Y-600001→; mit Zubehör	SK-1592	BTK	
1.4	10/99-09/01	AKK, AUD, AKP, ANX	1390	19x135; ch.6N-Y-600001→; mit Zubehör	SK-1592AQ1	BTKW	
1.4 16V	10/99-09/01	AFK, AQQ, AUB	1390	20x130; 17x58; beinhaltetete Rollen: 4	SK-1511	BTK	
1.4 16V	10/99-09/01	AHW, APE, AUA	1390	20x130; 17x58; beinhaltetete Rollen: 4	SK-1511	BTK	
1.4 16V	10/99-09/01	AFK, AQQ, AUB, AHW, APE, AUA	1390	20x130; 17x58; beinhaltetete Rollen: 4	SK-1511AQ1	BTKW	
1.4 16V	10/99-09/01	AFK, AQQ, AUB	1390	25x149	SK-1635	BTK	
1.4 16V	10/99-09/01	AFK, AQQ, AUB	1390	25x149	SK-1635AQ1	BTKW	
1.4 TDI	10/99-09/01	AMF	1422	30x120; ch.9N-2-050001→; mit Zubehör	SK-1372	BTK	
1.4 TDI	10/99-09/01	AMF	1422	30x120; : →AMF011494; mit Spanndämpfer, Spannrolle; mit Zubehör; Baumuster: 6N2	SK-1378	BTK	
1.4 TDI	10/99-09/01	AMF	1422	30x120; : →AMF011494; ohne Spanndämpfer, Spannrolle; mit Zubehör; Baumuster: 6N2	SK-1388	BTK	
1.4 TDI	10/99-09/01	AMF	1422	30x120; ch.→9N-2-050000; :AMF011495→; mit Zubehör; Baumuster: 6N2	SK-1582	BTK	
1.4 TDI	10/99-09/01	AMF	1422	30x120; :AMF011495→; ohne Spanndämpfer, Spannrolle; mit Zubehör	SK-1582AQ2	BTKW	
1.4 TDI	10/99-09/01	AMF	1422	30x120; ch.→9N-2-050000; :AMF011495→; mit Spanndämpfer, Spannrolle; mit Zubehör; Baumuster: 6N2	SK-1583	BTK	
1.4 TDI	10/99-09/01	AMF	1422	30x120; :AMF011495→; mit Spanndämpfer, Spannrolle; mit Zubehör	SK-1583AQ2	BTKW	



CM³

**Art. Nr.****ohne Halter**

POLO (6N2)

1.4 TDi	01/00-10/00	ATL	1422	30x120; mit Zubehör	SK-1372	BTK
1.6 16V GTI	10/99-09/01	ARC, AVY	1598	20x130; 17x58; beinhaltetete Rollen: 4	SK-1511	BTK
1.6 16V GTI	10/99-09/01	ARC, AVY	1598	20x130; 17x58; beinhaltetete Rollen: 4	SK-1511AQ2	BTKW
1.7 SDI	10/99-09/01	AKU	1716	23x137; mit Zubehör	SK-1106	BTK
1.9 D	10/99-09/01	AEF	1896	25x141; 04/2001 →	SK-1259	BTK
1.9 D, 1.9 SDI	10/99-09/01	AEF, AGD, ASX	1896	23x137; mit Zubehör	SK-1106	BTK
1.9 D, 1.9 SDI	10/99-09/01	AEF, AGD, ASX	1896	23x137; mit Zubehör	SK-1512	BTK
1.0	10/99-09/01	ALD, AUC	999	ch.→6N-Y-600000	0-N106	TB [TE]
1.0	10/99-09/01	ALD, AUC	999	ch.6N-Y-600001→	0-N1331	TB [TE]
1.4	10/99-09/01	ANX	1390		0-N106	TB [TE]
1.4	10/99-09/01	AKK, AUD	1390	ch.→6N-Y-600000	0-N106	TB [TE]
1.4	10/99-09/01	AKP	1390	ch.→6N-Y-600000	0-N106	TB [TE]
1.4	10/99-09/01	AKK, AUD	1390	ch.6N-Y-600001→	0-N1331	TB [TE]
1.4	10/99-09/01	AKP	1390	ch.6N-Y-600001→	0-N1331	TB [TE]
1.4 16V	10/99-09/01	AFK, AQQ, AUB, AHW, APE, AUA	1390		0-N1262	TB [DG]
1.4 16V	10/99-09/01	AFK, AQQ, AUB, AHW, APE, AUA	1390		0-N1263	TB [TE]
1.4 16V	10/99-09/01	AFK, AQQ, AUB, AHW, APE, AUA	1390		0-N158	TB [TE]
1.4 16V	10/99-09/01	AFK, AQQ, AUB, AHW, APE, AUA	1390		0-N164	TB [DG]
1.4 TDI	10/99-09/01	AMF	1422	ch.9N-2-050001→	0-N1045	TB [TE]
1.4 TDI	10/99-09/01	AMF	1422	:011495→	0-N1048	TB [TE]
1.4 TDI	10/99-09/01	AMF	1422	:→011494	0-N1049	TB [BT]
1.4 TDI	10/99-09/01	AMF	1422	:→011494; mit Anbaumaterial	0-N1265	TB [TE]
1.4 TDI	10/99-09/01	AMF	1422		0-N1268	TB [DG]
1.4 TDI	10/99-09/01	AMF	1422	:011495→	0-N1274	TB [BT]
1.4 TDi	01/00-10/00	ATL	1422		0-N1046	TB [DG]
1.6 16V GTI	10/99-09/01	ARC, AVY	1598		0-N1262	TB [DG]
1.6 16V GTI	10/99-09/01	ARC, AVY	1598		0-N1263	TB [TE]
1.6 16V GTI	10/99-09/01	ARC, AVY	1598		0-N158	TB [TE]
1.6 16V GTI	10/99-09/01	ARC, AVY	1598		0-N164	TB [DG]
1.7 SDI	10/99-09/01	AKU	1716		0-N111	TB [TE]
1.7 SDI	10/99-09/01	AKU	1716		0-N128	TB [DG]
1.9 D, 1.9 SDI	10/99-09/01	AEF, AGD, ASX	1896		0-N111	TB [TE]
1.9 SDI	10/99-09/01	AGD, ASX	1896		0-N128	TB [DG]
1.0	10/99-09/01	ALD, AUC	999	✳, für Fahrzeuge ohne Servolenkung	0-N1445	VB [BT] S
1.4	10/99-09/01	AKK, AUD	1390	für Fahrzeuge mit Servolenkung	0-N1445	VB [BT] S
1.4	10/99-09/01	AKP, ANX	1390	✳, für Fahrzeuge mit Servolenkung	0-N1445	VB [BT] S
1.4 16V	10/99-09/01	AFK, AQQ, AUB	1390		0-N1445	VB [BT] S
1.4 16V	10/99-09/01	AHW, APE, AUA	1390	✳	0-N1445	VB [BT] S
1.4 TDI	10/99-09/01	AMF	1422		0-N1041	VB [BT] S
1.6 16V GTI	10/99-09/01	ARC, AVY	1598	✳	0-N1445	VB [BT] S
1.7 SDI	10/99-09/01	AKU	1716		0-N1675	VB [TE]
1.7 SDI	10/99-09/01	AKU	1716		0-N1920	VB [BT]
1.7 SDI	10/99-09/01	AKU	1716	für Artikelnummer:0-N1920	0-N1925	VB [BT]
1.9 D, 1.9 SDI	10/99-09/01	AEF, AGD, ASX	1896		0-N1675	VB [TE]
1.9 D, 1.9 SDI	10/99-09/01	AEF, AGD, ASX	1896		0-N1920	VB [BT]
1.9 D, 1.9 SDI	10/99-09/01	AEF, AGD, ASX	1896	für Artikelnummer:0-N1920	0-N1925	VB [BT]

POLO Stufenheck (9A4)

1.4	07/03-	BBY, BKY, BBZ	1390	20x130; 17x58; ch.→9N-6P027500; beinhaltetete Rollen: 4	SK-1511	BTK
1.4	07/03-	BBY, BKY, BBZ	1390	20x130; 17x58; beinhaltetete Rollen: 4	SK-1511AQ1	BTKW
1.4 TDI	07/03-	BAY	1422	30x120; ch.9N-2-050001→; mit Zubehör	SK-1372	BTK
1.4 TDI	07/03-	BAY	1422	30x120; ch.9N-2-044001→; 9N-2-100000	SK-1372AQ1	BTKW
1.4 TDI	07/03-	BAY	1422	30x120; ch.9N-2-100001→	SK-1372AQ1	BTKW
1.4 TDI	07/03-	BAY	1422	30x120; ch.→9N-2-050000; mit Zubehör; Baumuster: 9A4	SK-1582	BTK
1.4 TDI	07/03-	BAY	1422	30x120; ch.→9N-2-044000; ohne Spanndämpfer, Spannrolle; mit Zubehör	SK-1582AQ2	BTKW
1.4 TDI	07/03-	BAY	1422	30x120; ch.→9N-2-050000; mit Spanndämpfer, Spannrolle; mit Zubehör; Baumuster: 9A4	SK-1583	BTK
1.4 TDI	07/03-	BAY	1422	30x120; ch.→9N-2-044000; mit Spanndämpfer, Spannrolle; mit Zubehör	SK-1583AQ2	BTKW
1.6	09/02-	BAH, BPA, CFZA	1598	19x135; mit Zubehör	SK-1592	BTK
1.9 SDI	09/02-	ASY	1896	25x141; :→021000; mit Zubehör	SK-1110	BTK
1.9 SDI	09/02-	ASY	1896	25x141	SK-1259	BTK
1.9 TDi	09/02-	ATD	1896	30x120; mit Zubehör	SK-1372	BTK



CM³



Art. Nr.



ohne Halter

POLO Stufenheck (9A4)

1.9 TDi	09/02-	ATD	1896	30x120; ch.9N-2-100001→	SK-1372AQ1	BTKW	
1.4	07/03-	BBY, BKY, BBZ	1390		0-N1262	TB [DG]	
1.4	07/03-	BBY, BKY, BBZ	1390		0-N1263	TB [TE]	
1.4	07/03-	BBY, BKY, BBZ	1390		0-N158	TB [TE]	
1.4	07/03-	BBY	1390		0-N164	TB [DG]	
1.4	07/03-	BKY	1390	ch.→9N-6-300000	0-N164	TB [DG]	
1.4	11/03-	BBZ	1390		0-N164	TB [DG]	
1.4 TDI	07/03-	BAY	1422	ch.9N-2-050001→	0-N1045	TB [TE]	
1.4 TDI	07/03-	BAY	1422		0-N1046	TB [DG]	
1.4 TDI	07/03-	BAY	1422	ch.→9N-2-050000	0-N1274	TB [BT]	
1.6	09/02-	BAH, BPA, CFZA	1598		0-N1331	TB [TE]	
1.9 SDI	09/02-	ASY	1896	→ 09/2009	0-N107	TB [TE]	
1.9 SDI	09/02-	ASY	1896		0-N131	TB [DG]	
1.9 SDI	09/02-	ASY	1896		0-N166	TB [DG]	
1.9 TDi	09/02-	ATD	1896		0-N1045	TB [TE]	
1.9 TDi	09/02-	ATD	1896		0-N1046	TB [DG]	
1.4	07/03-	BBY, BKY, BBZ	1390		0-N1445	VB [BT]	S
1.4 TDI	07/03-	BAY	1422		0-N1704	VB [BT]	S
1.6	09/02-	BAH, BPA, CFZA	1598	☛, für Fahrzeuge mit Servolenkung	0-N1445	VB [BT]	S
1.9 SDI	09/02-	ASY	1896		0-N1536	VB [BT]	S
1.9 SDI, 1.9 TDi	09/02-	CBAB, CFFB	1896		0-N1534	VB [BT]	S

POLO (9N_)

1.4 16V	10/01-05/08	AUA, BBY	1390	20x130; 17x58; beinhaltetete Rollen: 4	SK-1511	BTK	
1.4 16V	10/01-05/08	BKY	1390	20x130; 17x58; ch.→9N-7-000000; beinhaltetete Rollen: 4	SK-1511	BTK	
1.4 16V	10/01-11/09	AUB, BBZ, BUD	1390	20x130; 17x58; beinhaltetete Rollen: 4	SK-1511	BTK	
1.4 16V	10/01-11/09	AUA, BBY, BKY, AUB, BBZ, BUD	1390	20x130; 17x58; beinhaltetete Rollen: 4	SK-1511AQ1	BTKW	
1.4 TDI	10/01-06/05	AMF, BAY	1422	30x120; ch.9N-2-050001→; mit Zubehör	SK-1372	BTK	
1.4 TDI	10/01-06/05	AMF, BAY	1422	30x120; ch.9N-2-044001→; 9N-2-100000	SK-1372AQ1	BTKW	
1.4 TDI	10/01-06/05	AMF, BAY	1422	30x120; ch.9N-2-100001→	SK-1372AQ1	BTKW	
1.4 TDI	10/01-06/05	AMF	1422	30x120; ^(9N1) →AMF011494; mit Spanndämpfer, Spannrolle; mit Zubehör; Baumuster: 9N1	SK-1378	BTK	
1.4 TDI	10/01-06/05	AMF, BAY	1422	30x120; ^(9N1) →AMF011494; ohne Spanndämpfer, Spannrolle; mit Zubehör; Baumuster: 9N1	SK-1388	BTK	
1.4 TDI	10/01-06/05	AMF, BAY	1422	30x120; ch.→9N-2-050000; ^(9N1) →AMF011495→; mit Zubehör; Baumuster: 9N1	SK-1582	BTK	
1.4 TDI	10/01-06/05	AMF, BAY	1422	30x120; ch.→9N-2-044000; ohne Spanndämpfer, Spannrolle; mit Zubehör	SK-1582AQ2	BTKW	
1.4 TDI	10/01-06/05	AMF, BAY	1422	30x120; ch.→9N-2-050000; ^(9N1) →AMF011495→; mit Spanndämpfer, Spannrolle; mit Zubehör; Baumuster: 9N1	SK-1583	BTK	
1.4 TDI	10/01-06/05	AMF, BAY	1422	30x120; ch.→9N-2-044000; mit Spanndämpfer, Spannrolle; mit Zubehör	SK-1583AQ2	BTKW	
1.4 TDI	04/05-11/09	BMS, BNV, BNM, BWB	1422	30x120; mit Zubehör	SK-1372	BTK	
1.4 TDI	04/05-11/09	BMS, BNV, BNM, BWB	1422	30x120	SK-1372AQ1	BTKW	
1.4, 1.4 FSI	02/02-11/09	AXU	1390	19x135; mit Zubehör	SK-1592	BTK	
1.6	08/02-05/05	BAH	1598	19x135; mit Zubehör	SK-1592	BTK	
1.6 Total Flex	06/08-04/09	CCRA	1599	19x135; mit Zubehör	SK-1592	BTK	
1.8 GTI	09/05-11/09	BJX	1781	23x150	SK-1661	BTK	
1.8 GTi Cup Edition	05/06-11/09	BBU	1781	23x150; 07/2006 →	SK-1661	BTK	
1.9 SDI	10/01-11/09	ASY	1896	25x141; ^(9N1) →021000; mit Zubehör	SK-1110	BTK	
1.9 SDI	10/01-11/09	ASY	1896	25x141	SK-1259	BTK	
1.9 TDI	10/01-11/09	ASZ, BLT, ATD, AXR, BMT	1896	30x120; mit Zubehör	SK-1372	BTK	
1.9 TDI	10/01-11/09	BMT	1896	30x120	SK-1372AQ1	BTKW	
1.9 TDI	10/01-11/09	ATD, AXR	1896	30x120; ch.9N-2-100001→	SK-1372AQ1	BTKW	
1.9 TDI	11/03-11/09	ASZ, BLT	1896	30x120	SK-1372AQ1	BTKW	
1.4	06/05-11/09	BLM	1390		0-N1331	TB [TE]	
1.4 16V	10/01-11/09	AUA, BBY, BKY, AUB, BBZ, BUD	1390		0-N1262	TB [DG]	
1.4 16V	10/01-11/09	AUA, BBY, BKY, AUB, BBZ, BUD	1390		0-N1263	TB [TE]	
1.4 16V	10/01-11/09	AUA, BBY, BKY, AUB, BBZ, BUD	1390		0-N158	TB [TE]	
1.4 16V	10/01-05/08	AUA, BBY	1390		0-N164	TB [DG]	
1.4 16V	10/01-05/08	AUB, BBZ	1390		0-N164	TB [DG]	
1.4 16V	10/01-05/08	BKY	1390	ch.→9N-6-300000	0-N164	TB [DG]	
1.4 TDI	10/01-06/05	AMF, BAY	1422	ch.9N-2-050001→	0-N1045	TB [TE]	
1.4 TDI	10/01-06/05	AMF, BAY	1422	ch.9N-2-050001→	0-N1046	TB [DG]	



CM³



Art. Nr.



ohne Halter

POLO (9N_)

1.4 TDI	10/01-06/05	AMF, BAY	1422	ch.→9N-2-050000	0-N1048	TB [TE]	
1.4 TDI	10/01-06/05	AMF, BAY	1422	ch.→9N-2-050000	0-N1268	TB [DG]	
1.4 TDI	10/01-06/05	AMF, BAY	1422	ch.→9N-2-050000	0-N1274	TB [BT]	
1.4 TDI	04/05-11/09	BMS, BNV	1422		0-N1045	TB [TE]	
1.4 TDI	04/05-11/09	BNM, BWB	1422		0-N1045	TB [TE]	
1.4 TDI	04/05-11/09	BMS, BNV, BNM, BWB	1422		0-N1046	TB [DG]	
1.6	08/02-05/05	BAH	1598		0-N1331	TB [TE]	
1.6 Total Flex	06/08-04/09	CCRA	1599		0-N1331	TB [TE]	
1.8 GTI, 1.8 GTI Cup Edition	09/05-11/09	BBU, BJX	1781		0-N1316	TB [DG]	
1.8 GTI, 1.8 GTI Cup Edition	09/05-11/09	BBU, BJX	1781		0-N1566	TB [TE]	
1.8 GTI, 1.8 GTI Cup Edition	09/05-11/09	BBU, BJX	1781		0-N1567	TB [BT]	
1.9 SDI	10/01-11/09	ASY	1896	→ 09/2009	0-N107	TB [TE]	
1.9 SDI	10/01-11/09	ASY	1896		0-N131	TB [DG]	
1.9 SDI	10/01-11/09	ASY	1896		0-N166	TB [DG]	
1.9 TDI	10/01-11/09	ASZ, BLT, ATD, AXR, BMT	1896		0-N1045	TB [TE]	
1.9 TDI	10/01-11/09	ASZ, BLT, ATD, AXR, BMT	1896		0-N1046	TB [DG]	
1.2, 1.2 12V	10/01-11/09	AWY, BMD, AZQ, BME, BBM, BZG	1198		0-N1908	VB [BT]	S
1.2, 1.2 12V	10/01-11/09	AWY, BMD, AZQ, BME, BBM, BZG	1198	✳	0-N1909	VB [DG]	
1.4 16V	10/01-05/08	AUA, BBY, BKY, AUB, BBZ	1390		0-N1445	VB [BT]	S
1.4 FSI	02/02-07/06	AXU	1390	†; ✳	0-N1454	VB [DG]	
1.4 FSI	02/02-07/06	AXU	1390	✳	0-N1525	VB [BT]	S
1.4 FSI	02/02-07/06	AXU	1390	✳	0-N1733	VB [BT]	S
1.4 TDI	10/01-06/05	AMF, BAY	1422	ch.9N-2-000001→	0-N1704	VB [BT]	S
1.4 TDI	04/05-11/09	CBAB, CBDA, CFFB	1422		0-N1534	VB [BT]	S
1.4 TDI	04/05-11/09	BNM	1422	✳	0-N1704	VB [BT]	S
1.4 TDI	04/05-11/09	BNV	1422	✳	0-N1704	VB [BT]	S
1.4, 1.4 16V	06/05-11/09	BUD	1390	✳	0-N1445	VB [BT]	S
1.6 16V	05/06-11/09	BTS	1598	†; ✳	0-N1454	VB [DG]	
1.6 16V	05/06-11/09	BTS	1598	✳	0-N1525	VB [BT]	S
1.6 16V	05/06-11/09	BTS	1598	✳	0-N1733	VB [BT]	S
1.6 Total Flex	06/08-04/09	CCRA	1599	✳	0-N1445	VB [BT]	S
1.9 SDI, 1.9 TDI	10/01-11/09	CBAB, CFFB	1896		0-N1534	VB [BT]	S
1.9 SDI, 1.9 TDI	10/01-11/09	ASY, ASZ, BLT	1896		0-N1536	VB [BT]	S
1.9 TDI	10/01-11/09	ATD, AXR	1896		0-N1536	VB [BT]	S

POLO (6R, 6C)

1.2 TDI	10/09-	CFWA	1199	25x160; → 01/2011	SK-1695	BTK	
1.2 TDI	10/09-	CFWA	1199	25x160; → 01/2011	SK-1695AQ1	BTKW	
1.2 TDI	10/09-	CFWA	1199	25x160; 02/2011 →	SK-1727	BTK	
1.2 TDI	10/09-	CFWA	1199	25x160; → 01/2011	SK-1727AQ2	BTKW	
1.4	06/09-	CGGB	1390	20x130; 17x58; beinhaltetete Rollen: 4	SK-1511	BTK	
1.4 BiFuel	03/10-01/11	CMAA	1390	20x130; 17x58; beinhaltetete Rollen: 4	SK-1511	BTK	
1.4, 1.4 BiFuel	06/09-01/11	CDDA, CGGB, CLPA, CMAA	1390	20x130; 17x58; beinhaltetete Rollen: 4	SK-1511AQ1	BTKW	
1.6 TDI	06/09-	CAYA, CAYB, CAYC, CLNA	1598	25x160	SK-1695	BTK	
1.6 TDI	06/09-	CAYA, CAYB, CAYC, CLNA	1598	25x160; → 11/2010	SK-1695AQ1	BTKW	
1.6 TDI	06/09-	CAYC, CLNA	1598	25x160; → 11/2010	SK-1727AQ2	BTKW	
2.0 R WRC	08/13-	CDLJ	1984	23x148	SK-1724	BTK	
2.0 R WRC	08/13-	CDLJ	1984	23x148	SK-1724AQ1	BTKW	
1.0	01/14-	CHYA, CHYB	999		0-N2381	TB [DG]	
1.0, 1.0 TSI	01/14-	CHYA, CHYB, CHZC	999		0-N2313	TB [TE]	
1.2 TDI	10/09-	CFWA	1199		0-N131	TB [DG]	
1.2 TDI	10/09-	CFWA	1199		0-N2025	TB [DG]	
1.2 TDI	10/09-	CFWA	1199		0-N2200	TB [DG]	
1.2 TSI, 1.2 TSI 16V	01/14-	CJZC, CJZD	1197		0-N2313	TB [TE]	
1.2 TSI, 1.2 TSI 16V	01/14-	CJZC, CJZD	1197		0-N2381	TB [DG]	
1.4	06/09-	CGGB	1390		0-N1262	TB [DG]	
1.4	06/09-	CGGB	1390		0-N1263	TB [TE]	
1.4	06/09-	CGGB	1390		0-N158	TB [TE]	
1.4 BiFuel	03/10-01/11	CMAA	1390		0-N1262	TB [DG]	
1.4 BiFuel	03/10-01/11	CMAA	1390		0-N1263	TB [TE]	
1.4 BiFuel	03/10-01/11	CMAA	1390		0-N158	TB [TE]	
1.4 TDI	02/14-	CUSA, CYZB, CUSB	1422		0-N2314	TB [TE]	
1.4 TSI	10/12-	CPTA, CZEA	1395		0-N2313	TB [TE]	
1.4 TSI	10/12-	CPTA, CZEA	1395		0-N2381	TB [DG]	
1.6	07/14-	CWVA	1598		0-N2313	TB [TE]	
1.6	07/14-	CWVA	1598		0-N2381	TB [DG]	



CM³



Art. Nr.



ohne Halter

POLO (6R, 6C)							
1.6 TDI	06/09-	CAYA, CAYB, CAYC, CLNA	1598			0-N131	TB [DG]
1.6 TDI	06/09-	CAYA, CAYB	1598			0-N2025	TB [DG]
1.6 TDI	06/09-	CAYC	1598			0-N2025	TB [DG]
1.6 TDI	06/09-	CAYA, CAYB, CAYC, CLNA	1598			0-N2200	TB [DG]
2.0 R WRC	08/13-	CDLJ	1984			0-N2208	TB [TE]
1.2	06/09-	CGPA, CGPB	1198			0-N1908	VB [BT] S
1.2	06/09-	CGPA, CGPB	1198	✳		0-N1909	VB [DG]
1.2 TDI	10/09-	CFWA	1199			0-N1534	VB [BT] S
1.2 TSI	11/09-05/14	CBZB, CBZC	1197	✳		0-N1733	VB [BT] S
1.2 TSI	11/09-	CBZB	1197	✳		0-N2121	VB [DG]
1.2 TSI	05/11-05/14	CBZC	1197			0-N2121	VB [DG]
1.4	06/09-	CGGB	1390			0-N1445	VB [BT] S
1.4	06/09-	CLPA	1390			0-N1525	VB [BT] S
1.4	06/09-	CLPA	1390	✳		0-N1733	VB [BT] S
1.4 BiFuel	03/10-01/11	CMAA	1390	✳		0-N1445	VB [BT] S
1.4 GTI	05/10-	CAVE, CTHE	1390	✳		0-N2091	VB [BT] S
1.4 GTI	05/10-	CAVE, CTHE	1390			0-N2092	VB [BT] S
1.4 GTI	05/10-	CAVE, CTHE	1390	✳		0-N2111	VB [BT] S
1.4 GTI	05/10-	CAVE, CTHE	1390		Rippenanzahl: 6	0-N2133	VB [DG]
1.6 BiFuel	01/11-	CNKA	1598	✳		0-N1525	VB [BT] S
1.6 TDI	06/09-	CAYA, CAYB, CAYC, CLNA	1598			0-N1534	VB [BT] S
1.6, 1.6 BiFuel	01/10-	CFNA, CLSA, CNKA	1598	✳		0-N1733	VB [BT] S
POLO Stufenheck							
1.6	05/10-	CFNA, CFNA, CLSA, CFNB	1598			0-N1525	VB [BT] S
1.6	05/10-	CFNA, CFNA, CLSA, CFNB	1598	✳		0-N1733	VB [BT] S
SANTANA (32B)							
1.6	08/81-12/84	WV, YP	1588		18x121; mit Zubehör	SK-1026	BTK
1.6	08/81-12/84	DT	1595		18x121; mit Zubehör	SK-1026	BTK
1.6 D, 1.6 TD	08/81-12/84	CR, JK, CY	1588		25x135; mit Zubehör	SK-1001	BTK
1.8	01/83-12/84	DS	1781		18x121; mit Zubehör	SK-1026	BTK
1.3 CX	08/84-12/85	EP	1296			0-N805	TB [TE]
1.6	08/81-12/84	WV, YP	1588			0-N805	TB [TE]
1.6	08/81-12/84	DT	1595			0-N805	TB [TE]
1.6 D	08/81-12/84	JK	1588			0-N806	TB [TE]
1.6 TD	12/81-12/84	CY	1588			0-N806	TB [TE]
1.8	01/83-12/84	DS	1781			0-N805	TB [TE]
2.0	08/83-12/84	HP, HP, JS	1994			0-N807	TB [DG]
SANTANA Variant							
1.8	04/85-02/88	JV	1781		18x121; mit Zubehör	SK-1026	BTK
SANTANA Variant							
1.8	03/88-04/91	JV	1781		18x121; mit Zubehör	SK-1026	BTK
SANTANA							
1.8, 1.8 i	01/95-12/99	AFE, JV	1781		18x121; mit Zubehör	SK-1026	BTK
1.8, 1.8 i	01/95-	AFE	1781			0-N805	TB [TE]
SCIROCCO (53)							
1.5	02/74-12/77	FD, FH, YJ, ZB	1471		18x121; mit Zubehör	SK-1026	BTK
1.5	08/77-07/80	JB	1457		18x121; mit Zubehör	SK-1026	BTK
1.6	08/75-07/79	FN, FN, FP, FT	1588		18x121; 08/1976 ->; mit Zubehör	SK-1026	BTK
1.6	08/75-07/80	EG, FR	1588		18x121; mit Zubehör	SK-1026	BTK
1.5	02/74-12/77	FD, FH, YJ, ZB	1471			0-N805	TB [TE]
1.5	08/77-07/80	JB	1457			0-N805	TB [TE]
1.6	08/75-07/80	EG, FN, FN, FP, FR, FT	1588			0-N805	TB [TE]
SCIROCCO (53B)							
1.5	08/80-12/83	JB	1457		18x121; mit Zubehör	SK-1026	BTK
1.6	08/80-04/84	FR	1588		18x121; 08/1981 ->; mit Zubehör	SK-1026	BTK
1.6	08/80-07/82	EG	1588		18x121; mit Zubehör	SK-1026	BTK
1.6	01/83-07/90	EW, EWA, RE	1595		18x121; mit Zubehör	SK-1026	BTK
1.8	08/82-07/92	DX, EV, JJ, JJ, PB, EX, JH	1781		18x121; mit Zubehör	SK-1026	BTK
1.8 16V	10/85-07/92	KR, PL	1781		25x147	SK-1047	BTK
1.5	08/80-12/83	JB	1457			0-N805	TB [TE]
1.6	08/80-04/84	EG, FR	1588			0-N805	TB [TE]
1.6	01/83-07/90	EW, EWA, RE	1595			0-N805	TB [TE]
1.8	08/82-12/89	DX	1781			0-N805	TB [TE]



OPTIMAL®

VW



CM³



Art. Nr.



SCIROCCO (53B)

1.8	08/83-07/92	EX, JH	1781		0-N805	TB [TE]
1.8 16V	10/85-07/92	KR, PL	1781		0-N808	TB [TE]

SCIROCCO (137, 138)

2.0 R	11/09-	CDLA, CDLC, CDLK	1984	23x148	SK-1724	BTK
2.0 R	11/09-	CDLA, CDLC, CDLK	1984	23x148	SK-1724AQ1	BTKW
2.0 TDI	08/08-	CBDB	1968	30x160	SK-1694	BTK
2.0 TDI	08/08-	CBDB	1968	30x160	SK-1694AQ1	BTKW
2.0 TDI	08/08-	CFHC	1968	25x160; → 11/2010	SK-1695	BTK
2.0 TDI	08/08-	CFHC	1968	25x160; → 11/2010	SK-1695AQ1	BTKW
2.0 TDI	08/08-	CFHC	1968	25x160; 12/2010 →	SK-1727	BTK
2.0 TDI	08/08-	CFHB, CFHC	1968	25x160; → 11/2010	SK-1727AQ2	BTKW
2.0 TDI	05/09-	CBBB	1968	30x160	SK-1694	BTK
2.0 TDI	05/09-	CBBB	1968	30x160	SK-1694AQ2	BTKW
2.0 TDI	05/09-	CFGB	1968	25x160; → 01/2013	SK-1695	BTK
2.0 TDI	05/09-	CFGB	1968	25x160; → 11/2010	SK-1695AQ1	BTKW
2.0 TDI	05/09-	CFGB	1968	25x160; → 11/2010	SK-1727AQ2	BTKW
2.0 TDI	11/10-	CFHB	1968	25x160	SK-1727	BTK
2.0 TDI	01/13-	CFGC	1968	25x160	SK-1727AQ2	BTKW
1.4 TSI	11/13-	CXSB, CZCA	1395		0-N2313	TB [TE]
1.4 TSI	11/13-	CXSB, CZCA	1395		0-N2381	TB [DG]
2.0 R	11/09-	CDLA, CDLC	1984		0-N1316	TB [DG]
2.0 R	11/09-	CDLA, CDLC	1984		0-N1346	TB [DG]
2.0 R	11/09-	CDLA, CDLC	1984		0-N2208	TB [TE]
2.0 TDI	08/08-	CBDB	1968		0-N1046	TB [DG]
2.0 TDI	08/08-	CFHC	1968	→ 10/2010	0-N1046	TB [DG]
2.0 TDI	08/08-	CBDB	1968		0-N1268	TB [DG]
2.0 TDI	08/08-	CFHC	1968		0-N131	TB [DG]
2.0 TDI	08/08-	CBDB	1968		0-N1336	TB [DG]
2.0 TDI	08/08-	CBDB	1968		0-N1905	TB [BT]
2.0 TDI	08/08-	CFHC	1968		0-N2025	TB [DG]
2.0 TDI	08/08-	CFHC	1968	12/2010 →	0-N2200	TB [DG]
2.0 TDI	05/09-	CBBB	1968		0-N1046	TB [DG]
2.0 TDI	05/09-	CFGB	1968	→ 10/2010	0-N1046	TB [DG]
2.0 TDI	05/09-	CBBB	1968		0-N1268	TB [DG]
2.0 TDI	05/09-	CFGB	1968		0-N131	TB [DG]
2.0 TDI	05/09-	CBBB	1968		0-N1336	TB [DG]
2.0 TDI	05/09-	CBBB	1968		0-N1905	TB [BT]
2.0 TDI	05/09-	CFGB	1968		0-N2025	TB [DG]
2.0 TDI	05/09-	CFGB	1968	12/2010 →	0-N2200	TB [DG]
2.0 TDI	11/10-	CFGC, CFHB, CUUB	1968		0-N131	TB [DG]
2.0 TDI	11/10-	CFHB	1968		0-N2025	TB [DG]
2.0 TDI	11/10-	CFHB	1968		0-N2200	TB [DG]
2.0 TDI	11/13-	CUUB	1968		0-N2314	TB [TE]
1.4 TSI	05/08-	CAVD, CNWA, CTHD, CTKA	1390	5	0-N2050	VB [DG]
1.4 TSI	05/08-	CAVD, CNWA, CTHD, CTKA	1390	6	0-N2091	VB [BT] S
1.4 TSI	05/08-	CAVD, CNWA, CTHD, CTKA	1390	7	0-N2092	VB [BT] S
1.4 TSI	05/08-	CAVD, CNWA, CTHD, CTKA	1390	8	0-N2111	VB [BT] S
1.4 TSI	05/08-	CAVD, CNWA, CTHD, CTKA	1390	Rippenanzahl: 6	0-N2133	VB [DG]
1.4 TSI	08/08-	CAXA, CMSB	1390	1; 2	0-N1454	VB [DG]
1.4 TSI	08/08-	CAXA, CMSB	1390	3	0-N1525	VB [BT] S
1.4 TSI	08/08-	CAXA, CMSB	1390	4	0-N1733	VB [BT] S
2.0 R	11/09-	CDLA, CDLC	1984		0-N1656	VB [BT] S
2.0 TDI	08/08-	CBAB, CFFB	1968		0-N1534	VB [BT] S
2.0 TDI	11/10-	CFGC, CFHB	1968		0-N1534	VB [BT] S
2.0 TDI	11/13-	CUUB	1968	9	0-N2288	VB [BT] S
2.0 TSI	05/08-11/09	CAWB, CCZB	1984		0-N1832	VB [BT] S

SHARAN (7M8, 7M9, 7M6)

1.8 T 20V	09/97-03/10	AJH	1781	23x150; mit Spanndämpfer, Spannrolle	SK-1337	BTK
1.8 T 20V	09/97-03/10	AWC	1781	23x150; mit Spanndämpfer, Spannrolle	SK-1337AQ1	BTKW
1.8 T 20V	09/97-03/10	AWC	1781	23x150	SK-1660	BTK
1.8 T 20V	09/97-03/10	AWC	1781	23x150	SK-1660AQ1	BTKW
1.8 T 20V	09/97-03/10	AJH	1781	23x150; 11/1997 →	SK-1709	BTK
1.8 T 20V	09/97-03/10	AWC	1781	23x150; 11/1997 →	SK-1710	BTK
1.9 TDI	09/95-03/10	ANU	1896	30x120; 01/2003 →; mit Zubehör	SK-1372	BTK

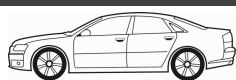

CM³



Art. Nr.



ohne Halter

SHARAN (7M8, 7M9, 7M6)

1.9 TDI	09/95-03/10	ANU	1896	30x120; 08/2002 →	SK-1372AQ2	BTKW
1.9 TDI	09/95-03/10	ANU	1896	30x120; → 07/2002; : → ANU005000; mit Spanndämpfer, Spannrolle; mit Zubehör	SK-1378	BTK
1.9 TDI	09/95-03/10	1Z, AHU, ANU	1896	30x120; → 07/2002; : → ANU005000; ohne Spanndämpfer, Spannrolle; mit Zubehör; Baumuster: 7M8, 7M9, 7M6	SK-1388	BTK
1.9 TDI	09/95-03/10	AHU, ANU	1896	30x120; 09/1996 → 07/2002; : → ANU005000; ohne Spanndämpfer, Spannrolle; mit Zubehör	SK-1388	BTK
1.9 TDI	09/95-03/10	AHU	1896	25.4x137; 09/1996 →; mit Zubehör	SK-1425	BTK
1.9 TDI	09/95-03/10	AHU, ANU	1896	25.4x137; mit Zubehör	SK-1425	BTK
1.9 TDI	09/95-03/10	1Z, AHU, ANU	1896	30x120; → 07/2002; : ANU005001 →; mit Zubehör; Baumuster: 7M8, 7M9, 7M6	SK-1582	BTK
1.9 TDI	09/95-03/10	AHU, ANU	1896	30x120; 09/1996 → 07/2002; : ANU005001 →; mit Zubehör	SK-1582	BTK
1.9 TDI	09/95-03/10	ANU	1896	30x120; → 07/2002; ohne Spanndämpfer, Spannrolle; mit Zubehör	SK-1582AQ1	BTKW
1.9 TDI	09/95-03/10	1Z, AHU, ANU	1896	30x120; → 07/2002; : ANU005001 →; mit Spanndämpfer, Spannrolle; mit Zubehör; Baumuster: 7M8, 7M9, 7M6	SK-1583	BTK
1.9 TDI	09/95-03/10	AHU, ANU	1896	30x120; 09/1996 → 07/2002; : ANU005001 →; mit Spanndämpfer, Spannrolle; mit Zubehör	SK-1583	BTK
1.9 TDI	09/95-03/10	ANU	1896	30x120; → 07/2002; mit Spanndämpfer, Spannrolle; mit Zubehör	SK-1583AQ1	BTKW
1.9 TDI	09/96-04/00	AFN	1896	25.4x137; 09/1998 →; mit Zubehör	SK-1425	BTK
1.9 TDI	04/00-03/10	BVK	1896	30x120	SK-1372AQ2	BTKW
1.9 TDI	04/00-03/10	AUY	1896	30x120; 08/2002 →	SK-1372AQ2	BTKW
1.9 TDI	04/00-03/10	AUY, BVK	1896	30x120; → 07/2002; mit Zubehör; Baumuster: 7M8, 7M9, 7M6	SK-1582	BTK
1.9 TDI	04/00-03/10	AUY	1896	30x120; 08/2001 → 07/2002; mit Zubehör	SK-1582	BTK
1.9 TDI	04/00-03/10	AUY	1896	30x120; → 07/2002; ohne Spanndämpfer, Spannrolle; mit Zubehör	SK-1582AQ1	BTKW
1.9 TDI	04/00-03/10	AUY, BVK	1896	30x120; → 07/2002; mit Spanndämpfer, Spannrolle; mit Zubehör; Baumuster: 7M8, 7M9, 7M6	SK-1583	BTK
1.9 TDI	04/00-03/10	AUY	1896	30x120; 08/2001 → 07/2002; mit Spanndämpfer, Spannrolle; mit Zubehör	SK-1583	BTK
1.9 TDI	04/00-03/10	AUY	1896	30x120; → 07/2002; mit Spanndämpfer, Spannrolle; mit Zubehör	SK-1583AQ1	BTKW
1.9 TDI	11/02-03/10	ASZ, BTB	1896	30x120; mit Zubehör	SK-1372	BTK
1.9 TDI	11/02-03/10	ASZ, BTB	1896	30x120	SK-1372AQ1	BTKW
1.9 TDI 4motion	04/00-03/10	AUY	1896	30x120; → 07/2002; mit Zubehör; Baumuster: 7M8, 7M9, 7M6	SK-1582	BTK
1.9 TDI 4motion	04/00-03/10	AUY	1896	30x120; → 07/2002; mit Spanndämpfer, Spannrolle; mit Zubehör; Baumuster: 7M8, 7M9, 7M6	SK-1583	BTK
1.9 TDI, 1.9 TDI 4motion	04/00-03/10	AUY, BVK	1896	30x120; ch. → 2003 →; mit Zubehör	SK-1372	BTK
1.9 TDI, 1.9 TDI 4motion	04/00-03/10	AUY, BVK	1896	30x120; 08/2002 →	SK-1372AQ2	BTKW
1.9 TDI, 1.9 TDI 4motion	04/00-03/10	AUY, BVK	1896	30x120; → 07/2002; ohne Spanndämpfer, Spannrolle; mit Zubehör	SK-1582AQ1	BTKW
1.9 TDI, 1.9 TDI 4motion	04/00-03/10	AUY, BVK	1896	30x120; → 07/2002; mit Spanndämpfer, Spannrolle; mit Zubehör	SK-1583AQ1	BTKW
2.0	09/95-03/10	ADY, ATM	1984	23x138; 09/1996 →	SK-1109	BTK
2.0	09/95-03/10	ADY, ATM	1984	23x138; Baumuster: 7M8, 7M9, 7M6	SK-1109	BTK
2.0	09/95-03/10	ATM	1984	23x138	SK-1109AQ2	BTKW
2.0	09/95-03/10	ADY, ATM	1984	18x124; 09/1996 →; mit Zubehör	SK-1120	BTK
2.0 LPG	04/06-03/10	ATM	1984	23x138; 05/2008 →; Baumuster: 7M8, 7M9, 7M6	SK-1109	BTK
2.0 LPG	04/06-03/10	ATM	1984	23x138; 05/2008 →	SK-1109AQ2	BTKW
2.0 TDI	11/05-03/10	BRT	1968	30x120; mit Zubehör	SK-1372	BTK
2.0 TDI	11/05-03/10	BVH	1968	30x120; mit Zubehör; Baumuster: 7M8, 7M9, 7M6	SK-1372	BTK
2.0 TDI	11/05-03/10	BRT, BVH	1968	30x120	SK-1372AQ2	BTKW
1.8 T 20V	09/97-03/10	AWC	1781	11/1997 →	0-N1042	TB [TE]
1.8 T 20V	09/97-03/10	AJH, AWC	1781		0-N1237	TB [BT]
1.8 T 20V	09/97-03/10	AJH, AWC	1781		0-N1316	TB [DG]
1.8 T 20V	09/97-03/10	AJH	1781	11/1997 →	0-N1654	TB [TE]
1.9 TDI	09/95-03/10	1Z, AHU	1896		0-N104	TB [TE]
1.9 TDI	09/95-03/10	ANU	1896	01/2003 →	0-N1045	TB [TE]
1.9 TDI	09/95-03/10	ANU	1896	01/2003 →	0-N1046	TB [DG]
1.9 TDI	09/95-03/10	ANU	1896	: 005001 →	0-N1048	TB [TE]



OPTIMAL®

VW



CM³



Art. Nr.



ohne Halter

SHARAN (7M8, 7M9, 7M6)

1.9 TDI	09/95-03/10	ANU	1896	ENGINE: →005000	0-N1049	TB [BT]	
1.9 TDI	09/95-03/10	ANU	1896	ENGINE: →005000; mit Anbaumaterial	0-N1265	TB [TE]	
1.9 TDI	09/95-03/10	ANU	1896	→ 12/2002	0-N1268	TB [DG]	
1.9 TDI	09/95-03/10	ANU	1896	→ 12/2002; ENGINE:005001→	0-N1274	TB [BT]	
1.9 TDI	09/95-03/10	1Z, AHU	1896		0-N128	TB [DG]	
1.9 TDI	09/96-04/00	AFN, AVG	1896		0-N104	TB [TE]	
1.9 TDI	09/96-04/00	AFN, AVG	1896		0-N128	TB [DG]	
1.9 TDI	11/02-03/10	ASZ, BTB	1896		0-N1046	TB [DG]	
1.9 TDI, 1.9 TDI 4motion	04/00-03/10	ASZ, AUY, BVK, BTB	1896		0-N1045	TB [TE]	
1.9 TDI, 1.9 TDI 4motion	04/00-03/10	AUY, BVK	1896	01/2003 →	0-N1046	TB [DG]	
1.9 TDI, 1.9 TDI 4motion	04/00-03/10	AUY, BVK	1896	→ 12/2002	0-N1048	TB [TE]	
1.9 TDI, 1.9 TDI 4motion	04/00-03/10	AUY, BVK	1896	→ 12/2002	0-N1268	TB [DG]	
1.9 TDI, 1.9 TDI 4motion	04/00-03/10	AUY, BVK	1896	→ 12/2002	0-N1274	TB [BT]	
2.0	09/95-02/00	ABF	1984		0-N129	TB [TE]	
2.0	09/95-03/10	ATM	1984		0-N157	TB [TE]	
2.0	09/95-03/10	ADY	1984		0-N805	TB [TE]	
2.0 LPG	04/06-03/10	ATM	1984		0-N157	TB [TE]	
2.0 TDI	11/05-03/10	BRT, BVH	1968		0-N1045	TB [TE]	
2.0 TDI	11/05-03/10	BRT, BVH	1968		0-N1046	TB [DG]	
1.9 TDI	09/95-03/10	1Z, AHU	1896		0-N1417	VB [TE]	
1.9 TDI	09/95-03/10	ANU	1896		0-N1494	VB [BT]	S
1.9 TDI	09/95-03/10	1Z, AHU	1896		0-N1609	VB [BT]	
1.9 TDI	09/96-04/00	AFN, AVG	1896		0-N1417	VB [TE]	
1.9 TDI	09/96-04/00	AFN, AVG	1896		0-N1609	VB [BT]	
1.9 TDI	11/02-03/10	ASZ, BTB	1896		0-N1494	VB [BT]	S
1.9 TDI, 1.9 TDI 4motion	04/00-03/10	AUY, BVK	1896	ch.→7M-6-015000	0-N1494	VB [BT]	S
1.9 TDI, 1.9 TDI 4motion	04/00-03/10	AUY, BVK	1896	ch.7M-6-015001→	0-N1531	VB [BT]	S
2.0	09/95-02/00	ABF	1984		0-N1417	VB [TE]	
2.0	09/95-03/10	ADY	1984		0-N1417	VB [TE]	
2.0	09/95-03/10	ADY	1984		0-N1660	VB [BT]	
2.0 TDI	11/05-03/10	BRT, BVH	1968		0-N1531	VB [BT]	S
2.8 V6 24V, 2.8 V6 24V 4motion	04/00-03/10	AYL	2792	Rippenanzahl: 6	0-N1496S	VB [TE]	
2.8 VR6, 2.8 VR6 Syncro	09/95-04/00	AAA, AMY	2792	Rippenanzahl: 7	0-N1657	VB [BT]	S

SHARAN (7N1, 7N2)

2.0 TDI	05/10-	CFFA, CFFB, CFGB	1968	25x160; → 11/2010	SK-1695	BTK	
2.0 TDI	05/10-	CFFA, CFFB, CFGB	1968	25x160; → 11/2010	SK-1695AQ1	BTKW	
2.0 TDI	05/10-	CFFA, CFFB, CFGB	1968	25x160; 12/2010 →	SK-1727	BTK	
2.0 TDI	05/10-	CFFA, CFFB	1968	25x160; → 11/2010	SK-1727AQ2	BTKW	
2.0 TDI	08/10-	CFGB	1968	25x160; → 11/2010	SK-1727AQ2	BTKW	
2.0 TDI	01/13-	CFGC	1968	25x160	SK-1727AQ2	BTKW	
2.0 TDI, 2.0 TDI 4motion	05/11-05/12	CFFA, CFFB, CFFE, CUVA, CFGC	1968	25x160	SK-1727	BTK	
2.0 TDI, 2.0 TDI 4motion	05/11-05/12	CFFA, CFFB	1968	25x160	SK-1727AQ2	BTKW	
2.0 TDI	08/10-	CFGB	1968		0-N2025	TB [DG]	
2.0 TDI, 2.0 TDI 4motion	05/10-05/12	CFFA, CFFB, CFFE, CUVA, CFGB, CFGC	1968		0-N131	TB [DG]	
2.0 TDI, 2.0 TDI 4motion	05/10-05/12	CFFA, CFFB	1968		0-N2025	TB [DG]	
2.0 TDI, 2.0 TDI 4motion	05/10-05/12	CFFA, CFFB, CFFE, CUVA, CFGB	1968		0-N2200	TB [DG]	
1.4 TSI	05/10-	CAVA, CNWB, CTHA	1390	⊗	0-N2050	VB [DG]	
1.4 TSI	05/10-	CAVA, CNWB, CTHA	1390	⊗	0-N2091	VB [BT]	S
1.4 TSI	05/10-	CAVA, CNWB, CTHA	1390		0-N2092	VB [BT]	S
1.4 TSI	05/10-	CAVA, CNWB, CTHA	1390	⊗	0-N2111	VB [BT]	S
1.8 TSI	11/11-	CDA	1798		0-N1832	VB [BT]	S
2.0 TDI, 2.0 TDI 4motion	05/10-05/12	CFFA, CFFB, CFFE, CUVA, CFGB, CFGC	1968		0-N1534	VB [BT]	S
2.0 TSI	12/10-	CCZA	1984		0-N1832	VB [BT]	S

TARO

2.4 D, 2.4 D 4x4	04/89-03/97	2L	2446	31x129	SK-1522	BTK	
2.4 D, 2.4 D 4x4	04/89-03/97	2L	2446		0-N013	TB [TE]	
2.4 D, 2.4 D 4x4	04/89-03/97	2L	2446		0-N014	TB [DG]	

TIGUAN (5N_)

2.0 TDI	03/08-	CBAB	1968	30x160	SK-1694	BTK	
2.0 TDI	03/08-	CFFB	1968	25x160	SK-1695	BTK	
2.0 TDI	03/08-	CFFB	1968	25x160; → 11/2010	SK-1695AQ1	BTKW	
2.0 TDI	03/08-	CFFB	1968	25x160; 12/2010 →	SK-1727	BTK	
2.0 TDI	05/10-	CFFD	1968	25x160	SK-1695	BTK	
2.0 TDI	05/10-	CFFD	1968	25x160; → 11/2010	SK-1695AQ1	BTKW	



CM³



Art. Nr.



ohne Halter

TIGUAN (5N_)

2.0 TDI	05/10-	CFFD	1968	25x160; → 11/2010	SK-1727AQ2	BTKW	
2.0 TDI 4motion	09/07-	CBBB	1968	30x160; 02/2008 →	SK-1694	BTK	
2.0 TDI 4motion	09/07-	CBAB	1968	30x160; 11/2007 →	SK-1694	BTK	
2.0 TDI 4motion	09/07-08/09	CBBA, CBBB, CFGB	1968	30x160	SK-1694AQ2	BTKW	
2.0 TDI 4motion	09/07-	CFFB, CLJA	1968	25x160	SK-1695	BTK	
2.0 TDI 4motion	09/07-	CFGB	1968	25x160; 02/2008 →	SK-1695	BTK	
2.0 TDI 4motion	09/07-	CFFB, CLJA	1968	25x160; → 11/2010	SK-1695AQ1	BTKW	
2.0 TDI 4motion	09/07-	CFGB	1968	25x160; → 11/2010	SK-1695AQ1	BTKW	
2.0 TDI 4motion	09/07-	CFFB, CLJA	1968	25x160; 12/2010 →	SK-1727	BTK	
2.0 TDI 4motion	09/07-	CFGB	1968	25x160; → 11/2010	SK-1727AQ2	BTKW	
2.0 TDI 4motion	11/07-	CBAA	1968	30x160	SK-1694	BTK	
2.0 TDI 4motion	11/07-	CBAA	1968	30x160	SK-1694AQ1	BTKW	
2.0 TDI 4motion	11/07-	CFFA	1968	25x160	SK-1695	BTK	
2.0 TDI 4motion	11/07-	CFFA	1968	25x160; → 11/2010	SK-1695AQ1	BTKW	
2.0 TDI 4motion	11/07-	CFFA	1968	25x160; 12/2010 →	SK-1727	BTK	
2.0 TDI 4motion	02/08-08/09	CBBA	1968	30x160	SK-1694	BTK	
2.0 TDI 4motion	11/12-	CFGC	1968	25x160	SK-1727	BTK	
2.0 TDI 4motion	11/12-	CFGC	1968	25x160	SK-1727AQ2	BTKW	
2.0 TDI, 2.0 TDI 4motion	09/07-	CBAB	1968	30x160	SK-1694AQ1	BTKW	
2.0 TDI, 2.0 TDI 4motion	09/07-	CFFA, CFFB, CLJA	1968	25x160; → 11/2010	SK-1727AQ2	BTKW	
2.0 TDI	03/08-	CFFB	1968	→ 10/2010	0-N1046	TB [DG]	
2.0 TDI	03/08-	CFFB	1968		0-N131	TB [DG]	
2.0 TDI	03/08-	CFFB	1968		0-N2025	TB [DG]	
2.0 TDI	03/08-	CFFB	1968	12/2010 →	0-N2200	TB [DG]	
2.0 TDI	05/10-	CFFD	1968		0-N2025	TB [DG]	
2.0 TDI	05/10-	CFFD	1968		0-N2200	TB [DG]	
2.0 TDI 4motion	09/07-	CBBB	1968		0-N1046	TB [DG]	
2.0 TDI 4motion	09/07-	CFFB, CLJA	1968	→ 10/2010	0-N1046	TB [DG]	
2.0 TDI 4motion	09/07-	CFGB	1968	→ 10/2010	0-N1046	TB [DG]	
2.0 TDI 4motion	09/07-	CBBB	1968		0-N1268	TB [DG]	
2.0 TDI 4motion	09/07-	CFFB, CLJA	1968		0-N131	TB [DG]	
2.0 TDI 4motion	09/07-	CFGB	1968		0-N131	TB [DG]	
2.0 TDI 4motion	09/07-	CBBB	1968		0-N1336	TB [DG]	
2.0 TDI 4motion	09/07-	CBBB	1968		0-N1905	TB [BT]	
2.0 TDI 4motion	09/07-	CFFB, CLJA	1968		0-N2025	TB [DG]	
2.0 TDI 4motion	09/07-	CFGB	1968		0-N2025	TB [DG]	
2.0 TDI 4motion	09/07-	CFFB, CLJA	1968	12/2010 →	0-N2200	TB [DG]	
2.0 TDI 4motion	09/07-	CFGB	1968	12/2010 →	0-N2200	TB [DG]	
2.0 TDI 4motion	11/07-	CBAA	1968		0-N1046	TB [DG]	
2.0 TDI 4motion	11/07-	CFFA	1968	→ 10/2010	0-N1046	TB [DG]	
2.0 TDI 4motion	11/07-	CBAA	1968		0-N1268	TB [DG]	
2.0 TDI 4motion	11/07-	CFFA	1968		0-N131	TB [DG]	
2.0 TDI 4motion	11/07-	CBAA	1968		0-N1336	TB [DG]	
2.0 TDI 4motion	11/07-	CBAA	1968		0-N1905	TB [BT]	
2.0 TDI 4motion	11/07-	CFFA	1968		0-N2025	TB [DG]	
2.0 TDI 4motion	11/07-	CFFA	1968	12/2010 →	0-N2200	TB [DG]	
2.0 TDI 4motion	02/08-08/09	CBBA	1968		0-N1046	TB [DG]	
2.0 TDI 4motion	02/08-08/09	CBBA	1968		0-N1268	TB [DG]	
2.0 TDI 4motion	02/08-08/09	CBBA	1968		0-N1336	TB [DG]	
2.0 TDI 4motion	02/08-08/09	CBBA	1968		0-N1905	TB [BT]	
2.0 TDI, 2.0 TDI 4motion	09/07-	CBAB	1968		0-N1046	TB [DG]	
2.0 TDI, 2.0 TDI 4motion	09/07-	CBAB	1968		0-N1268	TB [DG]	
2.0 TDI, 2.0 TDI 4motion	09/07-	CBAB	1968		0-N1336	TB [DG]	
2.0 TDI, 2.0 TDI 4motion	09/07-	CBAB	1968		0-N1905	TB [BT]	
2.0 TDI, 2.0 TDI 4motion	05/10-	CFFD, CFGC	1968		0-N131	TB [DG]	
1.4 TSI	08/10-	CAXA	1390	†; *	0-N1454	VB [DG]	
1.4 TSI	08/10-	CAXA	1390	*	0-N1525	VB [BT]	S
1.4 TSI	08/10-	CAXA	1390	*	0-N1733	VB [BT]	S
1.4 TSI, 1.4 TSI 4motion	09/07-	BWK, CAVA, CTHA, CAVD, CTHD	1390	*	0-N2091	VB [BT]	S
1.4 TSI, 1.4 TSI 4motion	09/07-	BWK, CAVA, CTHA, CAVD, CTHD	1390		0-N2092	VB [BT]	S
1.4 TSI, 1.4 TSI 4motion	09/07-	BWK, CAVA, CTHA, CAVD, CTHD	1390	*	0-N2111	VB [BT]	S
1.4 TSI, 1.4 TSI 4motion	09/07-	BWK, CAVA, CTHA, CAVD, CTHD	1390	Rippenanzahl: 6	0-N2133	VB [DG]	
2.0 TDI 4motion	09/07-	CBBB, CFGB	1968		0-N1738	VB [DG]	
2.0 TDI, 2.0 TDI 4motion	09/07-	CBAB, CFFB	1968		0-N1534	VB [BT]	S
2.0 TDI, 2.0 TDI 4motion	02/08-08/09	CBBA, CFFD, CFGC	1968		0-N1534	VB [BT]	S



OPTIMAL®

VW



CM³



Art. Nr.



ohne Halter

TIGUAN (5N_)

2.0 TFSI 4motion, 2.0 TSI 4motion	09/07-	CAWA, CCZC, CAWB, CCTA, CCZA, CCZB, CCZD	1984			0-N1832	VB [BT]	S
-----------------------------------	--------	--	------	--	--	----------------	---------	----------

TOUAREG (7LA, 7L6, 7L7)

3.0 TDI	04/06-05/10	BUN	2967	24x83; mit Zubehör		SK-1597	BTK	
3.0 TDI	04/06-05/10	CASB	2967	24x82		SK-1720	BTK	
3.0 V6 TDI	11/04-05/10	BKS, CATA	2967	24x83; mit Zubehör		SK-1597	BTK	
3.0 V6 TDI	11/04-05/10	CATA	2967	24x82		SK-1720	BTK	
3.0 V6 TDI	11/07-05/10	CASA, CASC	2967	24x82		SK-1720	BTK	
4.2 V8	12/02-11/06	AXQ, BHX	4172	30x253		SK-1386	BTK	
4.2 V8	12/02-11/06	AXQ	4172	30x253		SK-1386AQ1	BTKW	
3.0 TDI	04/06-05/10	CASB	2967			0-N131	TB [DG]	
3.0 TDI, 3.0 V6 TDI	11/04-05/10	BKS, CATA, BUN, CASB, CASA, CASC	2967			0-N1337	TB [TE]	
3.0 V6 TDI	11/04-05/10	CATA	2967			0-N131	TB [DG]	
3.0 V6 TDI	11/07-05/10	CASA, CASC	2967			0-N131	TB [DG]	
4.2 V8	12/02-11/06	AXQ, BHX	4172			0-N1568	TB [TE]	
4.2 V8	12/02-11/06	AXQ, BHX	4172			0-N1569	TB [BT]	
4.2 V8	12/02-11/06	AXQ, BHX	4172			0-N1570	TB [DG]	
4.2 V8	12/02-11/06	AXQ, BHX	4172			0-N169	TB [DG]	
3.0 TDI, 3.0 V6 TDI	11/04-05/10	BKS, CATA, BUN, CASB, CASA, CASC	2967			0-N1795	VB [DG]	
3.0 TDI, 3.0 V6 TDI	11/04-05/10	BKS, CATA, BUN, CASB, CASA, CASC	2967			0-N1918	VB [BT]	S
3.0 V6 TDI	11/04-05/10	BKS, CATA	2967	Rippenanzahl: 6		0-N1431	VB [DG]	
3.2 V6	10/02-11/06	AZZ, BAA, BKJ, BMV, BMX, BRJ, BMV	3189			0-N1676	VB [BT]	S
3.2 V6	10/02-11/06	AZZ, BAA, BKJ, BMV, BRJ	3189			0-N1740	VB [DG]	
3.2 V6	10/02-11/06	AZZ, BAA, BKJ, BMV, BMX, BRJ, BMV	3189			0-N2110	VB [DG]	
3.6 V6 FSI	10/05-05/10	BHK, BHL	3597			0-N1676	VB [BT]	S
3.6 V6 FSI	10/05-05/10	BHK, BHL	3597			0-N2110	VB [DG]	
4.2 V8	12/02-11/06	AXQ, BHX	4172			0-N1632	VB [DG]	
4.2 V8	12/02-11/06	AXQ, BHX	4172			0-N2137	VB [TE]	S
6.0 W12	08/04-05/10	BJN, CFRA	5998	Rippenanzahl: 7		0-N2127	VB [DG]	

TOUAREG (7P5)

3.0 V6 TDI	01/10-	CASA	2967	24x82		SK-1720	BTK	
3.0 V6 TDI	01/10-	CASD	2967	24x82		SK-1720	BTK	
3.0 V6 TDI	06/10-	CATA	2967	24x82		SK-1720	BTK	
3.0 V6 TDI	01/10-	CASA, CNRB, CASD, CJMA, CVWA, CATA	2967			0-N131	TB [DG]	
3.0 V6 TDI	01/10-	CASA, CNRB, CASD, CJMA, CVWA	2967			0-N1337	TB [TE]	
3.0 V6 TDI	01/10-	CASA, CNRB, CASD, CJMA, CVWA	2967			0-N1795	VB [DG]	
3.0 V6 TDI	01/10-	CASA	2967	→ 09/2010		0-N1918	VB [BT]	S
3.0 V6 TDI	01/10-	CASD	2967	→ 09/2010		0-N1918	VB [BT]	S
3.0 V6 TDI	01/10-	CJMA	2967			0-N2287	VB [BT]	S
3.0 V6 TDI	01/10-	CNRB	2967			0-N2287	VB [BT]	S
3.0 V6 TDI	05/11-	CJGD, CRCA	2967			0-N2287	VB [BT]	S
3.0 V6 TSI	08/10-	CJTA	2995			0-N1830	VB [BT]	S
3.0 V6 TSI, 3.0 V6 TSI Hybrid	04/10-	CGEA, CGFA, CJTA	2995			0-N2289	VB [BT]	S
3.0 V6 TSI, 3.0 V6 TSI Hybrid	04/10-	CGEA, CGFA, CJTA	2995			0-N2351	VB [DG]	
3.6 V6 FSI	04/10-	CGRA, CMTA	3597			0-N2110	VB [DG]	

TOURAN (1T1, 1T2)

1.6	07/03-05/10	BGU, BSE, BSF	1595	23x138; Baumuster: 1T1, 1T2		SK-1109	BTK	
1.6	07/03-05/10	BGU	1595	23x138		SK-1109AQ1	BTKW	
1.9 TDI	02/03-05/10	AVQ, BKC, BLS, BXE, BRU, BXF, BXJ	1896	30x120; mit Zubehör		SK-1372	BTK	
1.9 TDI	02/03-05/10	AVQ, BKC, BLS, BXE, BRU, BXF, BXJ	1896	30x120		SK-1372AQ1	BTKW	
2.0 EcoFuel	02/06-05/09	BSX	1984	23x138; Baumuster: 1T1, 1T2		SK-1109	BTK	
2.0 EcoFuel	02/06-05/09	BSX	1984	23x138		SK-1109AQ2	BTKW	
2.0 FSI	10/03-01/07	AXW	1984	23x145; mit Zubehör		SK-1599	BTK	
2.0 FSI	10/03-01/07	AXW	1984	23x145; mit Zubehör		SK-1599AQ1	BTKW	
2.0 FSI	10/03-01/07	BLR, BLX, BLY, BVY, BVZ	1984	23x148		SK-1724	BTK	
2.0 FSI	10/03-01/07	BLR, BLX, BLY, BVY, BVZ	1984	23x148		SK-1724AQ2	BTKW	
2.0 FSI	10/04-05/10	BJZ	1984	23x138		SK-1109	BTK	
2.0 TDI	02/03-05/10	AZV	1968	30x120; 03/2007 →; mit Zubehör		SK-1372	BTK	
2.0 TDI	02/03-05/10	AZV	1968	30x141; ch.→1T-6-185466; mit Zubehör		SK-1595AQ1	BTKW	
2.0 TDI	02/03-05/10	AZV	1968	30x141; ch.1T-6-185467→; 08/2003 →; mit Zubehör		SK-1668	BTK	
2.0 TDI	12/05-05/10	BMM	1968	30x120; mit Zubehör		SK-1372	BTK	
2.0 TDI	12/05-05/10	BMM	1968	30x120		SK-1372AQ2	BTKW	
2.0 TDI	12/05-05/10	BMN	1968	30x141; mit Zubehör		SK-1668	BTK	
2.0 TDI	12/05-05/10	BMN	1968	30x141		SK-1668AQ1	BTKW	



CM³



Art. Nr.



TOURAN (1T1, 1T2)

2.0 TDI	12/05-05/10	CFJA	1968	25x160		SK-1695	BTK	
2.0 TDI	12/05-05/10	CFJA	1968	25x160		SK-1695AQ1	BTKW	
2.0 TDI	12/05-05/10	CFJA	1968	25x160		SK-1727AQ2	BTKW	
2.0 TDI 16V	08/03-05/10	BKD	1968	30x141; ch.→1T6185466; mit Zubehör		SK-1595AQ1	BTKW	
2.0 TDI 16V	08/03-05/10	BKD	1968	30x141; ch.1T-6-185467→; mit Zubehör		SK-1668	BTK	
2.0 TDI, 2.0 TDI 16V	02/03-05/10	AZV, BKD	1968	30x141; ch.→1T-6-185466; mit Zubehör		SK-1595	BTK	
2.0 TDI, 2.0 TDI 16V	02/03-05/10	AZV, BKD	1968	30x141; ch.1T-6-185467→		SK-1668AQ1	BTKW	
1.6	07/03-05/10	BGU, BSE, BSF	1595			0-N157	TB [TE]	
1.9 TDI	02/03-05/10	AVQ, BKC, BLS, BXE, BRU, BXF, BXJ	1896			0-N1045	TB [TE]	
1.9 TDI	02/03-05/10	AVQ, BKC, BLS, BXE, BRU, BXF, BXJ	1896			0-N1046	TB [DG]	
2.0 EcoFuel	02/06-05/09	BSX	1984			0-N157	TB [TE]	
2.0 FSI	10/03-01/07	AXW, BLR, BLX, BLY, BVY, BVZ	1984			0-N1316	TB [DG]	
2.0 FSI	10/03-01/07	AXW	1984			0-N1340	TB [TE]	
2.0 FSI	10/03-01/07	AXW	1984			0-N1341	TB [DG]	
2.0 FSI	10/03-01/07	BLR, BLX, BLY, BVY, BVZ	1984			0-N1346	TB [DG]	
2.0 FSI	10/03-01/07	BLX, BLY, BLR	1984			0-N2208	TB [TE]	
2.0 TDI	02/03-05/10	AZV, BMM	1968			0-N1046	TB [DG]	
2.0 TDI	02/03-05/10	AZV	1968			0-N1335	TB [TE]	
2.0 TDI	02/03-05/10	AZV	1968	ch.→1T-6-185466		0-N1336	TB [DG]	
2.0 TDI	12/05-05/10	BMM	1968			0-N1045	TB [TE]	
2.0 TDI	12/05-05/10	BMN	1968			0-N1046	TB [DG]	
2.0 TDI	12/05-05/10	CFJA	1968	→ 11/2010		0-N1046	TB [DG]	
2.0 TDI	12/05-05/10	CFJA	1968			0-N131	TB [DG]	
2.0 TDI	12/05-05/10	BMN	1968			0-N1335	TB [TE]	
2.0 TDI	12/05-05/10	BMN	1968			0-N1575	TB [DG]	
2.0 TDI	12/05-05/10	CFJA	1968			0-N2025	TB [DG]	
2.0 TDI	12/05-05/10	CFJA	1968			0-N2200	TB [DG]	
2.0 TDI 16V	08/03-05/10	BKD	1968			0-N1046	TB [DG]	
2.0 TDI 16V	08/03-05/10	CFHC	1968	→ 11/2010		0-N1046	TB [DG]	
2.0 TDI 16V	08/03-05/10	CFHC	1968			0-N131	TB [DG]	
2.0 TDI 16V	08/03-05/10	BKD	1968			0-N1335	TB [TE]	
2.0 TDI 16V	08/03-05/10	BKD	1968	ch.→1T-6-185466		0-N1336	TB [DG]	
2.0 TDI 16V	08/03-05/10	CFHC	1968			0-N2025	TB [DG]	
2.0 TDI, 2.0 TDI 16V	02/03-05/10	AZV, BKD	1968	ch.1T-6-185467→		0-N1575	TB [DG]	
1.4 FSI, 1.4 TSI, 1.4 TSI EcoFuel	02/06-05/10	BLG, CAVB, BMY, CAVC, CDGA	1390	☞		0-N2050	VB [DG]	
1.4 FSI, 1.4 TSI, 1.4 TSI EcoFuel	02/06-05/10	BLG, CAVB, BMY, CAVC, CDGA	1390	☞		0-N2091	VB [BT]	S
1.4 FSI, 1.4 TSI, 1.4 TSI EcoFuel	02/06-05/10	BLG, CAVB, BMY, CAVC, CDGA	1390	☞		0-N2092	VB [BT]	S
1.4 FSI, 1.4 TSI, 1.4 TSI EcoFuel	02/06-05/10	BLG, CAVB, BMY, CAVC, CDGA	1390	☞		0-N2111	VB [BT]	S
1.4 FSI, 1.4 TSI, 1.4 TSI EcoFuel	02/06-05/10	BLG, CAVB, BMY, CAVC, CDGA	1390	Rippenanzahl: 6		0-N2133	VB [DG]	
1.6 FSI	02/03-01/07	BAG, BLF, BLP	1598	☞; ☞		0-N1454	VB [DG]	
1.6 FSI	02/03-01/07	BAG, BLF, BLP	1598	☞		0-N1525	VB [BT]	S
1.6 FSI	02/03-01/07	BAG, BLF, BLP	1598	☞		0-N1733	VB [BT]	S
1.9 TDI	02/03-05/04	AVQ	1896			0-N1530	VB [BT]	S
1.9 TDI	08/03-05/10	BKC	1896	→ 12/2005		0-N1530	VB [BT]	S
1.9 TDI	08/03-05/10	BKC, BLS, BXE	1896	01/2006 →		0-N1531	VB [BT]	S
1.9 TDI	11/04-05/10	BRU	1896			0-N1530	VB [BT]	S
1.9 TDI	11/04-05/10	BXF, BXJ	1896			0-N1531	VB [BT]	S
2.0 TDI	12/05-05/10	BMN	1968			0-N1530	VB [BT]	S
2.0 TDI	12/05-05/10	BMM	1968			0-N1531	VB [BT]	S
2.0 TDI, 2.0 TDI 16V	02/03-05/10	AZV, BKD	1968			0-N1530	VB [BT]	S
2.0 TDI, 2.0 TDI 16V	08/03-05/10	CBAB, CFFB	1968			0-N1534	VB [BT]	S

TOURAN (1T3)

1.6 TDI	05/10-05/15	CAYB, CAYC	1598	25x160; → 11/2010		SK-1695	BTK	
1.6 TDI	05/10-05/15	CAYB, CAYC	1598	25x160; → 11/2010		SK-1695AQ1	BTKW	
1.6 TDI	05/10-05/15	CAYB, CAYC	1598	25x160; 12/2010 →		SK-1727	BTK	
1.6 TDI	05/10-05/15	CAYC	1598	25x160; → 11/2010		SK-1727AQ2	BTKW	
2.0 TDI	05/10-05/15	CFHC, CFJA	1968	25x160		SK-1695	BTK	
2.0 TDI	05/10-05/15	CFHC, CFHF, CLCA, CFJA	1968	25x160; → 11/2010		SK-1695AQ1	BTKW	
2.0 TDI	11/10-05/15	CFHF, CLCA	1968	25x160; 12/2010 →		SK-1727	BTK	
2.0 TDI	11/10-05/15	CLCA	1968	25x160; → 11/2010		SK-1727AQ2	BTKW	
2.0 TDI	01/13-05/15	CFJB	1968	25x160		SK-1727	BTK	
2.0 TDI	01/13-05/15	CFJB	1968	25x160		SK-1727AQ2	BTKW	
1.6 TDI	05/10-05/15	CAYB, CAYC	1598			0-N131	TB [DG]	
1.6 TDI	05/10-05/15	CAYB	1598			0-N2025	TB [DG]	
1.6 TDI	05/10-05/15	CAYB	1598			0-N2061	TB [TE]	

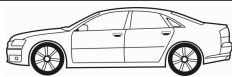

CM³



Art. Nr.



ohne Halter

TOURAN (1T3)

1.6 TDI	05/10-05/15	CAYB, CAYC	1598		0-N2200	TB [DG]	
2.0 TDI	05/10-05/15	CFHC, CFHF, CLCA, CFJA	1968		0-N131	TB [DG]	
2.0 TDI	05/10-05/15	CFHC, CFHF, CLCA	1968		0-N2200	TB [DG]	
2.0 TDI	11/10-05/15	CFHF, CLCA	1968		0-N2025	TB [DG]	
2.0 TDI	11/10-05/15	CFHF, CLCA	1968		0-N2061	TB [TE]	
1.2 TSI	05/10-05/15	CBZB	1197	✳	0-N1733	VB [BT]	S
1.2 TSI	05/10-05/15	CBZB	1197	✳	0-N2121	VB [DG]	
1.4 TSI, 1.4 TSI EcoFuel	05/10-05/15	CAVB, CTHB, CAVC, CTHC, CDGA	1390	✳	0-N2091	VB [BT]	S
1.4 TSI, 1.4 TSI EcoFuel	05/10-05/15	CAVB, CTHB, CAVC, CTHC, CDGA	1390		0-N2092	VB [BT]	S
1.4 TSI, 1.4 TSI EcoFuel	05/10-05/15	CAVB, CTHB, CAVC, CTHC, CDGA	1390	✳	0-N2111	VB [BT]	S
1.4 TSI, 1.4 TSI EcoFuel	05/10-05/15	CAVB, CTHB, CAVC, CTHC, CDGA	1390	Rippenanzahl: 6	0-N2133	VB [DG]	
1.6 TDI	05/10-05/15	CAYB, CAYC	1598		0-N1534	VB [BT]	S
2.0 TDI	05/10-05/15	CFHC, CFHF, CLCA, CFJA, CFJB	1968		0-N1534	VB [BT]	S

TRANSPORTER T3 Bus

1.6 D	01/81-07/87	CS	1588	25x135; mit Zubehör	SK-1001	BTK	
1.6 TD, 1.6 TD Syncro	08/84-07/92	JX	1589	25x135; mit Zubehör	SK-1001	BTK	
1.7 D	10/86-07/92	KY	1716	25x135; mit Zubehör	SK-1001	BTK	
1.6 D	01/81-07/87	CS	1588		0-N806	TB [TE]	
1.6 TD, 1.6 TD Syncro	08/84-07/92	JX	1589		0-N806	TB [TE]	
1.7 D	10/86-07/92	KY	1716		0-N806	TB [TE]	

TRANSPORTER T3 Kasten

1.6 D	01/81-07/87	CS	1588	25x135; mit Zubehör	SK-1001	BTK	
1.6 TD, 1.6 TD Syncro	10/84-07/92	JX	1589	25x135; mit Zubehör	SK-1001	BTK	
1.7 D	08/85-07/87	KY	1715	25x135; mit Zubehör	SK-1001	BTK	
1.7 D	07/89-07/92	KY	1716	25x135; mit Zubehör	SK-1001	BTK	
1.6 D	01/81-07/87	CS	1588		0-N806	TB [TE]	
1.6 TD, 1.6 TD Syncro	10/84-07/92	JX	1589		0-N806	TB [TE]	
1.7 D	08/85-07/87	KY	1715		0-N806	TB [TE]	
1.7 D	07/89-07/92	KY	1716		0-N806	TB [TE]	

TRANSPORTER T3 Pritsche/Fahrgestell

1.6 D	01/81-07/87	CS	1588	25x135; mit Zubehör	SK-1001	BTK	
1.6 TD	10/84-07/92	JX	1589	25x135; mit Zubehör	SK-1001	BTK	
1.6 TD Syncro	03/86-07/92	JX	1589	25x135; 08/1987 →; mit Zubehör	SK-1001	BTK	
1.7 D	07/89-07/92	KY	1716	25x135; mit Zubehör	SK-1001	BTK	
1.6 D	01/81-07/87	CS	1588		0-N806	TB [TE]	
1.6 TD, 1.6 TD Syncro	10/84-07/92	JX	1589		0-N806	TB [TE]	
1.7 D	07/89-07/92	KY	1716		0-N806	TB [TE]	

TRANSPORTER T4 Bus (70XB, 70XC, 7DB, 7DW, 7DK)

1.8	12/90-07/92	PD	1781	18x121; mit Zubehör	SK-1026	BTK	
1.9 D	09/90-12/95	1X	1896	25.4x137; :→1X120077; mit Zubehör	SK-1029	BTK	
1.9 D	09/90-12/95	1X	1896	25.4x137; :120078→; mit Zubehör	SK-1122	BTK	
1.9 TD	10/92-04/03	ABL	1896	25.4x137; :→ABL029319; mit Zubehör	SK-1029	BTK	
1.9 TD	10/92-04/03	ABL	1896	25.4x137; :ABL029320→; mit Zubehör	SK-1122	BTK	
2.0	09/90-04/03	AAC	1968	18x124; mit Zubehör	SK-1120	BTK	
2.4 D	08/97-04/03	AJA	2370	26.5x122; 20x77; → 04/2002; mit Zubehör	SK-1648	BTK	
2.4 D, 2.4 D Syncro	09/90-09/98	AAB	2370	26.5x122; 20x77; :→AAB320126	SK-1578	BTK	
2.4 D, 2.4 D Syncro	09/90-09/98	AAB	2370	26.5x122; → 06/1996; :→320126	SK-1578AQ1	BTKW	
2.4 D, 2.4 D Syncro	09/90-09/98	AAB	2370	26.5x122; 20x77; :AAB320127→; mit Zubehör	SK-1648	BTK	
2.5	11/90-04/03	AAF, ACU, AEN, AEU	2461	26.5x122; 01/1994 → 04/1998; mit Zubehör	SK-1380	BTK	
2.5 Syncro	11/92-04/03	AAF, ACU, AEN, AEU	2461	26.5x122; 01/1994 → 04/1998; :ACU019150→; mit Zubehör	SK-1380	BTK	
2.5 TDI	09/95-04/03	ACV, AUF, AYC	2461	26.5x122; 21x81; mit Zubehör	SK-1526AQ1	BTKW	
2.5 TDI	05/98-04/03	AHY, AXG, AJT, AYY	2461	26.5x122; 21x81; mit Zubehör; Baumuster: 70XB, 70XC, 7DB, 7DW	SK-1529	BTK	
2.5 TDI	05/98-04/03	AHY, AXG, AJT, AYY	2461	26.5x122; mit Zubehör	SK-1529AQ1	BTKW	
2.5 TDI	05/98-04/03	AHY, AXG, AJT, AYY	2461	26.5x122; mit Zubehör	SK-1725	BTK	
2.5 TDI	05/98-04/03	AHY, AXG, AJT, AYY	2461	26.5x122; mit Zubehör	SK-1725AQ1	BTKW	
2.5 TDI Syncro	01/96-04/03	ACV	2461	26.5x122; 21x81; mit Zubehör	SK-1526AQ1	BTKW	
2.5 TDI Syncro	01/96-04/03	AXL	2461	26.5x122; 21x81; mit Zubehör	SK-1529	BTK	
2.5 TDI Syncro	01/96-04/03	AXL	2461	26.5x122; mit Zubehör	SK-1529AQ1	BTKW	
2.5 TDI, 2.5 TDI Syncro	09/95-04/03	ACV, AUF, AYC, ACV, AXL	2461	26.5x122; 21x81; mit Zubehör; Baumuster: 70XB, 70XC, 7DB, 7DW	SK-1526	BTK	
2.5, 2.5 Syncro	11/90-04/03	ACU	2461	26.5x124; 01/1994 → 04/1998; :→ACU019149; mit Zubehör	SK-1360	BTK	



CM³



Art. Nr.



ohne Halter

TRANSPORTER T4 Bus (70XB, 70XC, 7DB, 7DW, 7DK)

2.5, 2.5 Syncro	11/90-04/03	AAF	2461	26.5x124; ch.70-N-014001→ 07/1995; mit Zubehör	SK-1360	BTK
2.5, 2.5 Syncro	11/90-04/03	AAF	2461	26.4x124; ch.70-N-014001→	SK-1360AQ1	BTKW
2.5, 2.5 Syncro	11/90-04/03	ACU	2461	26.4x124; →019149	SK-1360AQ1	BTKW
2.5, 2.5 Syncro	11/90-04/03	AEN	2461	26.4x122	SK-1380AQ1	BTKW
2.5, 2.5 Syncro	11/90-04/03	ACU	2461	26.4x122; →019150→; →048994	SK-1380AQ1	BTKW
2.5, 2.5 Syncro	11/90-04/03	AAF	2461	26.5x122; ch.→70-N-014000	SK-1578AQ1	BTKW
2.5, 2.5 Syncro	07/96-04/03	AET, APL, AVT	2461	26.5x122; mit Zubehör	SK-1380	BTK
1.8	12/90-07/92	PD	1781		0-N805	TB [TE]
1.9 D	09/90-12/95	1X	1896	→120078→	0-N104	TB [TE]
1.9 D	09/90-12/95	1X	1896	→120077	0-N806	TB [TE]
1.9 TD	10/92-04/03	ABL	1896	→029320→	0-N104	TB [TE]
1.9 TD	10/92-04/03	ABL	1896	→029319	0-N806	TB [TE]
2.0	09/90-04/03	AAC	1968		0-N805	TB [TE]
2.4 D	08/97-04/03	AJA	2370		0-N109	TB [TE]
2.4 D, 2.4 D Syncro	09/90-09/98	AAB	2370	→320127→	0-N109	TB [TE]
2.4 D, 2.4 D Syncro	09/90-09/98	AAB	2370	→320126	0-N807	TB [DG]
2.5	11/90-04/03	AAF	2461		0-N807	TB [DG]
2.5 Syncro	11/92-04/03	AAF	2461	→320126	0-N807	TB [DG]
2.5 TDI	09/95-04/03	ACV, AUF, AYC	2461		0-N109	TB [TE]
2.5 TDI	05/98-04/03	AHY, AXG, AJT, AYY	2461		0-N116	TB [TE]
2.5 TDI Syncro	01/96-04/03	ACV	2461		0-N109	TB [TE]
2.5 TDI, 2.5 TDI Syncro	09/95-04/03	ACV, AUF, AYC, ACV, AXL, AHY, AXG, AJT, AYY	2461		0-N110	TB [TE]
2.5 TDI, 2.5 TDI Syncro	09/95-04/03	AXL	2461		0-N116	TB [TE]
2.5 TDI, 2.5 TDI Syncro	09/95-04/03	ACV, AUF, AYC, ACV, AXL, AHY, AXG, AJT, AYY	2461		0-N117	TB [TE]
2.5, 2.5 Syncro	11/90-04/03	AEN, AEU	2461		0-N108	TB [TE]
2.5, 2.5 Syncro	11/90-04/03	ACU	2461	→019150→	0-N108	TB [TE]
2.5, 2.5 Syncro	11/90-04/03	AAF	2461	ch.70-N-014001→	0-N1444	TB [TE]
2.5, 2.5 Syncro	11/90-04/03	ACU	2461	→019149	0-N1444	TB [TE]
2.5, 2.5 Syncro	11/90-04/03	ACU	2461	→019149	0-N807	TB [DG]
2.5, 2.5 Syncro	07/96-04/03	AET, APL, AVT	2461		0-N108	TB [TE]
1.9 D, 1.9 TD	09/90-04/03	1X, ABL	1896		0-N1417	VB [TE]
1.9 D, 1.9 TD	09/90-04/03	1X, ABL	1896		0-N1609	VB [BT]
2.0	09/90-04/03	AAC	1968	ch.→70-T-199000	0-N1311	VB [DG]
2.0	09/90-04/03	AAC	1968	ch.70-T-200001→	0-N1311	VB [DG]
2.0	09/90-04/03	AAC	1968	01/1999 →; Rippenanzahl: 6	0-N1313	VB [TE]
2.0	09/90-04/03	AAC	1968	ch.70-T-200001→	0-N1417	VB [TE]
2.0	09/90-04/03	AAC	1968	ch.70-T-200001→	0-N1660	VB [BT]
2.0	09/90-04/03	AAC	1968	ch.70-T-200001→	0-N1891	VB [BT]
2.4 D	09/90-04/98	AAB	2370	ch.→M-175000; → 10/1991; für Fahrzeuge mit Servolenkung	0-N1801	VB [BT]
2.4 D	08/97-04/03	AJA	2370		0-N1311	VB [DG]
2.4 D	08/97-04/03	AJA	2370		0-N1417	VB [TE]
2.4 D	08/97-04/03	AJA	2370		0-N1600	VB [TE]
2.4 D	08/97-04/03	AJA	2370		0-N1609	VB [BT]
2.4 D	08/97-04/03	AJA	2370		0-N1891	VB [BT]
2.4 D Syncro	10/92-09/98	AAB	2370	ch.→T199999; 11/1992 → 12/1995; für Fahrzeuge mit Servolenkung	0-N1801	VB [BT]
2.4 D, 2.4 D Syncro	09/90-09/98	AAB	2370	ch.70-S-071872→	0-N1311	VB [DG]
2.4 D, 2.4 D Syncro	09/90-09/98	AAB	2370	ch.70-S-071872→; Rippenanzahl: 6	0-N1312	VB [TE]
2.4 D, 2.4 D Syncro	09/90-09/98	AAB	2370	ch.70-S-071872→	0-N1417	VB [TE]
2.4 D, 2.4 D Syncro	09/90-09/98	AAB	2370	ch.70-S-071872→	0-N1600	VB [TE]
2.4 D, 2.4 D Syncro	09/90-09/98	AAB	2370	ch.70-S-071872→	0-N1609	VB [BT]
2.4 D, 2.4 D Syncro	09/90-09/98	AAB	2370	ch.70-S-071872→	0-N1891	VB [BT]
2.5	11/90-04/03	AAF, ACU, AEN, AEU	2461	ch.→M-175000; → 10/1991; für Fahrzeuge mit Servolenkung	0-N1801	VB [BT]
2.5 TDI	09/95-04/03	AUF, AYC	2461		0-N1311	VB [DG]
2.5 TDI	09/95-04/03	ACV, AUF, AYC, AHY, AXG, AJT, AYY	2461	Rippenanzahl: 6	0-N1312	VB [TE]
2.5 TDI	05/98-04/03	AHY, AXG	2461		0-N1543	VB [BT]
2.5 TDI	05/98-04/03	AHY, AXG	2461		0-N1800	VB [VD]
2.5 TDI, 2.5 TDI Syncro	09/95-04/03	ACV	2461	ch.70-X-170001→	0-N1311	VB [DG]
2.5 TDI, 2.5 TDI Syncro	09/95-04/03	ACV	2461	ch.→70-X-170000	0-N1417	VB [TE]
2.5, 2.5 Syncro	11/90-04/03	AAF, ACU, AEN, AEU, AET, APL, AVT	2461		0-N1600	VB [TE]
2.5, 2.5 Syncro	11/90-04/03	AAF, ACU, AEN, AEU, AET, APL, AVT	2461		0-N1609	VB [BT]



OPTIMAL®

VW



CM³



Art. Nr.



ohne Halter

TRANSPORTER T4 Bus (70XB, 70XC, 7DB, 7DW, 7DK)

2.5, 2.5 Syncro, 2.5 TDI, 2.5 TDI Syncro	11/90-04/03	AAF, ACU, AEN, AEU, ACV, AUF, AYC, ACV, AXL, AET, APL, AVT, AHY, AXG, AJT, AYY	2461		0-N1311	VB [DG]
2.5, 2.5 Syncro, 2.5 TDI, 2.5 TDI Syncro	11/90-04/03	AAF, ACU, AEN, AEU, ACV, AUF, AYC, ACV, AXL, AET, APL, AVT, AJT, AYY	2461		0-N1891	VB [BT]

TRANSPORTER T4 Kasten (70XA)

1.9 D	07/90-12/95	1X	1896	25.4x137; :→1X120077; mit Zubehör	SK-1029	BTK
1.9 D	07/90-12/95	1X	1896	25.4x137; :120078→; mit Zubehör	SK-1122	BTK
1.9 TD	10/92-04/03	ABL	1896	25.4x137; 07/1994 →; :→ABL029319; mit Zubehör	SK-1029	BTK
1.9 TD	10/92-04/03	ABL	1896	25.4x137; 07/1994 →; :ABL029320→; mit Zubehör	SK-1122	BTK
2.0	07/90-04/03	AAC	1968	18x124; mit Zubehör	SK-1120	BTK
2.4 D	08/97-04/03	AJA	2370	26.5x122; 20x77; → 04/2002; mit Zubehör	SK-1648	BTK
2.4 D, 2.4 D Syncro	07/90-09/98	AAB	2370	26.5x122; 20x77; :→AAB320126	SK-1578	BTK
2.4 D, 2.4 D Syncro	07/90-09/98	AAB	2370	26.5x122; → 06/1996; :→320126	SK-1578AQ1	BTKW
2.4 D, 2.4 D Syncro	07/90-09/98	AAB	2370	26.5x122; 20x77; :AAB320127→; mit Zubehör	SK-1648	BTK
2.4 TDi	10/92-04/97	AAB	2370	26.5x122; 20x77; :AAB 320127→; mit Zubehör	SK-1648	BTK
2.5	11/90-04/03	AAF, ACU, AEN, AEU	2461	26.5x122; 01/1994 → 04/1998; mit Zubehör	SK-1380	BTK
2.5 Syncro	10/92-04/03	AAF, ACU, AEN, AEU	2461	26.5x122; 01/1994 → 04/1998; :ACU019150→; mit Zubehör	SK-1380	BTK
2.5 TDI	09/95-04/03	ACV, AUF, AYC	2461	26.5x122; 21x81; mit Zubehör; Baumuster: 70XA	SK-1526	BTK
2.5 TDI	09/95-04/03	ACV, AUF, AYC	2461	26.5x122; 21x81; mit Zubehör	SK-1526AQ1	BTKW
2.5 TDI	12/98-04/03	AJT, AYY, AXG	2461	26.5x122; 21x81; mit Zubehör; Baumuster: 70XA	SK-1529	BTK
2.5 TDI	12/98-04/03	AJT, AYY, AXG	2461	26.5x122; mit Zubehör	SK-1529AQ1	BTKW
2.5 TDI	12/98-04/03	AJT, AYY, AXG	2461	26.5x122; mit Zubehör	SK-1725	BTK
2.5 TDI	12/98-04/03	AJT, AYY, AXG	2461	26.5x122; mit Zubehör	SK-1725AQ1	BTKW
2.5 TDI Syncro	09/95-04/03	ACV, AXL	2461	26.5x122; 21x81; 01/1996 →; mit Zubehör; Baumuster: 70XA	SK-1526	BTK
2.5 TDI Syncro	09/95-04/03	ACV	2461	26.5x122; 21x81; 01/1996 →; mit Zubehör	SK-1526AQ1	BTKW
2.5 TDI Syncro	09/95-04/03	AXL	2461	26.5x122; 21x81; mit Zubehör	SK-1529	BTK
2.5 TDI Syncro	09/95-04/03	AXL	2461	26.5x122; mit Zubehör	SK-1529AQ1	BTKW
2.5, 2.5 Syncro	11/90-04/03	ACU	2461	26.5x124; 01/1994 → 04/1998; :→ACU019149; mit Zubehör	SK-1360	BTK
2.5, 2.5 Syncro	11/90-04/03	AAF	2461	26.5x124; ch.70-N-014001→ 07/1995; mit Zubehör	SK-1360	BTK
2.5, 2.5 Syncro	11/90-04/03	AAF	2461	26.4x124; ch.70-N-014001→	SK-1360AQ1	BTKW
2.5, 2.5 Syncro	11/90-04/03	ACU	2461	26.4x124; :→019149	SK-1360AQ1	BTKW
2.5, 2.5 Syncro	11/90-04/03	AEN	2461	26.4x122	SK-1380AQ1	BTKW
2.5, 2.5 Syncro	11/90-04/03	ACU	2461	26.4x122; :019150→; :→048994	SK-1380AQ1	BTKW
2.5, 2.5 Syncro	11/90-04/03	AAF	2461	26.5x122; ch.→70-N-014000	SK-1578AQ1	BTKW
2.5, 2.5 Syncro	08/96-04/03	AET, APL, AVT	2461	26.5x122; mit Zubehör	SK-1380	BTK
1.9 D	07/90-12/95	1X	1896	:120078→	0-N104	TB [TE]
1.9 D	07/90-12/95	1X	1896	:→120077	0-N806	TB [TE]
1.9 TD	10/92-04/03	ABL	1896	:029320→	0-N104	TB [TE]
1.9 TD	10/92-04/03	ABL	1896	:→029319	0-N806	TB [TE]
2.0	07/90-04/03	AAC	1968		0-N805	TB [TE]
2.4 D	08/97-04/03	AJA	2370		0-N109	TB [TE]
2.4 D, 2.4 D Syncro	07/90-09/98	AAB	2370	:320127→	0-N109	TB [TE]
2.4 D, 2.4 D Syncro	07/90-09/98	AAB	2370	:→320126	0-N807	TB [DG]
2.5	08/96-04/03	AET, APL, AVT	2461	:019150→	0-N108	TB [TE]
2.5 Syncro	08/96-04/03	AET, APL, AVT	2461		0-N108	TB [TE]
2.5 TDI	09/95-04/03	ACV, AUF, AYC	2461		0-N109	TB [TE]
2.5 TDI	12/98-04/03	AJT, AYY, AXG	2461		0-N116	TB [TE]
2.5 TDI Syncro	09/95-04/03	ACV	2461		0-N109	TB [TE]
2.5 TDI Syncro	09/95-04/03	AXL	2461		0-N116	TB [TE]
2.5 TDI, 2.5 TDI Syncro	09/95-04/03	ACV, AUF, AYC, ACV, AXL, AJT, AYY, AXG	2461		0-N110	TB [TE]
2.5 TDI, 2.5 TDI Syncro	09/95-04/03	ACV, AUF, AYC, ACV, AXL, AJT, AYY, AXG	2461		0-N117	TB [TE]
2.5, 2.5 Syncro	11/90-04/03	AEN, AEU	2461		0-N108	TB [TE]
2.5, 2.5 Syncro	11/90-04/03	ACU	2461	:019150→	0-N108	TB [TE]
2.5, 2.5 Syncro	11/90-04/03	AAF	2461	ch.70-N-014001→	0-N1444	TB [TE]
2.5, 2.5 Syncro	11/90-04/03	ACU	2461	:→019149	0-N1444	TB [TE]
2.5, 2.5 Syncro	11/90-04/03	AAF	2461		0-N807	TB [DG]
2.5, 2.5 Syncro	11/90-04/03	ACU	2461	:→019149	0-N807	TB [DG]



CM³



Art. Nr.



TRANSPORTER T4 Kasten (70XA)

1.9 D, 1.9 TD	07/90-04/03	1X, ABL	1896		0-N1417	VB [TE]
1.9 D, 1.9 TD	07/90-04/03	1X, ABL	1896		0-N1609	VB [BT]
2.0	07/90-04/03	AAC	1968	ch.→70-T-199000	0-N1311	VB [DG]
2.0	07/90-04/03	AAC	1968	ch.70-T-200001→	0-N1311	VB [DG]
2.0	07/90-04/03	AAC	1968	ch.70-T-200001→ 12/1998; Rippenanzahl: 6	0-N1312	VB [TE]
2.0	07/90-04/03	AAC	1968	01/1999 →; Rippenanzahl: 6	0-N1313	VB [TE]
2.0	07/90-04/03	AAC	1968	ch.70-T-200001→	0-N1417	VB [TE]
2.0	07/90-04/03	AAC	1968	ch.70-T-200001→	0-N1660	VB [BT]
2.0	07/90-04/03	AAC	1968	ch.70-T-200001→	0-N1891	VB [BT]
2.4 D	07/90-04/98	AAB	2370	ch.→M-175000; 09/1990 → 10/1991; für Fahrzeuge mit Servolenkung	0-N1801	VB [BT]
2.4 D	08/97-04/03	AJA	2370		0-N1311	VB [DG]
2.4 D	08/97-04/03	AJA	2370	Rippenanzahl: 6	0-N1312	VB [TE]
2.4 D	08/97-04/03	AJA	2370		0-N1417	VB [TE]
2.4 D	08/97-04/03	AJA	2370		0-N1600	VB [TE]
2.4 D	08/97-04/03	AJA	2370		0-N1609	VB [BT]
2.4 D	08/97-04/03	AJA	2370		0-N1891	VB [BT]
2.4 D Syncro	10/92-09/98	AAB	2370	ch.→T199999; 11/1992 → 12/1995; für Fahrzeuge mit Servolenkung	0-N1801	VB [BT]
2.4 D, 2.4 D Syncro	07/90-09/98	AAB	2370	ch.70-S-071872→	0-N1311	VB [DG]
2.4 D, 2.4 D Syncro	07/90-09/98	AAB	2370	ch.70-S-071872→; Rippenanzahl: 6	0-N1312	VB [TE]
2.4 D, 2.4 D Syncro	07/90-09/98	AAB	2370	ch.70-S-071872→	0-N1417	VB [TE]
2.4 D, 2.4 D Syncro	07/90-09/98	AAB	2370	ch.70-S-071872→	0-N1600	VB [TE]
2.4 D, 2.4 D Syncro	07/90-09/98	AAB	2370	ch.70-S-071872→	0-N1609	VB [BT]
2.4 D, 2.4 D Syncro	07/90-09/98	AAB	2370	ch.70-S-071872→	0-N1891	VB [BT]
2.5	11/90-04/03	AAF, ACU, AEN, AEU	2461	ch.→M-175000; → 10/1991; für Fahrzeuge mit Servolenkung	0-N1801	VB [BT]
2.5 TDI	09/95-04/03	AUF, AYC	2461		0-N1311	VB [DG]
2.5 TDI	09/00-04/03	AXG	2461		0-N1543	VB [BT]
2.5 TDI	09/00-04/03	AXG	2461		0-N1800	VB [VD]
2.5 TDI, 2.5 TDI Syncro	09/95-04/03	ACV	2461	ch.70-X-170001→	0-N1311	VB [DG]
2.5 TDI, 2.5 TDI Syncro	09/95-04/03	ACV	2461	ch.→70-X-170000	0-N1417	VB [TE]
2.5, 2.5 Syncro	11/90-04/03	AAF, ACU, AEN, AEU, AET, APL, AVT	2461		0-N1600	VB [TE]
2.5, 2.5 Syncro	11/90-04/03	AAF, ACU, AEN, AEU, AET, APL, AVT	2461		0-N1609	VB [BT]
2.5, 2.5 Syncro, 2.5 TDI, 2.5 TDI Syncro	11/90-04/03	AAF, ACU, AEN, AEU, ACV, AUF, AYC, ACV, AXL, AET, APL, AVT, AJT, AYY, AXG	2461		0-N1311	VB [DG]
2.5, 2.5 Syncro, 2.5 TDI, 2.5 TDI Syncro	11/90-04/03	AAF, ACU, AEN, AEU, ACV, AUF, AYC, ACV, AXL, AET, APL, AVT, AJT, AYY	2461		0-N1891	VB [BT]
2.5, 2.5 TDI	09/95-04/03	ACV, AUF, AYC, AET, APL, AVT, AJT, AYY, AXG	2461	Rippenanzahl: 6	0-N1312	VB [TE]

TRANSPORTER T4 Pritsche/Fahrgestell (70XD)

1.8	12/90-07/92	PD	1781	18x121; mit Zubehör	SK-1026	BTK
1.9 D	07/90-12/95	1X	1896	25.4x137; :→1X120077; mit Zubehör	SK-1029	BTK
1.9 D	07/90-12/95	1X	1896	25.4x137; :120078→; mit Zubehör	SK-1122	BTK
1.9 TD	10/92-04/03	ABL	1896	25.4x137; 07/1994 →; :→ABL029319; mit Zubehör	SK-1029	BTK
1.9 TD	10/92-04/03	ABL	1896	25.4x137; 07/1994 →; :ABL029320→; mit Zubehör	SK-1122	BTK
2.0	07/90-04/03	AAC	1968	18x124; mit Zubehör	SK-1120	BTK
2.4 D	08/97-04/03	AJA	2370	26.5x122; 20x77; → 04/2002; mit Zubehör	SK-1648	BTK
2.4 D, 2.4 D Syncro	09/90-09/98	AAB	2370	26.5x122; 20x77; :→AAB320126	SK-1578	BTK
2.4 D, 2.4 D Syncro	09/90-09/98	AAB	2370	26.5x122; → 06/1996; :→320126	SK-1578AQ1	BTKW
2.4 D, 2.4 D Syncro	09/90-09/98	AAB	2370	26.5x122; 20x77; :AAB320127→; mit Zubehör	SK-1648	BTK
2.5	11/90-04/03	AAF, ACU, AEN, AEU	2461	26.5x122; 01/1994 → 04/1998; mit Zubehör	SK-1380	BTK
2.5 Syncro	10/92-04/03	AAF, ACU, AEN, AEU	2461	26.5x122; 01/1994 → 04/1998; :ACU019150→; mit Zubehör	SK-1380	BTK
2.5 TDI	09/95-04/03	ACV, AUF, AYC	2461	26.5x122; 21x81; mit Zubehör	SK-1526AQ1	BTKW
2.5 TDI	05/98-04/03	AJT, AYY	2461	26.5x122; 21x81; mit Zubehör; Baumuster: 70XD	SK-1529	BTK
2.5 TDI	05/98-04/03	AJT, AYY	2461	26.5x122; mit Zubehör	SK-1529AQ1	BTKW
2.5 TDI	05/98-04/03	AJT, AYY	2461	26.5x122; mit Zubehör	SK-1725	BTK
2.5 TDI	05/98-04/03	AJT, AYY	2461	26.5x122; mit Zubehör	SK-1725AQ1	BTKW
2.5 TDI Syncro	05/98-04/03	ACV	2461	26.5x122; 21x81; mit Zubehör	SK-1526AQ1	BTKW
2.5 TDI Syncro	05/98-04/03	AXL	2461	26.5x122; 21x81; mit Zubehör	SK-1529	BTK
2.5 TDI Syncro	05/98-04/03	AXL	2461	26.5x122; mit Zubehör	SK-1529AQ1	BTKW
2.5 TDI, 2.5 TDI Syncro	09/95-04/03	ACV, AUF, AYC, ACV, AXL	2461	26.5x122; 21x81; mit Zubehör; Baumuster: 70XD	SK-1526	BTK



OPTIMAL®

VW



CM³



Art. Nr.



ohne Halter

TRANSPORTER T4 Pritsche/Fahrgestell (70XD)

2.5, 2.5 Syncro	11/90-04/03	ACU	2461	26.5x124; 01/1994 → 04/1998; ENGINE: →ACU019149; mit Zubehör	SK-1360	BTK
2.5, 2.5 Syncro	11/90-04/03	AAF	2461	26.5x124; ch.70-N-014001→ 07/1995; mit Zubehör	SK-1360	BTK
2.5, 2.5 Syncro	11/90-04/03	AAF	2461	26.4x124; ch.70-N-014001→	SK-1360AQ1	BTKW
2.5, 2.5 Syncro	11/90-04/03	ACU	2461	26.4x124; ENGINE: →019149	SK-1360AQ1	BTKW
2.5, 2.5 Syncro	11/90-04/03	AEN	2461	26.4x122	SK-1380AQ1	BTKW
2.5, 2.5 Syncro	11/90-04/03	ACU	2461	26.4x122; ENGINE:019150→; ENGINE: →048994	SK-1380AQ1	BTKW
2.5, 2.5 Syncro	11/90-04/03	AAF	2461	26.5x122; ch.→70-N-014000	SK-1578AQ1	BTKW
2.5, 2.5 Syncro	08/96-04/03	AET, APL, AVT	2461	26.5x122; mit Zubehör	SK-1380	BTK
1.9 D	07/90-12/95	1X	1896	ENGINE:120078→	0-N104	TB [TE]
1.9 D	07/90-12/95	1X	1896	ENGINE: →120077	0-N806	TB [TE]
1.9 TD	10/92-04/03	ABL	1896	ENGINE:029320→	0-N104	TB [TE]
1.9 TD	10/92-04/03	ABL	1896	ENGINE: →029319	0-N806	TB [TE]
2.0	07/90-04/03	AAC	1968		0-N805	TB [TE]
2.4 D	08/97-04/03	AJA	2370		0-N109	TB [TE]
2.4 D, 2.4 D Syncro	09/90-09/98	AAB	2370	ENGINE:320127→	0-N109	TB [TE]
2.4 D, 2.4 D Syncro	09/90-09/98	AAB	2370	ENGINE: →320126	0-N807	TB [DG]
2.5	08/96-04/03	AET, APL, AVT	2461	ENGINE:019150→	0-N108	TB [TE]
2.5 Syncro	08/96-04/03	AET, APL, AVT	2461		0-N108	TB [TE]
2.5 TDI	09/95-04/03	ACV, AUF, AYC	2461		0-N109	TB [TE]
2.5 TDI	05/98-04/03	AJT, AYY	2461		0-N116	TB [TE]
2.5 TDI Syncro	05/98-04/03	ACV	2461		0-N109	TB [TE]
2.5 TDI Syncro	05/98-04/03	AXL	2461		0-N116	TB [TE]
2.5 TDI, 2.5 TDI Syncro	09/95-04/03	ACV, AUF, AYC, ACV, AXL, AJT, AYY	2461		0-N110	TB [TE]
2.5 TDI, 2.5 TDI Syncro	09/95-04/03	ACV, AUF, AYC, ACV, AXL, AJT, AYY	2461		0-N117	TB [TE]
2.5, 2.5 Syncro	11/90-04/03	AEN, AEU	2461		0-N108	TB [TE]
2.5, 2.5 Syncro	11/90-04/03	ACU	2461	ENGINE:019150→	0-N108	TB [TE]
2.5, 2.5 Syncro	11/90-04/03	AAF	2461	ch.70-N-014001→	0-N1444	TB [TE]
2.5, 2.5 Syncro	11/90-04/03	ACU	2461	ENGINE: →019149	0-N1444	TB [TE]
2.5, 2.5 Syncro	11/90-04/03	AAF	2461		0-N807	TB [DG]
2.5, 2.5 Syncro	11/90-04/03	ACU	2461	ENGINE: →019149	0-N807	TB [DG]
1.9 D, 1.9 TD	07/90-04/03	1X, ABL	1896		0-N1417	VB [TE]
1.9 D, 1.9 TD	07/90-04/03	1X, ABL	1896		0-N1609	VB [BT]
2.0	07/90-04/03	AAC	1968	ch.→70-T-199000	0-N1311	VB [DG]
2.0	07/90-04/03	AAC	1968	ch.70-T-200001→	0-N1311	VB [DG]
2.0	07/90-04/03	AAC	1968	01/1999 →; Rippenanzahl: 6	0-N1313	VB [TE]
2.0	07/90-04/03	AAC	1968	ch.70-T-200001→	0-N1417	VB [TE]
2.0	07/90-04/03	AAC	1968	ch.70-T-200001→	0-N1660	VB [BT]
2.0	07/90-04/03	AAC	1968	ch.70-T-200001→	0-N1891	VB [BT]
2.4 D	09/90-04/98	AAB	2370	ch.→M-175000; → 10/1991; für Fahrzeuge mit Servolenkung	0-N1801	VB [BT]
2.4 D	08/97-04/03	AJA	2370		0-N1311	VB [DG]
2.4 D	08/97-04/03	AJA	2370		0-N1417	VB [TE]
2.4 D	08/97-04/03	AJA	2370		0-N1600	VB [TE]
2.4 D	08/97-04/03	AJA	2370		0-N1609	VB [BT]
2.4 D	08/97-04/03	AJA	2370		0-N1891	VB [BT]
2.4 D Syncro	10/92-09/98	AAB	2370	ch.→T199999; 11/1992 → 12/1995; für Fahrzeuge mit Servolenkung	0-N1801	VB [BT]
2.4 D, 2.4 D Syncro	09/90-09/98	AAB	2370	ch.70-S-071872→	0-N1311	VB [DG]
2.4 D, 2.4 D Syncro	09/90-09/98	AAB	2370	ch.70-S-071872→; Rippenanzahl: 6	0-N1312	VB [TE]
2.4 D, 2.4 D Syncro	09/90-09/98	AAB	2370	ch.70-S-071872→	0-N1417	VB [TE]
2.4 D, 2.4 D Syncro	09/90-09/98	AAB	2370	ch.70-S-071872→	0-N1600	VB [TE]
2.4 D, 2.4 D Syncro	09/90-09/98	AAB	2370	ch.70-S-071872→	0-N1609	VB [BT]
2.4 D, 2.4 D Syncro	09/90-09/98	AAB	2370	ch.70-S-071872→	0-N1891	VB [BT]
2.5	11/90-04/03	AAF, ACU, AEN, AEU	2461	ch.→M-175000; → 10/1991; für Fahrzeuge mit Servolenkung	0-N1801	VB [BT]
2.5 TDI	09/95-04/03	AUF, AYC	2461		0-N1311	VB [DG]
2.5 TDI	09/95-04/03	ACV, AUF, AYC, AJT, AYY	2461	Rippenanzahl: 6	0-N1312	VB [TE]
2.5 TDI, 2.5 TDI Syncro	09/95-04/03	ACV	2461	ch.70-X-170001→	0-N1311	VB [DG]
2.5 TDI, 2.5 TDI Syncro	09/95-04/03	ACV	2461	ch.→70-X-170000	0-N1417	VB [TE]
2.5, 2.5 Syncro	11/90-04/03	AAF, ACU, AEN, AEU, AET, APL, AVT	2461		0-N1600	VB [TE]
2.5, 2.5 Syncro	11/90-04/03	AAF, ACU, AEN, AEU, AET, APL, AVT	2461		0-N1609	VB [BT]
2.5, 2.5 Syncro, 2.5 TDI, 2.5 TDI Syncro	11/90-04/03	AAF, ACU, AEN, AEU, ACV, AUF, AYC, ACV, AXL, AET, APL, AVT, AJT, AYY	2461		0-N1311	VB [DG]
2.5, 2.5 Syncro, 2.5 TDI, 2.5 TDI Syncro	11/90-04/03	AAF, ACU, AEN, AEU, ACV, AUF, AYC, ACV, AXL, AET, APL, AVT, AJT, AYY	2461		0-N1891	VB [BT]

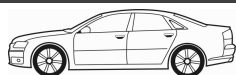

CM³



Art. Nr.



MULTIVAN T5 (7HM, 7HN, 7HF, 7EF, 7EM, 7EN)

1.9 TDI	04/03-11/09	AXB, AXC, BRR, BRS	1896	30x120; mit Zubehör	SK-1372	BTK	
1.9 TDI	04/03-11/09	AXB, AXC, BRR, BRS	1896	30x120	SK-1372AQ1	BTKW	
2.0	11/03-	AXA	1984	23x138; Baumuster: 7EF, 7EM, 7EN, 7HF, 7HM	SK-1109	BTK	
2.0	11/03-	AXA	1984	23x138	SK-1109AQ2	BTKW	
2.0 BiTDI 4motion	09/09-	CFCA	1968	25x160; 01/2010 →	SK-1695	BTK	
2.0 BiTDI, 2.0 BiTDI 4motion, 2.0 TDI, 2.0 TDI 4motion	09/09-	CAAA, CAAB, CAAC, CCHA, CAAE, CCHB, CFCA	1968	25x160; → 11/2010	SK-1695AQ1	BTKW	
2.0 BiTDI, 2.0 BiTDI 4motion, 2.0 TDI, 2.0 TDI 4motion	09/09-	CAAB, CAAC, CCHA, CFCA	1968	25x160; 12/2010 →	SK-1727	BTK	
2.0 BiTDI, 2.0 BiTDI 4motion, 2.0 TDI, 2.0 TDI 4motion	09/09-	CAAE, CCHA, CCHB	1968	25x160; → 11/2010	SK-1727AQ2	BTKW	
2.0 BiTDI, 2.0 TDI, 2.0 TDI 4motion	09/09-	CAAA, CAAB, CAAC, CCHA, CAAE, CCHB, CFCA	1968	25x160	SK-1695	BTK	
2.0 TDI	05/11-	CAAD	1968	25x160	SK-1727	BTK	
2.0 TDI	05/11-	CAAD	1968	25x160	SK-1727AQ2	BTKW	
2.0 TDI, 2.0 TDI 4motion	09/09-	CAAC, CAAE, CCHA, CCHB	1968	25x160; → 11/2010	SK-1727AQ2	BTKW	
1.9 TDI	04/03-11/09	AXB, BRR, BRS	1896		0-N1045	TB [TE]	
1.9 TDI	04/03-11/09	AXB, AXC, BRR, BRS	1896		0-N1046	TB [DG]	
2.0	11/03-	AXA	1984		0-N157	TB [TE]	
2.0 BiTDI, 2.0 BiTDI 4motion, 2.0 TDI, 2.0 TDI 4motion	09/09-	CAAA, CAAB, CAAC, CCHA, CAAD, CAAE, CCHB, CFCA	1968		0-N131	TB [DG]	
2.0 BiTDI, 2.0 BiTDI 4motion, 2.0 TDI, 2.0 TDI 4motion	09/09-	CAAA, CAAB, CAAC, CCHA, CFCA	1968		0-N2025	TB [DG]	
2.0 BiTDI, 2.0 BiTDI 4motion, 2.0 TDI, 2.0 TDI 4motion	09/09-	CAAA, CAAB, CAAC, CCHA, CAAD, CAAE, CCHB, CFCA	1968		0-N2200	TB [DG]	
2.0 TDI, 2.0 TDI 4motion	05/10-	CAAE, CCHB	1968		0-N2025	TB [DG]	
1.9 TDI	04/03-11/09	AXB	1896	ch.→7J-6-022356	0-N1494	VB [BT]	S
1.9 TDI	04/03-11/09	AXB, AXC	1896	ch.7J-6-022357→	0-N1531	VB [BT]	S
1.9 TDI	01/06-11/09	BRR, BRS	1896		0-N1531	VB [BT]	S
2.0 BiTDI, 2.0 BiTDI 4motion, 2.0 TDI, 2.0 TDI 4motion	09/09-	CAAA, CAAB, CAAC, CCHA, CAAD, CAAE, CCHB, CFCA	1968		0-N1534	VB [BT]	S
2.0 BiTDI, 2.0 BiTDI 4motion, 2.0 TDI, 2.0 TDI 4motion	09/09-	CAAA, CAAB, CAAC, CCHA, CAAE, CCHB, CFCA	1968		0-N1738	VB [DG]	
3.2 V6, 3.2 V6 4motion	02/04-11/09	BDL, BKK, CFLA	3189	ch.→7H-4-120000; Rippenanzahl: 6	0-N1496S	VB [TE]	

MULTIVAN T6 (SGF, SGM, SGN)

2.0 TSI, 2.0 TSI 4motion	04/15-	CJKA, CJKB	1984		0-N1832	VB [BT]	S
--------------------------	--------	------------	------	--	---------	---------	---

TRANSPORTER T5 Bus (7HB, 7HJ, 7EB, 7EJ, 7EF, 7EG, 7HF, 7EC)

1.9 TDI	04/03-11/09	AXB, AXC, BRR, BRS	1896	30x120; mit Zubehör	SK-1372	BTK	
1.9 TDI	04/03-11/09	AXB, AXC	1896	30x120; Baumuster: Caravelle	SK-1372AQ1	BTKW	
1.9 TDI	01/06-11/09	BRR, BRS	1896	30x120	SK-1372AQ1	BTKW	
2.0	11/03-	AXA	1984	23x138; Baumuster: 7HB, 7HJ	SK-1109	BTK	
2.0	11/03-	AXA	1984	23x138	SK-1109AQ2	BTKW	
2.0 BiTDI 4motion	09/09-	CFCA	1968	25x160; 01/2010 →	SK-1695	BTK	
2.0 BiTDI, 2.0 BiTDI 4motion, 2.0 TDI, 2.0 TDI 4motion	09/09-	CAAA, CAAB, CAAC, CCHA, CAAE, CCHB, CFCA	1968	25x160; → 11/2010	SK-1695AQ1	BTKW	
2.0 BiTDI, 2.0 BiTDI 4motion, 2.0 TDI, 2.0 TDI 4motion	09/09-	CAAA, CAAB, CAAC, CCHA, CAAE, CCHB, CFCA	1968	25x160; → 11/2010; Baumuster: Caravelle	SK-1695AQ1	BTKW	
2.0 BiTDI, 2.0 BiTDI 4motion, 2.0 TDI, 2.0 TDI 4motion	09/09-	CAAA, CAAB, CAAC, CCHA, CFCA	1968	25x160; 12/2010 →	SK-1727	BTK	
2.0 BiTDI, 2.0 BiTDI 4motion, 2.0 TDI, 2.0 TDI 4motion	09/09-	CAAE, CCHA, CCHB	1968	25x160; → 11/2010	SK-1727AQ2	BTKW	
2.0 BiTDI, 2.0 TDI, 2.0 TDI 4motion	09/09-	CAAA, CAAC, CCHA, CAAD, CAAE, CCHB, CFCA	1968	25x160	SK-1695	BTK	
2.0 TDI	09/09-	CAAB	1968	25x160; → 11/2010	SK-1695	BTK	
2.0 TDI	09/09-	CAAC, CCHA	1968	25x160; → 11/2010; Baumuster: Kombi	SK-1695AQ1	BTKW	
2.0 TDI	05/11-	CAAD	1968	25x160	SK-1727	BTK	
2.0 TDI	05/11-	CAAD	1968	25x160	SK-1727AQ2	BTKW	
2.0 TDI, 2.0 TDI 4motion	09/09-	CAAC, CAAE, CCHA, CCHB	1968	25x160; → 11/2010	SK-1727AQ2	BTKW	
1.9 TDI	04/03-11/09	AXB, AXC, BRR, BRS	1896		0-N1045	TB [TE]	
1.9 TDI	04/03-11/09	AXB, AXC, BRR, BRS	1896		0-N1046	TB [DG]	
2.0	11/03-	AXA	1984		0-N157	TB [TE]	
2.0 BiTDI, 2.0 BiTDI 4motion, 2.0 TDI, 2.0 TDI 4motion	09/09-	CAAA, CAAB, CAAC, CCHA, CAAD, CAAE, CCHB, CFCA	1968		0-N131	TB [DG]	
2.0 BiTDI, 2.0 BiTDI 4motion, 2.0 TDI, 2.0 TDI 4motion	09/09-	CAAA, CAAB, CAAC, CCHA, CFCA	1968		0-N2025	TB [DG]	
2.0 BiTDI, 2.0 BiTDI 4motion, 2.0 TDI, 2.0 TDI 4motion	09/09-	CAAA, CAAB, CAAC, CCHA, CAAD, CAAE, CCHB, CFCA	1968		0-N2200	TB [DG]	
2.0 TDI, 2.0 TDI 4motion	05/10-	CAAE, CCHB	1968		0-N2025	TB [DG]	



CM³



Art. Nr.



ohne Halter

TRANSPORTER T5 Bus (7HB, 7HJ, 7EB, 7EJ, 7EF, 7EG, 7HF, 7EC)

1.9 TDI	04/03-11/09	AXB, AXC	1896	ch.→7J-6-022356	0-N1494	VB [BT]	S
1.9 TDI	04/03-11/09	AXB, AXC	1896	ch.7J-6-022357→	0-N1531	VB [BT]	S
1.9 TDI	01/06-11/09	BRR, BRS	1896		0-N1531	VB [BT]	S
2.0 BitDI, 2.0 BitDI 4motion, 2.0 TDI, 2.0 TDI 4motion	09/09-	CAAA, CAAB, CAAC, CCHA, CAAD, CAAE, CCHB, CFCA	1968		0-N1534	VB [BT]	S
2.0 BitDI, 2.0 BitDI 4motion, 2.0 TDI, 2.0 TDI 4motion	09/09-	CAAA, CAAB, CAAC, CCHA, CAAE, CCHB, CFCA	1968		0-N1738	VB [DG]	
3.2 4motion, 3.2 V6, 3.2 V6 4motion	11/03-11/09	BDL, BKK, CFLA	3189	ch.→7H-4-120000; Rippenanzahl: 6	0-N1496S	VB [TE]	

TRANSPORTER T5 Kasten (7HA, 7HH, 7EA, 7EH)

1.9 TDI	04/03-11/09	AXB, AXC, BRR, BRS	1896	30x120; mit Zubehör	SK-1372	BTK	
1.9 TDI	04/03-11/09	AXB, AXC, BRR, BRS	1896	30x120	SK-1372AQ1	BTKW	
2.0	11/03-	AXA	1984	23x138; Baumuster: 7HA, 7HH	SK-1109	BTK	
2.0	11/03-	AXA	1984	23x138	SK-1109AQ2	BTKW	
2.0 BitDI 4motion	09/09-	CFCA	1968	25x160; 01/2010 → 11/2010	SK-1695	BTK	
2.0 BitDI, 2.0 BitDI 4motion, 2.0 TDI	09/09-	CAAE, CCHA, CCHB	1968	25x160; → 11/2010	SK-1727AQ2	BTKW	
2.0 BitDI, 2.0 BitDI 4motion, 2.0 TDI, 2.0 TDI 4motion	09/09-	CAAA, CAAB, CAAC, CCHA, CAAE, CCHB, CFCA	1968	25x160; → 11/2010	SK-1695AQ1	BTKW	
2.0 BitDI, 2.0 BitDI 4motion, 2.0 TDI, 2.0 TDI 4motion	09/09-	CAAA, CAAB, CAAC, CCHA, CAAE, CCHB, CFCA	1968	25x160; 12/2010 →	SK-1727	BTK	
2.0 BitDI, 2.0 TDI, 2.0 TDI 4motion	09/09-	CAAA, CAAB, CAAC, CCHA, CAAE, CCHB, CFCA	1968	25x160; → 11/2010	SK-1695	BTK	
2.0 TDI	09/09-	CAAB	1968	25x160; → 11/2010; Baumuster: Kombi	SK-1695AQ1	BTKW	
2.0 TDI	05/11-	CAAD	1968	25x160	SK-1727	BTK	
2.0 TDI	05/11-	CAAD	1968	25x160	SK-1727AQ2	BTKW	
2.0 TDI, 2.0 TDI 4motion	09/09-	CAAC, CAAE, CCHA, CCHB	1968	25x160; → 11/2010	SK-1727AQ2	BTKW	
1.9 TDI	04/03-11/09	AXB, AXC, BRR, BRS	1896		0-N1045	TB [TE]	
1.9 TDI	04/03-11/09	AXB, AXC, BRR, BRS	1896		0-N1046	TB [DG]	
2.0	11/03-	AXA	1984		0-N157	TB [TE]	
2.0 BitDI, 2.0 BitDI 4motion, 2.0 TDI, 2.0 TDI 4motion	09/09-	CAAA, CAAB, CAAC, CCHA, CAAD, CAAE, CCHB, CFCA	1968		0-N131	TB [DG]	
2.0 BitDI, 2.0 BitDI 4motion, 2.0 TDI, 2.0 TDI 4motion	09/09-	CAAA, CAAB, CAAC, CCHA, CFCA	1968		0-N2025	TB [DG]	
2.0 BitDI, 2.0 BitDI 4motion, 2.0 TDI, 2.0 TDI 4motion	09/09-	CAAA, CAAB, CAAC, CCHA, CAAD, CAAE, CCHB, CFCA	1968		0-N2200	TB [DG]	
1.9 TDI	04/03-11/09	AXB, AXC	1896	ch.→7J-6-022356	0-N1494	VB [BT]	S
1.9 TDI	04/03-11/09	AXB, AXC	1896	ch.7J-6-022357→	0-N1531	VB [BT]	S
1.9 TDI	01/06-11/09	BRR, BRS	1896		0-N1531	VB [BT]	S
2.0 BitDI, 2.0 BitDI 4motion, 2.0 TDI, 2.0 TDI 4motion	09/09-	CAAA, CAAB, CAAC, CCHA, CAAD, CAAE, CCHB, CFCA	1968		0-N1534	VB [BT]	S
2.0 BitDI, 2.0 BitDI 4motion, 2.0 TDI, 2.0 TDI 4motion	09/09-	CAAA, CAAB, CAAC, CCHA, CFCA	1968		0-N1738	VB [DG]	
3.2 4motion, 3.2 V6	04/03-11/09	BDL, BKK, CFLA	3189	ch.→7H-4-120000; Rippenanzahl: 6	0-N1496S	VB [TE]	

TRANSPORTER T5 Pritsche/Fahrgestell (7JD, 7JE, 7JL, 7JY, 7JZ)

1.9 TDI	04/03-11/09	AXB, AXC, BRR, BRS	1896	30x120; mit Zubehör	SK-1372	BTK	
1.9 TDI	04/03-11/09	AXB, AXC, BRR, BRS	1896	30x120	SK-1372AQ1	BTKW	
2.0	11/03-	AXA	1984	23x138; Baumuster: 7JD,7JE,7JL,7JY,7JZ	SK-1109	BTK	
2.0	11/03-	AXA	1984	23x138	SK-1109AQ2	BTKW	
2.0 BitDI 4motion	09/09-	CFCA	1968	25x160; 01/2010 → 11/2010	SK-1695	BTK	
2.0 BitDI, 2.0 BitDI 4motion, 2.0 TDI, 2.0 TDI 4motion	09/09-	CAAA, CAAB, CAAC, CAAE, CAAE, CCHB, CFCA	1968	25x160; → 11/2010	SK-1695AQ1	BTKW	
2.0 BitDI, 2.0 BitDI 4motion, 2.0 TDI, 2.0 TDI 4motion	09/09-	CAAA, CAAB, CAAC, CAAE, CAAE, CCHB, CFCA	1968	25x160; 12/2010 →	SK-1727	BTK	
2.0 BitDI, 2.0 BitDI 4motion, 2.0 TDI, 2.0 TDI 4motion	09/09-	CAAE, CCHA, CCHB	1968	25x160; → 11/2010	SK-1727AQ2	BTKW	
2.0 BitDI, 2.0 TDI, 2.0 TDI 4motion	09/09-	CAAA, CAAB, CAAC, CAAE, CAAE, CCHB, CFCA	1968	25x160; → 11/2010	SK-1695	BTK	
2.0 TDI	05/11-	CAAD	1968	25x160	SK-1727	BTK	
2.0 TDI	05/11-	CAAD	1968	25x160	SK-1727AQ2	BTKW	
1.9 TDI	04/03-11/09	AXB, AXC, BRR, BRS	1896		0-N1045	TB [TE]	
1.9 TDI	04/03-11/09	AXB, AXC, BRR, BRS	1896		0-N1046	TB [DG]	
2.0	11/03-	AXA	1984		0-N157	TB [TE]	
2.0 BitDI, 2.0 BitDI 4motion, 2.0 TDI, 2.0 TDI 4motion	09/09-	CAAA, CAAB, CAAC, CAAD, CAAE, CAAE, CCHB, CFCA	1968		0-N131	TB [DG]	
2.0 BitDI, 2.0 BitDI 4motion, 2.0 TDI, 2.0 TDI 4motion	09/09-	CAAA, CAAB, CAAC, CFCA	1968		0-N2025	TB [DG]	
2.0 BitDI, 2.0 BitDI 4motion, 2.0 TDI, 2.0 TDI 4motion	09/09-	CAAA, CAAB, CAAC, CAAD, CAAE, CAAE, CCHB, CFCA	1968		0-N2200	TB [DG]	
1.9 TDI	04/03-11/09	AXB, AXC	1896	ch.→7J-6-022356	0-N1494	VB [BT]	S
1.9 TDI	04/03-11/09	AXB, AXC	1896	ch.7J-6-022357→	0-N1531	VB [BT]	S

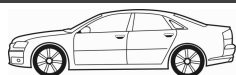

CM³



Art. Nr.



TRANSPORTER T5 Pritsche/Fahrgestell (7JD, 7JE, 7JL, 7JY, 7JZ)							
1.9 TDI	01/06-11/09	BRR, BRS	1896		0-N1531	VB [BT]	S
2.0 BiTDI, 2.0 BiTDI 4motion, 2.0 TDI, 2.0 TDI 4motion	09/09-	CAAA, CAAB, CAAC, CAAD, CAAE, CAEE, CCHB, CFCA	1968		0-N1534	VB [BT]	S
2.0 BiTDI, 2.0 BiTDI 4motion, 2.0 TDI, 2.0 TDI 4motion	09/09-	CAAA, CAAB, CAAC, CFCA	1968		0-N1738	VB [DG]	
3.2 V6	08/03-11/09	BDL, BKK	3189	ch.→7H-4-120000; Rippenanzahl: 6	0-N1496S	VB [TE]	
TRANSPORTER T6 Bus (SGB, SGG, SGJ)							
2.0 TSI, 2.0 TSI 4motion	04/15-	CJKA, CJKB	1984		0-N1832	VB [BT]	S
TRANSPORTER T6 Kasten (SGA, SGH)							
2.0 TSI, 2.0 TSI 4motion	04/15-	CJKA, CJKB	1984		0-N1832	VB [BT]	S
TRANSPORTER T6 Pritsche/Fahrgestell (SFD, SFE, SFL, SFZ)							
2.0 TSI	04/15-	CJKB	1984		0-N1832	VB [BT]	S
UP							
1.0, 1.0 EcoFuel	08/11-	CHYA, CHYB, CPGA	999		0-N2313	TB [TE]	
1.0, 1.0 EcoFuel	08/11-	CHYA, CHYB, CPGA	999		0-N2381	TB [DG]	
1.0, 1.0 EcoFuel	08/11-	CHYA, CHYB, CPGA	999	✳, für Fahrzeuge ohne Start-Stopp-Funktion	0-N2271	VB [TE]	
VENTO (1H2)							
1.4	11/91-09/98	ABD	1390	19x128	R-1190AQ1	BTKW	
1.4	11/91-09/98	ABD, AEX	1390	19x128	R-1190AQ1	BTKW	
1.4	11/91-09/98	AEX	1390	19x135; mit Zubehör	SK-1131	BTK	
1.4	11/91-09/98	AEX	1390	19x135; mit Zubehör	SK-1131AQ1	BTKW	
1.6	09/92-09/98	ABU	1598	19x133; → 12/1994	R-1257AQ1	BTKW	
1.6	09/92-09/98	AEA, AEE	1598	19x137; mit Zubehör	SK-1074	BTK	
1.6	09/92-09/98	AEA, AEE	1598	19x137; 01/1995 →	SK-1074AQ1	BTKW	
1.6	10/94-09/98	AEK, AFT	1595	18x121; mit Zubehör	SK-1090	BTK	
1.8	11/91-09/98	AAM, ABS, ADZ	1781	18x121; R...; → 07/1994; mit Zubehör	SK-1026	BTK	
1.8	11/91-09/98	AAM, ABS, ADZ	1781	18x121; 07/1994 →; mit Zubehör	SK-1090	BTK	
1.9 D	11/91-09/98	1Y	1896	25.4x137; → 07/1994; → 1Y378364; mit Zubehör	SK-1029	BTK	
1.9 D	11/91-09/98	1Y	1896	25.4x137; 07/1994 →; →:378365→; mit Zubehör	SK-1122	BTK	
1.9 SDI, 1.9 TDI	04/96-09/98	AEY, AFN	1896	25x137; mit Zubehör	SK-1098	BTK	
1.9 TD	11/91-09/98	AAZ	1896	25.4x137; → 07/1994; →:AAZ552765; mit Zubehör	SK-1029	BTK	
1.9 TD	11/91-09/98	AAZ	1896	25.4x137; 07/1994 →; →:AAZ552766→; mit Zubehör	SK-1122	BTK	
1.9 TDI	09/93-09/98	1Z	1896	25.4x137; → 07/1994; →:1Z289575; mit Zubehör	SK-1069	BTK	
1.9 TDI	09/93-09/98	1Z, AHU, ALE	1896	25x137; 07/1994 →; →:289576→; mit Zubehör	SK-1098	BTK	
2.0, 2.0 GL	11/91-09/98	2E, ADY, AGG, AKR, AEP	1984	18x124; mit Zubehör	SK-1120	BTK	
1.4	11/91-09/98	ABD, AEX	1390		0-N106	TB [TE]	
1.4	11/91-09/98	AEX	1390		0-N106	TB [TE]	
1.6	09/92-09/98	ABU, AEA, AEE	1598		0-N106	TB [TE]	
1.6	10/94-09/98	AEK, AFT	1595		0-N805	TB [TE]	
1.8	11/91-09/98	AAM, ABS, ADZ	1781		0-N805	TB [TE]	
1.9 D, 1.9 SDI, 1.9 TDI	11/91-09/98	1Y, AEY, AFN	1896		0-N104	TB [TE]	
1.9 D, 1.9 SDI, 1.9 TDI	11/91-09/98	1Y, 1Z, AHU, ALE, AEY, AFN	1896		0-N128	TB [DG]	
1.9 TD	11/91-09/98	AAZ	1896	→:552766→	0-N104	TB [TE]	
1.9 TD	11/91-09/98	AAZ	1896	→:552765	0-N806	TB [TE]	
1.9 TDI	09/93-09/98	1Z, AHU, ALE	1896	→:289575	0-N103	TB [TE]	
1.9 TDI	09/93-09/98	1Z, AHU, ALE	1896	→:289576→	0-N104	TB [TE]	
2.0 GL	11/91-07/98	AAC	1968		0-N805	TB [TE]	
2.0, 2.0 GL	11/91-09/98	2E, ADY, AGG, AKR, AEP	1984		0-N805	TB [TE]	
1.4	11/91-09/98	ABD	1390	ch.1H-S-120 001→; für Fahrzeuge mit Servolenkung	0-N1445	VB [BT]	S
1.4	11/91-09/98	AEX	1390	für Fahrzeuge mit Servolenkung	0-N1445	VB [BT]	S
1.4	11/91-09/98	ABD	1390	ch.→1H-S-120000; für Fahrzeuge mit Servolenkung	0-N1459	VB [BT]	S
1.6	09/92-09/98	ABU, AEA, AEE	1598		0-N1417	VB [TE]	
1.6	09/92-09/98	ABU	1598	ch.1H-S-120 001→	0-N1445	VB [BT]	S
1.6	09/92-09/98	AEA, AEE	1598	für Fahrzeuge mit Servolenkung	0-N1445	VB [BT]	S
1.6	09/92-09/98	ABU	1598	ch.→1H-S-120000	0-N1459	VB [BT]	S
1.6	09/92-09/98	AEA, AEE	1598		0-N1660	VB [BT]	
1.6	10/94-09/98	AEK, AFT	1595		0-N1417	VB [TE]	
1.6	10/94-09/98	AEK, AFT	1595		0-N1660	VB [BT]	



CM³



Art. Nr.



ohne Halter

VENTO (1H2)

1.8	11/91-09/98	AAM, ABS, ADZ	1781		0-N1417	VB [TE]	
1.8	11/91-09/98	AAM, ABS, ADZ	1781		0-N1660	VB [BT]	
1.9 D, 1.9 SDI, 1.9 TD, 1.9 TDI	11/91-09/98	1Y, 1Z, AHU, ALE, AAZ, AEY, AFN	1896		0-N1417	VB [TE]	
1.9 D, 1.9 SDI, 1.9 TD, 1.9 TDI	11/91-09/98	1Y, 1Z, AHU, ALE, AAZ, AEY, AFN	1896		0-N1609	VB [BT]	
2.0	11/91-09/98	2E, ADY, AGG, AKR	1984		0-N1660	VB [BT]	
2.0 GL	11/91-07/98	AAC	1968		0-N1417	VB [TE]	
2.0, 2.0 GL	11/91-09/98	2E, ADY, AGG, AKR, AEP	1984		0-N1417	VB [TE]	
2.8 VR6	01/92-09/98	AAA	2792	Rippenanzahl: 7	0-N1657	VB [BT]	S

VOYAGE

1.9 D, 1.9 TDi	06/96-09/01	1Y, 1Z	1896		0-N104	TB [TE]	
1.9 TDi	09/99-09/01	1Z	1896		0-N128	TB [DG]	
1.9 D, 1.9 TDi	06/96-09/01	1Y, 1Z	1896		0-N1417	VB [TE]	

VOYAGE

1.0 Flex	07/08-	CCNA	999		0-N1331	TB [TE]	
1.6 Flex	07/08-	CFZA	1598		0-N1331	TB [TE]	



CM³



Art. Nr.



BORA (1J2)

1.9 TDi	03/04-12/06	ATD	1896		0-N1046	TB [DG]	
---------	-------------	-----	------	--	----------------	---------	--

GOLF (1J1)

1.9 TDi	05/01-	AGR	1896		0-N1046	TB [DG]	
---------	--------	-----	------	--	----------------	---------	--

GOLF (1K1)

1.4 TSI	08/09-	CFB	1390	✳	0-N1733	VB [BT]	S
1.6	08/09-	CDF, CLR	1598	✳	0-N1733	VB [BT]	S

JETTA (1G2, 1J2)

1.6	05/91-12/99	ABX	1595		0-N805	TB [TE]	
1.9 TDi	08/98-04/00	ALH	1896	für OE: 058109244	0-N131	TB [DG]	

SAGITAR

1.8 TURBO	04/06-04/08	BPL	1781	23x150; mit Zubehör	SK-1726	BTK	
1.8 TURBO	04/06-04/08	BPL	1781		0-N1316	TB [DG]	
1.8 TURBO	04/06-04/08	BPL	1781		0-N1822	TB [BT]	S
1.4 TSI	09/09-	CFB	1390	✳	0-N1733	VB [BT]	S
1.8 TURBO	04/06-04/08	BPL	1781		0-N1656	VB [BT]	S



CM³



Art. Nr.



ohne Halter

GOL								
1.6	12/03-02/05	BHJ	1595			0-N805	TB [TE]	
LAVIDA								
1.4 TSi	03/10-08/12	CFB	1390	✳		0-N1733	VB [BT]	S
1.6	04/08-08/12	CDE	1598	✳		0-N1733	VB [BT]	S
PASSAT LINGYU Stufenheck (B5)								
1.8 T	11/05-04/09	BGC	1781		23x150; mit Zubehör	SK-1726	BTK	
1.8 T	11/05-04/09	BGC	1781			0-N1316	TB [DG]	
1.8 T	11/05-04/09	BGC	1781			0-N1822	TB [BT]	S
PASSAT Stufenheck (B5)								
1.8 Turbo	01/01-04/09	AWL, BGC	1781		23x150; mit Zubehör	SK-1726	BTK	
1.8 Turbo	01/01-04/09	AWL, BGC	1781			0-N1316	TB [DG]	
1.8 Turbo	01/01-04/09	AWL, BGC	1781			0-N1822	TB [BT]	S
1.8 Turbo	01/01-04/09	AWL, BGC	1781		Rippenanzahl: 4	0-N1317	VB [TE]	S
POLO Schrägheck								
1.4	01/02-03/06	BCC	1390	✳		0-N1733	VB [BT]	S
POLO Stufenheck								
1.4	06/03-03/06	BCC	1390	✳		0-N1733	VB [BT]	S
POLO JINQIN Schrägheck								
1.4	06/06-12/07	BCC, BMG	1390	✳		0-N1733	VB [BT]	S
1.6	06/06-12/07	BMH, CDE	1598	✳		0-N1733	VB [BT]	S
POLO JINQU Stufenheck								
1.4	06/06-12/07	BCC, BMG	1390	✳		0-N1733	VB [BT]	S
1.6	12/07-	CDE	1598	✳		0-N1733	VB [BT]	S
SANTANA								
1.8	03/85-08/96	JV	1781			0-N805	TB [TE]	
SANTANA								
1.6	08/96-12/11	AYF	1600			0-N805	TB [TE]	
1.8	08/96-12/11	JV	1781			0-N805	TB [TE]	
SANTANA Kombi								
1.8	08/96-12/11	AFE	1781			0-N805	TB [TE]	
SANTANA 2000								
1.8	04/95-03/04	AFE, JV	1781			0-N805	TB [TE]	
TOURAN (1T1, 1T2)								
1.8 Turbo	05/05-01/08	BPL, CFU	1781		23x150; mit Zubehör	SK-1726	BTK	
1.8 Turbo	05/05-01/08	BPL, CFU	1781			0-N1316	TB [DG]	



CM³



Art. Nr.



ohne Halter

SANA

1.4	10/89-10/93	14FE	1372	15x138	SK-1031	BTK
-----	-------------	------	------	--------	---------	-----



CM³



Art. Nr.



ohne Halter

10 (188)

1.2 60	10/05-	188 A4.000	1242	15x129; :→2533528	SK-1418	BTK	
1.2 60	10/05-	188 A4.000	1242	15x129; :→2533528	SK-1418AQ1	BTKW	
1.2 60	10/05-	188 A4.000	1242	22x129; :2533529→	SK-1677	BTK	

YUGO FLORIDA

1.4, 1.4 KAT	10/88-06/95	160 A1.000	1372	15x138	SK-1031	BTK	
1.4	10/88-06/95	160 A1.000	1372		0-N822	TB [TE]	

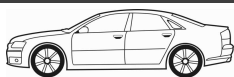
CM³

Art. Nr.

ohne
Halter**LANOS PICK-UP**

1.4	10/04-	A13SM	1349	17x111; mit Zubehör	SK-1162	BTK	
1.5	10/04-	A15SM	1498	17x111; mit Zubehör	SK-1162	BTK	
1.4	10/04-	A13SM	1349		0-N2097	FB [DG]	
1.5	10/04-	A15SM	1498		0-N2097	FB [DG]	

LANOS Schrägheck

1.4	10/04-	A13SM	1349	17x111; mit Zubehör	SK-1162	BTK	
1.5	10/04-	A15SM	1498	17x111; mit Zubehör	SK-1162	BTK	
1.6 16V	10/04-	A16DMS	1598	25x127	SK-1273	BTK	
1.6 16V	10/04-	A16DMS	1598	25x127	SK-1273AQ1	BTKW	
1.6 16V	10/04-	A16DMS	1598		0-N1532	VB [BT]	S
1.4	10/04-	A13SM	1349		0-N2097	FB [DG]	
1.5	10/04-	A15SM	1498		0-N2097	FB [DG]	

LANOS Stufenheck

1.4	10/04-	A13SM	1349	17x111; mit Zubehör	SK-1162	BTK	
1.5	10/04-	A15SM	1498	17x111; mit Zubehör	SK-1162	BTK	
1.6 16V	10/04-	A16DMS	1598	25x127	SK-1273	BTK	
1.6 16V	10/04-	A16DMS	1598	25x127	SK-1273AQ1	BTKW	
1.6 16V	10/04-	A16DMS	1598		0-N1532	VB [BT]	S
1.4	10/04-	A13SM	1349		0-N2097	FB [DG]	
1.5	10/04-	A15SM	1498		0-N2097	FB [DG]	



OPTIMAL®

ZHONGHUA(BRILLIANCE)



CM³



Art. Nr.



ohne Halter

JUNJIE Stufenheck (M2)

1.8	02/06-07/10	4 G 93	1834	für OE: MD169592	0-N056	TB [TE]	
1.8	02/06-07/10	4 G 93	1834	für OE: MD320174	0-N182	TB [TE]	

JUNJIE WAGON

1.8	12/08-	4 G 93	1834		0-N056	TB [TE]	
-----	--------	--------	------	--	---------------	---------	--

KUBAO Coupe (M3)

1.8	09/07-	4 G 93	1834		0-N056	TB [TE]	
-----	--------	--------	------	--	---------------	---------	--

ZUNCHI (M1)

1.8	08/07-12/10	4 G 93	1834		0-N056	TB [TE]	
1.8	08/07-12/10	4 G 93	1834		0-N182	TB [TE]	



ACURA

31170-PNA-003	0-N1850
31170-PNA-003	0-N1850S
31170-PNA-013	0-N1850
31170-PNA-013	0-N1850S
31170-PNA-023	0-N1850
31170-PNA-023	0-N1850S
31170-R40-A01	0-N2399
31170-R40-A01	0-N2399S
31170-RAA-A01	0-N1850
31170-RAA-A01	0-N1850S
31170-RAA-A02	0-N1850
31170-RAA-A02	0-N1850S
31170-RLF-J01	0-N2399
31170-RLF-J01	0-N2399S

ALFA ROMEO

46442999	0-N1407
46442999	0-N1407S
46524692	0-N1407
46524692	0-N1407S
46546374	0-N1487
46546374	0-N1487S
46547566	0-N1404
51800046	0-N2122
51837698	0-N2093
51837698	0-N2093S
55180011	0-N1487
55180011	0-N1487S
55183527	0-N115
55184055	0-N2117
55184055	0-N2117S
55190052	0-N1408
55190053	0-N1595
55190053	0-N1595S
55190054	0-N1594
55191315	0-N115
55191536	0-N1092
55192239	0-N114
55192323	0-N115
55193357	0-N2093
55193357	0-N2093S
55195531	0-N1976
55208381	0-N115
55212159	0-N115
55215666	0-N115
55238027	0-N115
60504224	0-N800
60504225	0-N801
60504226	0-N937
60561380	0-N2412
60570850	0-N1623
60578872	0-N2413
60595625	0-N1546

ALFA ROMEO

60595630	0-N2156
60596372	0-N114
60603056	0-N1093
60608908	0-N1572
60616155	0-N2413
60616799	0-N1092
60620443	0-N1572
60621380	0-N194
60624747	0-N1594
60652129	0-N938
60652477	0-N194
60654130	0-N1408
60664403	0-N938
60671573	0-N938
60778797	0-N2413
60800148	0-N823
60805460	0-N187
60808692	0-N889
60811332	0-N1407
60811332	0-N1407S
60811487	0-N889
60811488	0-N835
60812384	0-N1572
60812515	0-N1403
60812622	0-N114
60812624	0-N938
60812645	0-N187
60813221	0-N1408
60813307	0-N1595
60813307	0-N1595S
60813311	0-N1093
60813312	0-N1092
60813415	0-N938
60813592	0-N115
60813721	0-N1404
60814110	0-N1407
60814110	0-N1407S
60814462	0-N194
60814917	0-N1404
60815188	0-N1487
60815188	0-N1487S
71736493	0-N950
71736717	SK-1412
71736724	SK-1410
71736725	SK-1415
71736726	SK-1629
71736727	SK-1361
71736728	SK-1639
71736729	SK-1365
71736729	SK-1697
71736793	0-N950
71736795	SK-1112

ALFA ROMEO

71739304	0-N1588
71739304	0-N1588S
71747798	0-N1487
71747798	0-N1487S
71747799	0-N115
71754557	SK-1602
71754558	SK-1367
71754559	SK-1586
71754560	SK-1696
71754561	SK-1677
71754562	SK-1693
71754563	SK-1586
71754564	SK-1587
71754845	SK-1033
71771574	SK-1629AQ1
71771575	SK-1412AQ2
71771599	SK-1412AQ2
71773293	SK-1365
73501924	0-N1403
7596877	0-N835
7763644	0-N950
7778565	0-N115
7798333	0-N1407
7798333	0-N1407S
9400831489	SK-1082
9400831589	SK-1086

AUDI

022 145 276 A	0-N2110
022 145 276 C	0-N1715
022 145 276 F	0-N1715
022 145 299 A	0-N1496S
022 145 299 C	0-N2209
022 145 299 C	0-N2209S
022 145 299 D	0-N1496S
022 145 299 E	0-N1676
022 145 299 E	0-N1676S
022 145 299 H	0-N2209
022 145 299 H	0-N2209S
022 145 299 L	0-N2209
022 145 299 L	0-N2209S
026 109 243	0-N805
026 109 243 A	0-N805
026 109 243 C	0-N805
026 109 243 E	0-N805
026 109 243 F	0-N805
026 109 243 G	0-N805
026 109 243 J	0-N132
026 109 243 L	0-N805
026 198 119	SK-1101
027 109 243	0-N808
027 198 119	SK-1124
028 109 243	0-N103

AUDI

028 109 243 B	0-N103
028 109 243 E	0-N104
028 109 243 F	0-N104
028 109 243 H	0-N1332
028 109 243 J	0-N1332
028 109 243 K	0-N1332
028 109 244	0-N128
028 109 244 B	0-N128
028 145 278	0-N1417
028 145 278 A	0-N1417
028 145 278 E	0-N1417
028 145 278 J	0-N1432
028 145 278 J	0-N1432S
028 198 119	SK-1029
028 198 119 A	SK-1122
028 198 119 B	SK-1069
028 198 119 C	SK-1098
028 198 119 D	SK-1593
028 903 315 M	0-N1432
028 903 315 N	0-N1609
028 903 315 R	0-N1609
030 145 299 C	0-N1445
030 145 299 C	0-N1445S
030 145 299 F	0-N1445
030 145 299 F	0-N1445S
036 109 181 A	0-N164
036 109 181 B	0-N164
036 109 243 AB	0-N158
036 109 243 AC	0-N1263
036 109 243 AD	0-N158
036 109 243 AE	0-N1263
036 109 243 AF	0-N158
036 109 243 AG	0-N1263
036 109 243 E	0-N158
036 109 243 K	0-N1263
036 109 243 L	0-N158
036 109 243 R	0-N158
036 109 243 S	0-N1263
036 109 244 C	0-N1262
036 109 244 D	0-N1262
036 109 244 J	0-N1262
036 109 244 K	0-N131
036 198 119 A	SK-1511
036 198 119 C	SK-1511
036 198 119 E	SK-1511
038 109 243	0-N107
038 109 243 D	0-N107
038 109 243 F	0-N107
038 109 243 G	0-N107
038 109 243 H	0-N107
038 109 243 M	0-N1045
038 109 243 N	0-N107

AUDI		AUDI		AUDI		AUDI	
038 109 244 B	0-N166	038 903 315 T	0-N1534	03L 109 244 G	0-N2200	056 198 119	SK-1026
038 109 244 C	0-N166	038 903 315 T	0-N1534S	03L 109 244 H	0-N2200	057 109 243 A	0-N1969
038 109 244 E	0-N167	03C 145 276 C	0-N2133	03L 198 119	SK-1694	057 109 243 M	0-N1337
038 109 244 H	0-N166	03C 145 299 A	0-N2111	03L 198 119 A	SK-1695	057 109 487	0-N1978
038 109 244 J	0-N1046	03C 145 299 A	0-N2111S	03L 198 119 B	SK-1695	057 109 487	0-N1978S
038 109 244 M	0-N166	03C 145 299 AC	0-N2111	03L 198 119 C	SK-1727	058 109 243 B	0-N130S
038 109 244 N	0-N1046	03C 145 299 AC	0-N2111S	03L 198 119 D	SK-1727	058 109 243 C	0-N1236
038 109 244 P	0-N131	03C 145 299 AF	0-N2111	03L 198 119 F	SK-1727	058 109 243 D	0-N130
038 109 244 Q	0-N167	03C 145 299 AF	0-N2111S	045 109 243 A	0-N1048	058 109 243 E	0-N1236
038 109 244 R	0-N166	03C 145 299 C	0-N1733	045 109 243 B	0-N1265	058 109 244	0-N131
038 145 276	0-N174	03C 145 299 C	0-N1733S	045 109 243 C	0-N1048	058 109 479	0-N1276
038 145 278	0-N2047	03C 145 299 G	0-N2111	045 109 243 D	0-N1265	058 109 479 B	0-N1276
038 145 299 A	0-N2139	03C 145 299 G	0-N2111S	045 109 243 F	0-N1045	058 198 119	SK-1346
038 198 119	SK-1582	03C 145 299 H	0-N2111	045 109 244 A	0-N1268	058 198 119 A	SK-1641
038 198 119 A	SK-1372	03C 145 299 H	0-N2111S	045 109 479 B	0-N1274	058 198 479	SK-1638
038 198 119 B	SK-1378	03C 145 299 J	0-N2091	045 109 479 C	0-N1049	058 198 479 A	SK-1121
038 198 119 B	SK-1388	03C 145 299 J	0-N2091S	045 109 479 D	0-N1344	058 260 511	0-N1317
038 198 119 C	SK-1372	03C 145 299 K	0-N2111	045 903 315 A	0-N1704	058 260 511	0-N1317S
038 198 119 D	SK-1111	03C 145 299 K	0-N2111S	045 903 315 A	0-N1704S	058 903 133	0-N1822
038 198 119 D	SK-1258	03C 145 299 L	0-N2111	046 130 195 B	0-N1229	058 903 133	0-N1822S
038 198 119 E	SK-1258	03C 145 299 L	0-N2111S	046 130 195 C	0-N1230	058 903 133 B	0-N1822
038 198 119 F	SK-1110	03C 145 299 M	0-N2092	046 130 195 D	0-N1230	058 903 133 B	0-N1822S
038 198 119 F	SK-1259	03C 145 299 M	0-N2092S	046 903 133 A	0-N1601	058 903 133 C	0-N1822
038 198 119 G	SK-1372	03C 145 299 P	0-N2111	046 903 133 A	0-N1601S	058 903 133 C	0-N1822S
038 903 315 A	0-N1606	03C 145 299 P	0-N2111S	048 109 243 A	0-N922	058 903 133 D	0-N1822
038 903 315 A	0-N1606S	03C 145 299 Q	0-N1733	04C 109 244 B	0-N2381	058 903 133 D	0-N1822S
038 903 315 AB	0-N1536	03C 145 299 Q	0-N1733S	04C 109 244 D	0-N2381	059 109 243 D	0-N1266
038 903 315 AB	0-N1536S	03D 145 276 A	0-N1909	04C 109 479 G	0-N2313	059 109 243 F	0-N201
038 903 315 AD	0-N1534	03D 145 276 D	0-N1909	04C 109 479 H	0-N2313	059 109 243 G	0-N201
038 903 315 AD	0-N1534S	03D 145 276 E	0-N1909	04C 109 479 J	0-N2313	059 109 243 J	0-N1266
038 903 315 AE	0-N1494	03F 145 276	0-N2121	04E 109 244 A	0-N2381	059 109 243 L	0-N201
038 903 315 AE	0-N1494S	03G 109 243	0-N1335	04E 109 244 B	0-N2381	059 109 243 N	0-N1337
038 903 315 AG	0-N1534	03G 109 244	0-N1336	04E 109 244 D	0-N2381	059 109 243 P	0-N1337
038 903 315 AG	0-N1534S	03G 109 244 A	0-N1575	04E 109 244 E	0-N2381	059 109 244	0-N168
038 903 315 AH	0-N1534	03G 145 276	0-N1738	04E 109 479 A	0-N2313	059 109 244 A	0-N168
038 903 315 AH	0-N1534S	03G 145 276 A	0-N1928	04E 109 479 B	0-N2313	059 109 244 B	0-N168
038 903 315 AJ	0-N1534	03G 198 119	SK-1595	04E 109 479 C	0-N2313	059 109 479 B	0-N1364
038 903 315 AJ	0-N1534S	03G 198 119 A	SK-1668	04L 109 243 B	0-N2314	059 109 487 A	0-N1363
038 903 315 AM	0-N1534	03G 198 119 B	SK-1595	04L 109 243 C	0-N2314	059 109 487 B	0-N1363
038 903 315 AM	0-N1534S	03G 198 119 C	SK-1668	04L 109 243 G	0-N2314	059 109 487 C	0-N1363
038 903 315 C	0-N1538	03G 903 315 C	0-N1531	04L 903 315 A	0-N2288	059 145 201 D	0-N1918
038 903 315 C	0-N1538S	03G 903 315 C	0-N1531S	04L 903 315 A	0-N2288S	059 145 201 D	0-N1918S
038 903 315 D	0-N1441	03L 109 243 A	0-N1905	04L 903 315 B	0-N2288	059 145 201 E	0-N1955
038 903 315 D	0-N1441S	03L 109 243 B	0-N2061	04L 903 315 B	0-N2288S	059 145 201 E	0-N1955S
038 903 315 E	0-N1606	03L 109 243 D	0-N2061	04L 903 315 F	0-N2288	059 145 201 F	0-N1918
038 903 315 E	0-N1606S	03L 109 243 E	0-N1905	04L 903 315 F	0-N2288S	059 145 201 F	0-N1918S
038 903 315 F	0-N1494	03L 109 243 F	0-N2061	04L 903 315 G	0-N2288	059 145 276	0-N1308
038 903 315 F	0-N1494S	03L 109 244	0-N2025	04L 903 315 G	0-N2288S	059 145 283 A	0-N2196
038 903 315 K	0-N1606	03L 109 244 B	0-N2025	051 109 243	0-N808	059 145 284	0-N1947
038 903 315 K	0-N1606S	03L 109 244 C	0-N1268	051 109 243 A	0-N129	059 145 284 B	0-N1947
038 903 315 P	0-N1441	03L 109 244 D	0-N131	053 903 341	0-N2345	059 198 119	SK-1619
038 903 315 P	0-N1441S	03L 109 244 E	0-N2025	054 109 479	0-N939	059 198 119 A	SK-1619



AUDI		AUDI		AUDI		AUDI	
059 198 119 B	SK-1619	06B 903 133 E	0-N1671S	06E 903 341 H	0-N2351	078 109 479 E	0-N1275
059 260 523 A	0-N1005	06B 903 341	0-N1662	06F 198 119	SK-1599	078 109 487 A	0-N1371
059 260 523 B	0-N1005	06B 903 341 B	0-N1662	06F 198 119 B	SK-1724	078 109 487 C	0-N1371
059 903 133 F	0-N2287	06C 109 244	0-N1053	06F 903 315	0-N1656	078 198 119	SK-1383
059 903 133 F	0-N2287S	06C 109 244 C	0-N1052	06F 903 315	0-N1656S	078 198 119 A	SK-1376
059 903 133 J	0-N2287	06C 109 244 D	0-N1053	06H 903 133 F	0-N2026	078 198 479	SK-1377
059 903 133 J	0-N2287S	06C 109 479 A	0-N1342	06H 903 133 F	0-N2026S	078 903 133 AB	0-N1083
059 903 341	0-N1315	06C 109 485 A	0-N1054	06H 903 133 G	0-N2026	078 903 133 AB	0-N1083S
059 903 341 A	0-N1431	06C 198 119	SK-1538	06H 903 133 G	0-N2026S	078 903 341 B	0-N2347
059 903 341 E	0-N1431	06C 198 119	SK-1601	06H 903 341 C	0-N2027	078 903 341 J	0-N1414
059 903 341 F	0-N1907	06C 903 133 A	0-N1537	06H 903 341 D	0-N2027	07C 145 276 D	0-N2346
059 903 341 G	0-N1795	06C 903 133 A	0-N1537S	06J 903 133 A	0-N1832	07D 145 276 A	0-N2127
059 903 341 H	0-N1795	06C 903 133 B	0-N1537	06J 903 133 A	0-N1832S	07D 145 276 B	0-N2127
059 903 341 J	0-N1431	06C 903 133 B	0-N1537S	074 109 243	0-N923	07D 145 276 C	0-N2127
068 109 243	0-N806	06C 903 133 C	0-N2407	074 109 243 A	0-N924	07K 145 172 B	0-N1892
068 109 243 C	0-N806	06C 903 133 C	0-N2407S	074 109 243 B	0-N921	07K 145 172 B	0-N1892S
068 109 243 F	0-N806	06D 109 243	0-N1340	074 109 243 F	0-N109	07K 145 172 C	0-N1893
069 109 243 B	0-N807	06D 109 243 C	0-N2208	074 109 243 G	0-N109	07K 145 172 C	0-N1893S
06A 109 181	0-N2234	06D 109 244 A	0-N1341	074 109 243 J	0-N109	1J0 145 276	0-N1454
06A 109 243 A	0-N2195	06D 109 244 B	0-N1341	074 109 243 R	0-N109	1J0 145 299	0-N1733
06A 109 479	0-N157	06D 109 244 C	0-N1346	077 109 244 C	0-N169	1J0 145 299	0-N1733S
06A 109 479 A	0-N157	06D 109 244 D	0-N1346	077 109 244 E	0-N1570	1L0 198 001	SK-1104
06A 109 479 B	0-N157	06D 109 244 E	0-N1346	077 109 244 F	0-N2134	1L0 198 002	SK-1069
06A 109 479 C	0-N157	06D 109 477 A	0-N1818	077 109 246 B	0-N2414	1L0 198 002 A	SK-1098
06A 198 119	SK-1109	06D 109 479 A	0-N1818	077 109 479 D	0-N1569	6K0 198 002	SK-1026
06A 198 119 A	SK-1337	06D 109 485 A	0-N1817	077 109 485 C	0-N1568	6K0 198 005	SK-1029
06A 198 119 B	SK-1660	06D 109 485 A	0-N1817S	077 109 485 E	0-N1568	6L0 198 002	SK-1069
06A 903 315 D	0-N1041	06E 903 133 A	0-N1830	077 109 485 F	0-N1568	6Q0 145 299	0-N1525
06A 903 315 D	0-N1041S	06E 903 133 A	0-N1830S	077 198 119 A	SK-1386	6Q0 145 299	0-N1525S
06A 903 315 E	0-N1041	06E 903 133 AB	0-N2289	077 903 133 C	0-N1889	6QD 145 276	0-N1454
06A 903 315 E	0-N1041S	06E 903 133 AB	0-N2289S	077 903 133 C	0-N1889S		
06A 903 315 F	0-N1041	06E 903 133 B	0-N1830	077 903 133 E	0-N1889		
06A 903 315 F	0-N1041S	06E 903 133 B	0-N1830S	077 903 133 E	0-N1889S		
06B 109 243	0-N1654	06E 903 133 E	0-N1830	077 903 133 F	0-N2137		
06B 109 243 A	0-N1042	06E 903 133 E	0-N1830S	077 903 133 F	0-N2137S		
06B 109 243 B	0-N1050	06E 903 133 H	0-N2289	077 903 133 G	0-N2137		
06B 109 243 D	0-N1042	06E 903 133 H	0-N2289S	077 903 133 G	0-N2137S		
06B 109 243 E	0-N1050	06E 903 133 L	0-N1830	077 903 341	0-N1632		
06B 109 243 F	0-N1042	06E 903 133 L	0-N1830S	077 903 427	0-N1967		
06B 109 244	0-N1316	06E 903 133 M	0-N2289	077 903 427 B	0-N1967		
06B 109 477	0-N1237	06E 903 133 M	0-N2289S	078 109 243 C	0-N940		
06B 109 477 A	0-N1051	06E 903 133 N	0-N1830	078 109 243 K	0-N160		
06B 109 477 A	0-N1051S	06E 903 133 N	0-N1830S	078 109 243 Q	0-N1238		
06B 109 479	0-N1237	06E 903 133 Q	0-N1830	078 109 243 R	0-N1238		
06B 198 119	SK-1660	06E 903 133 Q	0-N1830S	078 109 243 S	0-N1238		
06B 198 119 A	SK-1640	06E 903 133 R	0-N1830	078 109 244	0-N941		
06B 198 119 C	SK-1726	06E 903 133 R	0-N1830S	078 109 244 C	0-N941		
06B 903 133	0-N1671	06E 903 133 T	0-N1830	078 109 244 F	0-N941		
06B 903 133	0-N1671S	06E 903 133 T	0-N1830S	078 109 244 G	0-N2000		
06B 903 133 A	0-N1671	06E 903 341 A	0-N2199	078 109 244 H	0-N2001		
06B 903 133 A	0-N1671S	06E 903 341 E	0-N2351	078 109 244 J	0-N2001		
06B 903 133 E	0-N1671	06E 903 341 G	0-N2199	078 109 479 B	0-N1372		

BMW

0 946 004	0-N1786
1 247 051	0-N1758
1 247 052	0-N1511
1 272 424	0-N809
1 427 252	0-N1290
1 427 252	0-N1290S
1 433 502	0-N1669
1 433 502	0-N1669S
1 433 571	0-N1291
1 433 571	0-N1291S
1 435 594	0-N1292
1 440 237	0-N1922
1 440 378	0-N1505S
1 482 199	0-N1492
1 482 199	0-N1492S
1 704 718	0-N1741
1 704 718	0-N1741S
1 709 613	0-N1787
1 710 045	0-N1447S
1 711 153	0-N809
1 715 626	0-N2409

BMW		BMW		BMW		BMW	
1 715 630	0-N1295	11 28 1 433 502	0-N1669	11 28 1 745 551	0-N1295S	11 28 7 524 267	0-N1794S
1 715 630	0-N1295S	11 28 1 433 502	0-N1669S	11 28 1 747 461	0-N1585	11 28 7 530 314	0-N1788
1 717 387	0-N1559S	11 28 1 433 571	0-N1291	11 28 1 747 461	0-N1585S	11 28 7 530 314	0-N1788S
1 720 039	0-N1295	11 28 1 433 571	0-N1291S	11 28 1 748 130	0-N1298	11 28 7 534 398	0-N2055
1 720 039	0-N1295S	11 28 1 435 594	0-N1292	11 28 1 748 131	0-N1301	11 28 7 534 398	0-N2055S
1 721 245	SK-1059	11 28 1 440 237	0-N1922	11 28 1 748 832	0-N1290	11 28 7 534 400	0-N2264
1 721 844	0-N1927	11 28 1 440 378	0-N1505S	11 28 1 748 832	0-N1290S	11 28 7 535 860	0-N2128
1 722 789	0-N1919	11 28 1 702 013	0-N1585	11 28 2 243 510	0-N1303	11 28 7 549 557	0-N1922
1 722 789	0-N1919S	11 28 1 702 013	0-N1585S	11 28 2 243 592	0-N1304	11 28 7 549 588	0-N1507
1 722 789	0-N2135	11 28 1 704 500	0-N1586	11 28 2 244 424	0-N1303	11 28 7 549 588	0-N1507S
1 726 181	0-N1298	11 28 1 704 718	0-N1741	11 28 2 244 754	0-N1304	11 28 7 549 589	0-N1512
1 726 343	0-N1301	11 28 1 704 718	0-N1741S	11 28 2 245 087	0-N1306	11 28 7 549 589	0-N1512S
1 727 611	0-N955	11 28 1 709 613	0-N1787	11 28 2 245 166	0-N1305	11 28 7 549 590	0-N1668
1 730 571	0-N1298	11 28 1 710 045	0-N1447S	11 28 2 246 769	0-N1303	11 28 7 549 590	0-N1668S
1 731 220	0-N1296	11 28 1 715 626	0-N2409	11 28 2 247 226	0-N1932	11 28 7 556 251	0-N2130
1 734 745	0-N1511	11 28 1 715 630	0-N1295	11 28 2 247 435	0-N1396	11 28 7 557 851	0-N2129
1 735 899	0-N1290	11 28 1 715 630	0-N1295S	11 28 2 248 168	0-N1303	11 28 7 558 752	0-N2031
1 735 899	0-N1290S	11 28 1 717 188	0-N1293	11 28 2 248 169	0-N1932	11 28 7 558 752	0-N2031S
1 736 724	0-N2140	11 28 1 717 210	0-N1974	11 28 2 248 192	0-N1513	11 28 7 558 969	0-N2212
1 736 857	0-N2411	11 28 1 717 387	0-N1559S	11 28 2 248 192	0-N1513S	11 28 7 558 969	0-N2212S
1 736 979	0-N2411	11 28 1 720 039	0-N1295	11 28 2 248 483	0-N1834	11 28 7 563 927	0-N1621
1 738 061	0-N1298	11 28 1 720 039	0-N1295S	11 28 2 248 483	0-N1834S	11 28 7 563 927	0-N1621S
1 738 605	0-N1298	11 28 1 722 789	0-N1919	11 28 2 248 484	0-N1900	11 28 7 571 013	0-N2264
1 742 013	0-N1640	11 28 1 722 789	0-N1919S	11 28 2 354 130	0-N1900	11 28 7 571 014	0-N2263
1 742 013	0-N1640S	11 28 1 722 789	0-N2135	11 28 2 354 131	0-N1834	11 28 7 571 015	0-N2055
1 745 545	0-N2410	11 28 1 726 181	0-N1298	11 28 2 354 131	0-N1834S	11 28 7 571 015	0-N2055S
1 745 546	0-N1527	11 28 1 726 343	0-N1301	11 28 4 706 053	0-N2126	11 28 7 574 834	0-N1668
1 745 546	0-N1527S	11 28 1 730 571	0-N1298	11 28 4 719 859	0-N1944	11 28 7 574 834	0-N1668S
1 745 547	0-N1506	11 28 1 731 220	0-N1296	11 28 7 500 560	0-N1726	11 28 7 578 674	0-N2373
1 745 547	0-N1506S	11 28 1 731 838	0-N1297	11 28 7 503 424	0-N1669	11 28 7 578 675	0-N2372
1 745 550	0-N1741	11 28 1 734 745	0-N1511	11 28 7 503 424	0-N1669S	11 28 7 582 761	0-N2252
1 745 550	0-N1741S	11 28 1 735 899	0-N1290	11 28 7 505 566	0-N1512	11 28 7 582 761	0-N2252S
1 745 551	0-N1295	11 28 1 735 899	0-N1290S	11 28 7 505 566	0-N1512S	11 28 7 582 766	0-N2278
1 745 551	0-N1295S	11 28 1 736 724	0-N2140	11 28 7 505 567	0-N1668	11 28 7 589 361	0-N2370
1 748 130	0-N1298	11 28 1 736 857	0-N2411	11 28 7 505 567	0-N1668S	11 28 7 589 886	0-N2371
1 748 131	0-N1301	11 28 1 736 979	0-N2411	11 28 7 509 476	0-N2124	11 28 7 598 831	0-N2264
1 748 832	0-N1290	11 28 1 738 061	0-N1298	11 28 7 509 476	0-N2124S	11 28 7 598 832	0-N2264
1 748 832	0-N1290S	11 28 1 738 605	0-N1298	11 28 7 509 508	0-N1638	11 28 7 598 833	0-N2263
11 13 1 708 806	0-N867	11 28 1 742 013	0-N1640	11 28 7 511 474	0-N2076	11 28 7 603 347	0-N2215
11 13 1 709 646	0-N867	11 28 1 742 013	0-N1640S	11 28 7 511 474	0-N2076S	11 28 7 603 347	0-N2215S
11 13 1 721 245	0-N954	11 28 1 742 858	0-N1299	11 28 7 512 758	0-N1791	11 28 7 615 130	0-N2371
11 13 1 721 264	0-N866	11 28 1 742 858	0-N1299S	11 28 7 512 758	0-N1791S	11 28 7 780 124	0-N1792
11 13 1 727 141	0-N866	11 28 1 742 859	0-N1300	11 28 7 515 280	0-N1668	11 28 7 786 880	0-N1790
11 28 0 946 004	0-N1786	11 28 1 742 859	0-N1300S	11 28 7 515 280	0-N1668S	11 28 7 786 881	0-N1523
11 28 1 247 051	0-N1758	11 28 1 745 545	0-N2410	11 28 7 515 865	0-N1669	11 28 7 789 020	0-N1516
11 28 1 247 052	0-N1511	11 28 1 745 546	0-N1527	11 28 7 515 865	0-N1669S	11 28 7 789 020	0-N1516S
11 28 1 247 647	0-N1294	11 28 1 745 546	0-N1527S	11 28 7 515 866	0-N1508	11 28 7 790 447	0-N1793
11 28 1 247 647	0-N1294S	11 28 1 745 547	0-N1506	11 28 7 515 866	0-N1508S	11 28 7 790 447	0-N1793S
11 28 1 427 252	0-N1290	11 28 1 745 547	0-N1506S	11 28 7 516 847	0-N1453	11 28 7 790 448	0-N1871
11 28 1 427 252	0-N1290S	11 28 1 745 550	0-N1741	11 28 7 516 897	0-N1794	11 28 7 795 037	0-N1339
11 28 1 432 104	0-N1294	11 28 1 745 550	0-N1741S	11 28 7 516 897	0-N1794S	11 28 7 795 037	0-N1339S
11 28 1 432 104	0-N1294S	11 28 1 745 551	0-N1295	11 28 7 524 267	0-N1794	11 28 7 799 464	0-N1792



BMW		BMW		BMW		BMW	
11 28 7 799 851	0-N2082	2 248 168	0-N1303	7 500 560	0-N1726	7 589 886	0-N2371
11 28 7 799 851	0-N2082S	2 248 169	0-N1932	7 503 424	0-N1669	7 598 831	0-N2264
11 28 7 799 859	0-N2125	2 248 191	0-N1513	7 503 424	0-N1669S	7 598 832	0-N2264
11 28 7 800 333	0-N1958	2 248 191	0-N1513S	7 505 566	0-N1512	7 598 833	0-N2263
11 28 7 800 333	0-N1958S	2 248 192	0-N1513	7 505 566	0-N1512S	7 603 347	0-N2215
11 28 7 800 334	0-N2084	2 248 192	0-N1513S	7 505 567	0-N1668	7 603 347	0-N2215S
11 28 7 800 334	0-N2084S	2 248 194	0-N1513	7 505 567	0-N1668S	7 615 130	0-N2371
11 28 7 800 562	0-N1950	2 248 194	0-N1513S	7 509 476	0-N2124	7 621 021	SK-1060
11 28 7 802 146	0-N1944	2 248 483	0-N1834	7 509 476	0-N2124S	7 624 063	SK-1059
11 28 7 806 252	0-N1516	2 248 483	0-N1834S	7 509 508	0-N1638	7 786 545	0-N1524
11 28 7 806 252	0-N1516S	2 248 484	0-N1900	7 511 474	0-N2076	7 786 706	0-N2074
11 28 7 807 021	0-N1523	2 248 563	0-N1940	7 511 474	0-N2076S	7 786 706	0-N2074S
11 28 7 810 807	0-N2216	2 248 563	0-N1940S	7 512 758	0-N1791	7 786 711	0-N2075
11 28 7 810 807	0-N2216S1	2 354 034	0-N1940	7 512 758	0-N1791S	7 786 881	0-N1523
11 28 7 810 807	0-N2216S2	2 354 034	0-N1940S	7 515 280	0-N1668	7 787 371	0-N1961
11 28 7 823 199	0-N2217	2 354 130	0-N1900	7 515 280	0-N1668S	7 787 375	0-N2072
11 28 7 823 199	0-N2217S1	2 354 131	0-N1834	7 515 865	0-N1669	7 789 019	0-N1515
11 28 7 823 199	0-N2217S2	2 354 131	0-N1834S	7 515 865	0-N1669S	7 789 019	0-N1515S
11 28 7 823 374	0-N2387	4 706 053	0-N2126	7 515 866	0-N1508	7 789 020	0-N1516
11 28 7 823 374	0-N2387S	4 719 859	0-N1944	7 515 866	0-N1508S	7 789 020	0-N1516S
11 28 7 823 380	0-N2369	64 55 1 721 844	0-N1927	7 516 847	0-N1453	7 790 447	0-N1793
11 28 7 838 797	0-N1919	64 55 1 726 699	0-N1306	7 530 314	0-N1788	7 790 447	0-N1793S
11 28 7 838 797	0-N1919S	64 55 2 244 172	0-N1306	7 530 314	0-N1788S	7 790 448	0-N1871
11 28 7 838 797	0-N2135	64 55 2 244 173	0-N1306	7 534 398	0-N2055	7 795 037	0-N1339
11 28 7 841 228	0-N1298	64 55 2 245 584	0-N1514	7 534 398	0-N2055S	7 795 037	0-N1339S
11 28 8 604 267	0-N2370	64 55 2 245 584	0-N1514S	7 534 400	0-N2264	7 799 851	0-N2082
11 28 8 620 023	0-N2278	64 55 2 248 191	0-N1513	7 535 860	0-N2128	7 799 851	0-N2082S
11 28 8 620 210	0-N2124	64 55 2 248 191	0-N1513S	7 549 557	0-N1922	7 799 859	0-N2125
11 28 8 620 210	0-N2124S	64 55 2 248 194	0-N1513	7 549 589	0-N1512	7 800 333	0-N1958
11 28 8 624 196	0-N1788	64 55 2 248 194	0-N1513S	7 549 589	0-N1512S	7 800 333	0-N1958S
11 28 8 624 196	0-N1788S	64 55 2 248 563	0-N1940	7 549 590	0-N1668	7 800 334	0-N2084
11 28 8 625 983	0-N1786	64 55 2 248 563	0-N1940S	7 549 590	0-N1668S	7 800 334	0-N2084S
11 31 1 272 424	0-N809	64 55 2 354 034	0-N1940	7 556 251	0-N2130	7 800 562	0-N1950
11 31 1 279 241	0-N925	64 55 2 354 034	0-N1940S	7 557 851	0-N2129	7 802 146	0-N1944
11 31 1 711 153	0-N809	64 55 2 354 036	0-N1913	7 558 752	0-N2031	7 805 960	0-N1062
11 31 1 721 245	SK-1059	64 55 2 354 036	0-N1913S	7 558 752	0-N2031S	7 806 252	0-N1516
11 31 1 721 844	0-N1927	64 55 2 354 037	0-N1923	7 558 969	0-N2212	7 806 252	0-N1516S
11 31 1 727 611	0-N955	64 55 7 786 076	0-N1923	7 558 969	0-N2212S	7 806 253	0-N1515
11 31 2 241 090	0-N925	64 55 7 786 287	0-N1912	7 563 927	0-N1621	7 806 253	0-N1515S
11 31 7 621 021	SK-1060	64 55 7 786 287	0-N1912S	7 563 927	0-N1621S	7 807 021	0-N1523
11 31 7 624 063	SK-1059	64 55 7 786 545	0-N1524	7 571 013	0-N2264	7 810 807	0-N2216
11 31 7 805 960	0-N1062	64 55 7 786 706	0-N2074	7 571 014	0-N2263	7 810 807	0-N2216S1
11 31 7 805 961	0-N1066	64 55 7 786 706	0-N2074S	7 571 015	0-N2055	7 810 807	0-N2216S2
1128 1 482 199	0-N1492	64 55 7 786 711	0-N2075	7 571 015	0-N2055S	7 823 199	0-N2217
1128 1 482 199	0-N1492S	64 55 7 787 371	0-N1961	7 574 834	0-N1668	7 823 199	0-N2217S1
2 243 510	0-N1303	64 55 7 787 375	0-N2072	7 574 834	0-N1668S	7 823 199	0-N2217S2
2 244 424	0-N1303	64 55 7 788 684	0-N1912	7 578 674	0-N2373	7 823 374	0-N2387
2 245 584	0-N1514	64 55 7 788 684	0-N1912S	7 578 675	0-N2372	7 823 374	0-N2387S
2 245 584	0-N1514S	64 55 7 789 019	0-N1515	7 582 761	0-N2252	7 823 380	0-N2369
2 246 769	0-N1303	64 55 7 789 019	0-N1515S	7 582 761	0-N2252S	7 838 797	0-N1919
2 247 226	0-N1932	64 55 7 806 253	0-N1515	7 582 766	0-N2278	7 838 797	0-N1919S
2 247 435	0-N1396	64 55 7 806 253	0-N1515S	7 589 361	0-N2370	7 838 797	0-N2135

BMW

7 841 228	0-N1298
8 604 267	0-N2370
8 620 023	0-N2278
8 620 210	0-N2124
8 620 210	0-N2124S
8 624 196	0-N1788
8 624 196	0-N1788S
8 625 983	0-N1786

BUICK

12605175	0-N2299
12605175	0-N2299S
12605492	0-N2283

CADILLAC

12568172	0-N1685
----------	---------

CHERY

481H1007070	0-N1683
-------------	---------

CHEVROLET

06004123	0-N1849S
06004127	0-N1849S
10118723	0-N1646
10229114	0-N1849S
10239670	0-N1697
10239670	0-N1697S
1029558	0-N1684
12456152	0-N1697
12456152	0-N1697S
12554027	0-N1846
12554027	0-N1846S
12555424	0-N1689
12557554	0-N1696
12561094	0-N1697
12561094	0-N1697S
12570827	0-N1691
12580162	0-N1846
12580162	0-N1846S
12580296	0-N1697
12580296	0-N1697S
12605175	0-N2299
12605175	0-N2299S
12609719	0-N1846
12609719	0-N1846S
24504828	0-N1688
24507684	0-N1690
24576073	0-N1692
25180907	0-N1646
25183772	0-N970
25184786	0-N1532
25184786	0-N1532S
25188374	0-N2097
53008642	0-N1685
532026620	0-N1686
55565572	0-N2341

CHEVROLET

55568403	0-N2341
8245760730	0-N1692
96183113	0-N1646
96208428	0-N2097
96351533	0-N1532
96351533	0-N1532S
96413863	0-N953
96413864	0-N300
96416331	0-N2274
96966707	0-N1532
96966707	0-N1532S

CHRYSLER

0 4483 214	0-N1698
0 4483 214	0-N1698S
0 4573 348	0-N2327
0 4612 894	0-N1698
0 4612 894	0-N1698S
0 4612 894AB	0-N1698
0 4612 894AB	0-N1698S
0 4612 894AC	0-N1698
0 4612 894AC	0-N1698S
0 4612 894AG	0-N1698
0 4612 894AG	0-N1698S
0 4627 039AA	0-N2048
0 4663 515	0-N2327
0 4720 714	0-N2157
0 4792 410AB	0-N2233
0 4792 410AC	0-N2233
0 4792 410AD	0-N2233
0 4792 495AB	0-N1509
0 4792 495AB	0-N1509S
0 4792 495AC	0-N1509
0 4792 495AC	0-N1509S
0 4792 836AA	0-N1431
0 4861 277AB	0-N2406
0 4861 277AB	0-N2406S
0 4861 277AD	0-N2406
0 4861 277AD	0-N2406S
0 4861 630AA	0-N2203
0 4861 630AA	0-N2203S
0 4861 630AB	0-N2203
0 4861 630AB	0-N2203S
0 4891 595AA	0-N2112
0 4891 595AA	0-N2112S
0 4891 595AB	0-N2112
0 4891 595AB	0-N2112S
0 4891 595AC	0-N2112
0 4891 595AC	0-N2112S
0 4891 595AE	0-N2112
0 4891 595AE	0-N2112S
0 4891 596AB	0-N2048
0 4891 596AC	0-N2048

CHRYSLER

0 4891 617AA	0-N2232
0 4891 617AA	0-N2232S
0 4891 660AA	0-N2364
0 4891 797AA	0-N2048
0 4891 797AB	0-N2048
0 5066 827AA	0-N1411
0 5066 936AA	0-N2151
0 5066 936AA	0-N2151S
0 5093 931AA	0-N1411
0 5096 525AA	0-N1645
0 5096 525AA	0-N1645S
0 5098 431AA	0-N2142
0 5142 573AA	0-N1411
0 5175 589AA	0-N1560
04536154	0-N1699
04536154	0-N1699S
04536154AB	0-N1699
04536154AB	0-N1699S
04627094AA	0-N2049
04663515AB	0-N2327
04663515AC	0-N2327
04668509AB	0-N1555
04668509AB	0-N1555S
04668509AC	0-N1555
04668509AC	0-N1555S
04668509AD	0-N1555
04668509AD	0-N1555S
04777375AB	0-N1835
04777375AC	0-N1835
04777383AC	0-N1835
04777393AB	0-N1835
04777394	0-N1835
04781570AB	0-N1838S
04861633AA	0-N1423
04862624AA	0-N1670
04862624AA	0-N1670S
04863737	0-N1546
04884320AA	0-N1836
05010371AA	0-N2059
05018400AA	0-N1835
05018400AB	0-N1835
05066938AA	0-N1423
05072440AB	0-N2261
05072440AB	0-N2261S
05080319AA	0-N1680
05083726AB	0-N1962
05142798AA	0-N1612
1536154AD	0-N1699
1536154AD	0-N1699S
30602001F	0-N2256
3561201810F	0-N2151
3561201810F	0-N2151S

CHRYSLER

35612022F	0-N2261
35612022F	0-N2261S
35612027H	0-N2329
3830196	0-N1693
4483214	0-N1698
4483214	0-N1698S
4483221	0-N1695
4536154	0-N1699
4536154	0-N1699S
4536154AB	0-N1699
4536154AB	0-N1699S
4556027	0-N1699
4556027	0-N1699S
4612894AB	0-N1698
4612894AB	0-N1698S
4612894AC	0-N1698
4612894AC	0-N1698S
4627 039AA	0-N2048
4781569AA	0-N1962
4781569AB	0-N1962
4792 410AB	0-N2233
4792 410AC	0-N2233
4792 410AD	0-N2233
4792835AA	0-N1686
4861277AB	0-N2406
4861277AB	0-N2406S
4884 320AA	0-N1836
4891 596AB	0-N2048
4891 596AC	0-N2048
4891 797AA	0-N2048
4891 797AB	0-N2048
4891617AA	0-N2232
4891617AA	0-N2232S
4891659AA	0-N2397
4891659AA	0-N2397S
4897054AA	0-N2059
4897578AA	0-N1962
5003284AA	0-N1962
5010371AA	0-N2059
5010372AA	0-N1962
5066 936AA	0-N2151
5066 936AA	0-N2151S
5066826AA	0-N1612
5072440AB	0-N2261
5072440AB	0-N2261S
5083726AA	0-N1962
5083726AB	0-N1962
53030958AC	0-N2257
53030958AC	0-N2257S1
53030958AC	0-N2257S2
6 8018 072AA	0-N1560
68020886AA	0-N1670



CHRYSLER

68020886AA	0-N1670S
68027611AA	0-N2329
68027611AB	0-N2329
68027647AA	0-N2238
68027648AA	0-N2205
68031478AA	SK-1734
68040206AA	0-N1902
68040206AA	0-N1902S
68045800AA	0-N2257
68045800AA	0-N2257S1
68045800AA	0-N2257S2
K 5096 525AA	0-N1645
K 5096 525AA	0-N1645S
K 5098 431AA	0-N2142
K05072440SB	0-N2261
K05072440SB	0-N2261S
K68018072AA	0-N1560
M D140 071	0-N185
M D319 022	0-N189
MD030605	0-N986
MD182537	0-N060

CITROËN

00 001 281 19	0-N1973
0513.61	0-N1222
0807.12	0-N835
0818.17	0-N815
0818.19	0-N871
0818.20	0-N944
0818.21	0-N822
0818.23	0-N816
0818.24	0-N821
0818.32	0-N816
0818.38	0-N1714
0818.38	0-N1714S
0820.53	0-N811
0823.08	0-N1056
0823.09	0-N1056
0823.10	0-N1056
0829.10	0-N882
0829.11	0-N813
0829.12	0-N812
0829.17	0-N822
0829.19	0-N811
0829.20	0-N869
0829.21	0-N813
0829.22	0-N870
0829.29	0-N811
0829.30	0-N861
0829.31	0-N911
0829.32	0-N943
0829.33	0-N901
0829.35	0-N943

CITROËN

0829.44	0-N811
0829.45	0-N861
0829.46	0-N911
0829.49	0-N121
0829.52	0-N214
0829.54	0-N811
0829.59	0-N118P
0829.60	0-N118P
0829.61	0-N118P
0829.62	0-N118P
0829.63	0-N118P
0829.66	0-N1057
0829.67	0-N1057
0829.69	0-N1058
0829.74	0-N214
0829.76	0-N1057
0829.77	0-N1057
0829.78	0-N1058
0829.79	0-N1058
0829.80	0-N1060
0829.82	0-N1061
0829.84	0-N1356
0829.88	0-N1062
0829.89	0-N1062
0829.90	0-N1277
0829.92	0-N1057
0829.93	0-N1057
0829.96	0-N1057
0829.98	0-N1060
0829.A0	0-N1359
0829.A1	0-N1360
0829.A3	0-N1327
0829.A4	0-N1327
0829.A5	0-N1338
0829.A7	0-N1057
0829.A9	0-N1343
0829.C0	0-N1613
0829.C3	0-N1357
0829.C4	0-N1358
0829.C5	0-N1056
0829.C6	0-N1338
0829.C7	0-N1061
0829.C8	0-N1359
0829.E8	0-N2018
0829.F5	0-N2018
0829.F8	0-N2224
0829.F9	0-N1614
0830.02	0-N814
0830.11	0-N862
0830.12	0-N945
0830.13	0-N900
0830.14	0-N862

CITROËN

0830.16	0-N862
0830.20	0-N122
0830.23	0-N215
0830.24	0-N170
0830.25	0-N171
0830.26	0-N170
0830.27	0-N171
0830.28	0-N119P
0830.29	0-N119P
0830.30	0-N119P
0830.31	0-N119P
0830.32	0-N821
0830.36	0-N862
0830.37	0-N862
0830.40	0-N816
0830.42	0-N1065
0830.44	0-N215
0830.46	0-N1381
0830.48	0-N1066
0830.49	0-N1066
0830.50	0-N1334
0830.52	0-N1456
0830.53	0-N170
0830.54	0-N171
0830.58	0-N170
0830.59	0-N171
0830.60	0-N1456
0830.61	0-N122
0830.62	0-N1360
0830.63	0-N1381
0830.75	0-N2382
0831.01	SK-1018S
0831.02	SK-1003
0831.03	SK-1004
0831.04	SK-1005
0831.05	SK-1006
0831.06	SK-1019
0831.07	SK-1157
0831.08	SK-1159
0831.09	SK-1007
0831.11	SK-1017
0831.13	SK-1003
0831.14	SK-1004
0831.16	SK-1006
0831.17	SK-1019
0831.20	SK-1007
0831.21	SK-1016
0831.22	SK-1017
0831.24	SK-1020
0831.25	SK-1158
0831.27	SK-1022
0831.28	SK-1020

CITROËN

0831.29	SK-1158
0831.30	SK-1040
0831.31	SK-1022
0831.32	SK-1399
0831.33	SK-1399
0831.34	SK-1079
0831.35	SK-1079
0831.36	SK-1034
0831.37	SK-1034
0831.40	SK-1085
0831.41	SK-1085
0831.44	SK-1005
0831.45	SK-1005
0831.46	SK-1040
0831.47	SK-1040
0831.48	SK-1399
0831.49	SK-1082
0831.50	SK-1016
0831.51	SK-1016
0831.52	SK-1017
0831.53	SK-1017
0831.55	SK-1482
0831.56	SK-1399
0831.57	SK-1399
0831.58	SK-1086
0831.59	SK-1086
0831.61	SK-1394
0831.62	SK-1085
0831.64	SK-1087
0831.65	SK-1482
0831.66	SK-1482
0831.67	SK-1399
0831.68	SK-1399
0831.70	SK-1393
0831.72	SK-1613
0831.73	SK-1534
0831.74	SK-1534
0831.77	SK-1642
0831.78	SK-1085
0831.79	SK-1085
0831.80	SK-1391
0831.81	SK-1391
0831.82	SK-1085
0831.83	SK-1085
0831.84	SK-1353
0831.85	SK-1353
0831.86	SK-1354
0831.87	SK-1354
0831.88	SK-1482
0831.89	SK-1482
0831.90	SK-1609
0831.91	SK-1609

CITROËN		CITROËN		CITROËN		CITROËN	
0831.92	SK-1594	0831.V3	SK-1085	5751.30	0-N1472	5751.92	0-N1421
0831.K0	SK-1594	0831.V4	SK-1424	5751.30	0-N1472S	5751.94	0-N1945
0831.K1	SK-1600	0831.V5	SK-1692	5751.31	0-N1747	5751.94	0-N1945S
0831.K2	SK-1596	0831.V6	SK-1600	5751.32	0-N1713	5751.95	0-N1421
0831.K3	SK-1600	0831.W1	SK-1714	5751.33	0-N1722	5751.96	0-N151
0831.K5	SK-1616	0831.W2	SK-1728	5751.34	0-N1463S	5751.97	0-N1620
0831.K6	SK-1614	0831.W3	SK-1732	5751.35	0-N1484	5751.97	0-N1620S
0831.K7	SK-1614	1204 53	0-N2263	5751.35	0-N1484S	5751.98	0-N1419
0831.K9	SK-1617	1281.18	0-N2348	5751.36	0-N1402	5751.A1	0-N2094
0831.L2	SK-1615	1281.19	0-N1973	5751.36	0-N1402S	5751.A2	0-N1620
0831.L3	SK-1615	1281.34	0-N1749	5751.37	0-N1465S	5751.A2	0-N1620S
0831.L4	SK-1598	1281.34	0-N1749S	5751.38	0-N931	5751.A7	0-N2037
0831.L5	SK-1598	1281.35	0-N2154	5751.40	0-N2175	5751.A7	0-N2037S
0831.L6	SK-1392	1281.38	0-N1750	5751.41	0-N1757	5751.A8	0-N1803
0831.L7	SK-1392	1281.39	0-N2348	5751.43	0-N1747	5751.A9	0-N1473
0831.L9	SK-1483	16 080 248 80	0-N1460	5751.44	0-N1747	5751.A9	0-N1473S
0831.N1	SK-1588	16 114 234 80	0-N1460	5751.45	0-N1681	5751.C3	0-N1673
0831.N1	SK-1692	1607664380	0-N2354	5751.46	0-N1545	5751.C3	0-N1673S
0831.N2	SK-1086	1608747480	SK-1728	5751.50	0-N1949	5751.C8	0-N1620
0831.N3	SK-1086	1608887680	0-N2424	5751.51	0-N1446	5751.C8	0-N1620S
0831.N4	SK-1085	16091201	SK-1085AQ1	5751.52	0-N1486	5751.C9	0-N1419
0831.N5	SK-1085	1609120180	SK-1085AQ1	5751.52	0-N1486S	5751.E0	0-N2095
0831.P1	SK-1424	16095246	SK-1085AQ1	5751.53	0-N1968	5751.E0	0-N2095S
0831.P2	SK-1424	1609524680	SK-1085AQ1	5751.54	0-N1747	5751.E1	0-N2095
0831.P4	SK-1424	16095247	SK-1085AQ1	5751.55	0-N1493	5751.E1	0-N2095S
0831.P6	SK-1692	1609524780	SK-1085AQ1	5751.55	0-N1493S	5751.E1	0-N2095S1
0831.P8	SK-1615	16095255	SK-1600AQ1	5751.56	0-N1748	5751.E7	0-N2055
0831.Q0	SK-1714	1609525580	SK-1600AQ1	5751.57	0-N151	5751.E7	0-N2055S
0831.Q1	SK-1728	16095256	SK-1424AQ1	5751.60	0-N1416	5751.E8	0-N2191
0831.Q3	SK-1003	1609525680	SK-1424AQ1	5751.61	0-N1391	5751.E9	0-N1874
0831.Q4	SK-1004	1609958780	0-N2294	5751.61	0-N1391S	5751.E9	0-N1874S
0831.Q5	SK-1020	1628.WA	0-N1651	5751.62	0-N1545	5751.F0	0-N1460
0831.Q8	SK-1007	1628.WA	0-N1651S	5751.63	0-N1545	5751.F1	0-N1392
0831.R1	SK-1019	1926.67	0-N1614	5751.67	0-N1545	5751.F3	0-N1808
0831.R3	SK-1040	26 207 509	0-N822	5751.72	0-N1545	5751.F3	0-N1808S
0831.R4	SK-1022	4007.E4	0-N095	5751.73	0-N1309	5751.F4	0-N1807
0831.R5	SK-1082	5703.38	0-N2349	5751.74	0-N1471	5751.F6	0-N2046
0831.R6	SK-1034	5751 E4	0-N2276	5751.74	0-N1471S	5751.F6	0-N2046S
0831.R7	SK-1086	5751.08	0-N2349	5751.75	0-N1449	5751.F7	0-N2019
0831.R8	SK-1085	5751.11	0-N2349	5751.76	0-N1413	5751.G0	0-N2116
0831.R9	SK-1615	5751.12	0-N2152	5751.77	0-N1473	5751.G0	0-N2116S
0831.S0	SK-1354	5751.14	0-N2349	5751.77	0-N1473S	5751.G1	0-N2019
0831.S1	SK-1353	5751.18	0-N124	5751.81	0-N1747	5751.G2	0-N2115
0831.S2	SK-1534	5751.19	0-N1484	5751.85	0-N1624	5751.G2	0-N2115S
0831.S3	SK-1614	5751.19	0-N1484S	5751.85	0-N1624S	5751.G3	0-N1419
0831.T3	SK-1391	5751.20	0-N1405	5751.86	0-N1339	5751.G4	0-N2048
0831.T4	SK-1482	5751.21	0-N2153	5751.86	0-N1339S	5751.G7	0-N1673
0831.T5	SK-1594	5751.23	0-N1756	5751.87	0-N1418	5751.G7	0-N1673S
0831.T8	SK-1617	5751.24	0-N1751	5751.89	0-N1636	5751.G9	0-N2055
0831.V0	SK-1598	5751.26	0-N133	5751.89	0-N1636S	5751.G9	0-N2055S
0831.V1	SK-1392	5751.27	0-N2015	5751.90	0-N1420	5751.H2	0-N2095
0831.V2	SK-1483	5751.29	0-N1320	5751.91	0-N1455	5751.H2	0-N2095S



CITROËN		CITROËN		CITROËN		CITROËN	
5751.H3	0-N2268	96 097 691	0-N1222	96 367 827	0-N1471	96 552 535 80	0-N1358
5751.H3	0-N2268S	96 098 279	0-N944	96 367 827	0-N1471S	96 552 536 80	0-N1357
5751.H7	0-N2112	96 099 089	0-N862	96 370 580	0-N1058	96 553 210 80	0-N1636
5751.H7	0-N2112S	96 112 753	0-N2349	96 374 926	0-N1061	96 553 210 80	0-N1636S
5751.H8	0-N2268	96 117 885	0-N2153	96 374 926 80	0-N1061	96 554 874 80	0-N1419
5751.H8	0-N2268S	96 137 001	0-N911	96 378 749	0-N1057	96 616 797 80	0-N2115
5751.J1	0-N2112	96 146 660	0-N2349	96 378 771 80	0-N1356	96 616 797 80	0-N2115S
5751.J1	0-N2112S	96 151 754	0-N1749	96 381 153 80	0-N118P	96 654 092	0-N871
5751.J5	0-N2392	96 151 754	0-N1749S	96 383 807 80	0-N1636	96 705 687 80	0-N2224
5751.J5	0-N2392S	96 155 001	0-N095	96 383 807 80	0-N1636S	96 725 750 80	0-N2224
5751.J9	0-N2390	96 156 400	0-N133	96 398 222	0-N1057	96 726 237 80	0-N2224
5751.J9	0-N2390S	96 159 233	0-N900	96 399 167	0-N1624	96 735 280 80	0-N2382
5751.K4	0-N2392	96 171 886	0-N901	96 399 167	0-N1624S	96 735 691 80	0-N2224
5751.K4	0-N2392S	96 178 009 80	0-N122	96 400 532	0-N1339	96 768 548 80	0-N2392
6453.76	0-N849	96 188 885	0-N1320	96 400 532	0-N1339S	96 768 548 80	0-N2392S
6453.AN	0-N1904	96 199 932	0-N1756	96 400 532 80	0-N1339	96 783 252 80	0-N1460
6453.AN	0-N1975	96 201 309	0-N862	96 400 532 80	0-N1339S	96 832 734 80	0-N2018
6453.C6	0-N1682	96 214 145	0-N1402	96 403 456	0-N1057	96 854 868 80	0-N1673
6453.CE	0-N1386	96 214 145	0-N1402S	96 408 284 80	0-N1327	96 854 868 80	0-N1673S
6453.FL	0-N1386	96 215 446	0-N2174	96 410 042	0-N1420	96 877 225 80	0-N2224
6453.KH	0-N1387	96 216 260	0-N1446	96 413 140	0-N1062	96201545	0-N1751
6453.NN	0-N1589	96 218 349	0-N1486	96 413 173 80	0-N1651	965206680	0-N1357
6453.R8	0-N1899	96 218 349	0-N1486S	96 413 173 80	0-N1651S	97 522 886	0-N811
6453.S3	0-N2173	96 225 744	0-N943	96 415 393	0-N1066	97 535 002	0-N811
6453.S4	0-N125	96 230 012	0-N1472	96 420 067 80	0-N1455	DACIA	
6453.S4	0-N125S	96 230 012	0-N1472S	96 426 581 80	0-N1419	11 92 330 42R	0-N2275
6453.S5	0-N125	96 236 000	0-N1747	96 429 298	0-N1277	13 07 080 47R	0-N2423
6453.S5	0-N125S	96 236 598	0-N1747	96 429 657	0-N151	13 07 085 46R	0-N2423
6453.SG	0-N1711S	96 256 217	0-N1713	96 433 296	0-N1057	13 07 756 30R	0-N2380
6453.SQ	0-N1387	96 256 218	0-N1722	96 447 595	0-N1421	13 0C 104 74R	SK-1730
6453.Y1	0-N2174	96 263 652	0-N1484	96 447 885	0-N1421	13 0C 153 39R	SK-1730
6453.Y3	0-N2172	96 263 652	0-N1484S	96 452 098 80	0-N1338	13 0C 174 80R	SK-1704
6453.Y3	0-N2172S	96 289 491	0-N2175	96 459 251 80	0-N1060	77 00 107 150	0-N262
6453.Y4	0-N1959	96 296 777	0-N118P	96 463 960 80	0-N1419	77 01 472 725	SK-1338
6454.S3	0-N2173	96 318 474	0-N1413	96 464 958 80	0-N1589	77 01 476 571	SK-1487
6455.B3	0-N2337	96 321 551	0-N1747	96 484 732 80	0-N1360	77 01 476 745	SK-1486
91 508 298	0-N812	96 327 221	0-N1065	96 487 043 80	0-N1359	77 01 477 014	SK-1088
91 538 722	0-N869	96 332 546	0-N1750	96 496 758 80	0-N1620	77 01 477 024	SK-1338
93 501 404	0-N813	96 333 151	0-N1748	96 496 758 80	0-N1620S	77 01 477 028	SK-1487
93 501 405	0-N814	96 333 152	0-N151	96 510 197 80	0-N1473	82 00 211 784	0-N145
93 510 847	0-N1682	96 340 878 80	0-N122	96 510 197 80	0-N1473S	82 00 598 966	0-N2275
95 006 057	0-N2152	96 344 657	0-N1493	96 510 815 80	0-N1803	82 00 908 180	0-N2062
95 495 830	0-N815	96 344 657	0-N1493S	96 520 466 80	0-N1620	82 00 933 753	0-N2265
95 577 787	0-N1320	96 345 720	0-N2175	96 520 466 80	0-N1620S	82 00 933 753	0-N2265S
95 619 217	0-N822	96 345 720 80	0-N2175	96 520 666 80	0-N1357	DAEWOO	
95 640 195	0-N861	96 353 368	0-N1058	96 520 736 80	0-N1673	1281081400000	0-N973
96 010 657	0-N870	96 354 380 80	0-N1060	96 520 736 80	0-N1673S	1281081401000	0-N973
96 036 288	0-N1973	96 359 666	0-N1473	96 521 487 80	0-N1358	1281081402000	0-N973
96 052 662	0-N811	96 359 666	0-N1473S	96 527 717 80	0-N1338	25188374	0-N2097
96 056 183	0-N871	96 363 551	0-N1493	96 531 371 80	0-N1343	5094008601	0-N970
96 076 190	0-N2348	96 363 551	0-N1493S	96 541 273 8	0-N1808	90353176	0-N948
96 094 102	0-N945	96 366 405	0-N1416	96 541 273 8	0-N1808S	90499401	0-N948

DAEWOO		DODGE		FIAT		FIAT	
9128738	0-N906	0 4792 410AD	0-N2233	46442999	0-N1407S	5175 8384	0-N1667
9157004	0-N100	0 4891 617AA	0-N2232	46454419	0-N1415	51758383	0-N1522
91580003	0-N101	0 4891 617AA	0-N2232S	46460702	0-N1490S	51758385	0-N1503
93202400	0-N974	04781569AB	0-N1962	46469587	0-N1894	51758385	0-N1503S
96103222	0-N971	04781570AB	0-N1838S	46514222	0-N1415	51761865	0-N1805
96183115	0-N1532	04884320AA	0-N1836	46524692	0-N1407	51761865	0-N1805S
96183115	0-N1532S	35612027H	0-N2329	46524692	0-N1407S	51773551	0-N1503
96208428	0-N2097	4483214	0-N1698	46537101	0-N1450	51773551	0-N1503S
96349976	0-N1532	4483214	0-N1698S	46546374	0-N1487	51776566	0-N1522
96349976	0-N1532S	4781569AA	0-N1962	46546374	0-N1487S	51800046	0-N2122
96350526	0-N971	4792 410AB	0-N2233	46547564	0-N1596	51815020	0-N2049
96350550	0-N970	4792 410AC	0-N2233	46548452	0-N1517	51817373	0-N1805
96435138	0-N1422	4792 410AD	0-N2233	46548452	0-N1517S	51817373	0-N1805S
96435138	0-N1422S	4861277AB	0-N2406	46554826	0-N951	51821652	0-N1478S
96459042	0-N1422	4861277AB	0-N2406S	46557128	0-N1720	51821653	0-N1526
96459042	0-N1422S	4891617AA	0-N2232	46557128	0-N1720S	51821653	0-N1526S
D96103222	0-N971	4891617AA	0-N2232S	46557129	0-N1627	51837961	0-N2390
D96350526	0-N971	4891659AA	0-N2397	46557129	0-N1627S	51837961	0-N2390S
DAIHATSU		4891659AA	0-N2397S	46736886	0-N1841	55180011	0-N1487
13503-87701	0-N041	4897054AA	0-N2059	46740729	0-N1634	55180011	0-N1487S
13503-87701-000	0-N041	4897578AA	0-N1962	46742968	0-N1398	55181878	0-N1842
13504-87701	0-N040	5010371AA	0-N2059	46750224	0-N1528	55181878	0-N1842S
13504-87701-000	0-N040	5010372AA	0-N1962	46750224	0-N1528S	55183497	0-N1616
13505-87102	0-N036	53010158	0-N1839	46754624	0-N1481	55183527	0-N115
13505-87201	0-N043	53010158	0-N1839S	46754624	0-N1481S	55184055	0-N2117
13505-87201-000	0-N043	53030958AC	0-N2257	46756937	0-N1399	55184055	0-N2117S
13505-87301-000	0-N1563	53030958AC	0-N2257S1	46792898	0-N208	551840550	0-N2117
13505-87303-000	0-N1562	53030958AC	0-N2257S2	46794035	0-N1415	551840550	0-N2117S
13505-87701	0-N037	53030958AD	0-N2257	46798684	0-N1842	55184761	0-N1490S
13505-87701-000	0-N037	53030958AD	0-N2257S1	46798684	0-N1842S	55184980	0-N1503
13505-87702	0-N038	53030958AD	0-N2257S2	46817666	0-N195	55184980	0-N1503S
13505-87702-000	0-N038	68027647AA	0-N2238	46819146	0-N1478S	55185074	0-N1526
13505-87703	0-N2323	68031478AA	SK-1734	474 0846	0-N816	55185074	0-N1526S
13505-87703-000	0-N2323	68045800AA	0-N2257	474 0847	0-N821	55187100	0-N2149
13505-87704	0-N039	68045800AA	0-N2257S1	4852375	0-N949	55190813	0-N1503
13505-87704-000	0-N039	68045800AA	0-N2257S2	500328902	0-N816	55190813	0-N1503S
13505-97201	0-N1764	FIAT		500344132	0-N1386	55191315	0-N115
13505-97201-000	0-N1764	1609010680	0-N1460	500346226	0-N1387	55191969	0-N1517
16603-23020	0-N2273	1611424580	0-N1620	500388688	0-N1352	55191969	0-N1517S
16603-23021	0-N2273	1611424580	0-N1620S	500390458	0-N1352	55192239	0-N114
16603-23022	0-N2273	4279745	0-N1617	500393575	0-N1806	55192240	0-N194
16603-97401	0-N1983	4427068	0-N850	504000410	0-N1483	55192323	0-N115
16620-47010	0-N2198	46400054	0-N951	504000410	0-N1483S	55192773	0-N196
16620-47010	0-N2198S	46403679	0-N195	504000412	0-N1597	55193358	0-N1522
16630-97401	0-N2339	46416489	0-N208	504010846	0-N1351	55195023	0-N1517
16630-97402	0-N2229	46424716	0-N187	504084453	0-N1711S	55195023	0-N1517S
16630-97403	0-N2339	46439454	0-N1634	504086751	0-N1483	55196971	0-N113
16630-97404	0-N2339	46439471	0-N1672	504086751	0-N1483S	55200441	0-N1326
16630-B2010	0-N2339	46440604	0-N1630	504086948	0-N1714	55204392	0-N1399
DODGE		46441096	0-N1599	504086948	0-N1714S	55206531	0-N2049
0 4792 410AB	0-N2233	46441096	0-N1599S	504106751	0-N1387	55208381	0-N115
0 4792 410AC	0-N2233	46442999	0-N1407	504183759	0-N1351	55211287	0-N951



FIAT		FIAT		FIAT		FIAT	
55211749	0-N2150	71736717	SK-1412	7553760	0-N826	9400831829	SK-1085
55215666	0-N115	71736718	SK-1418	7554724	0-N1629	9400831869	SK-1354
55216459	0-N1526	71736719	SK-1421	7596727	0-N889	9400831889	SK-1482
55216459	0-N1526S	71736720	SK-1035	7596728	0-N835	9400831929	SK-1594
55222539	0-N2390	71736722	SK-1637	7596876	0-N889	9405751679	0-N1545
55222539	0-N2390S	71736723	SK-1446	7596877	0-N835	9405751819	0-N1747
55232827	0-N1517	71736724	SK-1410	7650925	0-N187	9405751949	0-N1945
55232827	0-N1517S	71736725	SK-1415	7702173	0-N187	9405751949	0-N1945S
55233759	0-N1616	71736726	SK-1629	7733200	0-N1672	9464640480	0-N1327
55238027	0-N115	71736729	SK-1365	7740252	0-N1966	9467516789	SK-1483
55244469	0-N2390	71736729	SK-1697	7763644	0-N950	9467521280	SK-1616
55244469	0-N2390S	71736793	0-N950	7766487	0-N1593	9467521380	0-N1357
55555653	0-N1347	71736795	SK-1112	7766487	0-N1593S	9467521480	0-N1358
55556090	0-N1799	71739304	0-N1588	7766585	0-N1593	9467538389	SK-1086
55556090	0-N1799S	71739304	0-N1588S	7766585	0-N1593S	9467544580	SK-1614
55560082	0-N1347	71739801	0-N1348	777 8564	0-N1599	9467582689	SK-1692
55562217	0-N1347	7174 3962	0-N1667	777 8564	0-N1599S	9467611180	SK-1714
55562218	0-N1347	71740977	0-N822	7772961	0-N196	9467615880	SK-1424
55570289	0-N1347	71741116	0-N2194	7778565	0-N115	9467618089	0-N2224
561 9217	0-N822	71741116	0-N2194S	7782192	0-N113	9467618089	0-N2382
5956109	0-N823	71743963	0-N1522	7784613	0-N1634	9467626380	SK-1086
597 2277	0-N822	71743966	0-N1503	7788010	0-N1652	9467626480	SK-1085
5985019	0-N826	71743966	0-N1503S	7789752	0-N1630	9467626680	SK-1354
5997325	0-N818	71746353	SK-1421	7797142	0-N187	9467626880	SK-1534
60596372	0-N114	71747798	0-N1487	7798333	0-N1407	9467628080	SK-1482
60602136	0-N1628	71747798	0-N1487S	7798333	0-N1407S	9467628180	SK-1594
60607965	0-N938	71747799	0-N115	9400818199	0-N871	9467628980	SK-1085
60610908	0-N1403	71754559	SK-1586	9400829598	0-N118P	9467642580	SK-1714
60652129	0-N938	71754560	SK-1696	9400829629	0-N118P	96 16 660 580	0-N170
60664403	0-N938	71754561	SK-1677	9400829669	0-N1057	96 832 734 80	0-N2018
60667496	0-N1572	71754562	SK-1693	9400829929	0-N1057	9605266280	0-N811
60671573	0-N938	71754563	SK-1586	9400830149	0-N862	9608859180	0-N124
60671789	0-N1394	71754842	SK-1032	9400830289	0-N119P	9608989980	0-N1405
60677108	0-N2117	71754843	SK-1411	9400830319	0-N119P	9615923380	0-N900
60677108	0-N2117S	71754845	SK-1033	9400830379	0-N862	9616660580	0-N170
60812622	0-N114	71754846	SK-1144	9400830429	0-N1065	9616660780	0-N171
60812624	0-N938	71754847	SK-1046	9400830509	0-N1334	9617188680	0-N901
60812718	0-N194	71754849	SK-1031	9400830589	0-N170	9622234180	0-N1463S
60813415	0-N938	71754850	SK-1050	9400830599	0-N171	9622574480	0-N943
60813569	0-N1490S	71771498	0-N2149	9400831069	SK-1019	9623001280	0-N1472
60813590	0-N1326	71771575	SK-1412AQ2	9400831119	SK-1017	9623001280	0-N1472S
60813592	0-N115	71771576	SK-1418AQ1	9400831279	SK-1022	9623659880	0-N1747
60814033	0-N1415	71771584	SK-1696AQ1	9400831349	SK-1079	9625621780	0-N1713
60814110	0-N1407	73502729	0-N1598	9400831409	SK-1085	9625621880	0-N1722
60814110	0-N1407S	73502730	0-N1481	9400831489	SK-1082	9626365280	0-N1484
60815188	0-N1487	73502730	0-N1481S	9400831529	SK-1017	9626365280	0-N1484S
60815188	0-N1487S	73502887	0-N1842	9400831559	SK-1482	9627860780	0-N931
71734799	0-N208	73502887	0-N1842S	9400831589	SK-1086	9629471780	0-N1681
71736493	0-N950	73503128	0-N195	9400831609	SK-1394	9631847480	0-N1413
71736714	SK-1646	7541718	0-N832	9400831629	SK-1085	9631962880	0-N1545
71736715	SK-1076	755 3564	0-N819	9400831739	SK-1534	9632155180	0-N1747
71736716	SK-1610	755 3565	0-N820	9400831789	SK-1085	9632722180	0-N1065

FIAT

9633056680	0-N1747
9633315180	0-N1748
9633315280	0-N151
9633802580	0-N1968
9634465780	0-N1493
9634465780	0-N1493S
9635966680	0-N1473
9635966680	0-N1473S
9636207480	0-N1391
9636207480	0-N1391S
9636355180	0-N1493
9636355180	0-N1493S
9636640580	0-N1416
9636782780	0-N1471
9636782780	0-N1471S
9637024080	0-N1309
9641539380	0-N1066
9642184080	0-N1056
9642929880	0-N1277
9642965780	0-N151
9643329680	0-N1057
9644759580	0-N1421
9644788580	0-N1421
9650542480	0-N2037
9650542480	0-N2037S
9651260980	0-N171
9651261480	0-N170
9652046680	0-N1620
9652046680	0-N1620S
9652748480	0-N1056
9653197280	0-N2042
9653197280	0-N2042S
9653522380	0-N1493
9653522380	0-N1493S
9653522780	0-N1471
9653522780	0-N1471S
9654127380	0-N1808
9654127380	0-N1808S
9658142480	0-N1460
9658142680	0-N1392
9658142780	0-N2014
9658142780	0-N2014S
9658559480	0-N1807
9660484680	0-N2046
9660484680	0-N2046S
9671609180	0-N2268
9671609180	0-N2268S
9678325280	0-N1460
9678770180	0-N1392
9684015280	0-N1419
99461357	0-N816
99461358	0-N821

FIAT

K04861277AB	0-N2406
K04861277AB	0-N2406S
K04861277AD	0-N2406
K04861277AD	0-N2406S
K04891595AE	0-N2112
K04891595AE	0-N2112S
K04891596AC	0-N2048
K04891797AB	0-N2048
K4627094AA	0-N2049
K68027611AB	0-N2329

FORD

1 000 159	0-N290
1 004 409	0-N1260
1 004 475	0-N1903
1 004 475	0-N1903S
1 004 481	0-N1897
1 004 481	0-N1897S
1 004 549	0-N1443
1 004 549	0-N1443S
1 004 961	0-N1501
1 004 961	0-N1501S
1 004 965	0-N2022
1 004 965	0-N2022S
1 005 120	0-N128
1 005 516	0-N985
1 005 822	0-N915
1 005 823	0-N902
1 021 706	0-N089
1 021 707	0-N123
1 027 404	0-N1557S
1 031 030	0-N2220
1 031 030	0-N2220S
1 038 384	0-N292
1 039 422	0-N294
1 039 808	0-N1609
1 040 677	0-N123
1 040 678	0-N089
1 044 515	0-N1796
1 044 515	0-N1796S
1 049 577	0-N1716
1 051 901	0-N1417
1 052 359	0-N2022
1 052 359	0-N2022S
1 053 684	0-N1501
1 053 684	0-N1501S
1 053 942	0-N293
1 056 697	0-N123
1 058 458	0-N104
1 061 459	0-N1435
1 061 459	0-N1435S
1 064 925	0-N2157
1 069 144	0-N1845

FORD

1 069 144	0-N1845S
1 069 359	0-N1520
1 069 359	0-N1520S
1 069 359	0-N1610
1 072 031	0-N290
1 072 131	0-N294
1 072 321	0-N1385
1 073 096	0-N1435
1 073 096	0-N1435S
1 073 485	0-N1520
1 073 485	0-N1520S
1 073 485	0-N1610
1 075 546	0-N1433
1 075 546	0-N1433S
1 077 687	0-N1796
1 077 687	0-N1796S
1 077 689	0-N1903
1 077 689	0-N1903S
1 079 155	0-N1520
1 079 155	0-N1520S
1 079 155	0-N1610
1 079 173	0-N1367
1 079 393	0-N1458
1 088 100	0-N1400
1 088 100	0-N1400S
1 089 679	0-N1501
1 089 679	0-N1501S
1 095 025	0-N291
1 097 574	0-N1665
1 099 552	0-N123
1 099 553	0-N089
1 099 957	0-N1845
1 099 957	0-N1845S
1 100 566	0-N1049
1 100 583	0-N1265
1 100 585	0-N1268
1 100 693	0-N1433
1 100 693	0-N1433S
1 101 540	0-N2022
1 101 540	0-N2022S
1 102 823	0-N2155
1 102 823	0-N2155S
1 104 003	0-N1778
1 104 087	0-N294
1 106 830	0-N1657
1 106 830	0-N1657S
1 107 573	0-N290
1 108 752	SK-1041
1 108 756	SK-1078
1 108 758	SK-1078
1 110 999	SK-1042
1 111 911	0-N294

FORD

1 112 530	SK-1094
1 112 807	0-N1385
1 113 174	0-N1367
1 113 355	0-N294
1 113 611	0-N1520
1 113 611	0-N1520S
1 113 611	0-N1610
1 114 044	0-N1433
1 114 044	0-N1433S
1 114 544	0-N1716
1 114 737	0-N1434
1 114 737	0-N1434S
1 114 935	0-N2155
1 114 935	0-N2155S
1 117 008	0-N1392
1 117 009	0-N1428
1 118 677	0-N1458
1 119 021	0-N1048
1 119 023	0-N1274
1 119 938	0-N1702
1 119 954	0-N1719
1 119 954	0-N1719S
1 120 687	0-N1390
1 120 687	0-N1390S
1 122 523	0-N1494
1 122 523	0-N1494S
1 124 040	SK-1341
1 125 419	0-N1477
1 125 419	0-N1477S
1 127 103	0-N1497
1 127 103	0-N1497S
1 128 896	0-N1428
1 131 255	0-N1390
1 131 255	0-N1390S
1 132 644	0-N1390
1 132 644	0-N1390S
1 133 988	0-N1520
1 133 988	0-N1520S
1 133 988	0-N1610
1 135 356	0-N1361
1 135 358	SK-1049
1 135 627	0-N1702
1 136 183	0-N1622
1 136 426	SK-1351
1 139 712	0-N1496S
1 139 951	0-N1385
1 141 999	0-N1420
1 142 000	0-N1418
1 143 406	0-N1636
1 143 406	0-N1636S
1 145 493	0-N1458
1 145 947	0-N1062



FORD		FORD		FORD		FORD	
1 145 955	0-N1066	1 350 032	0-N1811S	1 445 915	0-N2038S	1 690 293	0-N1502S
1 148 358	0-N1653S	1 351 134	0-N1520	1 446 648	SK-1424	1 696 474	0-N2042
1 149 503	0-N1622	1 351 134	0-N1520S	1 456 983	0-N1963	1 696 474	0-N2042S
1 152 359	0-N1418	1 351 134	0-N1610	1 465 914	0-N1964	1 707 028	0-N2063
1 152 360	0-N1420	1 355 389	0-N1339	1 465 914	0-N1964S	1 731 709	0-N1392
1 152 890	0-N1433	1 355 389	0-N1339S	1 469 717	0-N1339	1 739 145	0-N2224
1 152 890	0-N1433S	1 357 587	0-N1636	1 469 717	0-N1339S	1 759 714	0-N2224
1 201 178	0-N1392	1 357 587	0-N1636S	1 473 383	0-N1942	1 780 142	SK-1659AQ1
1 201 181	0-N1477	1 359 934	0-N1062	1 473 384	0-N1520	1134084	0-N1716
1 201 181	0-N1477S	1 361 545	0-N1942	1 473 384	0-N1520S	1149701	0-N2266
1 201 255	SK-1341	1 361 840	0-N294	1 473 384	0-N1610	1149701	0-N2266S1
1 211 185	SK-1391	1 361 876	0-N1667	1 476 893	0-N1964	1149701	0-N2266S2
1 213 852	0-N291	1 361 983	0-N1564	1 476 893	0-N1964S	1201178	0-N1460
1 214 747	0-N1636	1 364 675	0-N1811	1 477 061	0-N2042	1203767	SK-1754
1 214 747	0-N1636S	1 364 675	0-N1811S	1 477 061	0-N2042S	1340774	0-N2266
1 215 978	0-N1367	1 367 254	0-N1709	1 479 084	0-N1367	1340774	0-N2266S1
1 215 978	0-N295	1 367 254	0-N1709S1	1 480 012	0-N1636	1340774	0-N2266S2
1 221 490	0-N1045	1 367 254	0-N1709S2	1 480 012	0-N1636S	1372015	SK-1492
1 221 491	0-N1046	1 371 224	0-N1497	1 481 774	0-N1062	1372015	SK-1666
1 222 855	0-N1420	1 371 224	0-N1497S	1 492 247	0-N2018	1372398	0-N1460
1 222 856	0-N1418	1 371 715	0-N1573	1 496 244	0-N1460	1449044	0-N1666
1 229 540	0-N1339	1 371 753	0-N958	1 496 915	0-N839	1465253	0-N2353
1 229 540	0-N1339S	1 372 398	0-N1460	1 514 877	0-N1964	1496244	0-N1460
1 229 768	SK-1424	1 372 770	0-N1661	1 514 877	0-N1964S	1555720	0-N2353
1 231 975	0-N1327	1 373 306	SK-1424	1 535 429	0-N1517	1683646	0-N2396
1 231 978	0-N1334	1 374 385	0-N1702	1 535 429	0-N1517S	1683646	0-N2396S
1 231 979	SK-1594	1 374 425	0-N2096	1 535 439	0-N1616	1685618	0-N2269
1 251 661	0-N1639	1 374 425	0-N2096S	1 538 439	0-N2018	1685618	0-N2269S
1 251 661	0-N1639S	1 374 427	0-N1554	1 539 115	0-N1478S	1685619	0-N2363
1 253 954	0-N2037	1 374 427	0-N1554S	1 540 603	0-N2190	1685884	0-N2363
1 253 954	0-N2037S	1 376 164	0-N1564	1 540 603	0-N2190S	1703348	SK-1732
1 301 972	0-N294	1 376 316	0-N1797	1 540 605	0-N2109	1714893	0-N2363
1 301 973	0-N294	1 376 316	0-N1797S	1 540 605	0-N2109S	1725441	0-N2382
1 302 873	0-N1811	1 376 631	0-N1494	1 562 503	0-N1062	1726568	SK-1666
1 302 873	0-N1811S	1 376 631	0-N1494S	1 563 519	0-N1964	1731729	0-N1460
1 306 666	0-N1497	1 380 026	SK-1339	1 563 519	0-N1964S	1753585	SK-1424AQ1
1 306 666	0-N1497S	1 380 026	SK-1340	1 567 809	0-N1797	1754059	0-N2363
1 308 227	0-N1942	1 385 379	0-N2038	1 567 809	0-N1797S	1754317	SK-1732
1 310 771	0-N2037	1 385 379	0-N2038S	1 598 372	0-N1478S	1761515	SK-1714AQ1
1 310 771	0-N2037S	1 387 066	0-N1991	1 612 261	0-N1644	1761930	0-N2300
1 315 781	0-N1639	1 387 199	0-N1797	1 624 447	0-N1418	1761930	0-N2300S
1 315 781	0-N1639S	1 387 199	0-N1797S	1 639 176	0-N1779	1761931	0-N2303
1 318 336	0-N2037	1 388 493	0-N1573	1 649 176	0-N1246	1761941	SK-1594AQ1
1 318 336	0-N2037S	1 420 513	0-N2014	1 669 904	0-N104	1763647	0-N1653S
1 318 844	0-N1716	1 420 513	0-N2014S	1 669 984	0-N1657	1768088	0-N2396
1 328 472	0-N290	1 425 510	0-N1797	1 669 984	0-N1657S	1768088	0-N2396S
1 329 630	0-N1636	1 425 510	0-N1797S	1 672 143	SK-1077	1800558	0-N2269
1 329 630	0-N1636S	1 440 810	0-N2116	1 672 144	SK-1659	1800558	0-N2269S
1 333 203	0-N1719	1 440 810	0-N2116S	1 683 833	SK-1714	1855727	SK-1732AQ1
1 333 203	0-N1719S	1 440 933	0-N2042	1 685 747	0-N2057	1855731	SK-1424AQ1
1 348 648	SK-1391	1 440 933	0-N2042S	1 685 777	0-N2224	1855738	SK-1424AQ1
1 350 032	0-N1811	1 445 915	0-N2038	1 690 293	0-N1502	1C1Q-6K254-AA	0-N1361

FORD		FORD		FORD		FORD	
1C1Q-6M260-AA	SK-1351	2S7E-6A228-AA	0-N1390S	4M5Q-6A228-BB	0-N1339	6 911 750	0-N1845
1C1Q-6M260-BA	SK-1049	2T1Q-19A21-6AA	0-N1942	4M5Q-6A228-BB	0-N1339S	6 911 750	0-N1845S
1N3J6268AA	SK-1754	2T1Q-19A21-6BA	0-N1942	4M5Q-6A228-ED	0-N1709	6 935 235	0-N1896
1S4Q-6A228-AD	0-N1520	2T1Q-19A21-6BB	0-N1942	4M5Q-6A228-ED	0-N1709S1	6 935 235	0-N1896S
1S4Q-6A228-AD	0-N1520S	2T1Q-6K254-AA	0-N1367	4M5Q-6A228-ED	0-N1709S2	6 935 236	0-N1895
1S4Q-6A228-AD	0-N1610	2T1Q-6K254-AA	0-N295	4S6Q-10K018-AA	0-N2266	6 935 236	0-N1895S
1S4Q-6A228-AE	0-N1520	2T1Q-6K254-AB	0-N1367	4S6Q-10K018-AA	0-N2266S1	6 977 403	0-N1845
1S4Q-6A228-AE	0-N1520S	2T1Q-6M260-AA	SK-1341	4S6Q-10K018-AA	0-N2266S2	6 977 403	0-N1845S
1S4Q-6A228-AE	0-N1610	3 396 014	0-N077	4S7Q-19A21-6JA	0-N1991	6 988 203	0-N915
1S4Q-6A228-AF	0-N1520	3 396 016	0-N081	4S7Q-6C348-BC	0-N1615	6 992 642	0-N1957
1S4Q-6A228-AF	0-N1520S	3 406 367	0-N2024	4S7Q-6K254-BD	0-N1613	6 992 642	0-N1957S
1S4Q-6A228-AF	0-N1610	3 590 347	0-N2225	4S7Q-6K254-CB	0-N1614	6 A22 8BB	0-N1339
1S7Q-19A21-6AB	0-N1702	3 804 186	0-N2024	5098760	0-N1811	6 A22 8BB	0-N1339S
1S7Q-19A21-6AC	0-N1702	3 804 188	0-N2041	5098760	0-N1811S	6C 1Q 19A21 6AA	0-N1460
1S7Q-19A21-6AD	0-N1702	3 864 995	0-N080	5M5G-6K254-AB	0-N1564	6C 1Q 19A21 6AB	0-N1460
1S7Q-6A228-AC	0-N1497	3 894 197	0-N079	5M5Q-19A216-AA	0-N1667	6C1Q-19A21-6AA	0-N1460
1S7Q-6A228-AC	0-N1497S	3 978 035	0-N2028	5M5Q-19A21-6DC	0-N2353	6C1Q-19A21-6AB	0-N1460
1S7Q-6A228-AD	0-N1497	3 994 039	0-N079	5M5Q-6A228-AA	0-N1639	6C1Q-6A228-AB	0-N2014
1S7Q-6A228-AD	0-N1497S	3M5Q-6A228-AB	0-N1639	5M5Q-6A228-AA	0-N1639S	6C1Q-6A228-AB	0-N2014S
1S7Q-6A228-AE	0-N1497	3M5Q-6A228-AB	0-N1639S	5M5Q-6C344-AA	0-N2353	6C1Q-6A228-BB	0-N2038
1S7Q-6A228-AE	0-N1497S	3M5Q-6A228-AC	0-N1639	5M5Q-8680A-C	0-N2353	6C1Q-6A228-BB	0-N2038S
2M21-6K254-AA	0-N1045	3M5Q-6A228-AC	0-N1639S	5M5Q-8A615-AA	SK-1659	6C1Q-6A228-BC	0-N2038
2M21-6K297-AA	0-N1046	3M5Q-6A228-AD	0-N1639	5M5Q-8B596-AA	SK-1659AQ1	6C1Q-6A228-BC	0-N2038S
2M2E-6A228-AA	0-N1653S	3M5Q-6A228-AD	0-N1639S	6 121 753	0-N842	6C1Q-6C344-AB	0-N1661
2S61-19A21-6AA	0-N1420	3M5Q-6B217-AA	0-N1327	6 121 754	0-N842	6E5Q-6A228-BD	0-N1811
2S61-19A21-6AB	0-N1420	3M5Q-6M250-AA	0-N1334	6 121 780	0-N838	6E5Q-6A228-BD	0-N1811S
2S61-19A21-6BA	0-N1418	3M5Q-8A615-AA	SK-1424	6 131 141	0-N837	6G9N 7739 AD	0-N2242
2S61-19A21-6BB	0-N1418	3M5Q-8A615-AB	SK-1424	6 168 156	0-N1519	6G9N 7739 AD	0-N2242S
2S61-19A21-6BC	0-N1418	3M5Q-8A615-BA	SK-1594	6 168 156	0-N1519S	6G9N 7739 AE	0-N2242
2S61-19A21-6CA	0-N1418	3M5Q-8A615-CA	SK-1424	6 177 882	0-N915	6G9N 7739 AE	0-N2242S
2S61-19A21-6DA	0-N1420	3M5Q-8A615-DA	SK-1077	6 177 883	0-N1214	6G9N-11948-AC	0-N2243
2S61-6A228-AC	0-N1636	3M5Q-8B596-AA	SK-1424AQ1	6 177 884	0-N902	6G9N-11948-AD	0-N2243
2S61-6A228-AC	0-N1636S	3M5Q-8B596-AAK	SK-1424AQ1	6 178 656	0-N874	6G9N-6K254-BA	0-N1573
2S61-6A228-AD	0-N1636	3M5Q8B596BA	SK-1594AQ1	6 182 891	0-N837	6G9N-7730-CE	0-N1964
2S61-6A228-AD	0-N1636S	3S4Q-6A228-AA	0-N1811	6 200 285	0-N1401	6G9N-7730-CE	0-N1964S
2S61-6A228-AE	0-N1636	3S4Q-6A228-AA	0-N1811S	6 482 249	0-N197	6G9N-7730-CF	0-N1964
2S61-6A228-AE	0-N1636S	3S4Q-6A228-AB	0-N1811	6 492 482	0-N902	6G9N-7730-CF	0-N1964S
2S61-6A228-AF	0-N1636	3S4Q-6A228-AB	0-N1811S	6 497 120	0-N874	6G9N-7739-CC	0-N1964
2S61-6A228-AF	0-N1636S	3S4Q-6A228-AC	0-N1811	6 501 088	0-N1519	6G9N-7739-CC	0-N1964S
2S61-6A228-AG	0-N1636	3S4Q-6A228-AC	0-N1811S	6 501 088	0-N1519S	6G9N-7739-CD	0-N1964
2S61-6A228-AG	0-N1636S	4060-2001F	0-N1644	6 577 227	0-N1533	6G9N-7739-CD	0-N1964S
2S6G-10K018-BA	0-N2266	4M5G-6K254-CA	0-N294	6 577 227	0-N1533S	6G9N-7739-CF	0-N1964
2S6G-10K018-BA	0-N2266S1	4M5G-6K254-DA	0-N294	6 616 951	0-N155	6G9N-7739-CF	0-N1964S
2S6G-10K018-BA	0-N2266S2	4M5G-6K254-DB	0-N294	6 616 952	0-N156	6G9Q-19A21-6AA	0-N1963
2S6Q-6B217-AA	0-N1062	4M5Q-6A228-8FA	0-N2037	6 635 941	0-N903	6G9Q-6A228-BC	0-N1797
2S6Q-6B217-AB	0-N1062	4M5Q-6A228-8FA	0-N2037S	6 635 942	0-N904	6G9Q-6A228-BC	0-N1797S
2S6Q-6B217-AD	0-N1062	4M5Q-6A228-8FC	0-N2037	6 710 259	0-N1533	6G9Q-6B217-AC	0-N2018
2S6Q-6B217-AE	0-N1062	4M5Q-6A228-8FC	0-N2037S	6 710 259	0-N1533S	6G9Q-6B217-AD	0-N2018
2S6Q-6M250-AA	0-N1066	4M5Q-6A228-8FD	0-N2037	6 727 884	0-N1642	6M34 6M250 AA	0-N1666
2S6Q-8A615-AA	SK-1391	4M5Q-6A228-8FD	0-N2037S	6 744 307	0-N096	6M5G-6K254-AA	0-N1573
2S6Q-8A615-AB	SK-1391	4M5Q-6A228-BA	0-N1339	6 789 631	0-N1519	6M5G-6M250-AA	0-N958
2S7E-6A228-AA	0-N1390	4M5Q-6A228-BA	0-N1339S	6 789 631	0-N1519S	6M5G6M260AA	SK-1492



FORD		FORD		FORD		FORD	
6M5Q-6A228-AA	0-N2096	93FF-6K254-BA	0-N915	988M-6K254-AB	0-N290	AV6Q-6M250-AB	0-N2382
6M5Q-6A228-AA	0-N2096S	944F-6A228-BA	0-N1957	988M-6K254-AC	0-N290	BF6N6M260AA	SK-1666
6M5Q-6A228-BA	0-N1554	944F-6A228-BA	0-N1957S	988M-6K254-AD	0-N290	BM5G-6K254-AE	0-N2057
6M5Q-6A228-BA	0-N1554S	94FF-19A21-6AB	0-N1400	988M-6K254-AE	0-N290	BM5Q-19A216-AB	0-N2363
7 044 044	0-N1400	94FF-19A21-6AB	0-N1400S	98BB-19A21-6AA	0-N1716	BM5Q-19A216-AC	0-N2363
7 044 044	0-N1400S	94FF-19A21-6AC	0-N1400	98BB-19A21-6AB	0-N1716	BM5Q-19A216-AD	0-N2363
7 053 546	0-N197	94FF-19A21-6AC	0-N1400S	98DD-6K254-AA	0-N2157	BM5Q-6A228-AA	0-N2269
7 053 802	0-N902	95VW-10145-DA	0-N1609	98FF-19A21-6BB	0-N1458	BM5Q-6A228-AA	0-N2269S
7 064 724	0-N1557S	95VW-6A228-AB	0-N1657	98FF-19A21-6BC	0-N1458	BM5Q-6C344-AA	0-N2363
7 072 698	0-N2156	95VW-6A228-AB	0-N1657S	98FF-19A21-6BD	0-N1458	CC 1Q 19A21 6CA	0-N1392
7 109 163	0-N1385	95VW-6A228-EA	0-N1657	98FF-3K738-BG	0-N1520	CC 1Q 19A21 6DA	0-N1460
7 109 977	0-N2157	95VW-6A228-EA	0-N1657S	98FF-3K738-BG	0-N1520S	CM5Q-19A216-AB	0-N2303
7 158 445	0-N1642	95VW-6K254-CA	0-N104	98FF-3K738-BG	0-N1610	CM5Q-6A2228-BA	0-N2300
7 168 218	0-N2156	95VW-6K254-DA	0-N104	98FF-3K738-BH	0-N1520	CM5Q-6A2228-BA	0-N2300S
7 239 509	0-N1653S	95WF-19A21-6AC	0-N1385	98FF-3K738-BH	0-N1520S	CV2Q-6B217-AA	0-N2224
7 330 712	0-N874	95WF-19A21-6AD	0-N1385	98FF-3K738-BH	0-N1610	CV6Q-6B217-AA	0-N2224
7 392 480	0-N1653S	95WF-6A228-BB	0-N1653S	98FF-3K773-8BG	0-N1610	DS7G-6A228-AA	0-N2269
7 400 530	0-N128	96 551 989 80	0-N1636	98FF-3K773-8BH	0-N1610	DS7G-6A228-AA	0-N2269S
84FM-6K254-AB	0-N838	96 551 989 80	0-N1636S	98MF-3C631-CD	0-N1433	E5EE-6K254-AA	0-N1246
84SM-6K254-CA	0-N837	96BF-6A228AB	0-N1443	98MF-3C631-CD	0-N1433S	F83E-6C348-AA	0-N2028
88WF-6A228-AC	0-N1519	96BF-6A228AB	0-N1443S	98MF-3C631-CE	0-N1433	K805-1594X-A	0-N2024
88WF-6A228-AC	0-N1519S	96FF-19A21-6AE	0-N1501	98MF-3C631-CE	0-N1433S	K805-1594Y-B	0-N2041
89FF-6K254-AC	0-N874	96FF-19A21-6AE	0-N1501S	98MF-3C631-CF	0-N1433	ME3M5Q-8B596-AA	SK-1424AQ1
89FF-6K254-AD	0-N874	96FF-19A21-6AF	0-N1501	98MF-3C631-CF	0-N1433S	V94D-D19A2-16AA	0-N2156
89FF-6K254-CB	0-N1214	96FF-19A21-6AF	0-N1501S	98MF-3C631-CG	0-N1433	V94D-D6K25-4AA	0-N2157
89FF-6K254-DC	0-N902	96FF-19A21-6BC	0-N2022	98MF-3C631-CG	0-N1433S	V97M-F6A22-8AB	0-N1796
89FF-6K254-DD	0-N902	96FF-19A21-6BC	0-N2022S	98MF-6A228-BE	0-N1434	V97M-F6A22-8AB	0-N1796S
8G9Q-6A228-AA	0-N1797	96FF-19A21-6BD	0-N2022	98MF-6A228-BE	0-N1434S	VX02-8109244VX	0-N128
8G9Q-6A228-AA	0-N1797S	96FF-19A21-6BD	0-N2022S	98MM-6K254-AB	0-N294	VX02-81452-78EVX	0-N1417
8M5N-6A228-AA	0-N2190	96FF-6K254-AA	0-N985	98MM-6K254-AC	0-N294	X1C1-Q6254-AA	0-N1367
8M5N-6A228-AA	0-N2190S	96FF-6K254-BA	0-N915	98MM-6K254-AD	0-N294	XM21-6B260-AA	0-N1049
8M5N-6A228-BA	0-N2109	96FF-6K254-DB	0-N902	98MM-6K254-AE	0-N294	XM21-6K254-AA	0-N1265
8M5N-6A228-BA	0-N2109S	96MF-6A228-AD	0-N1903	98MM-6K254-BB	0-N294	XM21-6K297-AA	0-N1268
91SF-19A216-AA	0-N197	96MF-6A228-AD	0-N1903S	98MM-6K254-BC	0-N294	XM34-6K254-AA	0-N2225
91SF-19A216-AB	0-N197	96MF-6A228-BD	0-N1897	98MM-6K254-BD	0-N294	XS7E-19A21-6AC	0-N1392
928F-1 9A216-AA	0-N1401	96MF-6A228-BD	0-N1897S	98MM-6K254-BL	0-N294	XS7E-19A21-6AD	0-N1392
928F-6A228-AB	0-N1533	96MM-6M250-AC	0-N1260	9M5Q-6A228-BA	0-N2396	XS7E-19A21-6BC	0-N1428
928F-6A228-AB	0-N1533S	96WF-6A228-AA	0-N1557S	9M5Q-6A228-BA	0-N2396S	XS7E-6A228-BC	0-N1390
928M-6K254-AC	0-N903	978M-6K254-AD	0-N1778	9M5Q-6A228-BB	0-N2396	XS7E-6A228-BC	0-N1390S
928M-6M250-BC	0-N904	978M-6M25-0AA	0-N292	9M5Q-6A228-BB	0-N2396S	XS7E-6A228-CB	0-N1477
928M-6M250-DC	0-N096	978M-6M25-0BB	0-N293	9M5Q-6B217-AB	0-N2063	XS7E-6A228-CB	0-N1477S
93BB-19A21-6AD	0-N1642	97BB-6A228-AG	0-N1435	9M5Q-8A615-AA	SK-1714	XS7E-6A228-CC	0-N1477
93BB-19A21-6BF	0-N1896	97BB-6A228-AG	0-N1435S	9M5Q8B596AA	SK-1714AQ1	XS7E-6A228-CC	0-N1477S
93BB-19A21-6BF	0-N1896S	97FF-6K254-CB	0-N089	9S51-6A228-BA	0-N1478S	XS7G-6M250-AA	0-N291
93BB-19A21-6CE	0-N1895	97FF-6K254-CC	0-N089	9S51-6K255-AA	0-N1616	XS7G-6M250-BA	0-N291
93BB-19A21-6CE	0-N1895S	97FF-6K254-DA	0-N123	9X2Q-6K254-BB	0-N1614	YC1E-6A228-AF	0-N1719
93BB-6A228-AE	0-N1845	97FF-6K254-DB	0-N123	AV2Q8A615AA	SK-1732	YC1E-6A228-AF	0-N1719S
93BB-6A228-AE	0-N1845S	97FF-6K254-DC	0-N123	AV2Q8A615AB	SK-1732	YC1E-6A228-AG	0-N1719
93BB-6A228-AF	0-N1845	97FF-6K254-DD	0-N123	AV2Q8B596AAK	SK-1732AQ1	YC1E-6A228-AG	0-N1719S
93BB-6A228-AF	0-N1845S	97MF-6K254-AB	0-N2220	AV6Q-6A228-AB	0-N1502	YC1E-9444A-D	0-N1665
93BB-6A228-AG	0-N1845	97MF-6K254-AB	0-N2220S	AV6Q-6A228-AB	0-N1502S	YM21-10145BB	0-N1496S
93BB-6A228-AG	0-N1845S	98 BB 19A21 6AC	0-N1716	AV6Q-6B217-AA	0-N2224	YM21-6B260-AA	0-N1274

FORD

YM21-6K254-AA	0-N1494
YM21-6K254-AA	0-N1494S
YM21-6K254-CA	0-N1048
YM21-6K254-EA	0-N1494
YM21-6K254-EA	0-N1494S
YS 4E 19A21 6BA	0-N1716
YS4E-19A21-6AA	0-N1385
YS4E-19A21-6AB	0-N1385
YS4E-19A21-6BB	0-N1716
YS4J-6K288AA	SK-1041
YS4J-6K288-BA	SK-1042
YS4J-6K288-BS	SK-1041
YS4J-6K288-CA	SK-1078
YS4J-6K288-DA	SK-1078
YS4Q-6K254-AB	0-N1367
YS4Q6M260AA	SK-1341
YS6E19A216AA	0-N1622
YS6E19A216AB	0-N1622
YS6E-6A228-BA	0-N2155
YS6E-6A228-BA	0-N2155S
YS6E-6A228-CA	0-N2155
YS6E-6A228-CA	0-N2155S
YS7J6268AB	SK-1094
YS7J-6268A-B	SK-1094
YS7J-6268C-A	SK-1339
YS7J-6268C-A	SK-1340

FORD AUSTRALIA

7803-21023	0-N1718
------------	---------

FORD USA

1L2E-19A21-6AC	0-N1684
1L2Z-8678A-B	0-N1684
7803-21023	0-N1718

HONDA

04145-PLC-315	0-N1330
13404-P13-003	0-N193
13404-PCA-003	0-N178
13404-PT0-003	0-N178
13404-PT0-004	0-N178
14325-P5T-G00	0-N1273
14510-634-000	0-N1781
14510-P08-003	0-N978
14510-P08-004	0-N978
14510-P13-003	0-N068
14510-P2A-003	0-N978
14510-P2A-004	0-N978
14510-P2A-J01	0-N978
14510-P30-003	0-N979
14510-P5T-G00	0-N236
14510-PC0-005	0-N067
14510-PC6-013	0-N981
14510-PD2-003	0-N981
14510-PD2-004	0-N981

HONDA

14510-PE0-003	0-N926
14510-PE0-005	0-N926
14510-PG6-013	0-N066
14510-PH1-003	0-N981
14510-PH1-004	0-N981
14510-PH3-003	0-N982
14510-PH3-004	0-N982
14510-PH7-003	0-N928
14510-PH7-004	0-N928
14510-PK1-004	0-N982
14510-PK1-014	0-N982
14510-PLC-034	0-N1330
14510-PLC-315	0-N1330
14510-PM7-003	0-N927
14510-PM7-004	0-N927
14510-PR3-003	0-N979
14510-PR3-004	0-N979
14510-PT0-002	0-N905
14510-PT0-003	0-N905
14510-PT0-004	0-N905
14510-PY3-003	0-N969
14510-PY3-004	0-N969
14520-P2A-305	0-N978
14520-P2A-306	0-N978
14520-P5T-G00	0-N237
14520-PLC-305	0-N1330
14520-PLC-325	0-N1330
14520-PLC-335	0-N1330
14520-PLZ-D00	0-N878
14530-PLZ-D00	0-N1085
31160-PLZ-D00	0-N1798
31160-PLZ-D00	0-N1798S
31170-PCX-003	0-N2398
31170-PCX-003	0-N2398S
31170-PNA-003	0-N1850
31170-PNA-003	0-N1850S
31170-PNA-013	0-N1850
31170-PNA-013	0-N1850S
31170-PNA-023	0-N1850
31170-PNA-023	0-N1850S
31170-PND-003	0-N1812
31170-PND-003	0-N1812S
31170-PND-013	0-N1812
31170-PND-013	0-N1812S
31170-R40-A01	0-N2399
31170-R40-A01	0-N2399S
31170-R40-A02	0-N2399
31170-R40-A02	0-N2399S
31170-R70-A01	0-N2251
31170-R70-A01	0-N2251S1
31170-R70-A01	0-N2251S2
31170-R70-A010	0-N2251

HONDA

31170-R70-A010	0-N2251S1
31170-R70-A010	0-N2251S2
31170-RAA-A01	0-N1850
31170-RAA-A01	0-N1850S
31170-RAA-A02	0-N1850
31170-RAA-A02	0-N1850S
31170-RB0-J01	0-N2210
31170-RB0-J01	0-N2210S
31170-RBD-E01	0-N2103
31170-RBD-E01	0-N2103S
31170-RBD-E02	0-N2103
31170-RBD-E02	0-N2103S
31170-RBJ-003	0-N2267
31170-RBJ-003	0-N2267S
31170-RL0-G01	0-N2400
31170-RL0-G01	0-N2400S
31170-RLF-J01	0-N2399
31170-RLF-J01	0-N2399S
31170-RNA-A01	0-N1851
31170-RNA-A01	0-N1851S
31170-RNA-A02	0-N1851
31170-RNA-A02	0-N1851S
31170-RNA-A03	0-N1851
31170-RNA-A03	0-N1851S
31170-RNA-A11	0-N1851
31170-RNA-A11	0-N1851S
31170-RNA-G01	0-N1851
31170-RNA-G01	0-N1851S
31170-RNA-G02	0-N1851
31170-RNA-G02	0-N1851S
31170-RNA-G11	0-N1851
31170-RNA-G11	0-N1851S
31170-RSJ-E01	0-N2210
31170-RSJ-E01	0-N2210S
31170-RWK-005	0-N2158
31170-RWK-005	0-N2158S
31170-RWK-015	0-N2158
31170-RWK-015	0-N2158S
31170-RWK-025	0-N2158
31170-RWK-025	0-N2158S
31170-RWK-A005	0-N2158
31170-RWK-A005	0-N2158S
31170-RZP-AG01	0-N2158
31170-RZP-AG01	0-N2158S
31170-RZP-G01	0-N2158
31170-RZP-G01	0-N2158S
31170-RZP-G02	0-N2158
31170-RZP-G02	0-N2158S
31170-RZP-G03	0-N2158
31170-RZP-G03	0-N2158S
31170-RZP-G04	0-N2158
31170-RZP-G04	0-N2158S

HONDA

31180-PNA-003	0-N2207
31180-PNA-J01	0-N2207
31190-PRA-000	0-N2033
31190-PRA-400	0-N2033
31190-RBA-000	0-N2033
31190-RL2-G01	0-N2123
31190-RNA-003	0-N2123
31190-RRA-A00	0-N2033
38942-P01-003	0-N2101
38942-P01-003	0-N2102
38942-P2K-T01	0-N2102
38942-P3F-003	0-N2102
38942-P72-000	0-N2102
38942-PHM-004	0-N1852
38942-PM3-000	0-N2100
38942-PM3-000	0-N2102
38942-PWA-004	0-N1852
38942-PZA-003	0-N2102
38950-P2K-305	0-N2101
38950-P2K-305	0-N2102
38950-P3F-305	0-N2102
56900-P5T-G05	0-N1535
56900-P5T-G05	0-N1535S
56910-P5T-G00	0-N1535
56910-P5T-G00	0-N1535S

HYUNDAI

0K551-12730A	0-N1375
0K551-12-730A	0-N1375
0K88R-12700	0-N1760
0K88R-12-750	0-N1550
0K88R-15-981	0-N1467S
0K88R-15-983	0-N1389
23357-32000	0-N183
23357-32010	0-N183
23357-32020	0-N183
23357-32030	0-N183
23357-32040	0-N183
23357-32050	0-N186
2335733120	0-N179
2335733130	0-N179
23357-33350	0-N1127
23357-38001	0-N1127
23357-42010	0-N184
23357-42020	0-N184
23357-42030	0-N184
24317-42000	0-N061
24317-42010	0-N061
24317-42020	0-N061
24317-4X000	0-N1375
24317-4X001	0-N1375
24322-4X000	0-N1760
24410-02510	0-N1366



HYUNDAI		HYUNDAI		HYUNDAI		ISUZU	
24410-02550	0-N1366	24810-35500	0-N189	25281-3E-000	0-N2231S	8-9422-0900-1	0-N047
2441021010	0-N986	24810-35510	0-N189	25281-3E-010	0-N2231	8-94220-900-2	0-N047
2441021014	0-N986	24810-35530	0-N189	25281-3E-010	0-N2231S	8-94364-816-1	0-N1768
24410-22000	0-N975	2481037100	0-N1576	25281-4A-000	0-N1552	8-94382-214-0	0-N049
24410-22020	0-N975	2481037120	0-N1576	25281-4A-000	0-N1552S	8-94382-215-1	0-N050
24410-23011	0-N1561	24810-38001	0-N055	25281-4A-010	0-N1552	8-94386-488-0	0-N2167
24410-23-050	0-N1619	24810-39810	0-N189	25281-4A-010	0-N1552S	8-94386-488-1	0-N2167
24410-23400	0-N1561	24840-3E000	0-N2326	252814X000	0-N1467S	8-94386-488-2	0-N2167
24410-23500	0-N1561	24840-3E500	0-N2326	252814X100	0-N1467S	8-94433-820-0	0-N050
24410-26-000	0-N975	25281-25-000	0-N2108	25286-2B-000	0-N1987	8-94472-349-0	0-N045
24410-27-000	0-N1499	25281-25-000	0-N2108S	25286-2B-010	0-N1987	8-94472-349-1	0-N045
24410-27-000	0-N1499S	25281-27000	0-N1815	25286-37-100	0-N1678	8-97010-530-1	0-N910
24410-27-250	0-N1499	25281-27000	0-N1815S	25286-37110	0-N1678	8-97112-438-0	0-N126
24410-27-250	0-N1499S	25281-27001	0-N1815	25286-3C-100	0-N1990	8-97114-552-0	0-N126
2441032000	0-N059	25281-27001	0-N1815S	25286-3C200	0-N1990	8-97116-002-0	0-N1768
2441032010	0-N059	25281-27010	0-N1815	25286-3C250	0-N1990	8-97129-939-1	0-N878
2441032020	0-N059	25281-27010	0-N1815S	252864X000	0-N1389	8-97136-256-0	0-N1765
2441032553	0-N063	25281-27060	0-N1815	25287-25000	0-N2021	8-97137-148-0	0-N2168
2441032554D	0-N063	25281-27060	0-N1815S	25287-25-000	0-N2021	8-97146-877-0	0-N1765S
2441032560	0-N063	25281-27400	0-N1815	25287-25010	0-N2021	8972220211	0-N1685
24410-33101	0-N1971	25281-27400	0-N1815S	25287-25-010	0-N2021	8972220214	0-N1685
24410-33180	0-N1971	25281-27401	0-N1815	25287-25100	0-N2021	8-97249-944-1	0-N1085
24410-33190	0-N1971	25281-27401	0-N1815S	25287-25-100	0-N2021	8-97249-945-0	0-N1085
24410-33344	0-N1971	25281-2A-000	0-N1813	25287-25110	0-N2021	8-97250-750-1	0-N1649
2441035010	0-N064	25281-2A-000	0-N1813S	25287-27000	0-N1547	8972521881	0-N1685
2441035020	0-N064	25281-2A-100	0-N1813	25287-27001	0-N1547	8973008570	0-N1685
2441035060	0-N064	25281-2A-100	0-N1813S	25287-27400	0-N1547	8-97309-459-1	0-N878
24410-37100	0-N2428	25281-2A200	0-N2214	25287-2A000	0-N2375	8-97312-462-0	0-N1717
24410-38-001	0-N1583	25281-2A200	0-N2214S	25287-2A010	0-N2429	8-97312-462-0	0-N1717S
24410-3E100	0-N2416	25281-2A650	0-N2214	25287-2A100	0-N2375	8-97383-061-1	0-N1717
24410-3E500	0-N2416	25281-2A650	0-N2214S	25287-2A110	0-N2429	8-97383-061-1	0-N1717S
24450-33010	0-N054	25281-2A850	0-N2214	25287-2A800	0-N2375	9-41239-72	0-N046
24450-33020	0-N054	25281-2A850	0-N2214S	25287-2F000	0-N2248	IVECO	
24450-35510	0-N185	25281-2B000	0-N2202	25287-57060	0-N2377	2992484	0-N816
24450-35530	0-N185	25281-2B000	0-N2202S	25288-27-000	0-N1814	4740847	0-N821
2445037100	0-N1577	25281-2B010	0-N2202	25288-27-001	0-N1814	500332622	0-N1480S
2445037120	0-N1577	25281-2B010	0-N2202S	25288-2A800	0-N2429	500388688	0-N1352
24450-38001	0-N1498	25281-2B020	0-N2202	25288-2F-000	0-N2249	5040 84453	0-N1711S
24450-38010	0-N1498	25281-2B020	0-N2202S	28287-2A600	0-N2375	5040 86751	0-N1483
24450-38011	0-N1498	25281-2F-000	0-N2247	28288-2A600	0-N2429	5040 86751	0-N1483S
24450-39810	0-N185	25281-2F-000	0-N2247S	57212-3A000	0-N1853	504000412	0-N1597
24810-23011	0-N1374	25281-35010	0-N1521	97834-22100	0-N1854	504086948	0-N1714
24810-23-050	0-N1374	25281-35020	0-N1521	97834-29000	0-N1854	504086948	0-N1714S
24810-23400	0-N1374	25281-35050	0-N1521	97834-29010	0-N1854	504183759	0-N1351
24810-23-500	0-N1374	25281-35060	0-N1521	97834-2D520	0-N1854	98463114	0-N816
24810-26010	0-N1370	25281-37101	0-N1677	ISUZU		99432547	0-N816
24810-26020	0-N1370	25281-37101	0-N1677S	5-12539-013-2	0-N048	JAGUAR	
24810-27-000	0-N1500	25281-37120	0-N1677	586000126	0-N178	AJ88003	0-N2281
24810-27-200	0-N1500	25281-37120	0-N1677S	5-86000-146-0	0-N905	AJ88003	0-N2281S
24810-27-250	0-N1500	25281-3C-100	0-N2250	8-94123-972-0	0-N046	C2C36146	0-N2281
24810-33021	0-N055	25281-3C-100	0-N2250S	8-94215-197-0	0-N042	C2C36146	0-N2281S
24810-33024	0-N055	25281-3E-000	0-N2231	8-94215-197-1	0-N042	C2S11662	0-N2281

JAGUAR		KIA		KIA		KIA	
C2S11662	0-N2281S	0K937-12-700A	0-N069	25281-27-400	0-N1815	25288-27-001	0-N1814
C2S45579	0-N2281	0K937-12-730	0-N070	25281-27-400	0-N1815S	25288-2A-800	0-N2429
C2S45579	0-N2281S	0K938-12-700	0-N069	25281-27-401	0-N1815	25288-2F-000	0-N2249
JEEP		0K938-12-730	0-N070	25281-27-401	0-N1815S	28287-2A-600	0-N2375
048 91659 AA	0-N2397	0K95K-12-750	0-N1581	25281-2A-000	0-N1813	28288-2A-600	0-N2429
048 91659 AA	0-N2397S	0K95K-12-770	0-N1826	25281-2A-000	0-N1813S	KK150-12-700A	0-N983
05142798AA	0-N1612	0K9BV-10-730A	0-N1856	25281-2A-100	0-N1813	KK150-12-700B	0-N983
4781569AA	0-N1962	0K9BV-10-730A	0-N1856S	25281-2A-100	0-N1813S	LHB10-16-30	0-N1261
4781569AB	0-N1962	0K9BV-10-770	0-N1855	25281-2A200	0-N2214	MB630-12-700E	0-N983
4781570AB	0-N1838S	0K9BV-10-770	0-N1855S	25281-2A200	0-N2214S	LADA	
4792835AA	0-N1686	0K9BV-12-730	0-N1582	25281-2A650	0-N2214	1041056-10-0	0-N1450
4861277AB	0-N2406	0K9BV-12-780	0-N1580	25281-2A650	0-N2214S	2105.100.6118	0-N912
4861277AB	0-N2406S	0K9BV-12-790	0-N1579	25281-2A850	0-N2214	2105.100.6124	0-N912
4891659AA	0-N2397	24410-23-050	0-N1619	25281-2A850	0-N2214S	21051006124	0-N912
4891659AA	0-N2397S	24410-26-000	0-N975	25281-2B-000	0-N2202	2108.100.6120	0-N1917
5010371AA	0-N2059	24410-27-000	0-N1499	25281-2B-000	0-N2202S	21080100612000	0-N1917
5066826AA	0-N1612	24410-27-000	0-N1499S	25281-2B-010	0-N2202	21080100612001	0-N1917
5142798AA	0-N1612	24410-27-250	0-N1499	25281-2B-010	0-N2202S	21081006120	0-N1917
53010158	0-N1839	24410-27-250	0-N1499S	25281-2B-020	0-N2202	211161006238	0-N2376
53010158	0-N1839S	24410-2X-000	0-N983	25281-2B-020	0-N2202S	21116-1006238	0-N2376
53013366AA	0-N1695	24410-2X-700	0-N069	25281-2F-000	0-N2247	2112.100.6120	0-N1911
53030958AC	0-N2257	24410-2X-701	0-N069	25281-2F-000	0-N2247S	2112.100.6135	0-N1914
53030958AC	0-N2257S1	24410-37100	0-N2428	25281-3C-100	0-N2250	21120100612001	0-N1911
53030958AC	0-N2257S2	24410-38-001	0-N1583	25281-3C-100	0-N2250S	211201006135	0-N1914
68027647AA	0-N2238	24410-3E100	0-N2416	25281-3E-000	0-N2231	21120100613500	0-N1914
68031478AA	SK-1734	24410-3E500	0-N2416	25281-3E-000	0-N2231S	21120100613501	0-N1914
68045800AA	0-N2257	24450-2Y-000	0-N1373	25281-3E-010	0-N2231	2112100611001	0-N1911
68045800AA	0-N2257S1	24450-35-510	0-N185	25281-3E-010	0-N2231S	21121006120	0-N1911
68045800AA	0-N2257S2	24450-35-530	0-N185	25281-4A-000	0-N1552	2112100612001	0-N1911
71754559	SK-1586	24450-39-810	0-N185	25281-4A-000	0-N1552S	21121006135	0-N1914
KIA		24450-3Y-100	0-N1580	25281-4A-010	0-N1552	2112100613501	0-N1914
0JE26-12-740A	0-N088	24450-3Y-200	0-N1579	25281-4A-010	0-N1552S	2112-1006135-02	0-N1914
0K054-12-700	0-N1948	24810-23-050	0-N1374	25286-2B-000	0-N1987	21126-1006135	0-N2044
0K054-12-700A	0-N1948	24810-23-500	0-N1374	25286-2B-010	0-N1987	21126-1006135-00	0-N2044
0K247-12-700	0-N1373	24810-27-000	0-N1500	25286-37-100	0-N1678	211261006238	0-N2056
0K551-12-700B	0-N1759	24810-27-200	0-N1500	25286-3C-100	0-N1990	21126-1006238	0-N2056
0K551-12-730A	0-N1375	24810-27-250	0-N1500	25286-4A-000	0-N1553	21126100623800	0-N2056
0K551-12-740A	0-N1376	24810-2X-700	0-N070	25287-25-000	0-N2021	21126-1006238-00	0-N2056
0K551-15-981A	0-N1551	24810-35-530	0-N189	25287-25-010	0-N2021	21215-1006120	0-N813
0K551-15-981A	0-N1551S	24810-39-810	0-N189	25287-25-100	0-N2021	21215-1006138	0-N814
0K551-15-981B	0-N1551	24840-3E000	0-N2326	25287-25-110	0-N2021	2123-1041056-10	0-N1450
0K551-15-981B	0-N1551S	24840-3E500	0-N2326	25287-27-000	0-N1547	LANCIA	
0K552-15-983C	0-N1389	25281-25-000	0-N2108	25287-27-001	0-N1547	46442999	0-N1407
0K552-15-P13	0-N1988	25281-25-000	0-N2108S	25287-27-400	0-N1547	46442999	0-N1407S
0K88R-12700	0-N1760	25281-27-000	0-N1815	25287-2A-000	0-N2375	46524692	0-N1407
0K88R-12-700	0-N1760	25281-27-000	0-N1815S	25287-2A-010	0-N2429	46524692	0-N1407S
0K88R-12-730	0-N1375	25281-27-001	0-N1815	25287-2A-100	0-N2375	46537101	0-N1450
0K88R-12-740	0-N1376	25281-27-001	0-N1815S	25287-2A-110	0-N2429	46546374	0-N1487
0K88R-12-750	0-N1550	25281-27-010	0-N1815	25287-2A-800	0-N2375	46546374	0-N1487S
0K88R-15-981	0-N1467S	25281-27-010	0-N1815S	25287-2F-000	0-N2248	46547564	0-N1596
0K88R-15-983	0-N1389	25281-27-060	0-N1815	25287-57060	0-N2377	46742968	0-N1398
0K933-12-730	0-N070	25281-27-060	0-N1815S	25288-27-000	0-N1814	46754624	0-N1481



LANCIA

46754624	0-N1481S
51800046	0-N2122
55180011	0-N1487
55180011	0-N1487S
55183527	0-N115
55191315	0-N115
55192239	0-N114
55192323	0-N115
55192773	0-N196
55208381	0-N115
55215666	0-N115
55238027	0-N115
60596372	0-N114
60604903	0-N1595
60604903	0-N1595S
60624147	0-N1595
60624147	0-N1595S
60813418	0-N1407
60813418	0-N1407S
60813592	0-N115
60813774	0-N1894
60814110	0-N1407
60814110	0-N1407S
60815188	0-N1487
60815188	0-N1487S
71736493	0-N950
71736717	SK-1412
71736718	SK-1418
71736719	SK-1421
71736722	SK-1637
71736723	SK-1446
71736724	SK-1410
71736726	SK-1629
71736727	SK-1361
71736793	0-N950
71736795	SK-1112
71739304	0-N1588
71739304	0-N1588S
71746353	SK-1421
71747798	0-N1487
71747798	0-N1487S
71747799	0-N115
71754558	SK-1367
71754559	SK-1586
71754561	SK-1677
71754562	SK-1693
71754563	SK-1586
71754843	SK-1411
71754845	SK-1033
71771575	SK-1412AQ2
73502730	0-N1481
73502730	0-N1481S

LANCIA

7596728	0-N835
7763644	0-N950
7772961	0-N196
7778565	0-N115
7798333	0-N1407
7798333	0-N1407S
9400830379	0-N862
9400831069	SK-1019
9400831119	SK-1017
9400831409	SK-1085
9400831489	SK-1082
9400831529	SK-1017
9400831559	SK-1482
9400831609	SK-1394
9400831629	SK-1085
9400831739	SK-1534
9400831789	SK-1085
9400831829	SK-1085
9400831889	SK-1482
9400831929	SK-1594
9405751819	0-N1747
9467516789	SK-1483
9467544580	SK-1614
9467582689	SK-1692
9467626480	SK-1085
9467626880	SK-1534
9467628080	SK-1482
9467628180	SK-1594
9467628980	SK-1085
96 20 038 880	0-N1757
96 35 638 380	0-N1449
9623001280	0-N1472
9623001280	0-N1472S
9623659880	0-N1747
9625621780	0-N1713
9625621880	0-N1722
9626365280	0-N1484
9626365280	0-N1484S
9632155180	0-N1747
9633056680	0-N1747
9633315180	0-N1748
9634465780	0-N1493
9634465780	0-N1493S
9636355180	0-N1493
9636355180	0-N1493S
9653522380	0-N1493
9653522380	0-N1493S
9660484680	0-N2046
9660484680	0-N2046S
K68027611AA	0-N2329
K68027611AB	0-N2329

LAND ROVER

LAND ROVER

1324388	SK-1742
ERR2798	0-N2054
ERR3440	0-N2053
ERR3440	0-N2053S
ERR7298	0-N2054
LHB10-16-30	0-N1261
LHP 10015L	0-N894
LHP10015L	0-N894
LHP100550L	0-N1273
LHP100680	0-N1256
LHP100840	0-N1120
LHP100840A	0-N1120
LHP100860	0-N1256
LHP100900L	0-N1272
LHV100150	0-N1239
LR000660	0-N1334
LR003651	0-N2116
LR003651	0-N2116S
LR004667	0-N2242
LR004667	0-N2242S
LR004877	0-N1963
LR006076	0-N2243
LR009395	0-N2018
LR016655	SK-1742
PQG 500030	0-N2281
PQG 500030	0-N2281S
PQG100141L	0-N1742
PQG100141L	0-N1742S
PQG100180	0-N1643
PQG100180	0-N1643S
PQG100190L	0-N1659
PQG100190L	0-N1659S
PQG100340L	0-N1514
PQG100340L	0-N1514S
PQR000080	0-N1834
PQR000080	0-N1834S
PQR100780L	0-N1735
PQR500230	0-N2277
PQR500350	0-N2277
PQS101710	0-N1900
PQS101710L	0-N1900
PRF100060L	0-N1396

LEXUS

13503-50010	0-N2058
13503-50011	0-N2058
13505-46031	0-N1549
13505-46041	0-N1549
13505-50010	0-N2319
13505-50021	0-N2319
13505-50022	0-N2319
13505-50030	0-N1883
13505-50030	0-N1883S

LEXUS

16603-0R010	0-N2040
16604-26010	0-N2051
16604-26011	0-N2051
16604-31010	0-N1728
16604-31020	0-N1728
16620-0W026	0-N1877
16620-0W026	0-N1877S
88440-20170	0-N1725

LOTUS

A111E6117S	0-N894
A132E6261S	0-N1728
A132E6263S	0-N2032
A132E6263S	0-N2032S

MAN

51.95800-7485	0-N171
---------------	--------

MAZDA

1A00-12-700	0-N2322
1E03-15-930A	0-N1385
1E05-12-730	0-N1260
1E06-12-700	0-N294
1E06-12-700A	0-N294
1E06-12-700B	0-N294
1E06-15-980	0-N1897
1E06-15-980	0-N1897S
1E07-12-700A	0-N089
1E07-12-700B	0-N089
1E07-12-720	0-N915
1E07-23-951	0-N902
1E07-23-951A	0-N902
1E07-23-951B	0-N902
1E07-23-951C	0-N902
1E10-12-700	0-N294
1E10-12-700A	0-N294
1E10-12-700C	0-N294
1E12-15-930	0-N2022
1E12-15-930	0-N2022S
1E12-15-930A	0-N2022
1E12-15-930A	0-N2022S
1E12-23-951	0-N902
B630-12-700B	0-N983
B630-12-700C	0-N983
B630-12-700D	0-N983
B630-12-700E	0-N983
B631-12-700C	0-N983
B660-12-700A	0-N069
B660-12-700B	0-N069
B660-12-700C	0-N069
B660-12-700D	0-N069
B660-12-700E	0-N069
B660-12-700F	0-N069
B660-12-730B	0-N070
B660-12-730C	0-N070

MAZDA		MAZDA		MAZDA		MAZDA	
C201-12-500	0-N294	L372-15-980B	0-N2034	RF2A-12-770A	0-N1936	Z60115940	0-N2286
C201-12-500A	0-N294	L372-15-980B	0-N2034S	RF2A-12-770B	0-N1936	Z601-15-940	0-N2286
C201-12-500B	0-N294	L372-15-980C	0-N2034	RF5C-12-700	0-N1378	Z601-15-980C	0-N2394
C401-12-500	0-N1564	L372-15-980C	0-N2034S	RF5C-12-730	0-N1377	Z601-15-980C	0-N2394S
F801-12-700C	0-N071	L372-15-980M	0-N2104	RF5C15940A	0-N2311	Z601-15-980D	0-N2394
F805-12-700	0-N072	L372-15-980M	0-N2104S	RF5C-15-940A	0-N2311	Z601-15-980D	0-N2394S
F805-12-700A	0-N072	L51015930A	0-N2302S	RF5D-15-940A	0-N2244	ZJ01-15-980B	0-N2104
F805-12-700C	0-N072	LF17-15-980A	0-N1811	RF5G-15-980A	0-N2114	ZJ01-15-980B	0-N2104S
F806-12-700	0-N072	LF17-15-980A	0-N1811S	RF5G-15-980A	0-N2114S	ZJ01-15-980C	0-N2104
FE1H-12-700A	0-N073	LF17-15-980B	0-N1811	RF71-12-700C	0-N083	ZJ01-15-980C	0-N2104S
FE1H-12-730	0-N074	LF17-15-980B	0-N1811S	RF71-12-730A	0-N084	ZJ01-15-980D	0-N2104
FE1H-12-730A	0-N074	LF17-15-980C	0-N1811	RF7J-15-980	0-N2113	ZJ01-15-980D	0-N2104S
FE3N-12-730	0-N075	LF17-15-980C	0-N1811S	RF7J-15-980	0-N2113S	ZJ38-15-980B	0-N2035
FP01-12-700	0-N076	LF17-15-980D	0-N1811	RF8D-15-980	0-N2113	ZJ38-15-980B	0-N2035S
FP01-12-700A	0-N076	LF17-15-980D	0-N1811S	RF8D-15-980	0-N2113S	ZJ38-15-980C	0-N2035
FP05-12-700A	0-N076	LF17-15-980E	0-N1811	RFC6-12-700	0-N083	ZJ38-15-980C	0-N2035S
FP05-12-700B	0-N076	LF17-15-980E	0-N1811S	WE01-12-730	0-N1666		
FS01-12-700A	0-N078	LF50-15-980	0-N1639	WL01-12-700	0-N1824	MERCEDES-BENZ	
FS01-12-700B	0-N078	LF50-15-980	0-N1639S	WL81-12-700	0-N2225	000 202 00 19	0-N1431
FS01-12-730A	0-N077	LF50-15-980A	0-N1639	Y401-12-730	0-N1066	000 202 03 19	0-N2131
FS05-12-700A	0-N078	LF50-15-980A	0-N1639S	Y401-12-730	0-N2382	000 202 04 19	0-N1680
JE15-12-730A	0-N086	LF50-15-980B	0-N1639	Y401-12-770	0-N1062	000 202 07 19	0-N2131
JE15-12-730B	0-N086	LF50-15-980B	0-N1639S	Y401-12-770A	0-N1062	000 202 08 19	0-N2131
JE15-12-730C	0-N086	LFG1-15-980B	0-N1858	Y401-12-770B	0-N1062	000 202 09 19	0-N1431
JE15-12-730D	0-N2383	LFG1-15-980B	0-N1858S	Y401-12-770C	0-N1062	000 202 16 19	0-N2120
JE15-12-750	0-N085	LFG1-15-980C	0-N1858	Y401-12-770D	0-N1062	000 202 17 19	0-N2119
JE15-12-750A	0-N085	LFG1-15-980C	0-N1858S	Y401-15-930	0-N1420	102 200 04 14	0-N2145
JE26-12-740	0-N088	LFH1-15-940	0-N1859	Y401-15-980A	0-N1636	102 200 07 14	0-N2145
JE26-12-740A	0-N088	LFH1-15-940A	0-N1859	Y401-15-980A	0-N1636S	102 200 08 14	0-N2144
JE26-12-750	0-N087	LFY1-15-980	0-N1639	Y401-15-980B	0-N1636	102 200 12 14	0-N2144
JE48-12-730	0-N091	LFY1-15-980	0-N1639S	Y401-15-980B	0-N1636S	102 200 12 70	0-N1013
JE48-12-740	0-N090	PN11-12-700	0-N180	Y401-15-980C	0-N1636	102 200 12 70	0-N1013S
JF01-12-730	0-N086	R201-12-700A	0-N092	Y401-15-980C	0-N1636S	102 200 14 14	0-N2144
JF01-12-730A	0-N086	R2AA-15-980B	0-N2395	Y601-15-980	0-N1339	102 200 15 14	0-N2145
JF01-12-730B	0-N086	R2AA-15-980B	0-N2395S	Y601-15-980	0-N1339S	102 200 33 70	0-N1013
JF01-12-730D	0-N086	R2AA-15-980C	0-N2395	Y601-15-980	0-N1339S	102 200 33 70	0-N1013S
JF01-12-750E	0-N085	R2AA-15-980C	0-N2395S	Y602-15-940	0-N1418	102 200 34 70	0-N1013
JF01-12-750F	0-N085	R2AA-15-980D	0-N2395	Y602-15-940A	0-N1418	102 200 34 70	0-N1013S
JF01-12-770B	0-N2159	R2AA-15-980D	0-N2395S	Y602-15-980	0-N1339	102 200 60 70	0-N1013
K805-1594X-A	0-N2024	R2AA-15-980D	0-N2395S	Y602-15-980	0-N1339S	102 200 60 70	0-N1013S
K805-15-94YA	0-N2041	R2AC-15-980B	0-N2395	Y650-12-730	0-N2382	102 200 66 70	0-N1013
K805-1594Y-B	0-N2041	R2AC-15-980B	0-N2395S	Y650-12-730A	0-N2382	102 200 66 70	0-N1013S
KL01-12-730A	0-N080	R2AC-15-980C	0-N2395	Y650-12-770	0-N2224	102 200 69 70	0-N1013
KL01-12-740	0-N081	R2AC-15-980C	0-N2395S	Y701-12-700A	0-N126	102 200 69 70	0-N1013S
KL01-12-770B	0-N2160	R2AC-15-980D	0-N2395	Y701-12-730	0-N878	102 200 77 70	0-N1625
KL02-12-750	0-N079	R2AC-15-980D	0-N2395S	YF09-12-700	0-N1778	102 200 77 70	0-N1625S
KLY2-12-SJ0	0-N079	RF03-12-700A	0-N082	YF09-12-730	0-N291	103 200 01 14	0-N2146
L327-15-940A	0-N1859	RF03-12-720	0-N027	YF09-15-930A	0-N1686	103 200 04 70	0-N1011
L372-15-980	0-N2034	RF1G-12-700	0-N1825	YF09-15-930A	0-N1716	103 200 04 70	0-N1011S
L372-15-980	0-N2034S	RF1G-12-700A	0-N1825	YF09-15-930B	0-N1686	103 200 05 70	0-N1278
L372-15-980A	0-N2034	RF1G-12-730	0-N1816	YF09-15-980	0-N1435	103 200 06 70	0-N1011
L372-15-980A	0-N2034S	RF2A-12-700	0-N1379	YF09-15-980	0-N1435S	103 200 06 70	0-N1011S
L372-15-980A	0-N2034S	RF2A-12-730	0-N1578	Z501-12-730	0-N1380	103 200 07 70	0-N1011



MERCEDES-BENZ

103 200 07 70	0-N1011S
103 200 08 70	0-N1011
103 200 08 70	0-N1011S
103 200 09 28	0-N1279
103 200 11 28	0-N1279
103 200 17 28	0-N1279
103 200 18 28	0-N1279
104 200 04 28	0-N1281
104 200 04 70	0-N1280
104 200 05 28	0-N1281
104 200 08 70	0-N1282
104 200 10 70	0-N1283
104 200 13 28	0-N1284
104 200 15 28	0-N1285
104 200 20 28	0-N1286
104 200 21 28	0-N1287
111 200 00 70	0-N1833
111 200 02 14	0-N1951
111 200 04 14	0-N1951
111 200 06 70	0-N1703
111 200 07 70	0-N1703
111 200 12 70	0-N1703
111 200 13 70	0-N2148
111 202 01 19	0-N1442
111 990 03 05	0-N1703
112 200 00 14	0-N2142
112 200 00 70	0-N1645
112 200 00 70	0-N1645S
112 200 01 70	0-N1645
112 200 01 70	0-N1645S
112 200 03 70	0-N1645
112 200 03 70	0-N1645S
112 200 06 70	0-N1645
112 200 06 70	0-N1645S
112 200 08 70	0-N1645
112 200 08 70	0-N1645S
112 200 09 70	0-N1645
112 200 09 70	0-N1645S
119 200 03 70	0-N1862
119 200 04 70	0-N1864
119 200 11 70	0-N1860
119 200 14 70	0-N2141
120 200 04 70	0-N1861
130 708 04 7R	0-N2423
137 202 01 19	0-N1560
160 200 03 70	0-N2020
166 200 06 70	0-N1946
166 200 06 70	0-N1946S1
166 200 06 70	0-N1946S2
166 200 09 70	0-N1946
166 200 09 70	0-N1946S1
166 200 09 70	0-N1946S2

MERCEDES-BENZ

166 202 00 19	0-N1723
166 202 01 19	0-N1395
166 202 02 19	0-N1388
166 202 03 19	0-N1723
166 202 04 19	0-N1395
166 202 05 19	0-N1388
166 202 06 19	0-N1388
166 202 07 19	0-N1723
166 202 08 19	0-N1395
266 200 06 70	0-N2246
266 200 06 70	0-N2246S1
266 200 06 70	0-N2246S2
266 200 06 70	0-N2246S3
266 200 07 70	0-N2401
266 200 07 70	0-N2401S1
266 200 07 70	0-N2401S2
266 200 09 70	0-N2246
266 200 09 70	0-N2246S1
266 200 09 70	0-N2246S2
266 200 09 70	0-N2246S3
266 200 11 70	0-N2401
266 200 11 70	0-N2401S1
266 200 11 70	0-N2401S2
266 202 00 19	0-N1395
266 202 04 19	0-N2367
271 200 02 70	0-N1587
271 200 02 70	0-N1587S
271 200 04 70	0-N2136
271 200 04 70	0-N2136S
271 200 05 70	0-N2206
271 206 00 19	0-N1457
272 200 00 70	0-N1670
272 200 00 70	0-N1670S
272 200 01 14	0-N2143
272 200 02 70	0-N1670
272 200 02 70	0-N1670S
272 202 01 19	0-N1746
272 202 02 19	0-N1746
272 202 04 19	0-N2138
272 202 06 19	0-N2138
272 202 07 19	0-N2138
272 202 08 19	0-N1637
272 202 10 19	0-N1637
272 202 14 19	0-N2138
274 200 00 70	0-N2309
274 200 00 70	0-N2309S
274 200 02 70	0-N2309
274 200 02 70	0-N2309S
274 200 04 70	0-N2309
274 200 04 70	0-N2309S
274 200 06 70	0-N2309
274 200 06 70	0-N2309S

MERCEDES-BENZ

274 202 00 19	0-N2310
276 200 01 70	0-N2403
276 200 01 70	0-N2403S
276 200 03 70	0-N2403
276 200 03 70	0-N2403S
276 202 01 19	0-N2368
278 202 05 19	0-N2284
601 200 03 14	0-N1926
601 200 05 14	0-N1926
601 200 07 70	0-N847
601 200 09 70	0-N846
601 200 10 70	0-N1288
601 200 12 70	0-N1452
601 200 17 73	0-N1289
601 981 00 27	0-N565592
603 200 01 14	0-N1926
603 200 03 14	0-N1926
603 200 06 14	0-N2147
604 200 01 14	0-N1926
604 200 02 14	0-N2147
604 200 03 14	0-N1926
606 200 00 73	0-N1043
606 200 01 73	0-N1043
607 200 00 70	0-N2290
607 200 00 70	0-N2290S
607 200 02 70	0-N2253
607 993 03 97	SK-1730
611 200 02 70	0-N1641
611 200 02 70	0-N1641S
611 200 03 70	0-N1641
611 200 03 70	0-N1641S
611 200 04 70	0-N1641
611 200 04 70	0-N1641S
611 200 05 70	0-N1641
611 200 05 70	0-N1641S
611 200 06 70	0-N1489S
611 234 00 93	0-N1436
611 234 00 93	0-N1436S
611 234 01 93	0-N1437
611 234 02 93	0-N1437
611 234 03 93	0-N1436
611 234 03 93	0-N1436S
628 200 01 70	0-N2193
628 200 01 70	0-N2193S
628 202 00 19	0-N2218
640 200 18 70	0-N2245
640 200 18 70	0-N2245S1
640 200 18 70	0-N2245S2
640 200 18 70	0-N2245S3
640 200 23 70	0-N2245
640 200 23 70	0-N2245S1
640 200 23 70	0-N2245S2

MERCEDES-BENZ

640 200 23 70	0-N2245S3
640 200 26 70	0-N2245
640 200 26 70	0-N2245S1
640 200 26 70	0-N2245S2
640 200 26 70	0-N2245S3
640 200 27 70	0-N2245
640 200 27 70	0-N2245S1
640 200 27 70	0-N2245S2
640 200 27 70	0-N2245S3
640 200 33 70	0-N2245
640 200 33 70	0-N2245S1
640 200 33 70	0-N2245S2
640 200 33 70	0-N2245S3
640 202 03 19	0-N1723
640 202 04 19	0-N1397
642 200 00 70	0-N1902
642 200 00 70	0-N1902S
642 200 04 70	0-N2219
642 200 04 70	0-N2219S
642 200 05 70	0-N2132
642 200 06 70	0-N2227
642 200 07 70	0-N1710
642 200 07 70	0-N1710S
642 200 09 70	0-N1560
642 200 10 70	0-N1560
642 200 11 70	0-N1710
642 200 11 70	0-N1710S
642 200 13 70	0-N1902
642 200 13 70	0-N1902S
642 200 14 70	0-N2219
642 200 14 70	0-N2219S
642 200 15 70	0-N2241
642 200 15 70	0-N2241S
642 200 16 70	0-N1710
642 200 16 70	0-N1710S
642 200 19 70	0-N2293
642 200 19 70	0-N2293S
642 200 23 70	0-N1560
642 200 25 70	0-N1560
646 200 00 70	0-N1489S
646 200 02 70	0-N1641
646 200 02 70	0-N1641S
646 200 03 70	0-N1641
646 200 03 70	0-N1641S
646 200 05 70	0-N1641
646 200 05 70	0-N1641S
651 200 00 70	0-N2083
651 200 00 70	0-N2083S
651 200 02 70	0-N2238
651 200 03 70	0-N2205
651 200 04 70	0-N2086
651 200 04 70	0-N2086S

MERCEDES-BENZ		MERCEDES-BENZ		MERCEDES-BENZ		MERCEDES-BENZ	
651 200 06 70	0-N2312	A102 200 12 14	0-N2144	A601 200 07 70	0-N847	A651 200 04 70	0-N2086S
651 200 07 70	0-N2296	A102 200 14 14	0-N2144	A601 200 10 70	0-N1288	A651 200 06 70	0-N2312
651 200 13 70	0-N2422	A102 200 15 14	0-N2145	A603 200 06 14	0-N2147	A651 200 07 70	0-N2296
651 200 13 70	0-N2422S	A103 200 01 14	0-N2146	A604 200 02 14	0-N2147	A651 200 13 70	0-N2422
651 200 16 70	0-N2083	A104 200 04 70	0-N1280	A606 200 00 73	0-N1043	A651 200 13 70	0-N2422S
651 200 16 70	0-N2083S	A104 200 13 28	0-N1284	A606 200 01 73	0-N1043	A651 200 16 70	0-N2083
651 200 17 70	0-N2083	A104 200 21 28	0-N1287	A607 200 00 70	0-N2290	A651 200 16 70	0-N2083S
651 200 17 70	0-N2083S	A111 200 02 14	0-N1951	A607 200 00 70	0-N2290S	A651 200 17 70	0-N2083
651 200 18 70	0-N2086	A111 200 04 14	0-N1951	A607 200 02 70	0-N2253	A651 200 17 70	0-N2083S
651 200 18 70	0-N2086S	A111 200 13 70	0-N2148	A607 993 03 97	SK-1730	A651 200 18 70	0-N2086
651 200 19 70	0-N2306	A112 200 00 14	0-N2142	A628 200 01 70	0-N2193	A651 200 18 70	0-N2086S
651 200 19 70	0-N2306S	A119 200 14 70	0-N2141	A628 200 01 70	0-N2193S	A651 200 19 70	0-N2306
651 200 22 70	0-N2307	A130 708 04 7R	0-N2423	A628 202 00 19	0-N2218	A651 200 19 70	0-N2306S
651 200 22 70	0-N2307S	A137 202 01 19	0-N1560	A640 200 18 70	0-N2245	A651 200 22 70	0-N2307
651 200 24 70	0-N2307	A266 200 06 70	0-N2246	A640 200 18 70	0-N2245S1	A651 200 22 70	0-N2307S
651 200 24 70	0-N2307S	A266 200 06 70	0-N2246S1	A640 200 18 70	0-N2245S2	A651 200 24 70	0-N2307
664 200 02 70	0-N1510	A266 200 06 70	0-N2246S2	A640 200 18 70	0-N2245S3	A651 200 24 70	0-N2307S
664 200 02 70	0-N1510S	A266 200 06 70	0-N2246S3	A640 200 23 70	0-N2245	MG	
668 200 05 70	0-N1946	A266 200 07 70	0-N2401	A640 200 23 70	0-N2245S1	LHP100840A	0-N1120
668 200 05 70	0-N1946S1	A266 200 07 70	0-N2401S1	A640 200 23 70	0-N2245S2	PQG100190	0-N1659
668 200 05 70	0-N1946S2	A266 200 07 70	0-N2401S2	A640 200 23 70	0-N2245S3	PQG100190	0-N1659S
668 200 08 70	0-N1941	A266 200 09 70	0-N2246	A640 200 26 70	0-N2245	MINI	
668 200 08 70	0-N1941S1	A266 200 09 70	0-N2246S1	A640 200 26 70	0-N2245S1	1 484 243	0-N2427
668 200 08 70	0-N1941S2	A266 200 09 70	0-N2246S2	A640 200 26 70	0-N2245S2	1 484 243	0-N2427S
668 200 08 70	0-N1941S3	A266 200 09 70	0-N2246S3	A640 200 26 70	0-N2245S3	11 28 1 484 243	0-N2427
668 200 16 70	0-N1941	A266 200 11 70	0-N2401	A640 200 27 70	0-N2245	11 28 1 484 243	0-N2427S
668 200 16 70	0-N1941S1	A266 200 11 70	0-N2401S1	A640 200 27 70	0-N2245S1	11 28 7 509 476	0-N2124
668 200 16 70	0-N1941S2	A266 200 11 70	0-N2401S2	A640 200 27 70	0-N2245S2	11 28 7 509 476	0-N2124S
668 200 16 70	0-N1941S3	A266 202 04 19	0-N2367	A640 200 27 70	0-N2245S3	11 28 7 534 400	0-N2264
668 200 22 70	0-N1941	A271 200 04 70	0-N2136	A640 200 33 70	0-N2245	11 28 7 570 810	0-N2427
668 200 22 70	0-N1941S1	A271 200 04 70	0-N2136S	A640 200 33 70	0-N2245S1	11 28 7 570 810	0-N2427S
668 200 22 70	0-N1941S2	A271 200 05 70	0-N2206	A640 200 33 70	0-N2245S2	11 28 7 571 013	0-N2264
668 200 22 70	0-N1941S3	A272 200 01 14	0-N2143	A640 200 33 70	0-N2245S3	11 28 7 571 014	0-N2263
668 202 01 19	0-N1397	A272 202 04 19	0-N2138	A642 200 04 70	0-N2219	11 28 7 598 831	0-N2264
668 202 02 19	0-N1388	A272 202 06 19	0-N2138	A642 200 04 70	0-N2219S	11 28 7 598 832	0-N2264
668 202 03 19	0-N1723	A272 202 07 19	0-N2138	A642 200 05 70	0-N2132	11 28 7 598 833	0-N2263
668 202 04 19	0-N1397	A272 202 14 19	0-N2138	A642 200 06 70	0-N2227	11 28 7 795 037	0-N1339
668 202 05 19	0-N1395	A274 200 00 70	0-N2309	A642 200 09 70	0-N1560	11 28 7 795 037	0-N1339S
668 202 06 19	0-N1972	A274 200 00 70	0-N2309S	A642 200 10 70	0-N1560	7 534 400	0-N2264
668 202 07 19	0-N1744	A274 200 02 70	0-N2309	A642 200 14 70	0-N2219	7 570 810	0-N2427
668 202 08 19	0-N1972	A274 200 02 70	0-N2309S	A642 200 14 70	0-N2219S	7 570 810	0-N2427S
668 202 09 19	0-N1744	A274 200 04 70	0-N2309	A642 200 15 70	0-N2241	7 571 013	0-N2264
668 202 10 19	0-N1972	A274 200 04 70	0-N2309S	A642 200 15 70	0-N2241S	7 571 014	0-N2263
668 202 11 19	0-N1744	A274 200 06 70	0-N2309	A642 200 19 70	0-N2293	7 598 831	0-N2264
A000 202 03 19	0-N2131	A274 200 06 70	0-N2309S	A642 200 19 70	0-N2293S	7 598 832	0-N2264
A000 202 07 19	0-N2131	A274 202 00 19	0-N2310	A642 200 23 70	0-N1560	7 598 833	0-N2263
A000 202 08 19	0-N2131	A276 200 01 70	0-N2403	A642 200 25 70	0-N1560	7 795 037	0-N1339
A000 202 16 19	0-N2120	A276 200 01 70	0-N2403S	A651 200 00 70	0-N2083	7 795 037	0-N1339S
A000 202 17 19	0-N2119	A276 200 03 70	0-N2403	A651 200 00 70	0-N2083S	MITSUBISHI	
A102 200 04 14	0-N2145	A276 200 03 70	0-N2403S	A651 200 02 70	0-N2238	1145A020	0-N2161
A102 200 07 14	0-N2145	A276 202 01 19	0-N2368	A651 200 03 70	0-N2205	1145A020	0-N2161S
A102 200 08 14	0-N2144	A278 202 05 19	0-N2284	A651 200 04 70	0-N2086	1145A026	0-N2384



MITSUBISHI		MITSUBISHI		MITSUBISHI		NISSAN	
1145A031	0-N2012	MD151447	0-N189	MN176844	0-N1772	11750-9654R	0-N1664S
1145A078	0-N1772	MD156604	0-N055	MN980101	0-N1335	11751-00Q0B	0-N2253
1341A001	0-N2419	MD156659	0-N2163	MN980104	0-N1046	11923-0001R	0-N2344
1341A005	0-N2048	MD164533	0-N1971	MN980107	0-N1336	11923-8274R	0-N2344
1341A008	0-N2364	MD166381	0-N1521	MN982126	0-N2018	11923-BN700	0-N1898
1341A012	0-N2365	MD169592	0-N056	MN982127	0-N1334	11923-BN700	0-N1898S
1341A029	0-N2048	MD174352	0-N065	MN982128	SK-1692	11925-00QAA	0-N1663
1341A042	0-N2294	MD175375	0-N052	MN982388	SK-1692	11925-00QAA	0-N1663S
1341A051	0-N2354	MD179597	0-N192	MR984375	0-N2010	11925-00QAB	0-N1314
1345A001	0-N2402	MD182537	0-N060	MR984714	0-N1762	11925-00QAE	0-N1409
1345A001	0-N2402S	MD185241	0-N2163	MSP005L200	SK-1737	11925-00QAF	0-N1307
1345A008	0-N2112	MD188813	0-N191	MW30620661	0-N1802	11925-00QAL	0-N1663
1345A008	0-N2112S	MD190988	0-N2415	MW30620661	0-N1802S	11925-00QAL	0-N1663S
1345A009	0-N2270	MD192068	0-N1127	MW30621270	0-N1729	11925-00QAP	0-N1409
1345A009	0-N2270S	MD192731	0-N055	MW30621589	SK-1493	11925-77A12	0-N2165
1345A013	0-N2397	MD197922	0-N2163	MW30623983	0-N1409	11925-77A13	0-N2165
1345A013	0-N2397S	MD303884	0-N2305	MW30638631	0-N1409	11925-AW300	0-N1409
1345A031	0-N2081	MD308586	0-N2415	MW30638633	0-N1611	11925-AX000	0-N2282
1345A031	0-N2081S	MD308588	0-N2163	MW30638633	0-N1611S	11925-AX00B	0-N2282
1345A060	0-N2112	MD308593	0-N2162	MW30777250	SK-1493	11925-VC801	0-N1986
1345A060	0-N2112S	MD308882	0-N1521	MW31303117	0-N1409	11927-00Q0D	0-N2253
1345A062	0-N2270	MD312403	0-N2036	NISSAN		11927-00QAA	0-N1307
1345A062	0-N2270S	MD315265	0-N052	11750-00Q0B	0-N1664	11927-1HC0A	0-N2240
1345A079	0-N2112	MD316826	0-N191	11750-00Q0B	0-N1664S	11927-77A10	0-N2164
1345A079	0-N2112S	MD319022	0-N189	11750-00Q0D	0-N1664	11927-77A11	0-N2164
M343741	0-N173	MD319040	0-N2163	11750-00Q0D	0-N1664S	11927-AD201	0-N2099
M618062	SK-1707	MD320174	0-N182	11750-00Q0E	0-N1314	11927-AD20B	0-N2099
M855992	0-N854	MD327654	0-N1521	11750-00QAA	0-N1802	11927-AN301	0-N2357
M855993	0-N173	MD329625	0-N061	11750-00QAA	0-N1802S	11927-AN304	0-N2357
M864049	0-N147	MD329976	0-N181	11750-00QAE	0-N1802	11927-AX000	0-N2043
MA857385	0-N2081	MD334548	0-N060	11750-00QAE	0-N1802S	11927-ED000	0-N2240
MA857385	0-N2081S	MD343741	0-N173	11750-00QAF	0-N1592	11927-ED00B	0-N2240
MD 325568	0-N1827	MD352473	0-N1127	11750-00QAH	0-N1589	11927-ED320	0-N2285
MD008965	0-N051	MD356509	0-N1129	11750-00QAJ	0-N1474	11927VC800	0-N2425
MD009650	0-N188	MD365983	0-N1130	11750-00QAP	0-N1474	11944-00QAC	0-N1898
MD011536	0-N059	MD366344	0-N2426	11750-00QAR	0-N1664	11944-00QAC	0-N1898S
MD012587	0-N058	MD368209	0-N1521	11750-00QAR	0-N1664S	11955-00Q0A	0-N1731
MD030605	0-N986	MD368210	0-N1866	11750-00QAU	0-N1664	11955-00Q0A	0-N1731S
MD040754	0-N183	MD369999	0-N060	11750-00QAU	0-N1664S	11955-00Q0B	0-N1875
MD040774	0-N062	MD373939	0-N2259	11750-1083R	0-N1664	11955-00Q0B	0-N1875S
MD050125	0-N184	MD374877	0-N1984	11750-1083R	0-N1664S	11955-00Q0C	0-N1731
MD050135	0-N061	MD377198	0-N1130	11750-2W200	0-N1732	11955-00Q0C	0-N1731S
MD102451	0-N1521	MD602710	0-N062	11750-2W200	0-N1732S	11955-00Q0D	0-N1875
MD104578	0-N064	MD852898	0-N1470	11750-2W201	0-N1732	11955-00Q0D	0-N1875S
MD109958	0-N053	MD852898	0-N1470S	11750-2W201	0-N1732S	11955-00QAA	0-N1731
MD115976	0-N179	MD865078	0-N147	11750-2W202	0-N1732	11955-00QAA	0-N1731S
MD128765	0-N186	MD883811	0-N1173	11750-2W202	0-N1732S	11955-00QAB	0-N1875
MD129033	0-N063	MN119741	0-N1763	11750-2W203	0-N1732	11955-00QAB	0-N1875S
MD129355	0-N054	MN137247	0-N1771	11750-2W203	0-N1732S	11955-00QAC	0-N1875
MD137302	0-N1971	MN137248	0-N2255	11750-2W20C	0-N1732	11955-00QAC	0-N1875S
MD140071	0-N185	MN149179	0-N2105	11750-2W20C	0-N1732S	11955-00QAD	0-N1731
MD146186	0-N987	MN149179	0-N2105S	11750-9654R	0-N1664	11955-00QAD	0-N1731S

NISSAN		NISSAN		NISSAN		OPEL	
11955-00QAE	0-N1731	13070-01M00	0-N032	82000-64664	0-N1365	12575509	0-N2194S
11955-00QAE	0-N1731S	13070-05E00	0-N030	82001-27467	0-N1269	12605175	0-N2299
11955-00QAF	0-N1875	13070-05E10	0-N030	OPEL		12605175	0-N2299S
11955-00QAF	0-N1875S	13070-16A02	0-N025	06 36 160	0-N1347	12605492	0-N2283
11955-00QAG	0-N1476	13070-16A03	0-N025	06 36 166	0-N1526	13 40 258	0-N2030
11955-00QAG	0-N1476S	13070-16A10	0-N027	06 36 166	0-N1526S	13 40 258	0-N2030S
11955-5X00B	0-N2089	13070-2F600	0-N1755	06 36 257	0-N2254	13 40 267	0-N2170
11955-5X00B	0-N2089S	13070-2J600	0-N028	06 36 279	0-N195	13 40 267	0-N2170S
11955-5X00C	0-N2089	13070-42L00	0-N024	06 36 383	0-N049	13 40 268	0-N1799
11955-5X00C	0-N2089S	13070-57J00	0-N028	06 36 415	0-N906	13 40 268	0-N1799S
11955-5X00D	0-N2089	13070-57J01	0-N028	06 36 416	0-N907	13 40 269	0-N2087
11955-5X00D	0-N2089S	13070-57J10	0-N028	06 36 418	0-N909	13 40 269	0-N2087S
11955-5X20B	0-N2085	13070-6F900	0-N861	06 36 420	0-N300	13 40 513	0-N1439
11955-5X20B	0-N2085S	13070-6F901	0-N861	06 36 422	0-N875	13 40 530	0-N1485
11955-6N202	0-N2211	13070-AW300	0-N1323	06 36 423	0-N876	13 40 530	0-N1485S
11955-6N202	0-N2211S	13070-BN700	SK-1487	06 36 424	0-N957	13 40 534	0-N1422
11955-6N20B	0-N2211	13070-D0100	0-N021	06 36 527	0-N2194	13 40 534	0-N1422S
11955-6N20B	0-N2211S	13070-D4200	0-N022	06 36 527	0-N2194S	13 40 535	0-N1439
11955-6N20C	0-N2211	13070-V5001	0-N024	06 36 591	0-N1717	13 40 536	0-N1438
11955-6N20C	0-N2211S	13070-V7201	0-N034	06 36 591	0-N1717S	13 40 536	0-N1438S
11955-8J000	0-N2211	13070-V7203	0-N034	06 36 654	0-N102	13 40 538	0-N1303
11955-8J000	0-N2211S	13074-05E00	0-N031	06 36 671	SK-1508	13 40 539	0-N1304
11955-8J00A	0-N2211	13074-16A01	0-N033	06 36 685	0-N115	13 40 540	0-N1305
11955-8J00A	0-N2211S	13074-58S00	0-N2260	06 36 721	0-N1768	13 40 541	0-N1422
11955-AW300	0-N1611	13077-00QAA	0-N1270	06 36 723	0-N1383	13 40 541	0-N1422S
11955-AW300	0-N1611S	13077-00QAD	0-N863	06 36 725	0-N102	13 40 543	0-N1304
11955-BN701	0-N1476	13077-00QAF	0-N145	06 36 726	0-N100	13 40 544	0-N1422
11955-BN701	0-N1476S	13077-00QAG	0-N1112	06 36 728	SK-1508	13 40 544	0-N1422S
11955-BN702	0-N1474	13077-00QAJ	0-N145	06 36 729	0-N1383	13 40 545	0-N1485
11955-BN703	0-N1476	13077-00QAL	0-N1112	06 36 729	0-N1383	13 40 545	0-N1485S
11955-BN703	0-N1476S	13077-45V00	0-N1218	06 36 731	0-N879	13 40 545	0-N1485S
11955-ET00A	0-N1869	13077-54A00	0-N029	06 36 732	0-N877	13 40 547	0-N1438
11955-ET00A	0-N1869S	13077-6F900	0-N862	06 36 734	0-N948	13 40 547	0-N1438S
11955-JA00A	0-N2211	13077-6F901	0-N862	06 36 735	0-N910	13 40 548	0-N1485
11955-JA00A	0-N2211S	13077-F6200	0-N1218	06 36 736	0-N1768	13 40 548	0-N1485S
11955-JA00B	0-N2211	13077-F6510	0-N1219	06 36 737	0-N100	13 40 549	0-N2169
11955-JA00B	0-N2211S	13077-F6511	0-N1220	06 36 739	0-N102	13 40 550	0-N2170
11955-JA00C	0-N2211	13077-F6512	0-N1218	06 36 740	0-N948	13 40 550	0-N2170S
11955-JA00C	0-N2211S	13077-V7200	0-N035	06 36 741	0-N126	13 40 551	0-N2170
11955-JD20A	0-N1869	13077-V7201	0-N035	06 36 742	0-N879	13 40 551	0-N2170S
11955-JD20A	0-N1869S	13077-V7202	0-N035	06 36 745	0-N126	13 40 552	0-N1303
11955-JD21A	0-N1869	13077-V7203	0-N035	06 36 748	0-N948	13 40 555	0-N1466
11955-JD21A	0-N1869S	16806-00Q0A	SK-1493	06 36 749	0-N948	13 40 555	0-N1466S
13070-00Q0L	0-N262	16806-00QA8	SK-1487	06 36 929	0-N1347	13 40 653	0-N1303
13070-00QAA	0-N262	16806-00QAF	SK-1493	08 15 971	0-N050	13 40 827	0-N1437
13070-00QAB	0-N198	16806-00QAG	SK-1489	12 04 641	0-N1495S	1340266	0-N2389
13070-00QAC	0-N1173	16806-00QAJ	SK-1493	12 06 990	0-N1464	1340266	0-N2389S
13070-00QAD	0-N1269	16806-00QAT	SK-1081	12 06 990	0-N1464S	1340270	0-N2340
13070-00QAE	0-N1269	16806-00QAX	SK-1487	1204185	0-N2390	1340533	0-N1322
13070-00QAF	0-N1269	16806-00QBB	SK-1487	1204185	0-N2390S	1340533	0-N1322S
13070-01B00	0-N094	24360-29000	0-N900	1204302	0-N2390	1340584	0-N2299
13070-01B01	0-N094	24370-29000	0-N901	1204302	0-N2390S	1340584	0-N2299S
		77001-11822	0-N1173	12575509	0-N2194	16 06 189	SK-1113



OPEL		OPEL		OPEL		OPEL	
16 06 189	SK-1355	24430296	0-N1588S	44 31 739	0-N1731	55565572	0-N2341
16 06 190	SK-1073	24447794	0-N1347	44 31 739	0-N1731S	55566028	0-N115
16 06 191	SK-1100	40 01 416	0-N199	44 31 762	SK-1489	55567191	0-N102
16 06 192	SK-1100	40 01 428	SK-1489	44 32 089	0-N1875	55568403	0-N2341
16 06 193	SK-1165	40 01 566	0-N1611	44 32 089	0-N1875S	55568974	0-N2236
16 06 194	SK-1478	40 01 566	0-N1611S	44 33 874	0-N1731	55570289	0-N1347
16 06 195	SK-1166	40 01 567	0-N1802	44 33 874	0-N1731S	55570290	0-N1347
16 06 196	SK-1632	40 01 567	0-N1802S	44 49 454	0-N1409	55574864	0-N1347
16 06 197	SK-1163	40 01 609	0-N173	44 49 516	0-N1731	55581830	0-N2254
16 06 198	SK-1644	40 01 801	SK-1035	44 49 516	0-N1731S	56 36 130	0-N1347
16 06 199	SK-1644	40 02 631	0-N199	45 00 041	0-N1650	56 36 131	0-N1347
16 06 262	SK-1355	40 02 632	0-N1106	45 00 955	0-N1591	56 36 357	SK-1073
16 06 274	SK-1073	42 94 287	0-N042	45 01 801	SK-1680	56 36 384	0-N1369
16 06 281	SK-1113	44 00 200	0-N1617	45 01 807	SK-1153	56 36 395	0-N878
16 06 305	SK-1667	44 00 204	0-N821	45 06 085	SK-1489	56 36 403	0-N1085
16 06 306	SK-1355	44 01 416	SK-1490	45 06 090	0-N1269	56 36 404	0-N1353
16 06 314	SK-1607	44 01 416	SK-1622	45 06 092	0-N1270	56 36 411	0-N1633
16 06 340	SK-1164	44 01 430	0-N1269	45 06 190	0-N1731	56 36 412	0-N1649
16 06 342	SK-1164	44 01 489	0-N147	45 06 190	0-N1731S	56 36 415	0-N952
16 06 343	SK-1168	44 02 632	SK-1490	45 06 192	0-N1875	56 36 416	0-N953
16 06 349	SK-1168	44 02 639	0-N147	45 06 192	0-N1875S	56 36 418	0-N957
16 06 355	SK-1607	44 02 639	SK-1490	45 06 194	0-N1307	56 36 419	0-N952
16 06 356	SK-1607	44 02 690	0-N854	45 06 195	0-N1648	56 36 421	0-N957
16 06 359	SK-1169	44 03 144	0-N816	47 08 770	0-N1526	56 36 422	0-N957
16 06 360	SK-1612	44 03 270	0-N854	47 08 770	0-N1526S	56 36 423	0-N127
16 06 366	SK-1611	44 04 476	0-N1875	48 05 176	0-N1960	56 36 424	0-N909
16 06 368	SK-1162	44 04 476	0-N1875S	48 05 177	0-N1952	56 36 425	0-N906
16 06 369	SK-1162	44 05 276	0-N1875	48 05 183	0-N2171	56 36 426	0-N953
16 06 384	SK-1481	44 05 276	0-N1875S	48 05 513	0-N2197	56 36 427	0-N952
16 06 385	SK-1169	44 05 281	0-N1731	48 05 513	0-N2197S	56 36 428	0-N1765S
16 06 387	SK-1054	44 05 281	0-N1731S	48 15 241	0-N1952	56 36 429	0-N101
16 06 388	SK-1479	44 08 351	0-N1611	4802596	0-N2420	56 36 434	0-N1355
16 06 389	SK-1481	44 08 351	0-N1611S	4802597	0-N2421	56 36 435	0-N1354
16 06 390	SK-1481	44 08 922	0-N1173	55185074	0-N1526	56 36 437	0-N1461
16 06 426	SK-1607	44 08 922	0-N173	55185074	0-N1526S	56 36 449	0-N1574
16 06 434	SK-1586	44 09 485	SK-1493	55190811	0-N1522	56 36 451	0-N1347
16 29 002	SK-1644	44 10 513	0-N1173	55190813	0-N1503	56 36 454	0-N300
16 29 005	SK-1723	44 10 548	0-N1365	55190813	0-N1503S	56 36 455	0-N953
16 29 019	SK-1693	44 10 595	0-N1307	55350580	0-N953	56 36 456	0-N115
1629016	SK-1586	44 11 707	0-N1611	55350960	0-N1437	56 36 469	0-N1347
1629062	SK-1355	44 11 707	0-N1611S	55353810	0-N1369	56 36 475	0-N115
18 54 297	0-N2283	44 13 416	0-N1731	55555653	0-N1347	56 36 486	0-N1347
18 54 352	0-N2072	44 13 416	0-N1731S	55560082	0-N1347	56 36 488	0-N2236
18 54 421	0-N1426	44 13 791	0-N1409	55562217	0-N1347	56 36 501	0-N957
18 54 429	0-N1603	44 14 654	0-N1409	55562218	0-N1347	56 36 561	SK-1073
18 54 436	0-N1306	44 15 859	0-N1875	55562245	0-N1526	56 36 565	SK-1073
18 54 740	0-N2221	44 15 859	0-N1875S	55562245	0-N1526S	56 36 721	0-N948
1854164	0-N2341	44 16 369	0-N147	55562251	0-N1522	56 36 722	0-N948
24412292	0-N1422	44 18 672	0-N1269	55562864	0-N2087	56 36 725	0-N1347
24412292	0-N1422S	44 30 318	0-N1648	55562864	0-N2087S	56 36 730	0-N956
24426500	0-N102	44 30 891	SK-1493	55563512	0-N1799	56 36 732	0-N102
24430296	0-N1588	44 30 895	SK-1624	55563512	0-N1799S	56 36 733	0-N102

OPEL		OPEL		OPEL		OPEL	
56 36 734	0-N1765	63 40 676	0-N1526S	90530124	0-N101	92 02 478	0-N948
56 36 735	0-N2168	636158	0-N2341	90530125	0-N100	92 02 550	0-N1438
56 36 738	0-N100	636257	0-N2254	90530126	0-N1383	92 02 550	0-N1438S
56 36 739	0-N1085	636584	0-N878	90542637	0-N2169	92 40 033	0-N300
56 36 740	0-N102	636592	0-N2389	90542860	0-N957	92 66 523	0-N1396
56 36 741	0-N1717	636592	0-N2389S	90543739	0-N957	92065368	0-N1369
56 36 741	0-N1717S	636671	SK-1508	90543873	0-N1303	93160244	0-N1365
56 36 743	0-N1326	636728	SK-1508	90570525	0-N948	93160256	0-N1307
56 36 745	0-N115	66 06 028	SK-1696	90570913	0-N952	93160746	0-N1611
56 36 746	0-N1369	66 06 029	SK-1586	90571758	0-N1466	93160746	0-N1611S
56 36 755	0-N1355	68 54 427	0-N1426	90571758	0-N1466S	93160779	0-N1409
56 36 756	0-N1354	8980055640	0-N1798	90573616	0-N957	93161221	0-N1731
56 36 757	0-N1353	8980055640	0-N1798S	90710530	0-N910	93161221	0-N1731S
56 36 978	0-N1348	90264022	0-N875	91 08 204	0-N821	93161481	SK-1624
6 14 533	0-N1588	90323501	0-N877	91 09 416	0-N199	93161842	0-N1731
6 14 533	0-N1588S	90323503	0-N876	91 09 428	SK-1489	93161842	0-N1731S
6 14 649	0-N2167	90324097	0-N1603	91 09 430	0-N1269	93161859	SK-1489
6 36 416	0-N907	90353176	0-N948	91 09 566	0-N1611	93171384	0-N1834
6 36 420	0-N300	90409238	0-N1439	91 09 566	0-N1611S	93171384	0-N1834S
6 36 727	0-N101	90409783	0-N1438	91 09 567	0-N1802	93171389	0-N1396
6 36 730	0-N878	90409783	0-N1438S	91 09 567	0-N1802S	93174119	SK-1113
6 36 738	0-N101	90411025	0-N1322	91 09 609	0-N173	93174120	SK-1073
6 36 746	0-N101	90411025	0-N1322S	91 10 631	0-N199	93174262	SK-1165
6 36 747	0-N878	90411769	0-N101	91 10 632	0-N1106	93174263	SK-1478
6 36 928	0-N878	90411773	0-N907	91 10 639	0-N147	93174264	SK-1166
62 04 661	0-N1495S	90411774	0-N100	91 11 144	0-N816	93174265	SK-1632
62 04 663	0-N1798	90411782	0-N906	91 18 848	0-N1303	93174266	SK-1163
62 04 663	0-N1798S	90411787	0-N909	91 20 501	SK-1508	93174267	SK-1644
63 40 532	0-N1422	90412730	0-N953	91 21 114	0-N1731	93174268	SK-1644
63 40 532	0-N1422S	90412731	0-N952	91 21 114	0-N1731S	93178816	0-N115
63 40 538	0-N1438	90412783	0-N102	91 28 444	0-N956	93180218	SK-1355
63 40 538	0-N1438S	90412884	0-N1464	91 28 516	0-N102	93180219	SK-1073
63 40 539	0-N1396	90412884	0-N1464S	91 28 656	0-N102	93181966	0-N115
63 40 541	0-N1900	90466474	0-N957	91 28 736	0-N906	93183572	SK-1113
63 40 543	0-N1834	90499401	0-N948	91 28 739	0-N953	93185845	SK-1355
63 40 543	0-N1834S	90500229	0-N1422	91 28 740	0-N952	93185849	SK-1607
63 40 548	0-N1396	90500229	0-N1422S	91 28 741	0-N909	93186866	0-N115
63 40 551	0-N1437	90502129	0-N1422	91 58 004	0-N100	93188132	SK-1169
63 40 552	0-N1799	90502129	0-N1422S	91 60 341	0-N1650	93188133	SK-1169
63 40 552	0-N1799S	90509168	0-N1303	91 61 255	0-N1591	93188136	SK-1479
63 40 553	0-N2170	90509273	0-N1304	91 62 101	SK-1680	93188137	SK-1481
63 40 553	0-N2170S	90509282	0-N1305	91 62 107	SK-1153	93188138	SK-1481
63 40 554	0-N1526	90511627	0-N1304	91 98 523	0-N1731	93191277	SK-1696
63 40 554	0-N1526S	90528200	0-N101	91 98 523	0-N1731S	93191278	SK-1586
63 40 555	0-N1522	90528603	0-N1383	91 98 527	0-N1307	93196786	SK-1607
63 40 556	0-N1667	90528760	0-N1438	91159961	0-N1611	93196787	SK-1607
63 40 557	0-N1503	90528760	0-N1438S	91159961	0-N1611S	93196788	SK-1612
63 40 557	0-N1503S	90529187	0-N957	91160164	0-N173	93196790	SK-1611
63 40 558	0-N1799	90529188	0-N957	91580003	0-N101	93196791	SK-1481
63 40 558	0-N1799S	90529810	0-N127	92 01 527	SK-1489	93198194	0-N1731
63 40 572	0-N1522	90529913	0-N1437	92 01 537	0-N1269	93198194	0-N1731S
63 40 676	0-N1526	90530123	0-N102	92 01 540	0-N1270	93198651	0-N1731



OPEL		PEUGEOT		PEUGEOT		PEUGEOT	
93198651	0-N1731S	0513.61	0-N1222	0829.93	0-N1057	0830.74	0-N1334
94106001	0-N878	0818.17	0-N815	0829.96	0-N1057	0831.01	SK-1018S
9-41239-72	0-N046	0818.19	0-N871	0829.98	0-N1060	0831.02	SK-1003
94149432	0-N879	0818.20	0-N944	0829.A0	0-N1359	0831.03	SK-1004
94215197	0-N042	0818.21	0-N822	0829.A1	0-N1360	0831.04	SK-1005
94220900	0-N047	0818.23	0-N816	0829.A3	0-N1327	0831.05	SK-1006
94364816	0-N1768	0818.24	0-N821	0829.A4	0-N1327	0831.06	SK-1019
94382214	0-N049	0818.32	0-N816	0829.A5	0-N1338	0831.07	SK-1157
94382215	0-N050	0818.38	0-N1714	0829.A7	0-N1057	0831.08	SK-1159
94386488	0-N2167	0818.38	0-N1714S	0829.C5	0-N1056	0831.09	SK-1007
94472349	0-N045	0820.53	0-N811	0829.C6	0-N1338	0831.11	SK-1017
95507809	SK-1607	0823.08	0-N1056	0829.C7	0-N1061	0831.13	SK-1003
95507810	SK-1586	0823.09	0-N1056	0829.C8	0-N1359	0831.14	SK-1004
95507813	SK-1644	0823.10	0-N1056	0829.F7	0-N2063	0831.17	SK-1019
95507816	SK-1723	0829.11	0-N813	0829.F8	0-N2224	0831.20	SK-1007
95511893	SK-1586	0829.12	0-N812	0830.02	0-N814	0831.21	SK-1016
95512576	SK-1693	0829.17	0-N822	0830.11	0-N862	0831.22	SK-1017
95516735	SK-1355	0829.19	0-N811	0830.12	0-N945	0831.24	SK-1020
95518060	SK-1355	0829.20	0-N869	0830.13	0-N900	0831.25	SK-1158
96352818	0-N1422	0829.21	0-N813	0830.14	0-N862	0831.27	SK-1022
96352818	0-N1422S	0829.22	0-N870	0830.16	0-N862	0831.28	SK-1020
96435138	0-N1422	0829.29	0-N811	0830.20	0-N122	0831.29	SK-1158
96435138	0-N1422S	0829.30	0-N861	0830.23	0-N215	0831.30	SK-1040
96440326	0-N1960	0829.31	0-N911	0830.24	0-N170	0831.31	SK-1022
96440417	0-N2171	0829.32	0-N943	0830.25	0-N171	0831.32	SK-1399
97112438	0-N126	0829.33	0-N901	0830.26	0-N170	0831.33	SK-1399
97114552	0-N126	0829.35	0-N943	0830.27	0-N171	0831.34	SK-1079
97116002	0-N1768	0829.44	0-N811	0830.28	0-N119P	0831.35	SK-1079
97129939	0-N878	0829.45	0-N861	0830.29	0-N119P	0831.36	SK-1034
97136256	0-N1765	0829.46	0-N911	0830.30	0-N119P	0831.37	SK-1034
97137148	0-N2168	0829.49	0-N121	0830.31	0-N119P	0831.40	SK-1085
97146877	0-N1765S	0829.52	0-N214	0830.32	0-N821	0831.41	SK-1085
97184929	0-N1495S	0829.54	0-N811	0830.36	0-N862	0831.44	SK-1005
97184930	0-N1426	0829.60	0-N118P	0830.37	0-N862	0831.45	SK-1005
97222553	0-N1495S	0829.61	0-N118P	0830.40	0-N816	0831.46	SK-1040
97229131	0-N1355	0829.62	0-N118P	0830.42	0-N1065	0831.47	SK-1040
97229132	0-N1354	0829.63	0-N118P	0830.44	0-N215	0831.48	SK-1082
97241065	0-N1633	0829.65	0-N1617	0830.46	0-N1381	0831.48	SK-1399
97249944	0-N1085	0829.66	0-N1057	0830.48	0-N1066	0831.49	SK-1082
97249945	0-N1085	0829.67	0-N1057	0830.49	0-N1066	0831.50	SK-1016
97250750	0-N1649	0829.69	0-N1058	0830.51	0-N1334	0831.51	SK-1016
97309459	0-N878	0829.74	0-N214	0830.52	0-N1456	0831.52	SK-1017
97312462	0-N1717	0829.76	0-N1057	0830.53	0-N170	0831.53	SK-1017
97312462	0-N1717S	0829.77	0-N1057	0830.54	0-N171	0831.55	SK-1482
97364344	0-N1495S	0829.78	0-N1058	0830.55	0-N1615	0831.56	SK-1399
97381208	0-N1354	0829.79	0-N1058	0830.58	0-N170	0831.57	SK-1399
97383061	0-N1717	0829.80	0-N1060	0830.59	0-N171	0831.58	SK-1086
97383061	0-N1717S	0829.82	0-N1061	0830.60	0-N1456	0831.59	SK-1086
98005564	0-N1798	0829.88	0-N1062	0830.61	0-N122	0831.60	SK-1394
98005564	0-N1798S	0829.89	0-N1062	0830.62	0-N1360	0831.61	SK-1394
PEUGEOT		0829.90	0-N1277	0830.63	0-N1381	0831.62	SK-1085
00 001 281 19	0-N1973	0829.92	0-N1057	0830.72	0-N1334	0831.63	SK-1087

PEUGEOT		PEUGEOT		PEUGEOT		PEUGEOT	
0831.65	SK-1482	0831.Q1	SK-1728	16087476	SK-1732	5751.43	0-N1747
0831.66	SK-1482	0831.Q3	SK-1003	1608747680	SK-1732	5751.44	0-N1747
0831.67	SK-1399	0831.Q4	SK-1004	16091201	SK-1085AQ1	5751.45	0-N1681
0831.68	SK-1399	0831.Q5	SK-1020	1609120180	SK-1085AQ1	5751.46	0-N1545
0831.69	SK-1393	0831.Q8	SK-1007	16095246	SK-1085AQ1	5751.50	0-N1949
0831.71	SK-1613	0831.R1	SK-1019	1609524680	SK-1085AQ1	5751.51	0-N1446
0831.73	SK-1534	0831.R3	SK-1040	16095247	SK-1085AQ1	5751.52	0-N1486
0831.74	SK-1534	0831.R4	SK-1022	1609524780	SK-1085AQ1	5751.52	0-N1486S
0831.76	SK-1642	0831.R5	SK-1082	16095256	SK-1424AQ1	5751.53	0-N1968
0831.77	SK-1642	0831.R6	SK-1034	1609525680	SK-1424AQ1	5751.54	0-N1747
0831.78	SK-1085	0831.R7	SK-1086	16095257	SK-1598AQ1	5751.55	0-N1493
0831.79	SK-1085	0831.R8	SK-1085	1609525780	SK-1598AQ1	5751.55	0-N1493S
0831.80	SK-1391	0831.R9	SK-1615	1609958780	0-N2294	5751.56	0-N1748
0831.81	SK-1391	0831.S0	SK-1354	1609974080	0-N2390	5751.57	0-N151
0831.82	SK-1085	0831.S1	SK-1353	1609974080	0-N2390S	5751.60	0-N1416
0831.83	SK-1085	0831.S2	SK-1534	16107933	SK-1598AQ1	5751.61	0-N1391
0831.84	SK-1353	0831.S3	SK-1614	1610793380	SK-1598AQ1	5751.61	0-N1391S
0831.85	SK-1353	0831.S7	SK-1399	1611423480	0-N1460	5751.62	0-N1545
0831.86	SK-1354	0831.S9	SK-1399	1628.WA	0-N1651	5751.63	0-N1545
0831.87	SK-1354	0831.T0	SK-1393	1628.WA	0-N1651S	5751.67	0-N1545
0831.88	SK-1482	0831.T2	SK-1642	26 207 509	0-N822	5751.72	0-N1545
0831.89	SK-1482	0831.T3	SK-1391	4007.E4	0-N095	5751.73	0-N1309
0831.90	SK-1609	0831.T4	SK-1482	5703.38	0-N2349	5751.74	0-N1471
0831.91	SK-1609	0831.T5	SK-1594	5751 E4	0-N2276	5751.74	0-N1471S
0831.92	SK-1594	0831.T6	SK-1596	5751.08	0-N2349	5751.75	0-N1449
0831.93	SK-1596	0831.T7	SK-1616	5751.11	0-N2349	5751.76	0-N1413
0831.K0	SK-1594	0831.V0	SK-1598	5751.13	0-N1712	5751.77	0-N1473
0831.K1	SK-1600	0831.V1	SK-1392	5751.14	0-N2349	5751.77	0-N1473S
0831.K3	SK-1600	0831.V2	SK-1483	5751.18	0-N124	5751.81	0-N1747
0831.K4	SK-1616	0831.V3	SK-1085	5751.19	0-N1484	5751.86	0-N1339
0831.K6	SK-1614	0831.V4	SK-1424	5751.19	0-N1484S	5751.86	0-N1339S
0831.K7	SK-1614	0831.V5	SK-1692	5751.20	0-N1405	5751.87	0-N1418
0831.K8	SK-1617	0831.V6	SK-1600	5751.21	0-N2153	5751.89	0-N1636
0831.L2	SK-1615	0831.V7	SK-1732	5751.23	0-N1756	5751.89	0-N1636S
0831.L3	SK-1615	0831.W1	SK-1714	5751.24	0-N1751	5751.90	0-N1420
0831.L4	SK-1598	0831.W2	SK-1728	5751.26	0-N133	5751.91	0-N1455
0831.L5	SK-1598	0831.W3	SK-1732	5751.27	0-N2015	5751.92	0-N1421
0831.L6	SK-1392	1281.18	0-N2348	5751.29	0-N1320	5751.95	0-N1421
0831.L7	SK-1392	1281.19	0-N1973	5751.30	0-N1472	5751.96	0-N151
0831.L8	SK-1483	1281.34	0-N1749	5751.30	0-N1472S	5751.97	0-N1620
0831.N0	SK-1588	1281.34	0-N1749S	5751.31	0-N1747	5751.97	0-N1620S
0831.N0	SK-1692	1281.35	0-N2154	5751.32	0-N1713	5751.98	0-N1419
0831.N2	SK-1086	1281.38	0-N1750	5751.33	0-N1722	5751.A0	0-N1556S
0831.N3	SK-1086	1281.39	0-N2348	5751.34	0-N1463S	5751.A1	0-N2094
0831.N4	SK-1085	16 080 248 80	0-N1460	5751.35	0-N1484	5751.A2	0-N1620
0831.N5	SK-1085	16 095 258 80	SK-1615AQ1	5751.35	0-N1484S	5751.A2	0-N1620S
0831.P1	SK-1424	16 107 934 80	SK-1615AQ1	5751.36	0-N1402	5751.A9	0-N1473
0831.P2	SK-1424	16 114 234 80	0-N1460	5751.36	0-N1402S	5751.A9	0-N1473S
0831.P4	SK-1424	16069735	SK-1600	5751.37	0-N1465S	5751.C0	0-N1840
0831.P5	SK-1692	1606973580	SK-1600	5751.38	0-N931	5751.C0	0-N1840S
0831.P8	SK-1615	1607664380	0-N2354	5751.40	0-N2175	5751.C3	0-N1673
0831.Q0	SK-1714	1608747480	SK-1728	5751.41	0-N1757	5751.C3	0-N1673S



PEUGEOT

5751.C8	0-N1620
5751.C8	0-N1620S
5751.C9	0-N1419
5751.E1	0-N2095S1
5751.E5	0-N1924
5751.E6	0-N1807
5751.E7	0-N2055
5751.E7	0-N2055S
5751.E8	0-N2191
5751.E9	0-N1874
5751.E9	0-N1874S
5751.F0	0-N1460
5751.F2	0-N2014
5751.F2	0-N2014S
5751.F3	0-N1808
5751.F3	0-N1808S
5751.F5	0-N2042
5751.F5	0-N2042S
5751.F6	0-N2046
5751.F6	0-N2046S
5751.F9	0-N1502
5751.F9	0-N1502S
5751.G0	0-N2116
5751.G0	0-N2116S
5751.G2	0-N2115
5751.G2	0-N2115S
5751.G3	0-N1419
5751.G4	0-N2048
5751.G5	0-N2112
5751.G5	0-N2112S
5751.G7	0-N1673
5751.G7	0-N1673S
5751.G8	0-N1840
5751.G8	0-N1840S
5751.G9	0-N2055
5751.G9	0-N2055S
5751.H3	0-N2268
5751.H3	0-N2268S
5751.H6	0-N1502
5751.H6	0-N1502S
5751.H8	0-N2268
5751.H8	0-N2268S
5751.J5	0-N2392
5751.J5	0-N2392S
5751.K4	0-N2392
5751.K4	0-N2392S
6453.76	0-N849
6453.AN	0-N1904
6453.AN	0-N1975
6453.C6	0-N1682
6453.CE	0-N1386
6453.FL	0-N1386

PEUGEOT

6453.KH	0-N1387
6453.NN	0-N1589
6453.R8	0-N1899
6453.S3	0-N2173
6453.S4	0-N125
6453.S4	0-N125S
6453.S5	0-N125
6453.S5	0-N125S
6453.SG	0-N1711S
6453.Y1	0-N2174
6453.Y3	0-N2172
6453.Y3	0-N2172S
6454.S3	0-N2173
6455.B3	0-N2337
91 508 298	0-N812
91 538 722	0-N869
93 501 404	0-N813
93 501 405	0-N814
93 510 847	0-N1682
95 495 830	0-N815
95 577 787	0-N1320
95 619 217	0-N822
95 640 195	0-N861
96 010 657	0-N870
96 036 288	0-N1973
96 052 662	0-N811
96 056 183	0-N871
96 076 190	0-N2348
96 094 102	0-N945
96 097 691	0-N1222
96 098 279	0-N944
96 099 089	0-N862
96 112 753	0-N2349
96 117 885	0-N2153
96 137 001	0-N911
96 146 660	0-N2349
96 151 754	0-N1749
96 151 754	0-N1749S
96 155 001	0-N095
96 156 400	0-N133
96 159 233	0-N900
96 171 886	0-N901
96 178 009 80	0-N122
96 188 885	0-N1320
96 199 932	0-N1756
96 201 309	0-N862
96 214 145	0-N1402
96 214 145	0-N1402S
96 215 446	0-N2174
96 216 260	0-N1446
96 217 206	0-N2173
96 218 349	0-N1486

PEUGEOT

96 218 349	0-N1486S
96 225 744	0-N943
96 230 012	0-N1472
96 230 012	0-N1472S
96 236 000	0-N1747
96 236 598	0-N1747
96 256 217	0-N1713
96 256 218	0-N1722
96 263 652	0-N1484
96 263 652	0-N1484S
96 289 491	0-N2175
96 296 777	0-N118P
96 318 474	0-N1413
96 321 551	0-N1747
96 327 221	0-N1065
96 332 546	0-N1750
96 333 151	0-N1748
96 333 152	0-N151
96 340 878 80	0-N122
96 344 657	0-N1493
96 344 657	0-N1493S
96 345 720	0-N2175
96 345 720 80	0-N2175
96 353 368	0-N1058
96 354 380 80	0-N1060
96 359 666	0-N1473
96 359 666	0-N1473S
96 363 551	0-N1493
96 363 551	0-N1493S
96 366 405	0-N1416
96 367 827	0-N1471
96 367 827	0-N1471S
96 370 580	0-N1058
96 374 926	0-N1061
96 374 926 80	0-N1061
96 378 749	0-N1057
96 381 153 80	0-N118P
96 383 807 80	0-N1636
96 383 807 80	0-N1636S
96 398 222	0-N1057
96 400 532	0-N1339
96 400 532	0-N1339S
96 400 532 80	0-N1339
96 400 532 80	0-N1339S
96 403 456	0-N1057
96 408 284 80	0-N1327
96 410 042	0-N1420
96 413 140	0-N1062
96 413 173 80	0-N1651
96 413 173 80	0-N1651S
96 415 393	0-N1066
96 420 067 80	0-N1455

PEUGEOT

96 426 581 80	0-N1419
96 429 298	0-N1277
96 429 657	0-N151
96 433 296	0-N1057
96 442 584 80	0-N1334
96 447 595	0-N1421
96 447 885	0-N1421
96 452 098 80	0-N1338
96 459 251 80	0-N1060
96 463 960 80	0-N1419
96 464 958 80	0-N1589
96 478 348 80	0-N1556S
96 484 732 80	0-N1360
96 487 043 80	0-N1359
96 496 758 80	0-N1620
96 496 758 80	0-N1620S
96 507 426 80	0-N1320
96 510 197 80	0-N1473
96 510 197 80	0-N1473S
96 520 466 80	0-N1620
96 520 466 80	0-N1620S
96 520 736 80	0-N1673
96 520 736 80	0-N1673S
96 527 717 80	0-N1338
96 541 273 8	0-N1808
96 541 273 8	0-N1808S
96 551 989 80	0-N1636
96 551 989 80	0-N1636S
96 554 874 80	0-N1419
96 561 502 80	0-N2095
96 561 502 80	0-N2095S
96 563 633 80	0-N1874
96 563 633 80	0-N1874S
96 616 797 80	0-N2115
96 616 797 80	0-N2115S
96 654 092	0-N871
96 725 750 80	0-N2224
96 744 068 80	0-N2063
96 768 548 80	0-N2392
96 768 548 80	0-N2392S
96 783 252 80	0-N1460
96 823 057 80	0-N1334
96 825 809 80	0-N1502
96 825 809 80	0-N1502S
96 854 868 80	0-N1673
96 854 868 80	0-N1673S
96201545	0-N1751
9674960980	0-N2355
97 522 886	0-N811
97 535 002	0-N811

PLYMOUTH

4612894AB	0-N1698
-----------	---------

PLYMOUTH

4612894AB	0-N1698S
4612894AC	0-N1698
4612894AC	0-N1698S
5003284AA	0-N1962

PONTIAC

12563083	0-N1658
20577684	0-N1658
24503851	0-N1658
24507667	0-N1658
8971858590	0-N1687

PORSCHE

022 145 276 A	0-N2110
930 126 216 00	0-N904
948 102 261 00	0-N2291
948 102 402 00	0-N2272
955 102 276 00	0-N2110
955 105 244 00	0-N131
955 105 244 01	0-N131
958 102 118 01	0-N2351
958 102 119 00	0-N2199
958 102 361 10	0-N2289
958 102 361 10	0-N2289S
958 102 361 20	0-N1830
958 102 361 20	0-N1830S
958 102 361 30	0-N1830
958 102 361 30	0-N1830S
996 102 117 57	0-N2068
996 102 118 56	0-N2069
996 102 119 58	0-N2070
996 115 015 75	0-N2071
996 115 015 76	0-N2090
996 115 016 72	0-N2073
996 115 221 72	0-N2080
997 102 118 00	0-N2078
997 102 119 00	0-N2079
997 102 260 00	0-N2077
9A1 102 030 01	0-N2295
9A1 102 212 00	0-N2272

PROTON

MD356509	0-N1129
----------	---------

RENAULT

11 75 000 01R	0-N2279
11 75 000 01R	0-N2279S
11 75 009 69R	0-N2039
11 75 009 69R	0-N2039S
11 75 011 13R	0-N2290
11 75 011 13R	0-N2290S
11 75 053 37R	0-N2280
11 75 053 37R	0-N2280S
11 75 061 93R	0-N2308
11 75 061 93R	0-N2308S
11 75 075 68R	0-N2039

RENAULT

11 75 075 68R	0-N2039S
11 92 300 01R	0-N2344
11 92 313 78R	0-N2253
11 92 330 42R	0-N2275
11 92 382 74R	0-N2344
11 92 71H C0A	0-N2240
11 95 52A 10A	0-N2213
11 95 52A 10A	0-N2213S
11 95 5JA 00B	0-N2211
11 95 5JA 00B	0-N2211S
11 95 5JA 00C	0-N2211
11 95 5JA 00C	0-N2211S
11 95 5JD 20A	0-N1869
11 95 5JD 20A	0-N1869S
11 95 5JD 21A	0-N1869
11 95 5JD 21A	0-N1869S
13 07 011 92R	0-N198
13 07 075 92R	0-N821
13 07 080 47R	0-N2423
13 07 085 46R	0-N2423
13 07 756 30R	0-N2380
13 0C 104 74R	SK-1730
13 0C 113 21R	SK-1624
13 0C 131 91R	SK-1630
13 0C 153 39R	SK-1730
13 0C 174 80R	SK-1704
13 0C 175 29R	SK-1088
13 0C 196 56R	SK-1624
50 01 001 259	0-N816
50 01 001 263	0-N1617
50 01 001 272	0-N821
50 10 284 907	0-N1480S
50 10 553 544	0-N1480S
74 30 638 277	0-N137
74 31 275 380	0-N1518
74 31 275 380	0-N1518S
74 38 610 040	SK-1491
74 38 610 041	SK-1103
74 38 630 590	0-N958
74 38 642 251	0-N137
74 38 670 484	0-N137
74 39 135 036	0-N930
74 39 146 139	0-N143
74 39 146 376	0-N958
74 39 146 377	0-N958
74 39 440 329	0-N137
77 00 100 671	0-N148
77 00 102 395	0-N1470
77 00 102 395	0-N1470S
77 00 102 872	0-N1663
77 00 102 872	0-N1663S
77 00 102 931	0-N1307

RENAULT

77 00 104 092	0-N1307
77 00 105 325	0-N1314
77 00 106 708	0-N1488
77 00 106 708	0-N1488S
77 00 107 150	0-N262
77 00 107 249	0-N147
77 00 108 117	0-N198
77 00 108 626	0-N1259
77 00 108 920	0-N200
77 00 109 450	0-N1611
77 00 109 450	0-N1611S
77 00 111 822	0-N1173
77 00 114 860	0-N200
77 00 115 070	0-N1571
77 00 115 075	0-N148
77 00 115 862	0-N199
77 00 115 862	SK-1622
77 00 116 049	0-N854
77 00 116 050	0-N881
77 00 116 054	0-N1106
77 00 116 054	SK-1490
77 00 116 054	SK-1622
77 00 116 192	0-N148
77 00 260 891	0-N2336
77 00 271 618	0-N141
77 00 272 652	0-N135
77 00 272 972	0-N150
77 00 273 277	0-N145
77 00 273 640	0-N149
77 00 274 039	0-N1898
77 00 274 039	0-N1898S
77 00 274 217	0-N1721
77 00 274 218	0-N1635
77 00 300 378	0-N1650
77 00 313 302	0-N1648
77 00 314 075	0-N1648
77 00 660 586	0-N882
77 00 692 315	0-N882
77 00 696 986	0-N883
77 00 696 987	0-N887
77 00 720 366	0-N856
77 00 721 690	0-N857
77 00 722 452	0-N913
77 00 726 440	0-N173
77 00 733 489	0-N881
77 00 735 486	0-N854
77 00 736 085	0-N863
77 00 736 419	0-N880
77 00 742 976	0-N1734
77 00 745 215	0-N882
77 00 850 603	0-N138
77 00 850 789	0-N1753

RENAULT

77 00 851 321	0-N139
77 00 852 005	0-N2332
77 00 852 114	0-N913
77 00 856 888	0-N2176
77 00 857 492	0-N964
77 00 857 879	0-N112
77 00 858 358	0-N134
77 00 858 902	0-N2333
77 00 859 117	0-N2334
77 00 859 182	0-N2342
77 00 859 183	0-N2335
77 00 860 217	0-N1602
77 00 860 455	0-N2016
77 00 860 883	0-N2343
77 00 861 810	0-N152
77 00 861 810	0-N152S
77 00 862 108	0-N149
77 00 862 152	0-N1479S
77 00 862 615	0-N965
77 00 862 743	0-N1752
77 00 862 744	0-N1590
77 00 862 888	0-N2179
77 00 863 111	0-N881
77 00 863 112	0-N854
77 00 863 113	0-N173
77 00 864 572	0-N277
77 00 864 573	0-N2013
77 00 867 985	0-N1729
77 00 868 201	0-N1589
77 00 869 666	0-N1736
77 00 869 684	0-N1635
77 00 870 432	0-N1721
77 00 870 495	0-N1626
77 00 870 495	0-N1626S
77 00 870 795	0-N1589
77 00 870 937	0-N1729
77 00 871 168	0-N882
77 00 871 169	0-N913
77 00 871 616	0-N1736
77 00 872 531	0-N112
77 00 872 550	0-N1488
77 00 872 550	0-N1488S
77 00 873 731	0-N112
77 00 875 305	0-N146
77 00 875 307	0-N147
77 01 035 743	0-N949
77 01 035 966	0-N144
77 01 040 204	0-N816
77 01 044 676	0-N1591
77 01 050 377	0-N1355
77 01 050 387	0-N1354
77 01 052 673	0-N1633



RENAULT

77 01 052 775	0-N1461
77 01 053 088	0-N1353
77 01 055 084	0-N1717
77 01 055 084	0-N1717S
77 01 063 970	0-N1355
77 01 063 971	0-N1354
77 01 064 387	0-N2177
77 01 064 510	0-N1353
77 01 064 942	0-N2045
77 01 064 942	0-N2045S
77 01 064 944	0-N2178
77 01 068 752	0-N1717
77 01 068 752	0-N1717S
77 01 208 788	0-N1648
77 01 468 162	SK-1014
77 01 468 163	SK-1015
77 01 468 164	SK-1010
77 01 468 167	SK-1011
77 01 468 168	SK-1012
77 01 469 774	SK-1013
77 01 469 775	SK-1171
77 01 469 776	SK-1036
77 01 469 820	SK-1095
77 01 469 820	SK-1645
77 01 469 821	SK-1096
77 01 469 822	SK-1091
77 01 469 823	SK-1092
77 01 469 824	SK-1093
77 01 469 825	SK-1154
77 01 469 833	SK-1021
77 01 471 367	SK-1625
77 01 471 382	SK-1088
77 01 471 426	SK-1093
77 01 471 464	SK-1095
77 01 471 519	SK-1103
77 01 471 520	SK-1491
77 01 471 769	SK-1657
77 01 471 770	SK-1035
77 01 471 771	SK-1035
77 01 471 772	SK-1045
77 01 471 773	SK-1046
77 01 471 774	SK-1153
77 01 471 864	SK-1107
77 01 471 865	SK-1084
77 01 471 865	SK-1114
77 01 471 866	SK-1108
77 01 471 866	SK-1108S
77 01 471 974	SK-1088
77 01 472 185	SK-1493
77 01 472 292	SK-1494
77 01 472 329	SK-1489
77 01 472 644	SK-1081

RENAULT

77 01 472 645	SK-1620
77 01 472 675	SK-1081
77 01 472 696	SK-1623
77 01 472 696	SK-1624
77 01 472 725	SK-1338
77 01 472 726	SK-1021
77 01 473 001	SK-1486
77 01 473 053	SK-1494
77 01 473 120	SK-1487
77 01 473 312	SK-1493
77 01 473 569	SK-1483
77 01 473 672	SK-1620
77 01 473 672	SK-1622
77 01 473 712	SK-1663
77 01 473 837	SK-1620
77 01 473 837	SK-1622
77 01 473 849	SK-1489
77 01 474 019	SK-1631
77 01 474 021	SK-1624
77 01 474 022	SK-1631
77 01 474 023	SK-1624
77 01 474 198	SK-1611
77 01 474 359	SK-1630
77 01 474 443	SK-1580
77 01 474 446	SK-1084
77 01 474 446	SK-1114
77 01 475 115	SK-1487
77 01 476 571	SK-1487
77 01 476 674	SK-1494
77 01 476 675	SK-1631
77 01 476 745	SK-1486
77 01 476 884	SK-1108
77 01 476 884	SK-1108S
77 01 476 885	SK-1013
77 01 477 012	SK-1487
77 01 477 013	SK-1081
77 01 477 014	SK-1088
77 01 477 022	SK-1624
77 01 477 023	SK-1630
77 01 477 024	SK-1338
77 01 477 028	SK-1487
77 01 477 046	SK-1084
77 01 477 046	SK-1114
77 01 477 047	SK-1663
77 01 477 048	SK-1493
77 01 477 049	SK-1620
77 01 477 050	SK-1580
77 01 477 067	SK-1611
77 01 477 093	SK-1624
77 01 477 184	SK-1631
77 01 477 380	SK-1489
77 01 478 750	SK-1630

RENAULT

77 11 115 394	0-N1112
82 00 004 341	0-N1731
82 00 004 341	0-N1731S
82 00 004 593	0-N1270
82 00 007 980	0-N1269
82 00 009 194	0-N1269
82 00 025 570	0-N1875
82 00 025 570	0-N1875S
82 00 035 827	0-N1112
82 00 040 155	0-N2222
82 00 040 161	0-N1592
82 00 045 127	0-N200
82 00 045 735	0-N148
82 00 048 486	0-N1476
82 00 048 486	0-N1476S
82 00 051 091	0-N854
82 00 051 092	0-N881
82 00 053 294	0-N1474
82 00 061 345	0-N200
82 00 061 697	0-N200
82 00 064 664	0-N1365
82 00 065 479	0-N1729
82 00 065 970	0-N1469
82 00 069 140	0-N1611
82 00 069 140	0-N1611S
82 00 071 267	0-N1323
82 00 071 402	0-N1611
82 00 071 402	0-N1611S
82 00 071 404	0-N1409
82 00 072 120	0-N1427
82 00 072 120	0-N1427S
82 00 079 341	0-N199
82 00 079 341	SK-1490
82 00 079 341	SK-1622
82 00 086 697	0-N200
82 00 102 612	0-N145
82 00 102 941	0-N1111
82 00 103 069	0-N1112
82 00 104 754	0-N1307
82 00 105 896	0-N1731
82 00 105 896	0-N1731S
82 00 111 869	0-N1875
82 00 111 869	0-N1875S
82 00 127 467	0-N1269
82 00 136 224	0-N2222
82 00 170 009	0-N1898
82 00 170 009	0-N1898S
82 00 171 807	0-N1898
82 00 171 807	0-N1898S
82 00 190 566	0-N1611
82 00 190 566	0-N1611S
82 00 190 571	0-N1802

RENAULT

82 00 190 571	0-N1802S
82 00 190 572	0-N1611
82 00 190 572	0-N1611S
82 00 191 324	0-N1368
82 00 192 843	0-N1314
82 00 200 587	0-N1875
82 00 200 587	0-N1875S
82 00 206 872	0-N1731
82 00 206 872	0-N1731S
82 00 211 784	0-N145
82 00 222 092	0-N200
82 00 226 495	0-N1475S
82 00 230 958	0-N1469
82 00 244 615	0-N198
82 00 262 773	0-N1474
82 00 275 844	0-N1476
82 00 275 844	0-N1476S
82 00 277 606	0-N1663
82 00 277 606	0-N1663S
82 00 285 009	0-N1409
82 00 292 784	0-N1474
82 00 324 532	0-N1743
82 00 328 372	0-N1474
82 00 347 161	0-N1731
82 00 347 161	0-N1731S
82 00 347 761	0-N1368
82 00 354 507	0-N1875
82 00 354 507	0-N1875S
82 00 357 341	0-N1739
82 00 357 406	0-N2039
82 00 357 406	0-N2039S
82 00 360 524	0-N1664
82 00 360 524	0-N1664S
82 00 371 058	0-N1476
82 00 371 058	0-N1476S
82 00 403 954	0-N1663
82 00 403 954	0-N1663S
82 00 420 960	0-N147
82 00 420 964	0-N147
82 00 420 964	SK-1490
82 00 421 284	0-N1314
82 00 429 703	0-N1475S
82 00 434 732	0-N2222
82 00 454 895	0-N1112
82 00 460 446	0-N1664
82 00 460 446	0-N1664S
82 00 469 376	0-N881
82 00 483 288	0-N1259
82 00 492 180	0-N1427
82 00 492 180	0-N1427S
82 00 499 908	0-N200
82 00 499 909	0-N200

RENAULT		RENAULT		ROVER		SAAB	
82 00 548 109	0-N1731	82 00 933 753	0-N2265S	LHP10013	0-N861	12605175	0-N2299
82 00 548 109	0-N1731S	82 00 941 079	0-N2039	LHP10015	0-N894	12605175	0-N2299S
82 00 548 227	SK-1490	82 00 941 079	0-N2039S	LHP10016	0-N1243	13 40 535	0-N1439
82 00 548 227	SK-1622	82 00 947 837	0-N1409	LHP100390	0-N236	24430296	0-N1588
82 00 582 997	0-N1314	82 00 981 266	0-N1409	LHP100440	0-N905	24430296	0-N1588S
82 00 585 574	0-N1111	82 00 989 169	0-N200	LHP100450	0-N905	4 356 127	0-N1430
82 00 585 576	0-N198	82 00 989 172	0-N200	LHP100480	0-N178	40 28 064	0-N2181
82 00 598 966	0-N2275	82 01 008 780	0-N2222	LHP100490	0-N178	40 29 609	0-N2180
82 00 603 359	0-N1663	82 01 033 287	0-N2060	LHP100550	0-N1273	40 29 930	0-N1604
82 00 603 359	0-N1663S	82 01 038 625	SK-1698	LHP100590	0-N901	42 37 020	0-N1438
82 00 608 550	0-N1664	82 01 058 069	0-N262	LHP100790	0-N978	42 37 020	0-N1438S
82 00 608 550	0-N1664S	96 16 660 580	0-N170	LHP100840	0-N1120	42 37 038	0-N1603
82 00 612 619	0-N1664	96 16 660 780	0-N171	LHP100840A	0-N1120	43 56 119	0-N2029
82 00 612 619	0-N1664S	96 20 038 880	0-N1757	LHP100900	0-N1272	43 56 119	0-N2029S
82 00 623 883	0-N1368	96 28 949 180	0-N2175	LHP100940	0-N1121	45 04 080	0-N957
82 00 641 468	0-N1898	96 30 535 380	0-N1056	LHV100080	0-N862	45 04 114	SK-1508
82 00 641 468	0-N1898S	96 35 638 380	0-N1449	LHV100110	0-N1248	45 75 478	0-N1485
82 00 645 498	0-N1875	96 35 966 680	0-N1473	LHV100120	0-N237	45 75 478	0-N1485S
82 00 645 498	0-N1875S	96 35 966 680	0-N1473S	LHV100160	0-N1122	47 50 220	0-N1438
82 00 663 046	0-N2253			LHV100160A	0-N1122	47 50 220	0-N1438S
82 00 673 090	0-N1427			PQG100141	0-N1742	47 52 879	0-N1544
82 00 673 090	0-N1427S	ROVER		PQG100141	0-N1742S	47 52 895	0-N1544
82 00 673 091	0-N1611	ADU 9219	0-N899	PQG100142	0-N1742	47 52 960	0-N1544
82 00 673 091	0-N1611S	ADU8335	0-N897	PQG100142	0-N1742S	47 70 459	0-N957
82 00 673 092	0-N1802	ADU9220	0-N898	PQG100180	0-N1643	47 70 475	0-N957
82 00 673 092	0-N1802S	AHU 2503	0-N899	PQG100180	0-N1643S	47 70 483	0-N957
82 00 676 403	0-N200	AHU2504	0-N898	PQG100180A	0-N1643	47 70 558	0-N957
82 00 676 404	0-N200	CDU 2005	0-N899	PQG100180A	0-N1643S	47 73 842	0-N956
82 00 704 394	0-N1112	CDU2049	0-N1584	PQG100190	0-N1659	47 73 842	SK-1508
82 00 709 717	0-N1173	CDU3558	0-N894	PQG100190	0-N1659S	48 98 755	0-N1410
82 00 709 719	0-N1323	DBP9291	0-N926	PQG100210	0-N1514	48 98 755	0-N1410S
82 00 714 513	0-N1731	ERR 1972	0-N968	PQG100210	0-N1514S	49 01 419	0-N2181
82 00 714 513	0-N1731S	ERR2530	0-N891	PQG100230	0-N1535	49 01 443	0-N2180
82 00 714 514	0-N1875	ERR2798	0-N2054	PQG100230	0-N1535S	49 01 625	0-N1544
82 00 714 514	0-N1875S	ERR3440	0-N2053	PQG100230A	0-N1535	49 60 290	0-N1544
82 00 725 951	0-N1739	ERR3440	0-N2053S	PQG100230A	0-N1535S	49 67 907	0-N1429
82 00 761 529	0-N1731	ERR3562	0-N1809	PQG100340	0-N1514	49 68 590	0-N1429
82 00 761 529	0-N1731S	ERR3562	0-N1809S	PQG100340	0-N1514S	51 72 309	0-N1410
82 00 761 531	0-N1875	ERR4708	0-N1857	PQR10013	0-N1540	51 72 309	0-N1410S
82 00 761 531	0-N1875S	ERR4708	0-N1857S	PQR10027	0-N1412	53 40 617	0-N1730
82 00 767 775	0-N2060	ERR5214	0-N1535	PQR10028	0-N1584	53 42 456	0-N1485
82 00 769 155	0-N1743	ERR5214	0-N1535S	PQR100780	0-N1735	53 42 456	0-N1485S
82 00 839 580	0-N1269	ERR6439	0-N1809	PQR100781	0-N1735	55 190 812	0-N1667
82 00 840 824	0-N1802	ERR7298	0-N2054	PQR100880	0-N1393	55190811	0-N1522
82 00 840 824	0-N1802S	ETC8560	0-N892	PQR500160	0-N1735	55190813	0-N1503
82 00 861 569	0-N1664	FDU2691	0-N927	PRF100060	0-N1396	55190813	0-N1503S
82 00 861 569	0-N1664S	LHB10-16-30	0-N1261	PRF100060L	0-N1396	59 54 508	0-N1353
82 00 875 156	0-N2222	LHP 10013	0-N861	QVU10022	0-N1643	59 54 516	0-N1355
82 00 905 328	0-N1427	LHP10002	0-N898	QVU10022	0-N1643S	59 54 524	0-N1354
82 00 905 328	0-N1427S	LHP100070	0-N900	XHM461	0-N928	59 54 771	0-N1717
82 00 908 180	0-N2062	LHP10009	0-N814			59 54 771	0-N1717S
82 00 933 753	0-N2265	LHP10010	0-N813			59 54 805	0-N1633
		LHP10011	0-N1243	SAAB			
				104752960	0-N1544		



SAAB

71 854 429	0-N1603
75 92 017	0-N1544
79 78 299	0-N1544
91 28 739	0-N953
92 40 033	0-N300
93178807	0-N1326
93178816	0-N115
93181966	0-N115
93186866	0-N115

SCANIA

135 3717	0-N1730
142 8940	0-N1730

SEAT

021 145 299 B	0-N1657
021 145 299 B	0-N1657S
021 145 299 C	0-N1657
021 145 299 C	0-N1657S
026 109 243	0-N805
026 109 243 A	0-N805
026 109 243 C	0-N805
026 109 243 E	0-N805
026 109 243 F	0-N805
026 109 243 G	0-N805
026 109 243 L	0-N805
027 109 243	0-N808
027 198 119	SK-1124
028 109 243	0-N103
028 109 243 B	0-N103
028 109 243 D	0-N111
028 109 243 E	0-N104
028 109 243 F	0-N104
028 109 243 G	0-N111
028 109 244	0-N128
028 109 244 B	0-N128
028 145 278	0-N1417
028 145 278 A	0-N1417
028 145 278 E	0-N1417
028 145 278 M	0-N1675
028 198 119	SK-1029
028 198 119 A	SK-1122
028 198 119 B	SK-1069
028 198 119 C	SK-1098
028 198 119 E	SK-1425
028 198 119 F	SK-1106
028 903 308 F	0-N1925
028 903 315 N	0-N1609
028 903 315 R	0-N1609
030 109 243 D	0-N106
030 109 243 F	0-N106
030 109 243 J	0-N106
030 109 243 K	0-N106
030 109 243 L	0-N1331

SEAT

030 109 243 M	0-N1331
030 109 243 N	0-N1331
030 109 243 P	0-N1331
030 109 243 R	0-N1331
030 145 299 C	0-N1445
030 145 299 C	0-N1445S
030 145 299 F	0-N1445
030 145 299 F	0-N1445S
030 198 119 A	SK-1131
030 198 119 B	SK-1592
032 145 276	0-N1310
032 145 299 A	0-N1539
032 145 299 A	0-N1539S
032 145 299 C	0-N1459
032 145 299 C	0-N1459S
032 198 119	SK-1074
036 109 181 A	0-N164
036 109 181 B	0-N164
036 109 243 AB	0-N158
036 109 243 AC	0-N1263
036 109 243 AD	0-N158
036 109 243 AE	0-N1263
036 109 243 AF	0-N158
036 109 243 AG	0-N1263
036 109 243 D	0-N1258
036 109 243 E	0-N158
036 109 243 F	0-N159
036 109 243 G	0-N1258
036 109 243 J	0-N1258
036 109 243 K	0-N1263
036 109 243 L	0-N158
036 109 243 R	0-N158
036 109 243 S	0-N1263
036 109 244	0-N165
036 109 244 C	0-N1262
036 109 244 D	0-N1262
036 109 244 G	0-N165
036 109 244 J	0-N1262
036 109 244 K	0-N131
036 198 119 A	SK-1511
036 198 119 B	SK-1585
036 198 119 C	SK-1511
036 198 119 E	SK-1511
037 198 119	SK-1120
037 903 315 A	0-N1660
037 903 315 B	0-N1660
037 903 315 C	0-N1660
038 109 243	0-N107
038 109 243 D	0-N107
038 109 243 F	0-N107
038 109 243 G	0-N107
038 109 243 H	0-N107

SEAT

038 109 243 M	0-N1045
038 109 243 N	0-N107
038 109 244 B	0-N166
038 109 244 C	0-N166
038 109 244 E	0-N167
038 109 244 H	0-N166
038 109 244 J	0-N1046
038 109 244 M	0-N166
038 109 244 N	0-N1046
038 109 244 P	0-N131
038 109 244 Q	0-N167
038 109 244 R	0-N166
038 145 276	0-N174
038 198 119	SK-1582
038 198 119 A	SK-1372
038 198 119 B	SK-1378
038 198 119 B	SK-1388
038 198 119 C	SK-1372
038 198 119 D	SK-1111
038 198 119 D	SK-1258
038 198 119 E	SK-1258
038 198 119 F	SK-1110
038 198 119 F	SK-1259
038 198 119 G	SK-1372
038 903 315 A	0-N1606
038 903 315 A	0-N1606S
038 903 315 AD	0-N1534
038 903 315 AD	0-N1534S
038 903 315 AE	0-N1494
038 903 315 AE	0-N1494S
038 903 315 AG	0-N1534
038 903 315 AG	0-N1534S
038 903 315 AH	0-N1534
038 903 315 AH	0-N1534S
038 903 315 AJ	0-N1534
038 903 315 AJ	0-N1534S
038 903 315 AM	0-N1534
038 903 315 AM	0-N1534S
038 903 315 C	0-N1538
038 903 315 C	0-N1538S
038 903 315 E	0-N1606
038 903 315 E	0-N1606S
038 903 315 F	0-N1494
038 903 315 F	0-N1494S
038 903 315 K	0-N1606
038 903 315 K	0-N1606S
038 903 315 T	0-N1534
038 903 315 T	0-N1534S
03C 145 276 B	0-N2050
03C 145 276 C	0-N2133
03C 145 299 A	0-N2111
03C 145 299 A	0-N2111S

SEAT

03C 145 299 AC	0-N2111
03C 145 299 AC	0-N2111S
03C 145 299 AF	0-N2111
03C 145 299 AF	0-N2111S
03C 145 299 C	0-N1733
03C 145 299 C	0-N1733S
03C 145 299 G	0-N2111
03C 145 299 G	0-N2111S
03C 145 299 H	0-N2111
03C 145 299 H	0-N2111S
03C 145 299 J	0-N2091
03C 145 299 J	0-N2091S
03C 145 299 K	0-N2111
03C 145 299 K	0-N2111S
03C 145 299 L	0-N2111
03C 145 299 L	0-N2111S
03C 145 299 M	0-N2092
03C 145 299 M	0-N2092S
03C 145 299 P	0-N2111
03C 145 299 P	0-N2111S
03C 145 299 Q	0-N1733
03C 145 299 Q	0-N1733S
03D 903 305 B	0-N1908
03D 903 305 B	0-N1908S
03D 903 305 F	0-N1908
03D 903 305 F	0-N1908S
03D 903 305 G	0-N1908
03D 903 305 G	0-N1908S
03E 903 133	0-N1908
03E 903 133	0-N1908S
03E 903 133 A	0-N1908
03E 903 133 A	0-N1908S
03E 903 133 B	0-N1908
03E 903 133 B	0-N1908S
03F 145 276	0-N2121
03G 109 243	0-N1335
03G 109 244	0-N1336
03G 109 244 A	0-N1575
03G 145 276	0-N1738
03G 198 119	SK-1595
03G 198 119 A	SK-1668
03G 198 119 B	SK-1595
03G 198 119 C	SK-1668
03L 109 243 A	0-N1905
03L 109 243 B	0-N2061
03L 109 243 D	0-N2061
03L 109 243 E	0-N1905
03L 109 243 F	0-N2061
03L 109 244	0-N2025
03L 109 244 B	0-N2025
03L 109 244 C	0-N1268
03L 109 244 D	0-N131

SEAT		SEAT		SEAT		SKODA	
03L 109 244 E	0-N2025	068 109 243 C	0-N806	1J0 145 276	0-N1454	036 109 243 AE	0-N1263
03L 109 244 G	0-N2200	068 109 243 F	0-N806	1J0 145 299	0-N1733	036 109 243 AF	0-N158
03L 109 244 H	0-N2200	06A 109 181	0-N2234	1J0 145 299	0-N1733S	036 109 243 AG	0-N1263
03L 198 119	SK-1694	06A 109 243 A	0-N2195	1L0 198 001	SK-1104	036 109 243 E	0-N158
03L 198 119 A	SK-1695	06A 109 479	0-N157	1L0 198 002	SK-1069	036 109 243 K	0-N1263
03L 198 119 B	SK-1695	06A 109 479 A	0-N157	1L0 198 002 A	SK-1098	036 109 243 L	0-N158
03L 198 119 C	SK-1727	06A 109 479 B	0-N157	6K0 145 299	0-N1459	036 109 243 R	0-N158
03L 198 119 D	SK-1727	06A 109 479 C	0-N157	6K0 145 299	0-N1459S	036 109 243 S	0-N1263
03L 198 119 F	SK-1727	06A 198 119	SK-1109	6K0 198 001 A	SK-1131	036 109 244 C	0-N1262
045 109 243 A	0-N1048	06A 198 119 A	SK-1337	6K0 198 001 B	SK-1090	036 109 244 D	0-N1262
045 109 243 B	0-N1265	06A 198 119 B	SK-1660	6K0 198 001 C	SK-1635	036 109 244 J	0-N1262
045 109 243 C	0-N1048	06B 109 243	0-N1654	6K0 198 001 D	SK-1074	036 109 244 K	0-N131
045 109 243 D	0-N1265	06B 109 243 A	0-N1042	6K0 198 002	SK-1026	036 198 119 A	SK-1511
045 109 243 F	0-N1045	06B 109 243 B	0-N1050	6K0 198 004	SK-1120	036 198 119 C	SK-1511
045 109 244 A	0-N1268	06B 109 243 C	0-N1566	6K0 198 005	SK-1029	036 198 119 E	SK-1511
045 109 479 B	0-N1274	06B 109 243 D	0-N1042	6L0 198 002	SK-1069	038 109 243	0-N107
045 109 479 C	0-N1049	06B 109 243 E	0-N1050	6Q0 145 299	0-N1525	038 109 243 D	0-N107
045 903 315 A	0-N1704	06B 109 243 F	0-N1042	6Q0 145 299	0-N1525S	038 109 243 F	0-N107
045 903 315 A	0-N1704S	06B 109 244	0-N1316	6QD 145 276	0-N1454	038 109 243 G	0-N107
047 903 306	0-N2065	06B 109 477	0-N1237	SE0 210 120 60A	0-N859	038 109 243 H	0-N107
047 903 306	0-N2065S	06B 109 477 A	0-N1051			038 109 243 M	0-N1045
047 903 315	0-N2066	06B 109 477 A	0-N1051S			038 109 243 N	0-N107
04C 109 244 B	0-N2381	06B 109 477 B	0-N1567			038 109 244 B	0-N166
04C 109 244 D	0-N2381	06B 109 479	0-N1237			038 109 244 C	0-N166
04C 109 479 G	0-N2313	06B 198 119	SK-1660			038 109 244 E	0-N167
04C 109 479 H	0-N2313	06B 198 119 A	SK-1640			038 109 244 H	0-N166
04C 109 479 J	0-N2313	06B 198 119 C	SK-1726			038 109 244 J	0-N1046
04C 145 299 B	0-N2271	06B 903 133	0-N1671			038 109 244 M	0-N166
04E 109 244 A	0-N2381	06B 903 133	0-N1671S			038 109 244 N	0-N1046
04E 109 244 B	0-N2381	06B 903 133 A	0-N1671			038 109 244 P	0-N131
04E 109 244 D	0-N2381	06B 903 133 A	0-N1671S			038 109 244 Q	0-N167
04E 109 244 E	0-N2381	06B 903 133 E	0-N1671			038 109 244 R	0-N166
04E 109 479 A	0-N2313	06B 903 133 E	0-N1671S			038 145 276	0-N174
04E 109 479 B	0-N2313	06B 903 341	0-N1662			038 145 278	0-N2047
04E 109 479 C	0-N2313	06B 903 341 B	0-N1662			038 198 119	SK-1582
04L 109 243 B	0-N2314	06D 109 243 C	0-N2208			038 198 119 A	SK-1372
04L 109 243 C	0-N2314	06D 109 244 C	0-N1346			038 198 119 C	SK-1372
04L 109 243 G	0-N2314	06D 109 244 D	0-N1346			038 198 119 D	SK-1111
04L 903 315 A	0-N2288	06D 109 244 E	0-N1346			038 198 119 D	SK-1258
04L 903 315 A	0-N2288S	06F 198 119 B	SK-1724			038 198 119 E	SK-1258
04L 903 315 B	0-N2288	06F 903 315	0-N1656			038 198 119 F	SK-1110
04L 903 315 B	0-N2288S	06F 903 315	0-N1656S			038 198 119 F	SK-1259
04L 903 315 F	0-N2288	06H 903 133 F	0-N2026			038 198 119 G	SK-1372
04L 903 315 F	0-N2288S	06H 903 133 F	0-N2026S			038 903 315 A	0-N1606
04L 903 315 G	0-N2288	06H 903 133 G	0-N2026			038 903 315 A	0-N1606S
04L 903 315 G	0-N2288S	06H 903 133 G	0-N2026S			038 903 315 AD	0-N1534
051 109 243	0-N808	06H 903 341 C	0-N2027			038 903 315 AD	0-N1534S
051 109 243 A	0-N129	06H 903 341 D	0-N2027			038 903 315 AE	0-N1494
051 198 119	SK-1090	06J 903 133 A	0-N1832			038 903 315 AE	0-N1494S
056 198 119	SK-1026	06J 903 133 A	0-N1832S			038 903 315 AG	0-N1534
058 109 244	0-N131	071 145 299 D	0-N2017			038 903 315 AG	0-N1534S
068 109 243	0-N806	071 145 299 D	0-N2017S			038 903 315 AH	0-N1534



SKODA

038 903 315 AH	0-N1534S
038 903 315 AJ	0-N1534
038 903 315 AJ	0-N1534S
038 903 315 AM	0-N1534
038 903 315 AM	0-N1534S
038 903 315 C	0-N1538
038 903 315 C	0-N1538S
038 903 315 D	0-N1441
038 903 315 D	0-N1441S
038 903 315 E	0-N1606
038 903 315 E	0-N1606S
038 903 315 F	0-N1494
038 903 315 F	0-N1494S
038 903 315 K	0-N1606
038 903 315 K	0-N1606S
038 903 315 P	0-N1441
038 903 315 P	0-N1441S
038 903 315 T	0-N1534
038 903 315 T	0-N1534S
03C 145 276 B	0-N2050
03C 145 276 C	0-N2133
03C 145 299 A	0-N2111
03C 145 299 A	0-N2111S
03C 145 299 AC	0-N2111
03C 145 299 AC	0-N2111S
03C 145 299 AF	0-N2111
03C 145 299 AF	0-N2111S
03C 145 299 C	0-N1733
03C 145 299 C	0-N1733S
03C 145 299 G	0-N2111
03C 145 299 G	0-N2111S
03C 145 299 H	0-N2111
03C 145 299 H	0-N2111S
03C 145 299 J	0-N2091
03C 145 299 J	0-N2091S
03C 145 299 K	0-N2111
03C 145 299 K	0-N2111S
03C 145 299 L	0-N2111
03C 145 299 L	0-N2111S
03C 145 299 M	0-N2092
03C 145 299 M	0-N2092S
03C 145 299 P	0-N2111
03C 145 299 P	0-N2111S
03C 145 299 Q	0-N1733
03C 145 299 Q	0-N1733S
03D 903 305 B	0-N1908
03D 903 305 B	0-N1908S
03D 903 305 F	0-N1908
03D 903 305 F	0-N1908S
03D 903 305 G	0-N1908
03D 903 305 G	0-N1908S
03E 903 133	0-N1908

SKODA

03E 903 133	0-N1908S
03E 903 133 A	0-N1908
03E 903 133 A	0-N1908S
03E 903 133 B	0-N1908
03E 903 133 B	0-N1908S
03F 145 276	0-N2121
03G 109 243	0-N1335
03G 109 244	0-N1336
03G 109 244 A	0-N1575
03G 198 119	SK-1595
03G 198 119 A	SK-1668
03G 198 119 B	SK-1595
03G 198 119 C	SK-1668
03L 109 243 A	0-N1905
03L 109 243 B	0-N2061
03L 109 243 D	0-N2061
03L 109 243 E	0-N1905
03L 109 243 F	0-N2061
03L 109 244	0-N2025
03L 109 244 B	0-N2025
03L 109 244 C	0-N1268
03L 109 244 D	0-N131
03L 109 244 E	0-N2025
03L 109 244 G	0-N2200
03L 109 244 H	0-N2200
03L 198 119	SK-1694
03L 198 119 A	SK-1695
03L 198 119 B	SK-1695
03L 198 119 C	SK-1727
03L 198 119 D	SK-1727
03L 198 119 F	SK-1727
045 109 243 A	0-N1048
045 109 243 C	0-N1048
045 109 243 F	0-N1045
045 109 244 A	0-N1268
045 109 479 B	0-N1274
045 903 315 A	0-N1704
045 903 315 A	0-N1704S
047 145 276 B	0-N1301
047 903 306	0-N2065
047 903 306	0-N2065S
047 903 306 C	0-N1956
047 903 306 C	0-N1956S
047 903 315	0-N2066
047 903 315 A	0-N2064
047 903 315 B	0-N2067
04C 109 244 B	0-N2381
04C 109 244 D	0-N2381
04C 109 479 G	0-N2313
04C 109 479 H	0-N2313
04C 109 479 J	0-N2313
04C 145 299 B	0-N2271

SKODA

04E 109 244 A	0-N2381
04E 109 244 B	0-N2381
04E 109 244 D	0-N2381
04E 109 244 E	0-N2381
04E 109 479 A	0-N2313
04E 109 479 B	0-N2313
04E 109 479 C	0-N2313
04L 109 243 B	0-N2314
04L 109 243 C	0-N2314
04L 109 243 G	0-N2314
04L 903 315 A	0-N2288
04L 903 315 A	0-N2288S
04L 903 315 B	0-N2288
04L 903 315 B	0-N2288S
04L 903 315 F	0-N2288
04L 903 315 F	0-N2288S
04L 903 315 G	0-N2288
04L 903 315 G	0-N2288S
058 109 244	0-N131
058 260 511	0-N1317
058 260 511	0-N1317S
058 903 133	0-N1822
058 903 133	0-N1822S
058 903 133 B	0-N1822
058 903 133 B	0-N1822S
058 903 133 C	0-N1822
058 903 133 C	0-N1822S
058 903 133 D	0-N1822
058 903 133 D	0-N1822S
059 109 243 D	0-N1266
059 109 243 F	0-N201
059 109 243 G	0-N201
059 109 243 J	0-N1266
059 109 243 L	0-N201
059 109 244	0-N168
059 109 244 A	0-N168
059 109 244 B	0-N168
059 109 479 B	0-N1364
059 109 487 A	0-N1363
059 109 487 B	0-N1363
059 109 487 C	0-N1363
059 145 276	0-N1308
059 145 283 A	0-N2196
059 145 284	0-N1947
059 145 284 B	0-N1947
059 198 119	SK-1619
059 198 119 A	SK-1619
059 198 119 B	SK-1619
059 260 523 A	0-N1005
059 260 523 B	0-N1005
059 903 341	0-N1315
059 903 341 A	0-N1431

SKODA

059 903 341 E	0-N1431
059 903 341 J	0-N1431
06A 109 181	0-N2234
06A 109 243 A	0-N2195
06A 109 479	0-N157
06A 109 479 A	0-N157
06A 109 479 B	0-N157
06A 109 479 C	0-N157
06A 198 119	SK-1109
06A 198 119 A	SK-1337
06A 198 119 B	SK-1660
06A 903 315 D	0-N1041
06A 903 315 D	0-N1041S
06A 903 315 E	0-N1041
06A 903 315 E	0-N1041S
06A 903 315 F	0-N1041
06A 903 315 F	0-N1041S
06B 109 243	0-N1654
06B 109 243 A	0-N1042
06B 109 243 B	0-N1050
06B 109 243 D	0-N1042
06B 109 243 E	0-N1050
06B 109 243 F	0-N1042
06B 109 244	0-N1316
06B 109 477	0-N1237
06B 109 477 A	0-N1051
06B 109 477 A	0-N1051S
06B 109 479	0-N1237
06B 198 119	SK-1660
06B 198 119 A	SK-1640
06B 198 119 C	SK-1726
06D 109 243 C	0-N2208
06D 109 244 C	0-N1346
06D 109 244 D	0-N1346
06D 109 244 E	0-N1346
06F 198 119 B	SK-1724
06F 903 315	0-N1656
06F 903 315	0-N1656S
06J 903 133 A	0-N1832
06J 903 133 A	0-N1832S
078 109 243 Q	0-N1238
078 109 243 R	0-N1238
078 109 243 S	0-N1238
078 109 244 H	0-N2001
078 109 244 J	0-N2001
078 109 479 E	0-N1275
078 109 487 A	0-N1371
078 109 487 C	0-N1371
078 198 119	SK-1383
078 198 479	SK-1377
078 903 133 AB	0-N1083
078 903 133 AB	0-N1083S

SKODA

1J0 145 276	0-N1454
1J0 145 299	0-N1733
1J0 145 299	0-N1733S
6K0 198 001 D	SK-1074
6Q0 145 299	0-N1525
6Q0 145 299	0-N1525S
6QD 145 276	0-N1454

SMART

0015956V001000000	0-N2020
132 200 00 70	0-N2404
132 200 00 70	0-N2404S
1322000170	0-N2297
1322000270	0-N2297
1322300010	0-N2297
639 200 03 70	0-N2419
6392000470	0-N2402
6392000470	0-N2402S
A132 200 00 70	0-N2404
A132 200 00 70	0-N2404S
A1322000170	0-N2297
A1322000270	0-N2297
A1322300010	0-N2297

SSANGYONG

111 200 00 70	0-N1833
6012001070	0-N1288
66520-00170	0-N2226
66520-00170	0-N2226S
66520-00270	0-N2226
66520-00270	0-N2226S
66520-00370	0-N2226
66520-00370	0-N2226S
6712000270	0-N2388
6712000270	0-N2388S
6712000370	0-N2388
6712000370	0-N2388S

SUBARU

13033-AA000	0-N1767
13033-AA001	0-N1767
13033-AA002	0-N1767
13033-AA040	0-N1767
13033-AA041	0-N1767
13033-AA042	0-N1767
13069-AA034	0-N1223
13069-AA035	0-N1223
13069-AA036	0-N1223
13069-AA037	0-N1223
13069-AA060	0-N1828
13069-AA062	0-N1828
13069-AA063	0-N1828
13069-AA070	0-N2325
13070-KA010	0-N1071
13070-KA020	0-N1244

SUBARU

13070-KA031	0-N1829
13073-AA080	0-N1225
13073-AA081	0-N1225
13073-AA082	0-N1225
13073-AA140	0-N1225
13073-AA142	0-N1225
13073-AA150	0-N1783
13073-AA180	0-N1225
13073-AA190	0-N1775
13073-AA200	0-N1777
13073-AA220	0-N1776
13073-AA230	0-N1776
13085-AA010	0-N1226
13085-AA020	0-N1782
13085-AA070	0-N1226
13085-AA080	0-N1226
13085-AA100	0-N1226
13085-AA101	0-N1226
23769-AA000	0-N2182
23769-AA000	0-N2182S
23769-AA001	0-N2182
23769-AA001	0-N2182S
23769-AA002	0-N2182
23769-AA002	0-N2182S
23769-AA003	0-N2182
23769-AA003	0-N2182S
23769-AA020	0-N2230
23769-AA020	0-N2230S
23770-AA040	0-N2374
73131-AC000	0-N1724
73131-AC000	0-N2102
73131-AC010	0-N2102
73131-FC000	0-N1724
73131-FC000	0-N2102

SUZUKI

10141-997	0-N1694
12760-67J00	SK-1534
12760-67JG1	0-N1323
12760-67JG1	SK-1580
12760-67JG1-000	0-N1323
12760-80KA0	SK-1698
12760-84A00	SK-1487
12760-84A01	SK-1487
12760-84A50	SK-1487
12781-79J50	0-N1326
12781-79J50	0-N2149
12781-79J51	0-N1326
12781-79J51	0-N2149
12810-53A00	0-N017
12810-53B00	0-N020
12810-53B01	0-N020
12810-66G00	0-N901

SUZUKI

12810-66G00-000	0-N901
12810-67G00	0-N118P
12810-67G01	0-N118P
12810-67G01-000	0-N118P
12810-67G10	0-N1357
12810-67G10-000	0-N1357
12810-71C00	0-N916
12810-71C01	0-N916
12810-71C02	0-N916
12810-73001	0-N017
12810-73002	0-N017
12810-73003	0-N017
12810-73J01	0-N1062
12810-73J01-000	0-N1062
12810-76G00	0-N2322
12810-76G10	0-N2322
12810-78E01	0-N1216
12810-79J50	0-N115
12810-79J51	0-N115
12810-79J52	0-N115
12810-81400	0-N973
12810-81401	0-N973
12810-81402	0-N973
12810-82000	0-N018
12810-82001	0-N018
12810-82002	0-N018
12810-82003	0-N018
12810-84000	0-N017
12810-84001	0-N017
12810-86500	0-N019
12810-86501	0-N019
12810-86CA0	0-N900
12810-M76G10	0-N2322
12823-66G00	0-N900
12823-66G00-000	0-N900
12823-67G00	0-N119P
12823-67G01	0-N119P
12823-73J00	0-N1066
12823-73J00-000	0-N1066
12830-86CA0	0-N901
17530-77E00	0-N1938
17540-67JA0	0-N1804
17540-67JA0	0-N1804S
17540-67JA0-000	0-N1804
17540-67JA0-000	0-N1804S
17540-67JA1	0-N1804
17540-67JA1	0-N1804S
17540-67JA1-000	0-N1804
17540-67JA1-000	0-N1804S
17540-67JA2	0-N1804
17540-67JA2	0-N1804S
17540-67JA2-000	0-N1804

SUZUKI

17540-67JA2-000	0-N1804S
17540-69K01	0-N1339
17540-69K01	0-N1339S
17540-77E00	0-N1876
17540-77E00	0-N1876S
17540-77E10	0-N1876
17540-77E10	0-N1876S
17540-77EA1	0-N1876
17540-77EA1	0-N1876S
17540-77EA3	0-N1876
17540-77EA3	0-N1876S
17540-85E00	0-N1526
17540-85E00	0-N1526S
21006-508	0-N1694
49160-64J01	0-N2106
49160-64J02	0-N2106
49160-66G00	0-N1320
49160-66G00-000	0-N1320
49160-67J00	0-N2052
49160-70AA0	0-N2023
49160-73J00	0-N1636
49160-73J00	0-N1636S
49160-77E00	0-N2239
49160-77E01	0-N2239
49160-81A00	0-N2106
49160-84A80	0-N2405
49160-84A80	0-N2405S
49170-65D40	0-N2118
49170-73J00	0-N1418
49170-84A80	0-N1307
95131-67J00	0-N1965
95131-67J11	0-N2228
95131-76K00	0-N1965

TATA

2789 0511 0101	0-N2385
2789 0511 0102	0-N2386
2790 2312 0142	0-N2379
2790 2312 0152	0-N2378
2797 0511 0101	0-N2331
2798 0511 0105	0-N2330

TOYOTA

13503-10011	0-N006
13503-10021	0-N006
13503-11030	0-N008
13503-11040	0-N008
13503-27010	0-N1329
13503-50010	0-N2058
13503-50011	0-N2058
13503-54010	0-N989
13503-54020	0-N989
13503-54030	0-N014
13503-62010	0-N994



TOYOTA

13503-62030	0-N994
13503-62040	0-N1773
13503-63010	0-N991
13503-63011	0-N991
13503-63020	0-N991
13503-63021	0-N991
13503-64020	0-N996
13503-64021	0-N996
13503-65010	0-N1250
13503-70040	0-N991
13503-88360	0-N991
13503-88361	0-N991
13503-88380	0-N991
13505-02020	0-N998
13505-02030	0-N999
13505-0L010	0-N176
13505-11010	0-N005
13505-11011	0-N005
13505-11020	0-N005
13505-11040	0-N007
13505-11050	0-N007
13505-15041	0-N997
13505-15050	0-N999
13505-15060	0-N999
13505-16010	0-N998
13505-16011	0-N998
13505-16020	0-N998
13505-16021	0-N998
13505-17020	0-N2320
13505-20010	0-N993
13505-20020	0-N993
13505-20030	0-N1761
13505-27010	0-N1328
13505-27010-F	0-N1328
13505-46041	0-N1549
13505-50030	0-N1883
13505-50030	0-N1883S
13505-54010	0-N988
13505-54020	0-N013
13505-54021	0-N013
13505-55020	0-N1754
13505-62020	0-N1879
13505-62031	0-N993
13505-62050	0-N993
13505-62060	0-N993
13505-62070	0-N1879
13505-63010	0-N990
13505-63011	0-N990
13505-63021	0-N990
13505-64011	0-N995
13505-64012	0-N995
13505-64020	0-N995

TOYOTA

13505-64021	0-N995
13505-65040	0-N1774
13505-67040	0-N176
13505-67041	0-N176
13505-67050	0-N1618
13505-74010	0-N992
13505-74011	0-N992
13505-74030	0-N001
13505-87704	0-N039
13505-88382	0-N000
13505-88383	0-N000
13540-0L010	0-N1819
13540-17011	0-N1821
13540-27010	0-N1820
13540-27011	0-N1820
13540-50011	0-N1823
13540-50030	0-N1823
13540-67010	0-N1819
13540-67020	0-N1819
13540-88480	0-N2298
13570-22010	0-N1982
13570-YV010	0-N1418
16601-28041	0-N2185
16601-28050	0-N2185
16601-YV010	0-N1339
16601-YV010	0-N1339S
16603-0R010	0-N2040
16603-0W010	0-N2189S
16603-0W030	0-N2189S
16603-23010	0-N1983
16603-23011	0-N1983
16603-31010	0-N1878
16603-31020	0-N1878
16603-31030	0-N1878
16603-31040	0-N1878
16603-31050	0-N1878
16603-51010	0-N2360
16603-97401	0-N1983
16603-B0010	0-N2273
16604-23020	0-N1981
16604-26010	0-N2051
16604-26011	0-N2051
16604-31010	0-N1728
16604-31020	0-N1728
16604-50010	0-N2186
16604-50030	0-N2186
16620-0H020	0-N2184
16620-0H020	0-N2184S
16620-0L020	0-N1880
16620-0L020	0-N1880S
16620-0R010	0-N1482S
16620-0W015	0-N2183

TOYOTA

16620-0W015	0-N2183S
16620-0W016	0-N2183
16620-0W016	0-N2183S
16620-0W020	0-N1877
16620-0W020	0-N1877S
16620-0W021	0-N1877
16620-0W021	0-N1877S
16620-0W022	0-N1877
16620-0W022	0-N1877S
16620-0W023	0-N1877
16620-0W023	0-N1877S
16620-0W024	0-N1877
16620-0W024	0-N1877S
16620-0W025	0-N1877
16620-0W025	0-N1877S
16620-0W026	0-N1877
16620-0W026	0-N1877S
16620-0W036	0-N2187
16620-0W090	0-N1462
16620-0W090	0-N1462S
16620-0W091	0-N1462
16620-0W091	0-N1462S
16620-0W092	0-N1462
16620-0W092	0-N1462S
16620-0W093	0-N1462
16620-0W093	0-N1462S
16620-0W100	0-N2187
16620-0W101	0-N2187
16620-0W110	0-N1810
16620-0W110	0-N1810S
16620-22010	0-N1462
16620-22010	0-N1462S
16620-22011	0-N1462
16620-22011	0-N1462S
16620-22012	0-N1462
16620-22012	0-N1462S
16620-22013	0-N1462
16620-22013	0-N1462S
16620-27020	0-N2098
16620-27020	0-N2098S
16620-27021	0-N2098
16620-27021	0-N2098S
16620-28010	0-N1810
16620-28010	0-N1810S
16620-28011	0-N1810
16620-28011	0-N1810S
16620-28040	0-N2184
16620-28040	0-N2184S
16620-28041	0-N2184
16620-28041	0-N2184S
16620-28070	0-N1810
16620-28070	0-N1810S

TOYOTA

16620-28090	0-N1810
16620-28090	0-N1810S
16620-30010	0-N2192
16620-30010	0-N2192S
16620-30031	0-N1880
16620-30031	0-N1880S
16620-31010	0-N2188
16620-31010	0-N2188S
16620-31011	0-N2188
16620-31011	0-N2188S
16620-31012	0-N2188
16620-31012	0-N2188S
16620-31021	0-N2032
16620-31021	0-N2032S
16620-31040	0-N2032
16620-31040	0-N2032S
16620-31050	0-N2032
16620-31050	0-N2032S
16620-33020	0-N2107
16620-33020	0-N2107S
16620-33040	0-N2107
16620-33040	0-N2107S
16620-46031	0-N1877
16620-46031	0-N1877S
16620-46032	0-N1877
16620-46032	0-N1877S
16620-46060	0-N1877
16620-46060	0-N1877S
16620-46070	0-N1877
16620-46070	0-N1877S
16620-47010	0-N2198
16620-47010	0-N2198S
16620-47020	0-N2088
16620-47020	0-N2088S
16620-47030	0-N2393
16620-47030	0-N2393S
16620-51011	0-N2301
16620-51011	0-N2301S
16620-WA010	0-N2387
16620-WA010	0-N2387S
16630-21020	0-N2201
16630-97402	0-N2229
16630-WA010	0-N2369
44350-12051	0-N1541
44350-12052	0-N1541
88440-17010	0-N1725
88440-20160	0-N1725
88440-20170	0-N1725
88441-0D010	0-N2304
SU001-00088	0-N118P
SU001-00089	0-N1381
SU001-00542	0-N1066

TOYOTA

SU001-00543	0-N1062
SU00-100545	SK-1391
SU001-00784	0-N1381
SU001-01050	0-N2424

VAUXHALL

06 36 591	0-N1717
06 36 591	0-N1717S
06 36 654	0-N102
06 36 728	SK-1508
12605175	0-N2299
12605175	0-N2299S
12605492	0-N2283
1340584	0-N2299
1340584	0-N2299S
16 06 189	SK-1113
16 06 190	SK-1073
16 06 193	SK-1165
16 06 194	SK-1478
16 06 195	SK-1166
16 06 196	SK-1632
16 06 197	SK-1163
16 06 198	SK-1644
16 06 199	SK-1644
16 06 262	SK-1355
16 06 274	SK-1073
16 06 281	SK-1113
16 06 305	SK-1667
16 06 306	SK-1355
16 06 314	SK-1607
16 06 366	SK-1611
16 06 384	SK-1481
16 06 389	SK-1481
16 06 390	SK-1481
16 29 002	SK-1644
16 29 005	SK-1723
1606198	SK-1644
1606385	SK-1169
18 54 297	0-N2283
24412292	0-N1422
24412292	0-N1422S
24426500	0-N102
24430296	0-N1588
24430296	0-N1588S
40 01 428	SK-1489
45 01 801	SK-1680
45 01 807	SK-1153
45 06 085	SK-1489
55190812	0-N1667
55350422	0-N1799
55350422	0-N1799S
55350580	0-N953
55350960	0-N1437

VAUXHALL

55353810	0-N1369
55556090	0-N1799
55556090	0-N1799S
55567191	0-N102
55581830	0-N2254
56 36 403	0-N1085
56 36 739	0-N1085
63 40 552	0-N1799
63 40 552	0-N1799S
63 40 558	0-N1799
63 40 558	0-N1799S
636728	SK-1508
66 06 028	SK-1696
66 06 029	SK-1586
90264022	0-N875
90323501	0-N877
90323503	0-N876
90324097	0-N1603
90353176	0-N948
90409238	0-N1439
90409783	0-N1438
90409783	0-N1438S
90411025	0-N1322
90411025	0-N1322S
90411769	0-N101
90411773	0-N907
90411774	0-N100
90411782	0-N906
90411787	0-N909
90412730	0-N953
90412731	0-N952
90412783	0-N102
90412884	0-N1464
90412884	0-N1464S
90466474	0-N957
90499401	0-N948
90500229	0-N1422
90500229	0-N1422S
90502129	0-N1422
90502129	0-N1422S
90509168	0-N1303
90509273	0-N1304
90509282	0-N1305
90511627	0-N1304
90528200	0-N101
90528603	0-N1383
90528760	0-N1438
90528760	0-N1438S
90529187	0-N957
90529188	0-N957
90529810	0-N127
90529913	0-N1437

VAUXHALL

90530123	0-N102
90530124	0-N101
90530125	0-N100
90530126	0-N1383
90542637	0-N2169
90542860	0-N957
90543739	0-N957
90543873	0-N1303
90570525	0-N948
90570913	0-N952
90571758	0-N1466
90571758	0-N1466S
90710530	0-N910
91 08 204	0-N821
91 09 416	0-N199
91 09 428	SK-1489
91 09 430	0-N1269
91 09 489	0-N147
91 09 566	0-N1611
91 09 566	0-N1611S
91 09 609	0-N173
91 10 631	0-N199
91 10 632	0-N1106
91 10 639	0-N147
91 10 690	0-N854
91 11 144	0-N816
91 18 848	0-N1303
91 20 501	SK-1508
91 28 444	0-N956
91 28 516	0-N102
91 28 656	0-N102
91 28 736	0-N906
91 28 739	0-N953
91 28 740	0-N952
91 28 741	0-N909
91 58 004	0-N100
91 60 341	0-N1650
91 61 255	0-N1591
91 62 101	SK-1680
91 62 107	SK-1153
91 98 527	0-N1307
9109416	SK-1490
9109416	SK-1622
91094632	SK-1490
91094639	SK-1490
9110632	SK-1490
9110639	SK-1490
91158706	SK-1493
91159961	0-N1611
91159961	0-N1611S
91160164	0-N1173
91160164	0-N173

VAUXHALL

91580003	0-N101
92 01 527	SK-1489
92 01 537	0-N1269
92 01 540	0-N1270
92 02 478	0-N948
92 02 550	0-N1438
92 02 550	0-N1438S
92 40 033	0-N300
92 66 523	0-N1396
92065368	0-N1369
93160237	0-N1173
93160244	0-N1365
93160256	0-N1307
93160746	0-N1611
93160746	0-N1611S
93160779	0-N1409
93161478	SK-1493
93171389	0-N1396
93172026	0-N2072
93174119	SK-1113
93174120	SK-1073
93174260	SK-1100
93174261	SK-1100
93174262	SK-1165
93174263	SK-1478
93174264	SK-1166
93174265	SK-1632
93174266	SK-1163
93174267	SK-1644
93174268	SK-1644
93180218	SK-1355
93180219	SK-1073
93183572	SK-1113
93185845	SK-1355
93185849	SK-1607
93188137	SK-1481
93188138	SK-1481
93188674	SK-1508
93191277	SK-1696
93191278	SK-1586
93196790	SK-1611
93196791	SK-1481
94106001	0-N878
9-41239-72	0-N046
94149432	0-N879
94215197	0-N042
94220900	0-N047
94364816	0-N1768
94382214	0-N049
94382215	0-N050
94386488	0-N2167
94472349	0-N045



VAUXHALL

95507813	SK-1644
95507816	SK-1723
97112438	0-N126
97114552	0-N126
97116002	0-N1768
97129939	0-N878
97136256	0-N1765
97137148	0-N2168
97146877	0-N1765S
97184929	0-N1495S
97184930	0-N1426
97222553	0-N1495S
97229131	0-N1355
97229132	0-N1354
97241065	0-N1633
97249944	0-N1085
97249945	0-N1085
97250750	0-N1649
97309459	0-N878
97312462	0-N1717
97312462	0-N1717S
97364344	0-N1495S
97381208	0-N1354
97383061	0-N1717
97383061	0-N1717S

VOLVO

1257120	0-N807
1275380	0-N1518
1275380	0-N1518S
1275409	0-N1350
13369533	0-N917
1357936	0-N162
1378122	0-N1231
271705	SK-1174
271856	SK-1103
271876	SK-1265
274518	SK-1492
274550	SK-1325
274557	SK-1493
3062 1261	0-N854
30621270	0-N1729
30621284	0-N1611
30621284	0-N1611S
30621589	SK-1493
30622153	0-N1884
30623983	0-N1409
30637070	0-N1491S
30637071	0-N1451
30637141	0-N1529
30637141	0-N1529S
30637505	0-N1418
30637955	0-N1324

VOLVO

30637961	0-N1491S
30637962	0-N1451
30638276	0-N1884
30638277	0-N137
30638278	0-N1349
30638574	0-N1611
30638574	0-N1611S
30638631	0-N1409
30638633	0-N1611
30638633	0-N1611S
30650927	0-N2037
30650927	0-N2037S
30650957	0-N2096
30650957	0-N2096S
30652243	0-N1409
30677134	0-N1349
30677832	0-N1573
30684210	0-N137
30684344	0-N1639
30684344	0-N1639S
30684427	0-N2037
30684427	0-N2037S
30711066	SK-1424
30711069	0-N1066
30711320	0-N1554
30711320	0-N1554S
30729939	0-N1451
30731727	SK-1492
30731765	0-N1339
30731765	0-N1339S
30731774	0-N1349
30731938	0-N1497
30731938	0-N1497S
3075 0739	0-N147
3075 7330	0-N1964
3075 7330	0-N1964S
30750904	0-N294
30750905	0-N1564
30757056	0-N1491S
30757057	0-N1529
30757057	0-N1529S
30757282	0-N1979
30757282	0-N1979S
30758108	0-N1418
30758260	SK-1103
30758261	SK-1491
30758263	SK-1531
30758267	SK-1643
30758269	SK-1618
30758270	SK-1747
3077 7726	0-N1964
3077 7726	0-N1964S

VOLVO

30777354	0-N1991
30777406	SK-1705
30777407	SK-1707
30777408	SK-1493
30777409	SK-1084
30777409	SK-1114
30777528	SK-1707
30777695	0-N2242
30777695	0-N2242S
30812354	0-N152
30812354	0-N152S
30813134	0-N1729
3085 5992	0-N854
30852898	0-N1470
30852898	0-N1470S
30855993	0-N173
3086 4050	0-N147
3086 5078	0-N147
30873954	0-N056
30874227	0-N055
30883811	0-N1173
30883833	0-N1611
30883833	0-N1611S
30883834	0-N1307
30889400	0-N148
31216066	0-N2243
31216514	0-N2042
31216514	0-N2042S
3125 1337	0-N1964
3125 1337	0-N1964S
3125 1429	0-N1964
3125 1429	0-N1964S
3125 8145	0-N1964
3125 8145	0-N1964S
3125 8153	0-N1964
3125 8153	0-N1964S
31251129	0-N1339
31251129	0-N1339S
31251250	0-N1529
31251250	0-N1529S
31251251	0-N1979
31251251	0-N1979S
31251252	0-N1491S
31251254	SK-1666
31251653	0-N2190
31251653	0-N2190S
31251654	0-N2109
31251654	0-N2109S
31251700	SK-1424
31258034	0-N2269
31258034	0-N2269S
31258305	SK-1608

VOLVO

31272239	0-N2353
31316434	0-N1502
31316434	0-N1502S
31316658	0-N1349
31316844	0-N1062
31316999	0-N1349
3133 0379	0-N1964
3133 0379	0-N1964S
31330198	0-N2224
31330200	0-N2382
31330202	SK-1728
31330416	0-N2057
31330914	0-N2363
31339542	0-N1349
31339887	0-N2382
31339888	SK-1728
31359568	SK-1608
31370046	SK-1728
31370047	0-N2224
31401193	0-N2243
31401286	0-N2242
31401286	0-N2242S
32877763	0-N887
32877789	0-N883
3342143	0-N856
3343 740	0-N854
3343741	0-N173
3343893	SK-1012
3531186	0-N2315
35311869	0-N2315
3531279	0-N960
3547543	0-N1231
35475433	0-N1231
463633	0-N860
6842593	0-N919
8610041	SK-1103
8630590	0-N958
8642248	0-N148
8642251	0-N137
8653 652	0-N1334
8653649	SK-1594
8653651	0-N1327
8658225	0-N1362
8658339	0-N1349
8670484	0-N137
8677 053	0-N116
8687851	0-N137
8692561	0-N1350
8692630	0-N137
8692809	0-N2096
8692809	0-N2096S
8692810	0-N1554



VOLVO		VW		VW		VW	
8692810	0-N1554S	022 145 299 E	0-N1676S	030 109 243 L	0-N1331	037 903 315 C	0-N1660
9135 555	0-N959	022 145 299 H	0-N2209	030 109 243 M	0-N1331	038 109 243	0-N107
9135 555-0	0-N959	022 145 299 H	0-N2209S	030 109 243 N	0-N1331	038 109 243 D	0-N107
9135 555-2	0-N959	022 145 299 L	0-N2209	030 109 243 P	0-N1331	038 109 243 F	0-N107
9135036	0-N930	022 145 299 L	0-N2209S	030 109 243 R	0-N1331	038 109 243 G	0-N107
91350363	0-N930	023 109 243	0-N1444	030 145 299 C	0-N1445	038 109 243 H	0-N107
9135556	0-N172	026 109 243	0-N805	030 145 299 C	0-N1445S	038 109 243 M	0-N1045
9135565	0-N1406	026 109 243 A	0-N805	030 145 299 F	0-N1445	038 109 243 N	0-N107
9135699	0-N1448	026 109 243 C	0-N805	030 145 299 F	0-N1445S	038 109 244 B	0-N166
9135937	0-N1232	026 109 243 E	0-N805	030 198 119 A	SK-1131	038 109 244 C	0-N166
91359372	0-N1232	026 109 243 F	0-N805	030 198 119 B	SK-1592	038 109 244 E	0-N167
9135946	0-N163	026 109 243 G	0-N805	032 145 276	0-N1310	038 109 244 H	0-N166
91359463	0-N163	026 109 243 L	0-N805	032 145 299 A	0-N1539	038 109 244 J	0-N1046
9143643	0-N1425	026 198 119	SK-1101	032 145 299 A	0-N1539S	038 109 244 M	0-N166
9146139	0-N143	027 109 243	0-N808	032 145 299 C	0-N1459	038 109 244 N	0-N1046
9146249	0-N1558S	027 198 119	SK-1124	032 145 299 C	0-N1459S	038 109 244 P	0-N131
9146258	0-N920	028 109 243	0-N103	032 198 119	SK-1074	038 109 244 Q	0-N167
9146376	0-N958	028 109 243 B	0-N103	036 109 181 A	0-N164	038 109 244 R	0-N166
9146377	0-N958	028 109 243 D	0-N111	036 109 181 B	0-N164	038 145 276	0-N174
91463778	0-N958	028 109 243 E	0-N104	036 109 243 AB	0-N158	038 145 278	0-N2047
9146693	0-N2223	028 109 243 F	0-N104	036 109 243 AC	0-N1263	038 145 299 A	0-N2139
9179314	0-N1953	028 109 243 G	0-N111	036 109 243 AD	0-N158	038 198 119	SK-1582
9179314	0-N1953S	028 109 243 H	0-N1332	036 109 243 AE	0-N1263	038 198 119 A	SK-1372
9180594	0-N117	028 109 243 J	0-N1332	036 109 243 AF	0-N158	038 198 119 B	SK-1378
9180687	0-N1382	028 109 243 K	0-N1332	036 109 243 AG	0-N1263	038 198 119 B	SK-1388
9186 258	0-N116	028 109 244	0-N128	036 109 243 D	0-N1258	038 198 119 C	SK-1372
9207905	0-N1424	028 109 244 B	0-N128	036 109 243 E	0-N158	038 198 119 D	SK-1111
9207927	0-N110	028 145 278	0-N1417	036 109 243 F	0-N159	038 198 119 D	SK-1258
92079276	0-N110	028 145 278 A	0-N1417	036 109 243 G	0-N1258	038 198 119 E	SK-1258
9440329	0-N137	028 145 278 E	0-N1417	036 109 243 J	0-N1258	038 198 119 F	SK-1110
9440904	0-N1362	028 145 278 J	0-N1432	036 109 243 K	0-N1263	038 198 119 F	SK-1259
9458470	0-N1647	028 145 278 J	0-N1432S	036 109 243 L	0-N158	038 198 119 G	SK-1372
9464 101	0-N116	028 145 278 M	0-N1675	036 109 243 R	0-N158	038 903 315 A	0-N1606
9464 1016	0-N116	028 198 119	SK-1029	036 109 243 S	0-N1263	038 903 315 A	0-N1606S
9487405	0-N2363	028 198 119 A	SK-1122	036 109 244	0-N165	038 903 315 AD	0-N1534
9497331	0-N1529	028 198 119 B	SK-1069	036 109 244 C	0-N1262	038 903 315 AD	0-N1534S
9497331	0-N1529S	028 198 119 C	SK-1098	036 109 244 D	0-N1262	038 903 315 AE	0-N1494
		028 198 119 D	SK-1593	036 109 244 G	0-N165	038 903 315 AE	0-N1494S
		028 198 119 E	SK-1425	036 109 244 J	0-N1262	038 903 315 AG	0-N1534
		028 198 119 F	SK-1106	036 109 244 K	0-N131	038 903 315 AG	0-N1534S
		028 198 119 G	SK-1512	036 145 299	0-N1890	038 903 315 AH	0-N1534
		028 903 308 F	0-N1925	036 145 299	0-N1890S	038 903 315 AH	0-N1534S
		028 903 315 M	0-N1432	036 198 119 A	SK-1511	038 903 315 AJ	0-N1534
		028 903 315 N	0-N1609	036 198 119 B	SK-1585	038 903 315 AJ	0-N1534S
		028 903 315 P	0-N1920	036 198 119 C	SK-1511	038 903 315 AM	0-N1534
		028 903 315 R	0-N1609	036 198 119 E	SK-1511	038 903 315 AM	0-N1534S
		030 109 119 F	SK-1344	036 245 276	0-N1605	038 903 315 C	0-N1538
		030 109 243 C	0-N105	037 145 276	0-N1311	038 903 315 C	0-N1538S
		030 109 243 D	0-N106	037 145 276 A	0-N1311	038 903 315 D	0-N1441
		030 109 243 F	0-N106	037 198 119	SK-1120	038 903 315 D	0-N1441S
		030 109 243 J	0-N106	037 903 315 A	0-N1660	038 903 315 E	0-N1606
		030 109 243 K	0-N106	037 903 315 B	0-N1660	038 903 315 E	0-N1606S

VW	
00A 145 299	0-N1951
00A 903 315	0-N1703
00A 903 341	0-N1833
021 145 299 B	0-N1657
021 145 299 B	0-N1657S
021 145 299 C	0-N1657
021 145 299 C	0-N1657S
022 145 276	0-N1740
022 145 276 A	0-N2110
022 145 276 C	0-N1715
022 145 276 F	0-N1715
022 145 299 C	0-N2209
022 145 299 C	0-N2209S
022 145 299 E	0-N1676



VW		VW		VW		VW	
038 903 315 F	0-N1494	03G 198 119 A	SK-1668	04E 109 479 B	0-N2313	059 145 201 F	0-N1918S
038 903 315 F	0-N1494S	03G 198 119 B	SK-1595	04E 109 479 C	0-N2313	059 145 276	0-N1308
038 903 315 K	0-N1606	03G 198 119 C	SK-1668	04L 109 243 B	0-N2314	059 145 283 A	0-N2196
038 903 315 K	0-N1606S	03G 903 315 A	0-N1530	04L 109 243 C	0-N2314	059 145 284	0-N1947
038 903 315 P	0-N1441	03G 903 315 A	0-N1530S	04L 109 243 G	0-N2314	059 145 284 B	0-N1947
038 903 315 P	0-N1441S	03G 903 315 D	0-N1531	04L 903 315 A	0-N2288	059 198 119	SK-1619
038 903 315 T	0-N1534	03G 903 315 D	0-N1531S	04L 903 315 A	0-N2288S	059 198 119 A	SK-1619
038 903 315 T	0-N1534S	03L 109 243 A	0-N1905	04L 903 315 B	0-N2288	059 198 119 B	SK-1619
03C 145 276 B	0-N2050	03L 109 243 B	0-N2061	04L 903 315 B	0-N2288S	059 260 523 A	0-N1005
03C 145 276 C	0-N2133	03L 109 243 D	0-N2061	04L 903 315 F	0-N2288	059 260 523 B	0-N1005
03C 145 299 A	0-N2111	03L 109 243 E	0-N1905	04L 903 315 F	0-N2288S	059 903 133 F	0-N2287
03C 145 299 A	0-N2111S	03L 109 243 F	0-N2061	04L 903 315 G	0-N2288	059 903 133 F	0-N2287S
03C 145 299 AC	0-N2111	03L 109 244	0-N2025	04L 903 315 G	0-N2288S	059 903 133 J	0-N2287
03C 145 299 AC	0-N2111S	03L 109 244 B	0-N2025	051 109 243	0-N808	059 903 133 J	0-N2287S
03C 145 299 AF	0-N2111	03L 109 244 C	0-N1268	051 109 243 A	0-N129	059 903 341	0-N1315
03C 145 299 AF	0-N2111S	03L 109 244 D	0-N131	051 198 119	SK-1090	059 903 341 A	0-N1431
03C 145 299 C	0-N1733	03L 109 244 E	0-N2025	056 198 119	SK-1026	059 903 341 E	0-N1431
03C 145 299 C	0-N1733S	03L 109 244 G	0-N2200	057 109 243 M	0-N1337	059 903 341 F	0-N1907
03C 145 299 G	0-N2111	03L 109 244 H	0-N2200	058 109 243 C	0-N1236	059 903 341 G	0-N1795
03C 145 299 G	0-N2111S	03L 198 119	SK-1694	058 109 243 E	0-N1236	059 903 341 H	0-N1795
03C 145 299 H	0-N2111	03L 198 119 A	SK-1695	058 109 244	0-N131	059 903 341 J	0-N1431
03C 145 299 H	0-N2111S	03L 198 119 B	SK-1695	058 109 479	0-N1276	062 145 278	0-N846
03C 145 299 J	0-N2091	03L 198 119 C	SK-1727	058 109 479 B	0-N1276	062 145 278 A	0-N2350
03C 145 299 J	0-N2091S	03L 198 119 D	SK-1727	058 198 119	SK-1346	062 145 299A	0-N2391
03C 145 299 K	0-N2111	03L 198 119 F	SK-1727	058 198 479	SK-1638	062 145 299A	0-N2391S
03C 145 299 K	0-N2111S	044 145 278 A	0-N1312	058 260 511	0-N1317	068 109 243	0-N806
03C 145 299 L	0-N2111	044 903 315 C	0-N1891	058 260 511	0-N1317S	068 109 243 C	0-N806
03C 145 299 L	0-N2111S	045 109 243 A	0-N1048	058 903 133	0-N1822	068 109 243 F	0-N806
03C 145 299 M	0-N2092	045 109 243 B	0-N1265	058 903 133	0-N1822S	069 109 243 B	0-N807
03C 145 299 M	0-N2092S	045 109 243 C	0-N1048	058 903 133 B	0-N1822	06A 109 181	0-N2234
03C 145 299 P	0-N2111	045 109 243 D	0-N1265	058 903 133 B	0-N1822S	06A 109 243 A	0-N2195
03C 145 299 P	0-N2111S	045 109 243 F	0-N1045	058 903 133 C	0-N1822	06A 109 479	0-N157
03C 145 299 Q	0-N1733	045 109 244 A	0-N1268	058 903 133 C	0-N1822S	06A 109 479 A	0-N157
03C 145 299 Q	0-N1733S	045 109 479 B	0-N1274	058 903 133 D	0-N1822	06A 109 479 B	0-N157
03D 903 305 B	0-N1908	045 109 479 C	0-N1049	058 903 133 D	0-N1822S	06A 109 479 C	0-N157
03D 903 305 B	0-N1908S	045 109 479 D	0-N1344	059 109 243 D	0-N1266	06A 198 119	SK-1109
03D 903 305 F	0-N1908	045 903 315 A	0-N1704	059 109 243 F	0-N201	06A 198 119 A	SK-1337
03D 903 305 F	0-N1908S	045 903 315 A	0-N1704S	059 109 243 G	0-N201	06A 198 119 B	SK-1660
03D 903 305 G	0-N1908	047 903 306	0-N2065	059 109 243 J	0-N1266	06A 903 315 D	0-N1041
03D 903 305 G	0-N1908S	047 903 306	0-N2065S	059 109 243 L	0-N201	06A 903 315 D	0-N1041S
03E 903 133	0-N1908	047 903 315	0-N2066	059 109 243 N	0-N1337	06A 903 315 E	0-N1041
03E 903 133	0-N1908S	04C 109 244 B	0-N2381	059 109 243 P	0-N1337	06A 903 315 E	0-N1041S
03E 903 133 A	0-N1908	04C 109 244 D	0-N2381	059 109 244	0-N168	06A 903 315 F	0-N1041
03E 903 133 A	0-N1908S	04C 109 479 G	0-N2313	059 109 244 A	0-N168	06A 903 315 F	0-N1041S
03E 903 133 B	0-N1908	04C 109 479 H	0-N2313	059 109 244 B	0-N168	06B 109 243	0-N1654
03E 903 133 B	0-N1908S	04C 109 479 J	0-N2313	059 109 479 B	0-N1364	06B 109 243 A	0-N1042
03F 145 276	0-N2121	04C 145 299 B	0-N2271	059 109 487 A	0-N1363	06B 109 243 B	0-N1050
03G 109 243	0-N1335	04E 109 244 A	0-N2381	059 109 487 B	0-N1363	06B 109 243 C	0-N1566
03G 109 244	0-N1336	04E 109 244 B	0-N2381	059 109 487 C	0-N1363	06B 109 243 D	0-N1042
03G 109 244 A	0-N1575	04E 109 244 D	0-N2381	059 145 201 D	0-N1918	06B 109 243 E	0-N1050
03G 145 276	0-N1738	04E 109 244 E	0-N2381	059 145 201 D	0-N1918S	06B 109 243 F	0-N1042
03G 198 119	SK-1595	04E 109 479 A	0-N2313	059 145 201 F	0-N1918	06B 109 244	0-N1316



VW		VW		VW	
06B 109 477	0-N1237	071 145 299 B	0-N2017S	078 109 243 S	0-N1238
06B 109 477 A	0-N1051	071 145 299 D	0-N2017	078 109 244 H	0-N2001
06B 109 477 A	0-N1051S	071 145 299 D	0-N2017S	078 109 244 J	0-N2001
06B 109 477 B	0-N1567	074 109 243 C	0-N108	078 109 479 E	0-N1275
06B 109 479	0-N1237	074 109 243 D	0-N1232	078 109 487 A	0-N1371
06B 198 119	SK-1660	074 109 243 E	0-N116	078 109 487 C	0-N1371
06B 198 119 A	SK-1640	074 109 243 F	0-N109	078 198 119	SK-1383
06B 198 119 C	SK-1726	074 109 243 G	0-N109	078 198 119 A	SK-1376
06D 109 243	0-N1340	074 109 243 H	0-N108	078 198 479	SK-1377
06D 109 243 C	0-N2208	074 109 243 J	0-N109	078 903 133 AB	0-N1083
06D 109 244 A	0-N1341	074 109 243 M	0-N116	078 903 133 AB	0-N1083S
06D 109 244 B	0-N1341	074 109 243 R	0-N109	07D 145 276 A	0-N2127
06D 109 244 C	0-N1346	074 130 195	0-N110	07D 145 276 B	0-N2127
06D 109 244 D	0-N1346	074 130 195 B	0-N110	07D 145 276 C	0-N2127
06D 109 244 E	0-N1346	074 130 245	0-N117	07K 145 172 B	0-N1892
06E 903 133 A	0-N1830	074 145 251 B	0-N1801	07K 145 172 B	0-N1892S
06E 903 133 A	0-N1830S	074 145 278 C	0-N1600	07K 145 172 C	0-N1893
06E 903 133 AB	0-N2289	074 145 278 D	0-N1313	07K 145 172 C	0-N1893S
06E 903 133 AB	0-N2289S	074 145 278 E	0-N1311	1J0 145 276	0-N1454
06E 903 133 B	0-N1830	074 145 278 F	0-N1312	1J0 145 299	0-N1733
06E 903 133 B	0-N1830S	074 145 283 B	0-N1543	1J0 145 299	0-N1733S
06E 903 133 E	0-N1830	074 145 299 A	0-N1800	1L0 198 001	SK-1104
06E 903 133 E	0-N1830S	074 198 119	SK-1526	1L0 198 002	SK-1069
06E 903 133 H	0-N2289	074 198 119 A	SK-1648	1L0 198 002 A	SK-1098
06E 903 133 H	0-N2289S	074 198 119 B	SK-1529	377 145 299	0-N1886
06E 903 133 L	0-N1830	074 198 119 C	SK-1380	377 145 299	0-N1886S1
06E 903 133 L	0-N1830S	074 198 119 D	SK-1360	377 145 299	0-N1886S2
06E 903 133 M	0-N2289	074 198 119 G	SK-1529	377 260 299	0-N1885
06E 903 133 M	0-N2289S	074 198 119 H	SK-1526	377 260 299	0-N1885S1
06E 903 133 N	0-N1830	074 198 119 P	SK-1529	377 260 299	0-N1885S2
06E 903 133 N	0-N1830S	074 198 119 Q	SK-1526	6K0 145 299	0-N1459
06E 903 133 Q	0-N1830	075 109 243 B	0-N163	6K0 145 299	0-N1459S
06E 903 133 Q	0-N1830S	075 109 243 D	0-N163	6K0 198 001 A	SK-1131
06E 903 133 R	0-N1830	076 145 261 A	0-N1954	6K0 198 001 B	SK-1090
06E 903 133 R	0-N1830S	076 145 261 A	0-N1954S	6K0 198 001 C	SK-1635
06E 903 133 T	0-N1830	076 145 276	0-N1906	6K0 198 001 D	SK-1074
06E 903 133 T	0-N1830S	076 145 299	0-N1943	6K0 198 002	SK-1026
06E 903 341 E	0-N2351	076 198 119	SK-1686	6K0 198 004	SK-1120
06E 903 341 H	0-N2351	076 260 938	0-N1915	6K0 198 005	SK-1029
06F 198 119	SK-1599	077 109 244 C	0-N169	6L0 198 002	SK-1069
06F 198 119 B	SK-1724	077 109 244 E	0-N1570	6Q0 145 299	0-N1525
06F 903 315	0-N1656	077 109 244 F	0-N2134	6Q0 145 299	0-N1525S
06F 903 315	0-N1656S	077 109 479 D	0-N1569	6QD 145 276	0-N1454
06H 903 133 F	0-N2026	077 109 485 E	0-N1568	J13 503 540 21	0-N013
06H 903 133 F	0-N2026S	077 198 119 A	SK-1386	J13 503 540 30	0-N014
06H 903 133 G	0-N2026	077 903 133 F	0-N2137		
06H 903 133 G	0-N2026S	077 903 133 F	0-N2137S		
06H 903 341 C	0-N2027	077 903 133 G	0-N2137		
06H 903 341 D	0-N2027	077 903 133 G	0-N2137S		
06J 903 133 A	0-N1832	077 903 341	0-N1632		
06J 903 133 A	0-N1832S	078 109 243 Q	0-N1238		
071 145 299 B	0-N2017	078 109 243 R	0-N1238		



BREDA		BREDA		BREDA		BREDA	
CR 1444	0-N187	CR 1808	0-N116	CR 1882	0-N876	CR 3048	0-N1640
CR 1444 P	0-N187	CR 1809	0-N110	CR 1883	0-N879	CR 3049	0-N2411
CR 1453	0-N2156	CR 1810	0-N102	CR 1885	0-N948	CR 3050	0-N1559S
CR 1456	0-N847	CR 1812	0-N923	CR 1886	0-N901	CR 3051	0-N2135
CR 1458	0-N1442	CR 1813	0-N922	CR 1887	0-N900	CR 3053	0-N1396
CR 1464	0-N915	CR 1814	0-N940	CR 1888	0-N911	CR 3055	0-N1280
CR 1466	0-N866	CR 1815	0-N954	CR 1889	0-N109	CR 3056	0-N1013
CR 1467	0-N867	CR 1816	0-N955	CR 1892	0-N106	CR 3056	0-N1013S
CR 1476	0-N1298	CR 1817	0-N902	CR 1893	0-N943	CR 3058	0-N1011
CR 1477	0-N1288	CR 1819	0-N115	CR 1895	0-N208	CR 3058	0-N1011S
CR 1478	0-N1388	CR 1821	0-N114	CR 1896	0-N950	CR 3063	0-N1289
CR 1482	0-N1519	CR 1826	0-N861	CR 1897	0-N949	CR 3064	0-N565592
CR 1482	0-N1519S	CR 1827	0-N862	CR 1898	0-N952	CR 3069	0-N1279
CR 1485	0-N174	CR 1828	0-N938	CR 1899	0-N953	CR 3070	0-N1043
CR 1490	0-N197	CR 1829	0-N132	CR 3000	0-N118P	CR 3073	0-N1951
CR 1642	0-N160	CR 1830	0-N842	CR 3001	0-N119P	CR 3080	0-N2144
CR 1643	0-N2000	CR 1833	0-N985	CR 3002	0-N166	CR 3081	0-N2145
CR 1644	0-N819	CR 1834	0-N889	CR 3003	0-N131	CR 3082	0-N2147
CR 1645	0-N820	CR 1837	0-N875	CR 3004	0-N128	CR 3088	0-N2141
CR 1646	0-N818	CR 1838/M	0-N173	CR 3005	0-N971	CR 3093	0-N1260
CR 1652	0-N800	CR 1839	0-N854	CR 3007	0-N973	CR 3094	0-N123
CR 1653	0-N801	CR 1841	0-N883	CR 3008	0-N126	CR 3098	0-N290
CR 1654	0-N822	CR 1843 M	0-N857	CR 3010	0-N201	CR 3099	0-N291
CR 1659	0-N850	CR 1844	0-N887	CR 3011	0-N200	CR 3100	0-N292
CR 1672	0-N823	CR 1845	0-N856	CR 3015	0-N195	CR 3101	0-N293
CR 1673	0-N832	CR 1846	0-N863	CR 3018	0-N1295	CR 3111	0-N957
CR 1675	0-N826	CR 1847	0-N859	CR 3018	0-N1295S	CR 3112	0-N127
CR 1677	0-N996	CR 1852	0-N925	CR 3019	0-N2409	CR 3116	0-N2169
CR 1678	0-N1616	CR 1854	0-N835	CR 3020	0-N1293	CR 3117	0-N300
CR 1680	0-N805	CR 1855	0-N944	CR 3021	0-N1306	CR 3117 P	0-N300
CR 1681	0-N807	CR 1856	0-N945	CR 3023	0-N1758	CR 3118	0-N1397
CR 1682	0-N806	CR 1859	0-N103	CR 3026	0-N2140	CR 3119	0-N1395
CR 1683	0-N878	CR 1861	0-N903	CR 3027	0-N1296	CR 3121	0-N2170
CR 1685	0-N812	CR 1862 P	0-N904	CR 3028	0-N1292	CR 3121	0-N2170S
CR 1686	0-N813	CR 1863	0-N808	CR 3029	0-N1297	CR 3122	0-N2170
CR 1687	0-N814	CR 1864	0-N096	CR 3030	0-N1303	CR 3122	0-N2170S
CR 1689	0-N815	CR 1865	0-N869	CR 3031	0-N1305	CR 3123	0-N924
CR 1691	0-N112	CR 1866	0-N881	CR 3032	0-N1304	CR 3128	0-N921
CR 1692	0-N811	CR 1867	0-N880	CR 3033	0-N1290	CR 3131	0-N1258
CR 1693	0-N838	CR 1868	0-N882	CR 3033	0-N1290S	CR 3132	0-N165
CR 1694	0-N839	CR 1869	0-N871	CR 3035	0-N1291	CR 3134	0-N1229
CR 1699	0-N117	CR 1870	0-N870	CR 3035	0-N1291S	CR 3135	0-N1230
CR 1800	0-N100	CR 1871	0-N860	CR 3040	0-N1299	CR 3136	0-N129
CR 1801	0-N906	CR 1872	0-N874	CR 3040	0-N1299S	CR 3138	0-N1236
CR 1802	0-N101	CR 1873	0-N837	CR 3041	0-N1300	CR 3139	0-N1042
CR 1803	0-N907	CR 1874	0-N937	CR 3041	0-N1300S	CR 3140	0-N157
CR 1804	0-N089	CR 1875	0-N1214	CR 3042	0-N2410	CR 3141	0-N1041
CR 1805	0-N105	CR 1876	0-N104	CR 3044	0-N1527	CR 3141	0-N1041S
CR 1806	0-N107	CR 1880	0-N909	CR 3044	0-N1527S	CR 3142	0-N163
CR 1807	0-N108	CR 1881	0-N877	CR 3047	0-N1511	CR 3144	0-N2001

BREDA		BREDA		BREDA		BREDA	
CR 3145	0-N1262	CR 3249	0-N169	CR 3353	0-N162	CR 3492	0-N2346
CR 3146	0-N158	CR 3251	0-N2345	CR 3354	0-N960	CR 3493	0-N2127
CR 3147	0-N167	CR 3252	0-N168	CR 3355	0-N2315	CR 3494	0-N2414
CR 3148	0-N164	CR 3256	0-N1371	CR 3359	0-N930	CR 3495	0-N1046
CR 3150	0-N159	CR 3257	0-N1051	CR 3361	0-N920	CR 3496	0-N1045
CR 3151	0-N1263	CR 3257	0-N1051S	CR 3363	0-N919	CR 3497	0-N1052
CR 3154	0-N1317	CR 3258	0-N1822	CR 3364	0-N1232	CR 3500	0-N1817
CR 3154	0-N1317S	CR 3258	0-N1822S	CR 3365	0-N172	CR 3500	0-N1817S
CR 3155	0-N1268	CR 3259	0-N1538	CR 3367	0-N1362	CR 3505	0-N1352
CR 3165	0-N1445	CR 3259	0-N1538S	CR 3368	0-N1350	CR 3510	0-N1062
CR 3165	0-N1445S	CR 3265	0-N938	CR 3376	0-N2152	CR 3511	0-N1066
CR 3169	0-N1543	CR 3272	0-N1386	CR 3377	0-N133	CR 3513	0-N1387
CR 3174	0-N1265	CR 3275	0-N1450	CR 3378	0-N2153	CR 3517	0-N1349
CR 3175	0-N1238	CR 3277	0-N2348	CR 3380	0-N1222	CR 3526	0-N1085
CR 3176	0-N107	CR 3278	0-N121	CR 3383	0-N2154	CR 3526	0-N118P
CR 3177	0-N1275	CR 3279	0-N122	CR 3388	0-N170	CR 3527	0-N119P
CR 3178	0-N1237	CR 3286	0-N2174	CR 3389	0-N171	CR 3528	0-N1447S
CR 3179	0-N1048	CR 3287	0-N2337	CR 3402	0-N904	CR 3532	0-N2157
CR 3180	0-N1274	CR 3290	0-N215	CR 3409	0-N1914	CR 3536	0-N1085
CR 3181	0-N1050	CR 3291	0-N214	CR 3410	0-N1065	CR 3537	0-N1365
CR 3188	0-N139	CR 3294	0-N2349	CR 3417	0-N1845	CR 3540	0-N2347
CR 3193	0-N2332	CR 3297	0-N2175	CR 3417	0-N1845S	CR 3542	0-N1528
CR 3194	0-N2176	CR 3298	0-N2172	CR 3424	0-N1092	CR 3542	0-N1528S
CR 3195	0-N964	CR 3298	0-N2172S	CR 3431	0-N2327	CR 3549	0-N1339
CR 3196	0-N2333	CR 3299	0-N2173	CR 3435	0-N2256	CR 3549	0-N1339S
CR 3197	0-N2334	CR 3309	0-N1061	CR 3438	0-N2220	CR 3550	0-N1054
CR 3198	0-N2342	CR 3313	0-N2412	CR 3438	0-N2220S	CR 3551	0-N1341
CR 3199	0-N2335	CR 3314	0-N2413	CR 3443	0-N1446	CR 3553	0-N1382
CR 3200	0-N1602	CR 3316	0-N897	CR 3447	0-N2180	CR 3556	0-N1093
CR 3202	0-N277	CR 3317	0-N899	CR 3448	0-N2029	CR 3558	0-N1627
CR 3205	0-N965	CR 3319	0-N894	CR 3448	0-N2029S	CR 3558	0-N1627S
CR 3206	0-N145	CR 3321	0-N898	CR 3449	0-N1539	CR 3559	0-N1720
CR 3207	0-N148	CR 3324	0-N1388	CR 3449	0-N1539S	CR 3559	0-N1720S
CR 3208	0-N1259	CR 3325	0-N892	CR 3453	0-N1282	CR 3560	0-N1277
CR 3209	0-N137	CR 3327	0-N891	CR 3455	0-N2142	CR 3561	0-N1419
CR 3210	0-N149	CR 3330	0-N1261	CR 3458	0-N1111	CR 3564	0-N1355
CR 3220	0-N152	CR 3331	0-N1248	CR 3462	0-N1569	CR 3565	0-N1354
CR 3220	0-N152S	CR 3332	0-N939	CR 3463	0-N130	CR 3571	0-N2170
CR 3225	0-N2179	CR 3333	0-N968	CR 3467	0-N1331	CR 3571	0-N2170S
CR 3226	0-N147	CR 3334	0-N1857	CR 3471	0-N1122	CR 3579	0-N1239
CR 3227	0-N2336	CR 3334	0-N1857S	CR 3474	0-N1507	CR 3580	0-N1383
CR 3229	0-N262	CR 3337	0-N1120	CR 3474	0-N1507S	CR 3581	0-N2167
CR 3230	0-N198	CR 3340	0-N1514	CR 3475	0-N1512	CR 3584	0-N1335
CR 3231	0-N146	CR 3340	0-N1514S	CR 3475	0-N1512S	CR 3586	0-N1398
CR 3238	0-N1270	CR 3341	0-N1256	CR 3480	0-N1285	CR 3589	0-N2349
CR 3240	0-N1314	CR 3343	0-N2181	CR 3481	0-N1588	CR 3602	0-N1369
CR 3242	0-N1721	CR 3346	0-N1438	CR 3481	0-N1588S	CR 3603	0-N1272
CR 3243	0-N1173	CR 3346	0-N1438S	CR 3482	0-N1287	CR 3606	0-N1340
CR 3244	0-N1269	CR 3349	0-N1544	CR 3484	0-N1459	CR 3633	0-N1427
CR 3248	0-N1266	CR 3352	0-N1231	CR 3484	0-N1459S	CR 3633	0-N1427S



BREDA		BREDA		BREDA		BREDA	
CR 3633	0-N2405	CR 3745	0-N1534S	CR 3885	0-N1656S	CR 4024	0-N2232
CR 3633	0-N2405S	CR 3747	0-N1573	CR 3888	0-N115	CR 4024	0-N2232S
CR 3636	0-N2383	CR 3752	0-N1957	CR 3890	0-N2129	CR 4042	0-N2299
CR 3637	0-N1453	CR 3752	0-N1957S	CR 3891	0-N2130	CR 4042	0-N2299S
CR 3638	0-N1368	CR 3758	0-N1574	CR 3896	0-N1621	CR 4088	0-N2199
CR 3644	0-N1360	CR 3764	0-N1337	CR 3896	0-N1621S	CR 4090	0-N2048
CR 3645	0-N1359	CR 3778	0-N1746	CR 3897	0-N1960	CR 4094	0-N2197
CR 3647	0-N1525	CR 3779	0-N1885	CR 3898	0-N2209	CR 4094	0-N2197S
CR 3647	0-N1525S	CR 3779	0-N1885S1	CR 3898	0-N2209S	CR 4095	0-N2064
CR 3658	0-N1246	CR 3779	0-N1885S2	CR 3899	0-N1617	CR 4120	0-N2203
CR 3665	0-N1357	CR 3781	0-N1537	CR 3900	0-N1884	CR 4120	0-N2203S
CR 3666	0-N1358	CR 3781	0-N1537S	CR 3903	0-N1716	CR 4137	0-N2266
CR 3670	0-N1392	CR 3783	0-N1605	CR 3905	0-N1906	CR 4137	0-N2266S1
CR 3679	0-N1673	CR 3786	0-N2095S1	CR 3910	0-N1643	CR 4137	0-N2266S2
CR 3679	0-N1673S	CR 3788	0-N1886	CR 3910	0-N1643S	CR 4143	0-N1859
CR 3681	0-N1793	CR 3788	0-N1886S1	CR 3919	0-N1346	CR 4184	0-N1286
CR 3681	0-N1793S	CR 3788	0-N1886S2	CR 3926	0-N1735	CR 4192	0-N2402
CR 3683	0-N1786	CR 3789	0-N1663	CR 3932	0-N2190	CR 4192	0-N2402S
CR 3684	0-N2124	CR 3789	0-N1663S	CR 3932	0-N2190S	CR 4247	0-N2196
CR 3684	0-N2124S	CR 3790	0-N2134	CR 3935	0-N2150	CR 4261	0-N1662
CR 3685	0-N1799	CR 3797	0-N2177	CR 3937	0-N2122	CR 4342	0-N2038
CR 3685	0-N1799S	CR 3800	0-N2331	CR 3939	0-N2229	CR 4342	0-N2038S
CR 3693	0-N2132	CR 3801	0-N1575	CR 3941	0-N2139	CR 4343	0-N1642
CR 3694	0-N2219	CR 3802	0-N2330	CR 3946	0-N1928	CR 4346	0-N1661
CR 3694	0-N2219S	CR 3805	0-N1612	CR 3948	0-N2138	CR 4349	0-N1991
CR 3697	0-N1711S	CR 3808	0-N2126	CR 3951	0-N2084	CR 4361	0-N2242
CR 3700	0-N1460	CR 3810	0-N1711S	CR 3951	0-N2084S	CR 4361	0-N2242S
CR 3701	0-N1323	CR 3811	0-N2178	CR 3952	0-N2125	CR 4391	0-N2276
CR 3704	0-N1788	CR 3814	0-N878	CR 3956	0-N1952	CR 4395	0-N2115
CR 3704	0-N1788S	CR 3815	0-N2148	CR 3964	0-N145	CR 4395	0-N2115S
CR 3709	0-N1523	CR 3819	0-N2378	CR 3970	0-N1811	CR 4408	0-N1832
CR 3710	0-N2111	CR 3825	0-N1798	CR 3970	0-N1811S	CR 4408	0-N1832S
CR 3710	0-N2111S	CR 3825	0-N1798S	CR 3976	0-N1742	CR 4411	0-N2027
CR 3712	0-N2133	CR 3830	0-N1834	CR 3976	0-N1742S	CR 4412	0-N2026
CR 3713	0-N1733	CR 3830	0-N1834S	CR 3986	0-N2052	CR 4412	0-N2026S
CR 3713	0-N1733S	CR 3831	0-N1564	CR 3994	0-N1954	CR 4415	0-N1893
CR 3715	0-N166	CR 3832	0-N1946	CR 3994	0-N1954S	CR 4415	0-N1893S
CR 3729	0-N2194	CR 3832	0-N1946S1	CR 4003	0-N2218	CR 4416	0-N2391
CR 3729	0-N2194S	CR 3832	0-N1946S2	CR 4004	0-N2193	CR 4416	0-N2391S
CR 3736	0-N1353	CR 3835	0-N2385	CR 4004	0-N2193S	CR 4418	0-N2121
CR 3738	0-N1121	CR 3847	0-N2155	CR 4007	0-N2222	CR 4426	0-N2026
CR 3743	0-N2245	CR 3847	0-N2155S	CR 4008	0-N2137	CR 4426	0-N2026S
CR 3743	0-N2245S1	CR 3852	0-N2379	CR 4008	0-N2137S	CR 4428	0-N2351
CR 3743	0-N2245S2	CR 3859	0-N2382	CR 4014	0-N2223	CR 4451	0-N1795
CR 3743	0-N2245S3	CR 3864	0-N2104	CR 4015	0-N2112	CR 4461	0-N1702
CR 3744	0-N2246	CR 3864	0-N2104S	CR 4015	0-N2112S	CR 4506	0-N2063
CR 3744	0-N2246S1	CR 3872	0-N1385	CR 4016	0-N2224	CR 4579	0-N2341
CR 3744	0-N2246S2	CR 3875	0-N2128	CR 4018	0-N2225	CR 4581	0-N2205
CR 3744	0-N2246S3	CR 3882	0-N1950	CR 4021	0-N2227	CR 4583	0-N2386
CR 3745	0-N1534	CR 3885	0-N1656	CR 4022	0-N2238	CR 4586	0-N2275

BREDA

CR 4588	0-N2265
CR 4588	0-N2265S
CR 4592	0-N2057
CR 4593	0-N2371
CR 4594	0-N2392
CR 4594	0-N2392S
CR 4595	0-N2354
CR 4596	0-N2377
CR 5000	0-N2168
CR 5002	0-N928
CR 5003	0-N237
CR 5004	0-N236
CR 5005	0-N094
CR 5007	0-N021
CR 5009	0-N025
CR 5010	0-N030
CR 5011	0-N031
CR 5012	0-N029
CR 5013	0-N028
CR 5014	0-N027
CR 5015	0-N033
CR 5016	0-N024
CR 5017	0-N022
CR 5019	0-N1219
CR 5020	0-N999
CR 5021	0-N992
CR 5022	0-N991
CR 5023	0-N995
CR 5024	0-N1273
CR 5025	0-N005
CR 5026	0-N006
CR 5029	0-N990
CR 5030	0-N988
CR 5031	0-N989
CR 5032	0-N997
CR 5033	0-N998
CR 5034	0-N008
CR 5035	0-N994
CR 5036	0-N007
CR 5037	0-N993
CR 5039	0-N001
CR 5042	0-N013
CR 5043	0-N014
CR 5044	0-N069
CR 5045	0-N070
CR 5046	0-N180
CR 5047	0-N076
CR 5048	0-N078
CR 5049	0-N077
CR 5051	0-N081

BREDA

CR 5052	0-N079
CR 5053	0-N084
CR 5054	0-N073
CR 5055	0-N075
CR 5056	0-N074
CR 5058	0-N092
CR 5059	0-N083
CR 5060	0-N983
CR 5062	0-N072
CR 5064	0-N986
CR 5065	0-N987
CR 5066	0-N053
CR 5067	0-N054
CR 5069	0-N058
CR 5070	0-N051
CR 5071	0-N183
CR 5072	0-N065
CR 5073	0-N179
CR 5074	0-N059
CR 5075	0-N188
CR 5076	0-N184
CR 5077	0-N061
CR 5078	0-N060
CR 5079	0-N062
CR 5080	0-N064
CR 5081	0-N186
CR 5082	0-N056
CR 5083	0-N052
CR 5084	0-N063
CR 5085	0-N979
CR 5086	0-N927
CR 5087	0-N978
CR 5088	0-N926
CR 5089	0-N905
CR 5090	0-N178
CR 5092	0-N982
CR 5095	0-N981
CR 5097	0-N017
CR 5098	0-N018
CR 5099	0-N020
CR 5100	0-N916
CR 5101	0-N019
CR 5105	0-N038
CR 5106	0-N2323
CR 5107	0-N039
CR 5108	0-N041
CR 5109	0-N040
CR 5110	0-N036
CR 5111	0-N1223
CR 5112	0-N1225

BREDA

CR 5117	0-N055
CR 5120	0-N975
CR 5121	0-N974
CR 5122	0-N970
CR 5123	0-N042
CR 5124	0-N047
CR 5125	0-N046
CR 5126	0-N049
CR 5128	0-N050
CR 5129	0-N048
CR 5131	0-N035
CR 5132	0-N034
CR 5138	0-N185
CR 5139	0-N191
CR 5140	0-N192
CR 5141	0-N191
CR 5142	0-N189
CR 5143	0-N969
CR 5146	0-N1071
CR 5159	0-N2319
CR 5163	0-N176
CR 5165	0-N066
CR 5166	0-N068
CR 5167	0-N193
CR 5169	0-N087
CR 5170	0-N085
CR 5171	0-N1127
CR 5172	0-N181
CR 5174	0-N1244
CR 5175	0-N045
CR 5178	0-N1218
CR 5179	0-N1220
CR 5180	0-N090
CR 5181	0-N091
CR 5182	0-N088
CR 5184	0-N1764
CR 5190	0-N1379
CR 5191	0-N1578
CR 5193	0-N2320
CR 5198	0-N1618
CR 5205	0-N2186
CR 5206	0-N1129
CR 5207	0-N1521
CR 5218	0-N1380
CR 5224	0-N1777
CR 5227	0-N1971
CR 5229	0-N2415
CR 5230	0-N2162
CR 5232	0-N2163
CR 5234	0-N1776

BREDA

CR 5236	0-N1820
CR 5240	0-N1815
CR 5240	0-N1815S
CR 5242	0-N1856
CR 5242	0-N1856S
CR 5245	0-N1499
CR 5254	0-N2164
CR 5260	0-N2182
CR 5260	0-N2182S
CR 5262	0-N1819
CR 5267	0-N2398
CR 5267	0-N2398S
CR 5270	0-N1547
CR 5276	0-N2189S
CR 5281	0-N1936
CR 5282	0-N2160
CR 5284	0-N2159
CR 5286	0-N2012
CR 5288	0-N1875
CR 5288	0-N1875S
CR 5293	0-N2228
CR 5294	0-N2183
CR 5294	0-N2183S
CR 5296	0-N2184
CR 5296	0-N2184S
CR 5299	0-N2187
CR 5301	0-N2161
CR 5301	0-N2161S
CR 5303	0-N1852
CR 5304	0-N2226
CR 5304	0-N2226S
CR 5305	0-N2339
CR 5306	0-N2230
CR 5306	0-N2230S
CR 5307	0-N1990
CR 5308	0-N2231
CR 5308	0-N2231S
CR 5331	0-N2273
CR 5333	0-N2374
CR 5335	0-N2250
CR 5335	0-N2250S
CR 5355	0-N1814
CR 5367	0-N1553
CR 5368	0-N1552
CR 5368	0-N1552S
CR 5371	0-N2375
CR 5373	0-N2429
CR 5380	0-N2244
CR 5405	0-N1984
CR 5430	0-N1876



BREDA		BREDA		BREDA		CONTI			
CR 5430	0-N1876S	KCD 0092	SK-1033	TOA3672	0-N1620	CT1016K1+CT1109K2	SK-1469		
CR 5448	0-N2207	KCD 0093	SK-1144	TOA3672	0-N1620S	CT1017K1	SK-1566		
CR 5459	0-N1987	KCD 0095	SK-1076	TOA3684	0-N2124	CT1018K1+(CT984K1)	SK-1375		
CR 5464	0-N2035	KCD 0103	SK-1019	TOA3684	0-N2124S	CT1019K1	SK-1393		
CR 5464	0-N2035S	KCD 0109	SK-1004	TOA3710	0-N2111	CT1023K1	SK-1478		
CR 5466	0-N2397	KCD 0112	SK-1017	TOA3710	0-N2111S	CT1023K2	SK-1632		
CR 5466	0-N2397S	KCD 0116	SK-1007	TOA3717	0-N1432	CT1023K3	SK-1667		
CR 5467	0-N2364	KCD 0122	SK-1079	TOA3767	0-N1492	CT1024K1	SK-1225		
CR 5468	0-N2270	KCD 0190	SK-1273	TOA3767	0-N1492S	CT1025K1	SK-1493		
CR 5468	0-N2270S	KCD 0197	SK-1141	TOA3824	0-N1908	CT1025WP1	SK-1493AQ1		
CR 5483	0-N2118	KCD 0203	SK-1065	TOA3824	0-N1908S	CT1025WP2	SK-1493AQ2		
CR 5487	0-N2239	KCD 0307	SK-1142	TOA3842	0-N2076	CT1026K1	SK-1620		
CR 5488	0-N2106	KCD 0340	SK-1155	TOA3842	0-N2076S	CT1026K2	SK-1490		
CR 5493	0-N2040	KCD 0362	SK-1078	TOA3867	0-N1958	CT1026K2	SK-1622		
CR 5517	0-N1771	KCD 0364	SK-1105	TOA3867	0-N1958S	CT1028K1	SK-1378		
CR 5527	0-N1619	KCD 0632	SK-1504	TOA3876	0-N1626	CT1028K2	SK-1583		
CR 5533	0-N1772	KCD 0654	SK-1592	TOA3876	0-N1626S	CT1028K3	SK-1372		
CR 5535	0-N1130	KCD 0726	SK-1121	TOA3896	0-N1621	CT1028K4	SK-1582		
CR 5538	0-N2255	KCD 0732	SK-1668	TOA3896	0-N1621S	CT1028K5	SK-1388		
CR 5542	0-N2322	KCD 0754	SK-1667	TOA3921	0-N1926	CT1028WP1	SK-1372AQ1		
CR 5571	0-N2384	KCD0403	SK-1270	TOA3951	0-N2084	CT1028WP3	SK-1372AQ1		
CR1811	0-N910	KCD0781	SK-1597	TOA3951	0-N2084S	CT1028WP4	SK-1372AQ2		
CR3060	0-N1864	PDI3695	0-N1326	TOA3954	0-N1646	CT1028WP5	SK-1372AQ3		
CR3164	0-N1660	POA1487	0-N1439	TOA4408	0-N1832	CT1028WP6	SK-1378AQ1		
CR3170	0-N1800	POA3152	0-N1432S	TOA4408	0-N1832S	CT1028WP7	SK-1583AQ1		
CR3281	0-N095	PQA3118	0-N2419	TOA5243	0-N1678	CT1031K1	SK-1007		
CR3469	0-N1308	TDI3016	0-N1058	TOA5302	0-N1850	CT1031K2	SK-1022		
CR3673	0-N1840	TDI3577	0-N1572	TOA5302	0-N1850S	CT1031WP1	SK-1022AQ2		
CR3673	0-N1840S	TDI3653	0-N1338	CONTI				CT1034K1	SK-1153
CR3716	0-N1530	TDI3674	0-N1343	CT1000K1+CT1109K1	SK-1555	CT1035K1	SK-1487		
CR3716	0-N1530S	TDI3687	0-N1347	CT1001K1 + CT800K1	SK-1430	CT1035K2	SK-1487		
CR5008	0-N032	TDI4533	0-N2149	CT1003K1	SK-1482	CT1035WP1	SK-1487AQ1		
CR5040	0-N000	TDI4577	0-N2208	CT1005K1+CT781K3	SK-1097	CT1035WP2	SK-1487AQ1		
CR5102	0-N037	TDI5172	0-N181	CT1006K1	SK-1436	CT1035WP3	SK-1487AQ2		
CR5103	0-N043	TDI5235	0-N1851	CT1008K1	SK-1470	CT1036K1	SK-1671		
CR5137	0-N182	TDI5235	0-N1851S	CT1008K2	SK-1685	CT1037K1	SK-1394		
CR5199	0-N1824	TOA1460	0-N1599	CT1010K1	SK-1608	CT1037K1	SK-1614		
CR5225	0-N1366	TOA1460	0-N1599S	CT1010WP1	SK-1608AQ1	CT1037K2	SK-1614		
CR5308	0-N2231	TOA3087	0-N1560	CT1012K1	SK-1512	CT1037WP1	SK-1614AQ1		
CR5308	0-N2231S	TOA3110	0-N956	CT1012K2	SK-1106	CT1038K1	SK-1035		
KCD 0015	SK-1094	TOA3297	0-N1473	CT1013K1	SK-1626	CT1039K2	SK-1469		
KCD 0016	SK-1042	TOA3297	0-N1473S	CT1014K2	SK-1481	CT1040K1	SK-1623		
KCD 0021	SK-1038	TOA3415	0-N1897	CT1014K3	SK-1479	CT1040K2	SK-1624		
KCD 0031	SK-1026	TOA3415	0-N1897S	CT1014K3	SK-1689	CT1041K1 + CT1042K	SK-1552		
KCD 0057	SK-1021	TOA3443	0-N1446	CT1014K5	SK-1481	CT1043K1	SK-1589		
KCD 0065	SK-1013	TOA3573	0-N1476	CT1015K1 + CT1018K	SK-1619	CT1043K2	SK-1717		
KCD 0072	SK-1031	TOA3573	0-N1476S	CT1015K2 + CT1018K	SK-1619	CT1043WP2	SK-1717AQ2		
KCD 0074	SK-1043	TOA3604	0-N1953	CT1015K2+CT1018K1	SK-1621	CT1044K1	SK-1258		
KCD 0086	SK-1035	TOA3604	0-N1953S	CT1015WP1	SK-1621AQ1	CT1044K2	SK-1259		
KCD 0090	SK-1046	TOA3629	0-N1649	CT1015WP1+CT1018	SK-1633AQ1	CT1044WP1	SK-1258AQ1		

CONTI

CONTI

CONTI

CONTI

CT1045K1	SK-1486
CT1045WP1	SK-1486AQ1
CT1046K1	SK-1489
CT1047K1	SK-1627
CT1048K1	SK-1458
CT1049K1	SK-1412
CT1049WP1	SK-1412AQ2
CT1050K1	SK-1712
CT1051K1	SK-1595
CT1051K2	SK-1668
CT1051WP1	SK-1595AQ1
CT1051WP2	SK-1668AQ1
CT1052K1	SK-1483
CT1053K1	SK-1316
CT1054K1	SK-1049
CT1054K2	SK-1049
CT1055K1	SK-1351
CT1056K1	SK-1599
CT1057K1	SK-1610
CT1058K2	SK-1719
CT1058K3	SK-1721
CT1061K1	SK-1007
CT1061K2	SK-1022
CT1061WP1	SK-1022AQ2
CT1061WP2	SK-1007AQ1
CT1061WP3	SK-1022AQ1
CT1062K1	SK-1439
CT1063K1	SK-1391
CT1063K2	SK-1534
CT1063K3	SK-1616
CT1063WP1	SK-1534AQ1
CT1063WP2	SK-1391AQ1
CT1064K1	SK-1580
CT1064WP1	SK-1580AQ1
CT1064WP2	SK-1580AQ1
CT1065K1	SK-1392
CT1065K3	SK-1615
CT1065WP1	SK-1392AQ1
CT1065WP2	SK-1615AQ1
CT1066K1	SK-1353
CT1066WP1	SK-1353AQ1
CT1067K1	SK-1354
CT1067WP1	SK-1354AQ1
CT1068K1	SK-1538
CT1068K2	SK-1601
CT1069K1	SK-1652
CT1070K1	SK-1066
CT1076K1	SK-1602
CT1076K2	SK-1367
CT1077K1	SK-1607

CT1078K1	SK-1612
CT1079K1	SK-1611
CT1081K1	SK-1591
CT1082K1	SK-1590
CT1085K1	SK-1669
CT1088K3	SK-1724
CT1088WP1	SK-1724AQ1
CT1088WP2	SK-1724AQ2
CT1088WP3	SK-1724AQ1
CT1088WP4	SK-1724AQ2
CT1089K1	SK-1713
CT1090K1	SK-1603
CT1090K2	SK-1604
CT1091K1	SK-1594
CT1091WP1	SK-1594AQ1
CT1092K1	SK-1424
CT1092K2	SK-1613
CT1092WP1	SK-1424AQ1
CT1094K1	SK-1597
CT1096K1+2xCT1097	SK-1502
CT1098K1	SK-1674
CT1099K1	SK-1654
CT1099K2	SK-1654
CT1100K1	SK-1609
CT1100K1	SK-1617
CT1100K2	SK-1609
CT1100K2	SK-1617
CT1101K1	SK-1598
CT1101WP1	SK-1598AQ1
CT1104K1	SK-1577
CT1105K1	SK-1586
CT1105K2	SK-1587
CT1105K3	SK-1586
CT1105WP1	SK-1586AQ1
CT1105WP2	SK-1586AQ1
CT1106K1	SK-1696
CT1106WP1	SK-1696AQ1
CT1107K1+CT921K2	SK-1306
CT1109K1	SK-1649
CT1109K1+CT839K1	SK-1323
CT1109K1+CT842K1	SK-1463
CT1109K1+CT911K1	SK-1311
CT1109K2	SK-1469
CT1110K1	SK-1600
CT1110K2	SK-1596
CT1114K1	SK-1676
CT1115K1	SK-1677
CT1117K1	SK-1742
CT1117K1+CT1118K1	SK-1675
CT1120K1	SK-1686

CT1121K1	SK-1723
CT1123K1	SK-1673
CT1126K1	SK-1088
CT1126K2	SK-1630
CT1126WP1	SK-1088AQ1
CT1126WP2	SK-1630AQ1
CT1128K1	SK-1670
CT1129K1	SK-1671
CT1130K1	SK-1623
CT1130K1	SK-1624
CT1130K2	SK-1623
CT1130K2	SK-1624
CT1130WP1	SK-1624AQ1
CT1131K1	SK-1720
CT1133K1	SK-1671
CT1133K2	SK-1671
CT1134K1	SK-1694
CT1134WP1	SK-1694AQ2
CT1134WP2	SK-1694AQ1
CT1136K1	SK-1678
CT1136K1	SK-1741
CT1137K1	SK-1691
CT1138K1	SK-1482
CT1138WP1	SK-1482AQ1
CT1139K1	SK-1695
CT1139K2	SK-1727
CT1139WP1	SK-1727AQ1
CT1139WP2	SK-1727AQ1
CT1139WP4	SK-1695AQ1
CT1139WP4	SK-1727AQ2
CT1139WP6	SK-1695AQ1
CT1139WP6	SK-1727AQ2
CT1140K1	SK-1714
CT1141K1+CT1027K1	SK-1653
CT1142K1	SK-1692
CT1145K1	SK-1674
CT1148K1	SK-1610
CT1148WP1	SK-1610AQ1
CT1149K1	SK-1697
CT1149WP1	SK-1697AQ1
CT1150K1	SK-1698
CT1155K1	SK-1693
CT1155WP1	SK-1693AQ1
CT1162K1	SK-1728
CT1162WP1	SK-1728AQ1
CT1163K1	SK-1732
CT503K1	SK-1023
CT508K1	SK-1260
CT510K1	SK-1321
CT511K1	SK-1309S

CT511K1+CT991K3	SK-1240
CT511K2	SK-1240S
CT512K1	SK-1052
CT513K1	SK-1001
CT517K1	SK-1236
CT517K1+CT714K1	SK-1236
CT521K1	SK-1189
CT522K1	SK-1063
CT522K2	SK-1014
CT522K3	SK-1093
CT523K1	SK-1007
CT525K1	SK-1006
CT527K1	SK-1185
CT529K1	SK-1056
CT530K1	SK-1064
CT536K1	SK-1275
CT539K1	SK-1126
CT539WP1	SK-1126AQ1
CT540K1	SK-1037
CT540WP1	SK-1037AQ1
CT553K1	SK-1010
CT557K1	SK-1024
CT559K1	SK-1216
CT568K1	SK-1248
CT569K1	SK-1249
CT581K1	SK-1065
CT583K1	SK-1062
CT585K1	SK-1232
CT586K1	SK-1219
CT588K1	SK-1157
CT589K1	SK-1059
CT589K2	SK-1060
CT594K2	SK-1138
CT594K3	SK-1138
CT596K1	SK-1015
CT603K1	SK-1223
CT604K1	SK-1012
CT605K1	SK-1031
CT607K1	SK-1004
CT607WP1	SK-1004AQ1
CT608K1	SK-1264
CT608K2	SK-1155
CT608K3	SK-1151
CT609K1	SK-1140
CT611K1	SK-1032
CT613K1	SK-1142
CT615K1	SK-1141
CT616K1	SK-1039
CT617K1	SK-1033
CT619K1	SK-1144



CONTI		CONTI		CONTI		CONTI	
CT622K1	SK-1045	CT740K1	SK-1257	CT804+CT800K1	SK-1218	CT873WP1	SK-1073AQ3
CT626K1	SK-1449	CT741K1	SK-1207	CT805K1	SK-1308	CT873WP2	SK-1073AQ2
CT629WP1	R-1190AQ1	CT744K1	SK-1020	CT807K1 BS ONLY	SK-1310	CT873WP4	SK-1073AQ1
CT630K1	SK-1120	CT744WP1	SK-1020AQ1	CT810K1	SK-1658	CT874K1	SK-1162
CT630K2	SK-1119	CT745K1	SK-1286	CT821K1	SK-1322	CT874WP1	SK-1162AQ2
CT630K3	SK-1120	CT747K1	SK-1049	CT825K1	SK-1172	CT874WP2	SK-1162AQ1
CT630K4	SK-1261	CT748K1	SK-1054	CT827K1	SK-1192	CT874WP5	SK-1162AQ3
CT637K1	SK-1026	CT748K2	SK-1164	CT828K1	SK-1196	CT877K1	SK-1361
CT643K1	SK-1061	CT748K3	SK-1168	CT829K1	SK-1457	CT877K2	SK-1410
CT655K1	SK-1203	CT748K4	SK-1054	CT836K1	SK-1313S	CT877K3	SK-1446
CT665K1	SK-1317	CT748K5	SK-1164	CT840K1	SK-1036	CT877WP1	SK-1361AQ1
CT670K1	SK-1445	CT748K6	SK-1168	CT840K2	SK-1099	CT877WP2	SK-1410AQ1
CT674K1	SK-1202	CT749K1	SK-1091	CT841K1	SK-1314	CT878K1	SK-1345
CT680K1	SK-1650	CT750K1	SK-1092	CT842K1	SK-1463	CT879K1	SK-1076
CT680K2	SK-1327	CT751K1	SK-1225	CT843K1	SK-1205	CT880K2	SK-1411
CT684K1	SK-1011	CT754K1	SK-1019	CT845K1	SK-1344	CT881K1	SK-1105
CT685K1	SK-1160	CT754K2	SK-1159	CT845WP1	SK-1344AQ1	CT881K2	SK-1077
CT690K1	SK-1027	CT755K1	SK-1570	CT846K1	SK-1131	CT881K3	SK-1659
CT692K1	SK-1066	CT755K2	SK-1360	CT846K2	SK-1592	CT881K4	SK-1077
CT695K1	SK-1188	CT755WP1	SK-1360AQ1	CT846WP1	SK-1131AQ2	CT881K5	SK-1659
CT700K1	SK-1018S	CT757K1	SK-1245	CT846WP2	SK-1592AQ1	CT881WP1	SK-1077AQ1
CT704K1	SK-1129	CT759K1	SK-1103	CT846WP3	SK-1131AQ1	CT881WP2	SK-1659AQ1
CT704K1+CT641	SK-1129	CT760K1	SK-1171	CT847K1	SK-1074	CT884K1	SK-1508
CT704WP1	SK-1129AQ1	CT760K2	SK-1089	CT847WP1	SK-1074AQ1	CT887K1	SK-1273
CT706K1	SK-1195	CT762K1	SK-1228	CT848K1	SK-1090	CT887WP1	SK-1273AQ1
CT708K1	SK-1067	CT763K1	SK-1211	CT848K3	SK-1101	CT887WP2	SK-1273AQ2
CT709K1	SK-1021	CT765K1	SK-1227	CT848K4	SK-1090	CT891K1	SK-1034
CT709WP1	SK-1021AQ2	CT769K1	SK-1224	CT850K1	SK-1075	CT895K1	SK-1564
CT709WP2	SK-1021AQ1	CT770K1	SK-1150	CT853K1	SK-1095	CT898K1	SK-1519
CT710K1	SK-1005	CT772K1	SK-1017	CT854K1	SK-1573	CT899K1	SK-1233
CT711K1	SK-1013	CT772WP1	SK-1017AQ1	CT855K1	SK-1270	CT901K1	SK-1041
CT714K1	SK-1236	CT773K1	SK-1213	CT861K1	SK-1154	CT901K2	SK-1042
CT715K1	SK-1242	CT774K1	SK-1226	CT862K1	SK-1288	CT901K3	SK-1078
CT718K1	SK-1003	CT775K1	SK-1016	CT863K1	SK-1277	CT901WP1	SK-1078AQ1
CT718K2	SK-1176	CT781K1	SK-1068S	CT864K1	SK-1158	CT901WP2	SK-1078AQ2
CT718WP1	SK-1003AQ1	CT781K1+CT933K1	SK-1068	CT865K1	SK-1079	CT901WP3	SK-1078AQ3
CT720WP1	R-1072AQ1	CT781K2	SK-1440	CT866K1	SK-1169	CT902K1	SK-1265
CT723K1	SK-1522	CT782K1	SK-1072	CT867K1	SK-1029	CT906K1	SK-1040
CT724K1	SK-1163	CT786K1	SK-1210	CT867K2	SK-1122	CT906K2	SK-1642
CT726K1	SK-1343	CT787K1	SK-1221	CT867K3	SK-1069	CT906WP1	SK-1040AQ1
CT726K2	SK-1376	CT788K1	SK-1407	CT867K4	SK-1098	CT908K1	SK-1109
CT726WP2	SK-1376AQ1	CT790K1	SK-1231	CT869K1	SK-1047	CT908WP1	SK-1109AQ1
CT728K1	SK-1094	CT791K1+CT939K2	SK-1539	CT869K2	SK-1124	CT908WP2	SK-1109AQ2
CT728WP1	SK-1094AQ1	CT792K1	SK-1335	CT870K1	SK-1100	CT909K10	SK-1726
CT729K1	SK-1053	CT793K1	SK-1246	CT870WP2	SK-1100AQ1	CT909K2	SK-1660
CT731K1	SK-1657	CT794K1	SK-1070	CT871K1	SK-1165	CT909K2	SK-1710
CT732WP1	R-1257AQ1	CT799K1+CT800K1	SK-1220	CT871K2	SK-1038	CT909K3	SK-1660
CT737K1	SK-1174	CT801K1	SK-1237S	CT872K1	SK-1123	CT909K4	SK-1640
CT738K1	SK-1234	CT801K1+CT991K3	SK-1237	CT872K2	SK-1104	CT909K6	SK-1337
CT738K2	SK-1320	CT803K1	SK-1500	CT873K1	SK-1073	CT909K7	SK-1337

CONTI

CONTI

CONTI

CONTI

CT909K7	SK-1709
CT909K8	SK-1661
CT909K9	SK-1661
CT909WP1	SK-1660AQ1
CT909WP2	SK-1726AQ1
CT909WP3	SK-1726AQ2
CT910K1	SK-1183
CT914K1+CT939K2	SK-1526
CT914K1+CT939K3	SK-1529
CT915K1	SK-1081
CT918K1	SK-1080
CT919K1	SK-1638
CT919K2	SK-1346
CT919K3	SK-1121
CT919K4	SK-1638
CT919K5	SK-1121
CT919K5	SK-1641
CT920K1	SK-1383
CT920K2	SK-1377
CT920K3	SK-1386
CT920K4	SK-1636
CT920K5	SK-1688
CT920K6	SK-1687
CT920WP1	SK-1386AQ1
CT920WP2	SK-1386AQ1
CT920WP3	SK-1377AQ1
CT921K1	SK-1096
CT921WP1	SK-1096AQ1
CT924K1	SK-1644
CT924WP1	SK-1644AQ1
CT926K1	SK-1130
CT927K1	SK-1043
CT927WP1	SK-1043AQ1
CT929K2	SK-1706
CT929K2 + CT1112	SK-1507
CT931K1	SK-1050
CT933K1	SK-1662
CT935K1	SK-1107
CT937K1	SK-1651
CT937K1	SK-1656
CT937K2	SK-1684
CT939K1+CT645	SK-1578
CT939K2+CT645	SK-1648
CT939K3	SK-1725
CT939K4	SK-1380
CT939WP1	SK-1578AQ1
CT939WP2+CT914K1	SK-1526AQ1
CT939WP3	SK-1725AQ1
CT939WP3+CT914K1	SK-1529AQ1
CT939WP4	SK-1380AQ1

CT939WP6	SK-1526AQ2
CT940K1	SK-1114
CT940K2	SK-1084
CT940K3	SK-1663
CT941K1	SK-1325
CT942K1	SK-1634
CT945K1	SK-1425
CT945K2	SK-1593
CT946K1	SK-1110
CT946K2	SK-1111
CT946WP1	SK-1111AQ1
CT947K1	SK-1637
CT947K2	SK-1415
CT949K1	SK-1108S
CT949K2	SK-1108
CT950K1+CT954K1	SK-1102
CT951K1	SK-1087
CT955K1	SK-1082
CT955K2	SK-1399
CT957K1	SK-1511
CT957K2	SK-1585
CT957K3	SK-1511
CT957WP1	SK-1511AQ1
CT957WP2	SK-1511AQ2
CT957WP3	SK-1511AQ1
CT957WP4	SK-1585AQ1
CT959K1	SK-1184
CT968K1	SK-1112
CT968K2	SK-1629
CT968WP1	SK-1112AQ1
CT968WP2	SK-1629AQ1
CT969K1	SK-1365
CT969WP1	SK-1697AQ1
CT970K1	SK-1664
CT970K1	SK-1755
CT972K1	SK-1222
CT973K1	SK-1665
CT973WP1	SK-1665AQ1
CT973WP2	SK-1665AQ2
CT974K1	SK-1504
CT975K1	SK-1355
CT975K2	SK-1113
CT975K3	SK-1355
CT975WP1	SK-1355AQ2
CT975WP2	SK-1355AQ1
CT975WP3	SK-1355AQ3
CT975WP5	SK-1113AQ2
CT975WP6	SK-1113AQ1
CT976K1	SK-1088
CT976K2	SK-1630

CT977K1	SK-1494
CT977K2	SK-1631
CT978K1	SK-1340
CT978K2	SK-1339
CT979K1	SK-1491
CT979K2	SK-1492
CT979K3	SK-1666
CT979WP1	SK-1491AQ1
CT979WP2	SK-1492AQ1
CT981K1	SK-1531
CT982K1	SK-1618
CT983K1	SK-1341
CT983K2	SK-1341
CT984K2 + CT1018K1	SK-1633
CT986K1	SK-1086
CT986K2	SK-1086
CT986WP1	SK-1086AQ1
CT986WP2	SK-1086AQ1
CT987K1	SK-1085
CT987K2	SK-1085
CT987WP1	SK-1085AQ1
CT988K1	SK-1338
CT988K2	SK-1338
CT988K3	SK-1704
CT988WP1	SK-1338AQ1
CT988WP2	SK-1338AQ2
CT989K1	SK-1046
CT994K1	SK-1716
CT995K2	SK-1646
CT995WP1	SK-1646AQ1
CT996K1	SK-1715
CT997K1	SK-1421
CT997WP1	SK-1421AQ1
CT998K1	SK-1186
CT999K1	SK-1418
CT999WP1	SK-1418AQ1
V55000	0-N809
V55001	0-N925
V55002	0-N955
V55003	0-N866
V55004	0-N867
V55005	0-N954
V55006	0-N1301
V55007	0-N1298
V55010	0-N2409
V55034	0-N2410
V55100	0-N846
V55101	0-N847
V55102	0-N1278
V55202	0-N837

V55203	0-N838
V55204	0-N874
V55205	0-N902
V55206	0-N839
V55208	0-N842
V55210	0-N904
V55211	0-N096
V55214	0-N915
V55217	0-N985
V55218	0-N1260
V55219	0-N123
V55220	0-N089
V55226	0-N294
V55227	0-N290
V55228	0-N291
V55229	0-N292
V55230	0-N293
V55231	0-N295
V55239	0-N1367
V55240	0-N1361
V55249	0-N903
V55282	0-N1564
V55301	0-N875
V55302	0-N948
V55303	0-N877
V55304	0-N876
V55305	0-N909
V55306	0-N100
V55307	0-N879
V55308	0-N910
V55311	0-N907
V55312	0-N953
V55313	0-N952
V55314	0-N906
V55315	0-N101
V55316	0-N126
V55317	0-N878
V55321	0-N956
V55322	0-N957
V55323	0-N127
V55327	0-N102
V55333	0-N300
V55342	0-N1383
V55344	0-N1085
V55348	0-N1369
V55349	0-N1574
V55351	0-N1347
V55356	0-N1348
V55368	0-N878
V55370	0-N1952



CONTI		CONTI		CONTI		CONTI	
V55371	0-N1960	V55492	0-N1275	V55710	0-N1363	V55876	0-N1093
V55373	0-N300	V55493	0-N1237	V55711	0-N1371	V55878	0-N1572
V55383	0-N1085	V55494	0-N1048	V55712	0-N1051	V55881	0-N1351
V55400	0-N805	V55495	0-N1274	V55712	0-N1051S	V55882	0-N1352
V55401	0-N807	V55496	0-N1050	V55715	0-N1049	V55898	0-N1326
V55402	0-N808	V55497	0-N1344	V55719	0-N1331	V55901	0-N943
V55403	0-N923	V55498	0-N1364	V55727	0-N1568	V55906	0-N121
V55404	0-N922	V55499	0-N1372	V55728	0-N1569	V55907	0-N122
V55405	0-N806	V55500	0-N863	V55729	0-N130	V55921	0-N118P
V55406	0-N924	V55501	0-N856	V55730	0-N1316	V55922	0-N119P
V55407	0-N940	V55502	0-N173	V55732	0-N1342	V55923	0-N215
V55413	0-N132	V55503	0-N854	V55735	0-N1046	V55924	0-N214
V55414	0-N103	V55506	0-N883	V55736	0-N1332	V55938	0-N1058
V55415	0-N128	V55507	0-N887	V55739	0-N1045	V55943	0-N1061
V55417	0-N921	V55510	0-N880	V55741	0-N201	V55949	0-N1057
V55419	0-N160	V55511	0-N881	V55742	0-N1054	V55950	0-N1065
V55420	0-N941	V55514	0-N882	V55744	0-N1052	V55953	0-N1062
V55421	0-N805	V55515	0-N913	V55748	0-N1341	V55954	0-N1066
V55422	0-N2000	V55518	0-N857	V55765	0-N1654	V55958	0-N1277
V55425	0-N1444	V55519	0-N1368	V55766	0-N1335	V55964	0-N1381
V55426	0-N104	V55524	0-N964	V55767	0-N1336	V55965	0-N1060
V55427	0-N105	V55532	0-N277	V55769	0-N1340	V55967	0-N1356
V55428	0-N106	V55536	0-N112	V55771	0-N1337	V55968	0-N1456
V55433	0-N166	V55537	0-N965	V55773	0-N1346	V55969	0-N1334
V55436	0-N1229	V55538	0-N145	V55781	0-N1566	V55971	0-N1357
V55437	0-N1230	V55539	0-N148	V55782	0-N1567	V55972	0-N1358
V55438	0-N129	V55540	0-N1259	V55801	0-N822	V55973	0-N1327
V55439	0-N939	V55541	0-N137	V55804	0-N818	V55974	0-N1338
V55440	0-N1236	V55555	0-N200	V55805	0-N819	V55977	0-N1343
V55441	0-N131	V55561	0-N147	V55806	0-N820	V55978	0-N1614
V55442	0-N1042	V55562	0-N199	V55807	0-N823	V55979	0-N1615
V55443	0-N157	V55565	0-N262	V55809	0-N826	V55984	0-N1613
V55445	0-N108	V55566	0-N198	V55811	0-N832	V55997	0-N118P
V55446	0-N109	V55567	0-N146	V55815	0-N850	V56000	0-N800
V55447	0-N110	V55572	0-N1112	V55822	0-N821	V56001	0-N801
V55453	0-N2001	V55573	0-N1106	V55825	0-N889	V56010	0-N937
V55454	0-N111	V55575	0-N1270	V55826	0-N816	V56015	0-N1616
V55455	0-N1262	V55580	0-N1173	V55829	0-N835	V56036	0-N115
V55456	0-N158	V55581	0-N1111	V55831	0-N113	V56101	0-N897
V55457	0-N167	V55582	0-N1269	V55832	0-N208	V56104	0-N894
V55458	0-N164	V55587	0-N1365	V55833	0-N951	V56109	0-N1243
V55459	0-N168	V55604	0-N1571	V55835	0-N114	V56110	0-N237
V55460	0-N159	V55605	0-N1323	V55837	0-N949	V56111	0-N236
V55461	0-N1263	V55622	0-N145	V55842	0-N950	V56119	0-N1261
V55465	0-N1268	V55629	0-N2060	V55844	0-N115	V56120	0-N1248
V55477	0-N116	V55703	0-N1266	V55850	0-N194	V56122	0-N1273
V55478	0-N117	V55704	0-N169	V55851	0-N938	V56127	0-N1120
V55489	0-N1265	V55705	0-N1570	V55852	0-N195	V56132	0-N1122
V55490	0-N1238	V55707	0-N168	V55853	0-N196	V56137	0-N1272
V55491	0-N107	V55709	0-N1276	V55875	0-N1092	V56303	0-N1575

CONTI

CONTI

CONTI

CONTI

V56340	0-N1905
V56349	0-N2061
V56350	0-N2025
V56354	0-N1053
V56364	0-N2195
V56365	0-N2234
V56368	0-N2208
V56376	0-N2200
V56404	0-N1438
V56404	0-N1438S
V56415	0-N1353
V56416	0-N1355
V56417	0-N1354
V56500	0-N860
V56506	0-N1349
V56511	0-N959
V56512	0-N930
V56514	0-N920
V56515	0-N958
V56516	0-N919
V56518	0-N172
V56521	0-N1362
V56522	0-N1350
V56536	0-N1324
V56542	0-N1573
V56560	0-N1349
V56600	0-N811
V56602	0-N861
V56603	0-N862
V56604	0-N812
V56607	0-N869
V56609	0-N813
V56610	0-N814
V56613	0-N815
V56618	0-N870
V56620	0-N811
V56621	0-N911
V56622	0-N901
V56623	0-N871
V56625	0-N900
V56628	0-N944
V56631	0-N945
V56638	0-N1359
V56642	0-N1360
V56643	0-N1056
V56644	0-N170
V56645	0-N171
V56647	0-N2018
V56658	0-N2063
V56800	0-N094

V56802	0-N021
V56803	0-N032
V56807	0-N030
V56808	0-N031
V56809	0-N029
V56810	0-N028
V56812	0-N027
V56820	0-N035
V56821	0-N034
V56900	0-N999
V56901	0-N992
V56902	0-N991
V56903	0-N995
V56904	0-N996
V56905	0-N005
V56906	0-N006
V56912	0-N990
V56913	0-N988
V56914	0-N989
V56915	0-N997
V56917	0-N008
V56920	0-N007
V56928	0-N013
V56929	0-N014
V56939	0-N176
V56943	0-N1329
V56951	0-N1328
V56959	0-N1820
V57002	0-N069
V57003	0-N070
V57004	0-N180
V57005	0-N076
V57006	0-N078
V57007	0-N077
V57008	0-N080
V57009	0-N081
V57010	0-N079
V57011	0-N084
V57013	0-N073
V57014	0-N075
V57015	0-N074
V57019	0-N083
V57020	0-N983
V57023	0-N071
V57026	0-N1760
V57027	0-N1375
V57028	0-N1376
V57029	0-N1550
V57034	0-N1379
V57035	0-N1578

V57044	0-N1380
V57047	0-N1377
V57048	0-N1778
V57061	0-N1936
V57064	0-N1378
V57201	0-N912
V57202	0-N1917
V57203	0-N1911
V57204	0-N1914
V57206	0-N2056
V57207	0-N2044
V57300	0-N986
V57301	0-N987
V57302	0-N053
V57303	0-N054
V57305	0-N058
V57306	0-N051
V57307	0-N183
V57308	0-N065
V57309	0-N179
V57310	0-N059
V57311	0-N188
V57312	0-N182
V57313	0-N061
V57314	0-N184
V57315	0-N060
V57317	0-N064
V57318	0-N186
V57319	0-N056
V57321	0-N052
V57323	0-N191
V57324	0-N192
V57327	0-N1127
V57329	0-N1129
V57400	0-N979
V57401	0-N927
V57403	0-N978
V57404	0-N926
V57406	0-N905
V57407	0-N178
V57411	0-N981
V57416	0-N1781
V57426	0-N1330
V57700	0-N017
V57702	0-N018
V57703	0-N020
V57704	0-N916
V57705	0-N019
V57900	0-N037
V57908	0-N036

V57909	0-N1562
V57910	0-N1563
V58100	0-N1223
V58101	0-N1225
V58102	0-N1226
V58107	0-N1767
V58109	0-N1775
V58110	0-N1828
V58115	0-N1777
V58116	0-N1776
V58260	0-N859
V58400	0-N055
V58401	0-N1374
V58402	0-N1561
V58403	0-N975
V58404	0-N1370
V58405	0-N1577
V58406	0-N1498
V58407	0-N1576
V58408	0-N1499S
V58409	0-N1500
V58410	0-N1366
V58428	0-N1619
V58432	0-N1499
V58612	0-N1612
V58613	0-N1411
V59000	0-N974
V59001	0-N971
V59002	0-N970
V59003	0-N973
V59503	0-N049
V59505	0-N050
V85502	0-N1446
V85503	0-N1402
V85503	0-N1402S
V85543	0-N1822
V85543	0-N1822S
V85546	0-N1290
V85546	0-N1290S
V85580	0-N1733
V85580	0-N1733S
V85585	0-N1663
V85585	0-N1663S
V85593	0-N1523
V85600	0-N2111
V85600	0-N2111S

DAYCO

APV1000	0-N1407
APV1000	0-N1407S
APV1001	0-N1484



DAYCO		DAYCO		DAYCO		DAYCO	
APV1001	0-N1484S	APV1068	0-N1399	APV2038	0-N1317S	APV2118	0-N1546
APV1002	0-N1595	APV1071	0-N1842	APV2040	0-N1640	APV2120	0-N1602
APV1002	0-N1595S	APV1071	0-N1842S	APV2040	0-N1640S	APV2121	0-N1437
APV1003	0-N1410	APV1072	0-N1481	APV2041	0-N2332	APV2122	0-N1439
APV1004	0-N1857	APV1072	0-N1481S	APV2043	0-N2140	APV2123	0-N2153
APV1004	0-N1857S	APV1073	0-N1806	APV2046	0-N2174	APV2124	0-N1722
APV1005	0-N2053	APV1074	0-N1597	APV2047	0-N1904	APV2127	0-N2347
APV1005	0-N2053S	APV1075	0-N1483	APV2047	0-N1975	APV2129	0-N1586
APV1007	0-N1401	APV1075	0-N1483S	APV2048	0-N2335	APV2132	0-N2349
APV1008	0-N1402	APV1076	0-N1339	APV2049	0-N2334	APV2134	0-N1431
APV1008	0-N1402S	APV1076	0-N1339S	APV2050	0-N2333	APV2135	0-N2345
APV1009	0-N1465S	APV1077	0-N1487	APV2051	0-N150	APV2139	0-N2176
APV1010	0-N1463S	APV1077	0-N1487S	APV2055	0-N1748	APV2140	0-N1751
APV1011	0-N1405	APV1078	0-N1526	APV2056	0-N1752	APV2142	0-N187
APV1012	0-N2256	APV1078	0-N1526S	APV2058	0-N2154	APV2143	0-N1730
APV1014	0-N1809	APV1079	0-N1517	APV2059	0-N149	APV2144	0-N1753
APV1014	0-N1809S	APV1079	0-N1517S	APV2060	0-N1585	APV2147	0-N1590
APV1017	0-N1544	APV1080	0-N2117	APV2060	0-N1585S	APV2148	0-N1446
APV1018	0-N1544	APV1080	0-N2117S	APV2061	0-N1599	APV2149	0-N2343
APV1019	0-N1594	APV1081	0-N1410S	APV2061	0-N1599S	APV2151	0-N1292
APV1020	0-N1464	APV1088	0-N1503	APV2063	0-N1721	APV2159	0-N1307
APV1020	0-N1464S	APV1088	0-N1503S	APV2064	0-N1314	APV2161	0-N2342
APV1021	0-N1438	APV1090	0-N1945	APV2066	0-N1514	APV2163	0-N197
APV1021	0-N1438S	APV1090	0-N1945S	APV2066	0-N1514S	APV2164	0-N1592
APV1022	0-N1404	APV1091	0-N1408	APV2070	0-N1903	APV2165	0-N1442
APV1023	0-N1596	APV1114	0-N2037	APV2070	0-N1903S	APV2166	0-N1726
APV1024	0-N1413	APV1114	0-N2037S	APV2073	0-N1624	APV2168	0-N1715
APV1026	0-N1386	APV1150	0-N1714	APV2073	0-N1624S	APV2168	0-N1740
APV1026	0-N1711S	APV1150	0-N1714S	APV2074	0-N2141	APV2168	0-N2110
APV1028	0-N1493	APV1155	0-N1667	APV2075	0-N1474	APV2170	0-N1668
APV1028	0-N1493S	APV1156	0-N1503	APV2079	0-N1894	APV2170	0-N1668S
APV1029	0-N1309	APV1156	0-N1503S	APV2081	0-N2041	APV2172	0-N2127
APV1030	0-N1471	APV1157	0-N1522	APV2082	0-N2024	APV2173	0-N1603
APV1030	0-N1471S	APV2006	0-N1682	APV2085	0-N1388	APV2178	0-N1425
APV1031	0-N2054	APV2008	0-N139	APV2086	0-N846	APV2179	0-N174
APV1032	0-N187	APV2014	0-N1712	APV2087	0-N1278	APV2180	0-N1419
APV1033	0-N1634	APV2017	0-N1296	APV2089	0-N1280	APV2183	0-N1421
APV1034	0-N1672	APV2018	0-N1927	APV2090	0-N1862	APV2186	0-N1649
APV1035	0-N1644	APV2021	0-N095	APV2092	0-N1417	APV2187	0-N1396
APV1040	0-N1387	APV2022	0-N1750	APV2094	0-N1600	APV2188	0-N1409
APV1041	0-N1398	APV2023	0-N133	APV2096	0-N1584	APV2189	0-N1591
APV1044	0-N1480S	APV2030	0-N1713	APV2103	0-N2179	APV2190	0-N1966
APV1046	0-N1720	APV2031	0-N1899	APV2104	0-N1589	APV2191	0-N1403
APV1046	0-N1720S	APV2032	0-N1749	APV2107	0-N1308	APV2193	0-N1628
APV1047	0-N1627	APV2032	0-N1749S	APV2108	0-N1604	APV2197	0-N2186
APV1047	0-N1627S	APV2033	0-N1681	APV2109	0-N1301	APV2198	0-N1521
APV1058	0-N1528	APV2034	0-N1968	APV2110	0-N2156	APV2202	0-N1723
APV1058	0-N1528S	APV2036	0-N1949	APV2112	0-N847	APV2203	0-N2206
APV1059	0-N1394	APV2037	0-N1005	APV2113	0-N1288	APV2205	0-N1395
APV1061	0-N1598	APV2038	0-N1317	APV2114	0-N1864	APV2207	0-N1397

DAYCO		DAYCO		DAYCO		DAYCO	
APV2207	0-N2419	APV2260	0-N1462	APV2307	0-N1588S	APV2463	0-N1808
APV2208	0-N1298	APV2260	0-N1462S	APV2309	0-N1657	APV2463	0-N1808S
APV2209	0-N2348	APV2261	0-N1488	APV2309	0-N1657S	APV2464	0-N2116
APV2210	0-N1973	APV2261	0-N1488S	APV2310	0-N1671	APV2464	0-N2116S
APV2211	0-N2349	APV2263	0-N1732	APV2310	0-N1671S	APV2465	0-N2055
APV2212	0-N2152	APV2263	0-N1732S	APV2311	0-N1497	APV2465	0-N2055S
APV2213	0-N2173	APV2265	0-N1717	APV2311	0-N1497S	APV2466	0-N1502
APV2214	0-N1450	APV2265	0-N1717S	APV2312	0-N1897	APV2466	0-N1502S
APV2216	0-N1416	APV2266	0-N1470	APV2312	0-N1897S	APV2474	0-N1733
APV2218	0-N1974	APV2266	0-N1470S	APV2313	0-N1845	APV2474	0-N1733S
APV2219	0-N2409	APV2267	0-N1593	APV2313	0-N1845S	APV2476	0-N1537
APV2221	0-N2412	APV2267	0-N1593S	APV2315	0-N1494	APV2476	0-N1537S
APV2222	0-N1758	APV2269	0-N1485	APV2315	0-N1494S	APV2477	0-N1664
APV2223	0-N1303	APV2269	0-N1485S	APV2317	0-N1558S	APV2477	0-N1664S
APV2224	0-N2413	APV2271	0-N1486	APV2318	0-N1459	APV2478	0-N1492
APV2225	0-N2181	APV2271	0-N1486S	APV2318	0-N1459S	APV2478	0-N1492S
APV2226	0-N1747	APV2272	0-N1509	APV2319	0-N1555	APV2479	0-N1797
APV2228	0-N1787	APV2272	0-N1509S	APV2319	0-N1555S	APV2479	0-N1797S
APV2229	0-N2410	APV2273	0-N1669	APV2320	0-N1539	APV2480	0-N1667
APV2232	0-N1641	APV2273	0-N1669S	APV2320	0-N1539S	APV2482	0-N1861
APV2232	0-N1641S	APV2276	0-N1513	APV2322	0-N1606	APV2483	0-N2187
APV2233	0-N1932	APV2276	0-N1513S	APV2322	0-N1606S	APV2485	0-N1677
APV2234	0-N1800	APV2278	0-N1516	APV2323	0-N1476	APV2485	0-N1677S
APV2235	0-N565592	APV2278	0-N1516S	APV2323	0-N1476S	APV2486	0-N2406
APV2237	0-N2169	APV2279	0-N1791	APV2324	0-N1611	APV2486	0-N2406S
APV2238	0-N1756	APV2279	0-N1791S	APV2324	0-N1611S	APV2487	0-N1877
APV2240	0-N1660	APV2280	0-N1515	APV2363	0-N2157	APV2487	0-N1877S
APV2241	0-N1041	APV2280	0-N1515S	APV2364	0-N1469	APV2491	0-N1741
APV2241	0-N1041S	APV2283	0-N1284	APV2366	0-N1625	APV2491	0-N1741S
APV2242	0-N1822	APV2285	0-N1287	APV2366	0-N1625S	APV2493	0-N2257
APV2242	0-N1822S	APV2292	0-N1587	APV2367	0-N1967	APV2493	0-N2257S1
APV2244	0-N1538	APV2292	0-N1587S	APV2368	0-N1860	APV2493	0-N2257S2
APV2244	0-N1538S	APV2294	0-N1953	APV2369	0-N1951	APV2496	0-N1626
APV2246	0-N1703	APV2294	0-N1953S	APV2370	0-N2144	APV2496	0-N1626S
APV2247	0-N2170	APV2295	0-N1472	APV2371	0-N2145	APV2497	0-N1957
APV2247	0-N2170S	APV2295	0-N1472S	APV2372	0-N2147	APV2497	0-N1957S
APV2249	0-N1511	APV2298	0-N1291	APV2373	0-N2142	APV2498	0-N1427
APV2251	0-N1527	APV2298	0-N1291S	APV2375	0-N1473	APV2498	0-N1427S
APV2251	0-N1527S	APV2300	0-N1645	APV2375	0-N1473S	APV2498	0-N2405
APV2252	0-N2180	APV2300	0-N1645S	APV2375	0-N2175	APV2498	0-N2405S
APV2253	0-N1011	APV2301	0-N1466	APV2376	0-N2172	APV2499	0-N2134
APV2253	0-N1011S	APV2301	0-N1466S	APV2376	0-N2172S	APV2500	0-N1799
APV2254	0-N1013	APV2302	0-N1083	APV2378	0-N1289	APV2500	0-N1799S
APV2254	0-N1013S	APV2304	0-N1512	APV2380	0-N2146	APV2503	0-N1719
APV2255	0-N1559S	APV2304	0-N1512S	APV2422	0-N1530	APV2503	0-N1719S
APV2256	0-N2135	APV2305	0-N1507	APV2422	0-N1530S	APV2504	0-N2148
APV2258	0-N1543	APV2305	0-N1507S	APV2423	0-N2093	APV2505	0-N1659
APV2259	0-N1441	APV2306	0-N1445	APV2423	0-N2093S	APV2505	0-N1659S
APV2259	0-N1441S	APV2306	0-N1445S	APV2424	0-N2042	APV2506	0-N1638
APV2259	0-N2047	APV2307	0-N1588	APV2424	0-N2042S	APV2508	0-N1798



DAYCO		DAYCO		DAYCO		DAYCO	
APV2508	0-N1798S	APV2553	0-N1940S	APV2681	0-N1920	APV2804	0-N1875S
APV2509	0-N1736	APV2554	0-N1710	APV2682	0-N1392	APV2805	0-N2171
APV2510	0-N1898	APV2554	0-N1710S	APV2710	0-N1610	APV2810	0-N1728
APV2510	0-N1898S	APV2555	0-N1704	APV2711	0-N1926	APV2815	0-N1385
APV2511	0-N1534	APV2555	0-N1704S	APV2712	0-N1840	APV2822	0-N2122
APV2511	0-N1534S	APV2556	0-N1874	APV2712	0-N1840S	APV2823	0-N1984
APV2512	0-N1560	APV2556	0-N1874S	APV2714	0-N2414	APV2827	0-N2199
APV2513	0-N1805	APV2557	0-N2115	APV2740	0-N1964	APV2828	0-N2132
APV2513	0-N1805S	APV2557	0-N2115S	APV2740	0-N1964S	APV2829	0-N2238
APV2514	0-N2346	APV2558	0-N1662	APV2749	0-N1532	APV2830	0-N2205
APV2516	0-N2336	APV2559	0-N1523	APV2749	0-N1532S	APV2831	0-N2404
APV2517	0-N1738	APV2560	0-N1505S	APV2750	0-N2091	APV2831	0-N2404S
APV2518	0-N1453	APV2562	0-N1979	APV2750	0-N2091S	APV2832	0-N2402
APV2519	0-N1734	APV2562	0-N1979S	APV2751	0-N1795	APV2832	0-N2402S
APV2523	0-N1454	APV2625	0-N1731	APV2753	0-N2155	APV2834	0-N1832
APV2524	0-N1525	APV2625	0-N1731S	APV2753	0-N2155S	APV2834	0-N1832S
APV2524	0-N1525S	APV2626	0-N2076	APV2754	0-N2158	APV2836	0-N2038
APV2525	0-N1959	APV2626	0-N2076S	APV2754	0-N2158S	APV2836	0-N2038S
APV2526	0-N152	APV2627	0-N1554	APV2756	0-N1964	APV2837	0-N2214
APV2526	0-N152S	APV2627	0-N1554S	APV2756	0-N1964S	APV2837	0-N2214S
APV2527	0-N1663	APV2628	0-N1794	APV2757	0-N2221	APV2838	0-N2083
APV2527	0-N1663S	APV2628	0-N1794S	APV2762	0-N2105	APV2838	0-N2083S
APV2528	0-N1636	APV2629	0-N2045	APV2762	0-N2105S	APV2840	0-N2088
APV2528	0-N1636S	APV2629	0-N2045S	APV2764	0-N1813	APV2840	0-N2088S
APV2529	0-N1788	APV2631	0-N1675	APV2764	0-N1813S	APV2841	0-N2213
APV2529	0-N1788S	APV2640	0-N1432	APV2765	0-N1908	APV2841	0-N2213S
APV2530	0-N1656	APV2642	0-N1946	APV2765	0-N1908S	APV2842	0-N2089
APV2530	0-N1656S	APV2642	0-N1946S1	APV2767	0-N2113	APV2842	0-N2089S
APV2532	0-N2165	APV2642	0-N1946S2	APV2767	0-N2113S	APV2843	0-N2085
APV2534	0-N1913	APV2643	0-N1941	APV2768	0-N1958	APV2843	0-N2085S
APV2534	0-N1913S	APV2643	0-N1941S1	APV2768	0-N1958S	APV2844	0-N2216
APV2535	0-N1900	APV2643	0-N1941S2	APV2770	0-N1716	APV2844	0-N2216S1
APV2539	0-N1673	APV2643	0-N1941S3	APV2774	0-N1793	APV2844	0-N2216S2
APV2539	0-N1673S	APV2646	0-N1744	APV2774	0-N1793S	APV2845	0-N2075
APV2540	0-N1639	APV2664	0-N1746	APV2781	0-N1950	APV2846	0-N2084
APV2540	0-N1639S	APV2664	0-N2138	APV2784	0-N1850	APV2846	0-N2084S
APV2541	0-N1786	APV2666	0-N1987	APV2784	0-N1850S	APV2847	0-N2422
APV2544	0-N1743	APV2667	0-N1801	APV2785	0-N1552	APV2847	0-N2422S
APV2545	0-N2177	APV2668	0-N1553	APV2785	0-N1552S	APV2848	0-N2087
APV2546	0-N1912	APV2671	0-N1869	APV2787	0-N1830	APV2848	0-N2087S
APV2546	0-N1912S	APV2671	0-N1869S	APV2787	0-N1830S	APV2849	0-N1982
APV2547	0-N1620	APV2672	0-N2074	APV2791	0-N2092	APV2974	0-N2028
APV2547	0-N1620S	APV2672	0-N2074S	APV2791	0-N2092S	APV2975	0-N1871
APV2548	0-N1834	APV2673	0-N1991	APV2793	0-N1814	APV2977	0-N1981
APV2548	0-N1834S	APV2674	0-N1621	APV2794	0-N2111	APV2982	0-N2086
APV2550	0-N1942	APV2674	0-N1621S	APV2794	0-N2111S	APV2982	0-N2086S
APV2551	0-N2130	APV2675	0-N1859	APV2795	0-N1962	APV2987	0-N2112
APV2552	0-N2096	APV2678	0-N2427	APV2801	0-N2103	APV2987	0-N2112S
APV2552	0-N2096S	APV2678	0-N2427S	APV2801	0-N2103S	APV2997	0-N2250
APV2553	0-N1940	APV2680	0-N1665	APV2804	0-N1875	APV2997	0-N2250S

DAYCO		DAYCO		DAYCO		DAYCO	
APV3003	0-N2364	ATB1003	0-N1361	ATB2050	0-N1571	ATB2149	0-N1058
APV3005	0-N2104	ATB1004	0-N1351	ATB2050	0-N173	ATB2153	0-N874
APV3005	0-N2104S	ATB1005	0-N1352	ATB2054	0-N978	ATB2156	0-N894
APV3006	0-N2231	ATB1006	0-N208	ATB2055	0-N835	ATB2159	0-N902
APV3006	0-N2231S	ATB1007	0-N115	ATB2061	0-N956	ATB2163	0-N1260
APV3007	0-N2040	ATB1008	0-N1121	ATB2063	0-N912	ATB2164	0-N123
APV3008	0-N2407	ATB1010	0-N1914	ATB2064	0-N878	ATB2166	0-N999
APV3008	0-N2407S	ATB1011	0-N1615	ATB2065	0-N957	ATB2171	0-N808
APV3009	0-N1547	ATB1012	0-N1613	ATB2068	0-N2000	ATB2178	0-N805
APV3018	0-N2351	ATB1013	0-N1614	ATB2070	0-N879	ATB2179	0-N806
APV3020	0-N2252	ATB1014	0-N1057	ATB2071	0-N910	ATB2183	0-N955
APV3020	0-N2252S	ATB1015	0-N1111	ATB2072	0-N126	ATB2187	0-N959
APV3028	0-N2021	ATB1016	0-N1277	ATB2075	0-N147	ATB2189	0-N909
APV3030	0-N2398	ATB1017	0-N1564	ATB2076	0-N160	ATB2190	0-N952
APV3030	0-N2398S	ATB2000	0-N1326	ATB2077	0-N262	ATB2192	0-N953
APV3035	0-N1928	ATB2000	0-N2149	ATB2080	0-N021	ATB2193	0-N971
APV3036	0-N2271	ATB2001	0-N014	ATB2085	0-N129	ATB2194	0-N158
APV3040	0-N2048	ATB2005	0-N1272	ATB2086	0-N130S	ATB2195	0-N1262
APV3043	0-N1856	ATB2007	0-N1335	ATB2088	0-N157	ATB2196	0-N2001
APV3043	0-N1856S	ATB2009	0-N130	ATB2089	0-N905	ATB2197	0-N1275
APV3049	0-N2212	ATB2010	0-N054	ATB2090	0-N1066	ATB2198	0-N128
APV3049	0-N2212S	ATB2011	0-N055	ATB2091	0-N863	ATB2199	0-N127
APV3052	0-N2217	ATB2012	0-N1380	ATB2094	0-N030	ATB2200	0-N113
APV3052	0-N2217S1	ATB2014	0-N819	ATB2096	0-N031	ATB2201	0-N948
APV3052	0-N2217S2	ATB2015	0-N820	ATB2097	0-N070	ATB2202	0-N104
APV3056	0-N2248	ATB2016	0-N816	ATB2098	0-N018	ATB2203	0-N103
APV3073	0-N2240	ATB2017	0-N821	ATB2099	0-N184	ATB2204	0-N100
APV3090	0-N2275	ATB2019	0-N951	ATB2101	0-N916	ATB2205	0-N106
APV3097	0-N2265	ATB2020	0-N950	ATB2102	0-N1127	ATB2206	0-N1359
APV3097	0-N2265S	ATB2022	0-N881	ATB2108	0-N007	ATB2207	0-N906
APV3099	0-N2341	ATB2024	0-N871	ATB2114	0-N061	ATB2208	0-N1360
APV3100	0-N2299	ATB2025	0-N862	ATB2116	0-N008	ATB2210	0-N965
APV3100	0-N2299S	ATB2026	0-N811	ATB2119	0-N183	ATB2211	0-N938
APV3131	0-N2283	ATB2027	0-N811	ATB2123	0-N069	ATB2212	0-N112
APV3170	0-N2300	ATB2029	0-N944	ATB2126	0-N958	ATB2213	0-N109
APV3170	0-N2300S	ATB2030	0-N945	ATB2127	0-N1065	ATB2214	0-N111
APV3172	0-N2353	ATB2031	0-N1381	ATB2128	0-N1270	ATB2215	0-N114
APV3174	0-N2303	ATB2032	0-N861	ATB2133	0-N987	ATB2216	0-N101
APV3180	0-N2290	ATB2035	0-N122	ATB2134	0-N186	ATB2217	0-N105
APV3180	0-N2290S	ATB2037	0-N1061	ATB2136	0-N035	ATB2218	0-N1268
APV3188	0-N2247	ATB2038	0-N943	ATB2138	0-N077	ATB2219	0-N1112
APV3188	0-N2247S	ATB2039	0-N900	ATB2141	0-N076	ATB2220	0-N970
APV3199	0-N2344	ATB2040	0-N118P	ATB2142	0-N1048	ATB2221	0-N194
APV3207	0-N1811	ATB2041	0-N119P	ATB2143	0-N1236	ATB2222	0-N196
APV3207	0-N1811S	ATB2042	0-N901	ATB2144	0-N1276	ATB2223	0-N200
APV3209	0-N2375	ATB2045	0-N882	ATB2145	0-N1050	ATB2224	0-N199
APV3217	0-N2429	ATB2046	0-N145	ATB2146	0-N1042	ATB2227	0-N1365
ATB1000	0-N294	ATB2047	0-N813	ATB2147	0-N1237	ATB2227	0-N2380
ATB1001	0-N1367	ATB2048	0-N814	ATB2148	0-N1051	ATB2230	0-N089
ATB1002	0-N195	ATB2049	0-N854	ATB2148	0-N1051S	ATB2231	0-N168



DAYCO		DAYCO		DAYCO		DAYCO	
ATB2232	0-N131	ATB2313	0-N1654	ATB2414	0-N1357	ATB2527	0-N1617
ATB2234	0-N137	ATB2314	0-N1368	ATB2415	0-N1324	ATB2530	0-N1346
ATB2235	0-N1269	ATB2315	0-N1575	ATB2416	0-N968	ATB2531	0-N2322
ATB2236	0-N1062	ATB2316	0-N110	ATB2418	0-N1246	ATB2532	0-N1819
ATB2237	0-N178	ATB2317	0-N117	ATB2419	0-N1382	ATB2533	0-N1567
ATB2238	0-N1046	ATB2318	0-N1572	ATB2420	0-N1573	ATB2534	0-N1763
ATB2240	0-N822	ATB2322	0-N1258	ATB2423	0-N020	ATB2535	0-N1762
ATB2246	0-N198	ATB2323	0-N1383	ATB2430	0-N1767	ATB2536	0-N1936
ATB2247	0-N974	ATB2324	0-N1369	ATB2431	0-N1824	ATB2537	0-N1826
ATB2248	0-N1331	ATB2325	0-N1343	ATB2433	0-N1129	ATB2538	0-N1550
ATB2250	0-N1232	ATB2327	0-N108	ATB2435	0-N017	ATB2539	0-N1376
ATB2251	0-N1341	ATB2328	0-N1338	ATB2436	0-N1374	ATB2541	0-N1330
ATB2252	0-N107	ATB2329	0-N1328	ATB2438	0-N975	ATB2542	0-N1820
ATB2253	0-N1045	ATB2332	0-N1358	ATB2441	0-N085	ATB2543	0-N2044
ATB2257	0-N013	ATB2333	0-N116	ATB2445	0-N171	ATB2544	0-N2056
ATB2259	0-N1225	ATB2334	0-N1759	ATB2446	0-N170	ATB2546	0-N1085
ATB2260	0-N1226	ATB2335	0-N1379	ATB2447	0-N2320	ATB2547	0-N115
ATB2266	0-N176	ATB2336	0-N189	ATB2450	0-N1056	ATB2549	0-N2327
ATB2267	0-N973	ATB2337	0-N1775	ATB2451	0-N1566	ATB2550	0-N2161
ATB2268	0-N1316	ATB2340	0-N1362	ATB2454	0-N850	ATB2550	0-N2161S
ATB2269	0-N903	ATB2341	0-N1948	ATB2457	0-N2315	ATB2553	0-N1952
ATB2271	0-N1085	ATB2345	0-N185	ATB2458	0-N1561	ATB2554	0-N1917
ATB2277	0-N1263	ATB2347	0-N181	ATB2462	0-N191	ATB2557	0-N1879
ATB2278	0-N904	ATB2348	0-N1122	ATB2469	0-N192	ATB2558	0-N2057
ATB2279	0-N163	ATB2351	0-N1354	ATB2471	0-N998	ATB2562	0-N2058
ATB2281	0-N915	ATB2353	0-N1355	ATB2472	0-N191	ATB2564	0-N1583
ATB2282	0-N277	ATB2354	0-N2383	ATB2474	0-N1574	ATB2567	0-N2060
ATB2283	0-N146	ATB2356	0-N182	ATB2475	0-N086	ATB2569	0-N2061
ATB2284	0-N148	ATB2357	0-N1342	ATB2477	0-N2325	ATB2571	0-N2200
ATB2285	0-N1259	ATB2358	0-N056	ATB2479	0-N024	ATB2572	0-N2062
ATB2287	0-N1274	ATB2361	0-N1578	ATB2480	0-N1883	ATB2587	0-N1771
ATB2288	0-N1371	ATB2364	0-N1776	ATB2480	0-N1883S	ATB2598	0-N2255
ATB2289	0-N096	ATB2366	0-N1366	ATB2482	0-N2167	ATB2599	0-N1619
ATB2291	0-N907	ATB2368	0-N1378	ATB2483	0-N2319	ATB2601	0-N2150
ATB2292	0-N164	ATB2372	0-N1768	ATB2487	0-N1773	ATB2602	0-N2234
ATB2294	0-N102	ATB2374	0-N1563	ATB2488	0-N2168	ATB2603	0-N2195
ATB2295	0-N166	ATB2376	0-N1829	ATB2495	0-N1373	ATB2609	0-N2382
ATB2296	0-N1336	ATB2378	0-N1562	ATB2498	0-N1618	ATB2610	0-N2208
ATB2297	0-N1238	ATB2381	0-N1353	ATB2506	0-N1347	ATB2611	0-N2224
ATB2298	0-N159	ATB2388	0-N1817	ATB2507	0-N1337	ATB2629	0-N2326
ATB2299	0-N167	ATB2388	0-N1817S	ATB2508	0-N118P	ATB2633	0-N2416
ATB2301	0-N1273	ATB2389	0-N1825	ATB2509	0-N1764	ATB2636	0-N2313
ATB2303	0-N1327	ATB2394	0-N1816	ATB2514	0-N1836	ATB2646	0-N1821
ATB2304	0-N1334	ATB2395	0-N1372	ATB2516	0-N878	ATB2652	0-N2314
ATB2307	0-N1173	ATB2399	0-N1969	ATB2517	0-N1838S	ATB2654	0-N2423
ATB2308	0-N1616	ATB2403	0-N1779	ATB2518	0-N1884	KTB101	SK-1003
ATB2309	0-N1340	ATB2405	0-N1349	ATB2519	0-N1905	KTB102	SK-1004
ATB2310	0-N1323	ATB2408	0-N1350	ATB2520	0-N2018	KTB103	SK-1005
ATB2311	0-N1760	ATB2410	0-N1243	ATB2522	0-N2220	KTB104	SK-1006
ATB2312	0-N1329	ATB2412	0-N1120	ATB2522	0-N2220S	KTB105	SK-1007

DAYCO

KTB106	SK-1021
KTB107	SK-1010
KTB108	SK-1011
KTB109	SK-1015
KTB110	SK-1107
KTB110/1	SK-1012
KTB110/1	SK-1707
KTB112	SK-1108S
KTB113	SK-1020
KTB114	SK-1019
KTB115	SK-1022
KTB116	SK-1159
KTB117	SK-1016
KTB118	SK-1018S
KTB119	SK-1017
KTB124	SK-1188
KTB125	SK-1066
KTB128	SK-1138
KTB129	SK-1014
KTB130	SK-1242
KTB132	SK-1091
KTB134	SK-1092
KTB135	SK-1031
KTB136	SK-1047
KTB137	SK-1157
KTB138	SK-1062
KTB142B	SK-1042
KTB144	SK-1040
KTB151	SK-1060
KTB152	SK-1034
KTB153	SK-1036
KTB154	SK-1043
KTB155	SK-1119
KTB157	SK-1101
KTB158	SK-1445
KTB159	SK-1140
KTB160	SK-1032
KTB163	SK-1050
KTB164	SK-1151
KTB165	SK-1082
KTB166	SK-1053
KTB168	SK-1038
KTB169	SK-1054
KTB170	SK-1163
KTB171	SK-1164
KTB172	SK-1168
KTB173	SK-1165
KTB174	SK-1081
KTB175	SK-1171
KTB176	SK-1063

DAYCO

KTB177	SK-1061
KTB178	SK-1061
KTB178	SK-1172
KTB179	SK-1176
KTB183	SK-1064
KTB185	SK-1103
KTB187	SK-1079
KTB188	SK-1154
KTB189	SK-1122
KTB190	SK-1069
KTB191	SK-1098
KTB192	SK-1093
KTB193	SK-1095
KTB194	SK-1096
KTB195	SK-1084
KTB196	SK-1086
KTB197	SK-1085
KTB199	SK-1646
KTB200	SK-1068
KTB201	SK-1026
KTB203	SK-1126
KTB204	SK-1001
KTB205	SK-1129
KTB207	SK-1027
KTB208	SK-1160
KTB210	SK-1039
KTB211C	SK-1041
KTB212	SK-1052
KTB213	SK-1056
KTB214	SK-1037
KTB217	SK-1059
KTB218	SK-1345
KTB219	SK-1141
KTB220	SK-1033
KTB221	SK-1162
KTB222	SK-1650
KTB226	SK-1242
KTB227	SK-1207
KTB229	SK-1219
KTB230	SK-1275
KTB232	SK-1237S
KTB233	SK-1202
KTB234	SK-1248
KTB235	SK-1189
KTB236	SK-1203
KTB239	SK-1211
KTB241	SK-1196
KTB242	SK-1321
KTB243	SK-1192
KTB244	SK-1226

DAYCO

KTB247	SK-1224
KTB248	SK-1195
KTB249	SK-1308
KTB250	SK-1078
KTB251	SK-1341
KTB252	SK-1073
KTB253	SK-1109
KTB254	SK-1169
KTB255	SK-1131
KTB256	SK-1074
KTB257	SK-1100
KTB258	SK-1067
KTB259	SK-1338
KTB261	SK-1155
KTB262	SK-1094
KTB263	SK-1114
KTB263	SK-1663
KTB264	SK-1213
KTB265	SK-1090
KTB266	SK-1512
KTB267	SK-1106
KTB268	SK-1236
KTB269	SK-1076
KTB270	SK-1087
KTB273	SK-1142
KTB274	SK-1150
KTB276	SK-1065
KTB278	SK-1158
KTB279	SK-1013
KTB280	SK-1012
KTB280/2	SK-1705
KTB281	SK-1645
KTB282	SK-1049
KTB283	SK-1351
KTB285	SK-1412
KTB286	SK-1077
KTB288	SK-1399
KTB289	SK-1622
KTB291	SK-1418
KTB292	SK-1421
KTB293	SK-1394
KTB294	SK-1425
KTB296	SK-1372
KTB297	SK-1227
KTB298	SK-1493
KTB300/1	SK-1657
KTB302	SK-1045
KTB302/1	SK-1045
KTB304	SK-1023
KTB305	SK-1035

DAYCO

KTB305	SK-1680
KTB306	SK-1046
KTB307	SK-1153
KTB308	SK-1113
KTB309	SK-1489
KTB310	SK-1391
KTB311	SK-1637
KTB312	SK-1411
KTB313	SK-1446
KTB314	SK-1410
KTB315	SK-1415
KTB316	SK-1491
KTB317	SK-1629
KTB319	SK-1534
KTB320	SK-1494
KTB321	SK-1486
KTB322	SK-1487
KTB323	SK-1577
KTB325	SK-1123
KTB326	SK-1104
KTB329	SK-1361
KTB330	SK-1639
KTB331	SK-1365
KTB331	SK-1697
KTB332	SK-1609
KTB333	SK-1392
KTB334	SK-1367
KTB335	SK-1642
KTB336	SK-1354
KTB337	SK-1353
KTB339	SK-1610
KTB340	SK-1603
KTB341	SK-1592
KTB342	SK-1582
KTB344	SK-1482
KTB344	SK-1596
KTB347	SK-1511
KTB348	SK-1089
KTB350	SK-1144
KTB351	SK-1143
KTB352	SK-1286
KTB353	SK-1174
KTB354	SK-1075
KTB355	SK-1344
KTB356	SK-1166
KTB358	SK-1261
KTB360	SK-1258
KTB361	SK-1355
KTB362	SK-1624
KTB363	SK-1599



DAYCO

KTB364	SK-1631
KTB366	SK-1216
KTB368	SK-1377
KTB371	SK-1186
KTB372	SK-1522
KTB373	SK-1593
KTB374	SK-1121
KTB375	SK-1225
KTB376	SK-1234
KTB377	SK-1245
KTB378	SK-1210
KTB379	SK-1221
KTB380	SK-1343
KTB382	SK-1070
KTB383	SK-1314
KTB384	SK-1228
KTB385	SK-1222
KTB387	SK-1205
KTB388	SK-1099
KTB389	SK-1564
KTB390	SK-1278
KTB391	SK-1288
KTB392	SK-1277
KTB393	SK-1273
KTB396	SK-1105
KTB397	SK-1508
KTB398	SK-1265
KTB399	SK-1742
KTB400	SK-1306
KTB401	SK-1024
KTB402	SK-1120
KTB403	SK-1029
KTB404	SK-1346
KTB405	SK-1638
KTB406	SK-1504
KTB407	SK-1339
KTB408	SK-1340
KTB412	SK-1478
KTB413	SK-1620
KTB414	SK-1479
KTB414	SK-1481
KTB414	SK-1689
KTB415	SK-1583
KTB416	SK-1378
KTB417	SK-1615
KTB418	SK-1335
KTB419	SK-1072
KTB420	SK-1309S
KTB421	SK-1264
KTB424	SK-1546S

DAYCO

KTB425	SK-1240S
KTB426	SK-1270
KTB428	SK-1625
KTB429	SK-1110
KTB429	SK-1259
KTB430	SK-1184
KTB431	SK-1187
KTB432	SK-1183
KTB433	SK-1233
KTB434	SK-1521
KTB435	SK-1527
KTB436	SK-1260
KTB437	SK-1220
KTB438	SK-1508
KTB439	SK-1649
KTB440	SK-1675
KTB441	SK-1595
KTB442	SK-1388
KTB443	SK-1641
KTB444	SK-1218
KTB445	SK-1469
KTB449	SK-1587
KTB450	SK-1453
KTB452	SK-1185
KTB453	SK-1112
KTB455	SK-1594
KTB456	SK-1102
KTB457	SK-1602
KTB458	SK-1696
KTB459	SK-1586
KTB460	SK-1088
KTB461	SK-1659
KTB463	SK-1638
KTB464	SK-1121
KTB465	SK-1493
KTB466	SK-1677
KTB467	SK-1580
KTB468	SK-1612
KTB471	SK-1685
KTB472	SK-1633
KTB473	SK-1648
KTB475	SK-1640
KTB477	SK-1376
KTB481	SK-1375
KTB481	SK-1619
KTB483	SK-1337
KTB483	SK-1709
KTB484	SK-1660
KTB484	SK-1710
KTB485	SK-1383

DAYCO

KTB486	SK-1668
KTB487	SK-1337
KTB488	SK-1108
KTB489	SK-1526
KTB490	SK-1380
KTB492	SK-1614
KTB493	SK-1424
KTB494	SK-1686
KTB495	SK-1598
KTB496	SK-1644
KTB497	SK-1706
KTB500	SK-1671
KTB501	SK-1223
KTB503	SK-1627
KTB506	SK-1626
KTB507	SK-1436
KTB509	SK-1628
KTB513	SK-1676
KTB515	SK-1273
KTB517	SK-1630
KTB519	SK-1490
KTB520	SK-1325
KTB521	SK-1322
KTB526	SK-1519
KTB527	SK-1589
KTB528	SK-1713
KTB529	SK-1721
KTB531	SK-1481
KTB532	SK-1487
KTB533	SK-1597
KTB534	SK-1085
KTB536	SK-1492
KTB537	SK-1674
KTB538	SK-1690
KTB539	SK-1407
KTB540	SK-1555
KTB541	SK-1250
KTB543	SK-1316
KTB544	SK-1636
KTB546	SK-1360
KTB547	SK-1460
KTB549	SK-1604
KTB551	SK-1719
KTB552	SK-1618
KTB552	SK-1747
KTB553	SK-1712
KTB555	SK-1595
KTB559	SK-1273
KTB560	SK-1483
KTB562	SK-1607

DAYCO

KTB563	SK-1694
KTB564	SK-1111
KTB565	SK-1533
KTB566	SK-1439
KTB567	SK-1725
KTB569	SK-1754
KTB571	SK-1489
KTB572	SK-1529
KTB576	SK-1424
KTB583	SK-1632
KTB584	SK-1667
KTB590	SK-1617
KTB591	SK-1600
KTB592	SK-1608
KTB595	SK-1608
KTB596	SK-1450
KTB597	SK-1470
KTB598	SK-1320
KTB599	SK-1656
KTB600	SK-1634
KTB605	SK-1666
KTB609	SK-1621
KTB614	SK-1724
KTB636	SK-1458
KTB641	SK-1658
KTB654	SK-1449
KTB659	SK-1748
KTB665	SK-1440
KTB682	SK-1476
KTB684	SK-1285
KTB690	SK-1386
KTB695	SK-1635
KTB713	SK-1716
KTB715	SK-1692
KTB730	SK-1724
KTB745	SK-1755
KTB759	SK-1586
KTB761	SK-1693
KTB762	SK-1674
KTB763	SK-1678
KTB763	SK-1741
KTB765	SK-1501
KTB768	SK-1552
KTB775	SK-1675
KTB777	SK-1080
KTB780	SK-1590
KTB781	SK-1502
KTB783	SK-1698
KTB784	SK-1661
KTB785	SK-1590

DAYCO

KT B786	SK-1444
KT B787	SK-1661
KT B788	SK-1727
KT B791	SK-1687
KT B816	SK-1739
KT B818	SK-1696
KT B820	SK-1732
KT B827	SK-1700
KT B838	SK-1753
KT B844	SK-1740
KT B848	SK-1652
KT B857	SK-1732
KT B947	SK-1750
KT B959	SK-1728
KT B965	SK-1717
KT B966	SK-1654
KT B967	SK-1714
KT B968	SK-1737
KT B969	SK-1736
KT B974	SK-1751
KT B975	SK-1726
KT BWP1010	SK-1003AQ1
KT BWP1050	SK-1007AQ1
KT BWP1060	SK-1021AQ2
KT BWP1062	SK-1021AQ1
KT BWP1130	SK-1020AQ1
KT BWP1151	SK-1022AQ2
KT BWP1190	SK-1017AQ1
KT BWP142B2	SK-1042AQ1
KT BWP1651	SK-1082AQ2
KT BWP1652	SK-1082AQ1
KT BWP1660	SK-1053AQ1
KT BWP1680	SK-1038AQ1
KT BWP1740	SK-1081AQ2
KT BWP1741	SK-1081AQ3
KT BWP1840	SK-1665AQ2
KT BWP1850	SK-1103AQ1
KT BWP1960	SK-1086AQ1
KT BWP1970	SK-1085AQ1
KT BWP1990	SK-1646AQ1
KT BWP2030	SK-1126AQ1
KT BWP2050	SK-1129AQ1
KT BWP2140	SK-1037AQ1
KT BWP2210	SK-1162AQ1
KT BWP2215	SK-1162AQ3
KT BWP2500	SK-1078AQ2
KT BWP2502	SK-1078AQ1
KT BWP2520	SK-1073AQ1
KT BWP2523	SK-1073AQ2
KT BWP2530	SK-1109AQ1

DAYCO

KT BWP2540	SK-1169AQ1
KT BWP2550	SK-1131AQ1
KT BWP2551	SK-1131AQ2
KT BWP2560	SK-1074AQ1
KT BWP2570	SK-1100AQ1
KT BWP2590	SK-1338AQ1
KT BWP2591	SK-1338AQ2
KT BWP2880	SK-1399AQ1
KT BWP2910	SK-1418AQ1
KT BWP2920	SK-1421AQ1
KT BWP2930	SK-1394AQ1
KT BWP2960	SK-1372AQ1
KT BWP2961	SK-1372AQ2
KT BWP2961	SK-1372AQ3
KT BWP2962	SK-1372AQ2
KT BWP2963	SK-1372AQ2
KT BWP2964	SK-1372AQ1
KT BWP3080	SK-1113AQ1
KT BWP3081	SK-1113AQ2
KT BWP3081	SK-1355AQ1
KT BWP3100	SK-1391AQ1
KT BWP3140	SK-1410AQ1
KT BWP3160	SK-1491AQ1
KT BWP3170	SK-1629AQ1
KT BWP3180	SK-1112AQ1
KT BWP3190	SK-1534AQ1
KT BWP3210	SK-1486AQ1
KT BWP3220	SK-1487AQ1
KT BWP3270	SK-1660AQ1
KT BWP3290	SK-1361AQ1
KT BWP3320	SK-1609AQ1
KT BWP3330	SK-1392AQ1
KT BWP3340	SK-1367AQ1
KT BWP3350	SK-1642AQ1
KT BWP3390	SK-1610AQ1
KT BWP3400	SK-1603AQ1
KT BWP3411	SK-1592AQ1
KT BWP3420	SK-1582AQ2
KT BWP3423	SK-1582AQ1
KT BWP3550	SK-1344AQ1
KT BWP3601	SK-1259AQ1
KT BWP3602	SK-1259AQ1
KT BWP3610	SK-1355AQ2
KT BWP3611	SK-1355AQ3
KT BWP3620	SK-1624AQ1
KT BWP3670	SK-1621AQ1
KT BWP3680	SK-1377AQ1
KT BWP3800	SK-1343AQ1
KT BWP3860	SK-1621AQ1
KT BWP3911	SK-1288AQ1

DAYCO

KT BWP3920	SK-1277AQ1
KT BWP3921	SK-1277AQ2
KT BWP3950	SK-1621AQ1
KT BWP4120	SK-1478AQ1
KT BWP4150	SK-1583AQ2
KT BWP4160	SK-1378AQ1
KT BWP4170	SK-1615AQ1
KT BWP4260	SK-1270AQ1
KT BWP4291	SK-1259AQ1
KT BWP4320	SK-1183AQ1
KT BWP4410	SK-1595AQ1
KT BWP4420	SK-1388AQ1
KT BWP4490	SK-1587AQ1
KT BWP4540	SK-1621AQ1
KT BWP4550	SK-1594AQ1
KT BWP4570	SK-1602AQ1
KT BWP4580	SK-1696AQ1
KT BWP4590	SK-1586AQ1
KT BWP4600	SK-1088AQ1
KT BWP4650	SK-1493AQ1
KT BWP4670	SK-1580AQ1
KT BWP4710	SK-1685AQ1
KT BWP4720	SK-1621AQ1
KT BWP4760	SK-1487AQ2
KT BWP4850	SK-1377AQ1
KT BWP4860	SK-1668AQ1
KT BWP4920	SK-1614AQ1
KT BWP4930	SK-1424AQ1
KT BWP4940	SK-1686AQ1
KT BWP4950	SK-1598AQ1
KT BWP4960	SK-1644AQ1
KT BWP4970	SK-1706AQ1
KT BWP5000	SK-1671AQ1
KT BWP5070	SK-1436AQ1
KT BWP5130	SK-1676AQ1
KT BWP5170	SK-1630AQ1
KT BWP5270	SK-1589AQ2
KT BWP5320	SK-1487AQ2
KT BWP5321	SK-1487AQ1
KT BWP5322	SK-1487AQ3
KT BWP5340	SK-1085AQ1
KT BWP5370	SK-1674AQ1
KT BWP5430	SK-1316AQ1
KT BWP5490	SK-1604AQ1
KT BWP5491	SK-1604AQ1
KT BWP5531	SK-1712AQ3
KT BWP5590	SK-1273AQ2
KT BWP5600	SK-1483AQ1
KT BWP5630	SK-1694AQ1
KT BWP5630	SK-1694AQ2

DAYCO

KT BWP5840	SK-1667AQ1
KT BWP5900	SK-1617AQ1
KT BWP6140	SK-1724AQ2
KT BWP6360	SK-1458AQ1
KT BWP6950	SK-1635AQ1
KT BWP7150	SK-1692AQ1
KT BWP7450	SK-1755AQ1
KT BWP7590	SK-1586AQ1
KT BWP7610	SK-1693AQ1
KT BWP7800	SK-1590AQ1
KT BWP8200	SK-1732AQ1
KT BWP8470	SK-1586AQ1
KT BWP9490	SK-1727AQ2
KT BWP9590	SK-1728AQ1
KT BWP9610	SK-1678AQ1
KT BWP9650	SK-1717AQ2
KT BWP9660	SK-1654AQ1
KT BWP9670	SK-1714AQ1
KT BWP9750	SK-1726AQ1
KT BWP9751	SK-1726AQ2

FEBI

01231	0-N1417
01237	0-N1439
01310	0-N1043
01315	0-N837
01389	0-N902
01390	0-N874
01391	0-N903
01392	0-N904
01406	0-N096
01443	0-N1280
01508	0-N941
01579	0-N1303
01588	0-N925
01790	0-N1305
01966	0-N1306
02248	0-N847
02249	0-N846
02558	0-N807
02560	0-N866
02561	0-N867
02889	0-N922
03241	0-N860
03370	0-N954
03600	0-N808
03673	0-N1297
03773	0-N1296
03801	0-N1758
03856	0-N906
03858	0-N907



FEBI		FEBI		FEBI		FEBI	
03872	0-N909	05077	0-N095	07057	0-N156	10294	0-N104
03879	0-N876	05082	0-N1751	07077	0-N923	10295	0-N106
03906	0-N163	05100	0-N1899	07078	0-N128	10296	0-N102
03921	0-N877	05220	0-N1278	07297	0-N1243	10297	0-N100
03923	0-N1230	05226	0-N875	07708	0-N921	10298	0-N115
03987	0-N1229	05338	0-N822	07709	0-N924	10299	0-N113
04001	0-N1703	05341	0-N815	07710	0-N940	10312	0-N2140
04127	0-N1311	05344	0-N1222	07968	0-N985	10612	0-N021
04131	0-N1414	05478	0-N1288	08109	0-N1951	10613	0-N029
04132	0-N2347	05613	0-N839	08467	0-N894	10614	0-N028
04134	0-N1312	05760	0-N2145	08502	0-N891	10615	0-N927
04165	0-N162	05801	0-N1320	08592	0-N897	10621	0-N179
04169	0-N883	05859	0-N887	08596	0-N898	10623	0-N014
04193	0-N856	05892	0-N881	08641	0-N826	10648	0-N950
04195	0-N854	05897	0-N863	08672	0-N818	10649	0-N938
04199	0-N173	05906	0-N880	08685	0-N816	10661	0-N951
04208	0-N960	05908	0-N882	08690	0-N1295	10760	0-N1304
04215	0-N1231	05928	0-N1753	08690	0-N1295S	10781	0-N1291
04216	0-N930	05933	0-N139	08692	0-N952	10781	0-N1291S
04217	0-N959	06050	0-N1298	08697	0-N953	10801	SK-1121
04218	0-N172	06051	0-N1301	08744	0-N2409	10967	SK-1450
04279	0-N920	06070	0-N842	08778	0-N2146	10987	SK-1067
04282	0-N958	06139	0-N1214	08779	0-N2147	11025	SK-1059
04283	0-N958	06146	0-N197	09613	0-N160	11026	SK-1060
04427	0-N955	06296	0-N1779	09614	0-N2000	11030	SK-1064
04556	0-N859	06298	0-N1862	09762	0-N132	11037	SK-1056
04723	0-N849	06305	0-N838	09778	0-N2181	11041	SK-1163
04725	0-N133	06343	0-N1864	09779	0-N823	11048	SK-1027
04730	0-N2153	06346	0-N1861	09780	0-N1256	11049	SK-1053
04732	0-N124	06384	0-N1625	09781	0-N1730	11050	SK-1039
04733	0-N931	06384	0-N1625S	09782	0-N1442	11058	SK-1052
04739	0-N2152	06385	0-N1011	09785	0-N1752	11061	SK-1098
04749	0-N945	06385	0-N1011S	09786	0-N1590	11066	SK-1657
04750	0-N814	06418	0-N1013	09788	0-N965	11068	SK-1142
04751	0-N901	06418	0-N1013S	09789	0-N1589	11071	SK-1023
04804	0-N943	06569	0-N1926	09790	0-N149	11071	SK-1665
04834	0-N911	06597	0-N2144	09791	0-N1472	11072	SK-1031
04856	0-N861	06687	0-N806	09791	0-N1472S	11076	SK-1043
04858	0-N870	06688	0-N805	09792	0-N121	11077	SK-1138
04865	0-N869	06880	0-N809	09793	0-N1722	11082	SK-1076
04880	0-N811	06971	0-N948	09794	0-N1713	11083	SK-1361
04925	0-N812	06980	0-N871	09810	0-N1290	11083	SK-1410
04926	0-N813	06981	0-N811	09810	0-N1290S	11084	SK-1411
04927	0-N944	06982	0-N862	10045	0-N166	11087	SK-1345
04968	0-N1974	06983	0-N900	10046	0-N165	11102	SK-1037
04987	0-N1293	07007	0-N277	10117	0-N1279	11106	SK-1017
05015	0-N1973	07008	0-N964	10132	0-N915	11122	0-N122
05069	0-N1749	07021	0-N1833	10172	0-N1860	11131	SK-1036
05069	0-N1749S	07022	0-N131	10243	0-N879	11135	SK-1063
05072	0-N1289	07047	0-N155	10293	0-N103	11141	SK-1015

FEBI		FEBI		FEBI		FEBI	
11144	SK-1089	11321	0-N127	14109	SK-1165	14658	SK-1261
11144	SK-1171	11322	0-N168	14111	SK-1038	14662	SK-1101
11147	SK-1013	11323	0-N1005	14113	SK-1169	14714	0-N1041
11147	SK-1108	11324	0-N1315	14115	SK-1162	14714	0-N1041S
11147	SK-1108S	11325	0-N159	14239	0-N007	14730	0-N1445
11149	SK-1012	11329	0-N1300	14241	0-N005	14730	0-N1445S
11151	SK-1011	11329	0-N1300S	14257	0-N006	14732	0-N116
11157	SK-1021	11330	0-N2410	14259	0-N032	14734	0-N117
11162	SK-1093	11331	0-N1299	14263	0-N997	14736	0-N1660
11170	SK-1018S	11331	0-N1299S	14267	0-N988	14893	0-N1406
11172	SK-1157	11332	0-N1787	14269	0-N018	14937	SK-1270
11174	SK-1005	11334	0-N1292	14271	0-N995	14938	0-N1286
11196	SK-1158	11335	0-N1585	14273	0-N989	14939	0-N1287
11208	SK-1034	11335	0-N1585S	14277	0-N008	14946	0-N1284
11214	SK-1040	11339	0-N1262	14355	0-N928	14947	0-N1285
11216	SK-1016	11340	0-N167	14357	0-N905	14968	0-N094
11218	SK-1003	11341	0-N1317	14369	0-N031	14996	0-N1932
11221	SK-1007	11341	0-N1317S	14373	0-N1485	15002	0-N1748
11222	SK-1022	11342	0-N1600	14373	0-N1485S	1508	0-N941
11227	SK-1006	11343	0-N2345	14373	0-N2169	15175	0-N1260
11230	SK-1020	11346	0-N215	14375	0-N1437	15176	0-N295
11242	SK-1004	11347	0-N214	14377	0-N1529	15177	0-N291
11243	SK-1159	11348	0-N1681	14379	0-N143	15178	0-N2131
11244	SK-1019	11349	0-N1968	14381	0-N137	15179	0-N1560
11250	0-N910	11355	0-N135	14397	0-N2180	15189	SK-1105
11270	0-N1800	11356	0-N145	14531	SK-1061	15277	0-N053
11274	0-N158	11388	0-N290	14542	0-N938	15279	0-N061
11275	0-N1641	11551	0-N089	14543	0-N937	15461	0-N034
11275	0-N1641S	11552	0-N114	14545	0-N1282	15463	0-N035
11276	0-N1431	11554	0-N101	14546	0-N1322	15491	0-N1362
11286	SK-1077	11556	0-N111	14546	0-N1322S	15492	0-N1350
11287	0-N293	11557	0-N105	14574	SK-1026	15594	0-N971
11289	0-N292	11559	0-N109	14574	SK-1090	15736	SK-1265
11291	0-N294	11560	0-N108	14600	SK-1001	15837	0-N1248
11292	0-N123	11561	0-N110	14602	SK-1029	15875	0-N1645
11294	0-N187	11604	0-N112	14604	SK-1124	15875	0-N1645S
11295	0-N1596	11640	0-N1904	14606	SK-1047	15878	0-N157
11296	0-N819	11640	0-N1975	14608	SK-1131	15888	0-N1263
11297	0-N820	11641	0-N1750	14610	SK-1344	17063	0-N118P
11298	0-N889	11669	SK-1079	14612	SK-1104	17064	0-N119P
11299	0-N835	11945	0-N208	14612	SK-1123	17065	0-N1949
11300	0-N832	11949	0-N1281	14618	SK-1120	17074	0-N1432S
11301	0-N800	12110	0-N952	14620	SK-1069	17076	0-N2001
11302	0-N801	12286	0-N1586	14622	SK-1119	17430	0-N2141
11308	SK-1065	12343	0-N1966	14626	SK-1098	17460	0-N970
11310	0-N236	12432	0-N126	14630	SK-1122	17478	SK-1100
11311	0-N237	12518	0-N1640	14640	SK-1343	17480	SK-1113
11312	SK-1102	12518	0-N1640S	14640	SK-1376	17481	0-N956
11314	0-N1273	1315	0-N837	14642	SK-1343	17482	0-N957
11316	0-N129	1390	0-N985	14646	SK-1126	17491	0-N073



FEBI		FEBI		FEBI		FEBI	
17492	0-N069	18937	0-N978	19657	SK-1421	21549	SK-1096
17493	0-N983	18944	0-N1464	19658	SK-1418	21627	0-N1349
17494	0-N070	18944	0-N1464S	19732	0-N1232	21628	0-N1450
17510	0-N2142	18956	0-N107	19734	0-N1308	21629	0-N1507
17541	0-N1407	19001	0-N1283	19736	0-N1822	21629	0-N1507S
17541	0-N1407S	19066	0-N912	19736	0-N1822S	21630	0-N1512
17542	0-N1484	19072	0-N1747	19749	0-N1418	21630	0-N1512S
17542	0-N1484S	19119	0-N1493	19824	0-N1435	21652	0-N1085
17544	0-N1405	19119	0-N1493S	19824	0-N1435S	21653	0-N878
17545	0-N926	19189	0-N1065	19845	0-N1259	21690	0-N1538
17600	0-N1403	19190	0-N1058	19846	0-N200	21690	0-N1538S
17601	0-N1628	19214	0-N1545	19847	0-N262	21706	0-N1045
17604	0-N025	19239	0-N170	19851	0-N1112	21707	0-N1721
17606	0-N030	19240	0-N171	19852	SK-1486	21708	0-N1046
17621	0-N183	19247	0-N1726	19856	0-N1446	21709	0-N1314
17624	0-N986	19283	0-N974	19871	0-N1450	21710	0-N2047
17629	0-N072	19292	0-N1316	19910	0-N198	21717	0-N146
17674	0-N1401	19325	0-N1057	19918	SK-1088	21720	SK-1258
17677	0-N1452	19354	0-N1402	19931	0-N147	21720	SK-1259
17712	0-N1268	19354	0-N1402S	19951	SK-1494	21722	0-N1274
17726	0-N174	19355	0-N1486	19995	0-N1951	21724	SK-1372
17767	0-N194	19355	0-N1486S	21025	0-N1270	21725	SK-1338
17769	0-N195	19356	0-N1391	21029	0-N1269	21726	SK-1583
17770	0-N196	19356	0-N1391S	21031	0-N1106	21746	0-N1494
17942	0-N1266	19357	0-N1416	21033	0-N1307	21746	0-N1494S
17944	0-N1048	19391	0-N1421	21060	0-N1466	21759	0-N1365
17946	0-N201	19404	0-N1276	21060	0-N1466S	21759	0-N2380
17948	0-N1654	19445	SK-1355	21061	0-N1588	21764	0-N1258
17950	0-N1265	19462	0-N074	21061	0-N1588S	21766	0-N164
17955	0-N968	19471	0-N148	21094	0-N2170	21771	0-N1497
17956	0-N892	19481	0-N126	21094	0-N2170S	21771	0-N1497S
17974	0-N1857	19482	0-N1471	21098	SK-1073	21772	SK-1511
17974	0-N1857S	19482	0-N1471S	21099	0-N1085	21779	0-N1433
18018	0-N1382	19483	0-N1386	21207	0-N1434	21786	0-N056
18181	0-N300	19485	0-N1544	21236	SK-1106	21787	0-N055
18233	0-N999	19486	0-N1544	21248	0-N1309	21797	0-N1903
18235	0-N992	19487	0-N1438	21249	SK-1081	21797	0-N1903S
18237	0-N178	19487	0-N1438S	21268	0-N1277	21803	0-N1897
18483	0-N2135	19488	0-N1408	21269	0-N1111	21803	0-N1897S
18485	0-N1511	19511	0-N1062	21270	SK-1487	21851	0-N1425
18489	0-N1061	19513	0-N1066	21274	SK-1354	21867	SK-1391
18554	0-N1050	19539	0-N1668	21280	SK-1353	21878	0-N1351
18556	0-N1042	19539	0-N1668S	21296	0-N1669	21900	0-N1361
18562	0-N1238	19548	SK-1337	21296	0-N1669S	21902	SK-1351
18574	0-N176	19552	SK-1111	21300	0-N1396	21905	0-N1083
18658	0-N1236	19554	SK-1425	21301	0-N1592	21989	SK-1631
18660	0-N1441	19570	0-N1332	21307	0-N1470	22055	0-N1173
18660	0-N1441S	19615	SK-1086	21307	0-N1470S	22056	SK-1493
18662	0-N1969	19621	SK-1394	21309	0-N152	22119	0-N1409
18664	0-N168	19623	SK-1085	21309	0-N152S	22143	0-N2223

FEBI		FEBI		FEBI		FEBI	
22152	0-N1518	22779	0-N1636S	23780	0-N1723	24791	SK-1626
22152	0-N1518S	22792	0-N903	23781	0-N1388	24817	SK-1277
22277	0-N1736	22843	0-N1760	24178	0-N1395	24818	SK-1436
22281	0-N1474	22844	0-N1376	24188	0-N1341	24819	SK-1070
22303	0-N1501	22845	0-N1550	24328	0-N1953	24823	SK-1068S
22303	0-N1501S	22855	0-N1469	24328	0-N1953S	24823	SK-1097
22309	SK-1482	22887	0-N1400	24369	SK-1424	24836	0-N1379
22327	SK-1392	22887	0-N1400S	24407	0-N1392	24837	0-N1578
22329	0-N1611	22900	0-N1572	24409	0-N1428	24851	0-N1342
22329	0-N1611S	23045	SK-1489	24501	0-N1355	24853	SK-1539
22339	0-N1363	23126	SK-1121	24503	0-N1354	24854	0-N1825
22343	0-N1978	23134	0-N130	24529	0-N1323	24855	0-N1816
22343	0-N1978S	23165	0-N1922	24529	0-N2060	24883	SK-1062
22346	0-N1237	23207	SK-1725	24541	0-N1488	25103	0-N1246
22347	0-N1051	23251	0-N1756	24541	0-N1488S	25195	0-N071
22347	0-N1051S	23255	0-N013	24543	0-N1366	2558	0-N807
22348	0-N1054	23283	0-N1329	24544	0-N1561	2560	0-N866
22349	0-N1420	23285	0-N1328	24547	0-N975	2561	0-N867
22351	0-N1413	23290	SK-1377	24551	0-N1370	26027	0-N1327
22352	0-N1569	23292	SK-1383	24553	0-N1577	26033	0-N1049
22354	0-N1568	23413	SK-1479	24606	0-N1340	26051	0-N1374
22355	0-N1419	23415	SK-1481	24608	SK-1599	26052	SK-1656
22356	0-N1275	23423	SK-1478	24618	0-N1458	26052	SK-1684
22357	0-N1053	23427	SK-1644	24629	0-N1773	26075	SK-1066
22358	0-N1371	23429	0-N1383	24630	0-N1618	26076	SK-1220
22363	0-N2127	23437	SK-1612	24639	0-N1792	26114 + 26184	SK-1306
22364	0-N1657	23449	SK-1184	24653	0-N1606	26117	SK-1341
22364	0-N1657S	23457	SK-1273	24653	0-N1606S	26136	SK-1288
22366	0-N1740	23530	SK-1635	24684	SK-1593	26139	SK-1399
22369	0-N1339	23556	0-N1459	24688	0-N1444	26145	SK-1087
22369	0-N1339S	23556	0-N1459S	24690	SK-1529	26147	SK-1415
22370	0-N2170	23558	0-N1539	24706	SK-1582	26168	0-N1052
22370	0-N2170S	23558	0-N1539S	24708	SK-1388	26184	SK-1236
22376	0-N1517	23601	0-N076	24715	0-N2320	26197	0-N1375
22376	0-N1517S	23627	0-N077	24723	SK-1346	26217	0-N1225
22377	SK-1412	23634	SK-1109	24730	0-N1457	26218	0-N1767
22391	0-N1741	23640	SK-1074	24734	SK-1511	26219	0-N1226
22391	0-N1741S	23644	SK-1592	24740	SK-1619	26223	0-N1369
22392	0-N1487	23650	0-N1791	24751	0-N978	26224	SK-1632
22392	0-N1487S	23650	0-N1791S	24752	0-N1335	26451	0-N1650
22404	0-N1404	23651	SK-1602	24754	0-N1336	26567	SK-1624
22405	0-N1594	23654	0-N1326	24755	SK-1640	26569	0-N1671
22407	0-N1456	23654	0-N2149	24756	SK-1595	26569	0-N1671S
22723	SK-1172	23655	SK-1629	24764	SK-1599	26603	0-N1582
22733	SK-1491	23655	SK-1696	24765	0-N1385	26604	0-N1581
22737	SK-1618	23758	0-N1432	24772	SK-1188	26605	0-N1373
22744	0-N1453	23772	0-N1510	24787	SK-1196	26623	0-N1579
22776	0-N1587	23772	0-N1510S	24788	SK-1192	26624	0-N1580
22776	0-N1587S	23773	0-N1680	24789	SK-1075	26679	0-N1558S
22779	0-N1636	23779	0-N1397	24790	SK-1186	26697	0-N075



FEBI		FEBI		FEBI		FEBI	
26715	0-N1359	27216	0-N1525S	27559	SK-1492	28296	0-N080
26716	0-N1360	27218	0-N1733	27560	0-N1506	28305	SK-1586
26717	SK-1615	27218	0-N1733S	27560	0-N1506S	28315	0-N186
26732	0-N092	27247	0-N1415	27561	0-N1527	28331	0-N1663
26733	0-N1576	27279	SK-1671	27561	0-N1527S	28331	0-N1663S
26734	0-N1948	27281	SK-1222	27563	0-N1449	28364	0-N1390
26735	0-N054	27283	SK-1221	27566	0-N1554	28364	0-N1390S
26738	0-N189	27296	SK-1375	27566	0-N1554S	28374	0-N1574
26740	0-N185	27296	SK-1633	27567	0-N2096	28375	SK-1667
26804	0-N1338	27302	SK-1621	27567	0-N2096S	28450	0-N878
26805	0-N1761	27354	0-N1719	27604	0-N1947	28451	SK-1481
26805	0-N993	27354	0-N1719S	27618	0-N1534	28544	0-N1884
26806	0-N994	27365	0-N1526	27618	0-N1534S	28545	SK-1747
26809	0-N000	27365	0-N1526S	27792	0-N1347	28589	SK-1608
26811	SK-1589	27367	0-N1913	27806	0-N1530	28590	0-N1498
26811	SK-1717	27367	0-N1913S	27806	0-N1530S	28602	SK-1623
26813	SK-1522	27372	0-N1523	27814	0-N1891	28602	SK-1624
26818	SK-1594	27374	0-N1505S	27818	0-N1799	28662	0-N1616
26849	0-N1879	27375	0-N1900	27818	0-N1799S	28664	SK-1677
26871	0-N1424	27375	0-N2072	27819	0-N1348	28687	0-N1492
26894	0-N1883	27376	0-N1357	27825	SK-1607	28687	0-N1492S
26894	0-N1883S	27377	0-N1358	27827	0-N1347	28708	0-N1788
26895	0-N2058	27381	0-N1961	28025	0-N1531	28708	0-N1788S
26897	0-N1250	27390	SK-1534	28025	0-N1531S	28709	0-N2130
26901	SK-1580	27391	SK-1614	28094	0-N1520	2889	0-N922
26902	SK-1275	27396	SK-1310	28094	0-N1610	29232	0-N1889
26904	SK-1231	27396	SK-1311	28103	SK-1483	29232	0-N1889S
26905	SK-1223	27396	SK-1323	28104	0-N1537	29271	SK-1617
26905	SK-1225	27396	SK-1469	28104	0-N1537S	29301	0-N1614
26928	0-N181	27398	SK-1320	28106	0-N1343	29345	0-N1575
26937	0-N1426	27408	SK-1325	28107	SK-1600	29389	0-N821
26951	0-N1448	27409	SK-1242	28149	0-N1670	29393	SK-1681
26955	0-N1516	27409	SK-1317	28149	0-N1670S	29396	0-N1522
26955	0-N1516S	27445	0-N1427	28225	0-N1436	29523	0-N1573
26982	0-N1377	27445	0-N1427S	28225	0-N1436S	29563	0-N1836
26991	0-N182	27445	0-N2405	28229	0-N2148	29770	0-N1710
26993	SK-1316	27445	0-N2405S	28234	0-N1746	29770	0-N1710S
26994	0-N1129	27454	0-N2143	28260	0-N1835	29945	0-N1704
27004	0-N1378	27517	0-N1665	28261	0-N2157	29945	0-N1704S
27017	0-N987	27527	0-N1902	28262	0-N1509	29952	0-N1564
27018	0-N059	27527	0-N1902S	28262	0-N1509S	30013	0-N1820
27019	0-N064	27535	SK-1322	28276	0-N1387	30026	0-N1851
27020	0-N052	27536	0-N1223	28277	0-N1651	30026	0-N1851S
27021	0-N060	27537	0-N1775	28277	0-N1651S	30027	0-N2103
27022	0-N063	27542	SK-1335	28279	0-N1473	30027	0-N2103S
27118	0-N192	27546	SK-1721	28279	0-N1473S	30050	SK-1245
27119	0-N191	27554	0-N1389	28283	0-N1549	30082	0-N2190
27120	0-N058	27557	0-N1462	28287	0-N1898	30082	0-N2190S
27123	0-N1127	27557	0-N1462S	28287	0-N1898S	30083	0-N2109
27216	0-N1525	27558	0-N1324	28295	0-N081	30083	0-N2109S

FEBI		FEBI		FEBI		FEBI	
30114	0-N1834	30781	SK-1110	31288	0-N1702	32727	SK-1598AQ1
30114	0-N1834S	30781	SK-1259	31310	0-N1330	32730	SK-1589AQ2
30117	0-N1923	30788	0-N1957	31359	0-N1979	32735	SK-1483AQ1
30119	0-N2129	30788	0-N1957S	31359	0-N1979S	32738	SK-1668AQ1
30120	0-N2128	30792	SK-1365	31382	0-N1744	32742	SK-1595AQ1
30121	0-N1794	30792	SK-1697	31383	0-N1972	32743	SK-1259AQ1
30121	0-N1794S	30797	0-N1622	31398	SK-1470	32744	SK-1258AQ1
30129	0-N1621	30799	0-N1533	31428	SK-1183	32745	SK-1412AQ2
30129	0-N1621S	30859	0-N1454	31471	0-N2186	32810	0-N1943
30130	0-N1786	30869	0-N1817	31480	0-N1852	32811	0-N1954
30131	0-N2124	30869	0-N1817S	31726	SK-1678	32811	0-N1954S
30131	0-N2124S	30873	0-N1942	31746	0-N1906	32813	SK-1491AQ1
30146	0-N1964	30890	0-N1567	31840	SK-1591	32814	SK-1109AQ1
30146	0-N1964S	30892	0-N1715	31850	SK-1590	32820	0-N1807
30159	0-N1664	30892	0-N2110	31960	SK-1590	32825	SK-1669AQ1
30159	0-N1664S	30893	0-N2134	31973	0-N1798	32826	SK-1654AQ1
30166	0-N1656	30894	0-N2414	31973	0-N1798S	32860	SK-1088AQ1
30166	0-N1656S	30895	0-N1967	32017	0-N1919	32891	SK-1288AQ1
30168	0-N1597	30897	0-N1908	32017	0-N1919S	33004	0-N2104
30170	0-N1714	30897	0-N1908S	32018	0-N1731	33004	0-N2104S
30170	0-N1714S	30906	0-N1626	32018	0-N1731S	33136	0-N2055
30178	0-N1483	30906	0-N1626S	32024	0-N2133	33136	0-N2055S
30178	0-N1483S	30918	0-N1925	32049	0-N1639	33152	0-N1955
30212	0-N1566	30923	0-N1795	32049	0-N1639S	33152	0-N1955S
30215	0-N1905	30976	SK-1609	32079	0-N1941	33153	0-N1918
30220	0-N1331	30980	0-N1352	32079	0-N1941S1	33153	0-N1918S
30221	0-N1337	30989	0-N1920	32079	0-N1941S2	33170	0-N1944
30222	0-N1830	30990	0-N1675	32079	0-N1941S3	33179	0-N1815
30222	0-N1830S	31051	SK-1598	32148	0-N1946	33179	0-N1815S
30227	0-N1346	31053	SK-1610	32148	0-N1946S1	33180	0-N1547
30248	0-N1743	31061	SK-1634	32148	0-N1946S2	33181	0-N1678
30260	0-N1965	31069	0-N1909	32175	0-N2029	33182	0-N1856
30289	0-N1431	31076	0-N1673	32175	0-N2029S	33182	0-N1856S
30291	0-N027	31076	0-N1673S	32248	0-N1793	33183	0-N1855
30440	0-N1958	31089	0-N1667	32248	0-N1793S	33183	0-N1855S
30440	0-N1958S	31090	0-N2139	32337	0-N1216	33184	0-N1551
30441	0-N1950	31142	0-N1667	32338	0-N1380	33184	0-N1551S
30454	0-N2138	31195	0-N1500	32397	0-N020	33185	0-N2416
30580	SK-1668	31196	0-N1499	32400	0-N1804	33186	0-N1619
30584	0-N1893	31214	0-N1532	32400	0-N1804S	33356	0-N2034
30584	0-N1893S	31214	0-N1532S	3241	0-N860	33356	0-N2034S
30585	0-N1892	31215	0-N2105	32427	SK-1585	33463	0-N2132
30585	0-N1892S	31215	0-N2105S	32447	0-N1984	3370	0-N954
30620	0-N1536	31236	0-N1871	32504	0-N2158	33716	0-N1676
30621	0-N1738	31255	0-N1850	32504	0-N2158S	33716	0-N1676S
30664	0-N1591	31255	0-N1850S	32577	0-N1819	33717	0-N1928
30686	0-N1662	31256	0-N1677	32717	SK-1162AQ1	33718	0-N1907
30733	0-N1503	31256	0-N1677S	32719	SK-1355AQ1	33827	SK-1355AQ3
30733	0-N1503S	31257	0-N1643	32720	SK-1183AQ1	33828	SK-1113AQ1
30779	SK-1526	31257	0-N1643S	32722	SK-1594AQ1	33880	0-N1963



FEBI		FEBI		FEBI		FEBI	
33947	0-N1797	34916	0-N2246S2	37270	0-N1945S	40327	0-N2092S
33947	0-N1797S	34916	0-N2246S3	37275	0-N2382	40440	0-N2296
33977	0-N1991	36020	0-N2018	37353	0-N2063	40466	0-N1620
34128	SK-1694	36021	0-N1356	37405	0-N115	40466	0-N1620S
34172	0-N2125	36057	0-N2199	37460	SK-1714	40814	SK-1743
34244	0-N1716	36084	0-N1915	37515	0-N2243	40848	SK-1659
34246	0-N1777	36203	0-N1832	37517	0-N2221	4164	0-N917
34312	0-N1499	36203	0-N1832S	37543	0-N2215	4165	0-N162
34467	0-N2064	36288	0-N1368	37543	0-N2215S	4169	0-N887
34468	0-N2065	36300	SK-1630	37551	0-N2212	4193	0-N856
34468	0-N2065S	36365	0-N1672	37551	0-N2212S	4208	0-N960
34469	0-N2075	36367	0-N1398	37552	0-N2216	4216	0-N930
34470	0-N2076	36399	0-N2227	37552	0-N2216S1	43484	SK-1720
34470	0-N2076S	36442	0-N1394	37552	0-N2216S2	43669	SK-1698
34471	0-N2031	36443	0-N1599	37605	0-N2062	43677	0-N2288
34471	0-N2031S	36443	0-N1599S	37642	SK-1660	43677	0-N2288S
34472	0-N2087	36488	0-N2082	37696	0-N2219	43685	0-N2276
34472	0-N2087S	36488	0-N2082S	37696	0-N2219S	43750	0-N2287
34475	0-N2067	36523	0-N2242	37697	0-N2136	43750	0-N2287S
34504	0-N2066	36523	0-N2242S	37697	0-N2136S	43784	0-N1830
34533	0-N2068	36636	0-N2084	37698	0-N2193	43784	0-N1830S
34534	0-N2069	36636	0-N2084S	37698	0-N2193S	43787	0-N2289
34536	0-N2070	36660	0-N1874	37699	0-N2218	43787	0-N2289S
34537	0-N2071	36660	0-N1874S	37702	0-N2119	44980	0-N2290
34538	0-N2073	36692	0-N2050	37703	0-N2120	44980	0-N2290S
34540	0-N2077	36693	0-N2111	37979	0-N2351	45036	0-N2291
34541	0-N2078	36693	0-N2111S	38465	0-N2309	45108	SK-1394AQ1
34542	0-N2079	36694	0-N2091	38465	0-N2309S	45117	SK-1694AQ2
34543	0-N2080	36694	0-N2091S	38467	0-N2422	45126	SK-1582AQ1
34544	0-N2090	36826	0-N1739	38467	0-N2422S	45147	0-N1534
34591	0-N1646	36831	0-N2039	38469	0-N2086	45147	0-N1534S
34606	0-N2113	36831	0-N2039S	38469	0-N2086S	45175	SK-1692AQ1
34606	0-N2113S	36859	0-N2042	38620	0-N2205	45365	0-N2293
34610	0-N1936	36859	0-N2042S	38654	0-N2195	45365	0-N2293S
34611	0-N2052	36867	0-N2019	38655	0-N2208	45553	0-N2306
34619	0-N1649	36893	0-N2061	3879	0-N876	45553	0-N2306S
34627	SK-1078AQ1	36933	0-N2206	39101	0-N2224	45554	0-N2307
34632	SK-1007AQ1	36934	0-N2245	39200	SK-1732	45554	0-N2307S
34635	SK-1003AQ1	36934	0-N2245S1	39203	SK-1728	45793	0-N2381
34640	SK-1022AQ2	36934	0-N2245S2	3921	0-N877	45795	0-N2313
34641	SK-1021AQ1	36934	0-N2245S3	3923	0-N1230	4723	0-N849
34642	SK-1040AQ1	36982	0-N2121	39390	0-N2268	4732	0-N124
34644	0-N2012	37019	0-N2200	39390	0-N2268S	4834	0-N911
34645	0-N2161	37021	SK-1727	39400	0-N2392	4858	0-N870
34645	0-N2161S	37154	0-N1875	39400	0-N2392S	4865	0-N869
34783	0-N2025	37154	0-N1875S	3987	0-N1229	4925	0-N812
34805	0-N1808	37255	0-N2038	39930	0-N2269	5077	0-N095
34805	0-N1808S	37255	0-N2038S	39930	0-N2269S	5226	0-N875
34916	0-N2246	37268	0-N1924	40210	0-N2057	5341	0-N815
34916	0-N2246S1	37270	0-N1945	40327	0-N2092	5344	0-N1222

FEBI

5613	0-N839
5859	0-N883
5889	0-N913
5906	0-N880
5929	0-N138
6070	0-N842
6139	0-N1214
6146	0-N838
6880	0-N809
7077	0-N923
7708	0-N921
7709	0-N924
7710	0-N940
8502	0-N891
8579	0-N1239
8592	0-N897
8596	0-N899
8672	0-N818
CR 3453	0-N1282

GATES

K+15127XS-1	SK-1003
K+15127XS-2	SK-1003
K+15310XS	SK-1162
K+15454XS-1	SK-1081
K+15454XS-2	SK-1081
K+25049XS	SK-1022
K015016	SK-1026
K015020	SK-1061
K015027	SK-1275
K015028	SK-1202
K015030	SK-1023
K015030FI	SK-1023
K015030XS	SK-1665
K015035	SK-1129
K015036	SK-1317
K015039	SK-1657
K015040XS	SK-1093
K015043	SK-1650
K015048	SK-1056
K015049XS	SK-1007
K015050XS	SK-1006
K015051	SK-1015
K015054	SK-1018S
K015055XS	SK-1039
K015056	SK-1010
K015057XS	SK-1062
K015061XS	SK-1662
K015063	SK-1024
K015064	SK-1052
K0150640	SK-1052

GATES

K015068	SK-1160
K015075XS	SK-1309S
K015078	SK-1064
K015079	SK-1145S
K015080	SK-1264
K015082XS	SK-1216
K015085	SK-1232
K015086	SK-1219
K015103	SK-1449
K015105	SK-1203
K015110	SK-1321
K015111	SK-1445
K015113	SK-1045
K015117XS	SK-1197
K015118	SK-1189
K015120	SK-1249
K015122	SK-1248
K015124	SK-1185
K015127	SK-1176
K015127XS	SK-1003
K015129	SK-1037
K015130XS	SK-1011
K015175XS	SK-1004
K015176	SK-1001
K015177	SK-1031
K015178	SK-1032
K015179	SK-1141
K015180	SK-1033
K015182XS	SK-1130
K015183XS	SK-1047
K015186	SK-1065
K015192XS	SK-1021
K015193XS	SK-1054
K015194XS	SK-1187
K015197XS	SK-1188
K015202XS	SK-1186
K015205	SK-1163
K015206	SK-1157
K015207	SK-1005
K015208XS	SK-1217
K015210	SK-1236
K015212	SK-1012
K015212XS	SK-1705
K015213XS	SK-1223
K015214XS	SK-1522
K015215XS	SK-1159
K015222	SK-1236
K015223XS	SK-1029
K015225XS	SK-1027
K015228XS	SK-1308

GATES

K015232XS	SK-1066
K015233XS	SK-1211
K015234XS	SK-1220
K015237XS	SK-1213
K015238XS	SK-1067
K015240XS	SK-1563
K015241	SK-1335
K015244XS	SK-1089
K015245	SK-1126
K015248XS	SK-1016
K015249XS	SK-1017
K015250XS	SK-1242
K015252XS	SK-1041
K015254XS	SK-1237
K015255XS	SK-1555
K015256XS	SK-1312
K015257XS	SK-1649
K015257XS BS ONLY	SK-1310
K015258XS	SK-1310
K015262XS	SK-1407
K015263XS	SK-1257
K015264XS	SK-1226
K015268	SK-1250
K015270XS	SK-1195
K015273XS	SK-1224
K015274XS	SK-1225
K015279XS	SK-1050
K015281	SK-1142
K015283XS	SK-1234
K015284XS	SK-1566
K015287XS	SK-1231
K015288	SK-1207
K0152880	SK-1207
K015299	SK-1144
K015300XS	SK-1302
K015302XS	SK-1059
K015304	SK-1150
K015305	SK-1013
K015305XS	SK-1013
K015306	SK-1260
K015307	SK-1453
K015308	SK-1120
K015309XS	SK-1068S
K015310XS	SK-1162
K015312	SK-1072
K015317XS	SK-1227
K015318XS	SK-1245
K015319	SK-1286
K015320XS	SK-1210
K015322	SK-1140

GATES

K015323XS	SK-1526
K015334XS	SK-1035
K015335XS	SK-1046
K015336	SK-1546S
K015338XS	SK-1049
K015341XS	SK-1221
K015343XS	SK-1174
K015344XS	SK-1343
K015346XS	SK-1570
K015347XS	SK-1020
K015348XS	SK-1070
K015349XS	SK-1218
K015350XS	SK-1314
K015352XS	SK-1322
K015354XS	SK-1228
K015356XS	SK-1222
K015357XS	SK-1053
K015358XS	SK-1196
K015360XS	SK-1094
K015363XS	SK-1205
K015367XS	SK-1169
K015368XS	SK-1038
K015369XS	SK-1073
K015370XS	SK-1036
K015371XS	SK-1172
K015372XS	SK-1311
K015373XS	SK-1323
K015375XS	SK-1463
K015378XS	SK-1103
K015379XS	SK-1457
K015382XS	SK-1564
K015386XS	SK-1075
K015388XS	SK-1274
K015389XS	SK-1190
K015391XS	SK-1095
K015391XS	SK-1645
K015393XS	SK-1519
K015396XS	SK-1573
K015397XS	SK-1270
K015398XS	SK-1527
K015399XS	SK-1123
K015402XS	SK-1278
K015403XS	SK-1192
K015405XS	SK-1521
K015406	SK-1154
K015408XS	SK-1100
K015409XS	SK-1288
K015410XS	SK-1277
K015411XS	SK-1043
K015412XS	SK-1158



GATES

K015413XS	SK-1079
K015416XS	SK-1507
K015418XS	SK-1040
K015419XS	SK-1273
K015420XS	SK-1034
K015421XS	SK-1233
K015423XS	SK-1411
K015424XS	SK-1090
K015426	SK-1344
K015427XS	SK-1131
K015428XS	SK-1074
K015429XS	SK-1361
K015431XS	SK-1345
K015432XS	SK-1076
K015433XS	SK-1105
K015434XS	SK-1183
K015435XS	SK-1096
K015441XS	SK-1458
K015445XS	SK-1316
K015449	SK-1184
K0154490	SK-1184
K015451XS	SK-1042
K015453XS	SK-1508
K015454XS	SK-1081
K015457XS	SK-1656
K015460XS	SK-1265
K015461XS	SK-1166
K015462XS	SK-1646
K015465XS	SK-1102
K015467XS	SK-1450
K015468XS	SK-1399
K015469XS	SK-1415
K015470XS	SK-1475
K015471XS	SK-1087
K015472XS	SK-1365
K015473XS	SK-1338
K015474XS	SK-1752
K015478XS	SK-1750
K015479XS	SK-1634
K015480XS	SK-1430
K015481XS	SK-1469
K015483XS	SK-1476
K015484XS	SK-1108S
K015485	SK-1107
K015485XS	SK-1707
K015486XS	SK-1114
K015487XS	SK-1444
K015489XS	SK-1109
K015490XS	SK-1635
K015491XS	SK-1337

GATES

K015492XS	SK-1346
K015493XS	SK-1636
K015495XS	SK-1153
K015497XS	SK-1504
K015499XS	SK-1113
K015500XS	SK-1112
K015501XS	SK-1088
K015503XS	SK-1412
K015505XS	SK-1436
K015507XS	SK-1625
K015508XS	SK-1339
K015509XS	SK-1491
K015510XS	SK-1671
K015511XS	SK-1626
K015512XS	SK-1627
K015514XS	SK-1325
K015515XS	SK-1670
K015520XS	SK-1375
K015523XS	SK-1086
K015524XS	SK-1085
K015527XS	SK-1502
K015528XS	SK-1482
K015529XS	SK-1628
K015533XS	SK-1531
K015535XS	SK-1470
K015537XS	SK-1712
K015539	SK-1715
K015541XS	SK-1341
K015542XS	SK-1478
K015543XS	SK-1111
K015544XS	SK-1421
K015545XS	SK-1418
K015547XS	SK-1501
K015550XS	SK-1623
K015552XS	SK-1493
K015553XS	SK-1618
K015555XS	SK-1669
K015556XS	SK-1653
K015557XS	SK-1619
K015558XS	SK-1394
K015559XS	SK-1258
K015560XS	SK-1713
K015561XS	SK-1620
K015562XS	SK-1589
K015563XS	SK-1481
K015564XS	SK-1512
K015565XS	SK-1585
K015567XS	SK-1652
K015568XS	SK-1439
K015569XS	SK-1582

GATES

K015571XS	SK-1049
K015572XS	SK-1351
K015573XS	SK-1489
K015574XS	SK-1353
K015575XS	SK-1354
K015577XS	SK-1486
K015578XS	SK-1487
K015579XS	SK-1654
K015580XS	SK-1608
K015581XS	SK-1392
K015582XS	SK-1393
K015583XS	SK-1716
K015586XS	SK-1673
K015587XS	SK-1391
K015588XS	SK-1534
K015589XS	SK-1577
K015590XS	SK-1609
K015591XS	SK-1690
K015592XS	SK-1610
K015593XS	SK-1590
K015594XS	SK-1611
K015595XS	SK-1612
K015596XS	SK-1674
K015598XS	SK-1424
K015599XS	SK-1613
K015600XS	SK-1602
K015601XS	SK-1603
K015602XS	SK-1483
K015603XS	SK-1607
K015605XS	SK-1538
K015606XS	SK-1594
K015607XS	SK-1595
K015608XS	SK-1596
K015609XS	SK-1744
K015610XS	SK-1580
K015611XS	SK-1718
K015612XS	SK-1719
K015614XS	SK-1597
K015615XS	SK-1598
K015616XS	SK-1599
K015622XS	SK-1425
K015623XS	SK-1586
K015624XS	SK-1675
K015626XS	SK-1676
K015627XS	SK-1677
K015630XS	SK-1678
K015631XS	SK-1691
K015633XS	SK-1588
K015634XS	SK-1723
K015636XS	SK-1739

GATES

K015637XS	SK-1738
K015641XS	SK-1736
K015643XS	SK-1735
K015645XS	SK-1734
K015646XS	SK-1693
K015648XS	SK-1694
K015649XS	SK-1695
K015650XS	SK-1696
K015653XS	SK-1697
K015654XS	SK-1698
K015655XS	SK-1733
K015656XS	SK-1728
K015657XS	SK-1732
K015661XS	SK-1686
K015662XS	SK-1704
K015671XS	SK-1088
K015672XS	SK-1714
K015675XS	SK-1730
K015676XS	SK-1729
K01T246	SK-1699
K01T257	SK-1289
K01T265	SK-1700
K01T271	SK-1702
K01T298	SK-1703
K02422	SK-1154
K025008	SK-1255
K025043	SK-1327
K025049XS	SK-1022
K025058XS	SK-1091
K025059XS	SK-1092
K025075XS	SK-1240
K025080	SK-1155
K025182XS	SK-1127
K025183XS	SK-1124
K025193XS	SK-1164
K025202XS	SK-1186
K025210	SK-1236
K025215XS	SK-1019
K025222	SK-1236
K025223XS	SK-1122
K025237XS	SK-1301
K025244XS	SK-1171
K025251XS	SK-1041
K025281	SK-1143
K0252810	SK-1143
K025283XS	SK-1320
K025302XS	SK-1060
K025308	SK-1119
K025323XS	SK-1578
K025334XS	SK-1680

GATES

K025335XS	SK-1679
K025344XS	SK-1376
K025346XS	SK-1360
K025349XS	SK-1218
K025368XS	SK-1165
K025370XS	SK-1099
K025378XS	SK-1103
K025382XS	SK-1757
K025391XS	SK-1095
K025398XS	SK-1527
K025399XS	SK-1104
K025405XS	SK-1682
K025416XS	SK-1706
K025418XS	SK-1642
K025420XS	SK-1683
K025424XS	SK-1101
K025427XS	SK-1592
K025429XS	SK-1446
K025433XS	SK-1077
K025434XS	SK-1460
K025435XS	SK-1306
K025451XS	SK-1042
K025455XS	SK-1106
K025457XS	SK-1684
K025460XS	SK-1643
K025461XS	SK-1644
K025462XS	SK-1080
K025467XS	SK-1533
K025468XS	SK-1082
K025469XS	SK-1637
K025478XS	SK-1751
K025484XS	SK-1108
K025485	SK-1083
K025485XS	SK-1707
K025486XS	SK-1084
K025491XS	SK-1660
K025492XS	SK-1638
K025493XS	SK-1377
K025495XS	SK-1681
K025499XS	SK-1355
K025500XS	SK-1629
K025501XS	SK-1630
K025507XS	SK-1494
K025508XS	SK-1340
K025509XS	SK-1492
K025520XS	SK-1633
K025523XS	SK-1086
K025524XS	SK-1085
K025529XS	SK-1591
K025535XS	SK-1685

GATES

K025542XS	SK-1632
K025543XS	SK-1110
K025543XS	SK-1259
K025547XS	SK-1552
K025550XS	SK-1624
K025553XS	SK-1747
K025555XS	SK-1749
K025556XS	SK-1746
K025557XS	SK-1621
K025558XS	SK-1614
K025559XS	SK-1259
K025560XS	SK-1722
K025561XS	SK-1622
K025562XS	SK-1717
K025563XS	SK-1479
K025564XS	SK-1106
K025565XS	SK-1511
K025569XS	SK-1583
K025578XS	SK-1487
K025581XS	SK-1615
K025588XS	SK-1616
K025590XS	SK-1617
K025600XS	SK-1367
K025601XS	SK-1604
K025604XS	SK-1606
K025605XS	SK-1601
K025607XS	SK-1668
K025608XS	SK-1600
K025609XS	SK-1745
K025612XS	SK-1721
K025614XS	SK-1743
K025622XS	SK-1593
K025623XS	SK-1587
K025624XS	SK-1742
K025630XS	SK-1741
K025633XS	SK-1692
K025636XS	SK-1740
K025641XS	SK-1737
K025649XS	SK-1727
K025650XS	SK-1696
K025671XS	SK-1630
K025676XS	SK-1720
K02T265	SK-1701
K035033	SK-1138
K035040	SK-1014
K035080	SK-1151
K0350800	SK-1151
K035182XS	SK-1130
K035193XS	SK-1168
K035223XS	SK-1069

GATES

K035251XS	SK-1041
K035308	SK-1261
K035309XS	SK-1097
K035323XS	SK-1380
K035360XS	SK-1094
K035429XS	SK-1361
K035433XS	SK-1754
K035434XS	SK-1753
K035451XS	SK-1078
K035462XS	SK-1646
K035468XS	SK-1399
K035469XS	SK-1639
K035486XS	SK-1114
K035486XS	SK-1663
K035491XS	SK-1640
K035492XS	SK-1641
K035493XS	SK-1383
K035499XS	SK-1355
K035500XS	SK-1629
K035507XS	SK-1631
K035508XS	SK-1748
K035509XS	SK-1666
K035520XS	SK-1375
K035524XS	SK-1085
K035542XS	SK-1667
K035559XS	SK-1686
K035561XS	SK-1490
K035563XS	SK-1689
K035565XS	SK-1511
K035569XS	SK-1388
K035600XS	SK-1602
K035604XS	SK-1724
K035623XS	SK-1586
K045040	SK-1063
K045193XS	SK-1054
K045223XS	SK-1098
K045309XS	SK-1068
K045323XS	SK-1539
K045429XS	SK-1410
K045433XS	SK-1659
K045462XS	SK-1080
K045486XS	SK-1084
K045492XS	SK-1121
K045493XS	SK-1687
K045500XS	SK-1112
K045520XS	SK-1633
K045563XS	SK-1481
K045569XS	SK-1378
K045600XS	SK-1367
K045623XS	SK-1587

GATES

K055193XS	SK-1168
K055223XS	SK-1593
K055309XS	SK-1440
K055323XS	SK-1529
K055429XS	SK-1410
K055433XS	SK-1077
K055491XS	SK-1661
K055493XS	SK-1688
K055500XS	SK-1629
K055569XS	SK-1372
K065193XS	SK-1164
K065323XS	SK-1648
K065429XS	SK-1755
K065468XS	SK-1399
K065491XS	SK-1709
K065493XS	SK-1386
K065569XS	SK-1388
K075429XS	SK-1756
K075491XS	SK-1710
K075493XS	SK-1687
K075569XS	SK-1378
K085493XS	SK-1688
K095493XS	SK-1688
KP15030XS	SK-1665AQ1
KP15035	SK-1129AQ1
KP15049XS	SK-1007AQ1
KP15127XS	SK-1003AQ1
KP15129	SK-1037AQ1
KP15175XS-1	SK-1004AQ1
KP15192XS	SK-1021AQ1
KP15245	SK-1126AQ1
KP15249XS	SK-1017AQ1
KP15310XS	SK-1162AQ1
KP15311	R-1190AQ1
KP15323XS	SK-1526AQ1
KP15344XS	SK-1343AQ1
KP15347XS	SK-1020AQ1
KP15357XS	SK-1053AQ1
KP15367XS	SK-1169AQ1
KP15368XS	SK-1038AQ1
KP15369XS-1	SK-1073AQ2
KP15369XS-2	SK-1073AQ3
KP15369XS-3	SK-1073AQ1
KP15378XS	SK-1103AQ1
KP15397XS	SK-1270AQ1
KP15400	R-1257AQ1
KP15408XS	SK-1100AQ1
KP15409XS-1	SK-1288AQ1
KP15410XS-1	SK-1277AQ1
KP15410XS-2	SK-1277AQ2



GATES

KP15411XS	SK-1043AQ1
KP15416XS	SK-1507AQ1
KP15418XS	SK-1040AQ1
KP15419XS-1	SK-1273AQ1
KP15419XS-2	SK-1273AQ2
KP15426	SK-1344AQ1
KP15427XS-1	SK-1131AQ2
KP15427XS-2	SK-1131AQ1
KP15428XS	SK-1074AQ1
KP15434XS	SK-1183AQ1
KP15435XS	SK-1096AQ1
KP15441XS	SK-1458AQ1
KP15445XS-1	SK-1316AQ1
KP15445XS-2	SK-1316AQ2
KP15462XS	SK-1646AQ1
KP15472XS	SK-1697AQ1
KP15473XS	SK-1338AQ2
KP15479XS	SK-1634AQ1
KP15480XS	SK-1430AQ1
KP15489XS-1	SK-1109AQ1
KP15489XS-2	SK-1109AQ2
KP15490XS	SK-1635AQ1
KP15491XS	SK-1337AQ1
KP15499XS-1	SK-1113AQ1
KP15499XS-2	SK-1113AQ2
KP15500XS	SK-1112AQ1
KP15501XS	SK-1088AQ1
KP15503XS-1	SK-1412AQ1
KP15503XS-2	SK-1412AQ2
KP15505XS	SK-1436AQ1
KP15509XS	SK-1491AQ1
KP15510XS	SK-1671AQ1
KP15514XS-1	SK-1325AQ1
KP15514XS-2	SK-1325AQ2
KP15523XS	SK-1086AQ1
KP15524XS	SK-1085AQ1
KP15528XS	SK-1482AQ1
KP15537XS-1	SK-1712AQ1
KP15537XS-2	SK-1712AQ2
KP15537XS-3	SK-1712AQ3
KP15542XS	SK-1478AQ1
KP15543XS	SK-1111AQ1
KP15544XS	SK-1421AQ1
KP15544XS-2	SK-1421AQ1
KP15545XS	SK-1418AQ1
KP15552XS	SK-1493AQ1
KP15557XS-1	SK-1619AQ2
KP15558XS	SK-1394AQ1
KP15559XS-1	SK-1258AQ1
KP15562XS	SK-1589AQ1

GATES

KP15562XS-2	SK-1589AQ2
KP15565XS-1	SK-1585AQ1
KP15569XS-1	SK-1582AQ1
KP15569XS-2	SK-1582AQ2
KP15574XS	SK-1353AQ1
KP15575XS	SK-1354AQ1
KP15577XS	SK-1486AQ1
KP15578XS	SK-1487AQ1
KP15579XS-1	SK-1654AQ1
KP15579XS-2	SK-1654AQ2
KP15580XS	SK-1608AQ1
KP15581XS	SK-1392AQ1
KP15587XS	SK-1391AQ1
KP15588XS	SK-1534AQ1
KP15589XS	SK-1577AQ1
KP15590XS	SK-1609AQ1
KP15592XS	SK-1610AQ1
KP15593XS	SK-1590AQ1
KP15596XS	SK-1674AQ1
KP15598XS	SK-1424AQ1
KP15600XS	SK-1602AQ1
KP15601XS-1	SK-1603AQ1
KP15601XS-2	SK-1603AQ1
KP15602XS-1	SK-1483AQ1
KP15604XS-1	SK-1724AQ2
KP15604XS-2	SK-1724AQ1
KP15606XS	SK-1594AQ1
KP15607XS-1	SK-1595AQ1
KP15607XS-2	SK-1595AQ1
KP15608XS	SK-1596AQ1
KP15610XS	SK-1580AQ1
KP15612XS-1	SK-1719AQ1
KP15615XS	SK-1598AQ1
KP15616XS	SK-1599AQ1
KP15623XS	SK-1586AQ1
KP15626XS	SK-1676AQ1
KP15627XS	SK-1677AQ1
KP15630XS	SK-1678AQ1
KP15646XS	SK-1693AQ1
KP15648XS-1	SK-1694AQ2
KP15648XS-2	SK-1694AQ1
KP15649XS-1	SK-1695AQ1
KP15650XS	SK-1696AQ1
KP15653XS	SK-1697AQ1
KP15654XS	SK-1698AQ1
KP15655XS	SK-1733AQ1
KP15656XS	SK-1728AQ1
KP15657XS	SK-1732AQ1
KP15661XS	SK-1686AQ1
KP15662XS	SK-1704AQ1

GATES

KP15671XS	SK-1088AQ1
KP15672XS	SK-1714AQ1
KP15675XS	SK-1730AQ1
KP25047	R-1072AQ1
KP25049XS	SK-1022AQ1
KP25049XS	SK-1022AQ2
KP25192XS	SK-1021AQ2
KP25344XS	SK-1376AQ1
KP25416XS	SK-1706AQ1
KP25418XS	SK-1642AQ1
KP25427XS	SK-1592AQ1
KP25451XS-1	SK-1042AQ1
KP25451XS-2	SK-1042AQ2
KP25451XS-4	SK-1042AQ3
KP25454XS	SK-1081AQ2
KP25454XS-2	SK-1081AQ3
KP25461XS	SK-1644AQ1
KP25468XS-1	SK-1082AQ1
KP25468XS-2	SK-1082AQ2
KP25473XS	SK-1338AQ1
KP25491XS	SK-1660AQ1
KP25493XS-1	SK-1377AQ1
KP25499XS-1	SK-1355AQ3
KP25499XS-2	SK-1355AQ1
KP25499XS-3	SK-1355AQ2
KP25500XS	SK-1629AQ1
KP25501XS	SK-1630AQ1
KP25509XS	SK-1492AQ1
KP25523XS	SK-1086AQ1
KP25524XS	SK-1085AQ1
KP25535XS	SK-1685AQ1
KP25542XS	SK-1632AQ1
KP25543XS-2	SK-1259AQ1
KP25550XS	SK-1624AQ1
KP25557XS-1	SK-1621AQ1
KP25558XS	SK-1614AQ1
KP25559XS-1	SK-1259AQ1
KP25559XS-2	SK-1259AQ1
KP25562XS-1	SK-1717AQ1
KP25562XS-2	SK-1717AQ2
KP25565XS-1	SK-1511AQ1
KP25565XS-2	SK-1511AQ2
KP25569XS-1	SK-1583AQ1
KP25569XS-2	SK-1583AQ2
KP25577XS	SK-1486AQ1
KP25578XS	SK-1487AQ2
KP25578XS-2	SK-1487AQ3
KP25578XS-3	SK-1487AQ1
KP25581XS	SK-1615AQ1
KP25590XS	SK-1617AQ1

GATES

KP25600XS	SK-1367AQ1
KP25601XS-1	SK-1604AQ1
KP25601XS-2	SK-1604AQ1
KP25607XS-1	SK-1668AQ1
KP25607XS-2	SK-1668AQ1
KP25608XS	SK-1600AQ1
KP25612XS-1	SK-1721AQ1
KP25612XS-2	SK-1721AQ2
KP25612XS-3	SK-1721AQ3
KP25623XS	SK-1587AQ1
KP25630XS	SK-1741AQ1
KP25633XS	SK-1692AQ1
KP25649XS-1	SK-1727AQ2
KP25650XS	SK-1696AQ1
KP25671XS	SK-1630AQ1
KP35323XS	SK-1380AQ1
KP35360XS	SK-1094AQ1
KP35429XS	SK-1361AQ1
KP35451XS-1	SK-1078AQ1
KP35451XS-2	SK-1078AQ2
KP35451XS-3	SK-1078AQ3
KP35462XS	SK-1646AQ1
KP35468XS	SK-1399AQ1
KP35491XS-1	SK-1640AQ1
KP35491XS-2	SK-1640AQ2
KP35493XS-1	SK-1383AQ1
KP35500XS	SK-1629AQ1
KP35509XS	SK-1666AQ1
KP35520XS	SK-1619AQ2
KP35524XS	SK-1085AQ1
KP35542XS	SK-1667AQ1
KP35565XS	SK-1511AQ1
KP35600XS	SK-1602AQ1
KP35604XS	SK-1724AQ1
KP35604XS-2	SK-1724AQ2
KP35623XS-1	SK-1586AQ1
KP45323XS	SK-1539AQ1
KP45500XS	SK-1112AQ1
KP45520XS	SK-1621AQ1
KP45600XS	SK-1367AQ1
KP45623XS	SK-1587AQ1
KP55323XS-1	SK-1529AQ1
KP55429XS	SK-1410AQ1
KP55500XS	SK-1629AQ1
KP55569XS-1	SK-1372AQ2
KP55569XS-2	SK-1372AQ1
KP55569XS-3	SK-1372AQ1
KP55569XS-4	SK-1372AQ3
KP65429XS	SK-1755AQ1
KP65569XS-1	SK-1388AQ1

GATES

GATES

GATES

GATES

KP75569XS-1	SK-1378AQ1
T36000	0-N1312
T36001	0-N1403
T36004	0-N1630
T36005	0-N1311
T36006	0-N1415
T36008	0-N1628
T36010	0-N187
T36011	0-N1634
T36012	0-N1413
T36013	0-N1452
T36014	0-N1629
T36015	0-N2156
T36016	0-N1894
T36018	0-N135
T36019	0-N2349
T36020	0-N2153
T36021	0-N1751
T36022	0-N1899
T36023	0-N095
T36024	0-N1749
T36024	0-N1749S
T36025	0-N1545
T36026	0-N2186
T36028	0-N1968
T36029	0-N1446
T36030	0-N1402
T36030	0-N1402S
T36031	0-N1465S
T36032	0-N1309
T36033	0-N1405
T36034	0-N1418
T36035	0-N150
T36036	0-N1722
T36037	0-N1904
T36037	0-N1975
T36038	0-N1439
T36039	0-N1544
T36040	0-N144
T36042	0-N143
T36043	0-N134
T36044	0-N139
T36045	0-N2013
T36046	0-N138
T36048	0-N1729
T36049	0-N2016
T36050	0-N1752
T36051	0-N1590
T36052	0-N1589
T36053	0-N1540

T36055	0-N2054
T36058	0-N1599
T36058	0-N1599S
T36059	0-N931
T36061	0-N124
T36062	0-N1681
T36063	0-N133
T36064	0-N849
T36066	0-N125
T36066	0-N125S
T36067	0-N1748
T36068	0-N1463S
T36070	0-N2174
T36071	0-N2015
T36072	0-N155
T36073	0-N156
T36074	0-N1400
T36074	0-N1400S
T36075	0-N149
T36076	0-N1591
T36079	0-N1429
T36080	0-N1404
T36081	0-N1408
T36082	0-N1399
T36083	0-N1310
T36084	0-N1409
T36085	0-N1651
T36085	0-N1651S
T36086	0-N1854
T36088	0-N1425
T36089	0-N1458
T36090	0-N1420
T36105	0-N1893
T36105	0-N1893S
T36106	0-N1892
T36106	0-N1892S
T36107	0-N2266
T36107	0-N2266S1
T36107	0-N2266S2
T36108	0-N2022
T36108	0-N2022S
T36109	0-N2094
T36122	0-N1592
T36123	0-N1457
T36124	0-N1392
T36125	0-N1428
T36135	0-N1730
T36151	0-N151
T36158	0-N1398
T36159	0-N1672

T36160	0-N1833
T36161	0-N1304
T36163	0-N1292
T36168	0-N1786
T36173	0-N1728
T36174	0-N1878
T36175	0-N1385
T36176	0-N1307
T36182	0-N1426
T36183	0-N1388
T36184	0-N1424
T36186	0-N1665
T36189	0-N1723
T36190	0-N1419
T36191	0-N1421
T36194	0-N1898
T36194	0-N1898S
T36197	0-N1642
T36198	0-N1702
T36199	0-N1716
T36204	0-N1991
T36206	0-N1547
T36207	0-N1394
T36208	0-N187
T36211	0-N1401
T36212	0-N1437
T36214	0-N1635
T36215	0-N1451
T36216	0-N1647
T36228	0-N2041
T36229	0-N2024
T36232	0-N1909
T36236	0-N2134
T36247	0-N1871
T36248	0-N1738
T36249	0-N1450
T36251	0-N1662
T36252	0-N1395
T36253	0-N1553
T36254	0-N1667
T36257	0-N1397
T36258	0-N1744
T36260	0-N1522
T36261	0-N1667
T36262	0-N2133
T36263	0-N1859
T36293	0-N1301
T36294	0-N1792
T36295	0-N1807
T36296	0-N1505S

T36297	0-N1396
T36300	0-N1715
T36303	0-N1746
T36304	0-N1288
T36307	0-N2021
T36320	0-N2033
T36322	0-N2048
T36323	0-N2048
T36325	0-N1990
T36361	0-N1924
T36362	0-N1736
T36363	0-N1423
T36364	0-N2130
T36366	0-N2019
T36367	0-N2243
T36369	0-N2128
T36372	0-N2138
T36373	0-N1950
T36374	0-N1944
T36375	0-N1560
T36376	0-N1795
T36379	0-N2040
T36380	0-N1739
T36382	0-N2050
T36384	0-N2110
T36385	0-N1453
T36386	0-N1928
T36387	0-N1803
T36388	0-N2171
T36391	0-N1649
T36392	0-N2191
T36393	0-N1963
T36394	0-N1976
T36395	0-N1983
T36397	0-N1544
T36398	0-N2353
T36401	0-N1387
T36402	0-N1386
T36403	0-N1806
T36405	0-N1907
T36406	0-N2052
T36407	0-N2367
T36408	0-N2274
T36411	0-N1814
T36412	0-N2276
T36413	0-N2275
T36414	0-N2221
T36415	0-N1984
T36416	0-N2051
T36417	0-N2244



GATES

T36419	0-N1987
T36420	0-N2286
T36422	0-N2302S
T36423	0-N2206
T36424	0-N1852
T36425	0-N2311
T36427	0-N2355
T36430	0-N2364
T36431	0-N1942
T36434	0-N2284
T36435	0-N2368
T36436	0-N2027
T36437	0-N2119
T36438	0-N2120
T36444	0-N1661
T36445	0-N2028
T36448	0-N1982
T36452	0-N2125
T36453	0-N2132
T36455	0-N2199
T36456	0-N1460
T36458	0-N2429
T36462	0-N1906
T36464	0-N2238
T36465	0-N2205
T36466	0-N2350
T36469	0-N2122
T36473	0-N2375
T36475	0-N2379
T36477	0-N2374
T36478	0-N2227
T36480	0-N2228
T36482	0-N2177
T36485	0-N2121
T36486	0-N2296
T36487	0-N2312
T36490	0-N2253
T36493	0-N2303
T36495	0-N1521
T36498	0-N2273
T36603	0-N2283
T36605	0-N2304
T36606	0-N2097
T36607	0-N1711S
T36608	0-N2240
T36610	0-N2254
T36618	0-N2310
T38001	0-N1684
T38003	0-N1693
T38005	0-N1687

GATES

T38006	0-N1685
T38007	0-N1688
T38008	0-N1689
T38009	0-N1690
T38010	0-N1694
T38011	0-N1691
T38015	0-N1692
T38016	0-N2123
T38018	0-N1686
T38023	0-N1718
T38024	0-N1646
T38025	0-N1701
T38027	0-N1678
T38028	0-N2207
T38029	0-N1695
T38030	0-N1724
T38030	0-N2102
T38031	0-N1725
T38034	0-N1695
T38041	0-N1696
T38046	0-N1297
T38054	0-N1454
T38055	0-N1416
T38056	0-N1501
T38056	0-N1501S
T38059	0-N1308
T38060	0-N197
T38061	0-N1295
T38061	0-N1295S
T38062	0-N1741
T38062	0-N1741S
T38063	0-N1299
T38063	0-N1299S
T38064	0-N2140
T38065	0-N1640
T38065	0-N1640S
T38066	0-N1585
T38066	0-N1585S
T38068	0-N1317
T38068	0-N1317S
T38069	0-N1298
T38070	0-N1306
T38071	0-N1301
T38073	0-N1586
T38074	0-N1604
T38078	0-N1414
T38081	0-N1603
T38082	0-N1431
T38083	0-N1430
T38085	0-N141

GATES

T38086	0-N2179
T38087	0-N1417
T38089	0-N846
T38092	0-N847
T38093	0-N1632
T38094	0-N174
T38095	0-N1278
T38095	0-N1442
T38097	0-N1315
T38098	0-N1713
T38099	0-N1431
T38103	0-N1697
T38103	0-N1697S
T38104	0-N1658
T38105	0-N1848
T38105	0-N1848S
T38108	0-N1849S
T38113	0-N1698
T38113	0-N1698S
T38116	0-N1839
T38116	0-N1839S
T38122	0-N1699
T38122	0-N1699S
T38147	0-N1660
T38148	0-N1041
T38148	0-N1041S
T38149	0-N1677
T38149	0-N1677S
T38151	0-N1822
T38151	0-N1822S
T38154	0-N1422
T38154	0-N1422S
T38156	0-N1876
T38156	0-N1876S
T38158	0-N1846
T38158	0-N1846S
T38167	0-N2257
T38167	0-N2257S1
T38167	0-N2257S2
T38170	0-N1877
T38170	0-N1877S
T38173	0-N2187
T38174	0-N1645
T38174	0-N1645S
T38175	0-N1657
T38175	0-N1657S
T38176	0-N1555
T38176	0-N1555S
T38177	0-N1588
T38177	0-N1588S

GATES

T38183	0-N2102
T38185	0-N2406
T38185	0-N2406S
T38188	0-N1435
T38188	0-N1435S
T38190	0-N1529
T38190	0-N1529S
T38192	0-N1538
T38192	0-N1538S
T38193	0-N1083
T38193	0-N1083S
T38201	0-N1290
T38201	0-N1290S
T38202	0-N1897
T38202	0-N1897S
T38203	0-N1903
T38203	0-N1903S
T38204	0-N1497
T38204	0-N1497S
T38205	0-N1796
T38205	0-N1796S
T38206	0-N1391
T38206	0-N1391S
T38207	0-N1671
T38207	0-N1671S
T38209	0-N1525
T38209	0-N1525S
T38211	0-N1282
T38212	0-N1466
T38212	0-N1466S
T38213	0-N1322
T38213	0-N1322S
T38214	0-N1445
T38214	0-N1445S
T38215	0-N1443
T38215	0-N1443S
T38216	0-N1810
T38216	0-N1810S
T38217	0-N2409
T38218	0-N1787
T38219	0-N2410
T38220	0-N1974
T38222	0-N1758
T38224	0-N1291
T38224	0-N1291S
T38225	0-N1703
T38226	0-N1410
T38226	0-N1410S
T38228	0-N1005
T38230	0-N1593

GATES

GATES

GATES

GATES

T38230	0-N1593S
T38231	0-N1320
T38232	0-N1949
T38233	0-N1756
T38234	0-N1484
T38234	0-N1484S
T38235	0-N1472
T38235	0-N1472S
T38236	0-N1471
T38236	0-N1471S
T38237	0-N2046
T38237	0-N2046S
T38238	0-N1486
T38238	0-N1486S
T38239	0-N1485
T38239	0-N1485S
T38240	0-N152
T38240	0-N152S
T38242	0-N1919
T38242	0-N1919S
T38244	0-N1511
T38245	0-N1809
T38245	0-N1809S
T38246	0-N2053
T38246	0-N2053S
T38263	0-N1011
T38263	0-N1011S
T38264	0-N1013
T38264	0-N1013S
T38272	0-N1434
T38272	0-N1434S
T38278	0-N1850
T38278	0-N1850S
T38279	0-N2281
T38279	0-N2281S
T38280	0-N1455
T38282	0-N1539
T38282	0-N1539S
T38283	0-N1459
T38283	0-N1459S
T38286	0-N1462
T38286	0-N1462S
T38287	0-N1558S
T38304	0-N1518
T38304	0-N1518S
T38305	0-N1489S
T38306	0-N1441
T38306	0-N1441S
T38306	0-N2047
T38307	0-N1494

T38307	0-N1494S
T38311	0-N2039
T38311	0-N2039S
T38312	0-N2095
T38312	0-N2095S
T38313	0-N1673
T38313	0-N1673S
T38316	0-N1433
T38316	0-N1433S
T38317	0-N1676
T38317	0-N1676S
T38318	0-N1639
T38318	0-N1639S
T38319	0-N1670
T38319	0-N1670S
T38320	0-N1556S
T38331	0-N1339
T38331	0-N1339S
T38343	0-N1438
T38343	0-N1438S
T38344	0-N2170
T38344	0-N2170S
T38345	0-N1609
T38346	0-N1587
T38346	0-N1587S
T38347	0-N1474
T38348	0-N1475S
T38354	0-N1477
T38354	0-N1477S
T38355	0-N1469
T38356	0-N1407
T38356	0-N1407S
T38357	0-N2034
T38357	0-N2034S
T38363	0-N1407
T38363	0-N1407S
T38364	0-N1487
T38364	0-N1487S
T38368	0-N1517
T38368	0-N1517S
T38369	0-N1464
T38369	0-N1464S
T38370	0-N1481
T38370	0-N1481S
T38371	0-N1636
T38371	0-N1636S
T38372	0-N1675
T38372	0-N2065
T38372	0-N2065S
T38375	0-N1432

T38375	0-N1432S
T38376	0-N1532
T38376	0-N1532S
T38377	0-N1496S
T38384	0-N1791
T38384	0-N1791S
T38387	0-N1606
T38387	0-N1606S
T38392	0-N1493
T38392	0-N1493S
T38399	0-N1490S
T38404	0-N2124
T38404	0-N2124S
T38405	0-N1492
T38405	0-N1492S
T38406	0-N1537
T38406	0-N1537S
T38407	0-N1747
T38408	0-N1811
T38408	0-N1811S
T38411	0-N2188
T38411	0-N2188S
T38413	0-N2105
T38413	0-N2105S
T38415	0-N1641
T38415	0-N1641S
T38421	0-N1812
T38421	0-N1812S
T38423	0-N1830
T38423	0-N1830S
T38425	0-N1857
T38425	0-N1857S
T38426	0-N1536
T38426	0-N1536S
T38427	0-N1534
T38427	0-N1534S
T38428	0-N1427
T38428	0-N1427S
T38429	0-N2246
T38429	0-N2246S1
T38429	0-N2246S2
T38429	0-N2246S3
T38430	0-N1535
T38430	0-N1535S
T38431	0-N1719
T38431	0-N1719S
T38432	0-N1495S
T38433	0-N1799
T38433	0-N1799S
T38434	0-N1557S

T38435	0-N1482S
T38436	0-N1531
T38436	0-N1531S
T38437	0-N1953
T38437	0-N1953S
T38438	0-N1530
T38438	0-N1530S
T38439	0-N1733
T38439	0-N1733S
T38440	0-N1526
T38440	0-N1526S
T38441	0-N1643
T38441	0-N1643S
T38442	0-N1659
T38442	0-N1659S
T38443	0-N1957
T38443	0-N1957S
T38444	0-N1520
T38444	0-N1520S
T38444	0-N1610
T38445	0-N1390
T38445	0-N1390S
T38446	0-N1620
T38446	0-N1620S
T38447	0-N1712
T38448	0-N1551
T38448	0-N1551S
T38450	0-N2209
T38450	0-N2209S
T38451	0-N2137
T38451	0-N2137S
T38454	0-N1815
T38454	0-N1815S
T38455	0-N1731
T38455	0-N1731S
T38456	0-N1663
T38456	0-N1663S
T38457	0-N1470
T38457	0-N1470S
T38458	0-N1808
T38458	0-N1808S
T38461	0-N1856
T38461	0-N1856S
T38464	0-N1855
T38464	0-N1855S
T38465	0-N1946
T38465	0-N1946S1
T38465	0-N1946S2
T38466	0-N1941
T38466	0-N1941S1



GATES

T38466	0-N1941S2
T38466	0-N1941S3
T38467	0-N1533
T38467	0-N1533S
T38468	0-N1802
T38468	0-N1802S
T38469	0-N1476
T38469	0-N1476S
T38469	0-N1664
T38469	0-N1664S
T38470	0-N2029
T38470	0-N2029S
T38471	0-N2232
T38471	0-N2232S
T38472	0-N1704
T38472	0-N1704S
T38473	0-N1595
T38473	0-N1595S
T38474	0-N1624
T38474	0-N1624S
T38475	0-N2154
T38476	0-N1682
T38477	0-N2037
T38477	0-N2037S
T38480	0-N1845
T38480	0-N1845S
T38481	0-N1488
T38481	0-N1488S
T38482	0-N1611
T38482	0-N1611S
T38484	0-N1314
T38489	0-N2182
T38489	0-N2182S
T38491	0-N1742
T38491	0-N1742S
T38495	0-N2242
T38495	0-N2242S
T38496	0-N1798
T38496	0-N1798S
T38498	0-N2389
T38498	0-N2389S
T38499	0-N1920
T38588	0-N1480S
T39000	0-N1913
T39000	0-N1913S
T39005	0-N1523
T39006	0-N1790
T39008	0-N1502
T39008	0-N1502S
T39009	0-N1476

GATES

T39009	0-N1476S
T39009	0-N1664
T39009	0-N1664S
T39010	0-N1794
T39010	0-N1794S
T39011	0-N1743
T39013	0-N1961
T39014	0-N1478S
T39015	0-N1834
T39015	0-N1834S
T39016	0-N1793
T39016	0-N1793S
T39017	0-N1503
T39017	0-N1503S
T39019	0-N1514
T39019	0-N1514S
T39020	0-N1956
T39020	0-N1956S
T39021	0-N1908
T39021	0-N1908S
T39023	0-N2111
T39023	0-N2111S
T39024	0-N1709
T39024	0-N1709S1
T39024	0-N1709S2
T39025	0-N1491S
T39026	0-N1979
T39026	0-N1979S
T39028	0-N2043
T39033	0-N1945
T39033	0-N1945S
T39038	0-N2074
T39038	0-N2074S
T39039	0-N2075
T39040	0-N2092
T39040	0-N2092S
T39041	0-N1840
T39041	0-N1840S
T39043	0-N1918
T39043	0-N1918S
T39050	0-N2148
T39053	0-N2112
T39053	0-N2112S
T39055	0-N1620
T39055	0-N1620S
T39056	0-N1589
T39057	0-N1584
T39059	0-N1412
T39060	0-N1627
T39060	0-N1627S

GATES

T39061	0-N1720
T39061	0-N1720S
T39062	0-N1902
T39062	0-N1902S
T39063	0-N1626
T39063	0-N1626S
T39064	0-N2245
T39064	0-N2245S1
T39064	0-N2245S2
T39064	0-N2245S3
T39065	0-N2391
T39065	0-N2391S
T39066	0-N1601
T39066	0-N1601S
T39073	0-N2399
T39073	0-N2399S
T39074	0-N1858
T39074	0-N1858S
T39077	0-N2158
T39077	0-N2158S
T39084	0-N1656
T39084	0-N1656S
T39085	0-N2031
T39085	0-N2031S
T39086	0-N1875
T39086	0-N1875S
T39087	0-N1832
T39087	0-N1832S
T39088	0-N1675
T39088	0-N2065
T39088	0-N2065S
T39089	0-N1900
T39091	0-N2064
T39097	0-N1303
T39099	0-N1955
T39099	0-N1955S
T39102	0-N2103
T39102	0-N2103S
T39103	0-N2104
T39103	0-N2104S
T39104	0-N2250
T39104	0-N2250S
T39107	0-N2014
T39107	0-N2014S
T39108	0-N2038
T39108	0-N2038S
T39109	0-N1958
T39109	0-N1958S
T39110	0-N1851
T39110	0-N1851S

GATES

T39111	0-N2181
T39112	0-N1788
T39112	0-N1788S
T39113	0-N2093
T39113	0-N2093S
T39114	0-N1621
T39114	0-N1621S
T39115	0-N1908
T39115	0-N1908S
T39116	0-N1964
T39116	0-N1964S
T39117	0-N2190
T39117	0-N2190S
T39118	0-N2109
T39118	0-N2109S
T39122	0-N2026
T39122	0-N2026S
T39123	0-N1813
T39123	0-N1813S
T39124	0-N2042
T39124	0-N2042S
T39126	0-N1874
T39126	0-N1874S
T39127	0-N2055
T39127	0-N2055S
T39128	0-N1842
T39128	0-N1842S
T39133	0-N2113
T39133	0-N2113S
T39134	0-N1552
T39134	0-N1552S
T39135	0-N1880
T39135	0-N1880S
T39136	0-N2401
T39136	0-N2401S1
T39136	0-N2401S2
T39137	0-N1714
T39137	0-N1714S
T39138	0-N1483
T39138	0-N1483S
T39139	0-N1528
T39139	0-N1528S
T39140	0-N2032
T39140	0-N2032S
T39141	0-N1797
T39141	0-N1797S
T39143	0-N1721
T39145	0-N1554
T39145	0-N1554S
T39149	0-N2180

GATES

T39150	0-N2231
T39150	0-N2231S
T39152	0-N1473
T39152	0-N1473S
T39152	0-N2175
T39154	0-N2098
T39154	0-N2098S
T39157	0-N2096
T39157	0-N2096S
T39162	0-N1869
T39162	0-N1869S
T39163	0-N2265
T39163	0-N2265S
T39164	0-N2087
T39164	0-N2087S
T39165	0-N2083
T39165	0-N2083S
T39166	0-N2086
T39166	0-N2086S
T39167	0-N2066
T39168	0-N2072
T39169	0-N2081
T39169	0-N2081S
T39170	0-N2089
T39170	0-N2089S
T39171	0-N2085
T39171	0-N2085S
T39172	0-N2088
T39172	0-N2088S
T39173	0-N2091
T39173	0-N2091S
T39174	0-N2030
T39174	0-N2030S
T39177	0-N2357
T39182	0-N2210
T39182	0-N2210S
T39184	0-N2425
T39186	0-N2268
T39186	0-N2268S
T39187	0-N2392
T39187	0-N2392S
T39188	0-N2396
T39188	0-N2396S
T39190	0-N2404
T39190	0-N2404S
T39196	0-N2422
T39196	0-N2422S
T39198	0-N2216
T39198	0-N2216S1
T39198	0-N2216S2

GATES

T39199	0-N2217
T39199	0-N2217S1
T39199	0-N2217S2
T39200	0-N2067
T39203	0-N2082
T39203	0-N2082S
T39204	0-N2297
T39207	0-N2136
T39207	0-N2136S
T39208	0-N2219
T39208	0-N2219S
T39210	0-N2202
T39210	0-N2202S
T39211	0-N2116
T39211	0-N2116S
T39212	0-N2403
T39212	0-N2403S
T39213	0-N2226
T39213	0-N2226S
T39219	0-N2211
T39219	0-N2211S
T39222	0-N2155
T39222	0-N2155S
T39224	0-N2106
T39225	0-N2106
T39226	0-N2084
T39226	0-N2084S
T39227	0-N2397
T39227	0-N2397S
T39230	0-N1951
T39231	0-N2147
T39232	0-N2142
T39233	0-N2143
T39235	0-N2146
T39236	0-N1954
T39236	0-N1954S
T39237	0-N2144
T39238	0-N2204
T39238	0-N2204S
T39239	0-N2197
T39239	0-N2197S
T39243	0-N2135
T39246	0-N2198
T39246	0-N2198S
T39247	0-N1735
T39248	0-N2270
T39248	0-N2270S
T39249	0-N2114
T39249	0-N2114S
T39250	0-N2213

GATES

T39250	0-N2213S
T39251	0-N2280
T39251	0-N2280S
T39256	0-N2395
T39256	0-N2395S
T39257	0-N2230
T39257	0-N2230S
T39264	0-N1804
T39264	0-N1804S
T39265	0-N1947
T39266	0-N2269
T39266	0-N2269S
T39267	0-N2279
T39267	0-N2279S
T39275	0-N2247
T39275	0-N2247S
T39276	0-N2248
T39277	0-N2249
T39279	0-N2035
T39279	0-N2035S
T39281	0-N2390
T39281	0-N2390S
T39284	0-N2394
T39284	0-N2394S
T39285	0-N2036
T39286	0-N2164
T39287	0-N2212
T39287	0-N2212S
T39288	0-N2299
T39288	0-N2299S
T39290	0-N1964
T39290	0-N1964S
T39292	0-N2288
T39292	0-N2288S
T39293	0-N2214
T39293	0-N2214S
T39294	0-N2293
T39294	0-N2293S
T39295	0-N2300
T39295	0-N2300S
T39296	0-N2301
T39296	0-N2301S
T39297	0-N2267
T39297	0-N2267S
T39333	0-N2287
T39333	0-N2287S
T39338	0-N2309
T39338	0-N2309S
T39340	0-N2290
T39340	0-N2290S

GATES

T39344	0-N1926
T41002	0-N1835
T41002	0-N2327
T41003	0-N037
T41008	0-N903
T41013	0-N178
T41014	0-N905
T41023	0-N978
T41031	0-N069
T41037	0-N975
T41038	0-N1127
T41039	0-N185
T41040	0-N1577
T41041	0-N1561
T41043	0-N059
T41045	0-N186
T41046	0-N054
T41051	0-N987
T41053	0-N183
T41064	0-N018
T41065	0-N916
T41071	0-N007
T41072	0-N999
T41074	0-N998
T41078	0-N1883
T41078	0-N1883S
T41079	0-N805
T41081	0-N860
T41082	0-N1238
T41083	0-N809
T41086	0-N1054
T41087	0-N1498
T41088	0-N021
T41094	0-N1363
T41095	0-N1266
T41097	0-N1568
T41098	0-N1568
T41099	0-N1978
T41099	0-N1978S
T41100	0-N1371
T41101	0-N1914
T41107	0-N808
T41108	0-N129
T41118	0-N819
T41119	0-N835
T41121	0-N822
T41129	0-N811
T41130	0-N861
T41131	0-N121
T41135	0-N911



GATES

T41137	0-N813
T41138	0-N901
T41139	0-N118P
T41140	0-N118P
T41141	0-N944
T41143	0-N874
T41144	0-N915
T41145	0-N985
T41147	0-N837
T41151	0-N879
T41154	0-N863
T41155	0-N145
T41157	0-N173
T41161	0-N882
T41165	0-N930
T41169	0-N894
T41172	0-N955
T41178	0-N816
T41180	0-N1754
T41181	0-N013
T41183	0-N176
T41189	0-N030
T41191	0-N034
T41211	0-N181
T41212	0-N182
T41214	0-N000
T41217	0-N160
T41221	0-N956
T41224	0-N1581
T41225	0-N1777
T41226	0-N1775
T41227	0-N2001
T41228	0-N1570
T41229	0-N1046
T41230	0-N169
T41233	0-N291
T41234	0-N821
T41235	0-N1065
T41236	0-N147
T41237	0-N2380
T41237	0-N262
T41238	0-N1336
T41239	0-N1776
T41240	0-N1173
T41241	0-N1366
T41242	0-N912
T41244	0-N1129
T41245	0-N1764
T41246	0-N968
T41247	0-N968

GATES

T41248	0-N191
T41249	0-N2320
T41250	0-N1879
T41251	0-N017
T41257	0-N126
T41258	0-N943
T41261	0-N910
T41265	0-N1781
T41267	0-N973
T41269	0-N2315
T41270	0-N959
T41271	0-N056
T41273	0-N1323
T41275	0-N1273
T41276	0-N1120
T41277	0-N1229
T41279	0-N1382
T41280	0-N1328
T41282	0-N1357
T41287	0-N1243
T41288	0-N1618
T41290	0-N1378
T41292	0-N1825
T41293	0-N891
T41295	0-N1379
T41296	0-N2225
T41302	0-N1761
T41305	0-N020
T41306	0-N1261
T41309	0-N2326
T41313	0-N1824
T41316	0-N2161
T41316	0-N2161S
T41319	0-N2322
T42000	0-N902
T42005	0-N070
T42008	0-N077
T42014	0-N1576
T42015	0-N1374
T42016	0-N1370
T42017	0-N055
T42018	0-N189
T42019	0-N1316
T42024	0-N1226
T42029	0-N008
T42031	0-N2058
T42033	0-N096
T42036	0-N904
T42039	0-N1225
T42041	0-N1911

GATES

T42042	0-N1917
T42042A	0-N1917
T42044	0-N131
T42045	0-N128
T42048	0-N1262
T42049	0-N164
T42050	0-N166
T42051	0-N167
T42053	0-N820
T42059	0-N950
T42060	0-N938
T42061	0-N951
T42065	0-N862
T42066	0-N122
T42067	0-N862
T42068	0-N814
T42069	0-N900
T42070	0-N119P
T42072	0-N945
T42073	0-N123
T42076	0-N952
T42077	0-N953
T42080	0-N909
T42081	0-N878
T42084	0-N906
T42085	0-N907
T42086	0-N957
T42088	0-N854
T42089	0-N881
T42090	0-N148
T42091	0-N1106
T42095	0-N965
T42097	0-N958
T42100	0-N014
T42106	0-N031
T42107	0-N035
T42116	0-N1380
T42121	0-N1962
T42122	0-N300
T42129	0-N061
T42130	0-N184
T42134	0-N1260
T42139	0-N1268
T42140	0-N1326
T42140	0-N2149
T42141	0-N1500
T42148	0-N1346
T42149	0-N1341
T42150	0-N2044
T42152	0-N892

GATES

T42153	0-N1239
T42155	0-N192
T42156	0-N1773
T42157	0-N163
T42158	0-N168
T42159	0-N168
T42161	0-N1381
T42162	0-N1066
T42165	0-N127
T42166	0-N1365
T42167	0-N1259
T42169	0-N1270
T42170	0-N971
T42179	0-N1350
T42180	0-N2000
T42181	0-N1354
T42182	0-N1355
T42183	0-N1352
T42184	0-N170
T42185	0-N171
T42187	0-N1122
T42188	0-N1456
T42189	0-N165
T42190	0-N1230
T42191	0-N1360
T42192	0-N1329
T42193	0-N1575
T42195	0-N146
T42196	0-N277
T42198	0-N1358
T42199	0-N1334
T42201	0-N1411
T42202	0-N1578
T42203	0-N1093
T42207	0-N1248
T42210	0-N1377
T42214	0-N1816
T42218	0-N1376
T42220	0-N1550
T42222	0-N1375
T42226	0-N1772
T42230	0-N1771
T42231	0-N2255
T42233	0-N1615
T42234	0-N164
T42304	0-N1960
T42305	0-N2025
T42306	0-N957
T42307	0-N2382
T42308	0-N2384

GATES

T42309	0-N2200
T42315	0-N1574
T43001	0-N1836
T43003	0-N1778
T43005	0-N2059
T43008	0-N1838S
T43010	0-N157
T43013	0-N1356
T43014	0-N1111
T43016	0-N1042
T43017	0-N1654
T43018	0-N1050
T43019	0-N1048
T43020	0-N1265
T43021	0-N1265
T43022	0-N1057
T43023	0-N1277
T43024	0-N196
T43025	0-N1237
T43026	0-N1275
T43027	0-N1342
T43028	0-N1051
T43028	0-N1051S
T43029	0-N1364
T43030	0-N1344
T43031	0-N1049
T43032	0-N1569
T43033	0-N194
T43035	0-N200
T43036	0-N201
T43037	0-N1232
T43038	0-N948
T43039	0-N970
T43040	0-N100
T43041	0-N103
T43042	0-N115
T43043	0-N114
T43045	0-N112
T43046	0-N106
T43047	0-N109
T43048	0-N110
T43049	0-N117
T43050	0-N1058
T43051	0-N1058
T43053	0-N101
T43054	0-N108
T43055	0-N195
T43056	0-N089
T43057	0-N107
T43058	0-N198

GATES

T43059	0-N1332
T43060	0-N102
T43061	0-N1331
T43062	0-N107
T43063	0-N1274
T43064	0-N198
T43065	0-N1236
T43066	0-N1276
T43067	0-N116
T43068	0-N208
T43069	0-N104
T43072	0-N1566
T43073	0-N1372
T43074	0-N1060
T43077	0-N1936
T43078	0-N159
T43082	0-N871
T43085	0-N112
T43087	0-N076
T43088	0-N1338
T43089	0-N1327
T43090	0-N1258
T43091	0-N1045
T43092	0-N1368
T43106	0-N1383
T43107	0-N1092
T43108	0-N1572
T43110	0-N1340
T43113	0-N1567
T43115	0-N290
T43116	0-N1367
T43117	0-N1269
T43118	0-N158
T43119	0-N1349
T43121	0-N1820
T43123	0-N130
T43124	0-N1361
T43126	0-N1112
T43127	0-N294
T43128	0-N1826
T43130	0-N2010
T43133	0-N1499
T43134	0-N1499
T43135	0-N1619
T43137	0-N1767
T43139	0-N137
T43140	0-N1263
T43141	0-N1272
T43143	0-N1347
T43144	0-N1085

GATES

T43145	0-N1343
T43147	0-N2056
T43149	0-N158
T43151	0-N1335
T43152	0-N1337
T43154	0-N1369
T43156	0-N1616
T43157	0-N1061
T43158	0-N1062
T43159	0-N1359
T43162	0-N1353
T43163	0-N1351
T43164	0-N1121
T43165	0-N1362
T43166	0-N1056
T43167	0-N2220
T43167	0-N2220S
T43168	0-N1368
T43171	0-N1564
T43172	0-N1573
T43173	0-N1324
T43174	0-N1612
T43175	0-N1330
T43178	0-N1583
T43180	0-N1760
T43181	0-N1905
T43185	0-N2012
T43186	0-N2018
T43187	0-N1617
T43193	0-N2428
T43199	0-N1613
T43200	0-N1614
T43207	0-N2060
T43211	0-N115
T43218	0-N2329
T43219	0-N2061
T43224	0-N1952
T43225	0-N2062
T43226	0-N1819
T43228	0-N2376
T43229	0-N2416
T43230	0-N2224
T43231	0-N2063
T43233	0-N1884
T43237	0-N2208
T43238	0-N1368
T43239	0-N2150
T43240	0-N2423
HUTCHINSON	
G2015	0-N1409

HUTCHINSON

G9003	0-N2429
HEG 08	0-N814
HEG 105	0-N131
HEG 109	0-N167
HEG 117	0-N008
HEG 118	0-N958
HEG 132	0-N1268
HEG 136	0-N262
HEG 137	0-N1270
HEG 144	0-N1326
HEG 144	0-N950
HEG 147	0-N1352
HEG 154	0-N1066
HEG 156	0-N1259
HEG 156	0-N1365
HEG 159	0-N1237
HEG 17	0-N881
HEG 174	0-N070
HEG 178	0-N119P
HEG 183	0-N164
HEG 187	0-N1046
HEG 189	0-N077
HEG 212	0-N1334
HEG 214	0-N1065
HEG 237	0-N031
HEG 284	0-N2380
HEG 296	0-N1226
HEG 297	0-N127
HEG 302	0-N2001
HEG 303	0-N2000
HEG 305	0-N168
HEG 308	0-N1336
HEG 309	0-N1329
HEG 311	0-N1360
HEG 312	0-N1122
HEG 313	0-N1358
HEG 320	0-N014
HEG 33	0-N900
HEG 358	0-N055
HEG 36	0-N909
HEG 362	0-N146
HEG 364	0-N1374
HEG 365	0-N1376
HEG 366	0-N1341
HEG 367	0-N1578
HEG 369	0-N1380
HEG 371	0-N1375
HEG 374	0-N1575
HEG 375	0-N1500
HEG 379	0-N1773



HUTCHINSON		HUTCHINSON		HUTCHINSON		HUTCHINSON	
HEG 38	0-N277	HTG 157	0-N1061	HTG 32	0-N901	HTG 54	0-N835
HEG 399	0-N1130	HTG 158	0-N1654	HTG 322	0-N1260	HTG 62	0-N910
HEG 40	0-N945	HTG 16	0-N806	HTG 323	0-N056	HTG 67	0-N808
HEG 407	0-N1326	HTG 160	0-N158	HTG 326	0-N1127	HTG 71	0-N102
HEG 409	0-N1316	HTG 176	0-N194	HTG 328	0-N1561	HTG 72	0-N104
HEG 410	0-N1550	HTG 18	0-N861	HTG 330	0-N1050	HTG 73	0-N103
HEG 418	0-N2382	HTG 182	0-N1263	HTG 332	0-N1836	HTG 74	0-N100
HEG 427	0-N2200	HTG 185	0-N1236	HTG 333	0-N2059	HTG 76	0-N112
HEG 43	0-N878	HTG 185	0-N130	HTG 336	0-N1817	HTG 80	0-N126
HEG 50	0-N119P	HTG 186	0-N1045	HTG 336	0-N1817S	HTG 85	0-N106
HEG 51	0-N965	HTG 190	0-N109	HTG 337	0-N1583	HTG 86	0-N903
HEG 56	0-N820	HTG 195	0-N021	HTG 342	0-N1272	HTG 96	0-N1383
HEG 60	0-N147	HTG 211	0-N1327	HTG 343	0-N1340	HTG166	0-N032
HEG 61	0-N148	HTG 211	0-N2018	HTG 344	0-N1369	HTG351	0-N1347
HEG 68	0-N128	HTG 213	0-N1057	HTG 348	0-N1337	KH 01	SK-1022
HEG 70	0-N953	HTG 213	0-N1343	HTG 349	0-N2208	KH 02	SK-1003
HEG 87	0-N904	HTG 218	0-N987	HTG 350	0-N1616	KH 03	SK-1004
HEG 88	0-N096	HTG 22	0-N871	HTG 352	0-N1378	KH 06	SK-1007
HEG 94	0-N906	HTG 225	0-N1173	HTG 353	0-N1612	KH 06WP09	SK-1007AQ1
HEG 94	0-N907	HTG 226	0-N1323	HTG 354	0-N1121	KH 07	SK-1021
HEG 95	0-N955	HTG 226	0-N2060	HTG 355	0-N1905	KH 07WP29	SK-1021AQ2
HTG 02	0-N1571	HTG 229	0-N1112	HTG 356	0-N1564	KH 08WP28	SK-1021AQ1
HTG 02	0-N173	HTG 230	0-N1276	HTG 380	0-N1879	KH 09	SK-1011
HTG 02.I	0-N1571	HTG 232	0-N1275	HTG 381	0-N2320	KH 101	SK-1487
HTG 07	0-N813	HTG 234	0-N018	HTG 383	0-N1051	KH 101WP78	SK-1487AQ3
HTG 10	0-N874	HTG 247	0-N956	HTG 383	0-N1051S	KH 113	SK-1165
HTG 107	0-N107	HTG 250	0-N160	HTG 384	0-N1129	KH 116	SK-1665
HTG 110	0-N145	HTG 261	0-N970	HTG 385	0-N181	KH 117	SK-1103
HTG 113	0-N157	HTG 263	0-N110	HTG 388	0-N1379	KH 117WP22	SK-1103AQ1
HTG 116	0-N007	HTG 265	0-N114	HTG 39	0-N944	KH 118	SK-1646
HTG 119	0-N1048	HTG 267	0-N1273	HTG 390	0-N020	KH 12	SK-1013
HTG 12	0-N822	HTG 269	0-N968	HTG 393	0-N1042	KH 12	SK-1108S
HTG 121	0-N1111	HTG 270	0-N116	HTG 396	0-N2225	KH 122	SK-1196
HTG 122	0-N894	HTG 271	0-N117	HTG 397	0-N1619	KH 123	SK-1192
HTG 123	0-N294	HTG 274	0-N129	HTG 401	0-N1567	KH 124	SK-1341
HTG 124	0-N1367	HTG 275	0-N196	HTG 403	0-N1566	KH 125	SK-1109
HTG 125	0-N999	HTG 277	0-N968	HTG 41	0-N863	KH 125WP51	SK-1507AQ1
HTG 133	0-N195	HTG 279	0-N1120	HTG 411	0-N1343	KH 126	SK-1067
HTG 135	0-N115	HTG 281	0-N1331	HTG 412	0-N2195	KH 127	SK-1338
HTG 138	0-N137	HTG 282	0-N1085	HTG 417	0-N2224	KH 127WP28	SK-1338AQ1
HTG 14	0-N862	HTG 285	0-N1335	HTG 42	0-N879	KH 129	SK-1512
HTG 141	0-N061	HTG 286	0-N1359	HTG 429	0-N1764	KH 13	SK-1020
HTG 142	0-N184	HTG 287	0-N1328	HTG 432	0-N1572	KH 130	SK-1106
HTG 145	0-N200	HTG 288	0-N1366	HTG 436	0-N1820	KH 132	SK-1088
HTG 146	0-N1351	HTG 290	0-N1368	HTG 44	0-N816	KH 132WP43	SK-1088AQ1
HTG 149	0-N1269	HTG 291	0-N1357	HTG 45	0-N821	KH 136	SK-1012
HTG 14C	0-N862	HTG 30	0-N805	HTG 46	0-N915	KH 136	SK-1107
HTG 150	0-N1274	HTG 31	0-N811	HTG 48	0-N121	KH 138	SK-1610
HTG 153	0-N1062	HTG 310	0-N1775	HTG 49	0-N118P	KH 139	SK-1412
HTG 155	0-N1277	HTG 317	0-N1338	HTG 53	0-N819	KH 140	SK-1105

HUTCHINSON

KH 145	SK-1418
KH 145WP40	SK-1418AQ1
KH 146	SK-1421
KH 146WP23	SK-1421AQ1
KH 147	SK-1394
KH 147WP60	SK-1394AQ1
KH 148	SK-1425
KH 149	SK-1623
KH 149	SK-1624
KH 150	SK-1583
KH 150WP56	SK-1583AQ2
KH 150WP79	SK-1583AQ2
KH 151	SK-1493
KH 151WP55	SK-1493AQ1
KH 152	SK-1355
KH 152WP74	SK-1355AQ2
KH 153	SK-1489
KH 154	SK-1491
KH 155	SK-1707
KH 156	SK-1041
KH 157	SK-1388
KH 157	SK-1582
KH 158	SK-1113
KH 158WP19	SK-1113AQ1
KH 159	SK-1112
KH 159	SK-1629
KH 159WP54	SK-1629AQ1
KH 16	SK-1031
KH 160	SK-1110
KH 160	SK-1258
KH 160	SK-1259
KH 161	SK-1353
KH 161WP48	SK-1353AQ1
KH 162	SK-1494
KH 163	SK-1511
KH 164	SK-1392
KH 165	SK-1577
KH 166	SK-1337
KH 168	SK-1166
KH 17	SK-1026
KH 171	SK-1354
KH 171WP48	SK-1354AQ1
KH 172	SK-1101
KH 18	SK-1001
KH 180	SK-1343
KH 182	SK-1224
KH 184	SK-1410
KH 184WP25	SK-1410AQ1
KH 186	SK-1391
KH 187	SK-1642

HUTCHINSON

KH 189	SK-1534
KH 19	SK-1023
KH 190	SK-1424
KH 190WP64	SK-1424AQ1
KH 193	SK-1346
KH 194	SK-1372
KH 194WP56	SK-1706AQ1
KH 195	SK-1306
KH 197	SK-1609
KH 197WP60	SK-1609AQ1
KH 20	SK-1029
KH 21	SK-1041
KH 22	SK-1012
KH 22	SK-1705
KH 225	SK-1594
KH 225WP60	SK-1594AQ1
KH 227	SK-1482
KH 227	SK-1596
KH 227WP49	SK-1596AQ1
KH 227WP77	SK-1596AQ1
KH 228	SK-1260
KH 229	SK-1522
KH 23	SK-1040
KH 235	SK-1580
KH 236	SK-1486
KH 236WP65	SK-1486AQ1
KH 239	SK-1340
KH 23WP17	SK-1040AQ1
KH 240	SK-1339
KH 243	SK-1273
KH 245	SK-1612
KH 247	SK-1481
KH 248	SK-1508
KH 25	SK-1019
KH 252	SK-1631
KH 253	SK-1624
KH 254	SK-1084
KH 255	SK-1114
KH 256	SK-1630
KH 260	SK-1376
KH 261	SK-1526
KH 263	SK-1378
KH 265	SK-1633
KH 266	SK-1619
KH 267	SK-1595
KH 267WP56	SK-1595AQ1
KH 268	SK-1592
KH 27	SK-1034
KH 271	SK-1638
KH 273	SK-1361

HUTCHINSON

KH 273WP25	SK-1361AQ1
KH 281	SK-1615
KH 281WP37	SK-1615AQ1
KH 283	SK-1617
KH 283WP60	SK-1617AQ1
KH 284	SK-1614
KH 284WP60	SK-1614AQ1
KH 288	SK-1533
KH 289	SK-1450
KH 292	SK-1501
KH 293	SK-1529
KH 297	SK-1075
KH 298	SK-1589
KH 301	SK-1627
KH 304	SK-1277
KH 309	SK-1288
KH 310	SK-1436
KH 315	SK-1245
KH 317	SK-1335
KH 318	SK-1719
KH 319	SK-1712
KH 32	SK-1036
KH 320	SK-1439
KH 321	SK-1634
KH 322	SK-1626
KH 323	SK-1598
KH 327	SK-1144
KH 328	SK-1586
KH 33	SK-1108
KH 330	SK-1367
KH 330	SK-1602
KH 332	SK-1599
KH 333WP73	SK-1724AQ2
KH 335	SK-1640
KH 336	SK-1621
KH 337	SK-1597
KH 338	SK-1685
KH 341	SK-1183
KH 343	SK-1673
KH 348	SK-1144
KH 350	SK-1483
KH 352	SK-1659
KH 355	SK-1378
KH 356	SK-1748
KH 357	SK-1750
KH 358	SK-1430
KH 360	SK-1590
KH 361	SK-1654
KH 362	SK-1654
KH 364	SK-1656

HUTCHINSON

KH 366	SK-1653
KH 367	SK-1716
KH 37	SK-1043
KH 384	SK-1671
KH 386	SK-1674
KH 387	SK-1221
KH 389	SK-1316
KH 391	SK-1460
KH 392	SK-1753
KH 394	SK-1470
KH 397	SK-1458
KH 40	SK-1092
KH 403	SK-1476
KH 409	SK-1607
KH 41	SK-1091
KH 410	SK-1632
KH 411	SK-1586
KH 411WP72	SK-1586AQ1
KH 412	SK-1611
KH 418	SK-1660
KH 419	SK-1635
KH 422	SK-1693
KH 424	SK-1564
KH 425	SK-1519
KH 427	SK-1752
KH 43	SK-1168
KH 430	SK-1686
KH 431	SK-1668
KH 437	SK-1507
KH 438	SK-1270
KH 445	SK-1367
KH 446	SK-1112
KH 446	SK-1629
KH 446	SK-1696
KH 446WP54	SK-1629AQ1
KH 447	SK-1600
KH 448WP68	SK-1727AQ2
KH 449	SK-1608
KH 450	SK-1728
KH 452	SK-1714
KH 453	SK-1698
KH 456	SK-1586
KH 46	SK-1082
KH 462	SK-1727
KH 462WP68	SK-1727AQ1
KH 463	SK-1754
KH 465	SK-1646
KH 469	SK-1481
KH 47	SK-1120
KH 48	SK-1081



HUTCHINSON

KH 493WP54	SK-1696AQ1
KH 51	SK-1035
KH 51	SK-1680
KH 52	SK-1046
KH 54	SK-1038
KH 54WP50	SK-1038AQ1
KH 55	SK-1096
KH 57	SK-1098
KH 58	SK-1069
KH 59	SK-1164
KH 60	SK-1162
KH 60WP02	SK-1162AQ1
KH 61	SK-1027
KH 62	SK-1032
KH 63	SK-1033
KH 64	SK-1042
KH 64WP70	SK-1042AQ2
KH 65	SK-1078
KH 70	SK-1085
KH 71	SK-1084
KH 72WP31	SK-1086AQ1
KH 74	SK-1090
KH 76	SK-1014
KH 77	SK-1111
KH 77	SK-1259
KH 81	SK-1053
KH 82	SK-1073
KH 88	SK-1074
KH 89	SK-1114
KH 89	SK-1663
KH 90	SK-1122
KH 91	SK-1153
KH 94	SK-1094
KH 96	SK-1100
KH 97	SK-1060
KH 98	SK-1169
KH 98WP21	SK-1169AQ1
KH 99	SK-1131
KH 99WP33	SK-1592AQ1
KH04	SK-1005
KH05	SK-1006
KH08	SK-1010
KH10	SK-1015
KH100	SK-1064
KH102	SK-1188
KH103	SK-1344
KH105	SK-1061
KH108	SK-1059
KH109	SK-1024
KH112	SK-1163

HUTCHINSON

KH114	SK-1089
KH115	SK-1172
KH118	SK-1080
KH119	SK-1345
KH131	SK-1236
KH134	SK-1150
KH135	SK-1158
KH141	SK-1399
KH147	SK-1394
KH15	SK-1018S
KH174	SK-1062
KH176	SK-1242
KH179	SK-1066
KH183	SK-1226
KH28	SK-1017
KH29	SK-1039
KH30	SK-1037
KH42	SK-1016
KH44	SK-1093
KH45	SK-1159
KH46WP27	SK-1082AQ1
KH53	SK-1129
KH56	SK-1095
KH66	SK-1045
KH67	SK-1141
KH68	SK-1049
KH69	SK-1052
KH72	SK-1086
KH75	SK-1047
KH76	SK-1063
KH78	SK-1087
KH80	SK-1140
KH83	SK-1123
KH84	SK-1154
KH85	SK-1076
KH86	SK-1157
KH87	SK-1097
KH87	SK-1662
KH95	SK-1119
KT 1521 W1	SK-1598AQ1
T0006	0-N149
T0011	0-N1298
T0012	0-N847
T0018	0-N1717
T0018	0-N1717S
T0019	0-N1416
T0020	0-N2349
T0021	0-N1485
T0021	0-N1485S
T0024	0-N1730

HUTCHINSON

T0026	0-N1681
T0030	0-N1752
T0031	0-N187
T0036	0-N1041
T0036	0-N1041S
T0037	0-N1538
T0037	0-N1538S
T0038	0-N1494
T0038	0-N1494S
T0039	0-N1822
T0039	0-N1822S
T0041	0-N2047
T0049	0-N1620
T0049	0-N1620S
T0050	0-N1713
T0056	0-N1736
T0057	0-N2213
T0057	0-N2213S
T0058	0-N2085
T0058	0-N2085S
T0059	0-N2214
T0059	0-N2214S
T0060	0-N2089
T0060	0-N2089S
T0061	0-N2088
T0061	0-N2088S
T0064	0-N1523
T0065	0-N2217
T0065	0-N2217S1
T0065	0-N2217S2
T0066	0-N2216
T0066	0-N2216S1
T0066	0-N2216S2
T0067	0-N2422
T0067	0-N2422S
T0070	0-N1875
T0070	0-N1875S
T0073	0-N2084
T0073	0-N2084S
T0076	0-N1958
T0076	0-N1958S
T0080	0-N2038
T0080	0-N2038S
T0081	0-N2040
T0084	0-N2064
T0200	0-N1407
T0200	0-N1407S
T0201	0-N1484
T0201	0-N1484S
T0207	0-N1394

HUTCHINSON

T0208	0-N1487
T0208	0-N1487S
T0209	0-N1303
T0212	0-N133
T0215	0-N1419
T0216	0-N1471
T0216	0-N1471S
T0218	0-N1493
T0218	0-N1493S
T0219	0-N1748
T0221	0-N1339
T0221	0-N1339S
T0224	0-N1722
T0227	0-N2174
T0228	0-N2152
T0229	0-N2153
T0232	0-N1421
T0233	0-N095
T0234	0-N1711S
T0235	0-N1450
T0238	0-N1589
T0238	0-N2222
T0239	0-N1721
T0241	0-N1314
T0244	0-N1671
T0244	0-N1671S
T0246	0-N1738
T0248	0-N1445
T0248	0-N1445S
T0249	0-N1539
T0249	0-N1539S
T0252	0-N1459
T0252	0-N1459S
T0255	0-N1432
T0256	0-N1704
T0256	0-N1704S
T0258	0-N1454
T0259	0-N1733
T0259	0-N1733S
T0280	0-N1398
T0284	0-N1503
T0284	0-N1503S
T0285	0-N1526
T0285	0-N1526S
T0288	0-N1672
T0290	0-N1749
T0290	0-N1749S
T0292	0-N1446
T0294	0-N1413
T0297	0-N1624

HUTCHINSON		HUTCHINSON		HUTCHINSON		INA	
T0297	0-N1624S	T0380	0-N1425	T1008	0-N1472S	530 0016 10	SK-1004
T0298	0-N1673	T0381	0-N1558S	T1009	0-N1486	530 0016 30	SK-1004AQ1
T0298	0-N1673S	T0384	0-N2096	T1009	0-N1486S	530 0017 10	SK-1064
T0299	0-N1712	T0384	0-N2096S	T1015	0-N2172	530 0018 10	SK-1021
T0300	0-N1756	T0385	0-N1554	T1015	0-N2172S	530 0018 30	SK-1021AQ2
T0301	0-N2154	T0385	0-N1554S	T1033	0-N1473	530 0018 31	SK-1021AQ1
T0302	0-N1682	T0389	0-N1953	T1033	0-N1473S	530 0019 10	SK-1006
T0304	0-N1750	T0389	0-N1953S	T2007	0-N152	530 0020 10	SK-1037
T0306	0-N2037	T0391	0-N1659	T2007	0-N152S	530 0024 10	SK-1154
T0306	0-N2037S	T0391	0-N1659S	T2013	0-N1470	530 0034 10	SK-1010
T0310	0-N1897	T0394	0-N1857	T2013	0-N1470S	530 0038 10	SK-1084
T0310	0-N1897S	T0394	0-N1857S	T2017	0-N1488	530 0039 10	SK-1165
T0316	0-N1639	T0396	0-N1758	T2017	0-N1488S	530 0040 10	SK-1108S
T0316	0-N1639S	T0399	0-N1641	T2036	0-N1469	530 0041 10	SK-1171
T0321	0-N1588	T0399	0-N1641S	T2050	0-N1804	530 0042 10	SK-1015
T0321	0-N1588S	T0400	0-N1703	T2050	0-N1804S	530 0043 10	SK-1010
T0322	0-N1392	T0405	0-N1290	T2056	0-N1804	530 0044 10	SK-1103
T0327	0-N1896	T0405	0-N1290S	T2056	0-N1804S	530 0044 30	SK-1103AQ1
T0327	0-N1896S	T0409	0-N1291	T3001	0-N2411	530 0045 10	SK-1260
T0328	0-N1895	T0409	0-N1291S	T4006	0-N2170	530 0046 10	SK-1060
T0328	0-N1895S	T0411	0-N1505S	T4006	0-N2170S	530 0047 10	SK-1168
T0330	0-N1845	T0412	0-N1396	T6023	0-N1599	530 0048 10	SK-1522
T0330	0-N1845S	T0414	0-N1492	T6023	0-N1599S	530 0049 10	SK-1100
T0334	0-N1719	T0414	0-N1492S	TS1407	0-N1747	530 0049 30	SK-1100AQ1
T0334	0-N1719S	T0420	0-N2103			530 0051 10	SK-1205
T0335	0-N1665	T0420	0-N2103S			530 0052 10	SK-1095
T0340	0-N1957	T0421	0-N2104			530 0053 10	SK-1236
T0340	0-N1957S	T0421	0-N2104S	15-4069	0-N2392	530 0054 10	SK-1164
T0344	0-N1410	T0422	0-N1521	15-4069	0-N2392S	530 0056 10	SK-1063
T0344	0-N1410S	T0423	0-N2105	530 00 0931	SK-1665AQ2	530 0057 10	SK-1069
T0345	0-N1439	T0423	0-N2105S	530 0001 10	SK-1026	530 0058 10	SK-1087
T0348	0-N1464	T0424	0-N1677	530 0001 10	SK-1090	530 0059 10	SK-1086
T0348	0-N1464S	T0424	0-N1677S	530 0002 10	SK-1001	530 0060 10	SK-1110
T0349	0-N1466	T0425	0-N1815	530 0003 10	SK-1029	530 0063 10	SK-1491
T0349	0-N1466S	T0425	0-N1815S	530 0004 10	SK-1162	530 0063 30	SK-1491AQ1
T0351	0-N1437	T0427	0-N1876	530 0004 30	SK-1162AQ1	530 0063 30	SK-1491AQ1
T0355	0-N1649	T0427	0-N1876S	530 0004 31	SK-1162AQ2	530 0064 10	SK-1096
T0356	0-N1799	T0428	0-N2182	530 0004 32	SK-1162AQ3	530 0064 30	SK-1096AQ1
T0356	0-N1799S	T0428	0-N2182S	530 0005 10	SK-1041	530 0065 10	SK-1339
T0357	0-N1798	T0431	0-N1483	530 0007 10	SK-1059	530 0066 10	SK-1340
T0357	0-N1798S	T0431	0-N1483S	530 0009 10	SK-1023	530 0067 10	SK-1660
T0358	0-N1438	T0432	0-N1714	530 0009 10	SK-1665	530 0067 30	SK-1660AQ1
T0358	0-N1438S	T0432	0-N1714S	530 0009 30	SK-1665AQ1	530 0069 10	SK-1346
T0362	0-N150	T0432	0-N1714S	530 0010 10	SK-1042	530 0070 10	SK-1638
T0363	0-N139	T0434	0-N174	530 0010 10	SK-1042AQ2	530 0072 10	SK-1054
T0368	0-N2179	T0442	0-N1720	530 0011 10	SK-1007	530 0073 10	SK-1045
T0374	0-N1664	T0442	0-N1720S	530 0011 30	SK-1007AQ1	530 0073 10	SK-1045
T0374	0-N1664S	T0443	0-N1627	530 0012 10	SK-1003	530 0074 10	SK-1033
T0378	0-N1626	T0443	0-N1627S	530 0012 30	SK-1003AQ1	530 0075 10	SK-1163
T0378	0-N1626S	T1003	0-N2175	530 0013 10	SK-1024	530 0076 10	SK-1017
		T1008	0-N1472	530 0014 10	SK-1027	530 0076 30	SK-1017AQ1
				530 0015 10	SK-1012	530 0077 10	SK-1355



INA		INA		INA		INA	
530 0078 10	SK-1073	530 0117 10	SK-1035	530 0174 10	SK-1512	530 0209 10	SK-1138
530 0078 30	SK-1073AQ1	530 0118 10	SK-1032	530 0175 10	SK-1725	530 0211 10	SK-1050
530 0078 31	SK-1073AQ2	530 0119 10	SK-1040	530 0175 30	SK-1529AQ1	530 0212 10	SK-1445
530 0078 32	SK-1073AQ3	530 0119 30	SK-1040AQ1	530 0175 30	SK-1725AQ1	530 0213 10	SK-1155
530 0079 10	SK-1038	530 0133 10	SK-1053	530 0176 10	SK-1388	530 0214 10	SK-1150
530 0079 30	SK-1038AQ1	530 0134 10	SK-1039	530 0177 10	SK-1378	530 0217 10	SK-1142
530 0080 10	SK-1158	530 0136 10	SK-1160	530 0177 30	SK-1378AQ1	530 0218 10	SK-1151
530 0081 10	SK-1068	530 0138 10	SK-1052	530 0178 10	SK-1383	530 0219 10	SK-1449
530 0081 10	SK-1068S	530 0140 10	SK-1077	530 0178 30	SK-1383AQ1	530 0221 10	SK-1345
530 0081 10	SK-1097	530 0142 10	SK-1341	530 0179 10	SK-1377	530 0222 10	SK-1076
530 0082 10	SK-1258	530 0143 10	SK-1049	530 0179 31	SK-1377AQ1	530 0223 10	SK-1361
530 0082 30	SK-1258AQ1	530 0144 10	SK-1351	530 0180 10	SK-1640	530 0223 30	SK-1361AQ1
530 0083 10	SK-1210	530 0145 10	SK-1056	530 0182 10	SK-1081	530 0224 10	SK-1154
530 0084 10	SK-1080	530 0146 10	SK-1478	530 0182 30	SK-1081AQ2	530 0225 10	SK-1410
530 0085 10	SK-1098	530 0147 10	SK-1169	530 0183 10	SK-1707	530 0225 30	SK-1410AQ1
530 0086 10	SK-1106	530 0148 10	SK-1508	530 0184 10	SK-1099	530 0226 10	SK-1415
530 0089 10	SK-1511	530 0149 10	SK-1120	530 0185 10	SK-1108	530 0227 10	SK-1365
530 0089 30	SK-1511AQ2	530 0150 10	SK-1026	530 0187 10	SK-1092	530 0227 10	SK-1697
530 0089 31	SK-1511AQ1	530 0150 10	SK-1090	530 0188 10	SK-1091	530 0227 30	SK-1697AQ1
530 0090 10	SK-1583	530 0152 10	SK-1129	530 0189 10	SK-1014	530 0228 10	SK-1412
530 0090 30	SK-1583AQ1	530 0153 10	SK-1578	530 0190 10	SK-1093	530 0228 30	SK-1412AQ2
530 0091 10	SK-1582	530 0153 30	SK-1578AQ1	530 0191 10	SK-1338	530 0229 10	SK-1411
530 0091 30	SK-1372AQ1	530 0154 10	SK-1047	530 0191 30	SK-1338AQ1	530 0230 10	SK-1637
530 0091 30	SK-1582AQ2	530 0155 10	SK-1123	530 0191 31	SK-1338AQ2	530 0231 10	SK-1446
530 0092 10	SK-1088	530 0156 10	SK-1126	530 0192 10	SK-1494	530 0232 10	SK-1610
530 0092 30	SK-1088AQ1	530 0156 10	SK-1126AQ1	530 0193 10	SK-1623	530 0233 10	SK-1079
530 0094 10	SK-1440	530 0157 10	SK-1119	530 0194 10	SK-1490	530 0234 10	SK-1394
530 0095 10	SK-1082	530 0158 10	SK-1343	530 0195 10	SK-1486	530 0234 30	SK-1394AQ1
530 0096 10	SK-1022	530 0158 30	SK-1343AQ1	530 0195 30	SK-1486AQ1	530 0235 10	SK-1534
530 0096 30	SK-1022AQ2	530 0159 10	SK-1101	530 0196 10	SK-1493	530 0235 30	SK-1534AQ1
530 0099 10	SK-1657	530 0161 10	SK-1376	530 0196 30	SK-1493AQ1	530 0236 10	SK-1399
530 0100 10	SK-1140	530 0161 30	SK-1376AQ1	530 0197 10	SK-1487	530 0237 10	SK-1392
530 0102 10	SK-1094	530 0162 10	SK-1026	530 0197 30	SK-1487AQ1	530 0237 30	SK-1392AQ1
530 0103 10	SK-1034	530 0162 10	SK-1090	530 0197 31	SK-1487AQ2	530 0238 10	SK-1393
530 0104 10	SK-1078	530 0163 10	SK-1120	530 0198 10	SK-1489	530 0238 10	SK-1482
530 0104 30	SK-1078AQ3	530 0164 10	SK-1122	530 0199 10	SK-1592	530 0238 30	SK-1482AQ1
530 0104 31	SK-1078AQ1	530 0165 10	SK-1344	530 0199 30	SK-1592AQ1	530 0239 10	SK-1391
530 0105 10	SK-1005	530 0166 10	SK-1131	530 0200 10	SK-1121	530 0239 30	SK-1391AQ1
530 0106 10	SK-1157	530 0166 30	SK-1131AQ1	530 0201 10	SK-1372	530 0240 10	SK-1065
530 0107 10	SK-1011	530 0166 31	SK-1131AQ2	530 0201 30	SK-1372AQ1	530 0241 10	SK-1072
530 0108 10	SK-1036	530 0167 10	SK-1074	530 0201 31	SK-1372AQ2	530 0242 10	SK-1067
530 0109 10	SK-1306	530 0167 30	SK-1074AQ1	530 0201 31	SK-1372AQ3	530 0244 10	SK-1500
530 0111 10	SK-1085	530 0168 10	SK-1130	530 0201 32	SK-1372AQ2	530 0245 10	SK-1102
530 0111 30	SK-1085AQ1	530 0170 10	SK-1660	530 0203 10	SK-1031	530 0247 10	SK-1501
530 0112 10	SK-1046	530 0170 10	SK-1710	530 0204 10	SK-1043	530 0248 10	SK-1061
530 0113 10	SK-1153	530 0171 10	SK-1109	530 0204 30	SK-1043AQ1	530 0249 10	SK-1172
530 0114 10	SK-1144	530 0171 30	SK-1109AQ2	530 0205 10	SK-1421	530 0250 10	SK-1270
530 0115 10	SK-1016	530 0171 31	SK-1109AQ1	530 0205 30	SK-1421AQ1	530 0251 10	SK-1174
530 0116 10	SK-1112	530 0172 30	SK-1380AQ1	530 0206 10	SK-1418	530 0252 10	SK-1020
530 0116 30	SK-1112AQ1	530 0173 10	SK-1380	530 0206 30	SK-1418AQ1	530 0252 30	SK-1020AQ1

INA		INA		INA		INA	
530 0253 10	SK-1018S	530 0310 10	SK-1066	530 0360 30	SK-1585AQ1	530 0433 30	SK-1629AQ1
530 0257 10	SK-1159	530 0311 10	SK-1211	530 0361 10	SK-1110	530 0434 10	SK-1646
530 0258 10	SK-1019	530 0312 10	SK-1213	530 0361 10	SK-1259	530 0434 30	SK-1646AQ1
530 0259 10	SK-1483	530 0313 10	SK-1288	530 0362 10	SK-1013	530 0435 10	SK-1696
530 0260 10	SK-1202	530 0313 30	SK-1288AQ1	530 0363 10	SK-1624	530 0435 30	SK-1696AQ1
530 0261 10	SK-1203	530 0314 10	SK-1277	530 0363 30	SK-1624AQ1	530 0436 10	SK-1586
530 0264 10	SK-1068	530 0316 10	SK-1220	530 0366 10	SK-1386	530 0436 30	SK-1586AQ1
530 0264 10	SK-1662	530 0317 10	SK-1220	530 0367 10	SK-1121	530 0436 30	SK-1587AQ1
530 0265 10	SK-1476	530 0318 10	SK-1216	530 0368 10	SK-1609	530 0437 10	SK-1587
530 0266 10	SK-1192	530 0319 10	SK-1327	530 0368 30	SK-1609AQ1	530 0438 10	SK-1602
530 0267 10	SK-1075	530 0320 10	SK-1248	530 0369 10	SK-1577	530 0439 10	SK-1367
530 0268 10	SK-1186	530 0321 10	SK-1246	530 0370 10	SK-1642	530 0440 10	SK-1086
530 0269 10	SK-1062	530 0322 10	SK-1564	530 0372 10	SK-1070	530 0440 30	SK-1086AQ1
530 0270 10	SK-1188	530 0323 10	SK-1245	530 0373 10	SK-1478	530 0441 10	SK-1355
530 0270 10	SK-1195	530 0324 10	SK-1519	530 0373 10	SK-1632	530 0441 30	SK-1355AQ2
530 0271 10	SK-1189	530 0325 10	SK-1249	530 0374 10	SK-1599	530 0441 31	SK-1355AQ1
530 0273 10	SK-1275	530 0326 10	SK-1257	530 0374 30	SK-1599AQ1	530 0442 10	SK-1580
530 0274 10	SK-1196	530 0328 10	SK-1658	530 0375 10	SK-1424	530 0442 30	SK-1580AQ1
530 0275 10	SK-1224	530 0329 10	SK-1335	530 0375 30	SK-1424AQ1	530 0443 10	SK-1113
530 0276 10	SK-1453	530 0330 10	SK-1656	530 0376 10	SK-1504	530 0443 30	SK-1113AQ1
530 0277 10	SK-1222	530 0331 10	SK-1320	530 0377 10	SK-1425	530 0443 30	SK-1355AQ3
530 0278 10	SK-1221	530 0332 10	SK-1273	530 0378 10	SK-1706	530 0443 31	SK-1113AQ2
530 0279 10	SK-1457	530 0332 30	SK-1273AQ2	530 0379 10	SK-1615	530 0444 10	SK-1667
530 0280 10	SK-1231	530 0333 10	SK-1171	530 0379 30	SK-1615AQ1	530 0445 32	SK-1724AQ2
530 0281 10	SK-1226	530 0334 10	SK-1353	530 0380 10	SK-1444	530 0446 10	SK-1614
530 0282 10	SK-1227	530 0334 30	SK-1353AQ1	530 0389 10	SK-1104	530 0447 10	SK-1617
530 0283 10	SK-1228	530 0335 10	SK-1354	530 0391 10	SK-1124	530 0449 10	SK-1594
530 0284 10	SK-1223	530 0335 30	SK-1354AQ1	530 0392 10	SK-1261	530 0449 30	SK-1594AQ1
530 0285 10	SK-1225	530 0338 10	SK-1481	530 0405 10	SK-1595	530 0450 10	SK-1607
530 0286 10	SK-1671	530 0339 10	SK-1603	530 0405 30	SK-1595AQ1	530 0451 10	SK-1611
530 0287 10	SK-1185	530 0340 10	SK-1604	530 0406 10	SK-1648	530 0452 10	SK-1688
530 0288 10	SK-1242	530 0342 10	SK-1631	530 0407 10	SK-1360	530 0453 10	SK-1183
530 0290 10	SK-1234	530 0343 10	SK-1593	530 0407 30	SK-1360AQ1	530 0453 30	SK-1183AQ1
530 0291 10	SK-1309S	530 0344 10	SK-1337	530 0409 10	SK-1661	530 0454 10	SK-1436
530 0292 10	SK-1321	530 0344 10	SK-1709	530 0415 10	SK-1630	530 0455 10	SK-1625
530 0296 10	SK-1240	530 0345 10	SK-1337	530 0415 30	SK-1630AQ1	530 0456 10	SK-1673
530 0297 10	SK-1463	530 0345 30	SK-1337AQ1	530 0416 10	SK-1375	530 0457 10	SK-1674
530 0298 10	SK-1310	530 0346 10	SK-1080	530 0416 10	SK-1619	530 0462 10	SK-1677
530 0299 10	SK-1240	530 0347 10	SK-1664	530 0416 31	SK-1619AQ2	530 0462 30	SK-1677AQ1
530 0299 10	SK-1240S	530 0348 10	SK-1502	530 0419 10	SK-1598	530 0463 10	SK-1668
530 0300 10	SK-1237	530 0349 10	SK-1265	530 0419 30	SK-1598AQ1	530 0463 30	SK-1668AQ1
530 0300 10	SK-1237S	530 0350 10	SK-1469	530 0421 10	SK-1618	530 0467 30	SK-1492AQ1
530 0302 10	SK-1316	530 0355 10	SK-1626	530 0422 10	SK-1589	530 0468 10	SK-1666
530 0303 10	SK-1323	530 0356 10	SK-1184	530 0422 30	SK-1589AQ1	530 0469 10	SK-1675
530 0304 10	SK-1313S	530 0357 10	SK-1620	530 0425 10	SK-1653	530 0470 10	SK-1085
530 0305 10	SK-1308	530 0358 10	SK-1644	530 0426 10	SK-1712	530 0471 10	SK-1600
530 0306 10	SK-1237	530 0358 31	SK-1644AQ1	530 0427 10	SK-1634	530 0472 10	SK-1613
530 0307 10	SK-1325	530 0359 10	SK-1638	530 0428 10	SK-1439	530 0473 10	SK-1663
530 0308 10	SK-1314	530 0360 10	SK-1259	530 0430 10	SK-1669	530 0475 10	SK-1742
530 0309 10	SK-1322	530 0360 10	SK-1585	530 0433 10	SK-1629	530 0476 10	SK-1675



INA		INA		INA		INA	
530 0477 10	SK-1674	530 0538 10	SK-1511	530 0622 30	SK-1629AQ1	531 0039 10	0-N1682
530 0478 10	SK-1687	530 0539 10	SK-1621	530 0623 10	SK-1646	531 0041 10	0-N871
530 0479 10	SK-1538	530 0539 10	SK-1633	530 0623 30	SK-1646AQ1	531 0044 10	0-N815
530 0480 10	SK-1601	530 0539 30	SK-1621AQ1	530 0624 10	SK-1696	531 0045 10	0-N811
530 0481 10	SK-1597	530 0540 10	SK-1458	530 0624 30	SK-1696AQ1	531 0047 10	0-N943
530 0482 10	SK-1686	530 0541 10	SK-1531	530 0625 10	SK-1587	531 0048 10	0-N901
530 0482 30	SK-1686AQ1	530 0542 10	SK-1654	530 0626 10	SK-1602	531 0049 10	0-N944
530 0483 10	SK-1526	530 0543 10	SK-1717	530 0627 10	SK-1367	531 0050 10	0-N877
530 0483 30	SK-1526AQ1	530 0543 30	SK-1717AQ1	530 0629 10	SK-1735	531 0051 20	0-N185
530 0484 10	SK-1529	530 0545 10	SK-1278	530 0651 10	SK-1734	531 0052 20	0-N879
530 0485 10	SK-1671	530 0546 10	SK-1726	530008110+53002641	SK-1068	531 0053 20	0-N1071
530 0487 10	SK-1678	530 0550 10	SK-1695	530009630	SK-1022AQ2	531 0054 30	0-N100
530 0488 10	SK-1627	530 0550 10	SK-1727	530017310+53000501	SK-1539	531 0055 10	0-N863
530 0489 10	SK-1692	530 0551 10	SK-1521	530029710+53002981	SK-1463	531 0056 10	0-N859
530 0489 30	SK-1692AQ1	530 0554 10	SK-1715	530029810+53002991	SK-1311	531 0061 10	0-N173
530 0490 10	SK-1338	530 0556 10	SK-1702	530029910+53002961	SK-1240	531 0063 10	0-N805
530 0491 10	SK-1612	530 0558 10	SK-1714	530030010+53003061	SK-1237	531 0064 10	0-N880
530 0492 10	SK-1689	530 0561 10	SK-1693	530030310+53002981	SK-1323	531 0066 10	0-N139
530 0494 10	SK-1481	530 0561 30	SK-1693AQ1	530030610+53003001	SK-1312	531 0072 10	0-N883
530 0495 10	SK-1659	530 0562 10	SK-1586	530031610+53003171	SK-1220	531 0073 10	0-N887
530 0495 30	SK-1659AQ1	530 0562 30	SK-1586AQ1	531 0001 10	0-N809	531 0074 10	0-N856
530 0500 10	SK-1635	530 0563 10	SK-1719	531 0002 10	0-N954	531 0075 10	0-N894
530 0503 10	SK-1694	530 0563 10	SK-1721	531 0004 10	0-N1295	531 0077 10	0-N897
530 0503 30	SK-1694AQ1	530 0564 10	SK-1676	531 0004 10	0-N1295S	531 0079 10	0-N806
530 0503 31	SK-1694AQ2	530 0566 10	SK-1670	531 0005 10	0-N822	531 0082 20	0-N922
530 0504 10	SK-1608	530 0567 10	SK-1750	531 0006 10	0-N818	531 0083 10	0-N808
530 0505 10	SK-1591	530 0568 10	SK-1747	531 0009 10	0-N826	531 0084 20	0-N940
530 0506 10	SK-1590	530 0572 10	SK-1723	531 0011 20	0-N823	531 0085 10	0-N921
530 0507 10	SK-1639	530 0573 10	SK-1652	531 0012 20	0-N819	531 0086 10	0-N917
530 0508 10	SK-1475	530 0576 10	SK-1684	531 0013 20	0-N850	531 0087 20	0-N919
530 0509 10	SK-1716	530 0577 10	SK-1732	531 0014 20	0-N832	531 0088 10	0-N920
530 0510 10	SK-1187	530 0577 30	SK-1732AQ1	531 0015 20	0-N835	531 0089 10	0-N860
530 0512 10	SK-1713	530 0578 10	SK-1728	531 0017 20	0-N191	531 0090 10	0-N930
530 0514 10	SK-1430	530 0578 30	SK-1728AQ1	531 0020 10	0-N837	531 0091 10	0-N958
530 0515 10	SK-1097	530 0579 10	SK-1698	531 0021 10	0-N903	531 0093 20	0-N800
530 0516 10	SK-1097	530 0580 10	SK-1596	531 0022 10	0-N838	531 0094 20	0-N801
530 0517 10	SK-1250	530 0581 10	SK-1552	531 0023 10	0-N874	531 0095 10	0-N1306
530 0518 10	SK-1470	530 0582 10	SK-1608	531 0024 10	0-N155	531 0096 10	0-N124
530 0519 10	SK-1678	530 0584 10	SK-1724	531 0025 10	0-N839	531 0097 10	0-N931
530 0520 10	SK-1685	530 0585 10	SK-1720	531 0027 10	0-N842	531 0099 10	0-N898
530 0520 30	SK-1685AQ1	530 0586 30	R-1190AQ1	531 0028 10	0-N156	531 0101 30	0-N948
530 0521 10	SK-1107	530 0594 10	SK-1736	531 0029 20	0-N915	531 0102 20	0-N912
530 0522 10	SK-1721	530 0594 10	SK-1737	531 0030 10	0-N811	531 0103 20	0-N160
530 0524 10	SK-1703	530 0603 10	SK-1681	531 0031 10	0-N861	531 0104 20	0-N983
530 0526 10	SK-1754	530 0604 30	SK-1704AQ1	531 0032 10	0-N812	531 0106 20	0-N069
530 0527 10	SK-1690	530 0607 10	SK-1730	531 0033 10	0-N869	531 0107 20	0-N071
530 0529 10	SK-1289	530 0620 10	SK-1112	531 0034 10	0-N813	531 0108 20	0-N073
530 0531 10	SK-1682	530 0620 30	SK-1112AQ1	531 0035 10	0-N814	531 0109 20	0-N969
530 0532 10	SK-1274	530 0621 10	SK-1080	531 0036 10	0-N870	531 0112 20	0-N973
530 0536 10	SK-1691	530 0622 10	SK-1629	531 0038 10	0-N849	531 0113 20	0-N974

INA		INA		INA		INA	
531 0113 30	0-N974	531 0174 20	0-N988	531 0238 10	0-N133	531 0323 10	0-N1640
531 0114 10	0-N072	531 0175 20	0-N990	531 0239 10	0-N2015	531 0323 10	0-N1640S
531 0114 20	0-N072	531 0176 20	0-N992	531 0241 10	0-N125	531 0327 10	0-N882
531 0116 10	0-N1712	531 0177 20	0-N993	531 0241 10	0-N125S	531 0329 10	0-N1273
531 0117 20	0-N092	531 0178 20	0-N995	531 0242 20	0-N910	531 0330 10	0-N237
531 0118 20	0-N975	531 0179 20	0-N997	531 0243 10	0-N121	531 0331 10	0-N1256
531 0119 20	0-N986	531 0180 20	0-N998	531 0247 10	0-N2349	531 0332 20	0-N180
531 0120 20	0-N054	531 0181 20	0-N999	531 0250 10	0-N913	531 0335 10	0-N2332
531 0121 20	0-N179	531 0182 20	0-N000	531 0251 30	0-N104	531 0337 10	0-N132
531 0122 10	0-N959	531 0183 20	0-N001	531 0252 30	0-N106	531 0338 10	0-N925
531 0123 20	0-N183	531 0186 20	0-N005	531 0253 30	0-N103	531 0339 10	0-N1263
531 0124 20	0-N059	531 0187 20	0-N007	531 0254 30	0-N113	531 0340 10	0-N2140
531 0125 20	0-N064	531 0191 20	0-N013	531 0255 30	0-N115	531 0341 20	0-N181
531 0130 20	0-N981	531 0192 20	0-N1549	531 0257 10	0-N215	531 0342 30	0-N116
531 0131 20	0-N905	531 0193 20	0-N060	531 0258 10	0-N1713	531 0343 30	0-N117
531 0132 20	0-N178	531 0194 20	0-N987	531 0261 10	0-N1899	531 0345 10	0-N290
531 0133 20	0-N982	531 0195 20	0-N052	531 0262 10	0-N1749	531 0347 20	0-N182
531 0134 20	0-N066	531 0196 20	0-N056	531 0262 10	0-N1749S	531 0350 10	0-N1222
531 0135 20	0-N926	531 0197 20	0-N076	531 0263 10	0-N1681	531 0351 10	0-N2336
531 0137 20	0-N1781	531 0198 20	0-N078	531 0264 10	0-N118P	531 0354 10	0-N2174
531 0138 20	0-N028	531 0199 10	0-N1229	531 0265 10	0-N1968	531 0355 10	0-N1904
531 0140 20	0-N979	531 0200 20	0-N082	531 0267 10	0-N1300	531 0355 10	0-N1975
531 0141 20	0-N928	531 0201 20	0-N027	531 0267 10	0-N1300S	531 0356 10	0-N2335
531 0142 10	0-N1603	531 0202 20	0-N083	531 0268 20	0-N927	531 0357 10	0-N2334
531 0143 20	0-N045	531 0203 20	0-N157	531 0269 10	0-N294	531 0358 10	0-N2333
531 0144 20	0-N068	531 0204 10	0-N123	531 0272 30	0-N089	531 0359 10	0-N150
531 0145 20	0-N193	531 0205 10	0-N162	531 0273 30	0-N101	531 0360 10	0-N135
531 0147 20	0-N042	531 0208 20	0-N032	531 0274 30	0-N109	531 0361 10	0-N145
531 0148 10	0-N1320	531 0209 20	0-N021	531 0275 30	0-N107	531 0363 10	0-N236
531 0149 20	0-N048	531 0211 20	0-N022	531 0276 30	0-N110	531 0366 10	0-N1741
531 0150 20	0-N049	531 0212 20	0-N030	531 0277 30	0-N105	531 0366 10	0-N1741S
531 0151 20	0-N036	531 0213 30	0-N970	531 0278 30	0-N108	531 0367 10	0-N1382
531 0152 20	0-N037	531 0214 20	0-N024	531 0279 30	0-N111	531 0373 10	0-N1748
531 0153 20	0-N038	531 0215 20	0-N176	531 0280 10	0-N208	531 0374 10	0-N1752
531 0154 20	0-N039	531 0216 20	0-N025	531 0281 30	0-N114	531 0375 10	0-N134
531 0155 20	0-N2323	531 0217 10	0-N964	531 0293 30	0-N1444	531 0377 10	0-N1261
531 0156 10	0-N955	531 0219 20	0-N034	531 0304 10	0-N1779	531 0378 10	0-N1754
531 0157 20	0-N041	531 0220 20	0-N094	531 0306 10	0-N1949	531 0381 10	0-N2154
531 0157 20	0-N043	531 0223 10	0-N1243	531 0307 10	0-N1005	531 0382 20	0-N1127
531 0159 10	0-N1231	531 0225 10	0-N985	531 0309 10	0-N1317	531 0383 20	0-N191
531 0161 10	0-N891	531 0226 10	0-N095	531 0309 10	0-N1317S	531 0384 20	0-N1244
531 0162 10	0-N1296	531 0227 10	0-N1750	531 0310 10	0-N999	531 0388 10	0-N149
531 0163 20	0-N1223	531 0228 20	0-N051	531 0311 10	0-N1362	531 0391 10	0-N1585
531 0166 20	0-N126	531 0229 20	0-N188	531 0312 10	0-N137	531 0391 10	0-N1585S
531 0167 20	0-N018	531 0231 20	0-N184	531 0314 20	0-N978	531 0392 10	0-N1599
531 0168 20	0-N019	531 0232 20	0-N061	531 0317 10	0-N158	531 0392 10	0-N1599S
531 0169 20	0-N916	531 0234 20	0-N053	531 0318 10	0-N159	531 0393 10	0-N129
531 0170 20	0-N020	531 0235 20	0-N186	531 0320 30	0-N112	531 0396 20	0-N1265
531 0171 10	0-N1260	531 0236 20	0-N063	531 0322 10	0-N1514	531 0399 20	0-N1654
531 0172 10	0-N1927	531 0237 20	0-N065	531 0322 10	0-N1514S	531 0401 10	0-N1969



INA		INA		INA		INA	
531 0402 20	0-N1266	531 0532 10	0-N1619	531 0635 20	0-N1652	531 0729 10	0-N1417
531 0404 10	0-N1112	531 0533 20	0-N126	531 0636 20	0-N1894	531 0730 20	0-N047
531 0406 10	0-N1721	531 0534 20	0-N1768	531 0637 20	0-N1623	531 0731 10	0-N941
531 0407 10	0-N1760	531 0535 20	0-N1085	531 0638 20	0-N1220	531 0732 10	0-N937
531 0408 30	0-N199	531 0536 10	0-N1496S	531 0639 20	0-N1774	531 0733 10	0-N1312
531 0409 30	0-N198	531 0539 10	0-N1400	531 0640 20	0-N2320	531 0734 10	0-N1600
531 0410 30	0-N200	531 0539 10	0-N1400S	531 0641 20	0-N1618	531 0735 10	0-N1412
531 0411 30	0-N194	531 0540 10	0-N1501	531 0642 20	0-N1879	531 0735 20	0-N939
531 0413 30	0-N196	531 0540 10	0-N1501S	531 0643 20	0-N1328	531 0736 10	0-N1584
531 0414 30	0-N195	531 0541 10	0-N1903	531 0645 20	0-N2041	531 0737 10	0-N2016
531 0426 10	0-N1230	531 0541 10	0-N1903S	531 0646 20	0-N2024	531 0742 10	0-N1634
531 0427 10	0-N1314	531 0545 10	0-N1796	531 0649 20	0-N2325	531 0743 10	0-N2179
531 0436 20	0-N1048	531 0545 10	0-N1796S	531 0650 20	0-N1829	531 0744 10	0-N1589
531 0440 30	0-N107	531 0546 10	0-N1057	531 0651 20	0-N1498	531 0745 10	0-N1432S
531 0458 20	0-N094	531 0547 10	0-N1111	531 0652 20	0-N1576	531 0746 10	0-N1581
531 0465 10	0-N968	531 0548 10	0-N1269	531 0653 20	0-N1366	531 0747 10	0-N1566
531 0467 10	0-N1455	531 0550 10	0-N1455	531 0654 20	0-N2315	531 0748 10	0-N1313
531 0471 10	0-N1514	531 0551 20	0-N1833	531 0655 20	0-N1767	531 0749 10	0-N1386
531 0471 10	0-N1514S	531 0553 10	0-N1624	531 0657 20	0-N903	531 0750 10	0-N1911
531 0475 10	0-N1911	531 0553 10	0-N1624S	531 0658 20	0-N1452	531 0751 30	0-N1308
531 0477 20	0-N1238	531 0555 10	0-N1062	531 0659 20	0-N2168	531 0752 10	0-N1604
531 0478 10	0-N1061	531 0557 10	0-N821	531 0660 20	0-N1765	531 0753 20	0-N939
531 0480 10	0-N1480S	531 0564 30	0-N1258	531 0662 20	0-N1828	531 0754 10	0-N1759
531 0495 10	0-N1720	531 0565 30	0-N1045	531 0663 20	0-N1755	531 0755 10	0-N1060
531 0495 10	0-N1720S	531 0566 30	0-N1836	531 0664 20	0-N2319	531 0756 10	0-N1327
531 0496 10	0-N1627	531 0567 30	0-N2059	531 0665 20	0-N1883	531 0757 10	0-N1338
531 0496 10	0-N1627S	531 0570 10	0-N295	531 0665 20	0-N1883S	531 0758 10	0-N1246
531 0497 10	0-N1367	531 0571 10	0-N2141	531 0666 20	0-N085	531 0760 10	0-N1450
531 0498 20	0-N1978	531 0572 10	0-N1277	531 0667 20	0-N1824	531 0761 10	0-N1571
531 0498 20	0-N1978S	531 0573 30	0-N201	531 0668 20	0-N1825	531 0762 10	0-N2164
531 0499 20	0-N1236	531 0578 10	0-N1613	531 0669 20	0-N1948	531 0763 10	0-N2165
531 0500 20	0-N1042	531 0582 10	0-N1499S	531 0670 20	0-N1373	531 0768 10	0-N1356
531 0501 20	0-N1054	531 0584 10	0-N1330	531 0671 20	0-N1917	531 0769 10	0-N1357
531 0502 20	0-N1568	531 0586 10	0-N294	531 0672 20	0-N1129	531 0770 10	0-N1343
531 0503 10	0-N1806	531 0591 30	0-N1474	531 0674 20	0-N1216	531 0771 10	0-N1614
531 0504 10	0-N1361	531 0594 30	0-N1572	531 0676 30	0-N1272	531 0773 10	0-N1353
531 0505 10	0-N1351	531 0597 20	0-N079	531 0677 30	0-N1388	531 0774 10	0-N087
531 0513 10	0-N1120	531 0598 20	0-N1379	531 0678 30	0-N1340	531 0776 10	0-N1337
531 0515 10	0-N1349	531 0599 20	0-N1562	531 0679 30	0-N1369	531 0778 10	0-N1616
531 0518 30	0-N102	531 0600 10	0-N805	531 0710 10	0-N1368	531 0779 10	0-N1347
531 0519 30	0-N1292	531 0625 20	0-N1283	531 0713 20	0-N949	531 0780 10	0-N118P
531 0519 30	0-N1443	531 0626 30	0-N1383	531 0716 10	0-N1580	531 0781 10	0-N1913
531 0520 20	0-N130	531 0627 30	0-N1778	531 0717 10	0-N911	531 0781 10	0-N1913S
531 0523 30	0-N1232	531 0628 30	0-N1335	531 0718 10	0-N846	531 0782 10	0-N1524
531 0524 30	0-N1332	531 0629 30	0-N1092	531 0719 10	0-N1579	531 0783 10	0-N1523
531 0525 30	0-N1331	531 0630 30	0-N200	531 0720 10	0-N1278	531 0784 10	0-N1378
531 0528 10	0-N1561	531 0631 10	0-N1449	531 0721 10	0-N1861	531 0785 10	0-N1612
531 0529 10	0-N1058	531 0632 10	0-N1359	531 0722 10	0-N1280	531 0786 10	0-N1324
531 0530 20	0-N017	531 0634 20	0-N1817	531 0723 10	0-N1862	531 0787 10	0-N1573
531 0531 20	0-N1050	531 0634 20	0-N1817S	531 0727 10	0-N1304	531 0788 10	0-N1834

INA		INA		INA		INA	
531 0788 10	0-N1834S	531 0854 10	0-N2222	531004710	0-N943	531012320	0-N183
531 0789 10	0-N1940	531 0855 10	0-N2322	531004810	0-N901	531012420	0-N059
531 0789 10	0-N1940S	531 0856 10	0-N2273	531004910	0-N944	531012520	0-N064
531 0790 10	0-N1912	531 0858 10	0-N2060	531005010	0-N877	531013020	0-N981
531 0790 10	0-N1912S	531 0859 10	0-N1349	531005120	0-N185	531013120	0-N905
531 0791 10	0-N1675	531 0860 10	0-N1771	531005220	0-N879	531013220	0-N178
531 0802 10	0-N2331	531 0861 10	0-N2201	531005320	0-N1071	531013320	0-N982
531 0803 10	0-N2330	531 0864 10	0-N2274	531005430	0-N100	531013420	0-N066
531 0804 10	0-N1121	531 0866 10	0-N2055S	531005510	0-N863	531013520	0-N926
531 0807 10	0-N1884	531 0868 10	0-N1314	531005610	0-N859	531013720	0-N1781
531 0809 10	0-N1905	531 0869 10	0-N1838S	531006110	0-N173	531013820	0-N028
531 0810 10	0-N2018	531 0871 10	0-N2271	531006310	0-N805	531014020	0-N979
531 0811 10	0-N1743	531 0873 10	0-N2272	531006410	0-N880	531014120	0-N928
531 0812 10	0-N1711S	531 0875 10	0-N2326	531006610	0-N139	531014320	0-N045
531 0813 10	0-N1564	531 0876 10	0-N2062	531007210	0-N883	531014420	0-N068
531 0815 10	0-N1952	531 0877 10	0-N2057	531007410	0-N856	531014520	0-N193
531 0816 10	0-N1841	531 0882 10	0-N2313	531007510	0-N894	531014720	0-N042
531 0817 10	0-N2220	531 0889 10	0-N2239	531007710	0-N897	531014810	0-N1320
531 0817 10	0-N2220S	531 0894 10	0-N2314	531007910	0-N806	531014920	0-N048
531 0818 10	0-N145	531 0897 10	0-N2329	531008220	0-N922	531015020	0-N049
531 0819 10	0-N1085	531 0906 10	0-N2423	531008310	0-N808	531015120	0-N036
531 0824 10	0-N1764	531000110	0-N809	531008420	0-N940	531015220	0-N037
531 0825 10	0-N2061	531000210	0-N954	531008510	0-N921	531015320	0-N038
531 0827 10	0-N2207	531000410	0-N1295	531008610	0-N917	531015420	0-N039
531 0830 10	0-N1852	531000510	0-N822	531008720	0-N919	531015610	0-N955
531 0831 10	0-N2189S	531000610	0-N818	531008910	0-N860	531015720	0-N043
531 0832 10	0-N1854	531000910	0-N826	531009010	0-N930	531015910	0-N1231
531 0833 10	0-N1761	531001120	0-N823	531009320	0-N800	531016110	0-N891
531 0834 10	0-N2161	531001220	0-N819	531009420	0-N801	531016210	0-N1296
531 0834 10	0-N2161S	531001320	0-N850	531009610	0-N124	531016320	0-N1223
531 0835 10	0-N2225	531001420	0-N832	531009710	0-N931	531016620	0-N126
531 0836 10	0-N1956	531001520	0-N835	531009910	0-N898	531016720	0-N018
531 0836 10	0-N1956S	531002010	0-N837	531010130	0-N948	531016820	0-N019
531 0837 10	0-N2065	531002210	0-N838	531010220	0-N912	531016920	0-N916
531 0837 10	0-N2065S	531002310	0-N874	531010320	0-N160	531017020	0-N020
531 0838 10	0-N2106	531002410	0-N155	531010420	0-N983	531017110	0-N1260
531 0839 10	0-N2063	531002510	0-N839	531010620	0-N069	531017210	0-N1927
531 0840 10	0-N2195	531002710	0-N842	531010720	0-N071	531017420	0-N988
531 0841 10	0-N2056	531002810	0-N156	531010820	0-N073	531017520	0-N990
531 0842 10	0-N2233	531002920	0-N915	531010920	0-N969	531017620	0-N992
531 0843 10	0-N1499	531003010	0-N811	531011220	0-N973	531017720	0-N993
531 0844 10	0-N115	531003110	0-N861	531011320	0-N974	531017820	0-N995
531 0845 10	0-N2229	531003210	0-N812	531011330	0-N974	531017920	0-N997
531 0846 10	0-N2339	531003310	0-N869	531011410	0-N072	531018020	0-N998
531 0849 10	0-N2150	531003410	0-N813	531011610	0-N1712	531018120	0-N999
531 0850 10	0-N2224	531003610	0-N870	531011720	0-N092	531018220	0-N000
531 0851 10	0-N2208	531003810	0-N849	531011820	0-N975	531018320	0-N001
531 0852 10	0-N1725	531003910	0-N1682	531011920	0-N986	531018620	0-N005
531 0853 10	0-N1724	531004110	0-N871	531012020	0-N054	531018720	0-N007
531 0853 10	0-N2102	531004410	0-N815	531012210	0-N959	531019120	0-N013



INA		INA		INA		INA	
531019320	0-N060	531026310	0-N1681	531037810	0-N1754	531056430	0-N1258
531019420	0-N987	531026410	0-N118P	531038110	0-N2154	531056530	0-N1045
531019520	0-N052	531026710	0-N1300	531038220	0-N1127	531056630	0-N1836
531019620	0-N056	531026710	0-N1300S	531038420	0-N1244	531056730	0-N2059
531019720	0-N076	531026820	0-N927	531038810	0-N149	531057010	0-N295
531019820	0-N078	531027230	0-N089	531039310	0-N129	531057110	0-N2141
531019910	0-N1229	531027330	0-N101	531039620	0-N1265	531057210	0-N1277
531020020	0-N082	531027430	0-N109	531040110	0-N1969	531057330	0-N201
531020120	0-N027	531027630	0-N110	531040220	0-N1266	531057810	0-N1613
531020220	0-N083	531027730	0-N105	531040410	0-N1112	531058410	0-N1330
531020320	0-N157	531027830	0-N108	531040610	0-N1721	531058610	0-N294
531020410	0-N123	531027930	0-N111	531040710	0-N1760	531059720	0-N079
531020820	0-N032	531028010	0-N208	531040830	0-N199	531059820	0-N1379
531020920	0-N021	531028130	0-N114	531040930	0-N198	531059920	0-N1562
531021120	0-N022	531029330	0-N1444	531041130	0-N194	531062520	0-N1283
531021220	0-N030	531030410	0-N1779	531041330	0-N196	531062630	0-N1383
531021330	0-N970	531031110	0-N1362	531041430	0-N195	531062730	0-N1778
531021420	0-N024	531031210	0-N137	531043620	0-N1048	531062830	0-N1335
531021520	0-N176	531031420	0-N978	531044030	0-N107	531062930	0-N1092
531021620	0-N025	531031710	0-N158	531046510	0-N968	531063030	0-N200
531021920	0-N034	531031810	0-N159	531047720	0-N1238	531063210	0-N1359
531022020	0-N094	531032030	0-N112	531047810	0-N1061	531063820	0-N1220
531022310	0-N1243	531032210	0-N1514	531049510	0-N1720	531063920	0-N1774
531022510	0-N985	531032210	0-N1514S	531049510	0-N1720S	531064120	0-N1618
531022610	0-N095	531032310	0-N1640	531049610	0-N1627	531064220	0-N1879
531022710	0-N1750	531032910	0-N1273	531049610	0-N1627S	531064320	0-N1328
531022820	0-N051	531033110	0-N1256	531049710	0-N1367	531064520	0-N2041
531022920	0-N188	531033220	0-N180	531049920	0-N1236	531064620	0-N2024
531023020	0-N062	531033710	0-N132	531050020	0-N1042	531065020	0-N1829
531023120	0-N184	531033810	0-N925	531050120	0-N1054	531065120	0-N1498
531023420	0-N053	531033910	0-N1263	531050310	0-N1806	531065720	0-N903
531023520	0-N186	531034010	0-N2140	531050410	0-N1361	531065920	0-N2168
531023620	0-N063	531034120	0-N181	531050510	0-N1351	531066020	0-N1765
531023720	0-N065	531034230	0-N116	531051510	0-N1349	531066220	0-N1828
531023810	0-N133	531034330	0-N117	531051830	0-N102	531066320	0-N1755
531023910	0-N2015	531034510	0-N290	531052020	0-N130	531066520	0-N1883
531024110	0-N125	531034720	0-N182	531052330	0-N1232	531066720	0-N1824
531024110	0-N125S	531035010	0-N1222	531052530	0-N1331	531066820	0-N1825
531024220	0-N910	531035410	0-N2174	531052810	0-N1561	531067220	0-N1129
531024310	0-N121	531035510	0-N1904	531052910	0-N1058	531067420	0-N1216
531025010	0-N913	531035910	0-N150	531053020	0-N017	531067630	0-N1272
531025130	0-N104	531036010	0-N135	531053120	0-N1050	531067830	0-N1340
531025230	0-N106	531036110	0-N145	531053420	0-N1768	531067930	0-N1369
531025330	0-N103	531036310	0-N236	531054510	0-N1796	531071010	0-N1368
531025430	0-N113	531036610	0-N1741	531054610	0-N1057	531071710	0-N911
531025530	0-N115	531036710	0-N1382	531054710	0-N1111	531071810	0-N846
531025710	0-N215	531037310	0-N1748	531054810	0-N1269	531072010	0-N1278
531025810	0-N1713	531037410	0-N1752	531055310	0-N1624	531072110	0-N1861
531026210	0-N1749	531037510	0-N134	531055510	0-N1062	531072210	0-N1280
531026210	0-N1749S	531037710	0-N1261	531055710	0-N821	531072710	0-N1304

INA		INA		INA		INA	
531073020	0-N047	531083110	0-N2189S	532 0064 10	0-N867	532 0124 10	0-N1463S
531073110	0-N941	531083410	0-N2161	532 0066 10	0-N1632	532 0125 20	0-N957
531073210	0-N937	531083410	0-N2161S	532 0068 20	0-N070	532 0126 10	0-N1465S
531073710	0-N2016	531083510	0-N2225	532 0069 20	0-N074	532 0127 10	0-N172
531074310	0-N2179	531083610	0-N1956	532 0070 20	0-N075	532 0130 20	0-N058
531074410	0-N1589	531083710	0-N2065	532 0071 10	0-N1602	532 0132 10	0-N1414
531074610	0-N1581	531083910	0-N2063	532 0072 20	0-N088	532 0134 10	0-N2347
531074710	0-N1566	531084110	0-N2056	532 0072 30	0-N088	532 0136 10	0-N1239
531075010	0-N1911	531084210	0-N2233	532 0074 20	0-N055	532 0138 10	0-N1405
531075210	0-N1604	531084310	0-N1499	532 0076 20	0-N050	532 0139 10	0-N1402
531075320	0-N939	531084510	0-N2229	532 0077 20	0-N046	532 0139 10	0-N1402S
531075410	0-N1759	531084910	0-N2150	532 0078 20	0-N047	532 0140 20	0-N170
531075510	0-N1060	531085010	0-N2224	532 0079 20	0-N040	532 0141 20	0-N171
531075610	0-N1327	531085110	0-N2208	532 0081 20	0-N996	532 0142 10	0-N122
531075810	0-N1246	531085210	0-N1725	532 0082 10	0-N197	532 0143 10	0-N151
531076210	0-N2164	531085410	0-N2222	532 0083 10	0-N892	532 0144 10	0-N1586
531076310	0-N2165	531085810	0-N2060	532 0084 20	0-N1225	532 0146 10	0-N1430
531076810	0-N1356	531086010	0-N1771	532 0085 20	0-N1226	532 0147 10	0-N1544
531076910	0-N1357	531086110	0-N2201	532 0087 10	0-N127	532 0148 20	0-N189
531077010	0-N1343	532 0001 10	0-N1301	532 0088 10	0-N899	532 0151 10	0-N292
531077110	0-N1614	532 0002 10	0-N866	532 0090 20	0-N989	532 0152 10	0-N293
531077310	0-N1353	532 0005 20	0-N820	532 0091 20	0-N991	532 0153 10	0-N2349
531077610	0-N1337	532 0007 20	0-N889	532 0092 20	0-N994	532 0155 10	0-N2047
531077810	0-N1616	532 0014 20	0-N2156	532 0093 10	0-N096	532 0156 10	0-N1315
531077910	0-N1347	532 0016 10	0-N904	532 0095 20	0-N006	532 0157 20	0-N041
531078110	0-N1913	532 0017 10	0-N1214	532 0096 20	0-N008	532 0158 10	0-N168
531078110	0-N1913S	532 0018 10	0-N902	532 0098 20	0-N014	532 0159 10	0-N2001
531078410	0-N1378	532 0020 10	0-N862	532 0100 20	0-N077	532 0160 10	0-N1431
531078510	0-N1612	532 0021 10	0-N911	532 0101 20	0-N080	532 0161 10	0-N131
531078610	0-N1324	532 0022 10	0-N900	532 0102 20	0-N081	532 0163 10	0-N2000
531078710	0-N1573	532 0023 10	0-N945	532 0103 20	0-N084	532 0164 10	0-N924
531078910	0-N1940	532 0025 10	0-N847	532 0104 20	0-N086	532 0165 10	0-N167
531079010	0-N1912	532 0027 10	0-N1288	532 0105 20	0-N090	532 0166 10	0-N2345
531079010	0-N1912S	532 0030 10	0-N1864	532 0106 20	0-N091	532 0167 10	0-N1262
531079110	0-N1675	532 0033 10	0-N953	532 0107 10	0-N960	532 0169 10	0-N1311
531080410	0-N1121	532 0034 10	0-N952	532 0108 10	0-N1437	532 0170 10	0-N1734
531080710	0-N1884	532 0035 10	0-N876	532 0109 10	0-N1439	532 0171 10	0-N277
531080910	0-N1905	532 0037 10	0-N875	532 0110 20	0-N029	532 0174 10	0-N2013
531081010	0-N2018	532 0038 10	0-N909	532 0111 10	0-N166	532 0177 10	0-N2176
531081110	0-N1743	532 0039 10	0-N906	532 0113 20	0-N031	532 0179 20	0-N029
531081210	0-N1711S	532 0040 10	0-N907	532 0114 20	0-N033	532 0180 20	0-N300
531081310	0-N1564	532 0041 20	0-N878	532 0115 20	0-N035	532 0182 10	0-N165
531081510	0-N1952	532 0051 10	0-N807	532 0116 20	0-N937	532 0184 10	0-N1751
531081610	0-N1841	532 0052 10	0-N923	532 0117 20	0-N1218	532 0185 10	0-N164
531081710	0-N2220	532 0055 20	0-N192	532 0118 20	0-N1219	532 0187 10	0-N291
531081710	0-N2220S	532 0057 10	0-N138	532 0119 10	0-N2153	532 0189 10	0-N168
531082410	0-N1764	532 0058 10	0-N857	532 0120 10	0-N938	532 0190 10	0-N163
531082510	0-N2061	532 0060 20	0-N1305	532 0121 20	0-N950	532 0191 10	0-N143
531082710	0-N2207	532 0062 10	0-N1297	532 0122 10	0-N128	532 0193 20	0-N187
531083010	0-N1852	532 0063 20	0-N1546	532 0123 10	0-N1722	532 0194 20	0-N971



INA		INA		INA		INA	
532 0196 10	0-N119P	532 0298 10	0-N1597	532 0362 10	0-N1649	532 0426 10	0-N964
532 0197 10	0-N1268	532 0300 10	0-N1598	532 0363 20	0-N1396	532 0427 10	0-N965
532 0198 10	0-N1730	532 0301 10	0-N1740	532 0364 20	0-N1409	532 0428 10	0-N2152
532 0204 10	0-N1753	532 0302 10	0-N2346	532 0365 20	0-N1765S	532 0429 10	0-N237
532 0209 10	0-N951	532 0303 10	0-N1668	532 0366 20	0-N1052	532 0430 10	0-N2173
532 0212 10	0-N141	532 0303 10	0-N1668S	532 0367 20	0-N1591	532 0431 10	0-N1544
532 0213 10	0-N1590	532 0304 10	0-N1680	532 0368 20	0-N1966	532 0432 10	0-N1544
532 0214 10	0-N1446	532 0305 10	0-N2127	532 0369 20	0-N1403	532 0433 10	0-N1309
532 0216 10	0-N2343	532 0307 10	0-N1374	532 0370 20	0-N1415	532 0434 10	0-N1413
532 0218 10	0-N146	532 0308 10	0-N1259	532 0371 20	0-N1628	532 0435 10	0-N1230
532 0220 10	0-N147	532 0309 10	0-N1603	532 0372 20	0-N2058	532 0436 10	0-N1450
532 0221 10	0-N262	532 0310 10	0-N1346	532 0373 20	0-N1093	532 0437 10	0-N1447S
532 0222 10	0-N148	532 0311 10	0-N1942	532 0374 20	0-N1540	532 0438 10	0-N1914
532 0223 10	0-N1406	532 0312 20	0-N1316	532 0375 20	0-N1629	532 0439 10	0-N1416
532 0224 10	0-N1292	532 0313 20	0-N1270	532 0376 20	0-N1355	532 0440 10	0-N2054
532 0225 10	0-N1350	532 0314 20	0-N1370	532 0377 20	0-N1633	532 0441 10	0-N1352
532 0227 10	0-N1835	532 0316 10	0-N814	532 0378 20	0-N1354	532 0442 10	0-N1394
532 0228 10	0-N1408	532 0317 10	0-N958	532 0379 20	0-N1329	532 0444 10	0-N1122
532 0229 10	0-N187	532 0318 10	0-N1376	532 0380 20	0-N2186	532 0445 10	0-N1451
532 0230 10	0-N1393	532 0320 10	0-N1418	532 0381 20	0-N1521	532 0446 10	0-N1365
532 0232 10	0-N1248	532 0321 10	0-N1066	532 0382 20	0-N1577	532 0448 10	0-N1582
532 0233 10	0-N2131	532 0322 10	0-N1106	532 0383 20	0-N1777	532 0449 10	0-N1665
532 0234 10	0-N1560	532 0323 10	0-N1389	532 0384 20	0-N1782	532 0450 10	0-N1651
532 0236 10	0-N169	532 0325 30	0-N1429	532 0385 20	0-N1783	532 0450 10	0-N1651S
532 0237 10	0-N854	532 0326 30	0-N1310	532 0386 20	0-N1377	532 0451 10	0-N1375
532 0238 10	0-N881	532 0327 30	0-N1425	532 0387 20	0-N1380	532 0458 10	0-N1622
532 0239 20	0-N816	532 0328 10	0-N958	532 0388 20	0-N1816	532 0459 10	0-N1574
532 0240 10	0-N1635	532 0329 10	0-N1570	532 0389 20	0-N1775	532 0460 10	0-N1358
532 0241 10	0-N1630	532 0330 10	0-N174	532 0390 20	0-N1773	532 0461 10	0-N1615
532 0242 10	0-N1647	532 0331 10	0-N1419	532 0392 20	0-N1729	532 0463 10	0-N2134
532 0243 10	0-N1307	532 0333 10	0-N1648	532 0393 20	0-N1448	532 0466 10	0-N1962
532 0244 10	0-N1650	532 0334 10	0-N1420	532 0395 10	0-N1360	532 0467 10	0-N1423
532 0245 10	0-N2342	532 0335 10	0-N1421	532 0396 20	0-N2167	532 0468 10	0-N1738
532 0247 10	0-N1436	532 0336 10	0-N1461	532 0397 10	0-N1456	532 0470 10	0-N1392
532 0247 10	0-N1436S	532 0342 10	0-N1922	532 0398 10	0-N1792	532 0471 10	0-N1428
532 0248 10	0-N1550	532 0343 10	0-N1453	532 0399 20	0-N144	532 0472 10	0-N1348
532 0252 30	0-N197	532 0344 10	0-N1638	532 0400 30	0-N1723	532 0473 10	0-N1334
532 0255 10	0-N1594	532 0345 10	0-N1381	532 0401 30	0-N1457	532 0474 10	0-N1924
532 0256 10	0-N1404	532 0346 10	0-N1454	532 0402 30	0-N1426	532 0475 10	0-N1505S
532 0257 10	0-N1596	532 0349 10	0-N1046	532 0403 20	0-N1776	532 0476 10	0-N1411
532 0259 10	0-N1672	532 0350 10	0-N1341	532 0404 30	0-N1395	532 0477 10	0-N1460
532 0260 10	0-N1592	532 0351 30	0-N1424	532 0405 30	0-N1458	532 0478 10	0-N300
532 0282 10	0-N1442	532 0352 20	0-N1578	532 0406 30	0-N1397	532 0479 10	0-N1715
532 0287 10	0-N1326	532 0353 20	0-N1563	532 0418 10	0-N1298	532 0480 10	0-N1605
532 0289 10	0-N1065	532 0354 10	0-N1898	532 0419 10	0-N2348	532 0481 10	0-N2076
532 0293 10	0-N1726	532 0354 10	0-N1898S	532 0420 10	0-N1973	532 0481 10	0-N2076S
532 0294 10	0-N1387	532 0355 10	0-N1336	532 0422 10	0-N887	532 0500 10	0-N1909
532 0295 10	0-N1398	532 0356 10	0-N1250	532 0423 10	0-N920	532 0501 10	0-N1385
532 0296 10	0-N1545	532 0360 10	0-N1916	532 0424 10	0-N2349	532 0502 10	0-N2177
532 0297 10	0-N1399	532 0361 10	0-N1736	532 0425 10	0-N162	532 0503 10	0-N2178

INA		INA		INA		INA	
532 0504 10	0-N878	532 0565 10	0-N1928	532 0652 10	0-N1991	532000720	0-N889
532 0505 10	0-N1522	532 0566 10	0-N2227	532 0653 10	0-N2351	532001420	0-N2156
532 0506 10	0-N2126	532 0568 10	0-N1552S	532 0654 10	0-N2380	532001610	0-N904
532 0507 10	0-N2378	532 0568 10	0-N1553	532 0655 10	0-N2363	532001710	0-N1214
532 0509 10	0-N1066	532 0569 10	0-N1944	532 0658 10	0-N2248	532001810	0-N902
532 0510 10	0-N1683	532 0570 10	0-N2238	532 0659 10	0-N2278	532002010	0-N862
532 0511 10	0-N1431	532 0571 10	0-N2205	532 0660 10	0-N2370	532002210	0-N900
532 0512 10	0-N2128	532 0572 10	0-N2133	532 0661 10	0-N2236	532002310	0-N945
532 0513 10	0-N2199	532 0578 10	0-N2171	532 0665 10	0-N2340	532002510	0-N847
532 0514 10	0-N2129	532 0579 10	0-N1990	532 0666 10	0-N2341	532002710	0-N1288
532 0515 10	0-N2130	532 0580 10	0-N2123	532 0667 10	0-N2419	532003010	0-N1864
532 0516 10	0-N1976	532 0582 10	0-N2025	532 0669 10	0-N2367	532003310	0-N953
532 0521 10	0-N2385	532 0584 10	0-N2052	532 0671 10	0-N2312	532003410	0-N952
532 0522 10	0-N2386	532 0585 10	0-N1938	532 0672 10	0-N2296	532003510	0-N876
532 0524 10	0-N1786	532 0586 10	0-N1053	532 0674 10	0-N2255	532003710	0-N875
532 0525 10	0-N1746	532 0587 10	0-N2033	532 0675 10	0-N1130	532003810	0-N909
532 0526 10	0-N1637	532 0590 10	0-N1728	532 0676 10	0-N2237	532003910	0-N906
532 0527 10	0-N1575	532 0594 10	0-N1646	532 0678 10	0-N2253	532004010	0-N907
532 0528 10	0-N2019	532 0596 10	0-N2050	532 0693 10	0-N1984	532004120	0-N878
532 0529 10	0-N1735	532 0598 10	0-N1878	532 0694 10	0-N2027	532005110	0-N807
532 0531 10	0-N1667	532 0599 10	0-N1772	532 0695 10	0-N1814	532005210	0-N923
532 0534 10	0-N1739	532 0600 10	0-N2364	532 0700 10	0-N2254	532005520	0-N192
532 0535 10	0-N1915	532 0601 10	0-N2234	532 0705 10	0-N2276	532005710	0-N138
532 0536 10	0-N1906	532 0604 10	0-N2044	532 0714 10	0-N1316	532005810	0-N857
532 0537 10	0-N1803	532 0605 10	0-N2125	532 0715 10	0-N2275	532006020	0-N1305
532 0538 10	0-N1807	532 0606 10	0-N1547	532 0718 10	0-N2295	532006210	0-N1297
532 0539 10	0-N2138	532 0609 10	0-N2051	532 0720 10	0-N2369	532006410	0-N867
532 0540 10	0-N1500	532 0610 10	0-N2040	532 0721 10	0-N2286	532006820	0-N070
532 0541 10	0-N1859	532 0611 10	0-N2149	532 0722 10	0-N2371	532006920	0-N074
532 0542 10	0-N2244	532 0614 10	0-N2283	532 0723 10	0-N2344	532007020	0-N075
532 0543 10	0-N1678	532 0617 10	0-N2049	532 0730 10	0-N2277	532007110	0-N1602
532 0544 10	0-N1963	532 0618 10	0-N1983	532 0735 10	0-N2421	532007220	0-N088
532 0545 10	0-N1716	532 0620 10	0-N2021	532 0736 10	0-N2420	532007420	0-N055
532 0547 10	0-N1960	532 0621 10	0-N2221	532 0737 10	0-N2294	532007620	0-N050
532 0548 10	0-N1972	532 0622 10	0-N2228	532 0738 10	0-N2354	532007720	0-N046
532 0549 10	0-N1744	532 0623 10	0-N2200	532 0744 10	0-N2377	532007920	0-N040
532 0550 10	0-N1856	532 0624 10	0-N2382	532 0750 10	0-N2424	532008120	0-N996
532 0550 10	0-N1856S	532 0625 10	0-N2218	532 0751 10	0-N2373	532008310	0-N892
532 0551 10	0-N2094	532 0629 10	0-N2120	532 0752 10	0-N2372	532008420	0-N1225
532 0553 10	0-N1871	532 0630 10	0-N2119	532 0753 10	0-N2381	532008520	0-N1226
532 0554 10	0-N1965	532 0631 10	0-N2374	532 0773 10	0-N2355	532008710	0-N127
532 0555 10	0-N2110	532 0632 10	0-N2121	532 0780 10	0-N2240	532008810	0-N899
532 0556 10	0-N1950	532 0639 10	0-N2429	532 0782 10	0-N2303	532009020	0-N989
532 0557 10	0-N1795	532 0642 10	0-N2375	532 0784 10	0-N2368	532009120	0-N991
532 0558 10	0-N2243	532 0644 10	0-N1987	532 0785 10	0-N2357	532009220	0-N994
532 0559 10	0-N2132	532 0646 10	0-N2384	532 0786 10	0-N2043	532009310	0-N096
532 0560 10	0-N2048	532 0647 10	0-N2365	532 0789 10	0-N2350	532009520	0-N006
532 0561 10	0-N2191	532 0648 10	0-N2206	532000110	0-N1301	532009620	0-N008
532 0562 10	0-N2122	532 0649 10	0-N2353	532000210	0-N866	532009820	0-N014
532 0564 10	0-N1907	532 0651 10	0-N1702	532000520	0-N820	532010020	0-N077



INA		INA		INA		INA	
532010120	0-N080	532021210	0-N141	532037820	0-N1354	532051210	0-N2128
532010220	0-N081	532021810	0-N146	532038020	0-N2186	532051310	0-N2199
532010320	0-N084	532022010	0-N147	532038120	0-N1521	532051410	0-N2129
532010520	0-N090	532022110	0-N262	532038420	0-N1782	532051510	0-N2130
532010620	0-N091	532022210	0-N148	532038520	0-N1783	532051610	0-N1976
532010710	0-N960	532022410	0-N1292	532038620	0-N1377	532052410	0-N1786
532011020	0-N029	532022510	0-N1350	532038720	0-N1380	532052510	0-N1746
532011110	0-N166	532022710	0-N1835	532038820	0-N1816	532052710	0-N1575
532011320	0-N031	532023210	0-N1248	532038920	0-N1775	532052810	0-N2019
532011420	0-N033	532023310	0-N2131	532039020	0-N1773	532052910	0-N1735
532011520	0-N035	532023610	0-N169	532039510	0-N1360	532053110	0-N1667
532011720	0-N1218	532023710	0-N854	532039620	0-N2167	532053410	0-N1739
532011820	0-N1219	532023810	0-N881	532039810	0-N1792	532053710	0-N1803
532011910	0-N2153	532023920	0-N816	532040030	0-N1723	532053810	0-N1807
532012010	0-N938	532024310	0-N1307	532040320	0-N1776	532053910	0-N2138
532012120	0-N950	532025230	0-N197	532041810	0-N1298	532054010	0-N1500
532012210	0-N128	532025910	0-N1672	532042010	0-N1973	532054110	0-N1859
532012310	0-N1722	532028910	0-N1065	532042210	0-N887	532054310	0-N1678
532012520	0-N957	532029310	0-N1726	532042310	0-N920	532054510	0-N1716
532012710	0-N172	532030110	0-N1740	532042510	0-N162	532054710	0-N1960
532013020	0-N058	532030310	0-N1668	532042610	0-N964	532054910	0-N1744
532013610	0-N1239	532030410	0-N1680	532042710	0-N965	532055110	0-N2094
532014020	0-N170	532030510	0-N2127	532042810	0-N2152	532055510	0-N2110
532014120	0-N171	532030810	0-N1259	532042910	0-N237	532055710	0-N1795
532014210	0-N122	532031010	0-N1346	532043010	0-N2173	532055910	0-N2132
532014820	0-N189	532031220	0-N1316	532043510	0-N1230	532056010	0-N2048
532015110	0-N292	532031320	0-N1270	532044010	0-N2054	532056110	0-N2191
532015210	0-N293	532031610	0-N814	532044110	0-N1352	532056210	0-N2122
532016010	0-N1431	532031710	0-N958	532044410	0-N1122	532056410	0-N1907
532016110	0-N131	532032010	0-N1418	532044610	0-N1365	532056510	0-N1928
532016310	0-N2000	532032110	0-N1066	532045010	0-N1651	532056610	0-N2227
532016410	0-N924	532032210	0-N1106	532045910	0-N1574	532056910	0-N1944
532016510	0-N167	532032910	0-N1570	532046010	0-N1358	532057010	0-N2238
532016710	0-N1262	532033010	0-N174	532046110	0-N1615	532057110	0-N2205
532017010	0-N1734	532034210	0-N1922	532046310	0-N2134	532057210	0-N2133
532017110	0-N277	532034510	0-N1381	532046610	0-N1962	532057810	0-N2171
532017410	0-N2013	532034910	0-N1046	532046710	0-N1423	532057910	0-N1990
532017710	0-N2176	532035010	0-N1341	532046810	0-N1738	532058210	0-N2025
532018210	0-N165	532035220	0-N1578	532047210	0-N1348	532058410	0-N2052
532018410	0-N1751	532035320	0-N1563	532047310	0-N1334	532058510	0-N1938
532018510	0-N164	532035410	0-N1898	532047610	0-N1411	532058610	0-N1053
532018710	0-N291	532035410	0-N1898S	532047910	0-N1715	532059010	0-N1728
532019010	0-N163	532035510	0-N1336	532048010	0-N1605	532059610	0-N2050
532019110	0-N143	532035610	0-N1250	532048110	0-N2076	532059810	0-N1878
532019420	0-N971	532036010	0-N1916	532048110	0-N2076S	532059910	0-N1772
532019610	0-N119P	532036110	0-N1736	532050210	0-N2177	532060510	0-N2125
532019710	0-N1268	532036620	0-N1052	532050310	0-N2178	532061010	0-N2040
532019810	0-N1730	532037220	0-N2058	532050510	0-N1522	532061110	0-N2149
532020410	0-N1753	532037320	0-N1093	532050610	0-N2126	532062110	0-N2221
532020910	0-N951	532037620	0-N1355	532051010	0-N1683	532062210	0-N2228

INA		INA		INA		INA	
532062310	0-N2200	533 0037 20	0-N1371	533 0085 30	0-N2170S	533002310	0-N1810S
532062510	0-N2218	533 0039 10	0-N1049	533 0086 30	0-N1609	533002410	0-N2157
532062910	0-N2120	533 0040 10	0-N1342	533 0087 20	0-N1173	533002820	0-N1051
532063010	0-N2119	533 0041 10	0-N1372	533 0088 20	0-N1056	533002820	0-N1051S
532063210	0-N2121	533 0043 20	0-N1971	533 0089 10	0-N2146	533002920	0-N1364
532065110	0-N1702	533 0045 20	0-N2415	533 0090 10	0-N2095	533003020	0-N1237
532065210	0-N1991	533 0046 20	0-N2162	533 0090 10	0-N2095S	533003120	0-N1344
532066110	0-N2236	533 0048 20	0-N2163	533 0090 10	0-N2095S1	533003220	0-N1276
532067410	0-N2255	533 0049 20	0-N1469	533 0091 10	0-N1925	533003320	0-N1569
532067510	0-N1130	533 0050 20	0-N2411	533 0092 10	0-N1959	533003420	0-N1275
532067610	0-N2237	533 0051 20	0-N1625	533 0093 10	0-N2175	533003510	0-N1274
532067810	0-N2253	533 0051 20	0-N1625S	533 0094 10	0-N1820	533003610	0-N1567
532069410	0-N2027	533 0052 20	0-N1967	533 0095 10	0-N1926	533003720	0-N1371
532070010	0-N2254	533 0053 20	0-N1818	533 0096 10	0-N1936	533003910	0-N1049
533 0001 10	0-N1974	533 0054 20	0-N1860	533 0097 10	0-N1919	533004010	0-N1342
533 0002 10	0-N2409	533 0055 20	0-N1951	533 0097 10	0-N1919S	533004320	0-N1971
533 0003 10	0-N1293	533 0056 20	0-N2144	533 0099 10	0-N1943	533004620	0-N2162
533 0004 10	0-N2412	533 0057 20	0-N2145	533 0100 10	0-N2143	533004820	0-N2163
533 0005 10	0-N1758	533 0058 20	0-N2147	533 0102 10	0-N2159	533005120	0-N1625
533 0007 10	0-N1303	533 0059 20	0-N2142	533 0103 10	0-N2160	533005220	0-N1967
533 0008 10	0-N2413	533 0060 20	0-N1490S	533 0104 10	0-N2185	533005320	0-N1818
533 0009 10	0-N2181	533 0061 20	0-N1483	533 0107 10	0-N1804	533005420	0-N1860
533 0011 10	0-N1747	533 0061 20	0-N1483S	533 0107 10	0-N1804S	533005520	0-N1951
533 0012 10	0-N1757	533 0062 20	0-N1473	533 0108 10	0-N1819	533005620	0-N2144
533 0013 10	0-N1787	533 0062 20	0-N1473S	533 0111 10	0-N1823	533005720	0-N2145
533 0014 10	0-N2410	533 0063 20	0-N2172	533 0112 10	0-N1947	533005820	0-N2147
533 0015 10	0-N1290	533 0063 20	0-N2172S	533 0114 10	0-N1617	533005920	0-N2142
533 0015 10	0-N1290S	533 0065 20	0-N1289	533 0116 10	0-N2418	533006220	0-N1473
533 0016 10	0-N1294	533 0066 20	0-N565592	533 0117 10	0-N2417	533006220	0-N1473S
533 0016 10	0-N1294S	533 0068 20	0-N2414	533 0118 10	0-N2258	533006320	0-N2172
533 0017 10	0-N1641	533 0069 20	0-N1043	533 0119 10	0-N2223	533006320	0-N2172S
533 0017 10	0-N1641S	533 0071 10	0-N2169	533 0123 10	0-N2010	533006520	0-N1289
533 0019 10	0-N1932	533 0072 20	0-N1484	533 0126 10	0-N2416	533007110	0-N2169
533 0020 10	0-N1800	533 0072 20	0-N1484S	533 0127 10	0-N2291	533007220	0-N1484
533 0021 10	0-N2139	533 0073 10	0-N1756	533000310	0-N1293	533007310	0-N1756
533 0022 10	0-N1410	533 0074 10	0-N1299	533000510	0-N1758	533007410	0-N1299
533 0022 10	0-N1410S	533 0074 10	0-N1299S	533000710	0-N1303	533007410	0-N1299S
533 0023 10	0-N1810	533 0075 30	0-N1660	533000910	0-N2181	533007530	0-N1660
533 0023 10	0-N1810S	533 0076 30	0-N1041	533001210	0-N1757	533007630	0-N1041
533 0024 10	0-N2157	533 0076 30	0-N1041S	533001310	0-N1787	533007730	0-N1822
533 0028 20	0-N1051	533 0077 30	0-N1822	533001510	0-N1290	533007730	0-N1822S
533 0028 20	0-N1051S	533 0077 30	0-N1822S	533001510	0-N1290S	533007810	0-N2020
533 0029 20	0-N1364	533 0078 10	0-N2020	533001610	0-N1294	533007920	0-N956
533 0030 20	0-N1237	533 0079 20	0-N956	533001610	0-N1294S	533008130	0-N1538
533 0031 20	0-N1344	533 0081 30	0-N1538	533001710	0-N1641	533008130	0-N1538S
533 0032 20	0-N1276	533 0081 30	0-N1538S	533001710	0-N1641S	533008230	0-N1282
533 0033 20	0-N1569	533 0082 30	0-N1282	533001910	0-N1932	533008320	0-N1363
533 0034 20	0-N1275	533 0083 20	0-N1363	533002010	0-N1800	533008430	0-N1703
533 0035 10	0-N1274	533 0084 30	0-N1703	533002110	0-N2139	533008530	0-N2170
533 0036 10	0-N1567	533 0085 30	0-N2170	533002310	0-N1810	533008530	0-N2170S



INA		INA		INA		INA	
533008630	0-N1609	534 0024 10	0-N1717S	534 0065 10	0-N1733S	534 0109 20	0-N1407S
533008720	0-N1173	534 0025 10	0-N1470	534 0066 10	0-N2029	534 0110 20	0-N1493
533008820	0-N1056	534 0025 10	0-N1470S	534 0066 10	0-N2029S	534 0110 20	0-N1493S
533008910	0-N2146	534 0026 10	0-N1593	534 0067 10	0-N1670	534 0111 20	0-N1471
533009110	0-N1925	534 0026 10	0-N1593S	534 0067 10	0-N1670S	534 0111 20	0-N1471S
533009210	0-N1959	534 0027 10	0-N1427	534 0068 10	0-N2042	534 0112 20	0-N2053
533009310	0-N2175	534 0027 10	0-N1427S	534 0068 10	0-N2042S	534 0112 20	0-N2053S
533009410	0-N1820	534 0029 10	0-N1554	534 0069 10	0-N1517	534 0113 20	0-N1809
533009510	0-N1926	534 0029 10	0-N1554S	534 0069 10	0-N1517S	534 0113 20	0-N1809S
533009610	0-N1936	534 0030 10	0-N2096	534 0070 10	0-N1478S	534 0114 20	0-N1645
533009710	0-N1919	534 0030 10	0-N2096S	534 0072 20	0-N1284	534 0114 20	0-N1645S
533009910	0-N1943	534 0031 10	0-N1719	534 0073 20	0-N1285	534 0115 20	0-N1466
533010010	0-N2143	534 0031 10	0-N1719S	534 0075 20	0-N1339	534 0115 20	0-N1466S
533010210	0-N2159	534 0032 10	0-N1433	534 0075 20	0-N1339S	534 0116 20	0-N1083
533010310	0-N2160	534 0032 10	0-N1433S	534 0078 20	0-N1279	534 0116 20	0-N1083S
533010410	0-N2185	534 0033 10	0-N1485	534 0079 20	0-N1043	534 0117 20	0-N1857
533010810	0-N1819	534 0033 10	0-N1485S	534 0080 20	0-N1475S	534 0117 20	0-N1857S
533011110	0-N1823	534 0035 10	0-N1488	534 0081 30	0-N1587	534 0118 20	0-N1422
533011210	0-N1947	534 0035 10	0-N1488S	534 0081 30	0-N1587S	534 0118 20	0-N1422S
533011310	0-N2012	534 0036 10	0-N1479S	534 0082 30	0-N1495S	534 0119 20	0-N1481
533011410	0-N1617	534 0037 10	0-N1486	534 0083 30	0-N1953	534 0119 20	0-N1481S
533011810	0-N2258	534 0037 10	0-N1486S	534 0083 30	0-N1953S	534 0120 20	0-N1528
533011910	0-N2223	534 0038 10	0-N1509	534 0094 10	0-N1658	534 0120 20	0-N1528S
534 0001 10	0-N1511	534 0038 10	0-N1509S	534 0095 10	0-N1848	534 0121 10	0-N1512
534 0003 10	0-N1506	534 0039 10	0-N1669	534 0095 10	0-N1848S	534 0121 10	0-N1512S
534 0003 10	0-N1506S	534 0039 10	0-N1669S	534 0096 10	0-N1805	534 0122 10	0-N1507
534 0004 10	0-N1527	534 0040 10	0-N1510	534 0096 10	0-N1805S	534 0122 10	0-N1507S
534 0004 10	0-N1527S	534 0040 10	0-N1510S	534 0097 10	0-N1601	534 0123 20	0-N1445
534 0005 10	0-N2180	534 0041 10	0-N1489S	534 0097 10	0-N1601S	534 0123 20	0-N1445S
534 0006 10	0-N1011	534 0043 10	0-N1513	534 0098 10	0-N1955	534 0124 30	0-N1588
534 0006 10	0-N1011S	534 0043 10	0-N1513S	534 0098 10	0-N1955S	534 0124 30	0-N1588S
534 0007 10	0-N1013	534 0044 10	0-N1508	534 0100 20	0-N1472	534 0125 30	0-N1443
534 0007 10	0-N1013S	534 0044 10	0-N1508S	534 0100 20	0-N1472S	534 0125 30	0-N1443S
534 0008 10	0-N1559S	534 0045 10	0-N1525	534 0101 20	0-N1487	534 0126 30	0-N1657
534 0009 10	0-N2135	534 0045 10	0-N1525S	534 0101 20	0-N1487S	534 0126 30	0-N1657S
534 0010 10	0-N1542S	534 0046 10	0-N2093	534 0102 30	0-N1322	534 0127 30	0-N1671
534 0011 10	0-N1543	534 0046 10	0-N2093S	534 0102 30	0-N1322S	534 0127 30	0-N1671S
534 0013 10	0-N214	534 0047 10	0-N1491S	534 0103 10	0-N1529	534 0128 20	0-N1497
534 0014 10	0-N1441	534 0049 10	0-N1516	534 0103 10	0-N1529S	534 0128 20	0-N1497S
534 0014 10	0-N1441S	534 0049 10	0-N1516S	534 0104 10	0-N1291	534 0129 20	0-N1897
534 0016 10	0-N1462	534 0050 10	0-N1791	534 0104 10	0-N1291S	534 0129 20	0-N1897S
534 0016 10	0-N1462S	534 0050 10	0-N1791S	534 0105 20	0-N152	534 0130 20	0-N1435
534 0017 10	0-N1488	534 0051 10	0-N1515	534 0105 20	0-N152S	534 0130 20	0-N1435S
534 0017 10	0-N1488S	534 0051 10	0-N1515S	534 0106 20	0-N1595	534 0131 20	0-N1434
534 0018 10	0-N1467S	534 0053 10	0-N1526	534 0106 20	0-N1595S	534 0131 20	0-N1434S
534 0021 10	0-N1732	534 0053 10	0-N1526S	534 0108 20	0-N1464	534 01314 10 + 533 00	0-N2095
534 0021 10	0-N1732S	534 0058 10	0-N1323	534 0108 20	0-N1464S	534 01314 10 + 533 00	0-N2095S
534 0022 10	0-N1391	534 0059 10	0-N1530	534 0109 10	0-N2117	534 0132 30	0-N1494
534 0022 10	0-N1391S	534 0059 10	0-N1530S	534 0109 10	0-N2117S	534 0132 30	0-N1494S
534 0024 10	0-N1717	534 0065 10	0-N1733	534 0109 20	0-N1407	534 0133 30	0-N1518

INA		INA		INA		INA	
534 0133 30	0-N1518S	534 0166 10	0-N1885S1	534 0244 10	0-N1941S3	534 0282 10	0-N2398S
534 0134 30	0-N1438	534 0166 10	0-N1885S2	534 0246 10	0-N2209	534 0283 10	0-N1812
534 0134 30	0-N1438S	534 0167 10	0-N1659	534 0246 10	0-N2209S	534 0283 10	0-N1812S
534 0135 30	0-N1558S	534 0167 10	0-N1659S	534 0247 10	0-N1677	534 0284 10	0-N2103
534 0136 30	0-N1459	534 0168 10	0-N1643	534 0247 10	0-N1677S	534 0284 10	0-N2103S
534 0136 30	0-N1459S	534 0168 10	0-N1643S	534 0248 10	0-N1556S	534 0285 10	0-N2105
534 0137 30	0-N1555	534 0169 10	0-N1477	534 0249 10	0-N1639	534 0285 10	0-N2105S
534 0137 30	0-N1555S	534 0169 10	0-N1477S	534 0249 10	0-N1639S	534 0286 10	0-N2182
534 0138 30	0-N1539	534 0170 10	0-N1790	534 0250 10	0-N1673	534 0286 10	0-N2182S
534 0138 30	0-N1539S	534 0171 10	0-N1900	534 0250 10	0-N1673S	534 0287 10	0-N2104
534 0139 30	0-N1535	534 0172 10	0-N1891	534 0251 10	0-N1851	534 0287 10	0-N2104S
534 0139 30	0-N1535S	534 0173 10	0-N1961	534 0251 10	0-N1851S	534 0288 10	0-N2219
534 0140 30	0-N1606	534 0174 10	0-N1482S	534 0252 10	0-N1788	534 0288 10	0-N2219S
534 0140 30	0-N1606S	534 0175 10	0-N1537	534 0252 10	0-N1788S	534 0290 10	0-N1532
534 0141 30	0-N1476	534 0175 10	0-N1537S	534 0253 10	0-N1621	534 0290 10	0-N1532S
534 0141 30	0-N1476S	534 0176 10	0-N1890	534 0253 10	0-N1621S	534 0293 10	0-N2034
534 0142 30	0-N1611	534 0176 10	0-N1890S	534 0254 10	0-N1842	534 0293 10	0-N2034S
534 0142 30	0-N1611S	534 0177 10	0-N1794	534 0254 10	0-N1842S	534 0295 10	0-N2113
534 0144 10	0-N1957	534 0177 10	0-N1794S	534 0255 10	0-N1945	534 0295 10	0-N2113S
534 0144 10	0-N1957S	534 0178 10	0-N2072	534 0255 10	0-N1945S	534 0296 10	0-N1908
534 0145 10	0-N1533	534 0179 10	0-N1620	534 0257 10	0-N1710	534 0296 10	0-N1908S
534 0145 10	0-N1533S	534 0179 10	0-N1620S	534 0257 10	0-N1710S	534 0297 10	0-N2226
534 0146 10	0-N1520	534 0180 10	0-N1636	534 0261 10	0-N1850	534 0297 10	0-N2226S
534 0146 10	0-N1520S	534 0180 10	0-N1636S	534 0261 10	0-N1850S	534 0299 10	0-N2250
534 0146 10	0-N1610	534 0181 10	0-N1731	534 0262 10	0-N2183	534 0299 10	0-N2250S
534 0147 10	0-N1799	534 0181 10	0-N1731S	534 0262 10	0-N2183S	534 0306 10	0-N1815
534 0147 10	0-N1799S	534 0182 10	0-N2184	534 0263 10	0-N1877	534 0306 10	0-N1815S
534 0150 10	0-N1536	534 0182 10	0-N2184S	534 0263 10	0-N1877S	534 0307 10	0-N1676
534 0150 10	0-N1536S	534 0183 10	0-N1902	534 0264 10	0-N2148	534 0307 10	0-N1676S
534 0151 10	0-N1531	534 0183 10	0-N1902S	534 0268 10	0-N1964	534 0308 10	0-N2014
534 0151 10	0-N1531S	534 0184 10	0-N2066	534 0268 10	0-N1964S	534 0308 10	0-N2014S
534 0153 10	0-N1407	534 0185 10	0-N1432	534 0269 10	0-N1664	534 0309 10	0-N1709
534 0153 10	0-N1407S	534 0186 10	0-N1656	534 0269 10	0-N1664S	534 0309 10	0-N1709S1
534 0156 10	0-N2029	534 0186 10	0-N1656S	534 0270 10	0-N1742	534 0309 10	0-N1709S2
534 0156 10	0-N2029S	534 0187 10	0-N1704	534 0270 10	0-N1742S	534 0312 10	0-N1855
534 0159 10	0-N2124	534 0187 10	0-N1704S	534 0271 10	0-N1663	534 0312 10	0-N1855S
534 0159 10	0-N2124S	534 0188 10	0-N1920	534 0271 10	0-N1663S	534 0313 10	0-N1551
534 0160 10	0-N1492	534 0239 10	0-N1923	534 0273 10	0-N2109	534 0313 10	0-N1551S
534 0160 10	0-N1492S	534 0240 10	0-N1802	534 0273 10	0-N2109S	534 0314 10	0-N2095
534 0161 10	0-N1390	534 0240 10	0-N1802S	534 0274 10	0-N2190	534 0314 10	0-N2095S
534 0161 10	0-N1390S	534 0241 10	0-N1503	534 0274 10	0-N2190S	534 0315 10	0-N2046
534 0162 10	0-N1557S	534 0241 10	0-N1503S	534 0278 10	0-N1954	534 0315 10	0-N2046S
534 0163 10	0-N1626	534 0242 10	0-N2045	534 0278 10	0-N1954S	534 0316 10	0-N2158
534 0163 10	0-N1626S	534 0242 10	0-N2045S	534 0279 10	0-N2155	534 0316 10	0-N2158S
534 0164 10	0-N1534	534 0243 10	0-N1946	534 0279 10	0-N2155S	534 0317 10	0-N1875
534 0164 10	0-N1534S	534 0243 10	0-N1946S1	534 0280 10	0-N1714	534 0317 10	0-N1875S
534 0165 10	0-N1886	534 0243 10	0-N1946S2	534 0280 10	0-N1714S	534 0318 10	0-N2055
534 0165 10	0-N1886S1	534 0244 10	0-N1941	534 0281 10	0-N2039	534 0318 10	0-N2055S
534 0165 10	0-N1886S2	534 0244 10	0-N1941S1	534 0281 10	0-N2039S	534 0319 10	0-N1979
534 0166 10	0-N1885	534 0244 10	0-N1941S2	534 0282 10	0-N2398	534 0319 10	0-N1979S



INA		INA		INA		INA	
534 0320 10	0-N1958	534 0365 10	0-N2232S	534 0420 10	0-N2387S	534 0453 10	0-N2114
534 0320 10	0-N1958S	534 0366 10	0-N2031	534 0421 10	0-N1698	534 0453 10	0-N2114S
534 0321 10	0-N1798	534 0366 10	0-N2031S	534 0421 10	0-N1698S	534 0455 10	0-N2390
534 0321 10	0-N1798S	534 0367 10	0-N2231	534 0422 10	0-N1832	534 0455 10	0-N2390S
534 0324 10	0-N2242	534 0367 10	0-N2231S	534 0422 10	0-N1832S	534 0457 10	0-N2035
534 0324 10	0-N2242S	534 0369 10	0-N2268	534 0423 10	0-N1813	534 0457 10	0-N2035S
534 0325 10	0-N2112	534 0369 10	0-N2268S	534 0423 10	0-N1813S	534 0458 10	0-N2210
534 0325 10	0-N2112S	534 0370 10	0-N2136	534 0428 10	0-N2392	534 0458 10	0-N2210S
534 0326 10	0-N1811	534 0370 10	0-N2136S	534 0428 10	0-N2392S	534 0460 10	0-N1876
534 0326 10	0-N1811S	534 0372 10	0-N2299	534 0429 10	0-N2247	534 0460 10	0-N1876S
534 0329 10	0-N1653S	534 0372 10	0-N2299S	534 0429 10	0-N2247S	534 0467 10	0-N2266
534 0331 10	0-N1793	534 0373 10	0-N2269	534 0430 10	0-N2108	534 0467 10	0-N2266S1
534 0331 10	0-N1793S	534 0373 10	0-N2269S	534 0430 10	0-N2108S	534 0467 10	0-N2266S2
534 0333 10	0-N2026	534 0374 10	0-N2091	534 0431 10	0-N2246	534 0470 10	0-N2287
534 0333 10	0-N2026S	534 0374 10	0-N2091S	534 0431 10	0-N2246S1	534 0470 10	0-N2287S
534 0334 10	0-N2037	534 0375 10	0-N1830	534 0431 10	0-N2246S2	534 0474 10	0-N2265
534 0334 10	0-N2037S	534 0375 10	0-N1830S	534 0431 10	0-N2246S3	534 0474 10	0-N2265S
534 0335 10	0-N2017	534 0390 10	0-N2137	534 0432 10	0-N2252	534 0477 10	0-N2270
534 0335 10	0-N2017S	534 0390 10	0-N2137S	534 0432 10	0-N2252S	534 0477 10	0-N2270S
534 0336 10	0-N2083	534 0396 10	0-N2092	534 0434 10	0-N2038	534 0479 10	0-N2405
534 0336 10	0-N2083S	534 0396 10	0-N2092S	534 0434 10	0-N2038S	534 0479 10	0-N2405S
534 0338 10	0-N2245	534 0400 10	0-N1808	534 0435 10	0-N2089	534 0481 10	0-N1641
534 0338 10	0-N2245S1	534 0400 10	0-N1808S	534 0435 10	0-N2089S	534 0481 10	0-N1641S
534 0338 10	0-N2245S2	534 0401 10	0-N2082	534 0436 10	0-N2204	534 0482 10	0-N2216
534 0338 10	0-N2245S3	534 0401 10	0-N2082S	534 0436 10	0-N2204S	534 0482 10	0-N2216S1
534 0339 10	0-N2193	534 0402 10	0-N2084	534 0437 10	0-N2098	534 0482 10	0-N2216S2
534 0339 10	0-N2193S	534 0402 10	0-N2084S	534 0437 10	0-N2098S	534 0487 10	0-N2289
534 0341 10	0-N1552	534 0403 10	0-N2396	534 0438 10	0-N2389	534 0487 10	0-N2289S
534 0345 10	0-N2075	534 0403 10	0-N2396S	534 0438 10	0-N2389S	534 0489 10	0-N2267
534 0346 10	0-N2111	534 0404 10	0-N2030	534 0439 10	0-N2087	534 0489 10	0-N2267S
534 0346 10	0-N2111S	534 0404 10	0-N2030S	534 0439 10	0-N2087S	534 0493 10	0-N2399
534 0348 10	0-N2032	534 0406 10	0-N1858	534 0441 10	0-N2194	534 0493 10	0-N2399S
534 0348 10	0-N2032S	534 0406 10	0-N1858S	534 0441 10	0-N2194S	534 0505 10	0-N2217
534 0350 10	0-N2187	534 0407 10	0-N2064	534 0442 10	0-N1869	534 0505 10	0-N2217S1
534 0351 10	0-N2067	534 0408 10	0-N2107	534 0442 10	0-N1869S	534 0505 10	0-N2217S2
534 0353 10	0-N2197	534 0408 10	0-N2107S	534 0443 10	0-N2422	534 0506 10	0-N2293
534 0353 10	0-N2197S	534 0409 10	0-N2198	534 0443 10	0-N2422S	534 0506 10	0-N2293S
534 0356 10	0-N1918	534 0409 10	0-N2198S	534 0445 10	0-N2241	534 0507 10	0-N2300
534 0356 10	0-N1918S	534 0411 10	0-N2230	534 0445 10	0-N2241S	534 0507 10	0-N2300S
534 0357 10	0-N2188	534 0411 10	0-N2230S	534 0446 10	0-N2401	534 0508 10	0-N2394
534 0357 10	0-N2188S	534 0412 10	0-N1797	534 0446 10	0-N2401S1	534 0508 10	0-N2394S
534 0359 10	0-N2211	534 0412 10	0-N1797S	534 0446 10	0-N2401S2	534 0509 10	0-N2259
534 0359 10	0-N2211S	534 0415 10	0-N2251	534 0447 10	0-N1874	534 0511 10	0-N2279
534 0360 10	0-N1880	534 0415 10	0-N2251S1	534 0447 10	0-N1874S	534 0511 10	0-N2279S
534 0360 10	0-N1880S	534 0415 10	0-N2251S2	534 0448 10	0-N2203	534 0516 10	0-N2215
534 0361 10	0-N2397	534 0417 10	0-N2202	534 0448 10	0-N2203S	534 0516 10	0-N2215S
534 0361 10	0-N2397S	534 0417 10	0-N2202S	534 0450 10	0-N2402	534 0533 10	0-N2388
534 0362 10	0-N1840	534 0419 10	0-N2407	534 0450 10	0-N2402S	534 0533 10	0-N2388S
534 0362 10	0-N1840S	534 0419 10	0-N2407S	534 0452 10	0-N2192	534 0536 10	0-N2400
534 0365 10	0-N2232	534 0420 10	0-N2387	534 0452 10	0-N2192S	534 0536 10	0-N2400S

INA		INA		INA		INA	
534 0537 10	0-N2301	534006510	0-N1733	534014610	0-N1610	534024310	0-N1946S2
534 0537 10	0-N2301S	534006510	0-N1733S	534014710	0-N1799	534024410	0-N1941
534 0538 10	0-N2395	534006710	0-N1670	534014710	0-N1799S	534024410	0-N1941S1
534 0538 10	0-N2395S	534006810	0-N2042	534015610	0-N2029	534024410	0-N1941S2
534 0540 10	0-N2403	534007220	0-N1284	534015610	0-N2029S	534024410	0-N1941S3
534 0540 10	0-N2403S	534007320	0-N1285	534015910	0-N2124	534024610	0-N2209
534 0541 10	0-N2404	534007420	0-N1287	534015910	0-N2124S	534024610	0-N2209S
534 0541 10	0-N2404S	534007520	0-N1339	534016010	0-N1492	534024710	0-N1677
534 0545 10	0-N2393	534007520	0-N1339S	534016010	0-N1492S	534024910	0-N1639
534 0545 10	0-N2393S	534007820	0-N1279	534016310	0-N1626	534024910	0-N1639S
534 0547 10	0-N2406	534007920	0-N1043	534016310	0-N1626S	534025010	0-N1673
534 0547 10	0-N2406S	534008330	0-N1953	534016510	0-N1886	534025010	0-N1673S
534 0548 10	0-N2391	534008330	0-N1953S	534016510	0-N1886S1	534025210	0-N1788
534 0548 10	0-N2391S	534009410	0-N1658	534016510	0-N1886S2	534025210	0-N1788S
534 0549 10	0-N2306	534009610	0-N1805	534016610	0-N1885	534025310	0-N1621
534 0549 10	0-N2306S	534009610	0-N1805S	534016610	0-N1885S1	534025310	0-N1621S
534 0550 10	0-N2214	534009810	0-N1955	534016610	0-N1885S2	534025710	0-N1710
534 0550 10	0-N2214S	534009810	0-N1955S	534016710	0-N1659	534026110	0-N1850
534 0551 10	0-N2290	534010410	0-N1291	534016810	0-N1643	534026110	0-N1850S
534 0551 10	0-N2290S	534010410	0-N1291S	534016810	0-N1643S	534026210	0-N2183
534 0552 10	0-N2288	534010520	0-N152	534016910	0-N1477	534026210	0-N2183S
534 0552 10	0-N2288S	534010620	0-N1595	534017010	0-N1790	534026310	0-N1877
534 0568 10	0-N1552S	534010620	0-N1595S	534017110	0-N1900	534026410	0-N2148
534000110	0-N1511	534010920	0-N1407	534017210	0-N1891	534026810	0-N1964
534000510	0-N2180	534011020	0-N1493	534017310	0-N1961	534026810	0-N1964S
534000610	0-N1011	534011120	0-N1471	534017510	0-N1537	534026910	0-N1664
534000610	0-N1011S	534011220	0-N2053	534017510	0-N1537S	534026910	0-N1664S
534000710	0-N1013	534011320	0-N1809	534017610	0-N1890	534027010	0-N1742
534000710	0-N1013S	534011320	0-N1809S	534017610	0-N1890S	534027010	0-N1742S
534000910	0-N2135	534011420	0-N1645	534017710	0-N1794	534027110	0-N1663
534001110	0-N1543	534011420	0-N1645S	534017710	0-N1794S	534027110	0-N1663S
534001310	0-N214	534011520	0-N1466	534017810	0-N2072	534027310	0-N2109
534001610	0-N1462	534011520	0-N1466S	534017910	0-N1620	534027410	0-N2190
534001610	0-N1462S	534011620	0-N1083	534017910	0-N1620S	534027410	0-N2190S
534002110	0-N1732	534012020	0-N1528	534018010	0-N1636	534027810	0-N1954
534002410	0-N1717	534012020	0-N1528S	534018210	0-N2184	534027810	0-N1954S
534002710	0-N1427	534012110	0-N1512	534018210	0-N2184S	534027910	0-N2155
534002710	0-N1427S	534012110	0-N1512S	534018310	0-N1902	534027910	0-N2155S
534003010	0-N2096	534012320	0-N1445	534018310	0-N1902S	534028010	0-N1714
534003110	0-N1719	534012320	0-N1445S	534018410	0-N2066	534028110	0-N2039
534003110	0-N1719S	534012430	0-N1588	534018610	0-N1656	534028110	0-N2039S
534003310	0-N1485	534012430	0-N1588S	534018610	0-N1656S	534028310	0-N1812
534003310	0-N1485S	534012630	0-N1657	534018710	0-N1704	534028310	0-N1812S
534003710	0-N1486	534012630	0-N1657S	534018810	0-N1920	534028410	0-N2103
534003910	0-N1669	534012730	0-N1671	534023910	0-N1923	534028510	0-N2105
534004510	0-N1525	534013230	0-N1494	534024010	0-N1802	534028610	0-N2182
534004510	0-N1525S	534013230	0-N1494S	534024010	0-N1802S	534028610	0-N2182S
534004610	0-N2093	534014130	0-N1476	534024210	0-N2045	534028710	0-N2104
534005010	0-N1791	534014130	0-N1476S	534024310	0-N1946	534028710	0-N2104S
534005810	0-N1323	534014230	0-N1611	534024310	0-N1946S1	534028810	0-N2219



INA		INA		INA		INA	
534028810	0-N2219S	534035010	0-N2187	534043510	0-N2089	F-123809	0-N928
534029310	0-N2034	534035110	0-N2067	534043510	0-N2089S	F-123811	0-N926
534029510	0-N2113	534035610	0-N1918	534043610	0-N2204	F-123816	0-N905
534029610	0-N1908	534035610	0-N1918S	534043610	0-N2204S	F-123996	0-N995
534029610	0-N1908S	534035710	0-N2188	534043710	0-N2098	F-123997	0-N996
534029710	0-N2226	534035710	0-N2188S	534043910	0-N2087	F-124048	0-N053
534029710	0-N2226S	534035910	0-N2211	534044110	0-N2194	F-124053	0-N986
534029910	0-N2250	534035910	0-N2211S	534044110	0-N2194S	F-124060	0-N988
534029910	0-N2250S	534036010	0-N1880	534044210	0-N1869	F-124062	0-N990
534030610	0-N1815	534036010	0-N1880S	534044210	0-N1869S	F-124063	0-N997
534030610	0-N1815S	534036510	0-N2232	534044510	0-N2241	F-124065	0-N032
534030710	0-N1676	534036510	0-N2232S	534044510	0-N2241S	F-124066	0-N072
534030810	0-N2014	534036610	0-N2031	534044710	0-N1874	F-124067	0-N071
534030810	0-N2014S	534036710	0-N2231	534044810	0-N2203	F-124068	0-N073
534030910	0-N1709	534036710	0-N2231S	534044810	0-N2203S	F-124069	0-N059
534031610	0-N2158	534037010	0-N2136	534045210	0-N2192	F-124071	0-N989
534031610	0-N2158S	534037410	0-N2091	534045210	0-N2192S	F-124072	0-N991
534031710	0-N1875	534037510	0-N1830	534045310	0-N2114	F-124091	0-N074
534031710	0-N1875S	534037510	0-N1830S	534045710	0-N2035	F-124092	0-N064
534031810	0-N2055	534039010	0-N2137	534045710	0-N2035S	F-140055	0-N837
534031910	0-N1979	534039010	0-N2137S	535 0139 10	0-N870	F-140056	0-N842
534031910	0-N1979S	534039610	0-N2092	F-110628.3	0-N951	F-140057.2	0-N985
534032010	0-N1958	534039610	0-N2092S	F-120046.4	0-N869	F-140061	0-N155
534032010	0-N1958S	534040010	0-N1808	F-120180	0-N880	F-140062	0-N156
534032110	0-N1798	534040110	0-N2082	F-120552	0-N870	F-140066	0-N891
534032110	0-N1798S	534040210	0-N2084	F-121338.5	0-N124	F-140075	0-N897
534032510	0-N2112	534040210	0-N2084S	F-121586	0-N141	F-140076	0-N898
534032510	0-N2112S	534040410	0-N2030	F-121977.1	0-N095	F-140077	0-N899
534032610	0-N1811	534040610	0-N1858	F-122576	0-N121	F-202858	0-N859
534032610	0-N1811S	534040610	0-N1858S	F-122598	0-N125	F-203093	0-N818
534033110	0-N1793	534040710	0-N2064	F-122598	0-N125S	F-203800	0-N826
534033110	0-N1793S	534040810	0-N2107	F-123137	0-N964	F-210045	0-N837
534033310	0-N2026	534040910	0-N2198	F-123149	0-N913	F-210963.1	0-N924
534033310	0-N2026S	534040910	0-N2198S	F-123623	0-N922	F-211941.4	0-N866
534033410	0-N2037	534041110	0-N2230	F-123629	0-N940	F-218999	0-N860
534033510	0-N2017	534041110	0-N2230S	F-123633	0-N823	F-219476	0-N866
534033510	0-N2017S	534041210	0-N1797	F-123638	0-N832	F-220084	0-N954
534033610	0-N2083	534041710	0-N2202	F-123640	0-N800	F-220085	0-N867
534033610	0-N2083S	534041710	0-N2202S	F-123641	0-N801	F-220086	0-N875
534033810	0-N2245	534042110	0-N1698	F-123647	0-N919	F-220088	0-N917
534033810	0-N2245S1	534042110	0-N1698S	F-123648	0-N912	F-220089	0-N838
534033810	0-N2245S2	534042310	0-N1813	F-123650	0-N889	F-220096	0-N807
534033810	0-N2245S3	534042310	0-N1813S	F-123656	0-N028	F-220125	0-N923
534033910	0-N2193	534043010	0-N2108	F-123657	0-N029	F-220257	0-N818
534033910	0-N2193S	534043110	0-N2246	F-123661	0-N135	F-220275	0-N877
534034510	0-N2075	534043110	0-N2246S1	F-123665	0-N941	F-220276	0-N876
534034610	0-N2111	534043110	0-N2246S2	F-123666	0-N925	F-220285	0-N162
534034610	0-N2111S	534043110	0-N2246S3	F-123802	0-N094	F-220286	0-N960
534034810	0-N2032	534043210	0-N2252	F-123804	0-N937	F-224693	0-N930
534034810	0-N2032S	534043210	0-N2252S	F-123805	0-N927	F-225532	0-N920

INA

F-225765	0-N921
F-227244	0-N165
F-228533	0-N172
F-231218	0-N159
F-232479	0-N113
F-234846	0-N169
F-37734.2	0-N857
F-38149	0-N883
F-38153	0-N887
F-38317	0-N812
F-38317-C	0-N812
F-38392	0-N815
F-38931	0-N849
F-38950	0-N856
F-56900	0-N839
F-82302.9	0-N809
F-82798	0-N839

IPD

10-0021	0-N1660
10-0022	0-N1445
10-0022	0-N1445S
10-0035	0-N1299
10-0035	0-N1299S
10-0036	0-N1300
10-0036	0-N1300S
10-0040	0-N1511
100041	0-N1861
10-0041	0-N1860
10-0050	0-N1441
10-0050	0-N1441S
10-0052	0-N1543
10-0053	0-N152
10-0053	0-N152S
10-0054	0-N1470
10-0054	0-N1470S
10-0055	0-N1488
10-0055	0-N1488S
10-0081	0-N1041
10-0081	0-N1041S
10-0152	0-N1472
10-0152	0-N1472S
10-0154	0-N1756
10-0179	0-N1473
10-0179	0-N1473S
10-0180	0-N2172
10-0180	0-N2172S
10-0257	0-N1464
10-0257	0-N1464S
10-0283	0-N1363
10-0284	0-N1371

IPD

10-0342	0-N1407
10-0342	0-N1407S
10-0345	0-N1595
10-0345	0-N1595S
10-0365	0-N1487
10-0365	0-N1487S
10-0369	0-N1484
10-0369	0-N1484S
10-0374	0-N1438
10-0374	0-N1438S
10-0375	0-N1410
10-0375	0-N1410S
10-0429	0-N1485
10-0429	0-N1485S
10-0431	0-N1322
10-0431	0-N1322S
10-0460	0-N1645
10-0460	0-N1645S
10-0461	0-N1282
10-0462	0-N1822
10-0462	0-N1822S
10-0463	0-N1083
10-0464	0-N1657
10-0464	0-N1657S
10-0467	0-N2135
10-0475	0-N2140
10-0477	0-N1290
10-0477	0-N1290S
10-0478	0-N1294
10-0478	0-N1294S
10-0487	0-N1291
10-0487	0-N1291S
10-0546	0-N1796
10-0546	0-N1796S
10-0547	0-N1897
10-0547	0-N1897S
10-0574	0-N1493
10-0574	0-N1493S
10-0575	0-N1471
10-0575	0-N1471S
10-0576	0-N1857
10-0576	0-N1857S
10-0577	0-N2053
10-0577	0-N2053S
10-0578	0-N1809
10-0578	0-N1809S
10-0579	0-N1810
10-0579	0-N1810S
10-0668	0-N1466
10-0668	0-N1466S

IPD

10-0669	0-N1588
10-0669	0-N1588S
10-0671	0-N1013
10-0671	0-N1013S
10-0677	0-N1625
10-0677	0-N1625S
10-0678	0-N1011
10-0678	0-N1011S
10-0683	0-N1289
10-0690	0-N1703
10-0691	0-N1279
10-0692	0-N1641
10-0692	0-N1641S
10-0693	0-N1043
10-0695	0-N2180
10-0698	0-N1538
10-0698	0-N1538S
10-0716	0-N1512
10-0716	0-N1512S
10-0719	0-N1903
10-0742	0-N1717
10-0742	0-N1717S
10-0747	0-N1469
10-0769	0-N1339
10-0769	0-N1339S
10-0839	0-N1558S
10-0848	0-N1483
10-0848	0-N1483S
10-0850	0-N1818
10-0854	0-N1539
10-0854	0-N1539S
10-0857	0-N1494
10-0857	0-N1494S
10-0859	0-N1459
10-0859	0-N1459S
10-0862	0-N1486
10-0862	0-N1486S
10-0867	0-N1528
10-0867	0-N1528S
10-0875	0-N1497
10-0875	0-N1497S
10-0887	0-N1669
10-0887	0-N1669S
10-0892	0-N1284
10-0893	0-N1285
10-0894	0-N1287
10-0955	0-N1671
10-0955	0-N1671S
10-0986	0-N2170
10-0986	0-N2170S

IPD

10-0987	0-N1611
10-0987	0-N1611S
10-0989	0-N1476
10-0989	0-N1476S
10-0991	0-N1609
10-1002	0-N1092
10-1003	0-N1481
10-1003	0-N1481S
10-1009	0-N1732
10-1009	0-N1732S
10-1033	0-N1953
10-1033	0-N1953S
10-1043	0-N1791
10-1043	0-N1791S
10-1056	0-N1427
10-1056	0-N1427S
10-1067	0-N1719
10-1067	0-N1719S
10-1070	0-N1525
10-1070	0-N1525S
11-0014	0-N2146
11-0015	0-N2145
11-0016	0-N1951
11-0017	0-N2147
11-0018	0-N2144
11-0851	0-N1967
11-0856	0-N2414
11-0877	0-N2157
11-1013	0-N1971
11-1015	0-N2415
11-1016	0-N2162
11-1018	0-N2163
11-1064	0-N1567
13-0023	0-N1800
13-0062	0-N2412
13-0066	0-N2413
13-0153	0-N1747
13-0172	0-N2411
13-0173	0-N1932
13-0177	0-N1757
13-0262	0-N1275
13-0263	0-N1237
13-0265	0-N1274
13-0267	0-N1344
13-0268	0-N1364
13-0269	0-N1372
13-0282	0-N1276
13-0341	0-N1051
13-0341	0-N1051S
13-0432	0-N2169



IPD		IPD		IPD		IPD	
13-0470	0-N2410	14-0102	0-N808	14-0212	0-N891	14-0352	0-N021
13-0471	0-N1787	14-0103	0-N806	14-0216	0-N1273	14-0353	0-N032
13-0476	0-N1303	14-0105	0-N923	14-0220	0-N1223	14-0354	0-N025
13-0480	0-N2409	14-0109	0-N940	14-0224	0-N969	14-0355	0-N030
13-0481	0-N1293	14-0111	0-N132	14-0229	0-N1057	14-0358	0-N028
13-0483	0-N1974	14-0113	0-N1444	14-0230	0-N017	14-0360	0-N024
13-0484	0-N1758	14-0115	0-N921	14-0231	0-N018	14-0363	0-N022
13-0543	0-N1049	14-0116	0-N109	14-0232	0-N020	14-0366	0-N1748
13-0650	0-N2181	14-0117	0-N924	14-0233	0-N916	14-0371	0-N1058
13-0712	0-N1569	14-0118	0-N160	14-0234	0-N019	14-0373	0-N968
13-0713	0-N1342	14-0136	0-N859	14-0251	0-N047	14-0379	0-N034
13-0714	0-N2142	14-0139	0-N159	14-0252	0-N046	14-0380	0-N1760
14-0020	0-N105	14-0142	0-N158	14-0253	0-N049	14-0395	0-N182
14-0024	0-N1313	14-0148	0-N1599	14-0255	0-N048	14-0396	0-N185
14-0028	0-N1005	14-0148	0-N1599S	14-0256	0-N2168	14-0397	0-N191
14-0030	0-N1263	14-0149	0-N118P	14-0259	0-N1265	14-0399	0-N191
14-0031	0-N1432S	14-0151	0-N214	14-0261	0-N107	14-0400	0-N811
14-0032	0-N1317	14-0155	0-N1261	14-0264	0-N1048	14-0402	0-N901
14-0032	0-N1317S	14-0157	0-N063	14-0266	0-N1050	14-0403	0-N871
14-0039	0-N1741	14-0161	0-N194	14-0270	0-N974	14-0404	0-N133
14-0039	0-N1741S	14-0162	0-N195	14-0272	0-N970	14-0408	0-N944
14-0043	0-N295	14-0163	0-N196	14-0273	0-N973	14-0410	0-N1320
14-0045	0-N2047	14-0164	0-N198	14-0279	0-N1112	14-0413	0-N861
14-0047	0-N201	14-0165	0-N199	14-0281	0-N1969	14-0415	0-N1222
14-0048	0-N116	14-0166	0-N200	14-0288	0-N150	14-0419	0-N1749
14-0049	0-N117	14-0171	0-N1640	14-0289	0-N2336	14-0419	0-N1749S
14-0057	0-N1752	14-0171	0-N1640S	14-0291	0-N2179	14-0420	0-N095
14-0060	0-N1266	14-0183	0-N1754	14-0293	0-N1111	14-0423	0-N2015
14-0061	0-N800	14-0184	0-N060	14-0298	0-N149	14-0434	0-N956
14-0068	0-N937	14-0185	0-N062	14-0299	0-N137	14-0436	0-N127
14-0070	0-N1232	14-0186	0-N064	14-0301	0-N2332	14-0444	0-N877
14-0072	0-N1312	14-0187	0-N186	14-0304	0-N883	14-0445	0-N948
14-0073	0-N1229	14-0188	0-N056	14-0305	0-N887	14-0447	0-N100
14-0074	0-N1230	14-0189	0-N052	14-0307	0-N856	14-0448	0-N879
14-0075	0-N129	14-0190	0-N987	14-0308	0-N857	14-0449	0-N910
14-0076	0-N939	14-0191	0-N053	14-0309	0-N913	14-0450	0-N102
14-0077	0-N1236	14-0194	0-N051	14-0310	0-N173	14-0455	0-N101
14-0079	0-N1042	14-0195	0-N065	14-0312	0-N854	14-0456	0-N126
14-0080	0-N157	14-0196	0-N059	14-0313	0-N863	14-0469	0-N1514
14-0082	0-N108	14-0197	0-N188	14-0314	0-N880	14-0469	0-N1514S
14-0084	0-N110	14-0198	0-N061	14-0315	0-N882	14-0474	0-N1292
14-0087	0-N163	14-0199	0-N184	14-0318	0-N139	14-0485	0-N1927
14-0088	0-N1238	14-0201	0-N897	14-0321	0-N964	14-0489	0-N1296
14-0090	0-N1258	14-0202	0-N899	14-0322	0-N2333	14-0490	0-N1295
14-0095	0-N106	14-0204	0-N894	14-0323	0-N2334	14-0490	0-N1295S
14-0096	0-N104	14-0206	0-N898	14-0332	0-N112	14-0492	0-N1301
14-0097	0-N1417	14-0207	0-N1243	14-0334	0-N145	14-0494	0-N809
14-0099	0-N103	14-0208	0-N237	14-0337	0-N135	14-0495	0-N954
14-0100	0-N805	14-0209	0-N236	14-0338	0-N134	14-0497	0-N955
14-0101	0-N922	14-0210	0-N928	14-0350	0-N094	14-0498	0-N1304

IPD		IPD		IPD		IPD	
14-0499	0-N925	14-0593	0-N1256	14-0708	0-N981	14-0818	0-N993
14-0500	0-N801	14-0594	0-N1362	14-0711	0-N1781	14-0820	0-N001
14-0501	0-N1682	14-0597	0-N1755	14-0720	0-N055	14-0821	0-N000
14-0502	0-N815	14-0598	0-N1825	14-0722	0-N1561	14-0824	0-N013
14-0504	0-N813	14-0600	0-N860	14-0723	0-N975	14-0826	0-N1836
14-0505	0-N812	14-0601	0-N917	14-0725	0-N183	14-0828	0-N2059
14-0507	0-N811	14-0603	0-N1231	14-0726	0-N986	14-0830	0-N181
14-0508	0-N869	14-0606	0-N2315	14-0727	0-N054	14-0831	0-N1917
14-0509	0-N870	14-0609	0-N959	14-0729	0-N1349	14-0833	0-N1883
14-0515	0-N849	14-0610	0-N930	14-0740	0-N1062	14-0833	0-N1883S
14-0518	0-N121	14-0614	0-N919	14-0744	0-N1948	14-0835	0-N2319
14-0521	0-N931	14-0617	0-N1442	14-0745	0-N1216	14-0845	0-N1806
14-0523	0-N1751	14-0620	0-N037	14-0748	0-N1654	14-0847	0-N1351
14-0524	0-N1713	14-0621	0-N043	14-0753	0-N1829	14-0849	0-N1817
14-0525	0-N1722	14-0623	0-N038	14-0755	0-N1462	14-0849	0-N1817S
14-0528	0-N2174	14-0624	0-N2323	14-0755	0-N1462S	14-0853	0-N1045
14-0530	0-N1899	14-0625	0-N039	14-0756	0-N193	14-0860	0-N805
14-0531	0-N125	14-0628	0-N036	14-0758	0-N1127	14-0863	0-N1712
14-0531	0-N125S	14-0632	0-N1498	14-0761	0-N1774	14-0872	0-N1085
14-0534	0-N1750	14-0634	0-N1767	14-0764	0-N1220	14-0881	0-N1367
14-0536	0-N2173	14-0636	0-N066	14-0767	0-N1382	14-0895	0-N1054
14-0537	0-N1968	14-0639	0-N068	14-0770	0-N294	14-0896	0-N1627
14-0538	0-N1949	14-0640	0-N1604	14-0771	0-N290	14-0896	0-N1627S
14-0539	0-N1904	14-0641	0-N1562	14-0774	0-N293	14-0899	0-N1720
14-0539	0-N1975	14-0642	0-N1071	14-0775	0-N1779	14-0899	0-N1720S
14-0544	0-N1056	14-0643	0-N042	14-0776	0-N1246	14-0903	0-N822
14-0550	0-N069	14-0648	0-N1308	14-0777	0-N197	14-0904	0-N823
14-0552	0-N180	14-0654	0-N1331	14-0780	0-N839	14-0905	0-N826
14-0553	0-N076	14-0657	0-N130	14-0782	0-N842	14-0907	0-N818
14-0554	0-N078	14-0659	0-N1379	14-0783	0-N838	14-0909	0-N832
14-0558	0-N079	14-0661	0-N1244	14-0784	0-N837	14-0910	0-N819
14-0560	0-N073	14-0662	0-N1828	14-0787	0-N874	14-0911	0-N820
14-0563	0-N086	14-0663	0-N1361	14-0788	0-N903	14-0917	0-N850
14-0564	0-N092	14-0664	0-N1269	14-0792	0-N915	14-0921	0-N816
14-0565	0-N083	14-0667	0-N1721	14-0793	0-N155	14-0925	0-N821
14-0566	0-N983	14-0670	0-N1278	14-0794	0-N156	14-0927	0-N835
14-0567	0-N085	14-0672	0-N1861	14-0796	0-N985	14-0928	0-N113
14-0569	0-N071	14-0673	0-N847	14-0797	0-N1260	14-0929	0-N208
14-0570	0-N072	14-0674	0-N846	14-0798	0-N123	14-0932	0-N114
14-0571	0-N082	14-0675	0-N1288	14-0799	0-N089	14-0933	0-N943
14-0580	0-N2141	14-0679	0-N1862	14-0800	0-N999	14-0935	0-N124
14-0581	0-N1314	14-0689	0-N1833	14-0801	0-N992	14-0939	0-N950
14-0583	0-N1624	14-0699	0-N1173	14-0803	0-N995	14-0941	0-N115
14-0583	0-N1624S	14-0700	0-N979	14-0805	0-N005	14-0949	0-N1277
14-0585	0-N1681	14-0701	0-N927	14-0810	0-N990	14-0951	0-N912
14-0586	0-N1514	14-0702	0-N978	14-0811	0-N988	14-0952	0-N1129
14-0586	0-N1514S	14-0703	0-N926	14-0812	0-N989	14-0953	0-N176
14-0588	0-N1765	14-0704	0-N905	14-0813	0-N997	14-0954	0-N1978
14-0591	0-N1061	14-0705	0-N178	14-0814	0-N998	14-0956	0-N151
14-0592	0-N1120	14-0707	0-N982	14-0817	0-N007	14-0957	0-N2320



IPD		IPD		IPD		IPD	
14-0958	0-N1618	15-0146	0-N187	15-0398	0-N192	15-0647	0-N1775
14-0959	0-N1879	15-0150	0-N119P	15-0401	0-N911	15-0649	0-N1416
14-0961	0-N2041	15-0156	0-N1248	15-0405	0-N900	15-0652	0-N1450
14-0962	0-N2024	15-0169	0-N1560	15-0407	0-N2153	15-0676	0-N1280
14-0963	0-N2325	15-0174	0-N1396	15-0411	0-N945	15-0680	0-N1864
14-0964	0-N1366	15-0175	0-N2131	15-0417	0-N862	15-0684	0-N565592
14-0965	0-N045	15-0182	0-N1570	15-0422	0-N2154	15-0717	0-N1668
14-0988	0-N1474	15-0193	0-N058	15-0430	0-N1437	15-0717	0-N1668S
14-0992	0-N1572	15-0213	0-N892	15-0435	0-N957	15-0721	0-N1374
14-0996	0-N1283	15-0221	0-N1225	15-0440	0-N909	15-0730	0-N1122
14-0997	0-N1383	15-0222	0-N1226	15-0442	0-N875	15-0733	0-N1740
14-0999	0-N1768	15-0223	0-N189	15-0443	0-N876	15-0734	0-N2346
14-1000	0-N2327	15-0226	0-N168	15-0446	0-N906	15-0735	0-N2127
14-1001	0-N1335	15-0238	0-N1309	15-0452	0-N907	15-0741	0-N1066
14-1010	0-N1778	15-0240	0-N2054	15-0453	0-N953	15-0743	0-N1730
14-1011	0-N1911	15-0245	0-N1270	15-0454	0-N952	15-0751	0-N1380
14-1022	0-N1340	15-0247	0-N1350	15-0457	0-N878	15-0752	0-N1377
14-1024	0-N1388	15-0248	0-N170	15-0458	0-N1439	15-0754	0-N1065
14-1028	0-N1272	15-0249	0-N171	15-0479	0-N1297	15-0757	0-N1521
14-1032	0-N1369	15-0254	0-N050	15-0488	0-N1305	15-0759	0-N2186
14-1037	0-N1359	15-0271	0-N971	15-0491	0-N1298	15-0760	0-N1329
14-1055	0-N1368	15-0274	0-N1259	15-0493	0-N867	15-0763	0-N1218
14-1059	0-N1581	15-0278	0-N262	15-0496	0-N866	15-0772	0-N291
14-1063	0-N1566	15-0280	0-N1106	15-0510	0-N814	15-0773	0-N292
14-1065	0-N1759	15-0290	0-N147	15-0512	0-N2349	15-0786	0-N902
14-1072	0-N1060	15-0294	0-N1726	15-0514	0-N2152	15-0789	0-N904
14-1073	0-N1327	15-0297	0-N151	15-0519	0-N1973	15-0790	0-N096
14-1074	0-N1338	15-0300	0-N1734	15-0520	0-N2348	15-0795	0-N1214
15-0026	0-N1431	15-0302	0-N141	15-0522	0-N122	15-0802	0-N991
15-0027	0-N1315	15-0311	0-N881	15-0533	0-N215	15-0804	0-N996
15-0029	0-N2345	15-0316	0-N138	15-0540	0-N1816	15-0806	0-N006
15-0044	0-N300	15-0317	0-N1753	15-0541	0-N1563	15-0815	0-N008
15-0046	0-N1268	15-0320	0-N2176	15-0551	0-N070	15-0816	0-N994
15-0058	0-N146	15-0324	0-N2342	15-0555	0-N077	15-0825	0-N014
15-0059	0-N1307	15-0325	0-N2335	15-0556	0-N080	15-0829	0-N1835
15-0069	0-N169	15-0326	0-N1602	15-0557	0-N081	15-0836	0-N2058
15-0071	0-N174	15-0328	0-N277	15-0559	0-N084	15-0838	0-N1425
15-0078	0-N131	15-0333	0-N965	15-0561	0-N075	15-0842	0-N1387
15-0089	0-N2001	15-0335	0-N148	15-0562	0-N074	15-0843	0-N1421
15-0091	0-N165	15-0339	0-N2343	15-0568	0-N1824	15-0846	0-N1352
15-0093	0-N166	15-0340	0-N1589	15-0572	0-N027	15-0852	0-N1052
15-0098	0-N128	15-0343	0-N1672	15-0604	0-N162	15-0855	0-N1046
15-0104	0-N807	15-0356	0-N031	15-0605	0-N960	15-0861	0-N1446
15-0112	0-N1311	15-0357	0-N029	15-0608	0-N143	15-0868	0-N1394
15-0119	0-N941	15-0359	0-N033	15-0612	0-N920	15-0870	0-N2347
15-0120	0-N2000	15-0362	0-N1219	15-0613	0-N958	15-0871	0-N1365
15-0140	0-N1262	15-0378	0-N035	15-0615	0-N172	15-0876	0-N2156
15-0141	0-N1310	15-0381	0-N1375	15-0627	0-N040	15-0879	0-N1418
15-0143	0-N164	15-0391	0-N1376	15-0645	0-N1316	15-0882	0-N1447S
15-0144	0-N167	15-0392	0-N1550	15-0646	0-N1578	15-0891	0-N1680

IPD		IPD		IPD		IPD	
15-0912	0-N938	15-3082	0-N1675	15-3238	0-N1573	15-3389	0-N2177
15-0924	0-N889	15-3083	0-N1385	15-3244	0-N1898	15-3390	0-N2178
15-0930	0-N951	15-3084	0-N1334	15-3244	0-N1898S	15-3391	0-N2126
15-0937	0-N187	15-3085	0-N1636	15-3245	0-N1916	15-3392	0-N2378
15-0967	0-N1341	15-3085	0-N1636S	15-3246	0-N1736	15-3395	0-N1683
15-0968	0-N1093	15-3087	0-N1505S	15-3248	0-N1615	15-3397	0-N2129
15-0970	0-N1419	15-3088	0-N1392	15-3250	0-N1411	15-3398	0-N2130
15-0972	0-N1355	15-3089	0-N1738	15-3251	0-N1460	15-3399	0-N1976
15-0973	0-N1354	15-3090	0-N1477	15-3252	0-N1522	15-3400	0-N1746
15-0975	0-N1250	15-3091	0-N1891	15-3255	0-N1959	15-3401	0-N1554
15-0976	0-N1773	15-3093	0-N1534	15-3256	0-N1926	15-3401	0-N1554S
15-0977	0-N1328	15-3093	0-N1534S	15-3258	0-N2093	15-3402	0-N2096
15-0979	0-N088	15-3094	0-N1733	15-3258	0-N2093S	15-3402	0-N2096S
15-0980	0-N091	15-3094	0-N1733S	15-3260	0-N1658	15-3403	0-N1537
15-0981	0-N090	15-3097	0-N1704	15-3261	0-N1848	15-3403	0-N1537S
15-0982	0-N1783	15-3097	0-N1704S	15-3261	0-N1848S	15-3404	0-N1851
15-0983	0-N1782	15-3098	0-N1571	15-3262	0-N1805	15-3404	0-N1851S
15-0984	0-N1777	15-3099	0-N1356	15-3262	0-N1805S	15-3405	0-N1788
15-0998	0-N2167	15-3100	0-N1357	15-3264	0-N1957	15-3405	0-N1788S
15-1004	0-N1398	15-3101	0-N1343	15-3264	0-N1957S	15-3406	0-N1621
15-1006	0-N1381	15-3102	0-N1614	15-3265	0-N1610	15-3406	0-N1621S
15-1008	0-N1239	15-3132	0-N1922	15-3268	0-N2124	15-3408	0-N1710
15-1012	0-N1914	15-3135	0-N1423	15-3268	0-N2124S	15-3408	0-N1710S
15-1021	0-N1395	15-3149	0-N300	15-3270	0-N1626	15-3411	0-N2148
15-1023	0-N1776	15-3150	0-N1358	15-3270	0-N1626S	15-3423	0-N1575
15-1030	0-N1723	15-3151	0-N1574	15-3271	0-N1886	15-3426	0-N2045
15-1034	0-N1397	15-3159	0-N1526	15-3271	0-N1886S1	15-3426	0-N2045S
15-1038	0-N1360	15-3159	0-N1526S	15-3271	0-N1886S2	15-3427	0-N1964
15-1047	0-N1053	15-3160	0-N1492	15-3272	0-N1885	15-3427	0-N1964S
15-1049	0-N1336	15-3160	0-N1492S	15-3272	0-N1885S1	15-3428	0-N1664
15-1050	0-N1649	15-3161	0-N1799	15-3272	0-N1885S2	15-3428	0-N1664S
15-1054	0-N1453	15-3161	0-N1799S	15-3273	0-N1659	15-3429	0-N1663
15-1062	0-N2383	15-3172	0-N2175	15-3273	0-N1659S	15-3429	0-N1663S
15-1068	0-N1665	15-3179	0-N1323	15-3274	0-N1643	15-3446	0-N1613
15-1069	0-N1454	15-3207	0-N1348	15-3274	0-N1643S	15-3448	0-N1890
15-1075	0-N1651	15-3209	0-N1639	15-3275	0-N1790	15-3448	0-N1890S
15-1075	0-N1651S	15-3209	0-N1639S	15-3276	0-N1900	15-3451	0-N1676
15-1122	0-N1326	15-3211	0-N1346	15-3277	0-N1961	15-3451	0-N1676S
15-2242	0-N1544	15-3213	0-N903	15-3317	0-N1962	15-3455	0-N1794
15-2376	0-N1544	15-3225	0-N2164	15-3330	0-N118P	15-3455	0-N1794S
15-2535	0-N2349	15-3226	0-N2165	15-3331	0-N1786	15-3456	0-N1834
15-3000	0-N1432	15-3228	0-N1353	15-3332	0-N1702	15-3456	0-N1834S
15-3031	0-N1326	15-3229	0-N087	15-3333	0-N1896	15-3457	0-N1940
15-3062	0-N1567	15-3230	0-N1337	15-3333	0-N1896S	15-3457	0-N1940S
15-3075	0-N1792	15-3231	0-N1616	15-3335	0-N2029	15-3458	0-N1912
15-3077	0-N1620	15-3232	0-N1347	15-3335	0-N2029S	15-3458	0-N1912S
15-3077	0-N1620S	15-3233	0-N1913	15-3379	0-N1500	15-3460	0-N1743
15-3079	0-N1530	15-3233	0-N1913S	15-3384	0-N2331	15-3462	0-N1715
15-3079	0-N1530S	15-3236	0-N1378	15-3386	0-N1884	15-3463	0-N1605
15-3081	0-N1324	15-3237	0-N1612	15-3388	0-N2134	15-3464	0-N2076



IPD		IPD		IPD		IPD	
15-3464	0-N2076S	15-3516	0-N2017	15-3560	0-N1850S	15-3621	0-N1670S
15-3465	0-N1909	15-3517	0-N1946	15-3561	0-N2183	15-3622	0-N2225
15-3468	0-N1739	15-3517	0-N1946S1	15-3561	0-N2183S	15-3623	0-N2138
15-3469	0-N2095	15-3517	0-N1946S2	15-3562	0-N1877	15-3626	0-N1793
15-3469	0-N2095S	15-3518	0-N1936	15-3562	0-N1877S	15-3626	0-N1793S
15-3469	0-N2095S1	15-3520	0-N2046	15-3563	0-N1742	15-3627	0-N1944
15-3470	0-N1925	15-3520	0-N2046S	15-3563	0-N1742S	15-3628	0-N2110
15-3471	0-N1820	15-3521	0-N1714	15-3565	0-N1532	15-3629	0-N1852
15-3472	0-N1919	15-3521	0-N1714S	15-3565	0-N1532S	15-3630	0-N2063
15-3475	0-N2072	15-3522	0-N2018	15-3566	0-N2034	15-3631	0-N1764
15-3478	0-N1731	15-3523	0-N1711S	15-3566	0-N2034S	15-3632	0-N1854
15-3478	0-N1731S	15-3525	0-N1085	15-3567	0-N1815	15-3633	0-N2161
15-3479	0-N1656	15-3527	0-N1735	15-3567	0-N1815S	15-3633	0-N2161S
15-3479	0-N1656S	15-3528	0-N1667	15-3568	0-N1709	15-3634	0-N1956
15-3481	0-N1920	15-3529	0-N1915	15-3568	0-N1709S1	15-3635	0-N2065
15-3482	0-N1923	15-3530	0-N1906	15-3568	0-N1709S2	15-3635	0-N2065S
15-3483	0-N1802	15-3531	0-N1803	15-3570	0-N1855	15-3636	0-N1990
15-3483	0-N1802S	15-3532	0-N1807	15-3570	0-N1855S	15-3638	0-N2052
15-3486	0-N2109	15-3533	0-N1678	15-3571	0-N1551	15-3639	0-N1938
15-3486	0-N2109S	15-3534	0-N1963	15-3571	0-N1551S	15-3642	0-N1646
15-3487	0-N2190	15-3535	0-N1716	15-3572	0-N1875	15-3643	0-N1943
15-3487	0-N2190S	15-3536	0-N1960	15-3572	0-N1875S	15-3644	0-N2185
15-3489	0-N2398	15-3537	0-N1972	15-3573	0-N1979	15-3645	0-N1819
15-3489	0-N2398S	15-3538	0-N1744	15-3573	0-N1979S	15-3648	0-N1823
15-3490	0-N1812	15-3539	0-N1856	15-3574	0-N1958	15-3649	0-N1947
15-3490	0-N1812S	15-3539	0-N1856S	15-3574	0-N1958S	15-3650	0-N2012
15-3491	0-N2103	15-3540	0-N2094	15-3575	0-N1798	15-3651	0-N1955
15-3491	0-N2103S	15-3541	0-N1871	15-3575	0-N1798S	15-3651	0-N1955S
15-3492	0-N2105	15-3543	0-N1950	15-3576	0-N1811	15-3652	0-N2184
15-3492	0-N2105S	15-3544	0-N1795	15-3576	0-N1811S	15-3652	0-N2184S
15-3493	0-N2182	15-3545	0-N2132	15-3578	0-N2151	15-3653	0-N2066
15-3493	0-N2182S	15-3546	0-N2048	15-3578	0-N2151S	15-3654	0-N1954
15-3494	0-N2104	15-3547	0-N2122	15-3579	0-N2037	15-3654	0-N1954S
15-3494	0-N2104S	15-3548	0-N1907	15-3579	0-N2037S	15-3655	0-N2032
15-3496	0-N1908	15-3549	0-N1928	15-3579	0-N2046	15-3655	0-N2032S
15-3496	0-N1908S	15-3550	0-N2133	15-3602	0-N878	15-3657	0-N2067
15-3504	0-N1564	15-3552	0-N2143	15-3603	0-N1330	15-3658	0-N1918
15-3505	0-N1503	15-3554	0-N2159	15-3604	0-N1121	15-3658	0-N1918S
15-3505	0-N1503S	15-3555	0-N2160	15-3606	0-N2139	15-3663	0-N1801
15-3506	0-N2128	15-3556	0-N1941	15-3610	0-N2171	15-3665	0-N2075
15-3507	0-N1841	15-3556	0-N1941S1	15-3614	0-N1808	15-3666	0-N2031
15-3508	0-N1905	15-3556	0-N1941S2	15-3614	0-N1808S	15-3666	0-N2031S
15-3512	0-N2158	15-3556	0-N1941S3	15-3615	0-N2116	15-3670	0-N1840
15-3512	0-N2158S	15-3557	0-N1677	15-3615	0-N2116S	15-3670	0-N1840S
15-3513	0-N2155	15-3557	0-N1677S	15-3616	0-N2055	15-3673	0-N1874
15-3513	0-N2155S	15-3558	0-N1842	15-3616	0-N2055S	15-3673	0-N1874S
15-3514	0-N1673	15-3558	0-N1842S	15-3617	0-N1797	15-3674	0-N2115
15-3514	0-N1673S	15-3559	0-N1945	15-3617	0-N1797S	15-3674	0-N2115S
15-3515	0-N1902	15-3559	0-N1945S	15-3618	0-N1667	15-3677	0-N2256
15-3515	0-N1902S	15-3560	0-N1850	15-3621	0-N1670	15-3678	0-N1644

IPD		IPD		IPD		IPD	
15-3685	0-N1830	15-3746	0-N2021	15-3801	0-N2121	15-3839	0-N2038S
15-3685	0-N1830S	15-3747	0-N2221	15-3802	0-N2200	15-3840	0-N2089
15-3686	0-N2125	15-3748	0-N2228	15-3803	0-N2107	15-3840	0-N2089S
15-3690	0-N1547	15-3749	0-N2042	15-3803	0-N2107S	15-3841	0-N22204
15-3691	0-N1499	15-3749	0-N2042S	15-3804	0-N2245	15-3841	0-N22204S
15-3692	0-N2189S	15-3750	0-N2226	15-3804	0-N2245S1	15-3842	0-N2194
15-3693	0-N2056	15-3750	0-N2226S	15-3804	0-N2245S2	15-3842	0-N2194S
15-3694	0-N2233	15-3751	0-N2232	15-3804	0-N2245S3	15-3843	0-N2241
15-3695	0-N2044	15-3751	0-N2232S	15-3806	0-N2198	15-3843	0-N2241S
15-3696	0-N2149	15-3752	0-N2231	15-3806	0-N2198S	15-3845	0-N22203
15-3697	0-N1617	15-3752	0-N2231S	15-3807	0-N1869	15-3845	0-N22203S
15-3698	0-N2113	15-3753	0-N2030	15-3807	0-N1869S	15-3846	0-N2192
15-3698	0-N2113S	15-3753	0-N2030S	15-3808	0-N2114	15-3846	0-N2192S
15-3699	0-N2250	15-3755	0-N2061	15-3808	0-N2114S	15-3852	0-N1984
15-3699	0-N2250S	15-3756	0-N2220	15-3809	0-N2252	15-3853	0-N2010
15-3700	0-N2112	15-3756	0-N2220S	15-3809	0-N2252S	15-3855	0-N2417
15-3700	0-N2112S	15-3757	0-N2224	15-3810	0-N2087	15-3856	0-N2253
15-3701	0-N2187	15-3758	0-N2222	15-3810	0-N2087S	15-3857	0-N1314
15-3702	0-N1880	15-3759	0-N2273	15-3811	0-N1772	15-3860	0-N2208
15-3702	0-N1880S	15-3760	0-N2199	15-3815	0-N2035	15-3861	0-N2418
15-3703	0-N2136	15-3761	0-N1859	15-3815	0-N2035S	15-3862	0-N2258
15-3703	0-N2136S	15-3762	0-N2227	15-3816	0-N2038	15-3863	0-N2211
15-3713	0-N2025	15-3763	0-N2040	15-3816	0-N2038S	15-3863	0-N2211S
15-3714	0-N2050	15-3765	0-N2218	15-3818	0-N2195	15-3864	0-N22202
15-3715	0-N1878	15-3766	0-N2120	15-3819	0-N2322	15-3864	0-N22202S
15-3716	0-N2137	15-3767	0-N2119	15-3821	0-N1771	15-3867	0-N22207
15-3716	0-N2137S	15-3768	0-N2374	15-3822	0-N2201	15-3868	0-N2238
15-3717	0-N2084	15-3769	0-N2223	15-3823	0-N2191	15-3871	0-N2375
15-3717	0-N2084S	15-3770	0-N2039	15-3824	0-N2205	15-3872	0-N2278
15-3721	0-N2111	15-3770	0-N2039S	15-3825	0-N2364	15-3873	0-N2312
15-3721	0-N2111S	15-3771	0-N2219	15-3826	0-N2234	15-3874	0-N2296
15-3722	0-N2014	15-3771	0-N2219S	15-3827	0-N2382	15-3875	0-N2237
15-3722	0-N2014S	15-3772	0-N2193	15-3829	0-N1991	15-3876	0-N2254
15-3723	0-N2188	15-3772	0-N2193S	15-3830	0-N1130	15-3878	0-N2402
15-3723	0-N2188S	15-3773	0-N2092	15-3831	0-N2027	15-3878	0-N2402S
15-3724	0-N2091	15-3773	0-N2092S	15-3832	0-N2209	15-3880	0-N2266
15-3724	0-N2091S	15-3774	0-N1858	15-3832	0-N2209S	15-3880	0-N2266S1
15-3725	0-N2229	15-3774	0-N1858S	15-3833	0-N2026	15-3880	0-N2266S2
15-3726	0-N2339	15-3775	0-N2064	15-3833	0-N2026S	15-3882	0-N2062
15-3727	0-N1725	15-3776	0-N2230	15-3834	0-N2083	15-3883	0-N1876
15-3728	0-N1724	15-3776	0-N2230S	15-3834	0-N2083S	15-3883	0-N1876S
15-3729	0-N1952	15-3792	0-N2060	15-3835	0-N2407	15-3884	0-N1814
15-3730	0-N2082	15-3793	0-N2384	15-3835	0-N2407S	15-3885	0-N2274
15-3730	0-N2082S	15-3794	0-N2351	15-3836	0-N1698	15-3886	0-N2255
15-3731	0-N1728	15-3795	0-N2098	15-3836	0-N1698S	15-3888	0-N2272
15-3732	0-N1983	15-3795	0-N2098S	15-3837	0-N1813	15-3890	0-N2275
15-3742	0-N115	15-3800	0-N2246	15-3837	0-N1813S	15-3891	0-N2265
15-3743	0-N2150	15-3800	0-N2246S1	15-3838	0-N2108	15-3891	0-N2265S
15-3744	0-N1637	15-3800	0-N2246S2	15-3838	0-N2108S	15-3894	0-N1832
15-3745	0-N2049	15-3800	0-N2246S3	15-3839	0-N2038	15-3894	0-N1832S



IPD		IPD		IPD		OPTIBELT	
15-3895	0-N2429	15-3982	0-N2422	15-4084	0-N2370	137UT	0-N1238
15-3896	0-N2365	15-3982	0-N2422S	15-4085	0-N2340	138UT	0-N2001
15-3897	0-N2236	15-3986	0-N2403	15-4086	0-N2369	139ST	0-N1275
15-3898	0-N2371	15-3986	0-N2403S	15-4088	0-N2240	140UR	0-N174
15-3899	0-N2277	15-3987	0-N1662	15-4089	0-N2357	141ST	0-N1276
15-3900	0-N2268	15-3988	0-N2300	15-4091	0-N2388	141UT	0-N163
15-3900	0-N2268S	15-3988	0-N2300S	15-4091	0-N2388S	142ST	0-N1236
15-3902	0-N2057	15-3989	0-N2106	15-4092	0-N2400	144UT	0-N2000
15-3903	0-N2269	15-3991	0-N2259	15-4092	0-N2400S	145UT	0-N1262
15-3903	0-N2269S	15-3992	0-N2283	15-4093	0-N2406	146ST	0-N158
15-3905	0-N2397	15-3993	0-N1987	15-4093	0-N2406S	148ST	0-N1263
15-3905	0-N2397S	15-3994	0-N2095	15-4095	0-N2290	149ST	0-N109
15-3906	0-N2353	15-3994	0-N2095S	15-4095	0-N2290S	150UT	0-N167
15-3908	0-N2399	15-3994 + 15-3469	0-N2095	15-4104	0-N2427	152ST	0-N1048
15-3908	0-N2399S	15-3994 + 15-3469	0-N2095S	15-4104	0-N2427S	153ST	0-N116
15-3909	0-N2267	15-3995	0-N2299	15-4105	0-N2423	154UT	0-N130
15-3909	0-N2267S	15-3995	0-N2299S	15-4108	0-N2363	155ST	0-N107
15-3911	0-N2276	15-3996	0-N2279	15-4110	0-N2419	156UT	0-N1316
15-3913	0-N2291	15-3996	0-N2279S	15-4142	0-N2214	157ST	0-N1050
15-3915	0-N2216	15-4003	0-N2377	15-4142	0-N2214S	158ST	0-N1051
15-3915	0-N2216S1	15-4025	0-N2424	OPTIBELT		158ST	0-N1051S
15-3915	0-N2216S2	15-4027	0-N2280	100UT	0-N805	160UT	0-N1268
15-3916	0-N2381	15-4027	0-N2280S	101ST	0-N806	161ST	0-N1274
15-3917	0-N2313	15-4028	0-N2282	102ST	0-N808	162ST	0-N1045
15-3933	0-N2421	15-4031	0-N2286	103UT	0-N807	163UT	0-N1046
15-3934	0-N2420	15-4032	0-N2303	104UT	0-N923	164UT	0-N1379
15-3935	0-N2294	15-4033	0-N2396	105ST	0-N924	165UT	0-N1578
15-3936	0-N2354	15-4033	0-N2396S	106ST	0-N940	166UT	0-N1127
15-3948	0-N2281	15-4034	0-N2395	111UT	0-N128	167UT	0-N200
15-3948	0-N2281S	15-4034	0-N2395S	112ST	0-N921	168UT	0-N262
15-3958	0-N2389	15-4036	0-N2387	113UT	0-N941	169ST	0-N1112
15-3958	0-N2389S	15-4036	0-N2387S	114SR	0-N1417	170UT	0-N195
15-3959	0-N2287	15-4037	0-N2301	119UT	0-N131	172UT	0-N1777
15-3959	0-N2287S	15-4037	0-N2301S	120ST	0-N157	173UT	0-N1767
15-3960	0-N2289	15-4041	0-N2416	121ST	0-N111	175UT	0-N805
15-3960	0-N2289S	15-4052	0-N2051	123ST	0-N922	176ST	0-N017
15-3961	0-N2293	15-4073	0-N2326	124ST	0-N105	178ST	0-N975
15-3961	0-N2293S	15-4074	0-N2355	125ST	0-N106	179ST	0-N036
15-3962	0-N2394	15-4075	0-N2368	127ST	0-N1042	181UT	0-N916
15-3962	0-N2394S	15-4076	0-N2401	128ST	0-N104	184UT	0-N1374
15-3972	0-N2270	15-4076	0-N2401S1	129ST	0-N103	185UT	0-N1561
15-3972	0-N2270S	15-4076	0-N2401S2	130UT	0-N160	187UT	0-N077
15-3974	0-N2344	15-4077	0-N2404	132UT	0-N166	189UT	0-N055
15-3977	0-N2271	15-4077	0-N2404S	133SR	0-N1317	193ST	0-N1243
15-3979	0-N2295	15-4078	0-N2247	133SR	0-N1317S	195UT	0-N146
15-3980	0-N2086	15-4078	0-N2247S	134SR	0-N1822	200ST	0-N809
15-3980	0-N2086S	15-4079	0-N2248	134SR	0-N1822S	201ST	0-N955
15-3981	0-N2217	15-4081	0-N2239	135SR	0-N1041	202UT	0-N866
15-3981	0-N2217S1	15-4082	0-N2329	135SR	0-N1041S	203UT	0-N867
15-3981	0-N2217S2	15-4083	0-N2244	136ST	0-N1237	204ST	0-N954

OPTIBELT		OPTIBELT		OPTIBELT		OPTIBELT	
206SR	0-N1295	289UT	0-N815	369UT	0-N951	459UT	0-N1352
206SR	0-N1295S	291UT	0-N1225	370UT	0-N950	463UT	0-N859
206UR	0-N1298	292UT	0-N1226	371ST	0-N115	466ST	0-N1905
208SR	0-N2409	293UT	0-N119P	373UT	0-N889	467ST	0-N973
212SR	0-N1758	294ST	0-N1057	374ST	0-N800	468ST	0-N1499
215UR	0-N1296	295UT	0-N1065	375ST	0-N801	472ST	0-N1612
217ST	0-N925	296ST	0-N1366	378UT	0-N938	474ST	0-N1085
219SR	0-N1303	3005UR	0-N1446	386UT	0-N1341	475ST	0-N1564
222ST	0-N1331	301ST	0-N837	387ST	0-N1340	476ST	0-N1616
223UT	0-N127	302ST	0-N838	389UT	0-N019	477ST	0-N1572
224ST	0-N978	304UT	0-N902	392UT	0-N020	490UT	0-N1574
225UT	0-N122	305ST	0-N839	393ST	0-N129	498ST	0-N1343
226ST	0-N1061	306ST	0-N842	395ST	0-N1383	501UT	0-N875
228ST	0-N194	307ST	0-N903	396ST	0-N1369	502ST	0-N877
229ST	0-N196	308UT	0-N904	398ST	0-N1269	503UT	0-N876
230ST	0-N1654	309UT	0-N096	399UT	0-N1270	504UT	0-N909
231ST	0-N294	312SR	0-N156	400SR	0-N846	505UT	0-N907
233ST	0-N110	315SR	0-N155	401UR	0-N847	506UT	0-N953
234ST	0-N117	316ST	0-N089	402SR	0-N1278	507UT	0-N952
235UT	0-N1371	317ST	0-N123	403UR	0-N1288	509UT	0-N906
236ST	0-N108	319UR	0-N197	405SR	0-N1280	510ST	0-N948
239ST	0-N1058	320ST	0-N915	410SR	0-N1013	511ST	0-N910
242UT	0-N1259	322ST	0-N903	410SR	0-N1013S	515ST	0-N100
243UT	0-N076	323ST	0-N874	411SR	0-N1011	516ST	0-N879
245UT	0-N168	325ST	0-N1260	411SR	0-N1011S	517UT	0-N878
246ST	0-N137	330UT	0-N186	414UR	0-N2141	518ST	0-N101
249ST	0-N1367	331ST	0-N1062	415UT	0-N168	519ST	0-N102
250UT	0-N118P	332UT	0-N1066	416UT	0-N971	520ST	0-N126
251SR	0-N931	333ST	0-N1359	417ST	0-N970	521ST	0-N049
252ST	0-N811	334UT	0-N1360	418UT	0-N300	522UT	0-N050
254ST	0-N861	338ST	0-N1273	419ST	0-N1328	524UT	0-N956
255UT	0-N862	339ST	0-N182	420UT	0-N1329	525UT	0-N957
256ST	0-N812	340ST	0-N1120	421UT	0-N1326	532ST	0-N1324
258ST	0-N894	341UT	0-N1122	423ST	0-N1335	535UT	0-N1914
260ST	0-N869	342ST	0-N1365	424UT	0-N1336	538SR	0-N1538
262UT	0-N814	343ST	0-N1111	425ST	0-N1347	538SR	0-N1538S
263SR	0-N1682	345ST	0-N1277	430ST	0-N1342	539ST	0-N2061
270ST	0-N870	346ST	0-N1173	431ST	0-N1357	542ST	0-N1362
271UR	0-N2152	350ST	0-N822	432UT	0-N1358	543UT	0-N1350
272ST	0-N811	351ST	0-N818	434UT	0-N1775	544ST	0-N1349
273ST	0-N911	353ST	0-N826	436UT	0-N878	546UT	0-N2149
274ST	0-N901	355ST	0-N198	437UT	0-N118P	552UR	0-N2348
275ST	0-N871	356ST	0-N850	440ST	0-N1368	553UR	0-N2349
276SR	0-N133	357ST	0-N821	441ST	0-N1917	555UT	0-N291
277UT	0-N900	359UT	0-N816	442ST	0-N2208	558ST	0-N1129
278SR	0-N124	361ST	0-N819	443UT	0-N1346	560ST	0-N1619
279ST	0-N944	362UT	0-N820	445UT	0-N1380	600ST	0-N863
280UT	0-N945	363UT	0-N835	447ST	0-N1327	601ST	0-N856
283ST	0-N943	365ST	0-N114	448UT	0-N1334	602ST	0-N173
284ST	0-N813	367ST	0-N113	449ST	0-N1351	603UT	0-N854



OPTIBELT

604UR	0-N138
606ST	0-N883
607UT	0-N887
609UR	0-N141
610ST	0-N880
611UT	0-N881
612SR	0-N139
614ST	0-N882
618UT	0-N857
621SR	0-N2336
624SR	0-N2176
627ST	0-N112
628UT	0-N965
630UT	0-N145
631UT	0-N147
632ST	0-N148
700ST	0-N860
701ST	0-N917
704ST	0-N1231
705UT	0-N162
706UT	0-N960
707UT	0-N958
708ST	0-N930
714UR	0-N143
751ST	0-N912
806UT	0-N035
807ST	0-N034
809UT	0-N029
810ST	0-N028
813ST	0-N094
814UT	0-N991
815ST	0-N995
816UT	0-N996
817ST	0-N021
818UT	0-N030
819UT	0-N031
825ST	0-N997
826ST	0-N005
827UT	0-N006
828ST	0-N007
829UT	0-N008
830ST	0-N999
832ST	0-N013
833UT	0-N014
834ST	0-N037
835ST	0-N990
836ST	0-N988
837UT	0-N989
875ST	0-N927
876ST	0-N905

OPTIBELT

877ST	0-N926
879ST	0-N981
900UT	0-N018
925ST	0-N986
926ST	0-N053
927ST	0-N061
928ST	0-N051
929ST	0-N184
930ST	0-N987
931UT	0-N183
950UT	0-N983
951ST	0-N069
952UT	0-N070
953ST	0-N073
954UT	0-N074
955ST	0-N071
KT 1001	SK-1026
KT 1002	SK-1162
KT 1002 W1	SK-1162AQ2
KT 1002 W2	SK-1162AQ1
KT 1002 W4	SK-1162AQ3
KT 1003	SK-1001
KT 1004	SK-1029
KT 1005	SK-1059
KT 1006	SK-1041
KT 1008	SK-1120
KT 1009	SK-1027
KT 1010	SK-1011
KT 1011	SK-1094
KT 1011	SK-1741
KT 1012	SK-1023
KT 1012 W1	SK-1665AQ2
KT 1013	SK-1003
KT 1013 W1	SK-1003AQ1
KT 1014	SK-1069
KT 1015	SK-1024
KT 1018	SK-1021
KT 1018 W1	SK-1021AQ2
KT 1018 W2	SK-1021AQ1
KT 1019	SK-1004
KT 1019 W1	SK-1004AQ1
KT 1020	SK-1047
KT 1021	SK-1122
KT 1023	SK-1037
KT 1023 W1	SK-1037AQ1
KT 1024	SK-1073
KT 1024 W1	SK-1073AQ1
KT 1024 W2	SK-1073AQ3
KT 1024 W3	SK-1073AQ2
KT 1025	SK-1165

OPTIBELT

KT 1027	SK-1169
KT 1030	SK-1100
KT 1030 W1	SK-1100AQ1
KT 1031	SK-1060
KT 1032	SK-1074
KT 1032 W1	SK-1074AQ1
KT 1032 W2	SK-1074AQ1
KT 1034	SK-1131
KT 1034 W1	SK-1131AQ1
KT 1034 W2	SK-1131AQ1
KT 1034 W3	SK-1131AQ2
KT 1035	SK-1078
KT 1035 W1	SK-1078AQ1
KT 1035 W2	SK-1078AQ2
KT 1035 W3	SK-1078AQ3
KT 1036	SK-1042
KT 1037	SK-1031
KT 1040	SK-1022
KT 1040 W1	SK-1022AQ2
KT 1040 W3	SK-1022AQ1
KT 1041	SK-1056
KT 1043	SK-1010
KT 1046	SK-1015
KT 1048	SK-1012
KT 1049	SK-1039
KT 1057	SK-1018S
KT 1059	SK-1013
KT 1061	SK-1343
KT 1062	SK-1053
KT 1063	SK-1020
KT 1065	SK-1091
KT 1066	SK-1092
KT 1068	SK-1019
KT 1069	SK-1224
KT 1070	SK-1017
KT 1070 W1	SK-1017AQ1
KT 1071	SK-1016
KT 1074	SK-1196
KT 1077	SK-1038
KT 1079	SK-1361
KT 1079 W1	SK-1361AQ1
KT 1083	SK-1034
KT 1084	SK-1040
KT 1084 W1	SK-1040AQ1
KT 1085 W1	SK-1112AQ1
KT 1086	SK-1096
KT 1087	SK-1425
KT 1091	SK-1657
KT 1099	SK-1032
KT 1101	SK-1033

OPTIBELT

KT 1107	SK-1522
KT 1109	SK-1067
KT 1110	SK-1260
KT 1117	SK-1036
KT 1118	SK-1103
KT 1120	SK-1043
KT 1126	SK-1081
KT 1128	SK-1338
KT 1128 W1	SK-1338AQ1
KT 1128 W2	SK-1338AQ2
KT 1129	SK-1108S
KT 1131	SK-1107
KT 1132	SK-1084
KT 1133	SK-1109
KT 1133 W2	SK-1109AQ1
KT 1135	SK-1101
KT 1166	SK-1335
KT 1170	SK-1105
KT 1171	SK-1578
KT 1173	SK-1665
KT 1205	SK-1638
KT 1206	SK-1346
KT 1207	SK-1355
KT 1207 W1	SK-1355AQ2
KT 1207 W2	SK-1355AQ1
KT 1207 W3	SK-1355AQ3
KT 1209	SK-1511
KT 1209 W1	SK-1511AQ1
KT 1216	SK-1082
KT 1217	SK-1046
KT 1218	SK-1725
KT 1218 + KT 1302	SK-1529
KT 1218 W1	SK-1725AQ1
KT 1218 W2	SK-1526AQ2
KT 1226	SK-1110
KT 1229	SK-1035
KT 1230	SK-1660
KT 1232	SK-1640
KT 1235	SK-1378
KT 1235 W1	SK-1378AQ1
KT 1236	SK-1583
KT 1236 W1	SK-1583AQ1
KT 1237	SK-1372
KT 1237 W1	SK-1372AQ2
KT 1237 W4	SK-1372AQ3
KT 1237 W5	SK-1372AQ1
KT 1238	SK-1582
KT 1244	SK-1482
KT 1244	SK-1596
KT 1245	SK-1626

OPTIBELT		OPTIBELT		OPTIBELT		OPTIBELT	
KT 1248	SK-1388	KT 1328 W4	SK-1391AQ1	KT 1399	SK-1589	KT 1474	SK-1608
KT 1252	SK-1486	KT 1329	SK-1113	KT 1400	SK-1586	KT 1478	SK-1458
KT 1252 W1	SK-1486AQ1	KT 1330	SK-1392	KT 1401	SK-1587	KT 1479 W1	SK-1007AQ1
KT 1253	SK-1412	KT 1330 W1	SK-1392AQ1	KT 1401 W1	SK-1587AQ1	KT 1481	SK-1652
KT 1255	SK-1719	KT 1332	SK-1615	KT 1403	SK-1595	KT 1483 W1	SK-1602AQ1
KT 1257	SK-1144	KT 1332 W1	SK-1615AQ1	KT 1403 W1	SK-1595AQ1	KT 1484	SK-1367
KT 1258	SK-1120	KT 1335	SK-1088	KT 1404	SK-1629	KT 1489	SK-1706
KT 1261	SK-1376	KT 1340	SK-1153	KT 1404 W1	SK-1629AQ1	KT 1490	SK-1114
KT 1262	SK-1320	KT 1341	SK-1259	KT 1405	SK-1607	KT 1495	SK-1715
KT 1267	SK-1245	KT 1342	SK-1108	KT 1406	SK-1088	KT 1496 W1	SK-1666AQ1
KT 1270	SK-1221	KT 1345	SK-1277	KT 1406 W1	SK-1088AQ1	KT 1499	SK-1674
KT 1274	SK-1463	KT 1347	SK-1656	KT 1408	SK-1623	KT 1500	SK-1714
KT 1279	SK-1099	KT 1350	SK-1394	KT 1409	SK-1624	KT 1502	SK-1678
KT 1280	SK-1457	KT 1350 W1	SK-1394AQ1	KT 1409 W1	SK-1624AQ1	KT 1505	SK-1654
KT 1282	SK-1192	KT 1351	SK-1534	KT 1410	SK-1630	KT 1507	SK-1597
KT 1285	SK-1592	KT 1351 W1	SK-1534AQ1	KT 1410 W1	SK-1630AQ1	KT 1511	SK-1717
KT 1285 W1	SK-1592AQ1	KT 1352	SK-1577	KT 1415	SK-1614	KT 1512 W1	SK-1668AQ1
KT 1288	SK-1090	KT 1353	SK-1609	KT 1415 W1	SK-1614AQ1	KT 1514	SK-1727
KT 1289	SK-1075	KT 1353 W1	SK-1609AQ1	KT 1416	SK-1627	KT 1514 W1	SK-1727AQ2
KT 1290	SK-1270	KT 1357	SK-1638	KT 1417	SK-1617	KT 1517 W1	SK-1086AQ1
KT 1291	SK-1288	KT 1358	SK-1098	KT 1417 W1	SK-1617AQ1	KT 1519 W1	SK-1697AQ1
KT 1294	SK-1410	KT 1360	SK-1449	KT 1420 W2	SK-1694AQ1	KT 1521	SK-1598
KT 1294 W1	SK-1410AQ1	KT 1365	SK-1316	KT 1421	SK-1054	KT 1523	SK-1470
KT 1296	SK-1337	KT 1368	SK-1487	KT 1422	SK-1634	KT 1527	SK-1610
KT 1297	SK-1077	KT 1368 W1	SK-1487AQ1	KT 1425	SK-1164	KT 1527 W1	SK-1610AQ1
KT 1298	SK-1564	KT 1368 W2	SK-1487AQ2	KT 1426	SK-1696	KT 1535 W1	SK-1586AQ1
KT 1299	SK-1519	KT 1368 W3	SK-1487AQ3	KT 1427	SK-1168	KT 1539	SK-1684
KT 1301	SK-1337	KT 1369 W1	SK-1604AQ1	KT 1428	SK-1594	KT 1545	SK-1721
KT 1301	SK-1709	KT 1369 W2	SK-1604AQ1	KT 1428 W1	SK-1594AQ1	KT 1547	SK-1693
KT 1302 + KT 1214	SK-1526	KT 1370	SK-1354	KT 1429	SK-1538	KT 1555 W1	SK-1586AQ1
KT 1303	SK-1383	KT 1370 W1	SK-1354AQ1	KT 1433	SK-1086	KT 1569	SK-1698
KT 1304	SK-1377	KT 1371	SK-1580	KT 1434	SK-1493	KT 1590	SK-1590
KT 1304 W1	SK-1377AQ1	KT 1372	SK-1386	KT 1434 W1	SK-1493AQ1	KT1015	SK-1024
KT 1306 W1	SK-1380AQ1	KT 1373	SK-1642	KT 1436	SK-1436	KT1020	SK-1047
KT 1307	SK-1325	KT 1375	SK-1599	KT 1438	SK-1712	KT1023	SK-1037
KT 1312	SK-1631	KT 1375 W1	SK-1599AQ1	KT 1439	SK-1601	KT1026	SK-1006
KT 1315	SK-1494	KT 1384	SK-1644	KT 1440	SK-1340	KT1028	SK-1061
KT 1316	SK-1418	KT 1384 W1	SK-1644AQ1	KT 1442	SK-1526	KT1029	SK-1119
KT 1316 W1	SK-1418AQ1	KT 1385	SK-1632	KT 1443	SK-1612	KT1041	SK-1056
KT 1317	SK-1491	KT 1388	SK-1469	KT 1445	SK-1511	KT1042	SK-1064
KT 1317 W1	SK-1491AQ1	KT 1390	SK-1424	KT 1446	SK-1659	KT1043	SK-1010
KT 1319	SK-1341	KT 1390 W1	SK-1424AQ1	KT 1447	SK-1677	KT1046	SK-1015
KT 1322	SK-1258	KT 1392	SK-1489	KT 1448	SK-1685	KT1049	SK-1039
KT 1323	SK-1478	KT 1393	SK-1621	KT 1448 W1	SK-1685AQ1	KT1057	SK-1018S
KT 1324	SK-1421	KT 1393 W1	SK-1621AQ1	KT 1449	SK-1756	KT1058	SK-1005
KT 1324 W1	SK-1421AQ1	KT 1393 W2	SK-1621AQ1	KT 1460	SK-1619	KT1070	SK-1017
KT 1326	SK-1512	KT 1397	SK-1273	KT 1465	SK-1481	KT1071	SK-1016
KT 1327	SK-1085	KT 1397 W1	SK-1273AQ2	KT 1467	SK-1627	KT1072	SK-1218
KT 1327 W1	SK-1085AQ1	KT 1398	SK-1353	KT 1468	SK-1667	KT1073	SK-1310
KT 1328	SK-1391	KT 1398 W1	SK-1353AQ1	KT 1469	SK-1183		



QUINTON HAZELL

QBK 574	SK-1351
QBK 575	SK-1351
QBK 623	SK-1651
QBK 657	SK-1602
QBK 664	SK-1527
QBK 688	SK-1604
QBK 704	SK-1490
QBK100	SK-1001
QBK101	SK-1091
QBK103	SK-1003
QBK104	SK-1004
QBK105	SK-1005
QBK106	SK-1006
QBK107	SK-1007
QBK111	SK-1010
QBK112	SK-1011
QBK113	SK-1012
QBK114	SK-1013
QBK115	SK-1014
QBK116	SK-1015
QBK117	SK-1016
QBK118	SK-1017
QBK119	SK-1018S
QBK120	SK-1019
QBK121	SK-1020
QBK122	SK-1021
QBK123	SK-1092
QBK127	SK-1022
QBK128	SK-1023
QBK129	SK-1024
QBK131	SK-1026
QBK132	SK-1027
QBK134	SK-1029
QBK136	SK-1031
QBK137	SK-1032
QBK138	SK-1033
QBK140	SK-1034
QBK141	SK-1035
QBK145	SK-1036
QBK146	SK-1037
QBK147	SK-1038
QBK149	SK-1162
QBK150	SK-1039
QBK153	SK-1040
QBK156	SK-1041
QBK157	SK-1042
QBK158	SK-1043
QBK160	SK-1045
QBK161	SK-1046
QBK162	SK-1047

QUINTON HAZELL

QBK164	SK-1049
QBK166	SK-1050
QBK168	SK-1052
QBK169	SK-1053
QBK170	SK-1054
QBK173	SK-1056
QBK176	SK-1059
QBK177	SK-1060
QBK210	SK-1061
QBK212	SK-1108
QBK213	SK-1062
QBK214	SK-1063
QBK215	SK-1064
QBK217	SK-1065
QBK218	SK-1066
QBK219	SK-1067
QBK220	SK-1662
QBK221	SK-1069
QBK223	SK-1070
QBK225	SK-1072
QBK226	SK-1073
QBK227	SK-1100
QBK228	SK-1100
QBK229	SK-1074
QBK232	SK-1075
QBK233	SK-1076
QBK234	SK-1105
QBK235	SK-1078
QBK236	SK-1079
QBK238	SK-1646
QBK239	SK-1081
QBK240	SK-1082
QBK241	SK-1107
QBK243	SK-1084
QBK244	SK-1085
QBK245	SK-1086
QBK246	SK-1087
QBK247	SK-1088
QBK248	SK-1089
QBK249	SK-1090
QBK250	SK-1091
QBK251	SK-1092
QBK252	SK-1093
QBK254	SK-1095
QBK254	SK-1645
QBK255	SK-1096
QBK256	SK-1097
QBK257	SK-1098
QBK258	SK-1099
QBK259	SK-1100

QUINTON HAZELL

QBK260	SK-1101
QBK261	SK-1102
QBK262	SK-1103
QBK263	SK-1104
QBK264	SK-1077
QBK265	SK-1106
QBK267	SK-1108
QBK268	SK-1109
QBK269	SK-1110
QBK270	SK-1111
QBK272	SK-1112
QBK273	SK-1113
QBK273	SK-1355
QBK274	SK-1114
QBK274	SK-1663
QBK279	SK-1119
QBK280	SK-1120
QBK281	SK-1638
QBK282	SK-1122
QBK283	SK-1123
QBK284	SK-1124
QBK286	SK-1126
QBK287	SK-1127
QBK289	SK-1129
QBK290	SK-1130
QBK291	SK-1131
QBK294	SK-1445
QBK299	SK-1138
QBK302	SK-1140
QBK303	SK-1141
QBK304	SK-1142
QBK306	SK-1143
QBK307	SK-1144
QBK308	SK-1145S
QBK315	SK-1150
QBK316	SK-1151
QBK318	SK-1153
QBK319	SK-1154
QBK320	SK-1155
QBK322	SK-1157
QBK323	SK-1158
QBK324	SK-1159
QBK325	SK-1160
QBK331	SK-1162
QBK332	SK-1163
QBK334	SK-1164
QBK335	SK-1165
QBK336	SK-1166
QBK337	SK-1508
QBK338	SK-1168

QUINTON HAZELL

QBK339	SK-1169
QBK340	SK-1650
QBK343	SK-1171
QBK344	SK-1172
QBK347	SK-1174
QBK350	SK-1176
QBK358	SK-1183
QBK359	SK-1184
QBK360	SK-1185
QBK361	SK-1186
QBK362	SK-1187
QBK365	SK-1188
QBK366	SK-1189
QBK367	SK-1190
QBK369	SK-1192
QBK372	SK-1195
QBK373	SK-1196
QBK374	SK-1197
QBK379	SK-1202
QBK380	SK-1203
QBK382	SK-1205
QBK384	SK-1207
QBK388	SK-1210
QBK389	SK-1211
QBK391	SK-1213
QBK395	SK-1217
QBK396	SK-1218
QBK398	SK-1219
QBK399	SK-1220
QBK400	SK-1221
QBK401	SK-1222
QBK402	SK-1223
QBK403	SK-1224
QBK404	SK-1225
QBK405	SK-1226
QBK406	SK-1227
QBK407	SK-1228
QBK410	SK-1231
QBK411	SK-1232
QBK412	SK-1233
QBK413	SK-1234
QBK414	SK-1463
QBK415	SK-1236
QBK416	SK-1237
QBK416	SK-1237S
QBK417	SK-1649
QBK419	SK-1240
QBK419	SK-1240S
QBK421	SK-1242
QBK424	SK-1245

QUINTON HAZELL

QUINTON HAZELL

QUINTON HAZELL

QUINTON HAZELL

QBK425	SK-1246
QBK427	SK-1248
QBK428	SK-1249
QBK429	SK-1250
QBK436	SK-1257
QBK437	SK-1258
QBK438	SK-1259
QBK440	SK-1260
QBK441	SK-1261
QBK444	SK-1264
QBK445	SK-1265
QBK448	SK-1449
QBK456	SK-1573
QBK457	SK-1270
QBK460	SK-1273
QBK461	SK-1274
QBK462	SK-1275
QBK465	SK-1277
QBK466	SK-1278
QBK479	SK-1286
QBK482	SK-1288
QBK483	SK-1289
QBK500	SK-1301
QBK501	SK-1302
QBK502	SK-1453
QBK509	SK-1306
QBK512	SK-1308
QBK517	SK-1309S
QBK520	SK-1310
QBK522	SK-1311
QBK523	SK-1312
QBK525	SK-1313S
QBK526	SK-1314
QBK529	SK-1317
QBK532	SK-1320
QBK533	SK-1321
QBK534	SK-1322
QBK535	SK-1323
QBK538	SK-1325
QBK540	SK-1327
QBK542	SK-1248
QBK555	SK-1335
QBK557	SK-1337
QBK558	SK-1337
QBK559	SK-1338
QBK560	SK-1339
QBK561	SK-1340
QBK562	SK-1341
QBK564	SK-1343
QBK565	SK-1344

QBK567	SK-1345
QBK568	SK-1346
QBK569	SK-1255
QBK572	SK-1168
QBK573	SK-1049
QBK577	SK-1353
QBK578	SK-1354
QBK582	SK-1511
QBK583	SK-1582
QBK583	SK-1583
QBK584	SK-1633
QBK585	SK-1534
QBK586	SK-1394
QBK587	SK-1410
QBK588	SK-1418
QBK589	SK-1489
QBK590	SK-1493
QBK591	SK-1483
QBK592	SK-1512
QBK601	SK-1407
QBK602	SK-1522
QBK603	SK-1500
QBK604	SK-1376
QBK606	SK-1570
QBK607	SK-1411
QBK608	SK-1100
QBK609	SK-1365
QBK610	SK-1415
QBK612	SK-1430
QBK615	SK-1491
QBK617	SK-1531
QBK618	SK-1425
QBK620	SK-1399
QBK621	SK-1504
QBK622	SK-1068
QBK622	SK-1068S
QBK623	SK-1656
QBK624	SK-1478
QBK625	SK-1372
QBK626	SK-1487
QBK627	SK-1622
QBK628	SK-1493
QBK629	SK-1378
QBK631	SK-1593
QBK632	SK-1580
QBK633	SK-1412
QBK635	SK-1644
QBK636	SK-1450
QBK637	SK-1533
QBK638	SK-1108S

QBK639	SK-1620
QBK640	SK-1585
QBK642	SK-1640
QBK643	SK-1638
QBK644	SK-1391
QBK645	SK-1424
QBK646	SK-1482
QBK647	SK-1594
QBK648	SK-1685
QBK649	SK-1421
QBK650	SK-1526
QBK651	SK-1529
QBK652	SK-1479
QBK653	SK-1481
QBK654	SK-1439
QBK655	SK-1634
QBK656	SK-1612
QBK659	SK-1586
QBK659	SK-1696
QBK660	SK-1566
QBK662	SK-1564
QBK667	SK-1521
QBK668	SK-1592
QBK669	SK-1636
QBK670	SK-1377
QBK671	SK-1625
QBK672	SK-1494
QBK673	SK-1631
QBK675	SK-1712
QBK676	SK-1623
QBK677	SK-1624
QBK678	SK-1486
QBK679	SK-1392
QBK680	SK-1615
QBK681	SK-1393
QBK682	SK-1577
QBK683	SK-1609
QBK685	SK-1608
QBK686	SK-1611
QBK690	SK-1652
QBK691	SK-1626
QBK693	SK-1755
QBK695	SK-1595
QBK701	SK-1598
QBK702	SK-1316
QBK703	SK-1589
QBK706	SK-1610
QBK707	SK-1748
QBK712	SK-1507
QBK715	SK-1501

QBK716	SK-1552
QBK717	SK-1677
QBK718	SK-1676
QBK719	SK-1653
QBK721	SK-1669
QBK724	SK-1703
QBK725	SK-1457
QBK726	SK-1627
QBK727	SK-1460
QBK728	SK-1470
QBK730	SK-1632
QBK734	SK-1635
QBK736	SK-1752
QBK738	SK-1702
QBK739	SK-1754
QBK740	SK-1643
QBK741	SK-1618
QBK741	SK-1643
QBK744	SK-1658
QBK745	SK-1654
QBK747	SK-1751
QBK754	SK-1617
QBK755	SK-1690
QBK757	SK-1675
QBK761	SK-1673
QBK763	SK-1692
QBK768	SK-1712
QBK769	SK-1719
QBK772	SK-1721
QBK775	SK-1750
QBK780	SK-1615
QBK785	SK-1709
QBK786	SK-1710
QBK789	SK-1367
QBK797	SK-1489
QBK798	SK-1587
QBK800	SK-1686
QBK802	SK-1717
QBK814	SK-1590
QBK816	SK-1735
QBK817	SK-1693
QBK830	SK-1597
QBK834	SK-1674
QBK837	SK-1458
QBK841	SK-1469
QBK843	SK-1383
QBK846	SK-1681
QBK847	SK-1671
QBK860	SK-1519
QBK870	SK-1727

**QUINTON HAZELL**

QBPK2731	SK-1113AQ2
QBPK1030	SK-1003AQ1
QBPK1040	SK-1004AQ1
QBPK1070	SK-1007AQ1
QBPK1210	SK-1020AQ1
QBPK1220	SK-1021AQ1
QBPK1221	SK-1021AQ2
QBPK1470	SK-1038AQ1
QBPK1471	SK-1038AQ1
QBPK1530	SK-1040AQ1
QBPK1570	SK-1042AQ3
QBPK1571	SK-1042AQ2
QBPK1572	SK-1042AQ1
QBPK1690	SK-1053AQ1
QBPK2260	SK-1073AQ1
QBPK2261	SK-1073AQ2
QBPK2263	SK-1073AQ3
QBPK2352	SK-1078AQ1
QBPK2380	SK-1646AQ1
QBPK2390	SK-1081AQ2
QBPK2400	SK-1082AQ1
QBPK2401	SK-1082AQ2
QBPK2470	SK-1088AQ1
QBPK2472	SK-1088AQ1
QBPK2590	SK-1100AQ1
QBPK2620	SK-1103AQ1
QBPK2680	SK-1109AQ2
QBPK2681	SK-1109AQ1
QBPK2700	SK-1111AQ1
QBPK2730	SK-1113AQ1
QBPK2910	SK-1131AQ1
QBPK2911	SK-1131AQ2
QBPK3140	SK-1162AQ1
QBPK3312	SK-1162AQ1
QBPK3391	SK-1169AQ1
QBPK3580	SK-1183AQ1
QBPK4370	SK-1258AQ1
QBPK4570	SK-1270AQ1
QBPK4820	SK-1288AQ1
QBPK5570	SK-1337AQ1
QBPK5591	SK-1338AQ1
QBPK5770	SK-1353AQ1
QBPK5780	SK-1354AQ1
QBPK5791	SK-1355AQ1
QBPK5792	SK-1355AQ2
QBPK5820	SK-1511AQ1
QBPK5821	SK-1511AQ2
QBPK5832	SK-1582AQ1
QBPK5832	SK-1583AQ1
QBPK5850	SK-1534AQ1

QUINTON HAZELL

QBPK5860	SK-1394AQ1
QBPK5870	SK-1410AQ1
QBPK5880	SK-1418AQ1
QBPK5900	SK-1493AQ1
QBPK6090	SK-1697AQ1
QBPK6120	SK-1430AQ1
QBPK6150	SK-1491AQ1
QBPK6200	SK-1399AQ1
QBPK6250	SK-1372AQ1
QBPK6252	SK-1372AQ2
QBPK6260	SK-1487AQ1
QBPK6290	SK-1378AQ1
QBPK6290	SK-1388AQ1
QBPK6350	SK-1644AQ1
QBPK6410	SK-1660AQ1
QBPK6440	SK-1391AQ1
QBPK6450	SK-1424AQ1
QBPK6470	SK-1594AQ1
QBPK6480	SK-1685AQ1
QBPK6490	SK-1421AQ1
QBPK6511	SK-1526AQ2
QBPK6570	SK-1602AQ1
QBPK6580	SK-1696AQ1
QBPK6590	SK-1586AQ1
QBPK6680	SK-1592AQ1
QBPK6780	SK-1486AQ1
QBPK6790	SK-1392AQ1
QBPK6800	SK-1615AQ1
QBPK6830	SK-1609AQ1
QBPK6930	SK-1755AQ1
QBPK6951	SK-1595AQ1
QBPK6990	SK-1599AQ1
QBPK7010	SK-1598AQ1
QBPK7020	SK-1316AQ1
QBPK7030	SK-1589AQ1
QBPK7080	SK-1724AQ1
QBPK7081	SK-1724AQ2
QBPK7180	SK-1676AQ1
QBPK7182	SK-1676AQ1
QBPK7340	SK-1635AQ1
QBPK7490	SK-1630AQ1
QBPK7491	SK-1630AQ1
QBPK7520	SK-1614AQ1
QBPK7540	SK-1617AQ1
QBPK7580	SK-1492AQ1
QBPK7642	SK-1487AQ3
QBPK7660	SK-1694AQ2
QBPK7661	SK-1694AQ1
QBPK7890	SK-1367AQ1
QBPK7940	SK-1646AQ1

QUINTON HAZELL

QBPK7980	SK-1587AQ1
QBPK8001	SK-1686AQ1
QBPK8010	SK-1666AQ1
QBPK8090	SK-1380AQ1
QBPK8170	SK-1693AQ1
QBPK8290	SK-1678AQ1
QBPK8310	SK-1697AQ1
QBPK8670	SK-1586AQ1
QBPK8690	SK-1727AQ2
QBPK8820	SK-1724AQ1
QTA1004	0-N1721
QTA1007	0-N1446
QTA1008	0-N1681
QTA1009	0-N1968
QTA1011	0-N1305
QTA1014	0-N2343
QTA1016	0-N1432S
QTA1017	0-N1304
QTA1021	0-N1472
QTA1021	0-N1472S
QTA1022	0-N1488
QTA1022	0-N1488S
QTA1023	0-N152
QTA1023	0-N152S
QTA1024	0-N1593
QTA1024	0-N1593S
QTA1026	0-N1470
QTA1026	0-N1470S
QTA1027	0-N1314
QTA1028H	0-N1747
QTA1031	0-N1416
QTA1032	0-N1501
QTA1032	0-N1501S
QTA1034	0-N1897
QTA1034	0-N1897S
QTA1035	0-N1845
QTA1035	0-N1845S
QTA1038	0-N1584
QTA1046	0-N1585
QTA1046	0-N1585S
QTA1047	0-N2140
QTA1053	0-N1462
QTA1053	0-N1462S
QTA1055H	0-N2413
QTA1059	0-N1291
QTA1059	0-N1291S
QTA1060	0-N1317
QTA1060	0-N1317S
QTA1061	0-N1431
QTA1062	0-N1641

QUINTON HAZELL

QTA1062	0-N1641S
QTA1063	0-N1703
QTA1065	0-N1485
QTA1065	0-N1485S
QTA1068	0-N2345
QTA1071	0-N1543
QTA1073	0-N1005
QTA1074	0-N1586
QTA1075	0-N1527
QTA1075	0-N1527S
QTA1077	0-N1299
QTA1077	0-N1299S
QTA1078	0-N1506
QTA1078	0-N1506S
QTA1079H	0-N2410
QTA1080	0-N1300
QTA1080	0-N1300S
QTA1081	0-N1741
QTA1081	0-N1741S
QTA1082	0-N2135
QTA1083	0-N1294
QTA1083	0-N1294S
QTA1083	0-N1559S
QTA1084	0-N1511
QTA1085	0-N1437
QTA1086	0-N1640
QTA1086	0-N1640S
QTA1088	0-N1447S
QTA1094H	0-N1932
QTA1098	0-N2047
QTA1099	0-N1514
QTA1099	0-N1514S
QTA1100	0-N2020
QTA1104	0-N1509
QTA1104	0-N1509S
QTA1109	0-N174
QTA1114	0-N1385
QTA1118	0-N1595
QTA1118	0-N1595S
QTA1119	0-N1410
QTA1119	0-N1410S
QTA1123	0-N1402
QTA1123	0-N1402S
QTA1126	0-N1544
QTA1127	0-N1544
QTA1128	0-N1594
QTA1129	0-N1464
QTA1129	0-N1464S
QTA1130	0-N1438
QTA1130	0-N1438S

QUINTON HAZELL

QUINTON HAZELL

QUINTON HAZELL

QUINTON HAZELL

QTA1132	0-N1413
QTA1133	0-N1517
QTA1133	0-N1517S
QTA1134	0-N1487
QTA1134	0-N1487S
QTA1135	0-N1493
QTA1135	0-N1493S
QTA1137	0-N1471
QTA1137	0-N1471S
QTA1140	0-N1822
QTA1140	0-N1822S
QTA1141	0-N1671
QTA1141	0-N1671S
QTA1143	0-N2127
QTA1144	0-N1740
QTA1146	0-N1680
QTA1147	0-N1748
QTA1150	0-N1486
QTA1150	0-N1486S
QTA1152	0-N1596
QTA1154	0-N1481
QTA1154	0-N1481S
QTA1157	0-N1497
QTA1157	0-N1497S
QTA1163	0-N1592
QTA1163	0-N1736
QTA1164	0-N1538
QTA1164	0-N1538S
QTA1165	0-N1494
QTA1165	0-N1494S
QTA1168	0-N1620
QTA1168	0-N1620S
QTA1172	0-N1473
QTA1172	0-N1473S
QTA1173H	0-N1757
QTA1175	0-N1421
QTA1176	0-N1386
QTA1177	0-N1339
QTA1177	0-N1339S
QTA1178	0-N1450
QTA1179	0-N1966
QTA1180	0-N1387
QTA1182	0-N1657
QTA1182	0-N1657S
QTA1184H	0-N1951
QTA1185H	0-N2146
QTA1185H	0-N2147
QTA1187	0-N1645
QTA1187	0-N1645S
QTA1188	0-N1466

QTA1188	0-N1466S
QTA1192	0-N1663
QTA1192	0-N1663S
QTA1194	0-N1717
QTA1194	0-N1717S
QTA1197H	0-N2144
QTA1199H	0-N2146
QTA1199H	0-N2147
QTA1200H	0-N2147
QTA1201H	0-N2142
QTA1203	0-N1588
QTA1203	0-N1588S
QTA1205	0-N1396
QTA1209	0-N1469
QTA1210	0-N2037
QTA1210	0-N2037S
QTA1213	0-N1597
QTA1214	0-N1627
QTA1214	0-N1627S
QTA1215	0-N1720
QTA1215	0-N1720S
QTA1217	0-N1409
QTA1218	0-N1611
QTA1218	0-N1611S
QTA1219	0-N1474
QTA1221	0-N1591
QTA1223	0-N1606
QTA1223	0-N1606S
QTA1225	0-N1636
QTA1225	0-N1636S
QTA1231	0-N1043
QTA1234	0-N2141
QTA1235	0-N1397
QTA1236	0-N1395
QTA1237	0-N1723
QTA1238	0-N1388
QTA1244	0-N1669
QTA1244	0-N1669S
QTA1247	0-N1513
QTA1247	0-N1513S
QTA1250	0-N1518
QTA1250	0-N1518S
QTA1253	0-N1483
QTA1253	0-N1483S
QTA1258	0-N1394
QTA1259	0-N1528
QTA1259	0-N1528S
QTA1260	0-N1598
QTA1269	0-N1732
QTA1269	0-N1732S

QTA1274	0-N1526
QTA1274	0-N1526S
QTA1278	0-N1492
QTA1278	0-N1492S
QTA1280	0-N1525
QTA1280	0-N1525S
QTA1283	0-N1799
QTA1283	0-N1799S
QTA1285	0-N1432
QTA1308	0-N1726
QTA1311	0-N1454
QTA1322	0-N1476
QTA1322	0-N1476S
QTA1325	0-N1459
QTA1325	0-N1459S
QTA1328	0-N1675
QTA1333	0-N1392
QTA1336	0-N1519
QTA1336	0-N1519S
QTA1337	0-N1896
QTA1337	0-N1896S
QTA1338	0-N1895
QTA1338	0-N1895S
QTA1339	0-N1520
QTA1339	0-N1520S
QTA1339	0-N1610
QTA1342	0-N1427
QTA1342	0-N1427S
QTA1343	0-N1425
QTA1344	0-N1558S
QTA1346	0-N1953
QTA1346	0-N1953S
QTA1348	0-N1704
QTA1348	0-N1704S
QTA1349	0-N1959
QTA1353	0-N1649
QTA1357	0-N1516
QTA1357	0-N1516S
QTA1358	0-N1791
QTA1358	0-N1791S
QTA1359	0-N1515
QTA1359	0-N1515S
QTA1361	0-N1587
QTA1361	0-N1587S
QTA1365	0-N1875
QTA1365	0-N1875S
QTA1366	0-N1731
QTA1366	0-N1731S
QTA1367	0-N1473
QTA1367	0-N1473S

QTA1369	0-N1743
QTA1370	0-N1589
QTA1371	0-N1664
QTA1371	0-N1664S
QTA1374	0-N1626
QTA1374	0-N1626S
QTA1377	0-N1840
QTA1377	0-N1840S
QTA1378	0-N1808
QTA1378	0-N1808S
QTA1380	0-N1502
QTA1380	0-N1502S
QTA1382	0-N2276
QTA1383	0-N1673
QTA1383	0-N1673S
QTA1384	0-N2046
QTA1384	0-N2046S
QTA1387	0-N1924
QTA1390	0-N1620
QTA1390	0-N1620S
QTA1397	0-N1733
QTA1397	0-N1733S
QTA187	0-N1301
QTA188	0-N1298
QTA189	0-N1295
QTA189	0-N1295S
QTA191	0-N847
QTA192	0-N1278
QTA192	0-N1442
QTA193	0-N1288
QTA195	0-N1280
QTA204	0-N2347
QTA210	0-N1753
QTA214	0-N139
QTA227	0-N1604
QTA235	0-N1682
QTA258H	0-N2412
QTA259	0-N1303
QTA259H	0-N1303
QTA261H	0-N1758
QTA263H	0-N2409
QTA265H	0-N1974
QTA266	0-N1296
QTA267	0-N1297
QTA296	0-N1603
QTA420	0-N1973
QTA422	0-N2349
QTA424	0-N1751
QTA494	0-N1417
QTA695	0-N2349



QUINTON HAZELL

QTA697	0-N1712
QTA699	0-N133
QTA701	0-N1713
QTA702	0-N1722
QTA707	0-N187
QTA708	0-N1672
QTA711	0-N1599
QTA711	0-N1599S
QTA712	0-N1407
QTA712	0-N1407S
QTA726	0-N1711S
QTA728	0-N2336
QTA730	0-N150
QTA732	0-N1734
QTA734	0-N2332
QTA736	0-N2333
QTA737	0-N2334
QTA738	0-N2342
QTA739	0-N2335
QTA740	0-N1602
QTA742	0-N1752
QTA743	0-N1590
QTA748	0-N1736
QTA761	0-N095
QTA777	0-N197
QTA789	0-N1975
QTA790	0-N1750
QTA798	0-N149
QTA799	0-N1589
QTA829	0-N1927
QTA846	0-N1857
QTA846	0-N1857S
QTA848	0-N187
QTA849	0-N1756
QTA877	0-N1484
QTA877	0-N1484S
QTA893	0-N1041
QTA893	0-N1041S
QTA895	0-N1445
QTA895	0-N1445S
QTA917	0-N1439
QTA918	0-N1290
QTA918	0-N1290S
QTA920	0-N1013
QTA920	0-N1013S
QTA921	0-N1625
QTA921	0-N1625S
QTA922	0-N1011
QTA922	0-N1011S
QTB722	SK-1675

QUINTON HAZELL

QTT100	0-N811
QTT1003	0-N1045
QTT1004	0-N1046
QTT1006	0-N1336
QTT1007	0-N1335
QTT1008	0-N1341
QTT1009	0-N1316
QTT101	0-N862
QTT1010	0-N1367
QTT1017	0-N1058
QTT102	0-N861
QTT1024	0-N1065
QTT1025	0-N1057
QTT1026	0-N182
QTT1027	0-N1062
QTT1028	0-N1066
QTT1029	0-N1327
QTT103	0-N812
QTT1032	0-N1351
QTT1033	0-N1352
QTT1035	0-N1353
QTT1036	0-N1354
QTT1037	0-N1355
QTT1038	0-N1331
QTT104	0-N814
QTT1040	0-N1498
QTT1041	0-N1127
QTT1043	0-N1365
QTT1044	0-N1323
QTT1045	0-N1112
QTT1046	0-N1173
QTT105	0-N813
QTT1053	0-N1371
QTT1057	0-N1342
QTT1058	0-N1050
QTT106	0-N869
QTT1061	0-N1085
QTT1062	0-N1051
QTT1062	0-N1051S
QTT1064	0-N1350
QTT1065	0-N1122
QTT1066	0-N1120
QTT1067	0-N1372
QTT1068	0-N168
QTT1070	0-N1383
QTT1073	0-N1042
QTT1074	0-N1566
QTT1075	0-N1121
QTT1076	0-N1326
QTT1078	0-N1359

QUINTON HAZELL

QTT1079	0-N1360
QTT108	0-N815
QTT1080	0-N1618
QTT1084	0-N1366
QTT1085	0-N1572
QTT1086	0-N196
QTT1087	0-N1340
QTT109	0-N822
QTT1091	0-N1338
QTT1093	0-N1328
QTT1094	0-N1329
QTT110	0-N856
QTT1100	0-N1838S
QTT1103	0-N1346
QTT1105	0-N1564
QTT1106	0-N1616
QTT111	0-N854
QTT1113	0-N1883
QTT1113	0-N1883S
QTT1114	0-N2058
QTT1116	0-N1129
QTT1117	0-N1369
QTT112	0-N1571
QTT112	0-N173
QTT1121	0-N1567
QTT1124	0-N2320
QTT1125	0-N176
QTT1126	0-N1879
QTT1127	0-N1773
QTT113	0-N887
QTT1130	0-N1382
QTT1131	0-N1884
QTT1134	0-N2414
QTT1142	0-N1500
QTT1143	0-N191
QTT1144	0-N1379
QTT1145	0-N1377
QTT1146	0-N1824
QTT1147	0-N130
QTT1148	0-N1347
QTT1149	0-N1368
QTT1150	0-N1343
QTT1153	0-N1348
QTT1153	0-N1936
QTT1154	0-N1357
QTT1155	0-N1358
QTT116	0-N857
QTT1160	0-N1324
QTT1160	0-N1573
QTT1162	0-N1962

QUINTON HAZELL

QTT1163	0-N1612
QTT1165	0-N1574
QTT1169	0-N1905
QTT117	0-N863
QTT1170	0-N1378
QTT1171	0-N1775
QTT1176	0-N2018
QTT1177	0-N1575
QTT1179	0-N1817
QTT1179	0-N1817S
QTT118	0-N881
QTT1180	0-N1819
QTT1181	0-N1820
QTT1184	0-N2208
QTT1189	0-N1359
QTT119	0-N880
QTT1191	0-N118P
QTT1192	0-N1381
QTT120	0-N882
QTT121	0-N871
QTT122	0-N870
QTT123	0-N883
QTT1231	0-N115
QTT1233	0-N2063
QTT124	0-N800
QTT125	0-N801
QTT1269	0-N2224
QTT127	0-N805
QTT1270	0-N2382
QTT1276	0-N2057
QTT128	0-N923
QTT1291	0-N2313
QTT1292	0-N2381
QTT1294	0-N2424
QTT1298	0-N2326
QTT130	0-N866
QTT131	0-N954
QTT132	0-N867
QTT133	0-N809
QTT137	0-N850
QTT143	0-N818
QTT144	0-N820
QTT146	0-N826
QTT151	0-N837
QTT152	0-N838
QTT153	0-N902
QTT154	0-N874
QTT155	0-N839
QTT157	0-N842
QTT158	0-N889

QUINTON HAZELL		QUINTON HAZELL		QUINTON HAZELL		QUINTON HAZELL	
QTT159	0-N889	QTT261	0-N1758	QTT352	0-N071	QTT438	0-N898
QTT159+R215	0-N889	QTT266	0-N1296	QTT356	0-N074	QTT440	0-N927
QTT166	0-N875	QTT270	0-N037	QTT358	0-N083	QTT442	0-N1223
QTT167	0-N877	QTT271	0-N038	QTT359	0-N084	QTT444	0-N1225
QTT168	0-N876	QTT274	0-N000	QTT361	0-N077	QTT445	0-N1226
QTT169	0-N859	QTT276	0-N039	QTT362	0-N081	QTT446	0-N916
QTT172	0-N806	QTT277	0-N040	QTT363	0-N090	QTT448	0-N020
QTT173	0-N808	QTT278	0-N951	QTT364	0-N091	QTT451	0-N995
QTT174	0-N807	QTT279	0-N114	QTT368	0-N088	QTT452	0-N013
QTT175	0-N860	QTT280	0-N113	QTT371	0-N056	QTT453	0-N992
QTT177	0-N924	QTT283	0-N155	QTT372	0-N065	QTT456	0-N006
QTT178	0-N922	QTT284	0-N156	QTT373	0-N052	QTT458	0-N989
QTT179	0-N832	QTT285	0-N915	QTT374	0-N192	QTT459	0-N991
QTT180	0-N911	QTT287	0-N1214	QTT375	0-N051	QTT461	0-N996
QTT181	0-N903	QTT288	0-N096	QTT376	0-N188	QTT466	0-N005
QTT182	0-N904	QTT291	0-N100	QTT378	0-N058	QTT468	0-N007
QTT185	0-N955	QTT292	0-N910	QTT380	0-N986	QTT470	0-N997
QTT187	0-N1301	QTT293	0-N879	QTT381	0-N183	QTT471	0-N998
QTT189	0-N1295	QTT295	0-N878	QTT383	0-N061	QTT472	0-N988
QTT189	0-N1295S	QTT297	0-N907	QTT386	0-N053	QTT474	0-N990
QTT190	0-N846	QTT298	0-N906	QTT387	0-N179	QTT477	0-N993
QTT191	0-N847	QTT299	0-N953	QTT389	0-N063	QTT479	0-N000
QTT193	0-N1288	QTT300	0-N952	QTT390	0-N054	QTT480	0-N999
QTT195	0-N1280	QTT301	0-N193	QTT391	0-N987	QTT483	0-N001
QTT196	0-N874	QTT302	0-N178	QTT392	0-N062	QTT486	0-N994
QTT198	0-N948	QTT303	0-N982	QTT393	0-N186	QTT491	0-N008
QTT200	0-N909	QTT304	0-N928	QTT394	0-N055	QTT493	0-N128
QTT202	0-N806	QTT305	0-N068	QTT396	0-N024	QTT494	0-N1417
QTT203	0-N940	QTT309	0-N978	QTT398	0-N1218	QTT496	0-N1229
QTT208	0-N863	QTT310	0-N979	QTT399	0-N1219	QTT497	0-N1230
QTT209	0-N138	QTT311	0-N905	QTT400	0-N1220	QTT498	0-N131
QTT213	0-N141	QTT315	0-N981	QTT403	0-N094	QTT499	0-N921
QTT219	0-N822	QTT316	0-N926	QTT404	0-N032	QTT500	0-N163
QTT221	0-N819	QTT317	0-N981	QTT406	0-N030	QTT502	0-N132
QTT222	0-N820	QTT320	0-N066	QTT408	0-N025	QTT503	0-N130S
QTT223	0-N823	QTT321	0-N969	QTT411	0-N021	QTT504	0-N941
QTT224	0-N835	QTT322	0-N067	QTT412	0-N022	QTT505	0-N2000
QTT228	0-N162	QTT324	0-N054	QTT413	0-N034	QTT507	0-N917
QTT229	0-N960	QTT326	0-N064	QTT414	0-N031	QTT508	0-N1231
QTT230	0-N125	QTT327	0-N059	QTT415	0-N033	QTT509	0-N920
QTT230	0-N125S	QTT329	0-N184	QTT416	0-N029	QTT510	0-N1232
QTT231	0-N862	QTT332	0-N069	QTT418	0-N035	QTT511	0-N930
QTT233	0-N849	QTT333	0-N070	QTT419	0-N1222	QTT512	0-N959
QTT235	0-N1682	QTT335	0-N072	QTT420	0-N1973	QTT514	0-N958
QTT236	0-N931	QTT336	0-N073	QTT422	0-N2349	QTT516	0-N937
QTT253	0-N901	QTT337	0-N075	QTT427	0-N943	QTT521	0-N925
QTT254	0-N900	QTT338	0-N092	QTT430	0-N964	QTT522	0-N970
QTT255	0-N944	QTT339	0-N983	QTT431	0-N277	QTT523	0-N974
QTT256	0-N945	QTT340	0-N036	QTT433	0-N899	QTT525	0-N973
QTT257	0-N985	QTT346	0-N1216	QTT436	0-N894	QTT526	0-N971



QUINTON HAZELL

QTT527	0-N2323
QTT528	0-N041
QTT530	0-N043
QTT544	0-N938
QTT546	0-N1779
QTT551	0-N102
QTT554	0-N956
QTT555	0-N957
QTT561	0-N975
QTT563	0-N045
QTT565	0-N049
QTT566	0-N048
QTT567	0-N046
QTT568	0-N047
QTT569	0-N050
QTT570	0-N087
QTT573	0-N912
QTT578	0-N891
QTT581	0-N968
QTT584	0-N180
QTT587	0-N082
QTT588	0-N027
QTT589	0-N079
QTT590	0-N078
QTT591	0-N076
QTT600	0-N060
QTT637	0-N965
QTT641	0-N949
QTT643	0-N897
QTT649	0-N1243
QTT651	0-N236
QTT657	0-N237
QTT667	0-N1244
QTT669	0-N019
QTT674	0-N014
QTT675	0-N939
QTT678	0-N103
QTT679	0-N109
QTT680	0-N160
QTT684	0-N919
QTT685	0-N1246
QTT686	0-N101
QTT688	0-N882
QTT689	0-N913
QTT693	0-N1749
QTT693	0-N1749S
QTT695	0-N2349
QTT698	0-N124
QTT699	0-N133
QTT708	0-N1672

QUINTON HAZELL

QTT726	0-N1711S
QTT730	0-N150
QTT746	0-N151
QTT761	0-N095
QTT798	0-N149
QTT799	0-N1589
QTT814	0-N121
QTT815	0-N122
QTT816	0-N214
QTT817	0-N215
QTT830	0-N2260
QTT832	0-N126
QTT834	0-N1250
QTT838	0-N950
QTT839	0-N938
QTT840	0-N194
QTT841	0-N115
QTT842	0-N196
QTT843	0-N113
QTT844	0-N1256
QTT846	0-N1857
QTT846	0-N1857S
QTT847	0-N104
QTT850	0-N106
QTT853	0-N112
QTT855	0-N148
QTT860	0-N105
QTT861	0-N1258
QTT862	0-N107
QTT863	0-N1654
QTT864	0-N108
QTT865	0-N109
QTT866	0-N110
QTT867	0-N208
QTT870	0-N118P
QTT871	0-N1259
QTT873	0-N158
QTT874	0-N028
QTT875	0-N146
QTT876	0-N147
QTT877	0-N1263
QTT878	0-N111
QTT879	0-N147
QTT880	0-N262
QTT881	0-N910
QTT883	0-N1260
QTT884	0-N123
QTT885	0-N293
QTT888	0-N119P
QTT890	0-N112

QUINTON HAZELL

QTT891	0-N116
QTT892	0-N117
QTT893	0-N1041
QTT893	0-N1041S
QTT895	0-N1445
QTT895	0-N1445S
QTT900	0-N1571
QTT901	0-N854
QTT903	0-N1262
QTT905	0-N1263
QTT906	0-N111
QTT907	0-N1265
QTT910	0-N126
QTT921	0-N1625
QTT921	0-N1625S
QTT922	0-N1011
QTT922	0-N1011S
QTT926	0-N129
QTT927	0-N157
QTT929	0-N159
QTT930	0-N201
QTT932	0-N1266
QTT933	0-N137
QTT935	0-N169
QTT936	0-N941
QTT937	0-N2001
QTT938	0-N168
QTT939	0-N166
QTT940	0-N165
QTT941	0-N1268
QTT942	0-N167
QTT943	0-N172
QTT944	0-N127
QTT945	0-N295
QTT946	0-N292
QTT947	0-N290
QTT948	0-N294
QTT949	0-N291
QTT950	0-N145
QTT951	0-N1269
QTT952	0-N1270
QTT953	0-N1056
QTT954	0-N170
QTT955	0-N171
QTT956	0-N1272
QTT957	0-N1273
QTT958	0-N164
QTT960	0-N1236
QTT961	0-N1237
QTT962	0-N1048

QUINTON HAZELL

QTT963	0-N1274
QTT964	0-N1261
QTT965	0-N1248
QTT966	0-N198
QTT968	0-N1238
QTT969	0-N1275
QTT970	0-N1276
QTT971	0-N107
QTT978	0-N1277
QTT979	0-N300

RUVILLE

50000701	R-1190AQ1
50000704	R-1072AQ1
5063850	SK-1733
52206	0-N839
55000	0-N809
55001	0-N925
5500170	SK-1064
55002	0-N955
5500270	SK-1060
55003	0-N866
5500370	SK-1059
55004	0-N867
55005	0-N954
55006	0-N1301
55007	0-N1298
55008	0-N1295
55008	0-N1295S
55010	0-N2409
55011	0-N1293
55012	0-N1306
55013	0-N1974
55014	0-N1758
55015	0-N1927
55018	0-N2140
55019	0-N1296
55020	0-N1292
55021	0-N1297
55022	0-N1303
55023	0-N1305
55024	0-N1304
55025	0-N1290
55025	0-N1290S
55026	0-N1294
55026	0-N1294S
55027	0-N1291
55027	0-N1291S
55029	0-N1585
55029	0-N1585S
55030	0-N1586

RUVILLE		RUVILLE		RUVILLE		RUVILLE	
55031	0-N1787	55066	0-N1788	55103	0-N1288	55161	0-N1587
55032	0-N1299	55066	0-N1788S	55104	0-N1861	55161	0-N1587S
55032	0-N1299S	55067	0-N2128	55105	0-N1280	55162	0-N1457
55033	0-N1300	55068	0-N1912	55106	0-N1013	55163	0-N1489S
55033	0-N1300S	55068	0-N1912S	55106	0-N1013S	55165	0-N1946
55034	0-N2410	55069	0-N1523	55107	0-N1625	55165	0-N1946S1
55035	0-N1514	55070	0-N1524	55107	0-N1625S	55165	0-N1946S2
55035	0-N1514S	55071	0-N1940	55108	0-N1011	55167	0-N2218
55036	0-N1527	55071	0-N1940S	55108	0-N1011S	55168	0-N2193
55036	0-N1527S	55072	0-N1913	55109	0-N1862	55168	0-N2193S
55037	0-N1506	55072	0-N1913S	55110	0-N1864	55175	0-N1902
55037	0-N1506S	55073	0-N1900	55113	0-N1289	55175	0-N1902S
55038	0-N1741	55074	0-N2076	55114	0-N565592	55176	0-N2143
55038	0-N1741S	55074	0-N2076S	55118	0-N1452	55178	0-N1670
55039	0-N1511	55075	0-N1794	55119	0-N1833	55178	0-N1670S
55040	0-N1640	55075	0-N1794S	55120	0-N1703	55179	0-N1746
55040	0-N1640S	55076	0-N1790	55121	0-N1279	55180	0-N2138
55041	0-N2411	55077	0-N1961	55122	0-N1043	55181	0-N1972
55042	0-N1559S	55078	0-N1505S	55123	0-N1641	55182	0-N1744
55043	0-N2135	55079	0-N2031	55123	0-N1641S	55183	0-N2245
55044	0-N1932	55079	0-N2031S	55124	0-N1442	55183	0-N2245S1
55045	0-N1396	55080	0-N2082	55125	0-N1860	55183	0-N2245S2
55046	0-N1726	55080	0-N2082S	55126	0-N1951	55183	0-N2245S3
55047	0-N1507	55081	0-N2084	55132	0-N2020	55187	0-N1941
55047	0-N1507S	55081	0-N2084S	55133	0-N2144	55187	0-N1941S1
55048	0-N1512	55082	0-N2387	55134	0-N2145	55187	0-N1941S2
55048	0-N1512S	55082	0-N2387S	55135	0-N2146	55187	0-N1941S3
55049	0-N1668	55083	0-N1834	55136	0-N2147	55189	0-N1926
55049	0-N1668S	55083	0-N1834S	55138	0-N1436	55190	0-N1710
55050	0-N1447S	55084	0-N2124	55138	0-N1436S	55190	0-N1710S
55051	0-N1792	55084	0-N2124S	55139	0-N2131	55191	0-N1637
55052	0-N1508	55085	0-N1492	55140	0-N1560	55195	0-N2219
55052	0-N1508S	55085	0-N1492S	55141	0-N2141	55195	0-N2219S
55053	0-N1515	55086	0-N1786	55143	0-N1645	55198	0-N2246
55053	0-N1515S	55087	0-N1944	55143	0-N1645S	55198	0-N2246S1
55054	0-N1516	55089	0-N1923	55144	0-N1282	55198	0-N2246S2
55054	0-N1516S	55090	0-N1621	55146	0-N2142	55198	0-N2246S3
55055	0-N1791	55090	0-N1621S	55147	0-N1723	55199	0-N2132
55055	0-N1791S	55091	0-N2129	55148	0-N1395	55202	0-N837
55056	0-N1669	55092	0-N2130	55149	0-N1388	5520270	SK-1027
55056	0-N1669S	55093	0-N1919	55150	0-N2388	5520271	SK-1053
55057	0-N1513	55093	0-N1919S	55150	0-N2388S	55202711	SK-1053AQ1
55057	0-N1513S	55094	0-N1431	55152	0-N1397	55203	0-N838
55059	0-N2125	55095	0-N1958	55154	0-N1283	5520370	SK-1039
55060	0-N1453	55095	0-N1958S	55155	0-N1043	55204	0-N874
55061	0-N1638	55096	0-N1950	55156	0-N1680	5520470	SK-1041
55062	0-N1922	55098	0-N2075	55157	0-N1284	55205	0-N902
55064	0-N1793	55100	0-N846	55158	0-N1285	55206	0-N839
55064	0-N1793S	55101	0-N847	55159	0-N1287	5520671	SK-1160
55065	0-N1871	55102	0-N1278	55160	0-N2148	55208	0-N842



RUVILLE		RUVILLE		RUVILLE		RUVILLE	
5520870	SK-1049	55241	0-N1533	5528570	SK-1754	55323	0-N127
5520871	SK-1052	55241	0-N1533S	55286	0-N1702	55324	0-N1603
55209	0-N903	55242	0-N1435	55289	0-N1811	55327	0-N102
5520970	SK-1094	55242	0-N1435S	55289	0-N1811S	5532770	SK-1355
55210	0-N904	55243	0-N1501	55290	0-N1991	5532771	SK-1073
55211	0-N096	55243	0-N1501S	55291	0-N1460	55327711	SK-1073AQ3
55212	0-N1214	55244	0-N1385	55292	0-N2014	55327712	SK-1073AQ2
55214	0-N915	55245	0-N1903	55292	0-N2014S	55327713	SK-1073AQ1
5521470	SK-1042	55245	0-N1903S	55298	0-N1963	5532772	SK-1355
55214701	SK-1042AQ1	55246	0-N1420	5530070	SK-1056	55327721	SK-1355AQ2
55214702	SK-1042AQ2	55247	0-N1418	55301	0-N875	55327722	SK-1113AQ2
5521471	SK-1078	55248	0-N1400	5530170	SK-1037	55327722	SK-1355AQ1
55214711	SK-1078AQ1	55248	0-N1400S	55301701	SK-1037AQ1	5532773	SK-1113
55214712	SK-1078AQ2	55249	0-N903	55302	0-N948	55327731	SK-1113AQ1
55214713	SK-1078AQ3	55250	0-N2157	5530270	SK-1162	55327731	SK-1355AQ3
55215	0-N155	55251	0-N2156	55302701	SK-1162AQ2	55327732	SK-1113AQ2
55216	0-N156	55252	0-N1497	55302702	SK-1162AQ1	55328	0-N1485
55217	0-N985	55252	0-N1497S	55302703	SK-1162AQ3	55328	0-N1485S
55217S	0-N985	55254	0-N1433	55303	0-N877	55330	0-N1437
55218	0-N1260	55254	0-N1433S	5530370	SK-1163	55331	0-N1322
55219	0-N123	55256	0-N1477	55304	0-N876	55331	0-N1322S
55220	0-N089	55256	0-N1477S	55305	0-N909	55332	0-N2169
55221	0-N1779	55257	0-N1392	5530570	SK-1038	55333	0-N300
55222	0-N1246	55258	0-N1428	55305701	SK-1038AQ1	55334	0-N2168
55223	0-N197	55259	0-N1458	55306	0-N100	55335	0-N1765
55226	0-N294	55260	0-N1520	5530670	SK-1100	55336	0-N1464
5522670	SK-1077	55260	0-N1520S	55306701	SK-1100AQ1	55336	0-N1464S
55227	0-N290	55260	0-N1610	5530672	SK-1165	55338	0-N1466
5522770	SK-1340	55262	0-N1797	5530673	SK-1478	55338	0-N1466S
5522771	SK-1339	55262	0-N1797S	55307	0-N879	55341	0-N1765S
55228	0-N291	55263	0-N1942	5530770	SK-1054	55342	0-N1383
55229	0-N292	55264	0-N1719	5530771	SK-1164	5534270	SK-1644
55230	0-N293	55264	0-N1719S	55308	0-N910	55342701	SK-1644AQ1
55231	0-N295	55265	0-N1665	5530871	SK-1168	55343	0-N1588
5523170	SK-1341	55266	0-N1390	55311	0-N907	55343	0-N1588S
55233	0-N1796	55266	0-N1390S	55312	0-N953	55344	0-N1085
55233	0-N1796S	55268	0-N1653S	55313	0-N952	5534470	SK-1481
55234	0-N1897	55270	0-N2155	55314	0-N906	5534471	SK-1612
55234	0-N1897S	55270	0-N2155S	55315	0-N101	55345	0-N2170
55235	0-N1434	55272	0-N1557S	5531570	SK-1169	55345	0-N2170S
55235	0-N1434S	55274	0-N1709	55315701	SK-1169AQ1	55346	0-N2167
55236	0-N1443	55274	0-N1709S1	55316	0-N126	55347	0-N1768
55236	0-N1443S	55274	0-N1709S2	5531670	SK-1689	55348	0-N1369
55238	0-N1957	55275	0-N1716	55317	0-N878	5534870	SK-1632
55238	0-N1957S	55281	0-N1622	55318	0-N1439	5534871	SK-1667
55239	0-N1367	55282	0-N1564	55320	0-N1422	55349	0-N1574
5523970	SK-1341	5528270	SK-1659	55320	0-N1422S	55350	0-N1426
55240	0-N1361	55282701	SK-1659AQ1	55321	0-N956	55351	0-N1347
5524070	SK-1049	55285	0-N2220	5532170	SK-1508	5535170	SK-1607
5524071	SK-1351	55285	0-N2220S	55322	0-N957	55352	0-N1495S

RUVILLE

55353	0-N1522
55355	0-N1526
55355	0-N1526S
55356	0-N1348
55357	0-N1799
55357	0-N1799S
55358	0-N2072
55359	0-N1658
55360	0-N1848
55360	0-N1848S
55364	0-N1798
55364	0-N1798S
55368	0-N878
55370	0-N1952
5537070	SK-1723
55370701	SK-1723AQ1
55371	0-N1960
55372	0-N2171
55373	0-N300
55383	0-N1085
5538370	SK-1689
5538371	SK-1481
55384	0-N2171
55385	0-N2197
55385	0-N2197S
55386	0-N2030
55386	0-N2030S
55387	0-N2299
55387	0-N2299S
55388	0-N2283
55393	0-N2221
55394	0-N2340
55396	0-N2389
55396	0-N2389S
55397	0-N2341
55400	0-N805
5540070	SK-1026
5540070	SK-1090
5540071	SK-1120
55401	0-N807
5540171	SK-1129
55401711	SK-1129AQ1
5540172	SK-1578
55401721	SK-1578AQ1
55402	0-N808
5540270	SK-1047
5540271	SK-1123
55403	0-N923
5540370	SK-1126
55403701	SK-1126AQ1

RUVILLE

55404	0-N922
5540470	SK-1119
55405	0-N806
5540570	SK-1001
5540571	SK-1029
55406	0-N924
55407	0-N940
5540770	SK-1343
55407701	SK-1343AQ1
55408	0-N1414
55412	0-N1632
55413	0-N132
5541370	SK-1101
5541371	SK-1261
55414	0-N103
5541470	SK-1069
55415	0-N128
55416	0-N130S
55417	0-N921
55419	0-N160
5541970	SK-1376
55419701	SK-1376AQ1
55420	0-N941
55421	0-N805
5542170	SK-1026
5542170	SK-1090
5542171	SK-1120
55422	0-N2000
55423	0-N1417
55424	0-N1311
55425	0-N1444
5542570	SK-1360
55425701	SK-1360AQ1
55426	0-N104
5542670	SK-1122
5542671	SK-1098
5542672	SK-1425
55427	0-N105
5542770	SK-1344
55427701	SK-1344AQ1
55428	0-N106
5542870	SK-1131
55428701	SK-1131AQ1
55428702	SK-1131AQ2
5542872	SK-1074
55428721	SK-1074AQ1
55429	0-N1310
55430	0-N1258
5543070	SK-1635
55431	0-N165

RUVILLE

55433	0-N166
55434	0-N174
55435	0-N1312
55436	0-N1229
55437	0-N1230
55438	0-N129
5543870	SK-1124
5543871	SK-1104
55439	0-N939
5543970	SK-1130
55440	0-N1236
5544070	SK-1638
5544071	SK-1346
5544072	SK-1638
55441	0-N131
55442	0-N1042
5544270	SK-1710
5544271	SK-1660
55442711	SK-1660AQ1
5544272	SK-1660
5544272	SK-1710
55443	0-N157
5544370	SK-1109
55443701	SK-1109AQ1
55443702	SK-1109AQ2
55444	0-N1041
55444	0-N1041S
55445	0-N108
55445701	SK-1380AQ1
55446	0-N109
5544670	SK-1648
5544671	SK-1648
5544672	SK-1526
55446721	SK-1526AQ1
55447	0-N110
5544770	SK-1526
55450	0-N163
55453	0-N2001
55454	0-N111
5545470	SK-1106
5545471	SK-1512
55455	0-N1262
55456	0-N158
5545670	SK-1511
55456701	SK-1511AQ1
55456702	SK-1511AQ2
5545671	SK-1585
55456711	SK-1585AQ1
5545672	SK-1511
55457	0-N167

RUVILLE

55458	0-N164
55459	0-N168
55460	0-N159
55461	0-N1263
55462	0-N1432
55462	0-N1432S
55464	0-N1317
55464	0-N1317S
55465	0-N1268
55474	0-N1660
55475	0-N1445
55475	0-N1445S
55476	0-N201
55477	0-N116
5547770	SK-1725
55477701	SK-1529AQ1
55477701	SK-1725AQ1
55477702	SK-1526AQ2
5547771	SK-1686
55477711	SK-1686AQ1
5547772	SK-1529
55478	0-N117
55480	0-N1441
55480	0-N1441S
55482	0-N1542S
55483	0-N1543
55484	0-N1800
55485	0-N1313
55486	0-N1600
55488	0-N1459
55488	0-N1459S
55489	0-N1265
5548970	SK-1388
5548971	SK-1378
55489711	SK-1378AQ1
55490	0-N1238
5549070	SK-1383
55490701	SK-1383AQ1
5549071	SK-1377
55490712	SK-1377AQ1
55491	0-N107
5549170	SK-1258
55491701	SK-1258AQ1
5549171	SK-1110
5549171	SK-1259
5549173	SK-1110
5549173	SK-1259
55491732	SK-1259AQ1
55491733	SK-1259AQ1
55492	0-N1275



RUVILLE

55493	0-N1237
55494	0-N1048
5549470	SK-1582
55494701	SK-1372AQ1
55494701	SK-1582AQ2
55494702	SK-1582AQ1
5549471	SK-1583
55494711	SK-1583AQ1
5549472	SK-1603
5549473	SK-1604
55494731	SK-1604AQ1
55494732	SK-1604AQ1
55495	0-N1274
55496	0-N1050
5549670	SK-1640
55497	0-N1344
55498	0-N1364
55499	0-N1372
55500	0-N863
5550070	SK-1021
55500701	SK-1021AQ2
55500702	SK-1021AQ1
5550071	SK-1081
55500711	SK-1081AQ2
55501	0-N856
5550170	SK-1010
55502	0-N173
5550270	SK-1012
5550271	SK-1011
5550272	SK-1036
5550273	SK-1084
5550274	SK-1707
5550275	SK-1099
5550276	SK-1108
5550277	SK-1013
5550278	SK-1107
55503	0-N854
55504	0-N138
55505	0-N1753
55506	0-N883
55507	0-N887
5550770	SK-1015
55509	0-N141
55510	0-N880
5551070	SK-1171
55511	0-N881
5551170	SK-1108S
55512	0-N139
55514	0-N882
5551470	SK-1092

RUVILLE

5551471	SK-1091
55515	0-N913
5551570	SK-1063
5551571	SK-1014
5551572	SK-1093
55518	0-N857
55519	0-N1368
5551970	SK-1630
55519701	SK-1630AQ1
55520	0-N1734
55521	0-N2332
55523	0-N2176
55524	0-N964
5552470	SK-1095
55525	0-N2333
55526	0-N2334
55527	0-N1427
55527	0-N1427S
55528	0-N2342
55529	0-N2335
55530	0-N1602
55531	0-N2016
55532	0-N277
55533	0-N2013
55536	0-N112
5553670	SK-1096
55536701	SK-1096AQ1
55537	0-N965
55538	0-N145
5553870	SK-1338
55538701	SK-1338AQ1
55538702	SK-1338AQ2
55539	0-N148
55540	0-N1259
55541	0-N137
5554170	SK-1491
55541701	SK-1491AQ1
5554171	SK-1531
55542	0-N2177
55543	0-N149
55544	0-N151
55545	0-N1529
55545	0-N1529S
55546	0-N1647
55547	0-N2343
55548	0-N135
55549	0-N134
55550	0-N1589
55551	0-N1449
55552	0-N1479S

RUVILLE

55553	0-N152
55553	0-N152S
55554	0-N1470
55554	0-N1470S
55555	0-N200
5555570	SK-1494
5555571	SK-1631
5555572	SK-1623
5555573	SK-1624
55555731	SK-1624AQ1
5555574	SK-1625
55556	0-N1488
55556	0-N1488S
55557	0-N1590
55558	0-N1752
55559	0-N2179
55561	0-N147
55562	0-N199
5556270	SK-1490
5556271	SK-1620
55563	0-N2336
55564	0-N150
55565	0-N262
55566	0-N198
5556670	SK-1088
55566701	SK-1088AQ1
55567	0-N146
55569	0-N1650
55570	0-N1635
55571	0-N1307
55572	0-N1112
5557270	SK-1486
55572701	SK-1486AQ1
55573	0-N1106
55574	0-N1648
55575	0-N1270
55576	0-N1591
55577	0-N1314
55578	0-N1592
55579	0-N1721
55580	0-N1173
5558070	SK-1493
55580701	SK-1493AQ1
55581	0-N1111
5558170	SK-1487
55581701	SK-1487AQ1
55581702	SK-1487AQ2
55581703	SK-1487AQ3
55582	0-N1269
5558270	SK-1489

RUVILLE

55585	0-N1611
55585	0-N1611S
55586	0-N1802
55586	0-N1802S
55587	0-N1365
55588	0-N1475S
55589	0-N1518
55589	0-N1518S
55590	0-N1729
55591	0-N1474
55592	0-N1476
55592	0-N1476S
55595	0-N1480S
55596	0-N2265
55596	0-N2265S
55597	0-N1409
55598	0-N1898
55598	0-N1898S
55599	0-N1469
55601	0-N1626
55601	0-N1626S
55603	0-N1743
55604	0-N1571
5560470	SK-1663
55605	0-N1323
5560570	SK-1580
55605701	SK-1580AQ1
55606	0-N1663
55606	0-N1663S
55607	0-N1664
55607	0-N1664S
55608	0-N1736
55610	0-N1731
55610	0-N1731S
55611	0-N1875
55611	0-N1875S
55613	0-N2178
55614	0-N2045
55614	0-N2045S
55618	0-N870
55619	0-N1739
55620	0-N2039
55620	0-N2039S
55622	0-N145
5562270	SK-1338
55622701	SK-1338AQ1
55622702	SK-1338AQ2
55629	0-N2060
5562970	SK-1698
55629701	SK-1698AQ1

RUVILLE		RUVILLE		RUVILLE		RUVILLE	
55630	0-N2222	55725	0-N2127	55762	0-N2017	55791	0-N1886S2
55631	0-N1869	55726	0-N1568	55762	0-N2017S	55792	0-N1885
55631	0-N1869S	55727	0-N1568	55764	0-N1496S	55792	0-N1885S1
55632	0-N2253	5572770	SK-1386	55765	0-N1654	55792	0-N1885S2
55633	0-N2380	5572771	SK-1688	5576570	SK-1337	55801	0-N822
55634	0-N2275	5572772	SK-1687	5576570	SK-1709	5580170	SK-1023
55635	0-N2062	55728	0-N1569	5576571	SK-1337	5580170	SK-1665
55637	0-N2344	55729	0-N130	55765711	SK-1337AQ1	55801701	SK-1665AQ1
55639	0-N2279	5572970	SK-1121	55766	0-N1335	55801702	SK-1665AQ2
55639	0-N2279S	5572971	SK-1121	5576670	SK-1595	5580171	SK-1031
55641	0-N2423	55730	0-N1316	55766701	SK-1595AQ1	5580173	SK-1043
5564170	SK-1730	55731	0-N1606	5576671	SK-1668	55801731	SK-1043AQ1
55700	0-N1431	55731	0-N1606S	55766711	SK-1668AQ1	5580174	SK-1421
55701	0-N1315	55732	0-N1342	55767	0-N1336	55801741	SK-1421AQ1
55702	0-N1005	55734	0-N2414	55768	0-N1947	5580175	SK-1418
55703	0-N1266	55735	0-N1046	55769	0-N1340	55801751	SK-1418AQ1
5570370	SK-1619	55736	0-N1332	5576970	SK-1599	55804	0-N818
5570371	SK-1621	5573670	SK-1593	55769701	SK-1599AQ1	5580471	SK-1138
5570374	SK-1619	55737	0-N1657	55771	0-N1337	5580473	SK-1050
5570375	SK-1621	55737	0-N1657S	5577170	SK-1597	55805	0-N819
5570376	SK-1375	55738	0-N1539	5577172	SK-1720	5580570	SK-1140
55703761	SK-1619AQ2	55738	0-N1539S	55772701	SK-1724AQ2	5580571	SK-1032
5570377	SK-1621	55739	0-N1045	55772702	SK-1724AQ1	55806	0-N820
5570377	SK-1633	5573970	SK-1372	55773	0-N1346	55807	0-N823
55703771	SK-1621AQ1	55739702	SK-1372AQ2	55774	0-N1601	5580771	SK-1155
55703772	SK-1621AQ1	55739702	SK-1372AQ3	55774	0-N1601S	5580772	SK-1150
55704	0-N169	55739703	SK-1372AQ1	55775	0-N1738	5580779	SK-1445
55705	0-N1570	55739704	SK-1372AQ2	55776	0-N1534	55809	0-N826
55706	0-N2345	55740	0-N1308	55776	0-N1534S	5580972	SK-1142
55707	0-N168	55741	0-N201	55777	0-N1530	55811	0-N832
55708	0-N1969	55742	0-N1054	55777	0-N1530S	5581170	SK-1151
55709	0-N1276	5574270	SK-1538	55778	0-N1733	55812	0-N835
55710	0-N1363	5574271	SK-1601	55778	0-N1733S	55813	0-N889
55711	0-N1371	55743	0-N1053	55779	0-N1454	55815	0-N850
55712	0-N1051	55744	0-N1052	55780	0-N1525	5581570	SK-1449
55712	0-N1051S	55745	0-N1537	55780	0-N1525S	55822	0-N821
55713	0-N1822	55745	0-N1537S	55781	0-N1566	5582270	SK-1657
55713	0-N1822S	55747	0-N1967	5578170	SK-1661	5582271	SK-1035
55714	0-N1538	55748	0-N1341	5578171	SK-1661	55825	0-N889
55714	0-N1538S	55749	0-N1818	55782	0-N1567	55826	0-N816
55715	0-N1049	55750	0-N1817	55783	0-N2137	5582670	SK-1045
55716	0-N1494	55750	0-N1817S	55783	0-N2137S	5582671	SK-1046
55716	0-N1494S	55751	0-N1671	55784	0-N1955	5582672	SK-1153
55717	0-N1083	55751	0-N1671S	55784	0-N1955S	5582674	SK-1681
55717	0-N1083S	55753	0-N1978	55786	0-N1907	55828	0-N1916
55719	0-N1331	55753	0-N1978S	55787	0-N1795	55829	0-N835
5571970	SK-1592	55754	0-N1536	55787	0-N1795	5582972	SK-1033
55719701	SK-1592AQ1	55754	0-N1536S	55790	0-N1531	5582973	SK-1144
55723	0-N1740	55757	0-N2347	55791	0-N1886	55831	0-N113
55724	0-N2346	55760	0-N1609	55791	0-N1886S1	5583170	SK-1345



RUVILLE

55832	0-N208
55833	0-N951
55835	0-N114
5583570	SK-1361
55835701	SK-1361AQ1
5583571	SK-1639
55837	0-N949
5583770	SK-1154
55840	0-N187
55841	0-N1966
55842	0-N950
5584270	SK-1367
55844	0-N115
5584470	SK-1080
5584471	SK-1112
55844711	SK-1112AQ1
5584472	SK-1080
5584473	SK-1629
55844731	SK-1629AQ1
5584474	SK-1646
55844741	SK-1646AQ1
5584475	SK-1696
55844751	SK-1629AQ1
55844751	SK-1696AQ1
5584476	SK-1586
55844761	SK-1586AQ1
5584477	SK-1587
55844771	SK-1587AQ1
5584478	SK-1602
55844781	SK-1602AQ1
5584479	SK-1367
55845	0-N1652
55846	0-N1630
55847	0-N1415
55848	0-N1628
55849	0-N1403
55850	0-N194
5585070	SK-1410
55850701	SK-1410AQ1
5585071	SK-1415
5585072	SK-1365
5585072	SK-1697
55850721	SK-1697AQ1
55851	0-N938
55852	0-N195
5585270	SK-1412
55852701	SK-1412AQ2
55853	0-N196
5585370	SK-1411
5585371	SK-1637

RUVILLE

5585372	SK-1446
55856	0-N1634
55860	0-N187
55861	0-N1593
55861	0-N1593S
55862	0-N1599
55862	0-N1599S
55863	0-N1407
55863	0-N1407S
55864	0-N1672
55865	0-N1594
55866	0-N1595
55866	0-N1595S
55867	0-N1408
55868	0-N1404
55869	0-N1596
55870	0-N1517
55870	0-N1517S
55871	0-N1386
55872	0-N1487
55872	0-N1487S
55873	0-N1748
55874	0-N1450
55875	0-N1092
55876	0-N1093
55878	0-N1572
5587870	SK-1664
5587870	SK-1755AQ1
5587870	SK-1756
55879	0-N1490S
55880	0-N1483
55880	0-N1483S
55881	0-N1351
5588170	SK-1610
55881701	SK-1610AQ1
55882	0-N1352
55883	0-N1806
55884	0-N1597
55885	0-N1894
55887	0-N1394
55888	0-N1528
55888	0-N1528S
55889	0-N1399
55890	0-N1598
55891	0-N1481
55891	0-N1481S
55892	0-N1398
55893	0-N1627
55893	0-N1627S
55895	0-N1629

RUVILLE

55896	0-N1623
55897	0-N1720
55897	0-N1720S
55898	0-N1326
55899	0-N1478S
55901	0-N943
5590170	SK-1082
55901701	SK-1082AQ2
5590171	SK-1079
55902	0-N1973
55903	0-N2348
55904	0-N931
55906	0-N121
55907	0-N122
55908	0-N1749
55908	0-N1749S
55909	0-N095
55911	0-N1405
55912	0-N1751
55913	0-N1713
55914	0-N1722
55917	0-N2174
55918	0-N2337
55919	0-N1899
55920	0-N125
55920	0-N125S
55921	0-N118P
5592170	SK-1086
5592171	SK-1085
55921711	SK-1085AQ1
5592172	SK-1394
55921721	SK-1394AQ1
5592173	SK-1534
55921731	SK-1534AQ1
5592174	SK-1609
55921741	SK-1609AQ1
55922	0-N119P
55923	0-N215
55924	0-N214
5592470	SK-1087
55925	0-N1472
55925	0-N1472S
55926	0-N1750
55927	0-N2349
55928	0-N1747
55929	0-N1757
55930	0-N1473
55930	0-N1473S
55931	0-N2172
55931	0-N2172S

RUVILLE

55932	0-N2173
55933	0-N1756
55934	0-N1465S
55935	0-N1463S
55936	0-N1484
55936	0-N1484S
55937	0-N1402
55937	0-N1402S
55938	0-N1058
5593870	SK-1399
55938701	SK-1399AQ1
55939	0-N1413
55940	0-N1493
55940	0-N1493S
55941	0-N1309
55942	0-N1471
55942	0-N1471S
55943	0-N1061
5594370	SK-1392
55943701	SK-1392AQ1
55944	0-N1545
55945	0-N1624
55945	0-N1624S
55946	0-N1455
55947	0-N1681
55949	0-N1057
5594970	SK-1482
55949704	SK-1482AQ1
5594971	SK-1596
55950	0-N1065
55951	0-N1391
55951	0-N1391S
55952	0-N1416
55953	0-N1062
5595370	SK-1391
55953701	SK-1391AQ1
5595371	SK-1577
5595372	SK-1424
55953721	SK-1424AQ1
55954	0-N1066
55955	0-N1421
55956	0-N1387
55957	0-N2349
55958	0-N1277
5595870	SK-1353
55958701	SK-1353AQ1
5595871	SK-1354
55958711	SK-1354AQ1
55959	0-N1712
55960	0-N1486

RUVILLE		RUVILLE		RUVILLE		RUVILLE	
55960	0-N1486S	55990	0-N1808	56036	0-N115	56128	0-N2054
55961	0-N1446	55990	0-N1808S	5603670	SK-1693	56129	0-N1393
55962	0-N1419	55991	0-N1807	56036701	SK-1693AQ1	56130	0-N1514
55963	0-N1339	55992	0-N1924	5603671	SK-1586	56130	0-N1514S
55963	0-N1339S	55993	0-N2276	56036711	SK-1586AQ1	56131	0-N1256
55964	0-N1381	55994	0-N1840	5603673	SK-1112	56132	0-N1122
55965	0-N1060	55994	0-N1840S	56036731	SK-1112AQ1	56133	0-N1535
5596570	SK-1393	55995	0-N1959	5603674	SK-1080	56133	0-N1535S
55967	0-N1356	55996	0-N1803	5603675	SK-1629	56134	0-N1659
5596770	SK-1613	55997	0-N118P	5603676	SK-1646	56134	0-N1659S
55968	0-N1456	5599770	SK-1086	56036761	SK-1646AQ1	56135	0-N1643
55969	0-N1334	55997701	SK-1086AQ1	5603677	SK-1696	56135	0-N1643S
55970	0-N2094	5599771	SK-1085	56036771	SK-1696AQ1	56136	0-N1742
55971	0-N1357	55998	0-N2042	5603678	SK-1587	56136	0-N1742S
5597170	SK-1614	55998	0-N2042S	56036781	SK-1587AQ1	56137	0-N1272
55971701	SK-1614AQ1	55999	0-N2055	5603679	SK-1602	5613770	SK-1504
5597171	SK-1617	55999	0-N2055S	56038	0-N2150	56138	0-N1540
55971711	SK-1617AQ1	56000	0-N800	56042	0-N2390	56139	0-N1239
5597172	SK-1616	5600070	SK-1065	56042	0-N2390S	56140	0-N1121
55972	0-N1358	56001	0-N801	56101	0-N897	56141	0-N1735
55973	0-N1327	56003	0-N2412	56102	0-N899	56300	0-N1891
5597370	SK-1594	56007	0-N2413	56104	0-N894	56301	0-N1675
55973701	SK-1594AQ1	56010	0-N937	5610470	SK-1067	56302	0-N1656
55974	0-N1338	5601070	SK-1072	5610471	SK-1706	56302	0-N1656S
5597470	SK-1598	56011	0-N1517	56108	0-N898	56303	0-N1575
55974701	SK-1598AQ1	56011	0-N1517S	56109	0-N1243	56304	0-N2133
55975	0-N1651	56012	0-N1407	5610970	SK-1500	56305	0-N1432
55975	0-N1651S	56012	0-N1407S	56110	0-N237	56305	0-N1432S
55976	0-N1945	56014	0-N1503	56111	0-N236	56306	0-N1920
55976	0-N1945S	56014	0-N1503S	5611170	SK-1102	56307	0-N1704
55977	0-N1343	56015	0-N1616	56113	0-N892	56307	0-N1704S
5597770	SK-1600	5601570	SK-1677	56114	0-N928	56308	0-N2066
55977701	SK-1600AQ1	5601571	SK-1676	56116	0-N891	56310	0-N2134
55978	0-N1614	56016	0-N2093	56117	0-N1412	56313	0-N1890
5597870	SK-1742	56016	0-N2093S	56118	0-N1584	56313	0-N1890S
5597871	SK-1675	56018	0-N1841	56119	0-N1261	56314	0-N1605
55979	0-N1615	56019	0-N1842	5611970	SK-1502	56315	0-N1715
55980	0-N1556S	56019	0-N1842S	56120	0-N1248	56317	0-N1909
55981	0-N1673	56021	0-N1667	56121	0-N2277	56318	0-N1908
55981	0-N1673S	56022	0-N1805	56122	0-N1273	56318	0-N1908S
55982	0-N2095	56022	0-N1805S	56123	0-N968	56319	0-N1906
55982	0-N2095S	56023	0-N1711S	56124	0-N1857	56321	0-N1943
55983	0-N2095S1	56024	0-N1714	56124	0-N1857S	56323	0-N1928
55984	0-N1613	56024	0-N1714S	56125	0-N2053	56325	0-N2110
5598470	SK-1675	56025	0-N1976	56125	0-N2053S	56326	0-N2091
55987	0-N1636	56028	0-N2046	56126	0-N1809	56326	0-N2091S
55987	0-N1636S	56028	0-N2046S	56126	0-N1809S	56327	0-N2209
55988	0-N2175	56033	0-N2122	56127	0-N1120	56327	0-N2209S
55989	0-N1620	56034	0-N2149	5612770	SK-1501	56331	0-N2391
55989	0-N1620S	56035	0-N2049	5612771	SK-1552	56331	0-N2391S



RUVILLE

56333	0-N2350
56335	0-N1925
56338	0-N1915
56339	0-N1954
56339	0-N1954S
56340	0-N1905
5634070	SK-1694
56340701	SK-1694AQ1
56340702	SK-1694AQ1
56340702	SK-1694AQ2
56341	0-N1676
56341	0-N1676S
56342	0-N2047
56343	0-N2139
56345	0-N2199
56347	0-N2026
56347	0-N2026S
56349	0-N2061
5634970	SK-1695
5634970	SK-1727
56349701	SK-1695AQ1
56349702	SK-1695AQ1
56350	0-N2025
56352	0-N2287
56352	0-N2287S
56353	0-N2111
56353	0-N2111S
56354	0-N1053
56355	0-N2067
56356	0-N1956
56356	0-N1956S
56357	0-N2065
56357	0-N2065S
56358	0-N1918
56358	0-N1918S
56359	0-N2050
56360	0-N1830
56360	0-N1830S
56361	0-N2092
56361	0-N2092S
56364	0-N2195
5636471	SK-1726
56365	0-N2234
56368	0-N2208
5636870	SK-1724
56369	0-N2196
56370	0-N2288
56370	0-N2288S
56371	0-N2289
56371	0-N2289S

RUVILLE

56372	0-N2027
56373	0-N2417
56374	0-N2258
56375	0-N2064
56376	0-N2200
56377	0-N2121
56379	0-N1832
56379	0-N1832S
56380	0-N2351
56381	0-N2407
56381	0-N2407S
56383	0-N1316
56384	0-N2271
56385	0-N2313
56386	0-N2381
56390	0-N2314
56400	0-N1604
56401	0-N2181
56402	0-N1544
56403	0-N1430
56404	0-N1438
56404	0-N1438S
56405	0-N1410
56405	0-N1410S
56406	0-N1544
56407	0-N1544
56408	0-N2180
56409	0-N2029
56409	0-N2029S
56410	0-N1717
56410	0-N1717S
56411	0-N1461
56413	0-N1730
56414	0-N1429
56415	0-N1353
5641570	SK-1611
56416	0-N1355
56417	0-N1354
56418	0-N1633
56419	0-N1649
56500	0-N860
5650070	SK-1061
5650071	SK-1172
56501	0-N917
56503	0-N1231
56504	0-N162
56505	0-N960
56506	0-N1349
5650670	SK-1608
56508	0-N2315

RUVILLE

56510	0-N143
56511	0-N959
5651170	SK-1265
56512	0-N930
5651270	SK-1103
56512701	SK-1103AQ1
5651271	SK-1270
56512711	SK-1270AQ1
56514	0-N920
56515	0-N958
56516	0-N919
5651670	SK-1174
56517	0-N1232
56518	0-N172
56521	0-N1362
5652170	SK-1618
56522	0-N1350
56523	0-N1406
56524	0-N1953
56524	0-N1953S
56525	0-N1424
56526	0-N1448
56527	0-N1558S
56528	0-N1425
56529	0-N1382
56530	0-N2223
56533	0-N1451
56534	0-N1491S
56536	0-N1324
5653670	SK-1492
56536701	SK-1492AQ1
56536701	SK-1666AQ1
56537	0-N1554
56537	0-N1554S
56538	0-N2096
56538	0-N2096S
56539	0-N1639
56539	0-N1639S
56541	0-N1884
5654170	SK-1747
56542	0-N1573
5654270	SK-1666
56542701	SK-1492AQ1
56542701	SK-1666AQ1
56544	0-N1979
56544	0-N1979S
56546	0-N1964
56546	0-N1964S
56549	0-N2242
56549	0-N2242S

RUVILLE

56551	0-N2243
56553	0-N2190
56553	0-N2190S
56554	0-N2109
56554	0-N2109S
56557	0-N2353
56558	0-N2204
56558	0-N2204S
56560	0-N1349
5656070	SK-1608
56600	0-N811
5660070	SK-1003
56600701	SK-1003AQ1
5660071	SK-1020
56600711	SK-1020AQ1
5660072	SK-1004
56600721	SK-1004AQ1
56601	0-N125
56601	0-N125S
56602	0-N861
5660270	SK-1005
5660271	SK-1040
56602711	SK-1040AQ1
5660272	SK-1642
56603	0-N862
5660370	SK-1017
56603701	SK-1017AQ1
56604	0-N812
5660470	SK-1006
56606	0-N849
56607	0-N869
5660770	SK-1157
5660771	SK-1158
56609	0-N813
5660970	SK-1007
56609701	SK-1007AQ1
56610	0-N814
56611	0-N1682
56612	0-N931
56613	0-N815
5661370	SK-1018S
5661371	SK-1018S
56618	0-N870
5661870	SK-1159
56619	0-N2152
56620	0-N811
5662070	SK-1019
56621	0-N911
56622	0-N901
5662270	SK-1022

RUVILLE

56622701	SK-1022AQ2
56622704	SK-1022AQ1
56623	0-N871
5662370	SK-1016
56624	0-N133
56625	0-N900
56626	0-N124
56627	0-N2153
56628	0-N944
5662870	SK-1034
56630	0-N1320
56631	0-N945
56632	0-N1222
56635	0-N2154
56637	0-N2015
56638	0-N1359
5663870	SK-1615
56638701	SK-1615AQ1
56639	0-N1968
56640	0-N1949
56641	0-N1904
56641	0-N1975
56642	0-N1360
56643	0-N1056
5664350	SK-1483
5664370	SK-1483
56643702	SK-1483AQ1
56644	0-N170
56645	0-N171
56647	0-N2018
5664770	SK-1692
56647701	SK-1692AQ1
56648	0-N2019
56651	0-N2037
56651	0-N2037S
56652	0-N1874
56652	0-N1874S
56653	0-N2112
56653	0-N2112S
56654	0-N2048
56655	0-N2191
56658	0-N2063
5665870	SK-1714
56658701	SK-1714AQ1
56659	0-N2268
56659	0-N2268S
56660	0-N1617
56664	0-N2224
5666470	SK-1732
56664701	SK-1732AQ1

RUVILLE

5666471	SK-1728
56664711	SK-1728AQ1
56665	0-N2382
56667	0-N2392
56667	0-N2392S
56669	0-N2237
56670	0-N2294
56671	0-N2354
56678	0-N2424
56682	0-N2355
56719	0-N2295
56720	0-N2272
56721	0-N2291
56800	0-N094
56802	0-N021
5680270	SK-1202
5680271	SK-1203
56803	0-N032
56805	0-N025
56807	0-N030
5680770	SK-1205
5680771	SK-1475
56808	0-N031
56809	0-N029
56810	0-N028
5681070	SK-1068S
5681070	SK-1097
5681071	SK-1097
5681072	SK-1097
56812	0-N027
5681270	SK-1662
56813	0-N1755
56814	0-N033
56816	0-N024
56817	0-N022
56819	0-N1219
56820	0-N035
56821	0-N034
5682170	SK-1210
5682171	SK-1476
56822	0-N1220
56823	0-N1218
56825	0-N1732
56825	0-N1732S
56826	0-N2164
56827	0-N2165
56834	0-N2211
56834	0-N2211S
56837	0-N2089
56837	0-N2089S

RUVILLE

56839	0-N2240
56841	0-N2357
56842	0-N2043
56900	0-N999
5690070	SK-1192
5690071	SK-1075
56901	0-N992
5690170	SK-1186
56902	0-N991
56903	0-N995
5690370	SK-1062
56904	0-N996
56905	0-N005
5690570	SK-1188
5690570	SK-1195
56906	0-N006
56910	0-N1754
56912	0-N990
56913	0-N988
5691370	SK-1189
56914	0-N989
56915	0-N997
5691571	SK-1275
56916	0-N998
56917	0-N008
56918	0-N994
56920	0-N007
5692070	SK-1196
56921	0-N993
5692170	SK-1289
5692171	SK-1274
5692172	SK-1278
56924	0-N001
56925	0-N000
5692570	SK-1187
56928	0-N013
5692870	SK-1522
56929	0-N014
56931	0-N1810
56931	0-N1810S
56932	0-N1462
56932	0-N1462S
56934	0-N1549
56935	0-N2058
56936	0-N2319
56938	0-N1883
56938	0-N1883S
5693870	SK-1703
56939	0-N176
5693970	SK-1713

RUVILLE

5693971	SK-1521
56942	0-N1774
56943	0-N1329
56944	0-N2186
56946	0-N2320
56947	0-N1250
56948	0-N1618
5694870	SK-1682
56949	0-N1879
5694970	SK-1702
56950	0-N1773
56951	0-N1328
5695170	SK-1589
56951701	SK-1589AQ1
5695171	SK-1717
56951711	SK-1717AQ1
56955	0-N2301
56955	0-N2301S
56957	0-N2183
56957	0-N2183S
56958	0-N1877
56958	0-N1877S
56959	0-N1820
56960	0-N1482S
56961	0-N2184
56961	0-N2184S
56963	0-N2040
56964	0-N2051
56965	0-N2185
56966	0-N2032
56966	0-N2032S
56967	0-N1728
56968	0-N2189S
56969	0-N1819
56971	0-N1761
56974	0-N2187
56975	0-N2188
56975	0-N2188S
56977	0-N1878
56979	0-N2393
56979	0-N2393S
56980	0-N1880
56980	0-N1880S
56981	0-N1823
56983	0-N1983
56984	0-N1725
56985	0-N1724
56985	0-N2102
56986	0-N2107
56986	0-N2107S



RUVILLE

56987	0-N2198
56987	0-N2198S
56988	0-N2273
56990	0-N2098
56990	0-N2098S
56992	0-N2201
56993	0-N2192
56993	0-N2192S
56996	0-N2360
57002	0-N069
5700270	SK-1224
5700271	SK-1233
5700272	SK-1627
5700273	SK-1652
57003	0-N070
57004	0-N180
5700470	SK-1453
57005	0-N076
5700570	SK-1222
57006	0-N078
5700670	SK-1221
57007	0-N077
57008	0-N080
57009	0-N081
57010	0-N079
5701070	SK-1457
57011	0-N084
57013	0-N073
5701370	SK-1231
5701371	SK-1226
5701372	SK-1227
57014	0-N075
57015	0-N074
57016	0-N086
57017	0-N092
57019	0-N083
5701970	SK-1228
57020	0-N983
5702070	SK-1223
5702071	SK-1225
57021	0-N085
57022	0-N1824
57023	0-N071
57024	0-N072
57025	0-N082
57026	0-N1760
5702670	SK-1716
57027	0-N1375
57028	0-N1376
57029	0-N1550

RUVILLE

57030	0-N1467S
57031	0-N1389
57032	0-N1816
57033	0-N1825
57034	0-N1379
5703470	SK-1671
5703471	SK-1671
57034711	SK-1671AQ1
57035	0-N1578
57036	0-N1948
57037	0-N1216
57038	0-N1373
5703870	SK-1444
57040	0-N088
57041	0-N091
57042	0-N090
57044	0-N1380
57045	0-N2041
57046	0-N2024
57047	0-N1377
57048	0-N1778
57049	0-N1582
57050	0-N1581
57051	0-N1580
57052	0-N1579
57053	0-N1759
57054	0-N2383
57055	0-N087
57058	0-N1856
57058	0-N1856S
57059	0-N1855
57059	0-N1855S
57061	0-N1936
57064	0-N1378
5706470	SK-1674
5706471	SK-1674
57064711	SK-1674AQ1
5706472	SK-1678
5706473	SK-1678
57064731	SK-1678AQ1
57067	0-N2104
57067	0-N2104S
57069	0-N2159
57070	0-N2160
57071	0-N2034
57071	0-N2034S
57072	0-N2113
57072	0-N2113S
57073	0-N1859
57074	0-N2244

RUVILLE

57075	0-N1551
57075	0-N1551S
57078	0-N1858
57078	0-N1858S
57079	0-N2114
57079	0-N2114S
57080	0-N2035
57080	0-N2035S
57082	0-N2286
57083	0-N2394
57083	0-N2394S
57084	0-N2395
57084	0-N2395S
57100	0-N2266
57100	0-N2266S1
57100	0-N2266S2
57105	0-N2225
5710570	SK-1750
57106	0-N2396
57106	0-N2396S
57107	0-N2363
57108	0-N2269
57108	0-N2269S
57115	0-N2038
57115	0-N2038S
57118	0-N2057
57121	0-N2300
57121	0-N2300S
57122	0-N2303
57201	0-N912
5720170	SK-1185
57202	0-N1917
57203	0-N1911
5720370	SK-1715
57204	0-N1914
57205	0-N1450
57206	0-N2056
57207	0-N2044
57300	0-N986
5730070	SK-1242
57301	0-N987
5730170	SK-1234
57302	0-N053
5730270	SK-1309S
5730271	SK-1321
57303	0-N054
57305	0-N058
57306	0-N051
57307	0-N183
5730770	SK-1240

RUVILLE

57308	0-N065
5730870	SK-1463
57309	0-N179
5730970	SK-1310
57310	0-N059
5731070	SK-1240
5731070	SK-1240S
5731070 + 5731770	SK-1240
5731071	SK-1237
5731071	SK-1237S
5731071	SK-1312
57311	0-N188
57312	0-N182
5731270	SK-1316
57312701	SK-1316AQ1
5731271	SK-1458
57313	0-N061
5731370	SK-1236
5731371	SK-1306
57314	0-N184
57315	0-N060
5731570	SK-1323
5731571	SK-1313S
57316	0-N062
57317	0-N064
5731770	SK-1308
57318	0-N186
5731870	SK-1237
5731870 + 5731071	SK-1237
57319	0-N056
5731970	SK-1325
57320	0-N185
5732071	SK-1735
57321	0-N052
5732170	SK-1314
5732171	SK-1322
57322	0-N063
57323	0-N191
5732370	SK-1670
57324	0-N192
57325	0-N191
57326	0-N189
57327	0-N1127
5732770	SK-1469
5732771	SK-1653
57328	0-N181
57329	0-N1129
5732970	SK-1470
57330	0-N1971
57332	0-N2415

RUVILLE		RUVILLE		RUVILLE		RUVILLE	
57333	0-N2162	57421	0-N066	57519	0-N2419	57706	0-N1938
57335	0-N2163	57424	0-N2267	57521	0-N2422	57707	0-N1965
57337	0-N1521	57424	0-N2267S	57521	0-N2422S	57708	0-N2052
57342	0-N2105	57425	0-N1851	57523	0-N2241	57709	0-N1804
57342	0-N2105S	57425	0-N1851S	57523	0-N2241S	57709	0-N1804S
57343	0-N2161	57426	0-N1330	57524	0-N2402	57710	0-N2106
57343	0-N2161S	5742670	SK-1591	57524	0-N2402S	57711	0-N2228
5734370	SK-1736	5742671	SK-1590	57528	0-N2403	57712	0-N2322
5734370	SK-1737	57427	0-N1850	57528	0-N2403S	57714	0-N1876
57344	0-N2012	57427	0-N1850S	57529	0-N1641	57714	0-N1876S
57345	0-N1772	57428	0-N2398	57529	0-N1641S	57715	0-N2405
57346	0-N2364	57428	0-N2398S	57530	0-N2293	57715	0-N2405S
57347	0-N2397	57429	0-N1812	57530	0-N2293S	57720	0-N2106
57347	0-N2397S	57429	0-N1812S	57532	0-N2404	57721	0-N2239
57351	0-N2384	57430	0-N2103	57532	0-N2404S	57900	0-N037
57353	0-N2270	57430	0-N2103S	57533	0-N2306	57901	0-N043
57353	0-N2270S	57431	0-N2158	57533	0-N2306S	57903	0-N038
57354	0-N2365	57431	0-N2158S	57534	0-N2290	57904	0-N2323
57355	0-N2259	57432	0-N2123	57534	0-N2290S	57905	0-N039
57356	0-N1771	57433	0-N2033	57535	0-N2368	57906	0-N041
57357	0-N2255	57434	0-N2251	57600	0-N2369	57907	0-N040
57358	0-N2010	57434	0-N2251S1	57601	0-N2252	57908	0-N036
57360	0-N1984	57434	0-N2251S2	57601	0-N2252S	5790870	SK-1257
57400	0-N979	57435	0-N2207	57602	0-N2278	57909	0-N1562
5740070	SK-1070	57436	0-N2399	57604	0-N2370	5790970	SK-1658
5740071	SK-1436	57436	0-N2399S	57605	0-N2055S	57910	0-N1563
57401	0-N927	57440	0-N1852	57606	0-N2371	57911	0-N1764
5740170	SK-1066	57442	0-N2210	57607	0-N2216	5791170	SK-1690
5740171	SK-1211	57442	0-N2210S	57607	0-N2216S1	57912	0-N2229
5740172	SK-1213	57443	0-N2400	57607	0-N2216S2	57913	0-N2339
57403	0-N978	57443	0-N2400S	57608	0-N2372	58100	0-N1223
5740370	SK-1288	57500	0-N2083	57609	0-N2373	5810070	SK-1335
57403701	SK-1288AQ1	57500	0-N2083S	57611	0-N2215	58101	0-N1225
5740371	SK-1277	57501	0-N2238	57611	0-N2215S	58102	0-N1226
57403711	SK-1277AQ1	57502	0-N2205	57613	0-N2217	58106	0-N1071
57404	0-N926	57504	0-N2136	57613	0-N2217S1	58107	0-N1767
57406	0-N905	57504	0-N2136S	57613	0-N2217S2	5810771	SK-1712
5740670	SK-1220	57505	0-N2206	57700	0-N017	58107711	SK-1712AQ3
5740670 + 5740770	SK-1220	57506	0-N2226	5770070	SK-1327	5810773	SK-1721
5740671	SK-1430	57506	0-N2226S	57702	0-N018	5810775	SK-1719
57407	0-N178	57507	0-N2418	5770270	SK-1248	5810775	SK-1721
5740770	SK-1220	57508	0-N2401	5770272	SK-1250	58108	0-N1244
57410	0-N982	57508	0-N2401S1	57703	0-N020	58109	0-N1775
57411	0-N981	57508	0-N2401S2	5770370	SK-1246	58110	0-N1828
5741170	SK-1216	57512	0-N2367	57704	0-N916	58111	0-N2325
57414	0-N981	57513	0-N2312	5770470	SK-1564	58112	0-N1783
57415	0-N969	57514	0-N2296	5770471	SK-1245	58113	0-N1782
57416	0-N1781	57515	0-N2227	5770472	SK-1519	58114	0-N1829
57417	0-N193	57517	0-N2119	57705	0-N019	58115	0-N1777
57418	0-N068	57518	0-N2120	5770570	SK-1249	58116	0-N1776



RUVILLE		RUVILLE		RUVILLE		SKF	
58119	0-N2182	58435	0-N2021	59002	0-N970	VKM 11014	0-N104
58119	0-N2182S	58437	0-N1987	5900270	SK-1273	VKM 11015	0-N111
58122	0-N2230	58438	0-N2429	59002701	SK-1273AQ1	VKM 11018	0-N1050
58122	0-N2230S	58439	0-N2375	59002702	SK-1273AQ2	VKM 11020	0-N808
58123	0-N2374	58440	0-N1813	59003	0-N973	VKM 11021	0-N129
58260	0-N859	58440	0-N1813S	5900370	SK-1183	VKM 11043	0-N921
5826070	SK-1024	58441	0-N2247	59003701	SK-1183AQ1	VKM 11045	0-N1232
58400	0-N055	58441	0-N2247S	5900371	SK-1685	VKM 11050	0-N939
58401	0-N1374	58442	0-N2248	59003711	SK-1685AQ1	VKM 11054	0-N108
58402	0-N1561	58444	0-N2108	59004	0-N1532	VKM 11072	0-N109
5840270	SK-1656	58444	0-N2108S	59004	0-N1532S	VKM 11073	0-N110
5840271	SK-1440	58445	0-N2416	59005	0-N1646	VKM 11105	0-N105
58403	0-N975	58446	0-N1130	59007	0-N2420	VKM 11106	0-N106
5840370	SK-1320	58447	0-N2202	59008	0-N2421	VKM 11107	0-N1331
5840371	SK-1439	58447	0-N2202S	59010	0-N2194	VKM 11113	0-N157
5840372	SK-1634	58451	0-N2377	59010	0-N2194S	VKM 11114	0-N1258
58404	0-N1370	58458	0-N2214	59011	0-N2087	VKM 11115	0-N1654
58405	0-N1577	58458	0-N2214S	59011	0-N2087S	VKM 11116	0-N1042
58406	0-N1498	58601	0-N1835	59012	0-N2236	VKM 11117	0-N1051
5840670	SK-1653	58602	0-N2059	59014	0-N2254	VKM 11117	0-N1051S
58407	0-N1576	58603	0-N1555	59015	0-N2274	VKM 11120	0-N158
5840770	SK-1669	58603	0-N1555S	59500	0-N042	VKM 11121	0-N159
58407701	SK-1669AQ1	58604	0-N1836	59501	0-N047	VKM 11124	0-N1263
58408	0-N1499S	58607	0-N2327	59502	0-N046	VKM 11130	0-N107
5840870	SK-1654	58608	0-N1962	59503	0-N049	VKM 11142	0-N1048
58409	0-N1500	58609	0-N1546	5950370	SK-1260	VKM 11143	0-N1265
58410	0-N1366	58610	0-N1509	59504	0-N042	VKM 11145	0-N1274
5841070	SK-1626	58610	0-N1509S	59505	0-N050	VKM 11150	0-N1266
58414	0-N1815	58611	0-N1510	59506	0-N048	VKM 11151	0-N201
58414	0-N1815S	58611	0-N1510S	59507	0-N045	VKM 11154	0-N1364
58415	0-N1547	58612	0-N1612	59900	0-N2330	VKM 11170	0-N2195
58416	0-N1814	5861270	SK-1673	59901	0-N2126	VKM 11200	0-N940
58417	0-N1677	58613	0-N1411	59903	0-N2331	VKM 11201	0-N160
58417	0-N1677S	58615	0-N1423	59904	0-N1066	VKM 11202	0-N1238
58418	0-N1678	58616	0-N2203	59905	0-N2385	VKM 11204	0-N1568
58419	0-N1990	58616	0-N2203S	59906	0-N2386	VKM 11208	0-N1372
58422	0-N2250	58617	0-N2406	59908	0-N2378	VKM 11209	0-N1275
58422	0-N2250S	58617	0-N2406S	59909	0-N2379	VKM 11220	0-N1340
58424	0-N2326	58619	0-N1838S	59995	0-N1683	VKM 11221	0-N1817
58428	0-N1619	58623	0-N2232			VKM 11221	0-N1817S
5842870	SK-1684	58623	0-N2232S			VKM 11225	0-N2208
58429	0-N1552S	58624	0-N2233			VKM 11250	0-N1045
58429	0-N1553	58627	0-N1698			VKM 11251	0-N1444
58430	0-N1552	58627	0-N1698S			VKM 11255	0-N1335
58431	0-N1854	58628	0-N2329			VKM 11256	0-N1332
58432	0-N1499	5862870	SK-1734			VKM 11257	0-N116
5843270	SK-1654	58847	0-N144			VKM 11258	0-N117
58432702	SK-1654AQ2	59000	0-N974			VKM 11263	0-N1905
58433	0-N2231	5900070	SK-1184			VKM 11265	0-N1229
58433	0-N2231S	59001	0-N971			VKM 11266	0-N1230

SKF

17302	0-N236
SKF03124	0-N2189S
VKM 11000	0-N805
VKM 11001	0-N922
VKM 11003	0-N132
VKM 11007	0-N130
VKM 11008	0-N1236
VKM 11009	0-N1276
VKM 11010	0-N806
VKM 11012	0-N103

SKF		SKF		SKF		SKF	
VKM 11269	0-N2061	VKM 13241	0-N901	VKM 16002	0-N1112	VKM 18200	0-N912
VKM 11278	0-N2314	VKM 13244	0-N118P	VKM 16003	0-N145	VKM 18400	0-N1838S
VKM 11300	0-N1054	VKM 13246	0-N118P	VKM 16006	0-N1602	VKM 18502	0-N2329
VKM 11330	0-N1969	VKM 13250	0-N871	VKM 16009	0-N2062	VKM 18600	0-N1836
VKM 11331	0-N1978	VKM 13253	0-N1277	VKM 16020	0-N198	VKM 18601	0-N1612
VKM 11331	0-N1978S	VKM 13256	0-N1359	VKM 16021	0-N1368	VKM 21004	0-N131
VKM 11332	0-N1337	VKM 13257	0-N1327	VKM 16038	0-N1324	VKM 21012	0-N128
VKM 11338	0-N2313	VKM 13258	0-N1338	VKM 16040	0-N1573	VKM 21030	0-N807
VKM 12002	0-N2150	VKM 13261	0-N1613	VKM 16100	0-N856	VKM 21031	0-N807
VKM 12005	0-N823	VKM 13262	0-N1614	VKM 16101	0-N173	VKM 21032	0-N923
VKM 12010	0-N850	VKM 13263	0-N1343	VKM 16102	0-N1111	VKM 21041	0-N924
VKM 12101	0-N818	VKM 13264	0-N1357	VKM 16103	0-N1571	VKM 21045	0-N163
VKM 12150	0-N826	VKM 13300	0-N944	VKM 16110	0-N883	VKM 21052	0-N941
VKM 12151	0-N819	VKM 13301	0-N1222	VKM 16112	0-N880	VKM 21115	0-N1237
VKM 12153	0-N835	VKM 13304	0-N214	VKM 16113	0-N1173	VKM 21120	0-N1262
VKM 12172	0-N196	VKM 13305	0-N2018	VKM 16129	0-N1323	VKM 21121	0-N164
VKM 12173	0-N114	VKM 13316	0-N2224	VKM 16204	0-N882	VKM 21122	0-N165
VKM 12174	0-N115	VKM 13902	0-N1056	VKM 16212	0-N913	VKM 21130	0-N166
VKM 12182	0-N194	VKM 14000	0-N839	VKM 16220	0-N1349	VKM 21131	0-N167
VKM 12199	0-N115	VKM 14100	0-N874	VKM 16300	0-N860	VKM 21142	0-N1268
VKM 12200	0-N822	VKM 14101	0-N838	VKM 16400	0-N917	VKM 21147	0-N1046
VKM 12201	0-N195	VKM 14103	0-N915	VKM 16410	0-N162	VKM 21148	0-N2200
VKM 12206	0-N1616	VKM 14105	0-N985	VKM 16501	0-N112	VKM 21150	0-N168
VKM 12215	0-N113	VKM 14107	0-N089	VKM 16503	0-N1269	VKM 21151	0-N168
VKM 12227	0-N832	VKM 14108	0-N1367	VKM 16550	0-N200	VKM 21170	0-N2234
VKM 12242	0-N208	VKM 14201	0-N837	VKM 16551	0-N199	VKM 21201	0-N2000
VKM 12277	0-N1572	VKM 14204	0-N1246	VKM 16560	0-N1382	VKM 21202	0-N2001
VKM 12390	0-N1351	VKM 14210	0-N903	VKM 16600	0-N919	VKM 21203	0-N169
VKM 12400	0-N949	VKM 14211	0-N290	VKM 16602	0-N930	VKM 21220	0-N1316
VKM 12500	0-N800	VKM 14215	0-N2057	VKM 16604	0-N137	VKM 21223	0-N1346
VKM 12501	0-N801	VKM 14216	0-N1778	VKM 16612	0-N959	VKM 21256	0-N1336
VKM 12541	0-N1092	VKM 14220	0-N1260	VKM 16800	0-N1362	VKM 21259	0-N1575
VKM 12700	0-N859	VKM 14222	0-N294	VKM 16800	0-N1884	VKM 21269	0-N2025
VKM 13050	0-N815	VKM 14224	0-N1564	VKM 17000	0-N897	VKM 21280	0-N2381
VKM 13100	0-N811	VKM 14301	0-N842	VKM 17110	0-N898	VKM 21302	0-N1053
VKM 13120	0-N861	VKM 15121	0-N948	VKM 17110	0-N899	VKM 22151	0-N820
VKM 13130	0-N121	VKM 15140	0-N1369	VKM 17112	0-N236	VKM 22153	0-N889
VKM 13132	0-N1061	VKM 15202	0-N100	VKM 17301	0-N1272	VKM 22174	0-N950
VKM 13140	0-N1062	VKM 15210	0-N879	VKM 17303	0-N1120	VKM 22177	0-N938
VKM 13200	0-N812	VKM 15211	0-N877	VKM 17304	0-N1273	VKM 22179	0-N1326
VKM 13201	0-N811	VKM 15213	0-N910	VKM 17305	0-N1121	VKM 22180	0-N1326
VKM 13202	0-N943	VKM 15215	0-N126	VKM 17307	0-N1261	VKM 22242	0-N951
VKM 13205	0-N2063	VKM 15216	0-N102	VKM 17308	0-N1243	VKM 22380	0-N821
VKM 13210	0-N869	VKM 15218	0-N1085	VKM 17310	0-N894	VKM 22385	0-N816
VKM 13211	0-N911	VKM 15220	0-N1353	VKM 17402	0-N891	VKM 22390	0-N1352
VKM 13214	0-N1058	VKM 15230	0-N1383	VKM 17406	0-N968	VKM 22510	0-N937
VKM 13220	0-N870	VKM 15260	0-N1347	VKM 18000	0-N954	VKM 22540	0-N1093
VKM 13231	0-N1060	VKM 15402	0-N101	VKM 18001	0-N955	VKM 23120	0-N862
VKM 13234	0-N1057	VKM 15500	0-N956	VKM 18100	0-N809	VKM 23121	0-N2382
VKM 13240	0-N813	VKM 16000	0-N863	VKM 18120	0-N925	VKM 23122	0-N1381



SKF		SKF		SKF		SKF	
VKM 23130	0-N122	VKM 26102	0-N881	VKM 31018	0-N1606	VKM 31116	0-N2111S
VKM 23140	0-N1066	VKM 26105	0-N1365	VKM 31018	0-N1606S	VKM 31125	0-N2092
VKM 23213	0-N862	VKM 26115	0-N148	VKM 31019	0-N1494	VKM 31125	0-N2092S
VKM 23214	0-N862	VKM 26123	0-N146	VKM 31019	0-N1494S	VKM 31150	0-N1906
VKM 23218	0-N862	VKM 26125	0-N147	VKM 31022	0-N1530	VKM 31207	0-N1310
VKM 23230	0-N1065	VKM 26128	0-N1106	VKM 31022	0-N1530S	VKM 31210	0-N1660
VKM 23240	0-N814	VKM 26211	0-N857	VKM 31023	0-N1459	VKM 31211	0-N1928
VKM 23241	0-N900	VKM 26220	0-N1350	VKM 31023	0-N1459S	VKM 31218	0-N1537
VKM 23246	0-N119P	VKM 26310	0-N1259	VKM 31025	0-N1675	VKM 31218	0-N1537S
VKM 23256	0-N1360	VKM 26402	0-N960	VKM 31030	0-N1609	VKM 31220	0-N1908
VKM 23257	0-N1334	VKM 26500	0-N964	VKM 31033	0-N1822	VKM 31220	0-N1908S
VKM 23258	0-N1456	VKM 26501	0-N965	VKM 31033	0-N1822S	VKM 31221	0-N1909
VKM 23261	0-N1615	VKM 26502	0-N277	VKM 31034	0-N1432	VKM 31223	0-N1656
VKM 23264	0-N1358	VKM 26503	0-N1270	VKM 31035	0-N1704	VKM 31223	0-N1656S
VKM 23300	0-N945	VKM 26600	0-N920	VKM 31035	0-N1704S	VKM 31230	0-N2017
VKM 23304	0-N215	VKM 26602	0-N958	VKM 31038	0-N1315	VKM 31230	0-N2017S
VKM 23305	0-N2424	VKM 26610	0-N958	VKM 31039	0-N1308	VKM 31240	0-N1893
VKM 23900	0-N170	VKM 26612	0-N172	VKM 31040	0-N1005	VKM 31240	0-N1893S
VKM 23901	0-N171	VKM 27110	0-N898	VKM 31041	0-N1431	VKM 31250	0-N1600
VKM 24100	0-N902	VKM 27110	0-N899	VKM 31042	0-N1525	VKM 31280	0-N2350
VKM 24104	0-N1214	VKM 27112	0-N237	VKM 31042	0-N1525S	VKM 31303	0-N1795
VKM 24107	0-N123	VKM 27302	0-N237	VKM 31043	0-N1312	VKM 31310	0-N2026
VKM 24210	0-N904	VKM 27303	0-N1122	VKM 31046	0-N2064	VKM 31310	0-N2026S
VKM 24211	0-N096	VKM 27307	0-N1248	VKM 31047	0-N1733	VKM 31315	0-N2027
VKM 24212	0-N292	VKM 27404	0-N892	VKM 31047	0-N1733S	VKM 31321	0-N1740
VKM 24213	0-N291	VKM 28000	0-N866	VKM 31048	0-N2066	VKM 32001	0-N1403
VKM 24214	0-N293	VKM 28001	0-N867	VKM 31054	0-N1531	VKM 32002	0-N1966
VKM 25124	0-N2236	VKM 28400	0-N1962	VKM 31054	0-N1531S	VKM 32004	0-N1652
VKM 25142	0-N1574	VKM 28600	0-N1835	VKM 31057	0-N1536	VKM 32005	0-N1630
VKM 25150	0-N952	VKM 28601	0-N1411	VKM 31057	0-N1536S	VKM 32006	0-N1415
VKM 25152	0-N953	VKM 31001	0-N1662	VKM 31058	0-N1534	VKM 32007	0-N1628
VKM 25156	0-N300	VKM 31002	0-N174	VKM 31058	0-N1534S	VKM 32009	0-N187
VKM 25158	0-N953	VKM 31004	0-N1417	VKM 31059	0-N1317	VKM 32011	0-N1634
VKM 25201	0-N875	VKM 31005	0-N1891	VKM 31059	0-N1317S	VKM 32012	0-N1593
VKM 25202	0-N909	VKM 31006	0-N1671	VKM 31060	0-N1657	VKM 32012	0-N1593S
VKM 25207	0-N878	VKM 31006	0-N1671S	VKM 31060	0-N1657S	VKM 32015	0-N1599
VKM 25211	0-N876	VKM 31007	0-N1311	VKM 31061	0-N1083	VKM 32015	0-N1599S
VKM 25212	0-N906	VKM 31008	0-N1738	VKM 31061	0-N1083S	VKM 32016	0-N1629
VKM 25213	0-N907	VKM 31010	0-N1414	VKM 31063	0-N1800	VKM 32017	0-N2156
VKM 25215	0-N878	VKM 31011	0-N1041	VKM 31064	0-N1313	VKM 32018	0-N1894
VKM 25216	0-N878	VKM 31011	0-N1041S	VKM 31065	0-N1715	VKM 32022	0-N1407
VKM 25222	0-N1354	VKM 31012	0-N1538	VKM 31066	0-N2391	VKM 32022	0-N1407S
VKM 25224	0-N127	VKM 31012	0-N1538S	VKM 31066	0-N2391S	VKM 32023	0-N1517
VKM 25226	0-N1355	VKM 31013	0-N1441	VKM 31070	0-N2209	VKM 32023	0-N1517S
VKM 25312	0-N300	VKM 31013	0-N1441S	VKM 31070	0-N2209S	VKM 32024	0-N1404
VKM 25500	0-N957	VKM 31013	0-N2047	VKM 31085	0-N1956	VKM 32025	0-N1490S
VKM 25701	0-N1960	VKM 31015	0-N1445	VKM 31098	0-N2050	VKM 32026	0-N2117
VKM 26020	0-N262	VKM 31015	0-N1445S	VKM 31099	0-N2091	VKM 32026	0-N2117S
VKM 26100	0-N887	VKM 31016	0-N1539	VKM 31099	0-N2091S	VKM 32027	0-N1487
VKM 26101	0-N854	VKM 31016	0-N1539S	VKM 31116	0-N2111	VKM 32027	0-N1487S

SKF		SKF		SKF		SKF	
VKM 32030	0-N1408	VKM 33022	0-N1713	VKM 33077	0-N1757	VKM 34010	0-N1435
VKM 32031	0-N1399	VKM 33023	0-N1446	VKM 33082	0-N1712	VKM 34010	0-N1435S
VKM 32033	0-N1481	VKM 33024	0-N1748	VKM 33083	0-N2172	VKM 34012	0-N1653S
VKM 32033	0-N1481S	VKM 33025	0-N1722	VKM 33083	0-N2172S	VKM 34013	0-N197
VKM 32034	0-N1398	VKM 33026	0-N1402	VKM 33084	0-N2173	VKM 34014	0-N1639
VKM 32035	0-N1598	VKM 33026	0-N1402S	VKM 33086	0-N2154	VKM 34014	0-N1639S
VKM 32036	0-N1596	VKM 33027	0-N1465S	VKM 33090	0-N1682	VKM 34018	0-N1433
VKM 32046	0-N1503	VKM 33028	0-N1484	VKM 33100	0-N1419	VKM 34018	0-N1433S
VKM 32046	0-N1503S	VKM 33028	0-N1484S	VKM 33101	0-N1620	VKM 34019	0-N1434
VKM 32048	0-N1522	VKM 33029	0-N1472	VKM 33101	0-N1620S	VKM 34023	0-N1429
VKM 32049	0-N1667	VKM 33029	0-N1472S	VKM 33111	0-N2392	VKM 34025	0-N1390
VKM 32050	0-N1720	VKM 33031	0-N1309	VKM 33111	0-N2392S	VKM 34025	0-N1390S
VKM 32050	0-N1720S	VKM 33032	0-N1471	VKM 33125	0-N1750	VKM 34027	0-N1588
VKM 32051	0-N1627	VKM 33032	0-N1471S	VKM 33131	0-N1807	VKM 34027	0-N1588S
VKM 32051	0-N1627S	VKM 33033	0-N1493	VKM 33132	0-N1924	VKM 34030	0-N1392
VKM 32080	0-N1478S	VKM 33033	0-N1493S	VKM 33161	0-N1808	VKM 34031	0-N1428
VKM 32082	0-N1595	VKM 33034	0-N1405	VKM 33161	0-N1808S	VKM 34032	0-N1477
VKM 32082	0-N1595S	VKM 33035	0-N1463S	VKM 33164	0-N1502	VKM 34032	0-N1477S
VKM 32083	0-N1594	VKM 33037	0-N1486	VKM 33164	0-N1502S	VKM 34033	0-N1443
VKM 32091	0-N1386	VKM 33037	0-N1486S	VKM 33175	0-N2175	VKM 34033	0-N1443S
VKM 32104	0-N1976	VKM 33038	0-N2174	VKM 33205	0-N2396	VKM 34034	0-N1385
VKM 32105	0-N2093	VKM 33039	0-N2015	VKM 33205	0-N2396S	VKM 34040	0-N1519
VKM 32105	0-N2093S	VKM 33040	0-N1756	VKM 33309	0-N2095	VKM 34040	0-N1519S
VKM 32154	0-N1672	VKM 33041	0-N1904	VKM 33309	0-N2095S	VKM 34042	0-N1896
VKM 32184	0-N1394	VKM 33041	0-N1975	VKM 33311	0-N1747	VKM 34042	0-N1896S
VKM 32202	0-N1528	VKM 33042	0-N1455	VKM 33313	0-N1711S	VKM 34043	0-N1895
VKM 32202	0-N1528S	VKM 33043	0-N1339	VKM 33314	0-N1421	VKM 34043	0-N1895S
VKM 32242	0-N187	VKM 33043	0-N1339S	VKM 33320	0-N2037	VKM 34044	0-N2266
VKM 32243	0-N1450	VKM 33044	0-N1418	VKM 33320	0-N2037S	VKM 34044	0-N2266S1
VKM 33002	0-N931	VKM 33045	0-N1413	VKM 33325	0-N2037	VKM 34044	0-N2266S2
VKM 33003	0-N124	VKM 33046	0-N2276	VKM 33325	0-N2037S	VKM 34046	0-N1557S
VKM 33004	0-N1681	VKM 33047	0-N2115	VKM 33400	0-N2055	VKM 34047	0-N1845
VKM 33006	0-N2349	VKM 33047	0-N2115S	VKM 33400	0-N2055S	VKM 34047	0-N1845S
VKM 33007	0-N2153	VKM 33050	0-N1945	VKM 33406	0-N2042	VKM 34048	0-N1642
VKM 33008	0-N1751	VKM 33050	0-N1945S	VKM 33406	0-N2042S	VKM 34050	0-N1991
VKM 33009	0-N133	VKM 33060	0-N1420	VKM 33407	0-N2019	VKM 34051	0-N1702
VKM 33010	0-N849	VKM 33061	0-N1636	VKM 34002	0-N155	VKM 34052	0-N1497
VKM 33012	0-N125	VKM 33061	0-N1636S	VKM 34003	0-N156	VKM 34052	0-N1497S
VKM 33012	0-N125S	VKM 33063	0-N1556S	VKM 34004	0-N1400	VKM 34054	0-N2028
VKM 33013	0-N1320	VKM 33064	0-N2094	VKM 34004	0-N1400S	VKM 34056	0-N1533S
VKM 33014	0-N1899	VKM 33065	0-N1651	VKM 34005	0-N1501	VKM 34061	0-N1401
VKM 33015	0-N095	VKM 33065	0-N1651S	VKM 34005	0-N1501S	VKM 34071	0-N1719
VKM 33016	0-N1749	VKM 33069	0-N151	VKM 34006	0-N2022	VKM 34071	0-N1719S
VKM 33016	0-N1749S	VKM 33073	0-N1624	VKM 34006	0-N2022S	VKM 34072	0-N1665
VKM 33017	0-N1545	VKM 33073	0-N1624S	VKM 34007	0-N1897	VKM 34102	0-N1942
VKM 33018	0-N1949	VKM 33074	0-N1673	VKM 34007	0-N1897S	VKM 34105	0-N1716
VKM 33019	0-N1391	VKM 33074	0-N1673S	VKM 34008	0-N1903	VKM 34107	0-N1458
VKM 33019	0-N1391S	VKM 33075	0-N1449	VKM 34008	0-N1903S	VKM 34108	0-N1610
VKM 33020	0-N1416	VKM 33076	0-N1473	VKM 34009	0-N1796	VKM 34110	0-N1709
VKM 33021	0-N1968	VKM 33076	0-N1473S	VKM 34009	0-N1796S	VKM 34110	0-N1709S1



SKF		SKF		SKF		SKF	
VKM 34110	0-N1709S2	VKM 35025	0-N1426	VKM 36038	0-N1409	VKM 36238	0-N1554S
VKM 34111	0-N1622	VKM 35041	0-N2194	VKM 36040	0-N1409	VKM 36240	0-N1529S
VKM 34113	0-N2155	VKM 35041	0-N2194S	VKM 36041	0-N1731	VKM 36241	0-N1964
VKM 34113	0-N2155S	VKM 35212	0-N1461	VKM 36041	0-N1731S	VKM 36241	0-N1964S
VKM 34115	0-N2269	VKM 35214	0-N1649	VKM 36052	0-N1474	VKM 36242	0-N2242
VKM 34115	0-N2269S	VKM 35216	0-N1717	VKM 36053	0-N1898	VKM 36242	0-N2242S
VKM 34120	0-N1963	VKM 35216	0-N1717S	VKM 36053	0-N1898S	VKM 36243	0-N2243
VKM 34200	0-N1797	VKM 35260	0-N1799	VKM 36055	0-N1664	VKM 36250	0-N1647
VKM 34200	0-N1797S	VKM 35260	0-N1799S	VKM 36055	0-N1664S	VKM 36500	0-N1424
VKM 34219	0-N2303	VKM 35311	0-N1798	VKM 36056	0-N1743	VKM 36530	0-N1953
VKM 34231	0-N2353	VKM 35311	0-N1798S	VKM 36058	0-N1476	VKM 36530	0-N1953S
VKM 34460	0-N1957	VKM 35330	0-N2087	VKM 36058	0-N1476S	VKM 37002	0-N1540
VKM 34460	0-N1957S	VKM 35330	0-N2087S	VKM 36061	0-N1736	VKM 37005	0-N1535
VKM 34500	0-N1604	VKM 35332	0-N2221	VKM 36064	0-N1650	VKM 37005	0-N1535S
VKM 34501	0-N1430	VKM 35351	0-N2421	VKM 36069	0-N1802	VKM 37010	0-N1643
VKM 34502	0-N1544	VKM 35500	0-N1438	VKM 36069	0-N1802S	VKM 37010	0-N1643S
VKM 34503	0-N1544	VKM 35500	0-N1438S	VKM 36070	0-N1475S	VKM 37011	0-N1659
VKM 34504	0-N2029	VKM 35603	0-N2030	VKM 36071	0-N1875	VKM 37011	0-N1659S
VKM 34504	0-N2029S	VKM 35603	0-N2030S	VKM 36071	0-N1875S	VKM 37014	0-N1412
VKM 34510	0-N1410	VKM 36001	0-N144	VKM 36072	0-N1427	VKM 37015	0-N1584
VKM 34510	0-N1410S	VKM 36003	0-N143	VKM 36072	0-N1427S	VKM 37020	0-N1742
VKM 34700	0-N2014	VKM 36004	0-N135	VKM 36079	0-N2253	VKM 37020	0-N1742S
VKM 34700	0-N2014S	VKM 36005	0-N150	VKM 36080	0-N1635	VKM 37032	0-N1393
VKM 34701	0-N1460	VKM 36006	0-N139	VKM 36081	0-N1721	VKM 37040	0-N2281
VKM 34702	0-N2038	VKM 36007	0-N134	VKM 36082	0-N1626	VKM 37040	0-N2281S
VKM 34702	0-N2038S	VKM 36008	0-N2016	VKM 36082	0-N1626S	VKM 37050	0-N1514
VKM 34704	0-N1661	VKM 36010	0-N149	VKM 36086	0-N2039	VKM 37050	0-N1514S
VKM 35002	0-N1439	VKM 36011	0-N2013	VKM 36086	0-N2039S	VKM 37420	0-N1857
VKM 35006	0-N2299	VKM 36013	0-N138	VKM 36087	0-N1739	VKM 37420	0-N1857S
VKM 35006	0-N2299S	VKM 36014	0-N141	VKM 36091	0-N1314	VKM 38001	0-N846
VKM 35007	0-N1485	VKM 36016	0-N1729	VKM 36111	0-N2279	VKM 38002	0-N1452
VKM 35007	0-N1485S	VKM 36017	0-N1591	VKM 36111	0-N2279S	VKM 38003	0-N1298
VKM 35008	0-N1322	VKM 36018	0-N152	VKM 36120	0-N1518	VKM 38004	0-N1301
VKM 35008	0-N1322S	VKM 36018	0-N152S	VKM 36120	0-N1518S	VKM 38007	0-N1293
VKM 35009	0-N1422	VKM 36019	0-N1752	VKM 36120	0-N1529	VKM 38008	0-N1758
VKM 35009	0-N1422S	VKM 36020	0-N1663	VKM 36122	0-N1425	VKM 38010	0-N1946
VKM 35011	0-N1464	VKM 36020	0-N1663S	VKM 36124	0-N1558S	VKM 38010	0-N1946S1
VKM 35011	0-N1464S	VKM 36022	0-N1590	VKM 36136	0-N2280	VKM 38010	0-N1946S2
VKM 35012	0-N1466	VKM 36023	0-N1589	VKM 36136	0-N2280S	VKM 38011	0-N1974
VKM 35012	0-N1466S	VKM 36024	0-N2179	VKM 36138	0-N2308	VKM 38012	0-N847
VKM 35013	0-N2170	VKM 36025	0-N1592	VKM 36138	0-N2308S	VKM 38020	0-N1641
VKM 35013	0-N2170S	VKM 36026	0-N1488	VKM 36146	0-N2290	VKM 38020	0-N1641S
VKM 35015	0-N1495S	VKM 36026	0-N1488S	VKM 36146	0-N2290S	VKM 38022	0-N1703
VKM 35016	0-N1437	VKM 36028	0-N2178	VKM 36201	0-N2265	VKM 38023	0-N1489S
VKM 35017	0-N2283	VKM 36030	0-N1611	VKM 36201	0-N2265S	VKM 38026	0-N1645
VKM 35022	0-N2341	VKM 36030	0-N1611S	VKM 36221	0-N2275	VKM 38026	0-N1645S
VKM 35023	0-N1526	VKM 36031	0-N1307	VKM 36230	0-N1451	VKM 38027	0-N1833
VKM 35023	0-N1526S	VKM 36032	0-N1470	VKM 36236	0-N2096	VKM 38045	0-N1011
VKM 35024	0-N2389	VKM 36032	0-N1470S	VKM 36236	0-N2096S	VKM 38045	0-N1011S
VKM 35024	0-N2389S	VKM 36035	0-N1469	VKM 36238	0-N1554	VKM 38053	0-N2120

SKF		SKF		SKF		SKF	
VKM 38062	0-N1637	VKM 38238	0-N1834	VKM 60003	0-N2197	VKM 62022	0-N2240
VKM 38065	0-N2148	VKM 38238	0-N1834S	VKM 60003	0-N2197S	VKM 62025	0-N1869
VKM 38066	0-N1442	VKM 38240	0-N1396	VKM 60004	0-N2171	VKM 62025	0-N1869S
VKM 38070	0-N1902	VKM 38241	0-N1523	VKM 60011	0-N2097	VKM 62028	0-N2089
VKM 38070	0-N1902S	VKM 38250	0-N1788	VKM 60012	0-N2274	VKM 62028	0-N2089S
VKM 38072	0-N1587	VKM 38250	0-N1788S	VKM 60014	0-N1532	VKM 62052	0-N2285
VKM 38072	0-N1587S	VKM 38251	0-N2128	VKM 60014	0-N1532S	VKM 63000	0-N2100
VKM 38073	0-N1457	VKM 38264	0-N2284	VKM 61000	0-N1725	VKM 63000	0-N2102
VKM 38075	0-N2219	VKM 38266	0-N2368	VKM 61013	0-N1810	VKM 63001	0-N2101
VKM 38075	0-N2219S	VKM 38300	0-N1453	VKM 61013	0-N1810S	VKM 63001	0-N2102
VKM 38076	0-N2132	VKM 38304	0-N1790	VKM 61014	0-N1462	VKM 63002	0-N1852
VKM 38077	0-N1670	VKM 38306	0-N2216	VKM 61014	0-N1462S	VKM 63003	0-N2102
VKM 38077	0-N1670S	VKM 38306	0-N2216S1	VKM 61015	0-N1982	VKM 63004	0-N1850
VKM 38079	0-N2138	VKM 38306	0-N2216S2	VKM 61016	0-N1482S	VKM 63004	0-N1850S
VKM 38088	0-N2218	VKM 38311	0-N2369	VKM 61017	0-N2040	VKM 63005	0-N1812
VKM 38089	0-N2193	VKM 38334	0-N2075	VKM 61019	0-N2098	VKM 63005	0-N1812S
VKM 38089	0-N2193S	VKM 38335	0-N2084	VKM 61019	0-N2098S	VKM 63006	0-N2033
VKM 38100	0-N1282	VKM 38335	0-N2084S	VKM 61020	0-N1880	VKM 63008	0-N2398
VKM 38123	0-N1388	VKM 38336	0-N1950	VKM 61020	0-N1880S	VKM 63008	0-N2398S
VKM 38125	0-N2238	VKM 38339	0-N1958	VKM 61021	0-N2051	VKM 63010	0-N2103
VKM 38127	0-N2205	VKM 38339	0-N1958S	VKM 61024	0-N2032	VKM 63010	0-N2103S
VKM 38130	0-N1395	VKM 38343	0-N2031	VKM 61024	0-N2032S	VKM 63018	0-N1851
VKM 38131	0-N1397	VKM 38343	0-N2031S	VKM 61025	0-N1728	VKM 63018	0-N1851S
VKM 38131	0-N2419	VKM 38351	0-N1922	VKM 61026	0-N2187	VKM 63019	0-N2158
VKM 38132	0-N1723	VKM 38353	0-N2217	VKM 61027	0-N2186	VKM 63019	0-N2158S
VKM 38201	0-N2140	VKM 38353	0-N2217S1	VKM 61029	0-N1877	VKM 63022	0-N2399
VKM 38202	0-N1290	VKM 38353	0-N2217S2	VKM 61029	0-N1877S	VKM 63022	0-N2399S
VKM 38202	0-N1290S	VKM 38523	0-N2404	VKM 61032	0-N1878	VKM 63027	0-N2400
VKM 38203	0-N1640	VKM 38523	0-N2404S	VKM 61038	0-N2304	VKM 63027	0-N2400S
VKM 38204	0-N1741	VKM 38600	0-N1423	VKM 61042	0-N2107	VKM 63029	0-N2267
VKM 38204	0-N1741S	VKM 38603	0-N1680	VKM 61042	0-N2107S	VKM 63029	0-N2267S
VKM 38205	0-N1447S	VKM 38611	0-N2406	VKM 61044	0-N2192	VKM 64002	0-N1858
VKM 38208	0-N1900	VKM 38611	0-N2406S	VKM 61044	0-N2192S	VKM 64002	0-N1858S
VKM 38209	0-N1621	VKM 38700	0-N1492	VKM 61052	0-N2184	VKM 64003	0-N1859
VKM 38209	0-N1621S	VKM 38700	0-N1492S	VKM 61052	0-N2184S	VKM 64004	0-N2113
VKM 38212	0-N1793	VKM 38705	0-N1786	VKM 61065	0-N2088	VKM 64004	0-N2113S
VKM 38212	0-N1793S	VKM 38706	0-N2124	VKM 61065	0-N2088S	VKM 64005	0-N2244
VKM 38214	0-N1871	VKM 38706	0-N2124S	VKM 61070	0-N2301	VKM 64010	0-N1813
VKM 38220	0-N1304	VKM 38868	0-N2246	VKM 61070	0-N2301S	VKM 64010	0-N1813S
VKM 38221	0-N1294	VKM 38868	0-N2246S1	VKM 61078	0-N2185	VKM 64010	0-N2214
VKM 38221	0-N1294S	VKM 38868	0-N2246S2	VKM 61087	0-N2198	VKM 64010	0-N2214S
VKM 38224	0-N1923	VKM 38868	0-N2246S3	VKM 61087	0-N2198S	VKM 64011	0-N1552
VKM 38225	0-N1305	VKM 38869	0-N2245	VKM 61099	0-N2393	VKM 64011	0-N1552S
VKM 38226	0-N1292	VKM 38869	0-N2245S1	VKM 61099	0-N2393S	VKM 64012	0-N1553
VKM 38230	0-N1306	VKM 38869	0-N2245S2	VKM 62002	0-N2211	VKM 64016	0-N1988
VKM 38231	0-N1291	VKM 38869	0-N2245S3	VKM 62002	0-N2211S	VKM 64017	0-N1551
VKM 38231	0-N1291S	VKM 38908	0-N1926	VKM 62010	0-N2099	VKM 64017	0-N1551S
VKM 38236	0-N1794	VKM 38914	0-N2403	VKM 62013	0-N2282	VKM 64018	0-N2375
VKM 38236	0-N1794S	VKM 38914	0-N2403S	VKM 62016	0-N1732	VKM 64019	0-N1987
VKM 38237	0-N1505S	VKM 60001	0-N1646	VKM 62021	0-N2164	VKM 64025	0-N2104



SKF		SKF		SKF		SKF	
VKM 64025	0-N2104S	VKM 66008	0-N2023	VKM 72200	0-N021	VKM 75001	0-N987
VKM 64035	0-N1811	VKM 66009	0-N2106	VKM 72300	0-N025	VKM 75002	0-N052
VKM 64035	0-N1811S	VKM 66018	0-N2405	VKM 72303	0-N027	VKM 75004	0-N064
VKM 64037	0-N2114	VKM 66018	0-N2405S	VKM 72310	0-N028	VKM 75005	0-N062
VKM 64037	0-N2114S	VKM 66020	0-N1804	VKM 72320	0-N030	VKM 75006	0-N975
VKM 64040	0-N2034	VKM 66020	0-N1804S	VKM 72400	0-N094	VKM 75008	0-N186
VKM 64040	0-N2034S	VKM 66021	0-N2052	VKM 72500	0-N034	VKM 75009	0-N056
VKM 64041	0-N2429	VKM 66024	0-N2106	VKM 73000	0-N927	VKM 75033	0-N059
VKM 64052	0-N2035	VKM 67000	0-N1983	VKM 73001	0-N928	VKM 75044	0-N179
VKM 64052	0-N2035S	VKM 67001	0-N2229	VKM 73002	0-N982	VKM 75054	0-N065
VKM 64056	0-N2202	VKM 67002	0-N2339	VKM 73003	0-N066	VKM 75064	0-N060
VKM 64056	0-N2202S	VKM 67005	0-N2273	VKM 73004	0-N969	VKM 75100	0-N986
VKM 64062	0-N2394	VKM 68001	0-N1724	VKM 73005	0-N978	VKM 75101	0-N051
VKM 64062	0-N2394S	VKM 68001	0-N2102	VKM 73006	0-N068	VKM 75108	0-N053
VKM 64071	0-N2248	VKM 68002	0-N2182	VKM 73007	0-N193	VKM 75113	0-N183
VKM 64112	0-N1667	VKM 68002	0-N2182S	VKM 73009	0-N067	VKM 75119	0-N188
VKM 65004	0-N1521	VKM 68006	0-N2374	VKM 73011	0-N178	VKM 75130	0-N063
VKM 65009	0-N2105	VKM 70000	0-N970	VKM 73101	0-N926	VKM 75144	0-N054
VKM 65009	0-N2105S	VKM 70001	0-N974	VKM 73112	0-N1781	VKM 75601	0-N061
VKM 65010	0-N1984	VKM 70001	0-N988	VKM 73200	0-N981	VKM 75612	0-N184
VKM 65011	0-N1854	VKM 71000	0-N1754	VKM 73201	0-N979	VKM 75613	0-N1127
VKM 65014	0-N1677	VKM 71001	0-N988	VKM 73600	0-N905	VKM 75614	0-N191
VKM 65014	0-N1677S	VKM 71002	0-N013	VKM 73607	0-N1330	VKM 75615	0-N181
VKM 65015	0-N1678	VKM 71003	0-N992	VKM 74000	0-N079	VKM 75616	0-N182
VKM 65016	0-N2036	VKM 71004	0-N993	VKM 74001	0-N072	VKM 75621	0-N1366
VKM 65018	0-N1814	VKM 71006	0-N000	VKM 74002	0-N078	VKM 75624	0-N1827
VKM 65019	0-N1547	VKM 71007	0-N999	VKM 74004	0-N092	VKM 75625	0-N1129
VKM 65027	0-N1815	VKM 71010	0-N1549	VKM 74006	0-N076	VKM 75625	0-N181
VKM 65027	0-N1815S	VKM 71014	0-N176	VKM 74007	0-N085	VKM 75628	0-N1499
VKM 65038	0-N2021	VKM 71100	0-N995	VKM 74008	0-N180	VKM 75629	0-N1561
VKM 65039	0-N2108	VKM 71101	0-N990	VKM 74200	0-N983	VKM 75630	0-N1576
VKM 65039	0-N2108S	VKM 71201	0-N005	VKM 74201	0-N069	VKM 75633	0-N1498
VKM 65044	0-N1866	VKM 71202	0-N997	VKM 74300	0-N082	VKM 75634	0-N1762
VKM 65045	0-N1521	VKM 71302	0-N001	VKM 74310	0-N083	VKM 75636	0-N1619
VKM 65048	0-N2259	VKM 71303	0-N1328	VKM 74501	0-N071	VKM 75641	0-N2428
VKM 65051	0-N2270	VKM 71304	0-N1761	VKM 74502	0-N1373	VKM 75643	0-N1583
VKM 65051	0-N2270S	VKM 71308	0-N1823	VKM 74503	0-N1579	VKM 75644	0-N1971
VKM 65054	0-N2048	VKM 71400	0-N007	VKM 74504	0-N1580	VKM 75675	0-N1771
VKM 65055	0-N2112	VKM 71401	0-N998	VKM 74505	0-N1826	VKM 75676	0-N2161
VKM 65055	0-N2112S	VKM 71701	0-N1879	VKM 74506	0-N1581	VKM 75676	0-N2161S
VKM 65060	0-N2397	VKM 71704	0-N2320	VKM 74600	0-N073	VKM 75677	0-N2010
VKM 65060	0-N2397S	VKM 71706	0-N1618	VKM 74601	0-N1825	VKM 75678	0-N2012
VKM 65061	0-N2364	VKM 71806	0-N1883	VKM 74602	0-N1379	VKM 75685	0-N2326
VKM 65072	0-N2231	VKM 71806	0-N1883S	VKM 74604	0-N2225	VKM 75686	0-N2416
VKM 65072	0-N2231S	VKM 71808	0-N1774	VKM 74606	0-N1824	VKM 76001	0-N916
VKM 66000	0-N2239	VKM 71809	0-N1819	VKM 74607	0-N1378	VKM 76102	0-N973
VKM 66004	0-N2118	VKM 71812	0-N1820	VKM 74608	0-N1759	VKM 76103	0-N017
VKM 66005	0-N1876	VKM 72000	0-N032	VKM 74609	0-N1760	VKM 76200	0-N020
VKM 66005	0-N1876S	VKM 72004	0-N024	VKM 74616	0-N1936	VKM 76202	0-N018
VKM 66006	0-N1938	VKM 72100	0-N022	VKM 75000	0-N185	VKM 76203	0-N019

SKF		SKF		SKF		SKF	
VKM 76204	0-N2322	VKM 84601	0-N075	VKMA 01034	SK-1127	VKMA 01335	SK-1720
VKM 77001	0-N039	VKM 84602	0-N1816	VKMA 01040	SK-1129	VKMA 01908	SK-1638
VKM 77003	0-N041	VKM 84603	0-N1578	VKMA 01044	SK-1570	VKMA 01909	SK-1688
VKM 77100	0-N037	VKM 84604	0-N1380	VKMA 01046	SK-1527	VKMA 01927	SK-1386
VKM 77300	0-N038	VKM 84608	0-N1377	VKMA 01050	SK-1130	VKMA 01935	SK-1337
VKM 77500	0-N036	VKM 84610	0-N1666	VKMA 01105	SK-1344	VKMA 01936	SK-1660
VKM 77501	0-N043	VKM 85000	0-N055	VKMA 01106	SK-1131	VKMA 01940	SK-1604
VKM 77503	0-N1764	VKM 85002	0-N189	VKMA 01107	SK-1592	VKMA 01941	SK-1378
VKM 77504	0-N1562	VKM 85140	0-N058	VKMA 01110	SK-1074	VKMA 01942	SK-1583
VKM 78000	0-N1223	VKM 85141	0-N192	VKMA 01113	SK-1109	VKMA 01943	SK-1378
VKM 78005	0-N1767	VKM 85145	0-N1370	VKMA 01114	SK-1635	VKMA 01952	SK-1621
VKM 78103	0-N1071	VKM 85146	0-N1500	VKMA 01120	SK-1585	VKMA 01952	SK-1633
VKM 78105	0-N1244	VKM 85148	0-N1577	VKMA 01121	SK-1511	VKMA 02005	SK-1445
VKM 79000	0-N045	VKM 85150	0-N1763	VKMA 01122	SK-1511	VKMA 02111	SK-1138
VKM 79001	0-N042	VKM 85151	0-N1130	VKMA 01130	SK-1110	VKMA 02151	SK-1140
VKM 79002	0-N049	VKM 85152	0-N2255	VKMA 01131	SK-1111	VKMA 02152	SK-1032
VKM 79003	0-N048	VKM 85153	0-N1374	VKMA 01135	SK-1337	VKMA 02153	SK-1141
VKM 79006	0-N1765	VKM 85156	0-N1772	VKMA 01135	SK-1709	VKMA 02154	SK-1033
VKM 80000	0-N971	VKM 87000	0-N040	VKMA 01136	SK-1660	VKMA 02155	SK-1142
VKM 81000	0-N994	VKM 88000	0-N1225	VKMA 01136	SK-1710	VKMA 02168	SK-1143
VKM 81001	0-N989	VKM 88001	0-N1226	VKMA 01140	SK-1603	VKMA 02169	SK-1144
VKM 81002	0-N014	VKM 88004	0-N1775	VKMA 01141	SK-1388	VKMA 02171	SK-1080
VKM 81004	0-N991	VKM 88007	0-N1777	VKMA 01142	SK-1582	VKMA 02172	SK-1411
VKM 81005	0-N2058	VKM 88008	0-N1776	VKMA 01143	SK-1388	VKMA 02174	SK-1646
VKM 81100	0-N996	VKM 89001	0-N046	VKMA 01148	SK-1727	VKMA 02176	SK-1112
VKM 81201	0-N006	VKM 89002	0-N047	VKMA 01151	SK-1375	VKMA 02177	SK-1361
VKM 81204	0-N1329	VKM 89003	0-N050	VKMA 01152	SK-1619	VKMA 02178	SK-1446
VKM 81400	0-N008	VKM11144	0-N1049	VKMA 01170	SK-1726	VKMA 02179	SK-1629
VKM 81401	0-N1773	VKMA 01000	SK-1026	VKMA 01200	SK-1343	VKMA 02181	SK-1365
VKM 82000	0-N1218	VKMA 01001	SK-1119	VKMA 01201	SK-1376	VKMA 02181	SK-1697
VKM 82001	0-N1220	VKMA 01002	SK-1120	VKMA 01202	SK-1383	VKMA 02183	SK-1410
VKM 82300	0-N033	VKMA 01003	SK-1261	VKMA 01220	SK-1599	VKMA 02184	SK-1415
VKM 82302	0-N029	VKMA 01006	SK-1101	VKMA 01224	SK-1606	VKMA 02185	SK-1637
VKM 82320	0-N031	VKMA 01007	SK-1641	VKMA 01225	SK-1724	VKMA 02186	SK-1639
VKM 82500	0-N035	VKMA 01008	SK-1346	VKMA 01244	SK-1686	VKMA 02190	SK-1602
VKM 82501	0-N1219	VKMA 01009	SK-1090	VKMA 01250	SK-1372	VKMA 02191	SK-1367
VKM 84000	0-N077	VKMA 01010	SK-1001	VKMA 01251	SK-1258	VKMA 02193	SK-1586
VKM 84001	0-N080	VKMA 01011	SK-1029	VKMA 01255	SK-1595	VKMA 02193	SK-1587
VKM 84002	0-N081	VKMA 01012	SK-1069	VKMA 01256	SK-1593	VKMA 02194	SK-1587
VKM 84003	0-N090	VKMA 01013	SK-1122	VKMA 01258	SK-1529	VKMA 02195	SK-1587
VKM 84004	0-N091	VKMA 01014	SK-1098	VKMA 01259	SK-1668	VKMA 02196	SK-1586
VKM 84005	0-N088	VKMA 01015	SK-1512	VKMA 01263	SK-1694	VKMA 02197	SK-1602
VKM 84007	0-N086	VKMA 01016	SK-1106	VKMA 01265	SK-1539	VKMA 02198	SK-1080
VKM 84201	0-N070	VKMA 01018	SK-1640	VKMA 01266	SK-1578	VKMA 02199	SK-1693
VKM 84310	0-N084	VKMA 01019	SK-1425	VKMA 01269	SK-1695	VKMA 02200	SK-1023
VKM 84502	0-N1582	VKMA 01020	SK-1047	VKMA 01270	SK-1526	VKMA 02201	SK-1043
VKM 84503	0-N1376	VKMA 01021	SK-1123	VKMA 01271	SK-1648	VKMA 02202	SK-1665
VKM 84504	0-N1375	VKMA 01023	SK-1124	VKMA 01275	SK-1259	VKMA 02203	SK-1418
VKM 84506	0-N1550	VKMA 01024	SK-1104	VKMA 01301	SK-1538	VKMA 02204	SK-1412
VKM 84600	0-N074	VKMA 01032	SK-1126	VKMA 01332	SK-1597	VKMA 02206	SK-1677



SKF		SKF		SKF		SKF	
VKMA 02209	SK-1676	VKMA 03246	SK-1085	VKMA 05150	SK-1073	VKMA 06116	SK-1108S
VKMA 02210	SK-1421	VKMA 03247	SK-1085	VKMA 05152	SK-1113	VKMA 06117	SK-1622
VKMA 02215	SK-1345	VKMA 03248	SK-1534	VKMA 05154	SK-1355	VKMA 06118	SK-1663
VKMA 02222	SK-1150	VKMA 03250	SK-1016	VKMA 05156	SK-1355	VKMA 06122	SK-1089
VKMA 02224	SK-1050	VKMA 03251	SK-1017	VKMA 05193	SK-1586	VKMA 06123	SK-1099
VKMA 02227	SK-1151	VKMA 03252	SK-1394	VKMA 05200	SK-1056	VKMA 06125	SK-1084
VKMA 02242	SK-1076	VKMA 03253	SK-1353	VKMA 05201	SK-1037	VKMA 06126	SK-1108
VKMA 02277	SK-1755	VKMA 03254	SK-1354	VKMA 05202	SK-1038	VKMA 06127	SK-1493
VKMA 02283	SK-1756	VKMA 03255	SK-1609	VKMA 05208	SK-1054	VKMA 06128	SK-1620
VKMA 02381	SK-1657	VKMA 03256	SK-1615	VKMA 05211	SK-1163	VKMA 06129	SK-1580
VKMA 02382	SK-1045	VKMA 03257	SK-1594	VKMA 05213	SK-1164	VKMA 06130	SK-1487
VKMA 02383	SK-1035	VKMA 03258	SK-1598	VKMA 05214	SK-1168	VKMA 06134	SK-1487
VKMA 02384	SK-1046	VKMA 03259	SK-1424	VKMA 05220	SK-1165	VKMA 06137	SK-1490
VKMA 02386	SK-1153	VKMA 03260	SK-1482	VKMA 05222	SK-1100	VKMA 06204	SK-1092
VKMA 02390	SK-1610	VKMA 03260	SK-1596	VKMA 05223	SK-1166	VKMA 06205	SK-1091
VKMA 02410	SK-1031	VKMA 03261	SK-1675	VKMA 05224	SK-1478	VKMA 06212	SK-1093
VKMA 02422	SK-1154	VKMA 03263	SK-1600	VKMA 05228	SK-1644	VKMA 06213	SK-1063
VKMA 02450	SK-1155	VKMA 03264	SK-1614	VKMA 05230	SK-1611	VKMA 06214	SK-1014
VKMA 02501	SK-1065	VKMA 03265	SK-1616	VKMA 05240	SK-1586	VKMA 06220	SK-1608
VKMA 02510	SK-1072	VKMA 03266	SK-1609	VKMA 05260	SK-1607	VKMA 06300	SK-1061
VKMA 02700	SK-1024	VKMA 03266	SK-1617	VKMA 05402	SK-1169	VKMA 06301	SK-1172
VKMA 02983	SK-1680	VKMA 03300	SK-1034	VKMA 05500	SK-1508	VKMA 06500	SK-1645
VKMA 02986	SK-1681	VKMA 03304	SK-1087	VKMA 05606	SK-1479	VKMA 06501	SK-1096
VKMA 03050	SK-1018S	VKMA 03305	SK-1692	VKMA 05608	SK-1481	VKMA 06502	SK-1095
VKMA 03100	SK-1003	VKMA 03314	SK-1732	VKMA 05609	SK-1481	VKMA 06503	SK-1489
VKMA 03110	SK-1004	VKMA 03316	SK-1728	VKMA 05700	SK-1612	VKMA 06560	SK-1643
VKMA 03111	SK-1020	VKMA 03902	SK-1483	VKMA 05702	SK-1481	VKMA 06600	SK-1174
VKMA 03120	SK-1005	VKMA 04000	SK-1160	VKMA 06000	SK-1021	VKMA 06601	SK-1573
VKMA 03121	SK-1040	VKMA 04101	SK-1039	VKMA 06002	SK-1486	VKMA 06602	SK-1103
VKMA 03122	SK-1642	VKMA 04103	SK-1041	VKMA 06003	SK-1338	VKMA 06603	SK-1270
VKMA 03132	SK-1392	VKMA 04106	SK-1042	VKMA 06008	SK-1698	VKMA 06604	SK-1491
VKMA 03140	SK-1391	VKMA 04107	SK-1078	VKMA 06010	SK-1081	VKMA 06605	SK-1531
VKMA 03141	SK-1577	VKMA 04108	SK-1341	VKMA 06021	SK-1630	VKMA 06610	SK-1265
VKMA 03200	SK-1006	VKMA 04201	SK-1027	VKMA 06023	SK-1630	VKMA 06800	SK-1618
VKMA 03201	SK-1019	VKMA 04202	SK-1053	VKMA 06038	SK-1492	VKMA 07100	SK-1176
VKMA 03202	SK-1079	VKMA 04212	SK-1094	VKMA 06040	SK-1666	VKMA 07301	SK-1504
VKMA 03205	SK-1714	VKMA 04213	SK-1339	VKMA 06100	SK-1010	VKMA 07302	SK-1102
VKMA 03210	SK-1157	VKMA 04214	SK-1340	VKMA 06101	SK-1011	VKMA 07303	SK-1501
VKMA 03211	SK-1158	VKMA 04216	SK-1748	VKMA 06103	SK-1036	VKMA 07304	SK-1552
VKMA 03213	SK-1082	VKMA 04220	SK-1105	VKMA 06104	SK-1623	VKMA 07306	SK-1507
VKMA 03214	SK-1399	VKMA 04222	SK-1077	VKMA 06106	SK-1624	VKMA 07307	SK-1502
VKMA 03216	SK-1399	VKMA 04223	SK-1754	VKMA 06107	SK-1494	VKMA 07310	SK-1067
VKMA 03218	SK-1613	VKMA 04224	SK-1659	VKMA 06108	SK-1631	VKMA 07312	SK-1706
VKMA 03220	SK-1159	VKMA 04226	SK-1659	VKMA 06109	SK-1625	VKMA 07405	SK-1533
VKMA 03231	SK-1393	VKMA 04301	SK-1052	VKMA 06110	SK-1015	VKMA 07406	SK-1450
VKMA 03235	SK-1482	VKMA 04304	SK-1049	VKMA 06111	SK-1012	VKMA 08000	SK-1059
VKMA 03235	SK-1596	VKMA 04305	SK-1351	VKMA 06112	SK-1171	VKMA 08001	SK-1060
VKMA 03240	SK-1007	VKMA 05121	SK-1162	VKMA 06113	SK-1013	VKMA 08120	SK-1064
VKMA 03241	SK-1022	VKMA 05140	SK-1632	VKMA 06114	SK-1107	VKMA 08201	SK-1185
VKMA 03244	SK-1086	VKMA 05142	SK-1667	VKMA 06115	SK-1114	VKMA 08400	SK-1700

SKF

VKMA 08500	SK-1699
VKMA 08501	SK-1673
VKMA 08502	SK-1734
VKMA 1001	SK-1119
VKMA 1003	SK-1261
VKMA 1020	SK-1047
VKMA 1021	SK-1123
VKMA 1024	SK-1104
VKMA 1032	SK-1126
VKMA 1034	SK-1127
VKMA 1040	SK-1129
VKMA 1050	SK-1130
VKMA 1105	SK-1344
VKMA 2005	SK-1445
VKMA 2111	SK-1138
VKMA 2153	SK-1141
VKMA 2155	SK-1142
VKMA 2168	SK-1143
VKMA 2170	SK-1145S
VKMA 2215	SK-1345
VKMA 2222	SK-1150
VKMA 2224	SK-1050
VKMA 2227	SK-1151
VKMA 2384	SK-1045
VKMA 2422	SK-1154
VKMA 2430	SK-1264
VKMA 2450	SK-1155
VKMA 2501	SK-1065
VKMA 2510	SK-1072
VKMA 2700	SK-1024
VKMA 3050	SK-1018S
VKMA 3120	SK-1005
VKMA 3200	SK-1006
VKMA 3202	SK-1079
VKMA 3210	SK-1157
VKMA 3211	SK-1158
VKMA 3220	SK-1159
VKMA 3250	SK-1016
VKMA 3251	SK-1017
VKMA 4000	SK-1160
VKMA 4301	SK-1052
VKMA 4302	SK-1049
VKMA 5200	SK-1056
VKMA 5201	SK-1037
VKMA 5211	SK-1163
VKMA 6100	SK-1010
VKMA 6110	SK-1015
VKMA 6112	SK-1171
VKMA 6122	SK-1089
VKMA 6212	SK-1093

SKF

VKMA 6300	SK-1061
VKMA 6301	SK-1172
VKMA 6500	SK-1095
VKMA 6500	SK-1645
VKMA 6600	SK-1174
VKMA 6612	SK-1265
VKMA 7100	SK-1176
VKMA 8000	SK-1059
VKMA 8120	SK-1064
VKMA 8201	SK-1185
VKMA 90000	SK-1273
VKMA 90001	SK-1183
VKMA 90002	SK-1184
VKMA 90008	SK-1685
VKMA 91001	SK-1274
VKMA 91002	SK-1275
VKMA 91003	SK-1186
VKMA 91005	SK-1192
VKMA 91006	SK-1075
VKMA 91011	SK-1289
VKMA 91013	SK-1187
VKMA 91014	SK-1278
VKMA 91015	SK-1190
VKMA 91022	SK-1521
VKMA 91100	SK-1062
VKMA 91122	SK-1189
VKMA 91124	SK-1522
VKMA 91201	SK-1188
VKMA 91202	SK-1650
VKMA 91205	SK-1195
VKMA 91303	SK-1589
VKMA 91400	SK-1196
VKMA 91401	SK-1197
VKMA 91702	SK-1275
VKMA 91704	SK-1702
VKMA 91707	SK-1703
VKMA 91708	SK-1752
VKMA 91711	SK-1713
VKMA 91713	SK-1682
VKMA 91720	SK-1062
VKMA 91903	SK-1717
VKMA 92006	SK-1285
VKMA 92012	SK-1205
VKMA 92200	SK-1202
VKMA 92210	SK-1203
VKMA 92310	SK-1662
VKMA 92401	SK-1207
VKMA 92411	SK-1286
VKMA 92500	SK-1210
VKMA 92513	SK-1068

SKF

VKMA 92513	SK-1068S
VKMA 92516	SK-1097
VKMA 92518	SK-1476
VKMA 92519	SK-1475
VKMA 93001	SK-1211
VKMA 93002	SK-1213
VKMA 93005	SK-1288
VKMA 93006	SK-1277
VKMA 93009	SK-1301
VKMA 93011	SK-1430
VKMA 93013	SK-1218
VKMA 93200	SK-1216
VKMA 93201	SK-1070
VKMA 93210	SK-1436
VKMA 93302	SK-1217
VKMA 93500	SK-1066
VKMA 93600	SK-1220
VKMA 93615	SK-1591
VKMA 93616	SK-1590
VKMA 94000	SK-1457
VKMA 94007	SK-1219
VKMA 94009	SK-1302
VKMA 94010	SK-1221
VKMA 94012	SK-1222
VKMA 94014	SK-1453
VKMA 94101	SK-1223
VKMA 94102	SK-1225
VKMA 94201	SK-1224
VKMA 94222	SK-1226
VKMA 94230	SK-1227
VKMA 94310	SK-1228
VKMA 94506	SK-1444
VKMA 94507	SK-1672
VKMA 94509	SK-1716
VKMA 94601	SK-1231
VKMA 94608	SK-1232
VKMA 94609	SK-1233
VKMA 94610	SK-1627
VKMA 94612	SK-1671
VKMA 94614	SK-1751
VKMA 94616	SK-1750
VKMA 94619	SK-1674
VKMA 94620	SK-1678
VKMA 94624	SK-1652
VKMA 95003	SK-1308
VKMA 95008	SK-1309S
VKMA 95010	SK-1236
VKMA 95012	SK-1234
VKMA 95013	SK-1310
VKMA 95014	SK-1306

SKF

VKMA 95015	SK-1237
VKMA 95015	SK-1237S
VKMA 95016	SK-1311
VKMA 95017	SK-1312
VKMA 95019	SK-1323
VKMA 95020	SK-1314
VKMA 95023	SK-1463
VKMA 95024	SK-1313S
VKMA 95025	SK-1322
VKMA 95030	SK-1320
VKMA 95031	SK-1321
VKMA 95036	SK-1240
VKMA 95103	SK-1240S
VKMA 95206	SK-1242
VKMA 95206	SK-1317
VKMA 95621	SK-1460
VKMA 95623	SK-1316
VKMA 95624	SK-1325
VKMA 95626	SK-1458
VKMA 95627	SK-1469
VKMA 95628	SK-1670
VKMA 95632	SK-1634
VKMA 95641	SK-1626
VKMA 95648	SK-1439
VKMA 95650	SK-1460
VKMA 95650	SK-1753
VKMA 95651	SK-1470
VKMA 95656	SK-1656
VKMA 95657	SK-1669
VKMA 95658	SK-1653
VKMA 95660	SK-1654
VKMA 95667	SK-1684
VKMA 95675	SK-1744
VKMA 95676	SK-1736
VKMA 95679	SK-1735
VKMA 95681	SK-1739
VKMA 95957	SK-1749
VKMA 95958	SK-1746
VKMA 95975	SK-1745
VKMA 95976	SK-1737
VKMA 95981	SK-1740
VKMA 96000	SK-1327
VKMA 96002	SK-1245
VKMA 96200	SK-1246
VKMA 96202	SK-1248
VKMA 96203	SK-1249
VKMA 96204	SK-1250
VKMA 96213	SK-1566
VKMA 96214	SK-1564
VKMA 96218	SK-1519



SKF		SKF		SKF		SKF	
VKMA 97300	SK-1255	VKMC 01952	SK-1621AQ1	VKMC 03251	SK-1017AQ1	VKMC 06020	SK-1088AQ1
VKMA 97501	SK-1407	VKMC 01952	SK-1633AQ1	VKMC 03252	SK-1394AQ1	VKMC 06021	SK-1630AQ1
VKMA 97503	SK-1257	VKMC 01952-1	SK-1621AQ1	VKMC 03253	SK-1353AQ1	VKMC 06038	SK-1492AQ1
VKMA 97505	SK-1690	VKMC 02174	SK-1646AQ1	VKMC 03254	SK-1354AQ1	VKMC 06040	SK-1666AQ1
VKMA 97506	SK-1658	VKMC 02176	SK-1112AQ1	VKMC 03256	SK-1615AQ1	VKMC 06106	SK-1624AQ1
VKMA 98000	SK-1335	VKMC 02177	SK-1361AQ1	VKMC 03257	SK-1594AQ1	VKMC 06127	SK-1493AQ1
VKMA 98109	SK-1712	VKMC 02183	SK-1410AQ1	VKMC 03258	SK-1598AQ1	VKMC 06129	SK-1580AQ1
VKMA 98114	SK-1719	VKMC 02190	SK-1602AQ1	VKMC 03259	SK-1424AQ1	VKMC 06134-1	SK-1487AQ1
VKMA 98115	SK-1721	VKMC 02190-2	SK-1602AQ1	VKMC 03260	SK-1596AQ1	VKMC 06134-3	SK-1487AQ3
VKMA 99004	SK-1260	VKMC 02191	SK-1367AQ1	VKMC 03263	SK-1600AQ1	VKMC 06220	SK-1608AQ1
VKMC 01032	SK-1126AQ1	VKMC 02191-2	SK-1367AQ1	VKMC 03264	SK-1394AQ1	VKMC 06415	SK-1021AQ2
VKMC 01040	SK-1129AQ1	VKMC 02192	SK-1629AQ1	VKMC 03264	SK-1614AQ1	VKMC 06602	SK-1103AQ1
VKMC 01103	R-1190AQ1	VKMC 02193	SK-1586AQ1	VKMC 03266	SK-1609AQ1	VKMC 06603	SK-1270AQ1
VKMC 01106-1	SK-1131AQ2	VKMC 02193-2	SK-1586AQ1	VKMC 03266	SK-1617AQ1	VKMC 06604	SK-1491AQ1
VKMC 01106-2	SK-1131AQ1	VKMC 02194	SK-1696AQ1	VKMC 03305	SK-1692AQ1	VKMC 07306	SK-1507AQ1
VKMC 01107	SK-1592AQ1	VKMC 02195	SK-1587AQ1	VKMC 03314	SK-1732AQ1	VKMC 07312	SK-1706AQ1
VKMC 01108	SK-1344AQ1	VKMC 02195-2	SK-1587AQ1	VKMC 03316	SK-1728AQ1	VKMC 90000	SK-1273AQ1
VKMC 01110	SK-1074AQ1	VKMC 02196	SK-1586AQ1	VKMC 03902-2	SK-1483AQ1	VKMC 90001	SK-1183AQ1
VKMC 01113-1	SK-1109AQ1	VKMC 02196-2	SK-1586AQ1	VKMC 04106-1	SK-1042AQ1	VKMC 90008	SK-1685AQ1
VKMC 01113-2	SK-1109AQ2	VKMC 02197	SK-1602AQ1	VKMC 04106-2	SK-1042AQ2	VKMC 90202	SK-1162AQ3
VKMC 01114	SK-1635AQ1	VKMC 02197-2	SK-1602AQ1	VKMC 04106-4	SK-1042AQ3	VKMC 90402	SK-1273AQ2
VKMC 01121-1	SK-1511AQ1	VKMC 02198	SK-1646AQ1	VKMC 04107-1	SK-1078AQ1	VKMC 91303	SK-1589AQ1
VKMC 01121-2	SK-1511AQ2	VKMC 02199	SK-1693AQ1	VKMC 04107-2	SK-1078AQ2	VKMC 91303-2	SK-1589AQ2
VKMC 01122	SK-1511AQ1	VKMC 02199-2	SK-1693AQ1	VKMC 04107-3	SK-1078AQ3	VKMC 91903-2	SK-1717AQ2
VKMC 01131	SK-1111AQ1	VKMC 02202	SK-1665AQ2	VKMC 04212	SK-1094AQ1	VKMC 93005-2	SK-1288AQ1
VKMC 01220	SK-1599AQ1	VKMC 02203	SK-1418AQ1	VKMC 05121	SK-1162AQ1	VKMC 93006	SK-1277AQ1
VKMC 01222	SK-1724AQ1	VKMC 02206	SK-1677AQ1	VKMC 05140	SK-1632AQ1	VKMC 93006	SK-1277AQ2
VKMC 01222-1	SK-1724AQ2	VKMC 02209	SK-1676AQ1	VKMC 05142	SK-1667AQ1	VKMC 93011	SK-1430AQ1
VKMC 01225	SK-1724AQ1	VKMC 02210	SK-1421AQ1	VKMC 05150	SK-1073AQ2	VKMC 93210	SK-1436AQ1
VKMC 01244	SK-1686AQ1	VKMC 02210-1	SK-1421AQ1	VKMC 05150-1	SK-1073AQ2	VKMC 93616	SK-1590AQ1
VKMC 01250-1	SK-1372AQ2	VKMC 02210-2	SK-1421AQ1	VKMC 05150-2	SK-1073AQ3	VKMC 94912	SK-1671AQ1
VKMC 01250-2	SK-1372AQ1	VKMC 02212	SK-1733AQ1	VKMC 05150-3	SK-1073AQ1	VKMC 94919-1	SK-1674AQ1
VKMC 01250-3	SK-1372AQ1	VKMC 02277	SK-1755AQ1	VKMC 05152-1	SK-1113AQ1	VKMC 94920-1	SK-1678AQ1
VKMC 01250-4	SK-1372AQ3	VKMC 02390	SK-1610AQ1	VKMC 05152-2	SK-1113AQ2	VKMC 95624	SK-1325AQ1
VKMC 01251	SK-1258AQ1	VKMC 03100	SK-1003AQ1	VKMC 05156-1	SK-1355AQ3	VKMC 95632	SK-1634AQ1
VKMC 01253	SK-1380AQ1	VKMC 03110-1	SK-1004AQ1	VKMC 05156-2	SK-1355AQ2	VKMC 95660-1	SK-1654AQ1
VKMC 01255-1	SK-1595AQ1	VKMC 03111	SK-1020AQ1	VKMC 05156-3	SK-1355AQ1	VKMC 95660-2	SK-1654AQ1
VKMC 01259-1	SK-1668AQ1	VKMC 03121	SK-1040AQ1	VKMC 05201	SK-1037AQ1	VKMC 95660-3	SK-1654AQ2
VKMC 01263-1	SK-1694AQ1	VKMC 03122	SK-1642AQ1	VKMC 05202	SK-1038AQ1	VKMC 98109	SK-1712AQ3
VKMC 01263-2	SK-1694AQ2	VKMC 03132	SK-1392AQ1	VKMC 05222	SK-1100AQ1	VKMC 98109-2	SK-1712AQ1
VKMC 01265	SK-1539AQ1	VKMC 03205	SK-1714AQ1	VKMC 05224	SK-1478AQ1	VKMC 98109-3	SK-1712AQ2
VKMC 01269	SK-1695AQ1	VKMC 03213	SK-1082AQ2	VKMC 05228	SK-1644AQ1	VKMC 98114	SK-1719AQ1
VKMC 01270	SK-1526AQ1	VKMC 03213-1	SK-1082AQ1	VKMC 05401	R-1072AQ1	VKMC 98115-2	SK-1721AQ3
VKMC 01903-1	SK-1377AQ1	VKMC 03214	SK-1399AQ1	VKMC 05402	SK-1169AQ1	VKMC 98115-3	SK-1721AQ1
VKMC 01935	SK-1337AQ1	VKMC 03235	SK-1482AQ1	VKMC 06000	SK-1021AQ1	VKMC 98115-4	SK-1721AQ2
VKMC 01936	SK-1660AQ1	VKMC 03235	SK-1596AQ1	VKMC 06002	SK-1486AQ1	VKMCV 52009	0-N1387
VKMC 01941	SK-1378AQ1	VKMC 03240	SK-1007AQ1	VKMC 06005	SK-1338AQ1	VKMCV 52012	0-N1483
VKMC 01942	SK-1583AQ1	VKMC 03241	SK-1022AQ2	VKMC 06008	SK-1698AQ1	VKMCV 52012	0-N1483S
VKMC 01943	SK-1378AQ1	VKMC 03244	SK-1086AQ1	VKMC 06010	SK-1081AQ2	VKMCV 52013	0-N1714
VKMC 01952	SK-1619AQ2	VKMC 03246	SK-1085AQ1	VKMC 06010-2	SK-1081AQ3	VKMCV 52013	0-N1714S

SKF		SNR		SNR		SNR	
VKMCV 52016	0-N1806	GA350.80	0-N1950	GA352.40	0-N1494	GA353.59	0-N2170
VKMCV 56002	0-N1730	GA350.81	0-N2084	GA352.40	0-N1494S	GA353.59	0-N2170S
VKMS 92518	SK-1476	GA350.81	0-N2084S	GA352.42	0-N1897	GA353.60	0-N1426
SNR		GA350.82	0-N1621	GA352.42	0-N1897S	GA353.61	0-N1495S
GA350.20	0-N1298	GA350.82	0-N1621S	GA352.43	0-N1610	GA353.62	0-N1588
GA350.21	0-N1301	GA350.87	0-N2427	GA352.44	0-N1719	GA353.62	0-N1588S
GA350.22	0-N1758	GA350.87	0-N2427S	GA352.44	0-N1719S	GA353.63	0-N1648
GA350.25	0-N1511	GA350.88	0-N2216	GA352.46	0-N1639	GA353.64	0-N1798
GA350.27	0-N1291	GA350.88	0-N2216S1	GA352.46	0-N1639S	GA353.64	0-N1798S
GA350.27	0-N1291S	GA350.88	0-N2216S2	GA352.49	0-N1895	GA353.65	0-N1799
GA350.31	0-N1303	GA350.89	0-N2217	GA352.49	0-N1895S	GA353.65	0-N1799S
GA350.32	0-N1293	GA350.89	0-N2217S1	GA352.50	0-N1845	GA353.66	0-N1532
GA350.33	0-N1290	GA350.89	0-N2217S2	GA352.50	0-N1845S	GA353.66	0-N1532S
GA350.33	0-N1290S	GA350.90	0-N2215	GA352.54	0-N1665	GA353.68	0-N2087
GA350.35	0-N2135	GA350.90	0-N2215S	GA352.55	0-N1642	GA353.68	0-N2087S
GA350.36	0-N1559S	GA35074	0-N1913	GA352.57	0-N1796	GA353.70	0-N1649
GA350.38	0-N1296	GA35074	0-N1913S	GA352.57	0-N1796S	GA354.01	0-N1417
GA350.41	0-N2140	GA351.00	0-N846	GA352.59	0-N1477	GA354.04	0-N2347
GA350.46	0-N1295	GA351.01	0-N1288	GA352.61	0-N1653S	GA354.10	0-N1317
GA350.46	0-N1295S	GA351.02	0-N1278	GA352.62	0-N1434	GA354.10	0-N1317S
GA350.47	0-N2409	GA351.02	0-N1442	GA352.63	0-N1385	GA354.11	0-N1005
GA350.49	0-N1741	GA351.03	0-N1862	GA352.64	0-N1709	GA354.12	0-N2047
GA350.49	0-N1741S	GA351.05	0-N847	GA352.64	0-N1709S1	GA354.13	0-N1800
GA350.50	0-N1292	GA351.06	0-N1861	GA352.64	0-N1709S2	GA354.14	0-N1801
GA350.51	0-N1396	GA351.08	0-N1641	GA352.65	0-N1443	GA355.00	0-N1611
GA350.52	0-N1900	GA351.08	0-N1641S	GA352.66	0-N1667	GA355.00	0-N1611S
GA350.53	0-N1834	GA351.10	0-N1011	GA352.67	0-N1797	GA355.04	0-N1474
GA350.53	0-N1834S	GA351.10	0-N1011S	GA352.67	0-N1797S	GA355.05	0-N1736
GA350.54	0-N1786	GA351.11	0-N1013	GA352.68	0-N2104	GA355.06	0-N1409
GA350.55	0-N1787	GA351.11	0-N1013S	GA352.68	0-N2104S	GA355.08	0-N1717
GA350.56	0-N1453	GA351.12	0-N1703	GA352.71	0-N2038	GA355.08	0-N1717S
GA350.57	0-N1788	GA351.14	0-N1645	GA352.71	0-N2038S	GA355.09	0-N1427
GA350.57	0-N1788S	GA351.14	0-N1645S	GA352.72	0-N1716	GA355.09	0-N1427S
GA350.59	0-N1514	GA351.15	0-N1489S	GA352.74	0-N1957	GA355.09	0-N2405
GA350.59	0-N1514S	GA351.16	0-N1397	GA352.74	0-N1957S	GA355.09	0-N2405S
GA350.60	0-N1790	GA351.17	0-N1279	GA352.78	0-N2396	GA355.11	0-N1476
GA350.61	0-N1523	GA351.18	0-N1560	GA352.78	0-N2396S	GA355.11	0-N1476S
GA350.63	0-N1791	GA351.19	0-N1795	GA352.80	0-N2028	GA355.13	0-N1476
GA350.63	0-N1791S	GA351.20	0-N1395	GA352.82	0-N2353	GA355.13	0-N1476S
GA350.64	0-N1792	GA351.21	0-N1744	GA353.50	0-N1603	GA355.14	0-N1663
GA350.65	0-N1793	GA351.25	0-N2297	GA353.51	0-N1464	GA355.14	0-N1663S
GA350.65	0-N1793S	GA351.42	0-N2404	GA353.51	0-N1464S	GA355.15	0-N1664
GA350.66	0-N1794	GA351.42	0-N2404S	GA353.52	0-N1439	GA355.15	0-N1664S
GA350.66	0-N1794S	GA351.44	0-N2306	GA353.53	0-N1485	GA355.16	0-N1731
GA350.67	0-N2055	GA351.44	0-N2306S	GA353.53	0-N1485S	GA355.16	0-N1731S
GA350.67	0-N2055S	GA351.54	0-N2309	GA353.54	0-N1437	GA355.17	0-N1626
GA350.68	0-N1958	GA351.54	0-N2309S	GA353.55	0-N1438	GA355.17	0-N1626S
GA350.68	0-N1958S	GA352.30	0-N197	GA353.55	0-N1438S	GA355.19	0-N1802
GA350.71	0-N1492	GA352.31	0-N155	GA353.58	0-N1466	GA355.19	0-N1802S
GA350.71	0-N1492S	GA352.33	0-N156	GA353.58	0-N1466S	GA355.20	0-N1743



SNR		SNR		SNR		SNR	
GA355.21	0-N1803	GA357.15	0-N1432	GA358.64	0-N1750	GA359.51	0-N125S
GA355.22	0-N1804	GA357.17	0-N1738	GA358.66	0-N095	GA359.54	0-N133
GA355.22	0-N1804S	GA357.18	0-N1308	GA358.67	0-N1749	GA359.55	0-N2174
GA355.24	0-N2253	GA357.19	0-N1671	GA358.67	0-N1749S	GA359.59	0-N849
GA355.27	0-N2290	GA357.19	0-N1671S	GA358.68	0-N2154	GA359.60	0-N1682
GA355.27	0-N2290S	GA357.20	0-N1704	GA358.70	0-N2173	GA359.62	0-N2349
GA355.50	0-N1589	GA357.20	0-N1704S	GA358.71	0-N1486	GA359.66	0-N1747
GA355.54	0-N149	GA357.21	0-N1675	GA358.71	0-N1486S	GA359.68	0-N1756
GA355.55	0-N150	GA357.27	0-N1525	GA358.72	0-N124	GA359.69	0-N1751
GA355.56	0-N1753	GA357.27	0-N1525S	GA358.72	0-N1407	GA359.70	0-N931
GA355.57	0-N2176	GA357.31	0-N1908	GA358.72	0-N1407S	GA359.71	0-N151
GA355.58	0-N138	GA357.31	0-N1908S	GA358.73	0-N2413	GA359.72	0-N124
GA355.59	0-N139	GA357.34	0-N1928	GA358.74	0-N2412	GA359.73	0-N2348
GA355.62	0-N141	GA357.38	0-N1830	GA358.75	0-N1595	GA359.74	0-N1973
GA355.63	0-N2332	GA357.38	0-N1830S	GA358.75	0-N1595S	GA359.75	0-N1712
GA355.64	0-N1734	GA357.44	0-N1537	GA358.78	0-N1599	GA359.76	0-N2349
GA355.68	0-N2179	GA357.44	0-N1537S	GA358.78	0-N1599S	GA359.77	0-N1949
GA355.69	0-N1752	GA357.46	0-N1662	GA358.84	0-N1386	GA359.78	0-N1446
GA355.72	0-N1602	GA357.47	0-N1733	GA358.85	0-N1487	GA359.79	0-N1402
GA355.74	0-N2334	GA357.47	0-N1733S	GA358.85	0-N1487S	GA359.79	0-N1402S
GA355.75	0-N2335	GA357.48	0-N2110	GA358.86	0-N1481	GA359.82	0-N1545
GA355.76	0-N2333	GA357.50	0-N2111	GA358.86	0-N1481S	GA359.84	0-N1413
GA355.77	0-N2342	GA357.50	0-N2111S	GA358.87	0-N1387	GA359.85	0-N1493
GA355.78	0-N2336	GA357.57	0-N1459	GA358.88	0-N1398	GA359.85	0-N1493S
GA355.80	0-N135	GA357.57	0-N1459S	GA358.94	0-N1450	GA359.89	0-N1222
GA355.81	0-N2343	GA357.58	0-N1832	GA358.98	0-N1598	GA359.92	0-N1748
GA355.84	0-N1314	GA357.58	0-N1832S	GA358.99	0-N1478S	GA359.94	0-N1416
GA355.89	0-N1721	GA358.00	0-N1503	GA359.00	0-N1339	GA359.96	0-N1624
GA355.93	0-N143	GA358.00	0-N1503S	GA359.00	0-N1339S	GA359.96	0-N1624S
GA355.95	0-N1470	GA358.03	0-N1483	GA359.01	0-N1757	GA359.98	0-N1471
GA355.95	0-N1470S	GA358.03	0-N1483S	GA359.04	0-N1419	GA359.98	0-N1471S
GA355.96	0-N1488	GA358.04	0-N1522	GA359.05	0-N1421	GA361.00	0-N2053
GA355.96	0-N1488S	GA358.05	0-N1667	GA359.07	0-N2172	GA361.00	0-N2053S
GA355.98	0-N1469	GA358.06	0-N1805	GA359.07	0-N2172S	GA361.01	0-N1809
GA355.99	0-N1729	GA358.06	0-N1805S	GA359.08	0-N1419	GA361.01	0-N1809S
GA357.00	0-N1432S	GA358.09	0-N1720	GA359.09	0-N1959	GA361.02	0-N1659
GA357.02	0-N2345	GA358.09	0-N1720S	GA359.10	0-N1473	GA361.02	0-N1659S
GA357.03	0-N1609	GA358.10	0-N1627	GA359.10	0-N1473S	GA361.03	0-N1535
GA357.04	0-N1041	GA358.10	0-N1627S	GA359.10	0-N2175	GA361.03	0-N1535S
GA357.04	0-N1041S	GA358.11	0-N1806	GA359.13	0-N2037	GA361.05	0-N1393
GA357.05	0-N1822	GA358.50	0-N187	GA359.13	0-N2037S	GA364.01	0-N2180
GA357.05	0-N1822S	GA358.51	0-N1672	GA359.14	0-N1620	GA364.02	0-N1410
GA357.06	0-N174	GA358.53	0-N1484	GA359.14	0-N1620S	GA364.02	0-N1410S
GA357.09	0-N1538	GA358.53	0-N1484S	GA359.15	0-N1673	GA364.03	0-N1544
GA357.09	0-N1538S	GA358.54	0-N2152	GA359.15	0-N1673S	GA364.05	0-N1544
GA357.10	0-N1445	GA358.55	0-N1472S	GA359.16	0-N1807	GA364.06	0-N1544
GA357.10	0-N1445S	GA358.57	0-N1681	GA359.17	0-N1808	GA365.34	0-N1953
GA357.11	0-N1657	GA358.58	0-N1713	GA359.17	0-N1808S	GA365.34	0-N1953S
GA357.11	0-N1657S	GA358.59	0-N1722	GA359.21	0-N1711S	GA365.37	0-N1425
GA357.14	0-N1660	GA358.60	0-N2153	GA359.51	0-N125	GA365.38	0-N1448

SNR		SNR		SNR		SNR	
GA365.39	0-N1554	GA384.12	0-N2247	GE357.04	0-N923	GE368.02	0-N031
GA365.39	0-N1554S	GA384.12	0-N2247S	GE357.08	0-N941	GE368.13	0-N029
GA365.41	0-N1979	GA384.13	0-N2429	GE357.12	0-N128	GE368.14	0-N033
GA365.41	0-N1979S	GA384.15	0-N2375	GE357.14	0-N131	GE368.15	0-N1219
GA368.01	0-N2165	GA384.18	0-N1547	GE357.15	0-N166	GE369.07	0-N996
GA368.03	0-N2089	GE343.11	0-N058	GE357.17	0-N2000	GE369.08	0-N014
GA368.03	0-N2089S	GE350.02	0-N866	GE357.19	0-N924	GE369.09	0-N989
GA369.00	0-N1462	GE350.04	0-N867	GE357.21	0-N1237	GE369.10	0-N008
GA369.00	0-N1462S	GE352.07	0-N904	GE357.22	0-N168	GE369.11	0-N006
GA369.01	0-N2186	GE352.11	0-N096	GE357.24	0-N164	GE369.14	0-N991
GA369.02	0-N1482S	GE352.14	0-N291	GE357.25	0-N163	GE369.19	0-N1329
GA369.03	0-N1810	GE352.15	0-N077	GE357.26	0-N1268	GE369.20	0-N1773
GA369.03	0-N1810S	GE353.00	0-N875	GE357.28	0-N1336	GE369.22	0-N1250
GA369.05	0-N2040	GE353.05	0-N876	GE357.29	0-N1046	GE369.25	0-N2058
GA369.06	0-N2088	GE353.06	0-N909	GE357.30	0-N168	GE370.03	0-N084
GA369.06	0-N2088S	GE353.07	0-N906	GE357.31	0-N2001	GE370.06	0-N086
GA369.12	0-N1728	GE353.08	0-N907	GE357.36	0-N1575	GE370.07	0-N075
GA370.00	0-N2041	GE353.09	0-N952	GE357.37	0-N1341	GE370.08	0-N074
GA370.01	0-N2024	GE353.10	0-N953	GE357.38	0-N1570	GE370.09	0-N070
GA370.02	0-N1811	GE353.13	0-N878	GE357.39	0-N1346	GE370.10	0-N081
GA370.02	0-N1811S	GE353.14	0-N050	GE357.41	0-N2200	GE370.11	0-N080
GA370.03	0-N1858	GE353.15	0-N971	GE358.01	0-N820	GE370.12	0-N1375
GA370.03	0-N1858S	GE353.16	0-N957	GE358.12	0-N889	GE370.13	0-N1578
GA370.10	0-N2302S	GE353.17	0-N127	GE358.26	0-N938	GE370.14	0-N1816
GA370.55	0-N2035	GE353.18	0-N1765S	GE358.27	0-N1326	GE370.15	0-N1377
GA370.55	0-N2035S	GE353.19	0-N2167	GE358.28	0-N951	GE370.16	0-N1380
GA373.00	0-N2105	GE355.01	0-N854	GE358.30	0-N950	GE370.17	0-N1376
GA373.00	0-N2105S	GE355.07	0-N857	GE359.05	0-N814	GE370.18	0-N1500
GA373.05	0-N1984	GE355.09	0-N887	GE359.07	0-N862	GE370.19	0-N1550
GA373.08	0-N2364	GE355.13	0-N881	GE359.09	0-N900	GE370.20	0-N1666
GA374.32	0-N1812	GE355.16	0-N964	GE359.14	0-N945	GE373.03	0-N055
GA374.32	0-N1812S	GE355.17	0-N965	GE359.16	0-N122	GE373.11	0-N058
GA374.33	0-N2103	GE355.19	0-N958	GE359.18	0-N119P	GE373.12	0-N192
GA374.33	0-N2103S	GE355.20	0-N277	GE359.20	0-N1065	GE373.13	0-N189
GA377.01	0-N1876	GE355.21	0-N854	GE359.21	0-N171	GE373.14	0-N1130
GA377.01	0-N1876S	GE355.26	0-N146	GE359.22	0-N170	GE373.16	0-N2255
GA383.00	0-N2281	GE355.27	0-N147	GE359.23	0-N1066	GE380.01	0-N1122
GA383.00	0-N2281S	GE355.34	0-N148	GE359.24	0-N1381	GE381.00	0-N1226
GA384.00	0-N1677	GE355.35	0-N147	GE359.25	0-N1360	GE381.02	0-N1775
GA384.00	0-N1677S	GE355.36	0-N816	GE359.27	0-N1615	GE381.03	0-N1777
GA384.01	0-N1553	GE355.37	0-N821	GE359.28	0-N1358	GE381.04	0-N1776
GA384.02	0-N1813	GE355.38	0-N262	GE359.30	0-N119P	GE384.00	0-N1374
GA384.02	0-N1813S	GE355.39	0-N1259	GE359.31	0-N2382	GE384.01	0-N1370
GA384.03	0-N1467S	GE355.39	0-N1365	GE359.32	0-N2424	GE384.02	0-N1577
GA384.04	0-N1814	GE355.41	0-N1270	GE360.03	0-N937	GT333.43	0-N1353
GA384.05	0-N1815	GE355.43	0-N2380	GE361.04	0-N899	GT347.12	0-N1781
GA384.05	0-N1815S	GE355.44	0-N1355	GE361.08	0-N892	GT350.00	0-N809
GA384.08	0-N1987	GE355.45	0-N1354	GE361.12	0-N1248	GT350.01	0-N954
GA384.10	0-N2231	GE355.46	0-N148	GE365.07	0-N1350	GT350.03	0-N955
GA384.10	0-N2231S	GE357.03	0-N807	GE368.00	0-N035	GT350.05	0-N925



SNR		SNR		SNR		SNR	
GT352.02	0-N837	GT355.11	0-N173	GT357.43	0-N1051S	GT359.12	0-N943
GT352.03	0-N842	GT355.12	0-N863	GT357.45	0-N1276	GT359.13	0-N944
GT352.04	0-N874	GT355.14	0-N913	GT357.46	0-N1049	GT359.15	0-N121
GT352.05	0-N902	GT355.18	0-N930	GT357.48	0-N1050	GT359.17	0-N118P
GT352.06	0-N903	GT355.22	0-N145	GT357.49	0-N1331	GT359.19	0-N214
GT352.08	0-N838	GT355.23	0-N949	GT357.51	0-N1045	GT359.20	0-N215
GT352.09	0-N839	GT355.25	0-N112	GT357.52	0-N1335	GT359.21	0-N1058
GT352.10	0-N985	GT355.33	0-N137	GT357.54	0-N108	GT359.22	0-N1277
GT352.12	0-N915	GT355.34	0-N198	GT357.55	0-N130	GT359.23	0-N1061
GT352.14	0-N089	GT355.36	0-N200	GT357.55	0-N130S	GT359.24	0-N1062
GT352.15	0-N295	GT355.37	0-N1112	GT357.57	0-N1371	GT359.25	0-N1058
GT352.16	0-N123	GT355.38	0-N1269	GT357.59	0-N1372	GT359.26	0-N1057
GT352.17	0-N078	GT355.39	0-N1111	GT357.67	0-N1817	GT359.27	0-N1056
GT352.18	0-N1260	GT355.40	0-N1173	GT357.67	0-N1817S	GT359.28	0-N1359
GT352.18	0-N294	GT355.41	0-N1571	GT357.68	0-N1818	GT359.29	0-N1614
GT352.21	0-N1367	GT355.42	0-N1323	GT357.70	0-N1340	GT359.30	0-N1357
GT352.22	0-N1246	GT355.44	0-N1368	GT357.71	0-N1337	GT359.31	0-N1338
GT352.23	0-N1564	GT355.45	0-N2062	GT357.73	0-N1905	GT359.32	0-N118P
GT352.24	0-N2220	GT357.00	0-N808	GT357.77	0-N2208	GT359.33	0-N1327
GT352.24	0-N2220S	GT357.01	0-N805	GT357.50	0-N1332	GT359.34	0-N1343
GT352.26	0-N1573	GT357.02	0-N806	GT358.00	0-N819	GT359.36	0-N2018
GT352.27	0-N2057	GT357.05	0-N922	GT358.08	0-N823	GT359.38	0-N2063
GT353.04	0-N877	GT357.06	0-N940	GT358.09	0-N832	GT359.39	0-N2224
GT353.11	0-N948	GT357.07	0-N160	GT358.11	0-N835	GT360.00	0-N800
GT353.12	0-N910	GT357.09	0-N103	GT358.14	0-N859	GT360.01	0-N801
GT353.14	0-N879	GT357.10	0-N104	GT358.15	0-N826	GT361.01	0-N897
GT353.16	0-N100	GT357.11	0-N106	GT358.18	0-N818	GT361.03	0-N898
GT353.17	0-N102	GT357.13	0-N107	GT358.22	0-N815	GT361.05	0-N894
GT353.18	0-N101	GT357.17	0-N111	GT358.25	0-N850	GT361.06	0-N891
GT353.19	0-N049	GT357.18	0-N1229	GT358.29	0-N113	GT361.07	0-N1256
GT353.20	0-N048	GT357.20	0-N1236	GT358.30	0-N115	GT361.09	0-N927
GT353.21	0-N047	GT357.21	0-N921	GT358.31	0-N114	GT361.13	0-N1273
GT353.22	0-N970	GT357.23	0-N129	GT358.32	0-N208	GT361.14	0-N1120
GT353.24	0-N956	GT357.24	0-N939	GT358.33	0-N194	GT361.15	0-N1272
GT353.25	0-N300	GT357.25	0-N158	GT358.34	0-N196	GT361.16	0-N1243
GT353.26	0-N1085	GT357.26	0-N1263	GT358.35	0-N195	GT361.17	0-N1121
GT353.27	0-N1383	GT357.27	0-N157	GT358.36	0-N1351	GT365.02	0-N860
GT353.28	0-N973	GT357.32	0-N110	GT358.37	0-N1352	GT365.03	0-N917
GT353.29	0-N1085	GT357.33	0-N109	GT358.38	0-N1572	GT365.04	0-N116
GT353.30	0-N2168	GT357.34	0-N1042	GT358.39	0-N1092	GT365.05	0-N117
GT353.31	0-N115	GT357.34	0-N1566	GT358.40	0-N1616	GT365.06	0-N1231
GT353.32	0-N1347	GT357.35	0-N159	GT359.00	0-N869	GT365.08	0-N1349
GT353.33	0-N042	GT357.36	0-N105	GT359.01	0-N861	GT365.10	0-N1324
GT353.34	0-N1765	GT357.37	0-N1048	GT359.02	0-N871	GT365.11	0-N1884
GT353.35	0-N1768	GT357.38	0-N1232	GT359.03	0-N811	GT366.01	0-N911
GT353.37	0-N1952	GT357.39	0-N1274	GT359.04	0-N811	GT366.02	0-N812
GT355.00	0-N880	GT357.40	0-N1364	GT359.06	0-N813	GT368.03	0-N034
GT355.03	0-N882	GT357.41	0-N1238	GT359.08	0-N901	GT368.04	0-N022
GT355.08	0-N883	GT357.42	0-N1275	GT359.10	0-N822	GT368.05	0-N021
GT355.10	0-N856	GT357.43	0-N1051	GT359.11	0-N870	GT368.06	0-N028

SNR		SNR		SNR		SNR	
GT368.07	0-N027	GT370.30	0-N1826	GT380.00	0-N968	KD453.23	SK-1508
GT368.08	0-N025	GT370.31	0-N1216	GT381.01	0-N1828	KD453.24	SK-1112
GT368.09	0-N030	GT372.00	0-N912	GT381.03	0-N1071	KD453.25	SK-1586
GT368.10	0-N032	GT373.00	0-N061	GT381.04	0-N1829	KD453.26	SK-1607
GT368.11	0-N094	GT373.01	0-N059	GT384.00	0-N975	KD453.28	SK-1273
GT368.12	0-N024	GT373.02	0-N056	GT384.01	0-N1561	KD453.30	SK-1481
GT369.00	0-N995	GT373.04	0-N184	GT384.02	0-N1366	KD453.31	SK-1481
GT369.01	0-N013	GT373.05	0-N186	GT384.04	0-N1576	KD453.32	SK-1612
GT369.02	0-N988	GT373.06	0-N986	KD450.02	SK-1059	KD453.33	SK-1054
GT369.03	0-N999	GT373.07	0-N051	KD450.03	SK-1060	KD453.34	SK-1685
GT369.04	0-N997	GT373.08	0-N188	KD450.04	SK-1064	KD455.00	SK-1014
GT369.05	0-N007	GT373.09	0-N179	KD452.01	SK-1039	KD455.01	SK-1010
GT369.06	0-N005	GT373.12	0-N183	KD452.04	SK-1027	KD455.02	SK-1015
GT369.12	0-N176	GT373.13	0-N065	KD452.06	SK-1053	KD455.03	SK-1012
GT369.13	0-N992	GT373.14	0-N053	KD452.07	SK-1078	KD455.04	SK-1011
GT369.15	0-N998	GT373.15	0-N060	KD452.08	SK-1094	KD455.05	SK-1021
GT369.19	0-N001	GT373.16	0-N052	KD452.09	SK-1041	KD455.06	SK-1013
GT369.20	0-N000	GT373.17	0-N054	KD452.10	SK-1042	KD455.08	SK-1091
GT369.21	0-N990	GT373.18	0-N062	KD452.11	SK-1105	KD455.10	SK-1092
GT369.22	0-N036	GT373.19	0-N987	KD452.11	SK-1754	KD455.11	SK-1093
GT369.25	0-N1754	GT373.20	0-N1764	KD452.13	SK-1052	KD455.12	SK-1014
GT369.26	0-N1328	GT373.21	0-N185	KD452.16	SK-1340	KD455.12	SK-1063
GT369.28	0-N1618	GT373.22	0-N191	KD452.17	SK-1339	KD455.13	SK-1081
GT369.30	0-N2320	GT373.24	0-N1129	KD452.18	SK-1077	KD455.14	SK-1036
GT369.31	0-N1883	GT373.25	0-N181	KD452.19	SK-1049	KD455.15	SK-1103
GT369.31	0-N1883S	GT373.29	0-N182	KD452.22	SK-1341	KD455.16	SK-1171
GT369.34	0-N1879	GT373.30	0-N2012	KD452.24	SK-1659	KD455.20	SK-1089
GT369.36	0-N1819	GT373.31	0-N1827	KD452.26	SK-1666	KD455.21	SK-1108
GT369.37	0-N1562	GT373.32	0-N1771	KD453.00	SK-1056	KD455.22	SK-1154
GT369.40	0-N1820	GT373.34	0-N2161	KD453.01	SK-1037	KD455.27	SK-1095
GT369.41	0-N1821	GT373.34	0-N2161S	KD453.02	SK-1162	KD455.28	SK-1096
GT369.42	0-N1823	GT373.35	0-N1772	KD453.04	SK-1164	KD455.31	SK-1084
GT370.00	0-N073	GT373.42	0-N1583	KD453.05	SK-1168	KD455.32	SK-1491
GT370.01	0-N072	GT373.46	0-N2010	KD453.06	SK-1100	KD455.33	SK-1045
GT370.02	0-N180	GT374.00	0-N905	KD453.07	SK-1163	KD455.34	SK-1046
GT370.04	0-N083	GT374.01	0-N981	KD453.08	SK-1165	KD455.35	SK-1035
GT370.05	0-N082	GT374.02	0-N926	KD453.09	SK-1166	KD455.35	SK-1680
GT370.10	0-N069	GT374.03	0-N178	KD453.10	SK-1038	KD455.36	SK-1153
GT370.11	0-N983	GT374.04	0-N982	KD453.11	SK-1073	KD455.37	SK-1108S
GT370.12	0-N092	GT374.05	0-N978	KD453.12	SK-1113	KD455.39	SK-1114
GT370.13	0-N071	GT374.06	0-N979	KD453.13	SK-1273	KD455.40	SK-1088
GT370.14	0-N076	GT377.00	0-N019	KD453.14	SK-1478	KD455.41	SK-1338
GT370.15	0-N1379	GT377.01	0-N018	KD453.15	SK-1169	KD455.42	SK-1099
GT370.16	0-N1824	GT377.02	0-N916	KD453.16	SK-1260	KD455.43	SK-1494
GT370.18	0-N1825	GT377.03	0-N020	KD453.17	SK-1355	KD455.43	SK-1625
GT370.21	0-N1759	GT377.06	0-N2322	KD453.18	SK-1612	KD455.44	SK-1623
GT370.24	0-N1499S	GT379.00	0-N039	KD453.19	SK-1479	KD455.45	SK-1631
GT370.27	0-N1760	GT379.03	0-N043	KD453.20	SK-1481	KD455.46	SK-1486
GT370.28	0-N1936	GT379.04	0-N041	KD453.21	SK-1183	KD455.47	SK-1493
GT370.29	0-N1378	GT379.05	0-N037	KD453.22	SK-1644	KD455.48	SK-1490



SNR		SNR		SNR		SNR	
KD455.49	SK-1487	KD457.47	SK-1633	KD458.41	SK-1697	KD459.52	SK-1598
KD455.50	SK-1489	KD457.48	SK-1375	KD458.43	SK-1646	KD459.54	SK-1594
KD455.51	SK-1622	KD457.49	SK-1372	KD458.46	SK-1665	KD459.56	SK-1600
KD455.52	SK-1624	KD457.49	SK-1617	KD458.47	SK-1610	KD459.57	SK-1714
KD455.53	SK-1657	KD457.50	SK-1595	KD458.51	SK-1587	KD459.59	SK-1728
KD455.55	SK-1663	KD457.51	SK-1592	KD458.52	SK-1367	KD459.64	SK-1732
KD455.56	SK-1580	KD457.54	SK-1583	KD458.54	SK-1677	KD461.02	SK-1067
KD455.57	SK-1630	KD457.55	SK-1638	KD458.56	SK-1602	KD461.05	SK-1450
KD455.61	SK-1698	KD457.56	SK-1337	KD458.56	SK-1696	KD465.00	SK-1061
KD457.00	SK-1001	KD457.60	SK-1380	KD458.57	SK-1693	KD465.01	SK-1529
KD457.01	SK-1026	KD457.61	SK-1668	KD459.00	SK-1007	KD465.02	SK-1265
KD457.02	SK-1024	KD457.65	SK-1386	KD459.01	SK-1022	KD465.03	SK-1608
KD457.03	SK-1029	KD457.66	SK-1599	KD459.02	SK-1006	KD468.01	SK-1068
KD457.04	SK-1047	KD457.67	SK-1694	KD459.03	SK-1004	KD468.01	SK-1662
KD457.05	SK-1090	KD457.68	SK-1259	KD459.04	SK-1018S	KD468.05	SK-1210
KD457.07	SK-1120	KD457.70	SK-1597	KD459.05	SK-1005	KD468.06	SK-1205
KD457.08	SK-1123	KD457.72	SK-1727	KD459.06	SK-1003	KD468.08	SK-1286
KD457.10	SK-1129	KD457.76	SK-1724	KD459.07	SK-1020	KD468.09	SK-1203
KD457.11	SK-1578	KD458.00	SK-1023	KD459.08	SK-1019	KD468.11	SK-1207
KD457.12	SK-1069	KD458.01	SK-1032	KD459.09	SK-1017	KD468.13	SK-1202
KD457.13	SK-1098	KD458.08	SK-1138	KD459.10	SK-1016	KD468.17	SK-1476
KD457.14	SK-1131	KD458.11	SK-1140	KD459.11	SK-1034	KD469.00	SK-1189
KD457.16	SK-1111	KD458.12	SK-1141	KD459.12	SK-1040	KD469.01	SK-1188
KD457.17	SK-1122	KD458.13	SK-1031	KD459.14	SK-1082	KD469.02	SK-1062
KD457.18	SK-1119	KD458.14	SK-1043	KD459.15	SK-1158	KD469.03	SK-1522
KD457.20	SK-1124	KD458.15	SK-1449	KD459.16	SK-1157	KD469.05	SK-1192
KD457.21	SK-1130	KD458.16	SK-1033	KD459.17	SK-1159	KD469.07	SK-1275
KD457.22	SK-1346	KD458.17	SK-1150	KD459.18	SK-1079	KD469.09	SK-1195
KD457.22	SK-1638	KD458.18	SK-1151	KD459.24	SK-1176	KD469.10	SK-1196
KD457.23	SK-1346	KD458.19	SK-1445	KD459.29	SK-1086	KD469.11	SK-1197
KD457.23	SK-1638	KD458.20	SK-1264	KD459.30	SK-1085	KD469.12	SK-1186
KD457.24	SK-1101	KD458.24	SK-1155	KD459.31	SK-1087	KD469.13	SK-1075
KD457.26	SK-1511	KD458.24	SK-1629	KD459.32	SK-1394	KD469.14	SK-1589
KD457.27	SK-1582	KD458.25	SK-1142	KD459.33	SK-1534	KD469.16	SK-1752
KD457.28	SK-1104	KD458.27	SK-1143	KD459.34	SK-1353	KD469.22	SK-1589
KD457.29	SK-1106	KD458.28	SK-1144	KD459.35	SK-1354	KD470.00	SK-1228
KD457.30	SK-1512	KD458.29	SK-1345	KD459.36	SK-1392	KD470.01	SK-1225
KD457.31	SK-1425	KD458.30	SK-1080	KD459.37	SK-1399	KD470.03	SK-1227
KD457.32	SK-1109	KD458.31	SK-1361	KD459.38	SK-1391	KD470.06	SK-1224
KD457.33	SK-1337	KD458.32	SK-1050	KD459.39	SK-1399	KD470.07	SK-1219
KD457.33	SK-1660	KD458.33	SK-1112	KD459.40	SK-1482	KD470.09	SK-1223
KD457.34	SK-1343	KD458.33	SK-1602	KD459.40	SK-1596	KD470.10	SK-1226
KD457.35	SK-1376	KD458.33	SK-1629	KD459.42	SK-1424	KD470.11	SK-1231
KD457.36	SK-1074	KD458.34	SK-1412	KD459.43	SK-1642	KD470.12	SK-1302
KD457.37	SK-1258	KD458.35	SK-1421	KD459.44	SK-1609	KD470.13	SK-1222
KD457.38	SK-1526	KD458.36	SK-1418	KD459.45	SK-1577	KD470.15	SK-1627
KD457.39	SK-1344	KD458.37	SK-1410	KD459.46	SK-1483	KD470.17	SK-1751
KD457.40	SK-1126	KD458.38	SK-1415	KD459.47	SK-1615	KD470.19	SK-1221
KD457.45	SK-1640	KD458.39	SK-1411	KD459.48	SK-1742	KD470.21	SK-1671
KD457.46	SK-1383	KD458.40	SK-1446	KD459.50	SK-1614	KD470.23	SK-1457

SNR

SNR

TRISCAN

TRISCAN

KD470.24	SK-1654
KD470.27	SK-1716
KD470.31	SK-1674
KD470.35	SK-1750
KD473.00	SK-1236
KD473.01	SK-1306
KD473.03	SK-1310
KD473.04	SK-1320
KD473.05	SK-1234
KD473.06	SK-1314
KD473.07	SK-1555
KD473.11	SK-1460
KD473.12	SK-1470
KD473.14	SK-1316
KD473.15	SK-1458
KD473.21	SK-1325
KD474.00	SK-1066
KD474.02	SK-1277
KD474.03	SK-1211
KD474.05	SK-1213
KD474.06	SK-1216
KD474.07	SK-1220
KD474.08	SK-1288
KD474.09	SK-1436
KD474.10	SK-1070
KD474.14	SK-1590
KD477.00	SK-1248
KD477.01	SK-1249
KD477.02	SK-1250
KD477.05	SK-1245
KD477.07	SK-1564
KD481.00	SK-1335
KD484.00	SK-1439
KD484.01	SK-1634
KD484.02	SK-1626
KD484.04	SK-1684
KDP453.020	SK-1162AQ1
KDP453.060	SK-1100AQ1
KDP453.100	SK-1038AQ1
KDP453.110	SK-1073AQ1
KDP453.120	SK-1113AQ1
KDP453.150	SK-1169AQ1
KDP453.250	SK-1586AQ1
KDP455.051	SK-1021AQ1
KDP455.052	SK-1021AQ2
KDP455.130	SK-1081AQ2
KDP455.400	SK-1088AQ1
KDP455.410	SK-1131AQ1
KDP455.410	SK-1338AQ1
KDP455.411	SK-1338AQ2

KDP455.460	SK-1486AQ1
KDP455.470	SK-1493AQ1
KDP455.490	SK-1487AQ1
KDP457.141	SK-1131AQ2
KDP457.141	SK-1592AQ1
KDP457.260	SK-1511AQ1
KDP457.270	SK-1582AQ1
KDP457.271	SK-1582AQ2
KDP457.370	SK-1111AQ1
KDP457.480	SK-1621AQ1
KDP457.492	SK-1372AQ1
KDP458.330	SK-1629AQ1
KDP458.340	SK-1412AQ1
KDP458.360	SK-1418AQ1
KDP458.370	SK-1410AQ1
KDP458.410	SK-1697AQ1
KDP459.000	SK-1007AQ1
KDP459.030	SK-1004AQ1
KDP459.060	SK-1003AQ1
KDP459.090	SK-1017AQ1
KDP459.120	SK-1040AQ1
KDP459.290	SK-1086AQ1
KDP459.300	SK-1085AQ1
KDP459.340	SK-1353AQ1
KDP459.350	SK-1354AQ1
KDP459.360	SK-1392AQ1
KDP459.380	SK-1391AQ1
KDP459.420	SK-1424AQ1
KDP459.470	SK-1615AQ1
KDP459.500	SK-1614AQ1
KDP459.520	SK-1598AQ1
KDP459.540	SK-1594AQ1
KDP459.570	SK-1714AQ1
KDP459.590	SK-1728AQ1

TRISCAN

5641 252006	0-N2342
5647 10048	SK-1529
5647 10063	SK-1492
8641 101008	0-N1834
8641 101008	0-N1834S
8641 101009	0-N1711S
8641 102016	0-N1396
8641 102019	0-N1387
8641 102021	0-N1678
8641 102028	0-N1392
8641 102035	0-N2052
8641 102036	0-N2281
8641 102036	0-N2281S
8641 102038	0-N1984
8641 102039	0-N2276

8641 102040	0-N2353
8641 102041	0-N2283
8641 103013	0-N1476
8641 103013	0-N1476S
8641 103015	0-N1473
8641 103015	0-N1473S
8641 103026	0-N1964
8641 103026	0-N1964S
8641 103033	0-N1811
8641 103033	0-N1811S
8641 103037	0-N2242
8641 103037	0-N2242S
8641 111008	0-N1640
8641 111009	0-N1514
8641 111009	0-N1514S
8641 111013	0-N1523
8641 111022	0-N2084
8641 111022	0-N2084S
8641 112012	0-N1786
8641 112015	0-N2076
8641 112015	0-N2076S
8641 112018	0-N1950
8641 113005	0-N1290
8641 113005	0-N1290S
8641 113008	0-N1291
8641 113008	0-N1291S
8641 113012	0-N2410
8641 113013	0-N1512
8641 113013	0-N1512S
8641 113021	0-N2409
8641 113026	0-N1621
8641 113026	0-N1621S
8641 113027	0-N1788
8641 113027	0-N1788S
8641 113030	0-N1492
8641 113030	0-N1492S
8641 113031	0-N2124
8641 113031	0-N2124S
8641 113036	0-N1958
8641 113036	0-N1958S
8641 123001	0-N2413
8641 13015	SK-1521
8641 131001	0-N2186
8641 131002	0-N1728
8641 131003	0-N2040
8641 132001	0-N2189S
8641 132009	0-N2051
8641 141003	0-N2164
8641 141006	0-N2357
8641 142001	0-N2043

8641 151001	0-N1599
8641 151001	0-N1599S
8641 151005	0-N1720
8641 151005	0-N1720S
8641 151006	0-N1627
8641 151006	0-N1627S
8641 152005	0-N1386
8641 152015	0-N187
8641 153004	0-N2412
8641 153008	0-N1483
8641 153008	0-N1483S
8641 161014	0-N2396
8641 161014	0-N2396S
8641 162007	0-N1385
8641 162009	0-N1716
8641 163002	0-N1897
8641 163002	0-N1897S
8641 163011	0-N1957
8641 163011	0-N1957S
8641 163013	0-N2155
8641 163013	0-N2155S
8641 163020	0-N2266
8641 163020	0-N2266S1
8641 163020	0-N2266S2
8641 163021	0-N2269
8641 163021	0-N2269S
8641 173002	0-N1857
8641 173005	0-N1742
8641 173005	0-N1742S
8641 182002	0-N1856
8641 182002	0-N1856S
8641 211001	0-N2274
8641 212001	0-N1646
8641 231001	0-N847
8641 231016	0-N2120
8641 231018	0-N1288
8641 231023	0-N2404
8641 231023	0-N2404S
8641 231024	0-N2422
8641 231024	0-N2422S
8641 231026	0-N2216
8641 231026	0-N2216S1
8641 231026	0-N2216S2
8641 231027	0-N2217
8641 231027	0-N2217S1
8641 231027	0-N2217S2
8641 232001	0-N1442
8641 232010	0-N1560
8641 232011	0-N1746
8641 232021	0-N2284



TRISCAN

8641 232024	0-N2368
8641 232025	0-N2403
8641 232025	0-N2403S
8641 232026	0-N2205
8641 232027	0-N2238
8641 232028	0-N2312
8641 232029	0-N2296
8641 233002	0-N1011
8641 233002	0-N1011S
8641 233005	0-N1641
8641 233005	0-N1641S
8641 233006	0-N1013
8641 233006	0-N1013S
8641 233017	0-N1946
8641 233017	0-N1946S1
8641 233017	0-N1946S2
8641 233020	0-N2219
8641 233020	0-N2219S
8641 233023	0-N2086
8641 233023	0-N2086S
8641 242001	0-N1439
8641 242004	0-N1649
8641 243006	0-N1438
8641 243006	0-N1438S
8641 243007	0-N1588
8641 243007	0-N1588S
8641 243011	0-N1798
8641 243011	0-N1798S
8641 243014	0-N2389
8641 243014	0-N2389S
8641 251001	0-N139
8641 251002	0-N1721
8641 251004	0-N2334
8641 251005	0-N2333
8641 251011	0-N149
8641 251015	0-N2336
8641 251018	0-N2280
8641 251018	0-N2280S
8641 252022	0-N2275
8641 253003	0-N152
8641 253003	0-N152S
8641 253005	0-N1427
8641 253005	0-N1427S
8641 253006	0-N1626
8641 253006	0-N1626S
8641 253008	0-N1663
8641 253008	0-N1663S
8641 253010	0-N2265
8641 253010	0-N2265S
8641 253011	0-N2279

TRISCAN

8641 253011	0-N2279S
8641 273003	0-N1953
8641 273003	0-N1953S
8641 281001	0-N2349
8641 281005	0-N2348
8641 281011	0-N133
8641 281013	0-N849
8641 281026	0-N2268
8641 281026	0-N2268S
8641 281027	0-N2392
8641 281027	0-N2392S
8641 282011	0-N1446
8641 282020	0-N2355
8641 283003	0-N1673
8641 283003	0-N1673S
8641 283004	0-N1620
8641 283004	0-N1620S
8641 283007	0-N2095S1
8641 291001	0-N1417
8641 291006	0-N1432S
8641 291008	0-N2391
8641 291008	0-N2391S
8641 291011	0-N2351
8641 292010	0-N2347
8641 292013	0-N2345
8641 292019	0-N1928
8641 292021	0-N1906
8641 292023	0-N2110
8641 292026	0-N1832
8641 292026	0-N1832S
8641 292027	0-N2350
8641 293002	0-N1539
8641 293003	0-N1041
8641 293003	0-N1041S
8641 293005	0-N1538
8641 293005	0-N1538S
8641 293006	0-N1822
8641 293006	0-N1822S
8641 293010	0-N1459
8641 293010	0-N1459S
8641 293011	0-N1432
8641 293018	0-N1733
8641 293018	0-N1733S
8641 293021	0-N1534
8641 293021	0-N1534S
8641 293023	0-N1537
8641 293023	0-N1537S
8641 293025	0-N1908
8641 293025	0-N1908S
8641 293035	0-N2111

TRISCAN

8641 293035	0-N2111S
8641 383001	0-N2095
8641 383001	0-N2095S
8641 402001	0-N1852
8641 403002	0-N2400
8641 403002	0-N2400S
8641 403003	0-N1851
8641 403003	0-N1851S
8641 403005	0-N1850
8641 403005	0-N1850S
8641 403006	0-N2398
8641 403006	0-N2398S
8641 403008	0-N2399
8641 403008	0-N2399S
8641 423003	0-N2270
8641 423003	0-N2270S
8641 431003	0-N2247
8641 431003	0-N2247S
8641 432002	0-N1547
8641 432007	0-N2375
8641 432010	0-N2429
8641 432011	0-N2248
8641 432013	0-N1987
8641 433001	0-N1815
8641 433001	0-N1815S
8641 433002	0-N2231
8641 433002	0-N2231S
8641 502005	0-N2244
8641 502006	0-N2311
8641 502007	0-N2286
8641 502008	0-N2302S
8641 503001	0-N2104
8641 503001	0-N2104S
8641 503007	0-N2395
8641 503007	0-N2395S
8641 503008	0-N2394
8641 503008	0-N2394S
8641 653003	0-N2029
8641 653003	0-N2029S
8641 681001	0-N2374
8641 682001	0-N2102
8641 691006	0-N2106
8641 693002	0-N1876
8641 693002	0-N1876S
8641 801001	0-N1646
8641 801003	0-N2397
8641 801003	0-N2397S
8641 802004	0-N2364
86411 73002	0-N1857S
86412 93002	0-N1539S

TRISCAN

8641231002	0-N846
8641281003	0-N124
8641281006	0-N095
8641291003	0-N1445
8641291003	0-N1445S
8641292005	0-N1308
8641293001	0-N1660
8641293004	0-N1441
8641293004	0-N1441S
8641293007	0-N1800
8641293017	0-N1530
8641293017	0-N1530S
8646 10101	0-N823
8646 10103	0-N812
8646 10104	0-N813
8646 10106	0-N815
8646 10108	0-N871
8646 10110	0-N856
8646 10111	0-N173
8646 10114	0-N911
8646 10115	0-N943
8646 10116	0-N944
8646 10117	0-N064
8646 10118	0-N137
8646 10119	0-N1232
8646 10121	0-N1062
8646 10124	0-N1269
8646 10127	0-N185
8646 10129	0-N1324
8646 10130	0-N1357
8646 10201	0-N807
8646 10202	0-N822
8646 10204	0-N869
8646 10205	0-N814
8646 10209	0-N887
8646 10210	0-N854
8646 10213	0-N945
8646 10214	0-N075
8646 10216	0-N147
8646 10218	0-N148
8646 10220	0-N170
8646 10221	0-N171
8646 10223	0-N1270
8646 10226	0-N189
8646 10227	0-N1326
8646 10228	0-N1358
8646 10232	0-N2149
8646 11102	0-N925
8646 11103	0-N954
8646 11104	0-N955

TRISCAN		TRISCAN		TRISCAN		TRISCAN	
8646 11201	0-N866	8646 16111	0-N1216	8646 25108	0-N200	8646 29143	0-N107
8646 11202	0-N867	8646 16112	0-N985	8646 25202	0-N857	8646 29144	0-N130
8646 12103	0-N800	8646 16113	0-N123	8646 25203	0-N262	8646 29150	0-N1331
8646 12104	0-N801	8646 16114	0-N089	8646 25204	0-N146	8646 29157	0-N2208
8646 13101	0-N990	8646 16115	0-N294	8646 25205	0-N1259	8646 29202	0-N1229
8646 13102	0-N992	8646 16116	0-N290	8646 27101	0-N860	8646 29204	0-N131
8646 13104	0-N997	8646 16117	0-N1260	8646 27102	0-N1231	8646 29205	0-N167
8646 13105	0-N998	8646 16202	0-N902	8646 27108	0-N930	8646 29208	0-N2000
8646 13106	0-N001	8646 16203	0-N904	8646 27114	0-N1884	8646 29209	0-N941
8646 13110	0-N988	8646 16204	0-N1214	8646 27115	0-N2315	8646 29210	0-N163
8646 13112	0-N013	8646 16206	0-N293	8646 27202	0-N162	8646 29211	0-N166
8646 13113	0-N005	8646 16207	0-N291	8646 27203	0-N960	8646 29213	0-N2001
8646 13114	0-N999	8646 16208	0-N292	8646 27204	0-N172	8646 29214	0-N1268
8646 13115	0-N007	8646 16209	0-N295	8646 27205	0-N920	8646 29216	0-N164
8646 13123	0-N2320	8646 17101	0-N1243	8646 27207	0-N958	8646 29217	0-N168
8646 13202	0-N996	8646 17102	0-N1120	8646 28101	0-N215	8646 29219	0-N1046
8646 13204	0-N006	8646 17103	0-N894	8646 28103	0-N121	8646 29220	0-N169
8646 13205	0-N989	8646 17107	0-N968	8646 28104	0-N1058	8646 29301	0-N1237
8646 13207	0-N014	8646 17202	0-N1122	8646 28105	0-N214	8646 29302	0-N1051
8646 13208	0-N008	8646 21101	0-N970	8646 28108	0-N1277	8646 29302	0-N1051S
8646 13300	0-N1820	8646 21102	0-N973	8646 28110	0-N1343	8646 29304	0-N1275
8646 14101	0-N032	8646 21201	0-N971	8646 28111	0-N1338	8646 29305	0-N1371
8646 14104	0-N025	8646 24103	0-N877	8646 28202	0-N122	8646 40105	0-N905
8646 14105	0-N021	8646 24104	0-N879	8646 29101	0-N805	8646 40107	0-N178
8646 14106	0-N034	8646 24105	0-N948	8646 29103	0-N808	8646 40108	0-N927
8646 14109	0-N094	8646 24106	0-N100	8646 29104	0-N923	8646 40109	0-N979
8646 14110	0-N030	8646 24107	0-N910	8646 29105	0-N922	8646 40110	0-N982
8646 14111	0-N028	8646 24108	0-N126	8646 29106	0-N940	8646 41102	0-N038
8646 14112	0-N024	8646 24109	0-N102	8646 29108	0-N806	8646 41104	0-N036
8646 14201	0-N033	8646 24110	0-N101	8646 29109	0-N924	8646 42101	0-N986
8646 14203	0-N035	8646 24111	0-N049	8646 29110	0-N1230	8646 42102	0-N051
8646 14204	0-N029	8646 24112	0-N956	8646 29112	0-N104	8646 42104	0-N059
8646 15101	0-N826	8646 24115	0-N1347	8646 29114	0-N103	8646 42105	0-N061
8646 15102	0-N835	8646 24116	0-N1369	8646 29115	0-N116	8646 42106	0-N188
8646 15104	0-N832	8646 24203	0-N876	8646 29116	0-N108	8646 42107	0-N183
8646 15107	0-N818	8646 24204	0-N878	8646 29117	0-N109	8646 42108	0-N184
8646 15109	0-N850	8646 24205	0-N953	8646 29118	0-N110	8646 42110	0-N063
8646 15113	0-N114	8646 24206	0-N952	8646 29123	0-N159	8646 42111	0-N179
8646 15114	0-N208	8646 24207	0-N909	8646 29124	0-N105	8646 42112	0-N060
8646 15116	0-N196	8646 24208	0-N907	8646 29127	0-N132	8646 42113	0-N987
8646 15117	0-N115	8646 24209	0-N906	8646 29128	0-N160	8646 42114	0-N054
8646 15119	0-N1572	8646 24210	0-N127	8646 29129	0-N117	8646 42115	0-N186
8646 15215	0-N938	8646 24211	0-N957	8646 29131	0-N129	8646 42116	0-N052
8646 15217	0-N950	8646 24212	0-N300	8646 29132	0-N1236	8646 42117	0-N056
8646 15219	0-N1093	8646 24213	0-N050	8646 29133	0-N1266	8646 42118	0-N182
8646 16103	0-N837	8646 24215	0-N878	8646 29134	0-N201	8646 42119	0-N181
8646 16105	0-N874	8646 24216	0-N1574	8646 29135	0-N1258	8646 42120	0-N191
8646 16106	0-N839	8646 25102	0-N883	8646 29136	0-N1265	8646 42121	0-N191
8646 16107	0-N842	8646 25103	0-N882	8646 29138	0-N1050	8646 42123	0-N1129
8646 16109	0-N915	8646 25107	0-N198	8646 29141	0-N1238	8646 42125	0-N1771



TRISCAN		TRISCAN		TRISCAN		TRISCAN	
8646 42201	0-N055	864640102	0-N926	8647 10081	SK-1732	8647 15048	SK-1629
8646 42202	0-N192	864640104	0-N981	8647 11002	SK-1059	8647 15050	SK-1646
8646 42203	0-N2255	864642109	0-N053	8647 11003	SK-1060	8647 160001	SK-1094AQ1
8646 43101	0-N975	864650107	0-N073	8647 130004	SK-1589AQ2	8647 16003	SK-1027
8646 50101	0-N983	864650110	0-N092	8647 13001	SK-1275	8647 16005	SK-1041
8646 50102	0-N069	864650111	0-N078	8647 13003	SK-1062	8647 16007	SK-1053
8646 50103	0-N180	8647 100001	SK-1022AQ1	8647 13004	SK-1189	8647 16011	SK-1339
8646 50105	0-N071	8647 100001	SK-1022AQ2	8647 13006	SK-1187	8647 16012	SK-1340
8646 50106	0-N072	8647 100003	SK-1526AQ2	8647 13007	SK-1188	8647 16013	SK-1341
8646 50108	0-N082	8647 100009	SK-1103AQ1	8647 13009	SK-1195	8647 16018	SK-1754
8646 50109	0-N027	8647 100010	SK-1666AQ1	8647 13011	SK-1075	8647 17004	SK-1552
8646 50112	0-N083	8647 100011	SK-1586AQ1	8647 13012	SK-1192	8647 17005	SK-1501
8646 50113	0-N076	8647 100012	SK-1424AQ1	8647 13016	SK-1589	8647 17007	SK-1450
8646 50115	0-N1824	8647 100014	SK-1491AQ1	8647 13016	SK-1717	8647 17008	SK-1533
8646 50117	0-N1379	8647 100015	SK-1594AQ1	8647 13017	SK-1274	8647 17009	SK-1507
8646 50201	0-N074	8647 10002	SK-1022	8647 13020	SK-1752	8647 17011	SK-1502
8646 50202	0-N077	8647 100022	SK-1586AQ1	8647 13022	SK-1702	8647 18002	SK-1716
8646 50203	0-N084	8647 10003	SK-1045	8647 13023	SK-1289	8647 18003	SK-1444
8646 50204	0-N070	8647 10004	SK-1011	8647 13027	SK-1682	8647 21001	SK-1273
8646 50206	0-N081	8647 10006	SK-1019	8647 14001	SK-1286	8647 21002	SK-1183
8646 50209	0-N1578	8647 10007	SK-1017	8647 14006	SK-1097	8647 21005	SK-1685
8646 60102	0-N047	8647 10008	SK-1225	8647 150007	SK-1676AQ1	8647 240002	SK-1073AQ3
8646 60202	0-N046	8647 10010	SK-1035	8647 150008	SK-1610AQ1	8647 240003	SK-1073AQ2
8646 66101	0-N859	8647 10011	SK-1046	8647 15001	SK-1665	8647 240004	SK-1113AQ1
8646 68103	0-N1223	8647 10012	SK-1036	8647 15002	SK-1031	8647 240005	SK-1113AQ2
8646 68201	0-N1225	8647 10015	SK-1034	8647 15003	SK-1033	8647 24001	SK-1037
8646 68202	0-N1226	8647 10018	SK-1042	8647 15004	SK-1065	8647 240010	SK-1073AQ1
8646 69101	0-N018	8647 10019	SK-1082	8647 15005	SK-1043	8647 240011	SK-1169AQ1
8646 69103	0-N020	8647 10021	SK-1153	8647 15006	SK-1361	8647 24005	SK-1054
8646 69104	0-N916	8647 10023	SK-1085	8647 15007	SK-1345	8647 24006	SK-1168
8646 69105	0-N019	8647 10026	SK-1657	8647 15008	SK-1076	8647 24007	SK-1164
8646 70101	0-N912	8647 10031	SK-1144	8647 15009	SK-1112	8647 24008	SK-1163
864610107	0-N870	8647 10033	SK-1079	8647 15012	SK-1080	8647 24009	SK-1162
864613109	0-N995	8647 10038	SK-1642	8647 15012	SK-1646	8647 24010	SK-1169
864613116	0-N000	8647 10042	SK-1325	8647 15016	SK-1418	8647 24011	SK-1038
864613201	0-N991	8647 10045	SK-1236	8647 15017	SK-1415	8647 24012	SK-1165
864615112	0-N113	8647 10046	SK-1527	8647 15019	SK-1410	8647 24013	SK-1073
864615208	0-N889	8647 10049	SK-1526	8647 15020	SK-1412	8647 24014	SK-1100
864615216	0-N951	8647 10050	SK-1594	8647 15024	SK-1367	8647 24015	SK-1508
864616104	0-N838	8647 100504	SK-1714AQ1	8647 15028	SK-1629	8647 24016	SK-1113
864624202	0-N875	8647 10051	SK-1622	8647 15029	SK-1080	8647 24019	SK-1166
864625104	0-N880	8647 10052	SK-1306	8647 15032	SK-1610	8647 24024	SK-1481
864629111	0-N921	8647 10053	SK-1586	8647 15033	SK-1421	8647 24029	SK-1478
864629116	0-N108	8647 10054	SK-1483	8647 15038	SK-1587	8647 24029	SK-1632
864629121	0-N111	8647 10067	SK-1077	8647 15040	SK-1023	8647 24030	SK-1612
864629122	0-N158	8647 10069	SK-1519	8647 15041	SK-1676	8647 24031	SK-1481
864629124	0-N105	8647 10070	SK-1680	8647 15042	SK-1755	8647 250002	SK-1081AQ2
864629130	0-N1263	8647 10071	SK-1750	8647 15044	SK-1756	8647 250004	SK-1088AQ1
864629207	0-N1262	8647 10075	SK-1696	8647 15045	SK-1693	8647 250006	SK-1487AQ1
864629212	0-N165	8647 10079	SK-1714	8647 15046	SK-1112	8647 250010	SK-1088AQ1



TRISCAN

8647 250011	SK-1630AQ1
8647 25003	SK-1081
8647 25018	SK-1091
8647 25019	SK-1092
8647 25026	SK-1088
8647 25027	SK-1625
8647 25031	SK-1486
8647 25034	SK-1631
8647 25036	SK-1630
8647 25039	SK-1698
8647 25041	SK-1088
8647 25042	SK-1630
8647 250501	SK-1081AQ3
8647 270001	SK-1492AQ1
8647 27001	SK-1061
8647 27002	SK-1174
8647 27005	SK-1270
8647 27007	SK-1608
8647 27010	SK-1618
8647 27014	SK-1531
8647 280006	SK-1020AQ1
8647 280009	SK-1598AQ1
8647 28001	SK-1006
8647 280011	SK-1082AQ1
8647 280012	SK-1082AQ2
8647 280013	SK-1399AQ1
8647 280014	SK-1600AQ1
8647 28002	SK-1003
8647 28004	SK-1157
8647 28006	SK-1158
8647 28011	SK-1005
8647 28012	SK-1016
8647 28014	SK-1085
8647 28019	SK-1353
8647 28025	SK-1598
8647 28026	SK-1596
8647 28030	SK-1617
8647 28031	SK-1600
8647 28033	SK-1681
8647 290010	SK-1372AQ2
8647 290012	SK-1372AQ1
8647 290013	SK-1592AQ1
8647 290016	SK-1668AQ1
8647 290023	SK-1337AQ1
8647 290024	SK-1724AQ2
8647 290025	SK-1599AQ1
8647 290026	SK-1582AQ1
8647 290027	SK-1583AQ1
8647 290028	SK-1724AQ1
8647 290029	SK-1686AQ1

TRISCAN

8647 29003	SK-1001
8647 290031	SK-1619AQ2
8647 290032	SK-1621AQ1
8647 290034	SK-1539AQ1
8647 29004	SK-1047
8647 290040	SK-1603AQ1
8647 29005	SK-1029
8647 29006	SK-1122
8647 29007	SK-1069
8647 29008	SK-1098
8647 29009	SK-1120
8647 29010	SK-1119
8647 29011	SK-1261
8647 29013	SK-1123
8647 29014	SK-1104
8647 29015	SK-1090
8647 29016	SK-1101
8647 29017	SK-1344
8647 29018	SK-1131
8647 29019	SK-1074
8647 29021	SK-1106
8647 29024	SK-1640
8647 29026	SK-1110
8647 29037	SK-1582
8647 29038	SK-1583
8647 29039	SK-1388
8647 29044	SK-1633
8647 29045	SK-1619
8647 29048	SK-1372
8647 29049	SK-1376
8647 29053	SK-1592
8647 29057	SK-1425
8647 29058	SK-1593
8647 29060	SK-1121
8647 29063	SK-1648
8647 29065	SK-1383
8647 29066	SK-1388
8647 29067	SK-1378
8647 29069	SK-1386
8647 29070	SK-1688
8647 29075	SK-1606
8647 29076	SK-1259
8647 29079	SK-1538
8647 29081	SK-1635
8647 29082	SK-1597
8647 29084	SK-1595
8647 29087	SK-1709
8647 29088	SK-1710
8647 29090	SK-1688
8647 29094	SK-1661

TRISCAN

8647 29095	SK-1695
8647 29096	SK-1727
8647 29097	SK-1724
8647 400001	SK-1277AQ1
8647 40001	SK-1066
8647 40005	SK-1277
8647 40006	SK-1218
8647 40009	SK-1436
8647 40013	SK-1590
8647 42001	SK-1312
8647 42010	SK-1316
8647 42011	SK-1463
8647 42013	SK-1469
8647 42015	SK-1458
8647 42017	SK-1460
8647 42019	SK-1735
8647 42020	SK-1737
8647 42021	SK-1753
8647 420500	SK-1458AQ1
8647 43002	SK-1634
8647 43003	SK-1320
8647 43005	SK-1654
8647 43010	SK-1656
8647 43013	SK-1653
8647 43015	SK-1739
8647 43016	SK-1740
8647 430502	SK-1634AQ1
8647 500001	SK-1678AQ1
8647 500002	SK-1674AQ1
8647 50001	SK-1226
8647 50002	SK-1224
8647 50003	SK-1227
8647 50005	SK-1222
8647 50009	SK-1233
8647 50010	SK-1627
8647 50012	SK-1453
8647 50014	SK-1751
8647 50018	SK-1674
8647 50019	SK-1671
8647 500500	SK-1741AQ1
8647 68002	SK-1712
8647 68004	SK-1719
8647 69001	SK-1248
8647 69002	SK-1245
8647 70001	SK-1185
8647 80004	SK-1673
8647 80006	SK-1734
8710 23400	0-N1926



			
0-N000	0-N001	0-N005	0-N006
			
0-N007	0-N008	0-N013	0-N014
			
0-N017	0-N018	0-N019	0-N020
			
0-N021	0-N022	0-N024	0-N025
			
0-N027	0-N028	0-N029	0-N030
			
0-N031	0-N032	0-N033	0-N034

			
0-N035	0-N036	0-N037	0-N038
			
0-N039	0-N040	0-N041	0-N042
			
0-N043	0-N045	0-N046	0-N047
			
0-N048	0-N049	0-N050	0-N051
			
0-N052	0-N053	0-N054	0-N055
			
0-N056	0-N058	0-N059	0-N060



0-N061



0-N062



0-N063



0-N064



0-N065



0-N066



0-N067



0-N068



0-N069



0-N070



0-N071



0-N072



0-N073



0-N074



0-N075



0-N076



0-N077



0-N078



0-N079



0-N080



0-N081



0-N082



0-N083



0-N084

0-N085	0-N086	0-N087	0-N088
0-N089	0-N090	0-N091	0-N092
0-N094	0-N095	0-N096	0-N100
0-N101	0-N102	0-N103	0-N104
0-N105	0-N106	0-N107	0-N108
0-N109	0-N110	0-N111	0-N112



0-N113



0-N114



0-N115



0-N116



0-N117



0-N118P



0-N119P



0-N121



0-N122



0-N123



0-N124



0-N125



0-N125S



0-N126



0-N127



0-N128



0-N129



0-N130



0-N130S



0-N131



0-N132



0-N133



0-N134



0-N135

			
0-N137	0-N138	0-N139	0-N141
			
0-N143	0-N144	0-N145	0-N146
			
0-N147	0-N148	0-N149	0-N150
			
0-N151	0-N152	0-N152S	0-N155
			
0-N156	0-N157	0-N158	0-N159
			
0-N160	0-N162	0-N163	0-N164



0-N165



0-N166



0-N167



0-N168



0-N169



0-N170



0-N171



0-N172



0-N173



0-N174



0-N176



0-N178



0-N179



0-N180



0-N181



0-N182



0-N183



0-N184



0-N185



0-N186



0-N187



0-N188



0-N189



0-N191

			
0-N192	0-N193	0-N194	0-N195
			
0-N196	0-N197	0-N198	0-N199
			
0-N200	0-N201	0-N208	0-N214
			
0-N215	0-N236	0-N237	0-N262
			
0-N277	0-N290	0-N291	0-N292
			
0-N293	0-N294	0-N295	0-N300



0-N800



0-N801



0-N805



0-N806



0-N807



0-N808



0-N809



0-N811



0-N812



0-N813



0-N814



0-N815



0-N816



0-N818



0-N819



0-N820



0-N821



0-N822



0-N823



0-N826



0-N832



0-N835



0-N837



0-N838

0-N839	0-N842	0-N846	0-N847
0-N849	0-N850	0-N854	0-N856
0-N857	0-N859	0-N860	0-N861
0-N862	0-N863	0-N866	0-N867
0-N869	0-N870	0-N871	0-N874
0-N875	0-N876	0-N877	0-N878



0-N879



0-N880



0-N881



0-N882



0-N883



0-N887



0-N889



0-N891



0-N892



0-N894



0-N897



0-N898



0-N899



0-N900



0-N901



0-N902



0-N903



0-N904



0-N905



0-N906



0-N907



0-N909



0-N910



0-N911

			
0-N912	0-N913	0-N915	0-N916
			
0-N917	0-N919	0-N920	0-N921
			
0-N922	0-N923	0-N924	0-N925
			
0-N926	0-N927	0-N928	0-N930
			
0-N931	0-N937	0-N938	0-N939
			
0-N940	0-N941	0-N943	0-N944



			
0-N945	0-N948	0-N949	0-N950
			
0-N951	0-N952	0-N953	0-N954
			
0-N955	0-N956	0-N957	0-N958
			
0-N959	0-N960	0-N964	0-N965
			
0-N968	0-N969	0-N970	0-N971
			
0-N973	0-N974	0-N975	0-N978

0-N979	0-N981	0-N982	0-N983
0-N985	0-N986	0-N987	0-N988
0-N989	0-N990	0-N991	0-N992
0-N993	0-N994	0-N995	0-N996
0-N997	0-N998	0-N999	0-N1005
0-N1011S	0-N1011	0-N1013S	0-N1013



0-N1041S



0-N1041



0-N1042

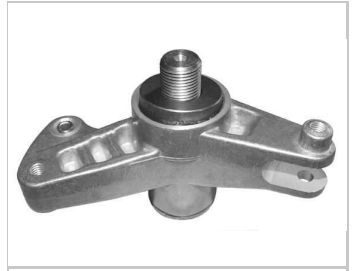

0-N1043



0-N1045



0-N1046



0-N1048

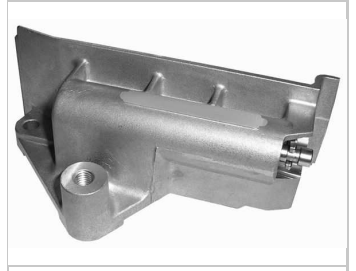

0-N1049



0-N1050



0-N1051



0-N1051S



0-N1052



0-N1053



0-N1054



0-N1056



0-N1057



0-N1058



0-N1060



0-N1061



0-N1062



0-N1065



0-N1066



0-N1071



0-N1083S

0-N1083	0-N1085	0-N1092	0-N1093
0-N1106	0-N1111	0-N1112	0-N1120
0-N1121	0-N1122	0-N1127	0-N1129
0-N1130	0-N1173	0-N1214	0-N1216
0-N1218	0-N1219	0-N1220	0-N1222
0-N1223	0-N1225	0-N1226	0-N1229



			
0-N1230	0-N1231	0-N1232	0-N1236
			
0-N1237	0-N1238	0-N1239	0-N1243
			
0-N1244	0-N1246	0-N1248	0-N1250
			
0-N1256	0-N1258	0-N1259	0-N1260
			
0-N1261	0-N1262	0-N1263	0-N1265
			
0-N1266	0-N1268	0-N1269	0-N1270

			
0-N1272	0-N1273	0-N1274	0-N1275
			
0-N1276	0-N1277	0-N1278	0-N1279
			
0-N1280	0-N1281	0-N1282	0-N1283
			
0-N1284	0-N1285	0-N1286	0-N1287
			
0-N1288	0-N1289	0-N1290S	0-N1290
			
0-N1291S	0-N1291	0-N1292	0-N1293



			
0-N1294S	0-N1294	0-N1295	0-N1295S
			
0-N1296	0-N1297	0-N1298	0-N1299
			
0-N1299S	0-N1300	0-N1300S	0-N1301
			
0-N1303	0-N1304	0-N1305	0-N1306
			
0-N1307	0-N1308	0-N1309	0-N1310
			
0-N1311	0-N1312	0-N1313	0-N1314

0-N1315	0-N1316	0-N1317	0-N1317S
0-N1320	0-N1322	0-N1322S	0-N1323
0-N1324	0-N1326	0-N1327	0-N1328
0-N1329	0-N1330	0-N1331	0-N1332
0-N1334	0-N1335	0-N1336	0-N1337
0-N1338	0-N1339	0-N1339S	0-N1340



0-N1341	0-N1342	0-N1343	0-N1344
0-N1346	0-N1347	0-N1348	0-N1349
0-N1350	0-N1351	0-N1352	0-N1353
0-N1354	0-N1355	0-N1356	0-N1357
0-N1358	0-N1359	0-N1360	0-N1361
0-N1362	0-N1363	0-N1364	0-N1365

0-N1366	0-N1367	0-N1368	0-N1369
0-N1370	0-N1371	0-N1372	0-N1373
0-N1374	0-N1375	0-N1376	0-N1377
0-N1378	0-N1379	0-N1380	0-N1381
0-N1382	0-N1383	0-N1385	0-N1386
0-N1387	0-N1388	0-N1389	0-N1390



			
0-N1390S	0-N1391	0-N1391S	0-N1392
			
0-N1393	0-N1394	0-N1395	0-N1396
			
0-N1397	0-N1398	0-N1399	0-N1400
			
0-N1400S	0-N1401	0-N1402S	0-N1402
			
0-N1403	0-N1404	0-N1405	0-N1406
			
0-N1407	0-N1407S	0-N1408	0-N1409

0-N1410	0-N1410S	0-N1411	0-N1412
0-N1413	0-N1414	0-N1415	0-N1416
0-N1417	0-N1418	0-N1419	0-N1420
0-N1421	0-N1422	0-N1422S	0-N1423
0-N1424	0-N1425	0-N1426	0-N1427
0-N1427S	0-N1428	0-N1429	0-N1430



0-N1431



0-N1432S



0-N1432



0-N1433S



0-N1433



0-N1434



0-N1434S



0-N1435



0-N1435S



0-N1436



0-N1436S



0-N1437



0-N1438



0-N1438S



0-N1439



0-N1441



0-N1441S



0-N1442



0-N1443



0-N1443S



0-N1444



0-N1445



0-N1445S



0-N1446

0-N1447S	0-N1448	0-N1449	0-N1450
0-N1451	0-N1452	0-N1453	0-N1454
0-N1455	0-N1456	0-N1457	0-N1458
0-N1459	0-N1459S	0-N1460	0-N1461
0-N1462	0-N1462S	0-N1463S	0-N1464
0-N1464S	0-N1465S	0-N1466	0-N1466S



0-N1467S



0-N1469



0-N1470



0-N1470S



0-N1471



0-N1471S



0-N1472



0-N1472S



0-N1473



0-N1473S



0-N1474



0-N1475S



0-N1476



0-N1476S



0-N1477S



0-N1477



0-N1478S



0-N1479S



0-N1480S



0-N1481



0-N1481S



0-N1482S



0-N1483S



0-N1484S



0-N1484



0-N1485S



0-N1485



0-N1486



0-N1486S



0-N1487



0-N1487S



0-N1488



0-N1488S



0-N1489S



0-N1490S



0-N1491S



0-N1492



0-N1492S



0-N1493S



0-N1493



0-N1494



0-N1494S



0-N1495S



0-N1496S



0-N1497



0-N1497S



0-N1498



0-N1499S



0-N1499



0-N1500



0-N1501S



0-N1501



0-N1502



0-N1502S



0-N1503



0-N1503S



0-N1505S



0-N1506S



0-N1506



0-N1507S



0-N1507



0-N1508S



0-N1508



0-N1509S



0-N1509



0-N1510



0-N1510S



0-N1511



0-N1512



0-N1512S



0-N1513



0-N1513S

0-N1514S	0-N1514	0-N1515S	0-N1515
0-N1516	0-N1516S	0-N1517	0-N1517S
0-N1518	0-N1518S	0-N1519S	0-N1520
0-N1520S	0-N1521	0-N1522	0-N1523
0-N1524	0-N1525	0-N1525S	0-N1526S
0-N1526	0-N1527	0-N1527S	0-N1528



0-N1528S



0-N1529



0-N1529S

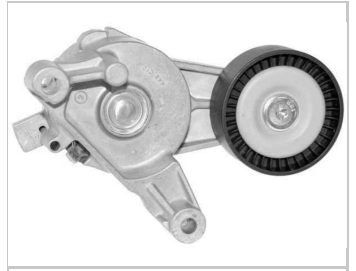

0-N1530



0-N1530S

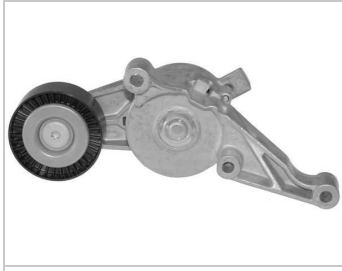

0-N1531



0-N1531S



0-N1532S



0-N1532



0-N1533



0-N1533S



0-N1534



0-N1534S



0-N1535



0-N1535S



0-N1536S



0-N1536

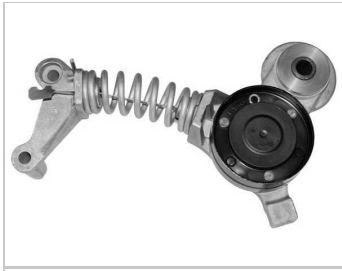

0-N1537



0-N1537S



0-N1538



0-N1538S



0-N1539



0-N1539S



0-N1540

0-N1541	0-N1542S	0-N1543	0-N1544
0-N1545	0-N1546	0-N1547	0-N1549
0-N1550	0-N1551	0-N1551S	0-N1552
0-N1552S	0-N1553	0-N1554S	0-N1555S
0-N1555	0-N1556S	0-N1557S	0-N1558S
0-N1559S	0-N1560	0-N1561	0-N1562



0-N1563



0-N1564



0-N1566



0-N1567



0-N1568



0-N1569



0-N1570



0-N1571



0-N1572



0-N1573



0-N1574



0-N1575



0-N1576



0-N1577



0-N1578



0-N1579



0-N1580



0-N1581



0-N1582



0-N1583



0-N1584



0-N1585



0-N1585S



0-N1586

			
0-N1587S	0-N1587	0-N1588	0-N1588S
			
0-N1589	0-N1590	0-N1591	0-N1592
			
0-N1593	0-N1593S	0-N1594	0-N1595
			
0-N1595S	0-N1596	0-N1597	0-N1598
			
0-N1599S	0-N1599	0-N1600	0-N1601S
			
0-N1601	0-N1602	0-N1603	0-N1604



0-N1605



0-N1606



0-N1606S



0-N1609

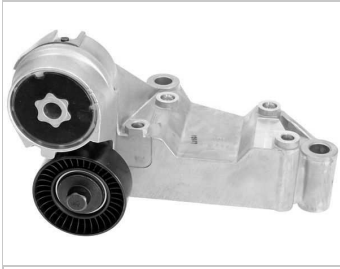

0-N1610



0-N1611S



0-N1611



0-N1612



0-N1613



0-N1614



0-N1615



0-N1616



0-N1617



0-N1618



0-N1619



0-N1620S



0-N1620



0-N1621S



0-N1621



0-N1622



0-N1623



0-N1624



0-N1624S



0-N1625

0-N1625S	0-N1626	0-N1626S	0-N1627
0-N1627S	0-N1628	0-N1629	0-N1630
0-N1632	0-N1633	0-N1634	0-N1635
0-N1636S	0-N1636	0-N1637	0-N1638
0-N1639	0-N1639S	0-N1640	0-N1640S
0-N1641	0-N1641S	0-N1642	0-N1643



0-N1643S



0-N1644



0-N1645S



0-N1645



0-N1646



0-N1647



0-N1648



0-N1649



0-N1650



0-N1651S



0-N1651



0-N1652



0-N1653S



0-N1654



0-N1656



0-N1656S



0-N1657S



0-N1657



0-N1658



0-N1659S



0-N1659



0-N1660



0-N1661



0-N1662

			
0-N1663	0-N1663S	0-N1664	0-N1664S
			
0-N1665	0-N1666	0-N1667	0-N1668
			
0-N1668S	0-N1669S	0-N1669	0-N1670
			
0-N1670S	0-N1671	0-N1671S	0-N1672
			
0-N1673S	0-N1673	0-N1675	0-N1676
			
0-N1676S	0-N1677S	0-N1677	0-N1678

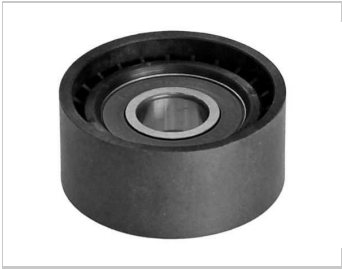

0-N1680



0-N1681



0-N1682



0-N1683



0-N1684



0-N1685



0-N1686



0-N1687



0-N1688



0-N1689



0-N1690



0-N1691



0-N1692



0-N1693



0-N1694



0-N1695



0-N1696



0-N1697



0-N1697S



0-N1698



0-N1698S



0-N1699



0-N1699S



0-N1701

			
0-N1702	0-N1703	0-N1704	0-N1704S
			
0-N1709	0-N1709S1	0-N1709S2	0-N1710
			
0-N1710S	0-N1711S	0-N1712	0-N1713
			
0-N1714	0-N1714S	0-N1715	0-N1716
			
0-N1717	0-N1717S	0-N1718	0-N1719
			
0-N1719S	0-N1720	0-N1720S	0-N1721



0-N1722



0-N1723



0-N1724



0-N1725



0-N1726



0-N1728



0-N1729



0-N1730



0-N1731



0-N1731S



0-N1732



0-N1732S



0-N1733



0-N1733S



0-N1734



0-N1735



0-N1736



0-N1738



0-N1739



0-N1740



0-N1741



0-N1741S



0-N1742



0-N1742S

			
0-N1743	0-N1744	0-N1746	0-N1747
			
0-N1748	0-N1749	0-N1749S	0-N1750
			
0-N1751	0-N1752	0-N1753	0-N1754
			
0-N1755	0-N1756	0-N1757	0-N1758
			
0-N1759	0-N1760	0-N1761	0-N1762
			
0-N1763	0-N1764	0-N1765S	0-N1765



			
0-N1767	0-N1768	0-N1771	0-N1772
			
0-N1773	0-N1774	0-N1775	0-N1776
			
0-N1777	0-N1778	0-N1779	0-N1781
			
0-N1782	0-N1783	0-N1786	0-N1787
			
0-N1788	0-N1788S	0-N1790	0-N1791
			
0-N1791S	0-N1792	0-N1793S	0-N1793

			
0-N1794	0-N1794S	0-N1795	0-N1796
			
0-N1797	0-N1797S	0-N1798S	0-N1798
			
0-N1799S	0-N1799	0-N1800	0-N1801
			
0-N1802S	0-N1802	0-N1803	0-N1804S
			
0-N1804	0-N1805S	0-N1805	0-N1806
			
0-N1807	0-N1808S	0-N1808	0-N1809



			
0-N1809S	0-N1810S	0-N1810	0-N1811
			
0-N1811S	0-N1812	0-N1812S	0-N1813
			
0-N1813S	0-N1814	0-N1815	0-N1815S
			
0-N1816	0-N1817	0-N1818	0-N1819
			
0-N1820	0-N1821	0-N1822S	0-N1822
			
0-N1823	0-N1824	0-N1825	0-N1826

0-N1827	0-N1828	0-N1829	0-N1830
0-N1830S	0-N1832	0-N1832S	0-N1833
0-N1834S	0-N1834	0-N1835	0-N1836
0-N1838S	0-N1839S	0-N1839	0-N1840
0-N1840S	0-N1841	0-N1842	0-N1842S
0-N1845	0-N1846	0-N1846S	0-N1848



0-N1848S



0-N1849S



0-N1850



0-N1850S



0-N1851S



0-N1851



0-N1852



0-N1854



0-N1855



0-N1855S



0-N1856



0-N1856S



0-N1857S



0-N1857



0-N1858



0-N1858S



0-N1859



0-N1860



0-N1861



0-N1862



0-N1864



0-N1866



0-N1869



0-N1871

0-N1874	0-N1874S	0-N1875	0-N1875S
0-N1876	0-N1876S	0-N1877	0-N1877S
0-N1878	0-N1879	0-N1880S	0-N1880
0-N1883	0-N1883S	0-N1884	0-N1885S2
0-N1885S1	0-N1885	0-N1886S1	0-N1886S2
0-N1886	0-N1890	0-N1890S	0-N1891



0-N1892



0-N1892S



0-N1893S



0-N1893



0-N1894



0-N1895



0-N1895S



0-N1896S



0-N1896



0-N1897



0-N1898S



0-N1898



0-N1899



0-N1900



0-N1902S



0-N1902



0-N1903



0-N1904



0-N1905



0-N1906



0-N1907



0-N1908S



0-N1908



0-N1909

0-N1911	0-N1912	0-N1912S	0-N1913S
0-N1913	0-N1914	0-N1915	0-N1916
0-N1917	0-N1918	0-N1919	0-N1919S
0-N1920	0-N1922	0-N1923	0-N1924
0-N1925	0-N1926	0-N1927	0-N1928
0-N1932	0-N1936	0-N1938	0-N1940



0-N1940S



0-N1941S3



0-N1941S2



0-N1941S1

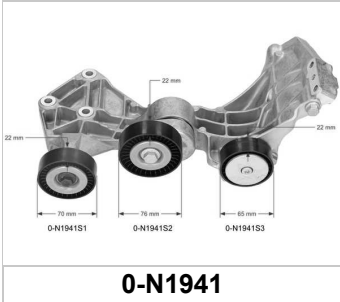

0-N1941



0-N1942



0-N1943



0-N1944



0-N1945



0-N1945S



0-N1946S2



0-N1946S1

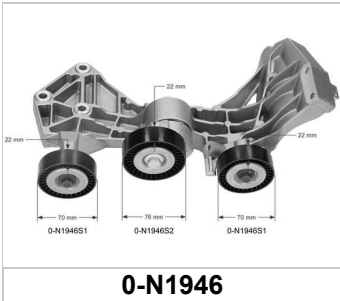

0-N1946



0-N1947



0-N1948



0-N1949



0-N1950



0-N1951



0-N1952



0-N1953S



0-N1953



0-N1954S



0-N1954



0-N1955S

0-N1955	0-N1956S	0-N1956	0-N1957
0-N1957S	0-N1958S	0-N1958	0-N1959
0-N1960	0-N1961	0-N1962	0-N1963
0-N1964	0-N1965	0-N1966	0-N1967
0-N1968	0-N1969	0-N1971	0-N1972
0-N1973	0-N1974	0-N1975	0-N1976



			
0-N1978	0-N1979	0-N1981	0-N1982
			
0-N1983	0-N1984	0-N1986	0-N1987
			
0-N1988	0-N1990	0-N1991	0-N2000
			
0-N2001	0-N2010	0-N2012	0-N2013
			
0-N2014	0-N2014S	0-N2015	0-N2016
			
0-N2017S	0-N2017	0-N2018	0-N2019



0-N2020



0-N2021



0-N2022



0-N2022S



0-N2023



0-N2024



0-N2025



0-N2026



0-N2026S



0-N2027



0-N2028



0-N2029



0-N2029S



0-N2030



0-N2030S



0-N2031



0-N2032



0-N2033



0-N2034S



0-N2034



0-N2035



0-N2035S



0-N2036



0-N2037



			
0-N2037S	0-N2038	0-N2038S	0-N2039
			
0-N2039S	0-N2040	0-N2041	0-N2042
			
0-N2042S	0-N2043	0-N2044	0-N2045S
			
0-N2045	0-N2046	0-N2046S	0-N2047
			
0-N2048	0-N2049	0-N2050	0-N2051
			
0-N2052	0-N2053	0-N2053S	0-N2054



0-N2055



0-N2055S



0-N2056



0-N2057



0-N2058



0-N2060



0-N2061



0-N2062



0-N2063



0-N2064



0-N2065S



0-N2065



0-N2066



0-N2067



0-N2068



0-N2069



0-N2070



0-N2071



0-N2072



0-N2073



0-N2074S



0-N2074



0-N2075



0-N2076



0-N2076S



0-N2077



0-N2078



0-N2079



0-N2080



0-N2081



0-N2081S



0-N2082



0-N2082S



0-N2083S



0-N2083



0-N2084S



0-N2084



0-N2085



0-N2085S



0-N2086



0-N2086S



0-N2087S



0-N2087



0-N2088



0-N2089S



0-N2089



0-N2090



0-N2091

0-N2091S	0-N2092S	0-N2092	0-N2093S
0-N2093	0-N2094	0-N2095	0-N2095S
0-N2095S1	0-N2096	0-N2096S	0-N2097
0-N2098	0-N2098S	0-N2099	0-N2100
0-N2101	0-N2102	0-N2103S	0-N2103
0-N2104	0-N2104S	0-N2105	0-N2105S



0-N2106



0-N2107



0-N2107S



0-N2108S



0-N2108



0-N2109



0-N2109S



0-N2110



0-N2111S



0-N2111



0-N2112S



0-N2112



0-N2113



0-N2113S



0-N2114



0-N2114S



0-N2115S



0-N2115



0-N2116



0-N2116S



0-N2117



0-N2117S



0-N2118



0-N2119

0-N2120	0-N2121	0-N2122	0-N2123
0-N2124	0-N2124S	0-N2125	0-N2126
0-N2127	0-N2128	0-N2129	0-N2130
0-N2131	0-N2132	0-N2133	0-N2134
0-N2135	0-N2136	0-N2136S	0-N2137
0-N2137S	0-N2138	0-N2139	0-N2140



0-N2141



0-N2142



0-N2143



0-N2144



0-N2145



0-N2146



0-N2147



0-N2148



0-N2149



0-N2150



0-N2151



0-N2151S



0-N2152



0-N2153



0-N2154



0-N2155S



0-N2155



0-N2156



0-N2157



0-N2158



0-N2158S



0-N2159



0-N2160



0-N2161S

			
0-N2161	0-N2162	0-N2163	0-N2164
			
0-N2165	0-N2167	0-N2168	0-N2169
			
0-N2170	0-N2170S	0-N2171	0-N2172
			
0-N2172S	0-N2173	0-N2174	0-N2175
			
0-N2176	0-N2177	0-N2178	0-N2179
			
0-N2180	0-N2181	0-N2182	0-N2183



0-N2184



0-N2184S



0-N2185



0-N2186



0-N2187



0-N2188



0-N2188S



0-N2189S



0-N2190S



0-N2190



0-N2191



0-N2192



0-N2193



0-N2193S



0-N2194



0-N2194S



0-N2195



0-N2196



0-N2197



0-N2197S



0-N2198



0-N2198S



0-N2199



0-N2200

0-N2201	0-N2202	0-N2202S	0-N2203
0-N2203S	0-N2204S	0-N2204	0-N2205
0-N2206	0-N2207	0-N2208	0-N2209
0-N2209S	0-N2210S	0-N2210	0-N2211S
0-N2211	0-N2212	0-N2212S	0-N2213
0-N2213S	0-N2214S	0-N2214	0-N2215



0-N2215S



0-N2216



0-N2216S1



0-N2216S2



0-N2217S2



0-N2217

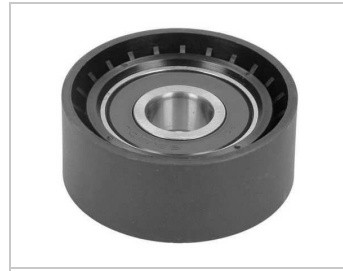

0-N2217S1



0-N2218



0-N2219



0-N2219S



0-N2220



0-N2220S



0-N2221



0-N2222



0-N2223



0-N2224



0-N2225



0-N2226



0-N2226S



0-N2227



0-N2228



0-N2229



0-N2230



0-N2231S



0-N2231



0-N2232



0-N2232S



0-N2233



0-N2234



0-N2236



0-N2237



0-N2238



0-N2239



0-N2240



0-N2241



0-N2241S



0-N2242S



0-N2242



0-N2243



0-N2244

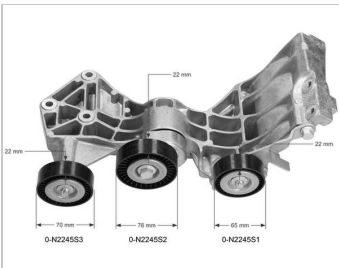

0-N2245



0-N2245S1



0-N2245S2



0-N2245S3



0-N2246S1



0-N2246S2

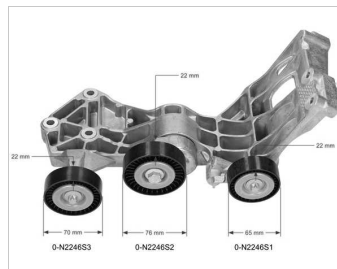

0-N2246



0-N2246S3



0-N2247



0-N2248



0-N2249



0-N2250



0-N2252S



0-N2252



0-N2253



0-N2254



0-N2255



0-N2256



0-N2257



0-N2257S1



0-N2257S2



0-N2258



0-N2259



0-N2260



0-N2261



0-N2261S



0-N2263

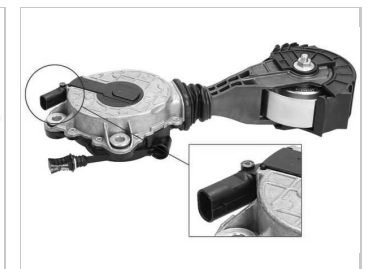

0-N2264



0-N2265



0-N2265S

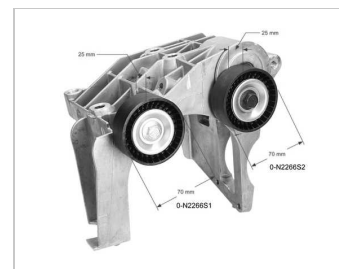

0-N2266



0-N2266S1

0-N2266S2	0-N2267	0-N2267S	0-N2268S
0-N2268	0-N2269	0-N2269S	0-N2270
0-N2270S	0-N2272	0-N2276	0-N2278
0-N2279	0-N2279S	0-N2280	0-N2280S
0-N2281	0-N2281S	0-N2282	0-N2284
0-N2285	0-N2286	0-N2287	0-N2287S



0-N2288



0-N2288S



0-N2289



0-N2290



0-N2290S



0-N2293



0-N2293S



0-N2294



0-N2295



0-N2297



0-N2299S

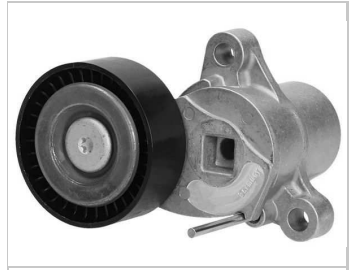

0-N2300



0-N2300S



0-N2301S



0-N2302S



0-N2303



0-N2304



0-N2305



0-N2306S



0-N2306



0-N2307



0-N2308



0-N2308S



0-N2309



0-N2309S



0-N2310



0-N2311



0-N2314



0-N2319



0-N2320



0-N2322



0-N2326



0-N2333



0-N2339



0-N2340



0-N2341



0-N2343



0-N2344



0-N2346



0-N2350



0-N2353



0-N2354



0-N2357



0-N2364



0-N2367



0-N2368



0-N2369



0-N2372



0-N2373



0-N2375



0-N2377



0-N2380



0-N2381



0-N2382



0-N2384



0-N2385



0-N2386



0-N2388S



0-N2389S



0-N2390S



0-N2391S



0-N2393S



0-N2395S



0-N2396S



0-N2397S



0-N2400S



0-N2401S1



0-N2402S



0-N2403S



0-N2404S



0-N2405S



0-N2406S

0-N2407S	0-N2409	0-N2410	0-N2413
0-N2415	0-N2416	0-N2419	0-N2420
0-N2421	0-N2422S	0-N2427S	0-N2428
0-N565592	SK-1001	SK-1003	SK-1003AQ1
SK-1004	SK-1004AQ1	SK-1005	SK-1006
SK-1007	SK-1007AQ1	SK-1010	SK-1011



SK-1012

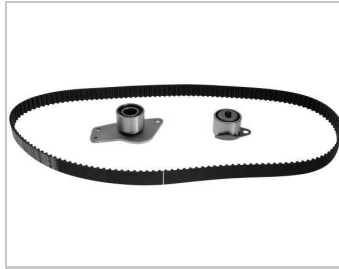

SK-1013

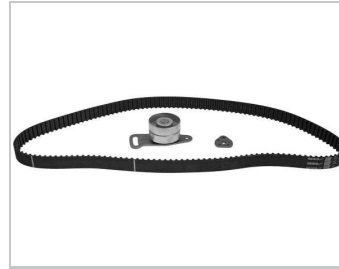

SK-1014

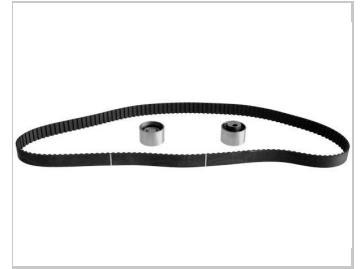

SK-1015

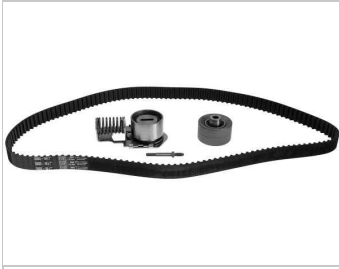

SK-1016

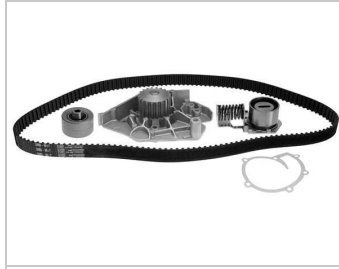

SK-1017AQ1



SK-1017



SK-1018S



SK-1019

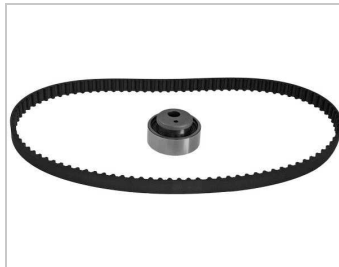

SK-1020



SK-1021



SK-1021AQ1



SK-1021AQ2



SK-1022AQ2

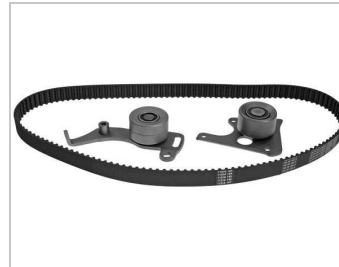

SK-1022



SK-1022AQ1



SK-1023



SK-1024



SK-1026



SK-1027



SK-1029



SK-1031



SK-1032



SK-1033

SK-1034	SK-1035	SK-1036	SK-1037
SK-1037AQ1	SK-1038	SK-1039	SK-1040
SK-1040AQ1	SK-1041	SK-1042	SK-1043
SK-1043AQ1	SK-1045	SK-1046	SK-1047
SK-1049	SK-1050	SK-1052	SK-1053
SK-1053AQ1	SK-1054	SK-1056	SK-1059

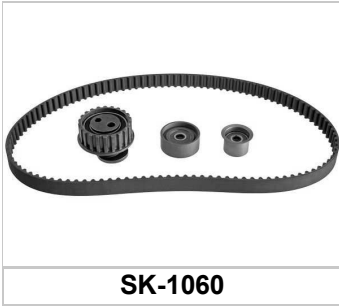

SK-1060



SK-1061

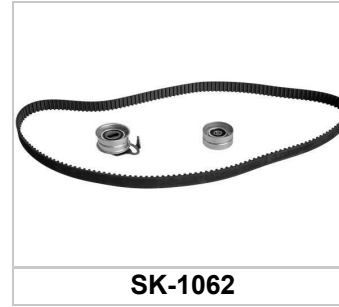

SK-1062

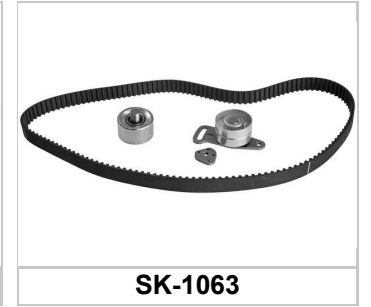

SK-1063



SK-1064



SK-1065

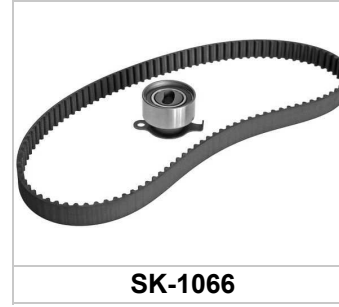

SK-1066

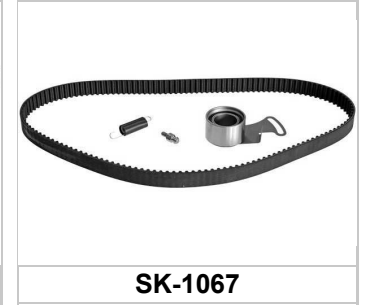

SK-1067



SK-1068

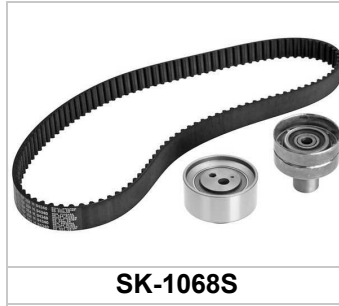

SK-1068S



SK-1069

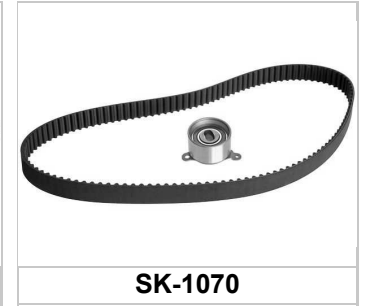

SK-1070

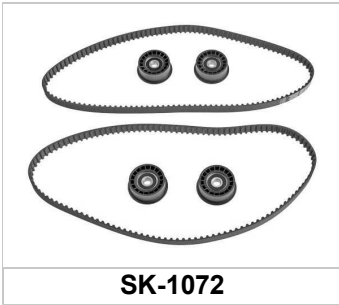

SK-1072



SK-1073AQ1



SK-1073AQ2

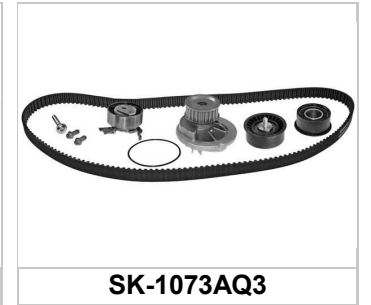

SK-1073AQ3

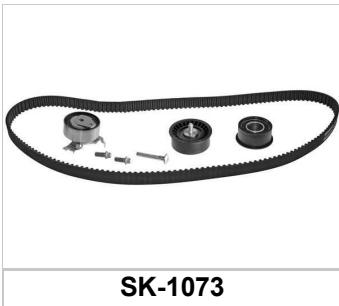

SK-1073

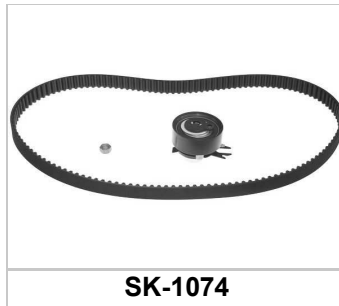

SK-1074



SK-1074AQ1



SK-1075

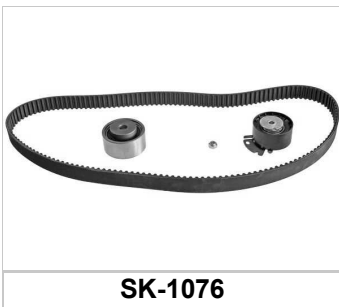

SK-1076



SK-1077



SK-1077AQ1



SK-1078AQ1

SK-1078AQ2	SK-1078AQ3	SK-1078	SK-1079
SK-1080	SK-1081	SK-1081AQ2	SK-1082
SK-1083	SK-1084	SK-1085	SK-1085AQ1
SK-1086	SK-1086AQ1	SK-1087	SK-1088
SK-1088AQ1	SK-1089	SK-1090	SK-1091
SK-1092	SK-1093	SK-1094	SK-1094AQ1



SK-1095



SK-1096

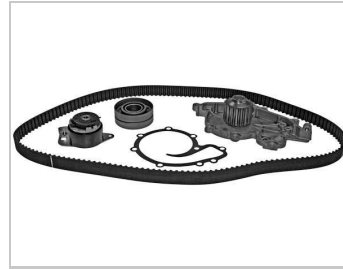

SK-1096AQ1



SK-1097



SK-1098



SK-1099

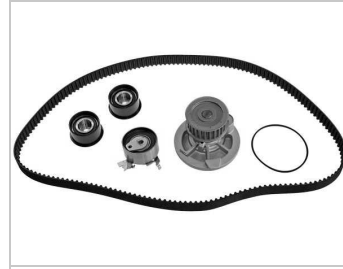

SK-1100AQ1



SK-1100



SK-1101



SK-1102



SK-1103



SK-1104



SK-1105



SK-1106



SK-1107



SK-1108



SK-1108S



SK-1109



SK-1109AQ1

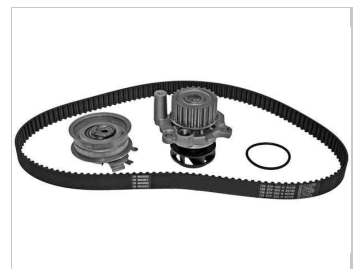

SK-1109AQ2



SK-1110

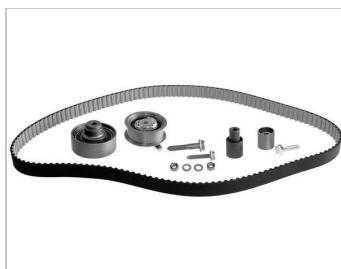

SK-1111

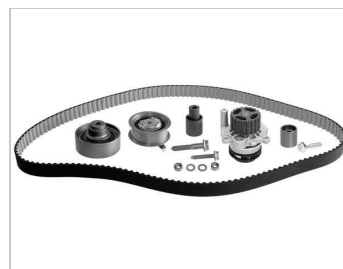

SK-1111AQ1



SK-1112

SK-1112AQ1	SK-1113	SK-1113AQ1	SK-1114
SK-1119	SK-1120	SK-1121	SK-1122
SK-1123	SK-1124	SK-1126AQ1	SK-1126
SK-1127	SK-1129AQ1	SK-1129	SK-1130
SK-1131	SK-1131AQ1	SK-1131AQ2	SK-1138
SK-1140	SK-1141	SK-1142	SK-1143

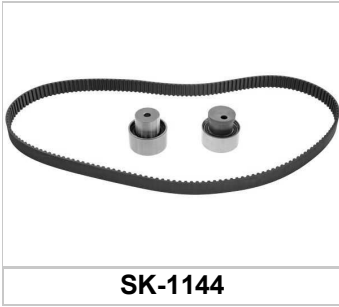

SK-1144



SK-1145S

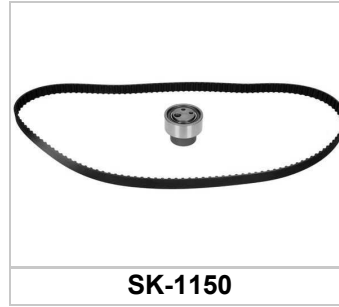

SK-1150



SK-1151

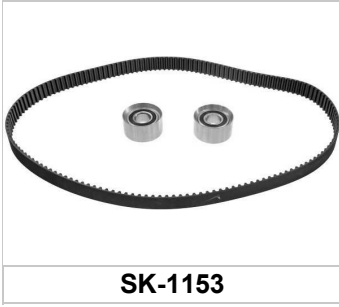

SK-1153

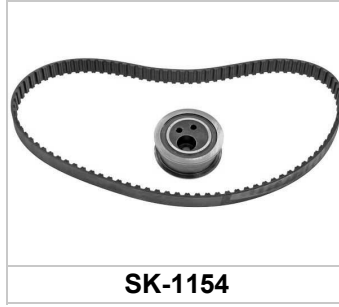

SK-1154



SK-1155



SK-1157



SK-1158



SK-1159



SK-1160



SK-1162



SK-1162AQ3



SK-1162AQ1



SK-1162AQ2



SK-1163



SK-1164

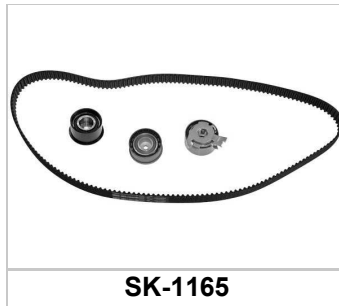

SK-1165



SK-1166



SK-1168

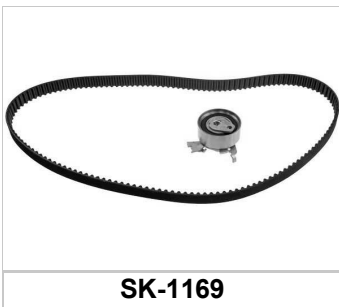

SK-1169



SK-1171



SK-1172



SK-1174

SK-1176	SK-1183AQ1	SK-1183	SK-1184
SK-1185	SK-1186	SK-1187	SK-1188
SK-1189	SK-1190	SK-1192	SK-1195
SK-1196	SK-1197	SK-1202	SK-1203
SK-1205	SK-1207	SK-1210	SK-1211
SK-1213	SK-1216	SK-1217	SK-1218



SK-1219

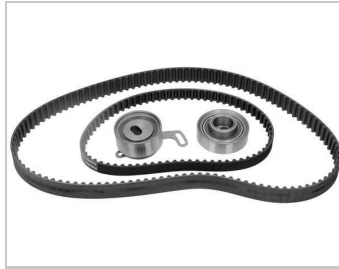

SK-1220

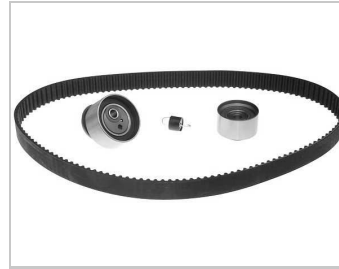

SK-1221



SK-1222

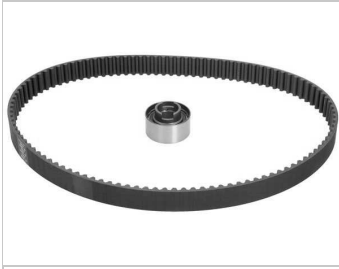

SK-1223



SK-1224

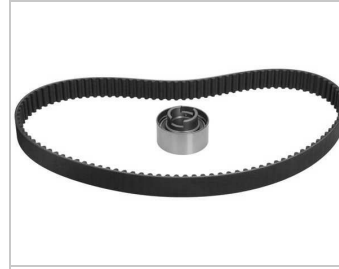

SK-1225



SK-1226



SK-1227



SK-1228



SK-1231



SK-1232



SK-1233



SK-1234

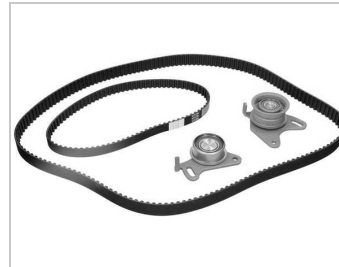

SK-1236

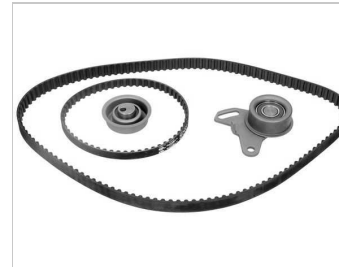

SK-1237



SK-1237S

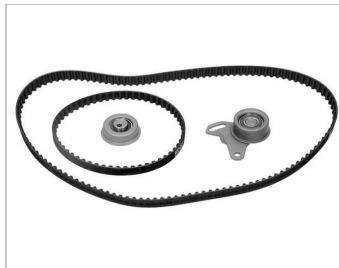

SK-1240



SK-1240S



SK-1242



SK-1245

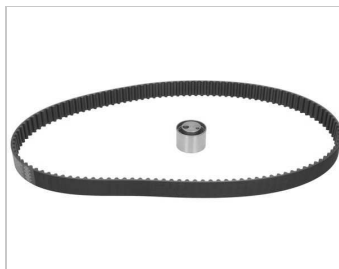

SK-1246



SK-1248

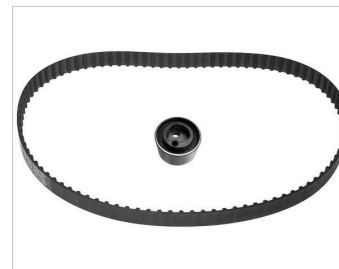

SK-1249

SK-1250	SK-1255	SK-1257	SK-1258
SK-1258AQ1	SK-1259	SK-1260	SK-1261
SK-1264	SK-1265	SK-1270	SK-1273AQ1
SK-1273AQ2	SK-1273	SK-1274	SK-1275
SK-1277	SK-1278	SK-1285	SK-1286
SK-1288	SK-1289	SK-1301	SK-1302

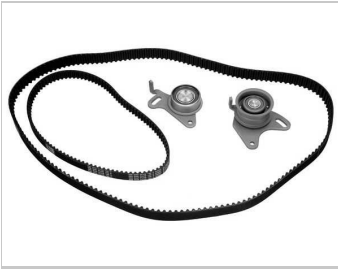

SK-1306

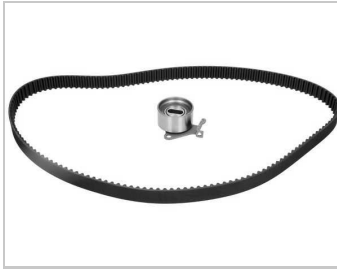

SK-1308

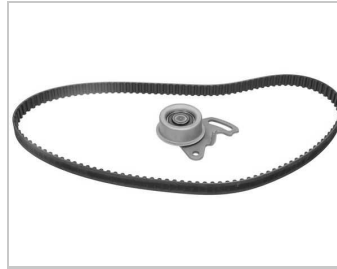

SK-1309S



SK-1310

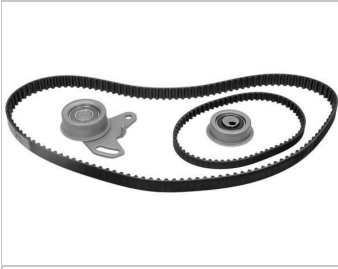

SK-1311

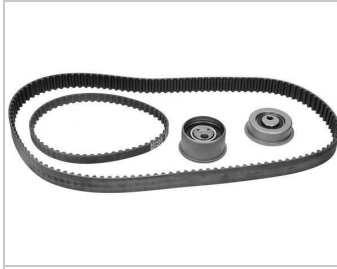

SK-1312

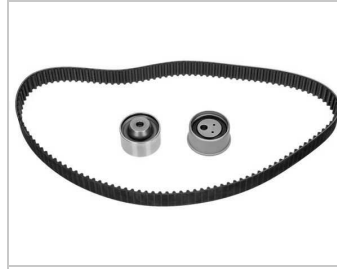

SK-1313S

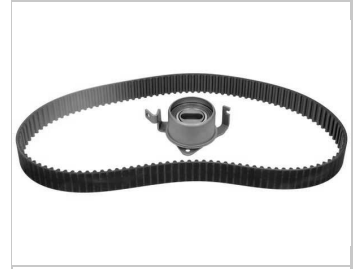

SK-1314



SK-1316



SK-1317



SK-1320



SK-1321



SK-1322



SK-1323



SK-1325



SK-1327



SK-1335



SK-1337



SK-1337AQ1



SK-1338



SK-1338AQ1



SK-1338AQ2



SK-1339



SK-1340

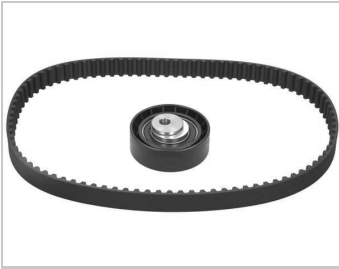

SK-1341

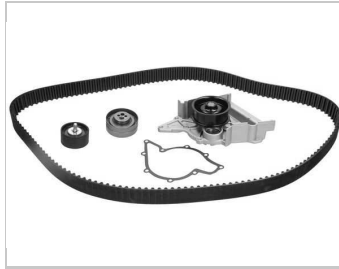

SK-1343AQ1

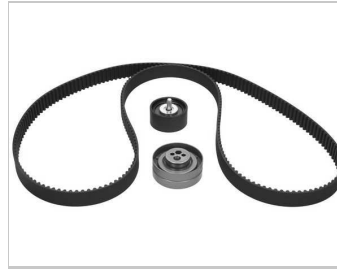

SK-1343



SK-1344



SK-1344AQ1



SK-1345



SK-1346

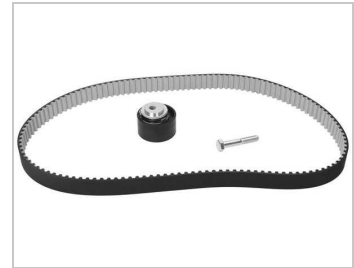

SK-1351



SK-1353

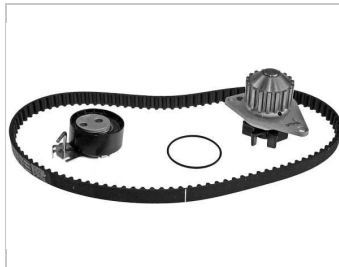

SK-1353AQ1



SK-1354

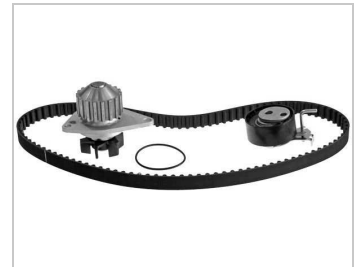

SK-1354AQ1



SK-1355



SK-1355AQ1



SK-1355AQ2



SK-1355AQ3



SK-1360



SK-1360AQ1



SK-1361



SK-1361AQ1



SK-1365



SK-1367



SK-1372AQ1



SK-1372AQ2

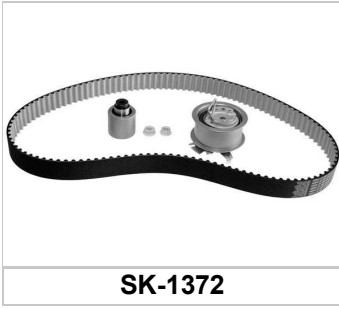

SK-1372



SK-1372AQ3



SK-1375

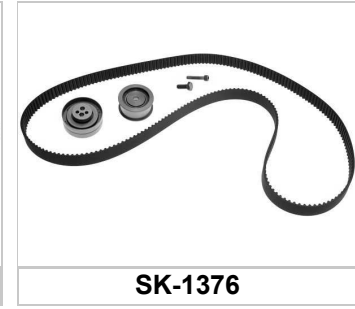

SK-1376



SK-1376AQ1

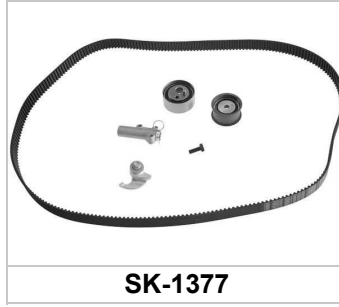

SK-1377



SK-1377AQ1



SK-1378AQ1



SK-1378



SK-1380



SK-1380AQ1



SK-1383



SK-1383AQ1

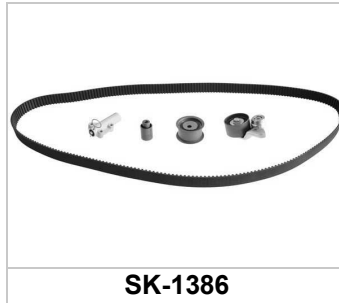

SK-1386

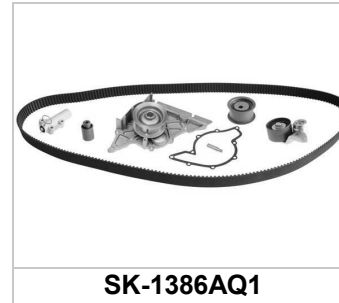

SK-1386AQ1

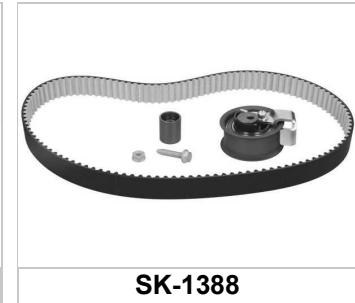

SK-1388



SK-1391



SK-1391AQ1



SK-1392AQ1



SK-1392



SK-1393

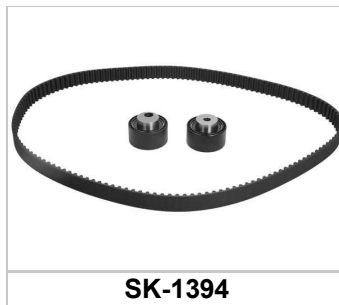

SK-1394

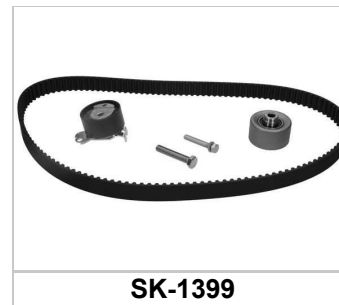

SK-1399



SK-1407



SK-1410AQ1



SK-1410

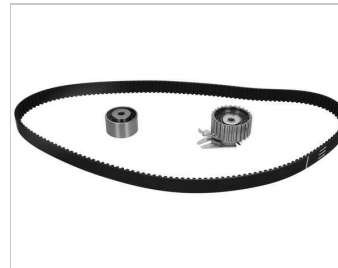

SK-1411



SK-1412



SK-1412AQ1



SK-1412AQ2



SK-1415

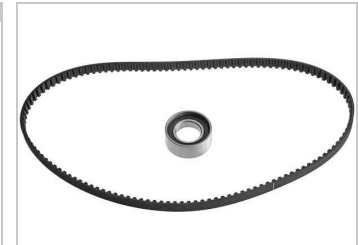

SK-1418



SK-1418AQ1



SK-1421



SK-1421AQ1

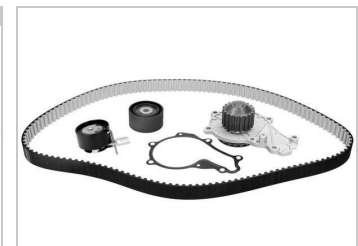

SK-1424AQ1



SK-1424

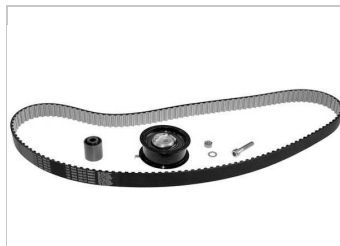

SK-1425



SK-1430



SK-1436



SK-1439



SK-1440



SK-1444



SK-1445



SK-1446



SK-1449



SK-1450



SK-1453

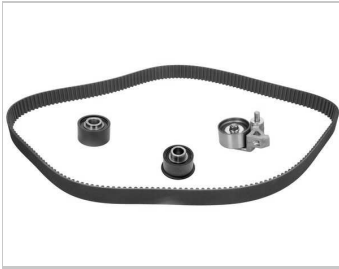

SK-1457



SK-1458



SK-1460



SK-1463



SK-1469

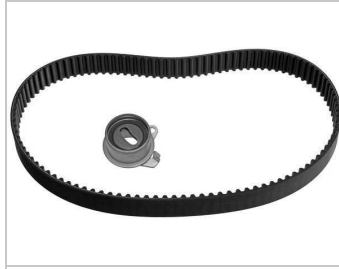

SK-1470

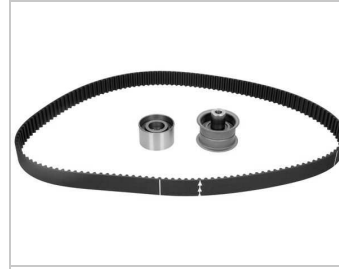

SK-1475

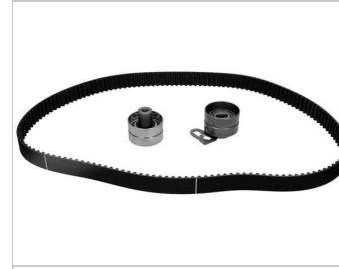

SK-1476

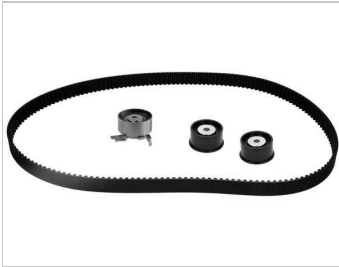

SK-1478

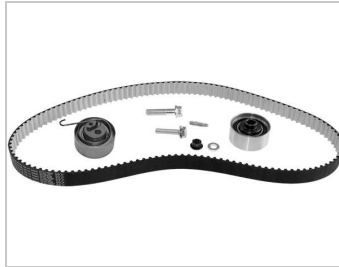

SK-1479



SK-1481



SK-1482



SK-1482AQ1



SK-1483

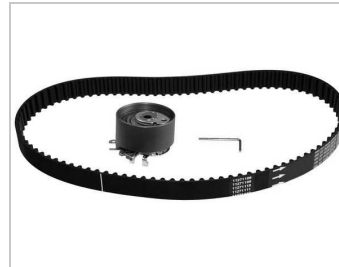

SK-1486



SK-1486AQ1



SK-1487



SK-1487AQ3



SK-1487AQ1

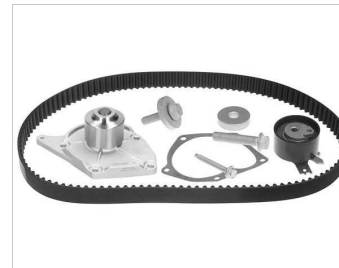

SK-1487AQ2



SK-1489



SK-1490



SK-1491



SK-1491AQ1

SK-1492	SK-1493	SK-1493AQ2	SK-1493AQ1
SK-1494	SK-1500	SK-1501	SK-1502
SK-1504	SK-1507	SK-1508	SK-1511
SK-1511AQ1	SK-1511AQ2	SK-1512	SK-1519
SK-1521	SK-1522	SK-1526	SK-1526AQ1
SK-1526AQ2	SK-1527	SK-1529	SK-1529AQ1

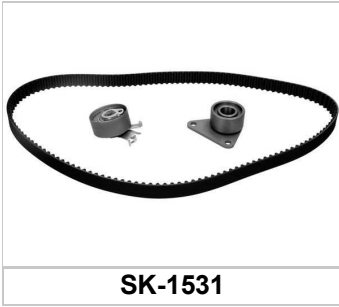

SK-1531



SK-1533

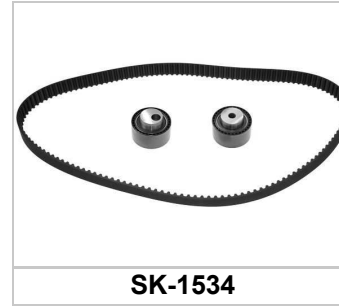

SK-1534



SK-1534AQ1



SK-1538



SK-1539



SK-1539AQ1

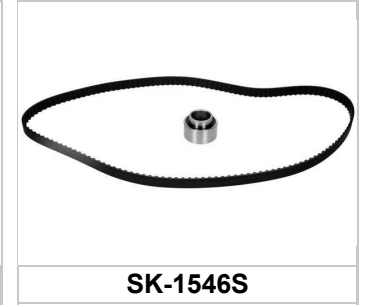

SK-1546S



SK-1552

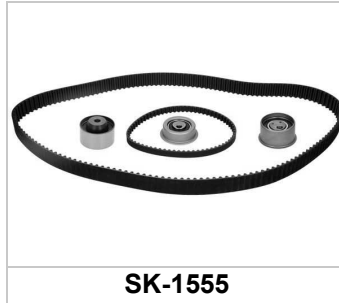

SK-1555



SK-1563



SK-1564



SK-1566

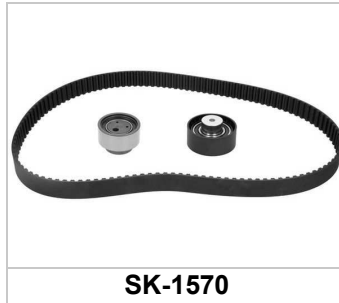

SK-1570



SK-1573



SK-1577



SK-1577AQ1

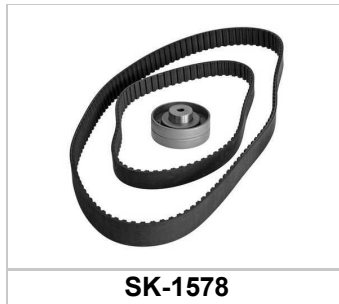

SK-1578



SK-1578AQ1



SK-1580

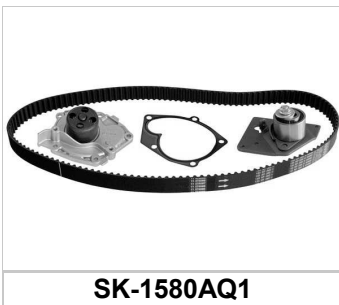

SK-1580AQ1

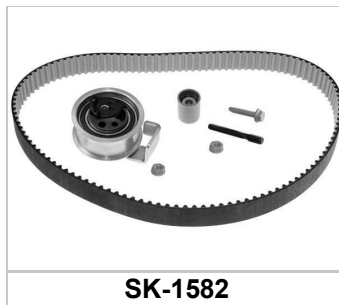

SK-1582



SK-1583



SK-1583AQ1

SK-1585	SK-1585AQ1	SK-1586	SK-1587
SK-1588	SK-1589	SK-1589AQ1	SK-1590
SK-1591	SK-1592	SK-1592AQ1	SK-1593
SK-1594	SK-1595AQ1	SK-1595	SK-1596
SK-1597	SK-1598	SK-1599	SK-1599AQ1
SK-1600	SK-1601	SK-1602	SK-1603

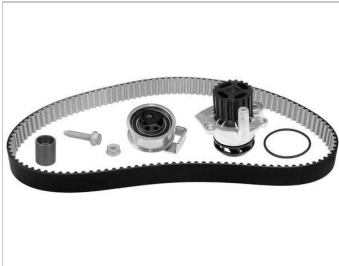

SK-1603AQ1

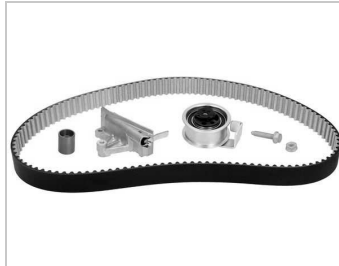

SK-1604

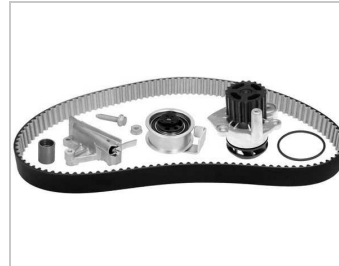

SK-1604AQ1



SK-1606



SK-1607

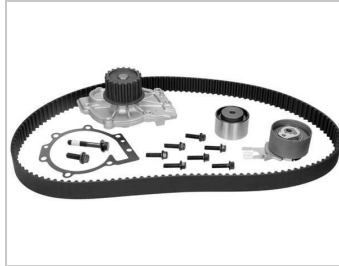

SK-1608AQ1



SK-1608

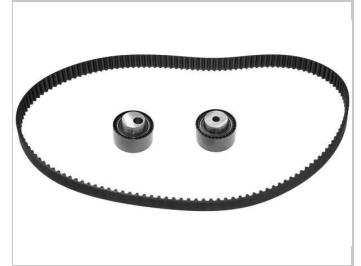

SK-1609

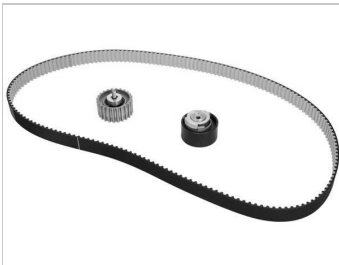

SK-1610



SK-1611

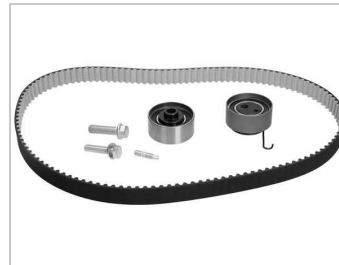

SK-1612



SK-1613

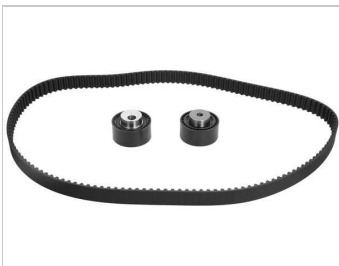

SK-1614

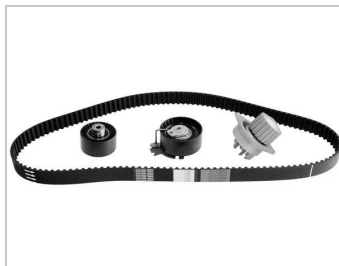

SK-1615AQ1



SK-1615



SK-1616

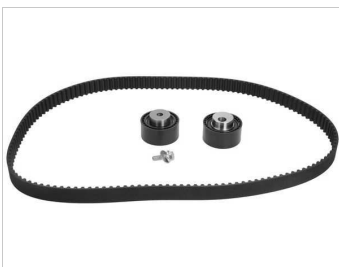

SK-1617



SK-1618



SK-1619



SK-1619AQ2



SK-1620



SK-1621



SK-1622



SK-1623

SK-1624	SK-1624AQ1	SK-1625	SK-1626
SK-1627	SK-1628	SK-1629	SK-1629AQ1
SK-1630	SK-1630AQ1	SK-1631	SK-1632
SK-1633	SK-1633AQ1	SK-1634	SK-1635
SK-1635AQ1	SK-1636	SK-1637	SK-1638
SK-1639	SK-1640	SK-1640AQ1	SK-1640AQ2



SK-1641

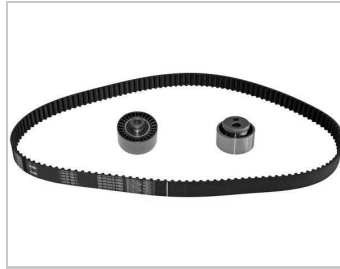

SK-1642



SK-1643

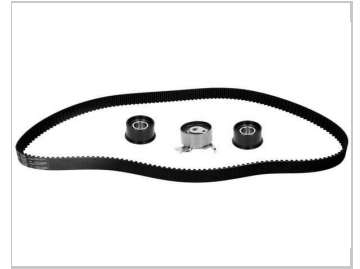

SK-1644



SK-1645

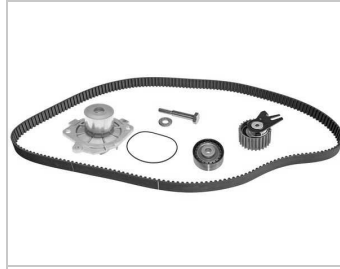

SK-1646AQ1

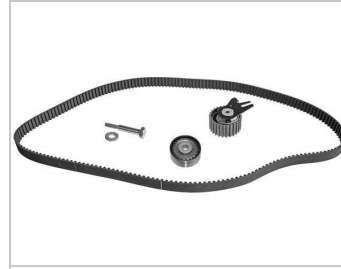

SK-1646



SK-1648



SK-1649



SK-1650



SK-1651



SK-1652

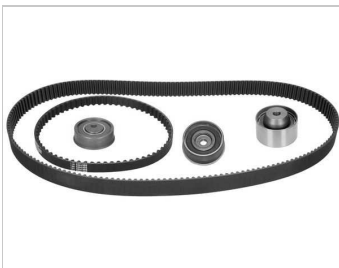

SK-1653



SK-1654



SK-1656



SK-1657



SK-1658



SK-1659



SK-1659AQ1



SK-1660



SK-1660AQ1



SK-1661

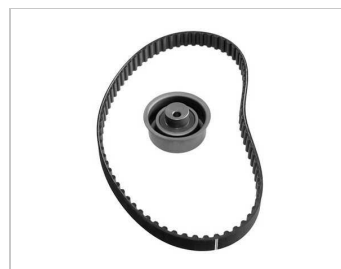

SK-1662



SK-1663

SK-1664	SK-1665	SK-1665AQ1	SK-1665AQ2
SK-1666	SK-1667	SK-1668	SK-1668AQ1
SK-1669	SK-1669AQ1	SK-1670	SK-1671
SK-1672	SK-1673	SK-1674	SK-1675
SK-1676	SK-1677	SK-1677AQ1	SK-1678
SK-1679	SK-1680	SK-1681	SK-1682

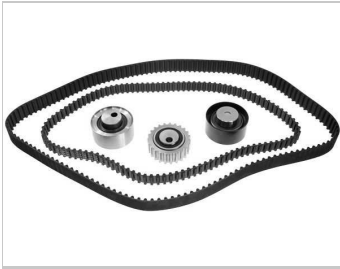

SK-1683



SK-1684



SK-1685



SK-1685AQ1

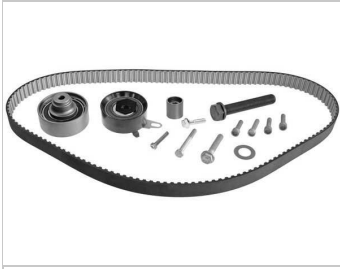

SK-1686

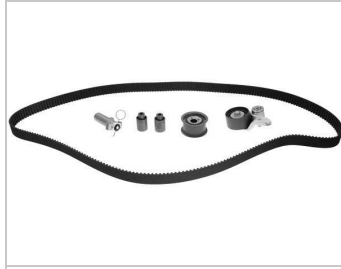

SK-1687



SK-1688

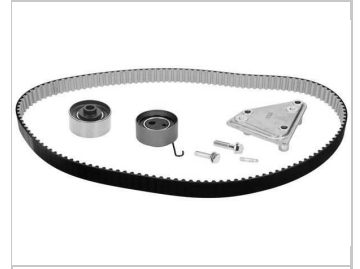

SK-1689



SK-1690

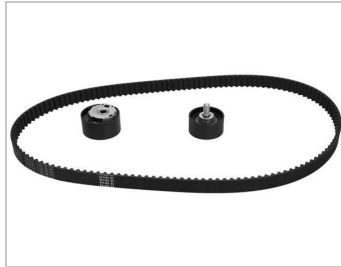

SK-1691



SK-1692



SK-1693



SK-1694

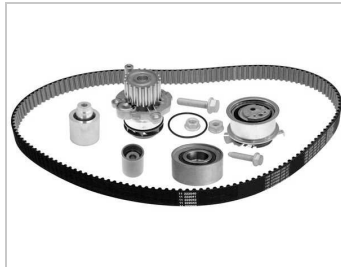

SK-1694AQ1



SK-1694AQ2



SK-1695



SK-1696



SK-1697



SK-1697AQ1



SK-1698



SK-1699



SK-1700



SK-1702



SK-1703



SK-1704



SK-1705



SK-1706

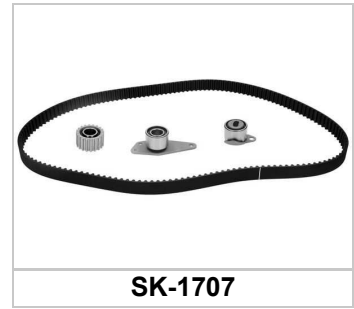

SK-1707



SK-1709

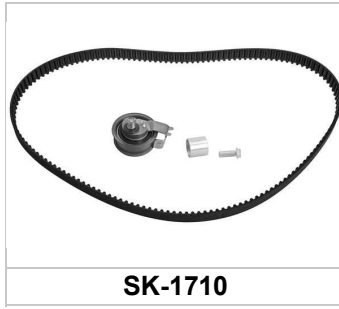

SK-1710



SK-1712



SK-1713

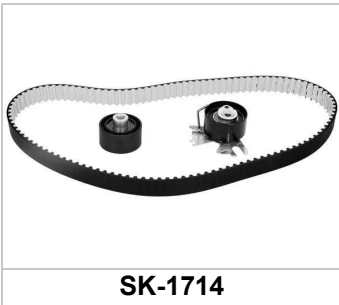

SK-1714



SK-1714AQ1

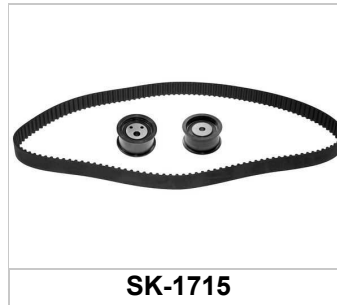

SK-1715

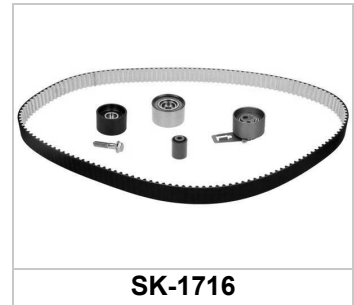

SK-1716

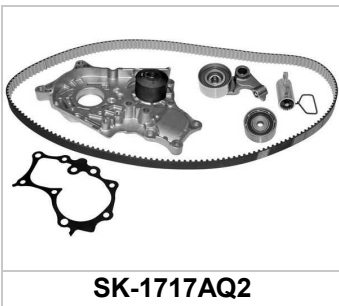

SK-1717AQ2

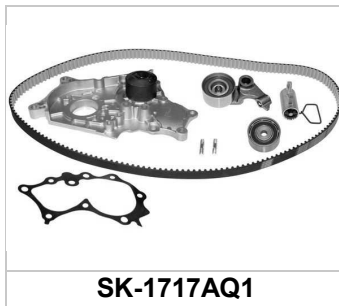

SK-1717AQ1

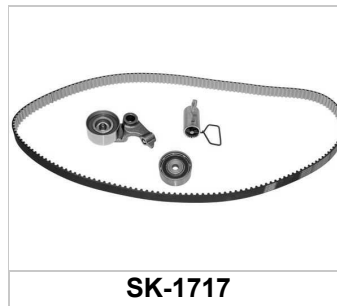

SK-1717



SK-1718



SK-1719



SK-1720



SK-1721



SK-1722

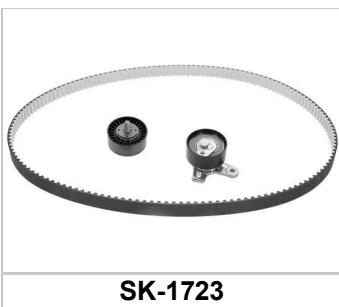

SK-1723

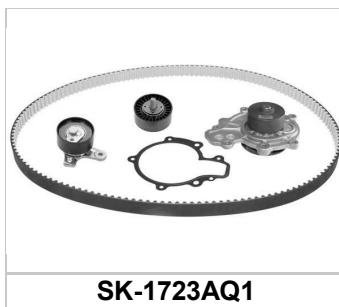

SK-1723AQ1

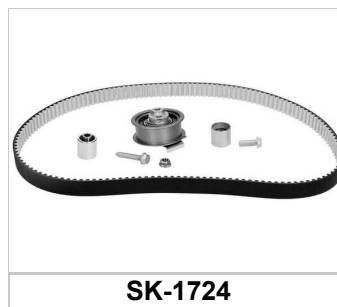

SK-1724



SK-1725



SK-1725AQ1

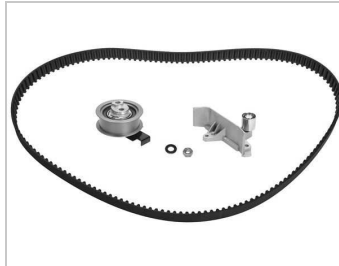

SK-1726



SK-1726AQ1



SK-1726AQ2



SK-1727



SK-1727AQ1



SK-1727AQ2



SK-1743



R-1072AQ1



R-1190AQ1



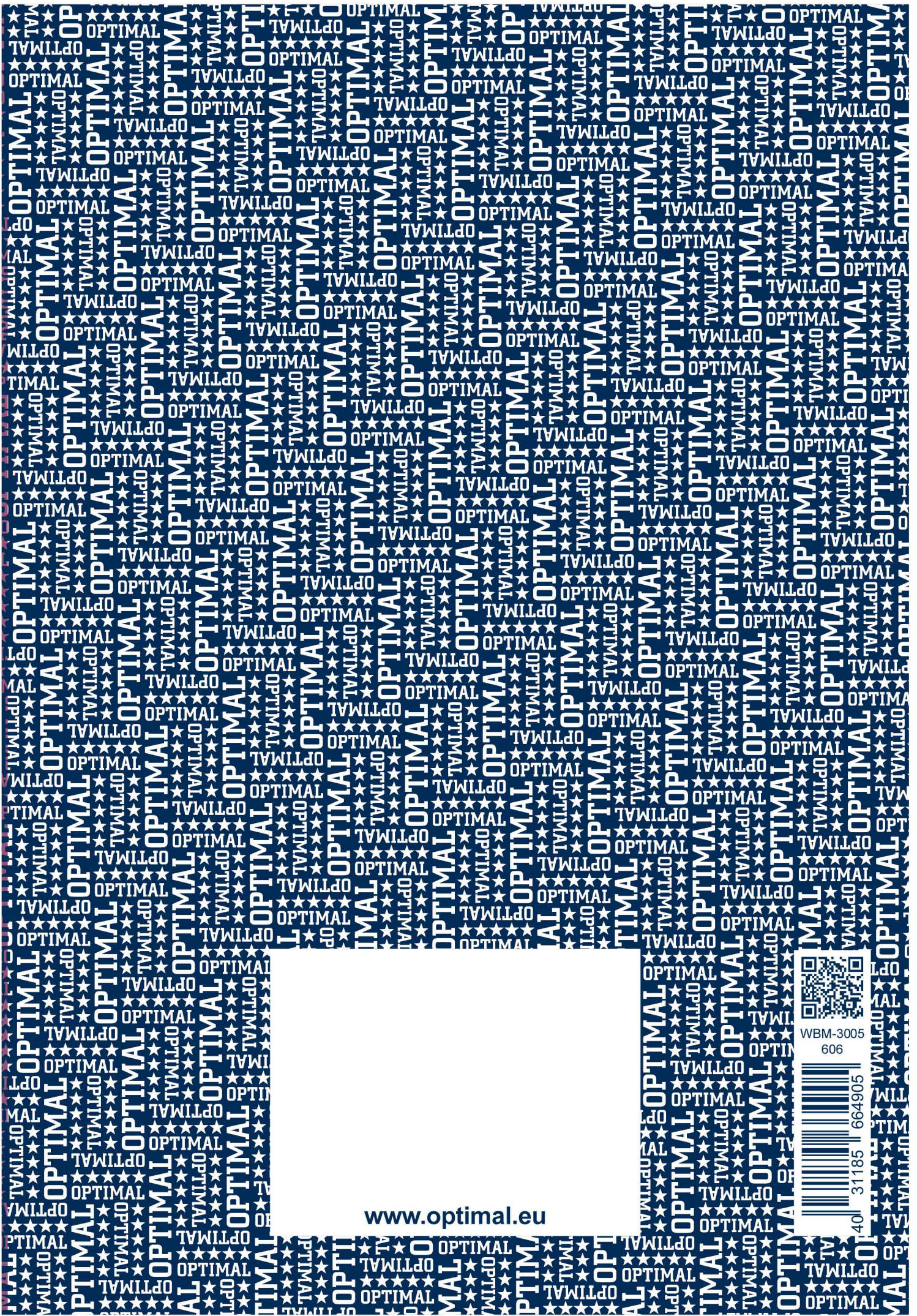

www.optimal.eu



WBM-3005
606



40 31185 664905