

Qualität fährt mit.
Quality in motion.



Ihr Systemlieferant *Your full-line supplier*

Mit diesem Katalog werden alle früheren Ausgaben ungültig. Technische Änderungen bleiben vorbehalten. Das Zahlenmaterial des Kataloges wurde sorgfältig erarbeitet. Eine Gewähr für letzte Richtigkeit kann aber nicht übernommen werden. Ersatzansprüche, die also auf den Angaben des Kataloges beruhen, können deshalb nicht anerkannt werden.

Original-Ersatzteilnummern dienen lediglich Vergleichszwecken. Sie dürfen nicht in Lieferscheinen und Rechnungen an die Fahrzeughalter oder Wiederverkäufer erscheinen.

Maßgebend für alle Lieferungen sind unsere Verkaufs-, Lieferungs- und Zahlungsbedingungen.

Dieser Katalog genießt Urheberrecht. Vervielfältigungen, auch auszugsweise, sind nicht gestattet.

With this catalogue all previous editions are no longer valid. Technical alterations reserved. The figures of the catalogue have been elaborated carefully. Nevertheless we cannot guarantee for absolute correctness. Therefore entitlements to compensation cannot be accepted.

Original-numbers (OE-numbers) are only meant to be a means of comparison. They must not appear on delivery notes or invoices that are addressed to vehicle owners or resellers.

Our terms and conditions are decisive for all deliveries. This catalogue ist protected by copyright.

Duplications even in abridged versions are prohibited.

Bremsscheibe Brake Disc

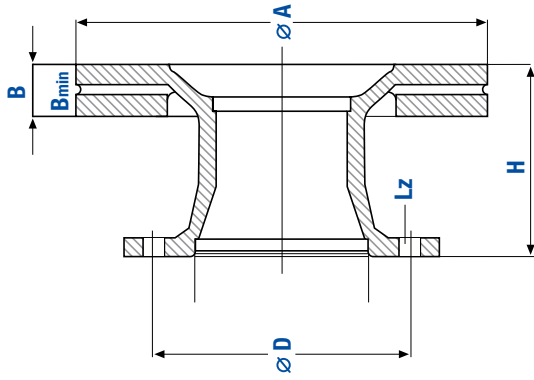

$\varnothing A$ Durchmesser (mm)
 H Höhe (mm)
 B Bremsbahn (mm)
 B_{min} Mindestdicke (mm)
 $\varnothing D$ Lochkreis - \varnothing (mm)
 Lz Lochanzahl

$\varnothing A$ diameter
 H height
 B brake surface
 B_{min} minimum thickness (min. TH)
 $\varnothing D$ pitch circle
 Lz number of holes

Bremstrommel Brake Drum

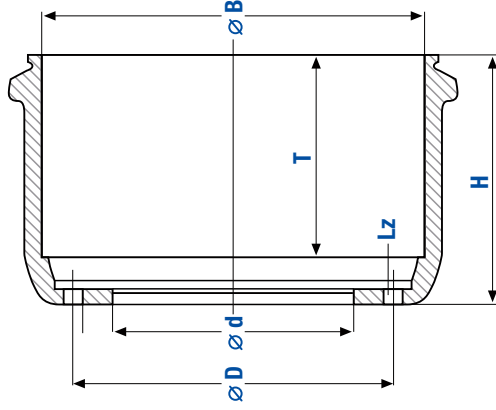

$\varnothing B$ Durchmesser (mm)
 T Bremsbahn (mm)
 $\varnothing D$ Lochkreis - \varnothing (mm)
 $\varnothing d$ Nabenbohrung - \varnothing (mm)
 H Höhe (mm)
 Lz Lochanzahl

$\varnothing B$ diameter
 T brake surface
 $\varnothing D$ pitch circle
 $\varnothing d$ hub bore
 H height
 Lz number of holes



ST – Bremse ST-Brake

Das Kompletzprogramm von Scheiben- und Trommelbremsen für NKW, Busse, Transporter und Sonderfahrzeuge.

Das Unternehmen Templin hat kontinuierlich das Produktprogramm im Bereich Bremse weiter ausgebaut, sodass heute eine komplette Systemlösung im Reparaturmarkt angeboten werden kann.

Gemeinschaftlich mit Partnern hat bei der Entwicklung der Produkte die Anforderungen des IAM – Marktes Berücksichtigung gefunden und die Spezifikationen der Produkte aufeinander abgestimmt. Beispiel: Reibpaarung Bremsklotz – Bremssscheibe

Unter dem Motto: Die Templin – Entwicklungen entsprechen höchster Qualität (ISO 9001 zertifiziert) unter Berücksichtigung aller sicherheitsrelevanten Anforderungen; sind wir in der Lage ST – Originalqualität in Reparatursätzen den regionalen Spezifikationen anzubieten.

The complete range of brake discs and –drums for trucks, busses, light commercials and special vehicles.

The Templin company has constantly extended the range of brake parts. Today we can offer the complete system needed to the repair market.

*With our partners we have engineered the parts to meet the requirements of the IAM. That means to optimize the parts working together, to get the best result.
For example: friction pairing for brake pads and brake discs.*

The Templin – engineering corresponds to highest quality (ISO 9001 certificate), under consideration of all safety requirements, we are able to offer ST original quality also in the repair sets to regional specifications.



Bremsscheibenkontrolle Brake Disc Control

1.) Brems Scheibenfläche

Bremsscheiben auf Ribbildung und Riefen kontrollieren.

- Netzartige Ribbildung ist zulässig.
- Risse auf der Bremsfläche mit max. 1,5 mm Breite und Tiefe sind zulässig, wenn sie nicht 75 % der Bremsfläche überschreiten.
- Riefen auf der Bremsfläche sind zulässig, wenn sie nicht tiefer als 1,5 mm sind.
- Brems Scheiben mit durchgehenden Rissen auf der Bremsfläche sind unzulässig und müssen achsweise erneuert werden.

2.) Verschleißmaß

Das absolute Verschleißmaß der Brems Scheibe ist am äußeren Ø eingepreßt. Beim Erreichen des angegebenen Maßes minimum thickness sind die Brems Scheiben achsweise zu erneuern.

3.) Scheibenschlag

Ein Scheibenschlag von 0,15 mm ist zulässig.

Achten Sie bitte auf die Wartungs- und Instandsetzungshinweise der Bremsen- und Fahrzeughersteller.

1.) Brake Disk Surface

Check of brake discs surface for cracks and grooves.

- Cracks resembling a net are allowed.
- Cracks on the braking surface with max. width and depth of 1,5 mm are allowed, as long as they are not exceeding 75 % of the braking surface.
- Grooves on the braking surface are allowed if they are not deeper than 1,5 mm.
- Brake discs with cracks going all the way through the braking surface have to be replaced per axle.

2.) Wear Dimension

The brake discs maximum wear dimension is imprinted on the outer diameter. When the minimum thickness is reached, discs have to be replaced per axle.

3.) Disc Imbalance

A disc imbalance of 0,15 mm is allowed.

Please observe repair and maintenance instructions of the brake- and vehicle manufacturers.

Automatische Gestängesteller Automatic slack adjusters

Überlegene technische Konstruktion – differenzierte Technologie, die den modernen Anforderungen ans Bremsen gerecht wird
Superior technical design – differentiated technology to cope with modern braking demands
 Einfach und schnell zu installieren – sich selbst einstellender Mechanismus
Quick and easy to install – self-setting mechanism
 Größte Sicherheit – ausfallsichere Eigenschaften
Maximum security – failsafe features
 Optimierte Konstruktion, um einen größeren Anwendungsbereich abzudecken
Optimized design for a wider range of applications

Produkt Zulassungen *Product approvals*
 TÜV I, KBA 61140, TÜV III, ABS certified, SAE J 1462

Einsatzmöglichkeiten Product applications	Anhänger Trailer	LKW Truck	Bus Bus
ROR	■		
SAF	■		
Bergische Achse	■		
SAE	■		
SMB	■		
Trailer	■		
Fruehauf	■		
Sisu		■	
Mercedes		■	■
MAN		■	■
Renault		■	■
DAF		■	■
Scania		■	■
Volvo		■	■
Van Hool			■
Neoplan			■

Made in Sweden
 Patented & patented

Automatische Gestängesteller

Beim Einsatz von automatischen Gestängestellern entfällt die manuelle Einstellung des Bremsgestänges. Dadurch wird vermieden, dass bei versäuerter Nachjustierung der Kolbenhub im Membranzylinder zu groß wird und somit der Luftverbrauch ansteigt und sich darüber hinaus die Ansprechzeit der Bremse verlängert.

Automatic slack adjusters

With the use of automatic slack adjusters the manual attitude of the brake linkage is void. Thus it is avoided that during missed readjusting the piston stroke in the diaphragm brake cylinder too largely and thus air consumption rises an itself beyond that the response of the brake extended.

Installationsanweisung Installation instruction

1 Vorbereiten Prepare



2 Ausrichtung - fest Align - fix



3 Befestigen Fasten

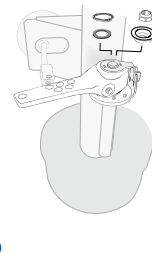

4 Prüfen Check

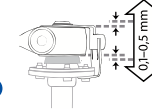

5 Vermeiden Avoid

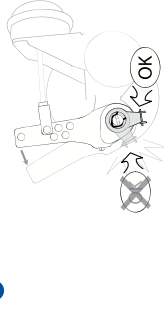

6 Verbinden Connect

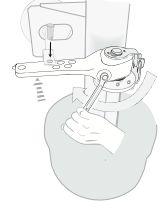

7 Fixieren Set

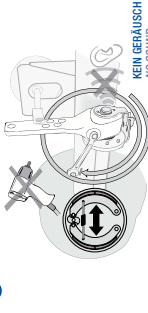

8 Fertig Finish



Inhalt / Content	Seite / page
Informationen / Information	1 - 10
BG-03.010 Bremswellen Brake camshafts:	11 - 17
Bremswellen Brake camshafts	11 - 17
BG-03.020 Bremswellensätze und Zubehör Rep.-kits brake camshaft and accessories:	19 - 43
Dichtring, Radnabe Seal Ring, wheel hub	19
Distanzring Spacer Ring	19
Distanzscheibe, Bremswelle Spacer, brake shaft	19 - 21
Halter, Bremswellenlager Holder, brake shaft bearing	23
Halteschelle Fastening Clamp	23
Lager, Bremsnockenwelle Bearing, brake camshaft	24
Lagerbuchse, Bremswelle Bushing, brake shaft	24 - 28
Reparatursatz Bremsnockenwelle Repair Kit, brake camshaft	28 - 39
Sicherungsring Circlip	40 - 41
Dichtung Gasket Seal	41 - 43
BG-03.030 Gestängesteller und Zubehör Brake Adjuster and accessories:	43 - 93
Gestängesteller, Bremsanlage Brake Adjuster	43 - 92
Reparatursatz, Gestängesteller Repair Kit, adjuster	92 - 93
Feder, Gestängesteller Spring, adjuster	93
BG-03.040 Bremsbacken Brake shoes:	94 - 103
Bremsbackensatz Brake Shoe Set	93
Bremsbacke Brake Shoe	94 - 103
BG-03.060 Bremsbelagnieten Brake-lining rivets:	104 - 105
Niete, Trommelbremsbelag Rivet, drum brake lining	104 - 105
BG-03.070 Reparatursatz, Bremsbacke und Zubehör Repair Kit, brake shoe and accessories:	107 - 134
Unterlegscheibe Washer	107
Schraube Screw / Bolt	108
Buchse, Bremsbackenbolzen	109 - 111
Bremsbackenrolle Brake Shoe Sleeve	112 - 115
Reparatursatz, Bremsbackenlagerung Repair Kit, brake shoe mounting	115 - 116
Warnkontakt, Bremsbelagverschleiß / Alarm Sensor, brake lining wear	116
Dichtung Gasket / Seal	117
Sicherungsring Circlip	117

Inhalt / Content	Seite / page
------------------	--------------

BG-03.070 Reparatursatz, Bremsbacke und Zubehör Repair Kit, brake shoe and accessories:	107 - 134
Dichtung Seal Ring	117 - 118
Sicherungsclip Circlip	119
Federhaltestift, Bremsbacke Spring Retaining Pin, brake shoe	119 - 120
Bolzen, Bremsbackenrolle Pin, brake shoe sleeve	121 - 127
Reparatursatz, Bremsbackenrolle Repair Kit, brake shoe sleeve	127 - 130
Bremsbackenbolzensatz Brake Shoe Pin Set	130 - 132
Halteblech, Bremsbackenbolzen Retaining Plate, brake shoe pins	132 - 134
Bügel Bracket	134
Sicherungsbügel Fastening Clamp	134
 BG-03.080 Feder, Bremsbacken Spring, brake shoe:	 134 - 145
Feder, Bremsbacken Spring, brake shoe	134 - 145
 BG-03.090 Bremstrommel Brake Drum:	 145 - 200
Bremstrommel Brake Drum	145 - 198
Radnabe Wheel Hub	198 - 200
 BG-03.100 Zubehör für Bremstrommeln Accessories for Brake Drums:	 200 - 206
Abdeckblech, Staubschutz-Radlager Cover Plate, dust-cover wheel bearing	200 - 206
 BG-03.110 Bremsscheibe Brake Disc:	 206 - 237
Bremsscheibe Brake Disc	206 - 236
Schraube, Bremsscheibe Bolt, brake disc	236 - 237
 BG-03.120 Bremsbelagsatz, Scheibenbremse Brake Pad Set, disc brake:	 237 - 244
Bremsbelagsatz, Scheibenbremse Brake Pad Set, disc brake	237 - 244
 BG-03.130 Zubehör Bremsbelagsatz Accessories for Brake Pad Set	 244 - 249
Warnkontakt, Bremsbelagverschleiß Alarm Sensor, brake lining wear	244 - 247
Zubehörsatz, Scheibenbremsbelag Accessory Kit, disc brake pads	248 - 249
 Vergleichsliste Crosslist	 251 - 310
Aufsteigend nach ST-Nr. Comparison No. Ascending to ST-No.	251 - 279
Aufsteigend nach Vergleichsnummer Ascending to Comp.-No.	281 - 310

SERVICE-HOTLINE

FON: +49 5156 - 96 10 - 0
FAX: +49 5156 - 96 11 96

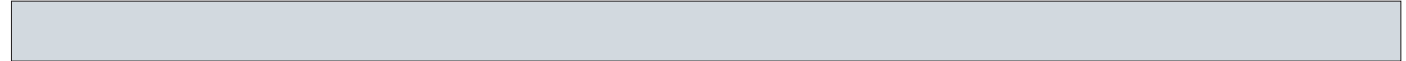

Bremswellen | Brake camshafts



Artikel-Nr.	Gesamtänge	Einbauseite	S / Z	passend für	Info	Ref.-Nr.
article-no.	total length	Fitting Position	S / Z	to fit to	Info	Ref.-No.
03.010.0240.231	401	links left	S	Bergische Achse		05.097.05.01.3
03.010.0240.241	401	rechts right	Z	Bergische Achse		05.097.05.02.3
03.010.0240.251	418	links left	S	Bergische Achse		05.097.05.03.3
03.010.0240.271	427	links left	S	Bergische Achse		05.097.05.05.3
03.010.0240.281	427	rechts right	Z	Bergische Achse		05.097.05.06.3
03.010.0240.291	441	links left	S	Bergische Achse		05.097.05.07.3
03.010.0240.301	441	rechts right	Z	Bergische Achse		05.097.05.08.3
03.010.0240.311	480	links left	S	Bergische Achse		05.097.05.09.3
03.010.0240.321	480	rechts right	Z	Bergische Achse		05.097.05.10.3
03.010.0240.331	516	links left	S	Bergische Achse		05.097.05.11.3
03.010.0240.341	516	rechts right	Z	Bergische Achse		05.097.05.12.3
03.010.0240.351	541	links left	S	Bergische Achse		05.097.05.13.3
03.010.0240.361	541	rechts right	Z	Bergische Achse		05.097.05.14.3
03.010.0240.371	550	links left	S	Bergische Achse		05.097.05.15.3
03.010.0240.381	550	rechts right	Z	Bergische Achse		05.097.05.16.3
03.010.0240.391	588	links left	S	Bergische Achse		05.097.05.17.3
03.010.0240.401	588	rechts right	Z	Bergische Achse		05.097.05.18.3
03.010.0240.411	618	links left	S	Bergische Achse		05.097.05.19.3
03.010.0240.421	618	rechts right	Z	Bergische Achse		05.097.05.20.3
03.010.0240.431	628	links left	S	Bergische Achse		05.097.05.21.3

BG-03.010

Bremswellen Brake camshafts



Bremswellen | Brake camshafts



Artikel-Nr.	Gesamtänge	Einbauseite	S / Z	passend für	Info	Ref.-Nr.
article-no.	total length	Fitting Position	S / Z	to fit to	Info	Ref.-No.
03.010.0240.441	628	rechts right	Z	Bergische Achse		05.097.05.22.3
03.010.0240.451	641	links left	S	Bergische Achse		05.097.05.23.3
03.010.0240.461	641	rechts right	Z	Bergische Achse		05.097.05.24.3
03.010.0240.471	666	links left	S	Bergische Achse		05.097.05.25.3
03.010.0240.481	666	rechts right	Z	Bergische Achse		05.097.05.26.3
03.010.0240.491	696	links left	S	Bergische Achse		05.097.05.27.3
03.010.0240.501	696	rechts right	Z	Bergische Achse		05.097.05.28.3
03.010.0240.511	734	links left	S	Bergische Achse		05.097.05.29.3
03.010.0240.521	734	rechts right	Z	Bergische Achse		05.097.05.30.3
03.010.0240.531	857	links left	S	Bergische Achse		05.097.05.31.3
03.010.0240.541	857	rechts right	Z	Bergische Achse		05.097.05.32.3
03.010.0240.571	453	links left	S	Bergische Achse		05.097.05.35.3
03.010.0240.581	453	rechts right	Z	Bergische Achse		05.097.05.36.3
03.010.0240.591	753	links left	S	Bergische Achse		05.097.05.37.3
03.010.0240.601	753	rechts right	Z	Bergische Achse		05.097.05.38.3
03.010.0240.611	676	links left	S	Bergische Achse		05.097.05.39.3
03.010.0240.621	676	rechts right	Z	Bergische Achse		05.097.05.40.3
03.010.0240.671	576	links left	S	Bergische Achse		05.097.05.45.3
03.010.0240.681	576	rechts right	Z	Bergische Achse		05.097.05.46.3
03.010.0240.691	603	links left	S	Bergische Achse		05.097.05.47.3

Bremswellen | Brake camshafts



Artikel-Nr.	Gesamtänge	Einbauseite	S / Z	passend für	Info	Ref.-Nr.
article-no.	total length	Fitting Position	S / Z	to fit to	Info	Ref.-No.
03.010.0240.701	603	rechts right	Z	Bergische Achse		05.097.05.48.3
03.010.0240.210	232	links left	S	Bergische Achse	mit Rep.-Satz with Repair Kit	09.097.02.37.1
03.010.0240.220	232	rechts right	Z	Bergische Achse	mit Rep.-Satz with Repair Kit	09.097.02.38.1
03.010.0240.230	401	links left	S	Bergische Achse	mit Rep.-Satz with Repair Kit	09.097.05.01.0
03.010.0240.240	401	rechts right	Z	Bergische Achse	mit Rep.-Satz with Repair Kit	09.097.05.02.0
03.010.0240.250	418	links left	S	Bergische Achse	mit Rep.-Satz with Repair Kit	09.097.05.03.1
03.010.0240.270	427	links left	S	Bergische Achse	mit Rep.-Satz with Repair Kit	09.097.05.05.0
03.010.0240.280	427	rechts right	Z	Bergische Achse	mit Rep.-Satz with Repair Kit	09.097.05.06.0
03.010.0240.290	441	links left	S	Bergische Achse	mit Rep.-Satz with Repair Kit	09.097.05.07.1
03.010.0240.300	441	rechts right	Z	Bergische Achse	mit Rep.-Satz with Repair Kit	09.097.05.08.1
03.010.0240.310	480	links left	S	Bergische Achse	mit Rep.-Satz with Repair Kit	09.097.05.09.1
03.010.0240.320	480	rechts right	Z	Bergische Achse	mit Rep.-Satz with Repair Kit	09.097.05.10.1
03.010.0240.330	516	links left	S	Bergische Achse	mit Rep.-Satz with Repair Kit	09.097.05.11.1
03.010.0240.340	516	rechts right	Z	Bergische Achse	mit Rep.-Satz with Repair Kit	09.097.05.12.1
03.010.0240.350	541	links left	S	Bergische Achse	mit Rep.-Satz with Repair Kit	09.097.05.13.1
03.010.0240.360	541	rechts right	Z	Bergische Achse	mit Rep.-Satz with Repair Kit	09.097.05.14.1
03.010.0240.370	547	links left	S	Bergische Achse	mit Rep.-Satz with Repair Kit	09.097.05.15.0
03.010.0240.380	550	rechts right	Z	Bergische Achse	mit Rep.-Satz with Repair Kit	09.097.05.16.0
03.010.0240.390	588	links left	S	Bergische Achse	mit Rep.-Satz with Repair Kit	09.097.05.17.1
03.010.0240.400	588	rechts right	Z	Bergische Achse	mit Rep.-Satz with Repair Kit	09.097.05.18.1

BG-03.010

Bremswellen Brake camshafts



Bremswellen | Brake camshafts



Artikel-Nr.	Gesamtänge	Einbauseite	S / Z	passend für	Info	Ref.-Nr.
article-no.	total length	Fitting Position	S / Z	to fit to	Info	Ref.-No.
03.010.0240.410	618	links left	S	Bergische Achse	mit Rep.-Satz with Repair Kit	09.097.05.19.1
03.010.0240.420	618	rechts right	Z	Bergische Achse	mit Rep.-Satz with Repair Kit	09.097.05.20.1
03.010.0240.430	628	links left	S	Bergische Achse	mit Rep.-Satz with Repair Kit	09.097.05.21.1
03.010.0240.440	628	rechts right	Z	Bergische Achse	mit Rep.-Satz with Repair Kit	09.097.05.22.1
03.010.0240.450	641	links left	S	Bergische Achse	mit Rep.-Satz with Repair Kit	09.097.05.23.1
03.010.0240.460	641	rechts right	Z	Bergische Achse	mit Rep.-Satz with Repair Kit	09.097.05.24.1
03.010.0240.470	666	links left	S	Bergische Achse	mit Rep.-Satz with Repair Kit	09.097.05.25.1
03.010.0240.480	666	rechts right	Z	Bergische Achse	mit Rep.-Satz with Repair Kit	09.097.05.26.1
03.010.0240.490	696	links left	S	Bergische Achse	mit Rep.-Satz with Repair Kit	09.097.05.27.1
03.010.0240.500	696	rechts right	Z	Bergische Achse	mit Rep.-Satz with Repair Kit	09.097.05.28.1
03.010.0240.510	734	links left	S	Bergische Achse	mit Rep.-Satz with Repair Kit	09.097.05.29.1
03.010.0240.520	734	rechts right	Z	Bergische Achse	mit Rep.-Satz with Repair Kit	09.097.05.30.1
03.010.0240.530	857	links left	S	Bergische Achse	mit Rep.-Satz with Repair Kit	09.097.05.31.0
03.010.0240.570	453	links left	S	Bergische Achse	mit Rep.-Satz with Repair Kit	09.097.05.35.0
03.010.0240.580	453	rechts right	Z	Bergische Achse	mit Rep.-Satz with Repair Kit	09.097.05.36.0
03.010.0240.590	753	links left	S	Bergische Achse	mit Rep.-Satz with Repair Kit	09.097.05.37.0
03.010.0240.600	753	rechts right	Z	Bergische Achse	mit Rep.-Satz with Repair Kit	09.097.05.38.0
03.010.0240.610	676	links left	S	Bergische Achse	mit Rep.-Satz with Repair Kit	09.097.05.39.1
03.010.0240.620	676	rechts right	Z	Bergische Achse	mit Rep.-Satz with Repair Kit	09.097.05.40.1
03.010.0240.670	576	links left	S	Bergische Achse	mit Rep.-Satz with Repair Kit	09.097.05.45.1

Bremswellen | Brake camshafts



Artikel-Nr.	Gesamtänge	Einbauseite	S / Z	passend für	Info	Ref.-Nr.
article-no.	total length	Fitting Position	S / Z	to fit to	Info	Ref.-No.
03.010.0240.680	576	rechts right	Z	Bergische Achse	mit Rep.-Satz with Repair Kit	09.097.05.46.1
03.010.0240.690	603	links left	S	Bergische Achse	mit Rep.-Satz with Repair Kit	09.097.05.47.1
03.010.0240.700	603	rechts right	Z	Bergische Achse	mit Rep.-Satz with Repair Kit	09.097.05.48.1
03.010.0290.700	589,5	links left	S	FRUEHAUF		A-JA-0476-003
03.010.0290.710	589,5	rechts right	Z	FRUEHAUF		A-JA-0476-004
03.010.0290.720	637	rechts right	S	FRUEHAUF		A-JA-0660-003
03.010.0290.730	637	links left	Z	FRUEHAUF		A-JA-0660-004
03.010.0692.000	531	links left	S	Kässbohrer		010.24.21.849.59
03.010.0657.000	560	links left	S	Kässbohrer		010.24.21.849.77
03.010.0658.000	560	rechts right	Z	Kässbohrer		010.24.21.849.78
03.010.0908.170	226	links left	S	MAN		81.50301.0225
03.010.0908.180	226	rechts right	Z	MAN		81.50301.0226
03.010.0903.510	525	rechts right	Z	MAN		81.50301.0271
03.010.0903.520	525	links left	S	MAN		81.50301.0272
03.010.1905.830	255	links left	S	MERCEDES-BENZ		623 421 01 36
03.010.1905.840	255	rechts right	Z	MERCEDES-BENZ		623 421 02 36
03.010.1905.860	545	rechts right	Z	MERCEDES-BENZ		623 423 01 36
03.010.1905.870	545	links left	S	MERCEDES-BENZ		623 423 02 36
03.010.2165.000	575,2	links left	S	SAUER		2.262.0253.02
03.010.2166.000	575,2	rechts right	Z	SAUER		2.262.0254.02

BG-03.010

Bremswellen Brake camshafts



Bremswellen | Brake camshafts



Artikel-Nr.	Gesamtänge	Einbauseite	S / Z	passend für	Info	Ref.-Nr.
article-no.	total length	Fitting Position	S / Z	to fit to	Info	Ref.-No.
03.010.2163.000	548	links left	S	SAUER		2.262.0261.02
03.010.2164.000	548	rechts right	Z	SAUER		2.262.0262.02
03.010.2191.000	680	links left	S	SAUER		2.262.0271.02
03.010.2202.000	604	links left	S	SAUER		2.262.0279.02
03.010.2203.000	604	rechts right	Z	SAUER		2.262.0280.02
03.010.2158.000	704	links left	S	SAUER		2.262.0283.02
03.010.2159.000	704	rechts right	Z	SAUER		2.262.0284.02
03.010.2167.000	634	links left	S	SAUER		2.262.0285.02
03.010.2168.000	634	rechts right	Z	SAUER		2.262.0286.02
03.010.2161.000	738	links left	S	SAUER		2.262.0293.02
03.010.2162.000	738	rechts right	Z	SAUER		2.262.0294.02
03.010.2212.000	585	links left	S	SAUER		2.262.0331.01
03.010.2213.000	585	rechts right	Z	SAUER		2.262.0332.01
03.010.2240.000	569,5	links left	S	SAUER		2.262.0403.02
03.010.2241.000	569,5	rechts right	Z	SAUER		2.262.0404.02
03.010.2242.000	679,5	links left	S	SAUER		2.262.0411.02
03.010.2243.000	679,5	rechts right	Z	SAUER		2.262.0412.02
03.010.2244.000	622,5	links left	S	SAUER		2.262.0415.02
03.010.2245.000	622,5	rechts right	Z	SAUER		2.262.0416.02
03.010.2253.000	720,5	rechts right	Z	SAUER		2.262.1102.01

Bremswellen | Brake camshafts



Artikel-Nr.	Gesamtänge	Einbauseite	S / Z	passend für	Info	Ref.-Nr.
article-no.	total length	Fitting Position	S / Z	to fit to	Info	Ref.-No.
03.010.2251.000	719	rechts right	Z	SAUER		2.262.1102.02
03.010.2254.000	720,5	links left	S	SAUER		2.262.1103.01
03.010.2252.000	719	links left	S	SAUER		2.262.1103.02
03.010.2255.000	635	rechts right	Z	SAUER		2.262.1110.02
03.010.2256.000	635	links left	S	SAUER		2.262.1111.02
03.010.3500.200	632,5	rechts right	Z	SMB		M003036
03.010.3500.210	635	rechts right	S	SMB		M044465
03.010.3500.230	632,5	rechts right	S	Trailor		6503390L
03.010.3500.220	632,5	links left	Z	Trailor		6503391M
03.010.4200.850	570,5	rechts right	Z	ROR		212 19 257
03.010.4200.860	570,5	links left	S	ROR		212 19 258
03.010.4200.810	570,6	rechts right	Z	ROR		212 21 070
03.010.4200.820	570,6	links left	S	ROR		212 21 071
03.010.4200.830	632,6	rechts right	Z	ROR		212 21 194
03.010.4200.840	632,6	links left	S	ROR		212 21 195

SERVICE-HOTLINE

FON: +49 5156-9610-0

FAX: +49 5156-961196



Dichtring, Radnabe | Seal Ring, wheel hub

Dichtring, Radnabe	Aussendurchmesser	181		03.020.2037.100
Seal Ring, wheel hub	Outer Diameter (mm)			
	Innendurchmesser	164		
	Inner Diameter (mm)			
passend für to fit to	Dicke/Stärke	1		Vergl.-Nr. Comp.No
SAF	Thickness (mm)			1.093.0012.00

Distanzring | Spacer Ring

Distanzring	Aussendurchmesser	46		03.020.0244.270
Spacer Ring	Outer Diameter (mm)			
	Innendurchmesser	42		
	Inner Diameter (mm)			
passend für to fit to	Dicke/Stärke	2		Vergl.-Nr. Comp.No
Bergische Achse	Thickness (mm)			03.310.81.02.0

Distanzring	Aussendurchmesser	46,5		03.020.2037.500
Spacer Ring	Outer Diameter (mm)			
	Innendurchmesser	38,5		
	Inner Diameter (mm)			
passend für to fit to	Dicke/Stärke	1,7		Vergl.-Nr. Comp.No
SAF	Thickness (mm)			1.094.0034.00

Distanzring	Aussendurchmesser	42		03.020.2220.100
Spacer Ring	Outer Diameter (mm)			
	Innendurchmesser	36		
	Inner Diameter (mm)			
passend für to fit to	Dicke/Stärke	3		Vergl.-Nr. Comp.No
SAF	Thickness (mm)			1.094.0019.00

Distanzscheibe, Bremswelle | Spacer, brake shaft

Distanzscheibe, Bremswelle	Aussendurchmesser	42		03.020.0244.290
Spacer, brake shaft	Outer Diameter (mm)			
	Innendurchmesser	22,6		
	Inner Diameter (mm)			
passend für to fit to	Dicke/Stärke	8		Vergl.-Nr. Comp.No
Bergische Achse	Thickness (mm)			03.320.11.10.0

Distanzscheibe, Bremswelle	Aussendurchmesser	42		03.020.0244.600
Spacer, brake shaft	Outer Diameter (mm)			
	Innendurchmesser	22,5		
	Inner Diameter (mm)			
passend für to fit to	Dicke/Stärke	10,5		Vergl.-Nr. Comp.No
Bergische Achse	Thickness (mm)			03.320.11.16.0

BG-03.020

Distanzscheibe, Bremswelle Spacer, brake shaft



Distanzscheibe, Bremswelle Spacer, brake shaft				
Distanzscheibe, Bremswelle Spacer, brake shaft passend für to fit to MAN	Aussendurchmesser	61,5		03.020.0905.400 Vergl.-Nr. Comp.No 81.91710.0163
	Outer Diameter (mm)			
	Innendurchmesser	43,5		
	Inner Diameter (mm)			
	Dicke/Stärke	9		
	Thickness (mm)			
	Material	Kunststoff		
	Material	Synthetic Material		
Distanzscheibe, Bremswelle Spacer, brake shaft passend für to fit to Mercedes Benz	Aussendurchmesser	58		03.020.1909.070 Vergl.-Nr. Comp.No 346 423 05 52
	Outer Diameter (mm)			
	Innendurchmesser	44		
	Inner Diameter (mm)			
	Dicke/Stärke	4		
	Thickness (mm)			
Distanzscheibe, Bremswelle Spacer, brake shaft passend für to fit to Mercedes Benz	Breite	74		03.020.1909.080 Vergl.-Nr. Comp.No 346 423 00 57
	Width (mm)			
	Aussendurchmesser	57,8		
	Outer Diameter (mm)			
	Innendurchmesser	42,2		
	Inner Diameter (mm)			
	Dicke/Stärke	3		
	Thickness (mm)			
Distanzscheibe, Bremswelle Spacer, brake shaft passend für to fit to Mercedes-Benz	Breite	74,5		03.020.1909.090 Vergl.-Nr. Comp.No 346 423 01 57
	Width (mm)			
	Aussendurchmesser	59,6		
	Outer Diameter (mm)			
	Innendurchmesser	42		
	Inner Diameter (mm)			
	Dicke/Stärke	3		
	Thickness (mm)			
Distanzscheibe, Bremswelle Spacer, brake shaft passend für to fit to Mercedes Benz	Aussendurchmesser	42,5		03.020.1909.100 Vergl.-Nr. Comp.No 346 421 09 52
	Outer Diameter (mm)			
	Innendurchmesser	50		
	Inner Diameter (mm)			
	Dicke/Stärke	0,5		
	Thickness (mm)			
Distanzscheibe, Bremswelle Spacer, brake shaft passend für to fit to Mercedes Benz	Aussendurchmesser	42,5		03.020.1909.110 Vergl.-Nr. Comp.No 346 421 05 52
	Outer Diameter (mm)			
	Innendurchmesser	50		
	Inner Diameter (mm)			
	Dicke/Stärke	1,5		
	Thickness (mm)			

Distanzscheibe, Bremswelle Spacer, brake shaft				
Distanzscheibe, Bremswelle Spacer, brake shaft passend für to fit to Mercedes Benz	Aussendurchmesser	42,5		03.020.1909.120 Vergl.-Nr. Comp.No 346 421 06 52
	Outer Diameter (mm)			
	Innendurchmesser	50		
	Inner Diameter (mm)			
	Dicke/Stärke	2		
	Thickness (mm)			
Distanzscheibe, Bremswelle Spacer, brake shaft passend für to fit to Mercedes Benz	Aussendurchmesser	42,5		03.020.1909.130 Vergl.-Nr. Comp.No 346 421 07 52
	Outer Diameter (mm)			
	Innendurchmesser	50		
	Inner Diameter (mm)			
	Dicke/Stärke	2,5		
	Thickness (mm)			
Distanzscheibe, Bremswelle Spacer, brake shaft passend für to fit to Mercedes Benz	Aussendurchmesser	50		03.020.1909.140 Vergl.-Nr. Comp.No 346 421 08 52
	Outer Diameter (mm)			
	Innendurchmesser	35		
	Inner Diameter (mm)			
	Dicke/Stärke	1		
	Thickness (mm)			
Distanzscheibe, Bremswelle Spacer, brake shaft passend für to fit to Mercedes Benz	Aussendurchmesser	50		03.020.1909.150 Vergl.-Nr. Comp.No 346 421 10 52
	Outer Diameter (mm)			
	Innendurchmesser	35		
	Inner Diameter (mm)			
	Dicke/Stärke	2		
	Thickness (mm)			
Distanzscheibe, Bremswelle Spacer, brake shaft passend für to fit to Mercedes Benz	Aussendurchmesser	61,7		03.020.1909.720 Vergl.-Nr. Comp.No 385 421 01 52
	Outer Diameter (mm)			
	Innendurchmesser	44,7		
	Inner Diameter (mm)			
	Dicke/Stärke	9		
	Thickness (mm)			
	Material	Kunststoff		
	Material	Synthetic Material		
Distanzscheibe, Bremswelle Spacer, brake shaft passend für to fit to SAF	Aussendurchmesser	38,2		03.020.2062.000 Vergl.-Nr. Comp.No 1.331.0056.00
	Outer Diameter (mm)			
	Dicke/Stärke	1,75		
	Thickness (mm)			
Distanzscheibe, Bremswelle Spacer, brake shaft passend für to fit to SAF	Aussendurchmesser	51		03.020.2187.000 Vergl.-Nr. Comp.No 1.331.0015.00
	Outer Diameter (mm)			
	Dicke/Stärke	1		
	Thickness (mm)			

BG-03.020

Halter, Bremswellenlager Holder, brake shaft bearing



Halter, Bremswellenlager Holder, brake shaft bearing										
Halter, Bremswellenlager Holder, brake shaft bearing passend für to fit to BERGISCHE ACHSE		03.020.0238.020 Vergl.-Nr. Comp.No 03.229.02.16.0								
Halter, Bremswellenlager Holder, brake shaft bearing passend für to fit to BERGISCHE ACHSE		03.020.0238.030 Vergl.-Nr. Comp.No 03.229.02.17.0								
Halter, Bremswellenlager Holder, brake shaft bearing passend für to fit to SAF Stückliste Parts List 1 x 18.080.0242.670 Schmiernippel Grease Nipple 1 x 20.010.0241.15R Halter, Bremswellenlager Holder, brake shaft bearing		03.020.0241.150 Vergl.-Nr. Comp.No 03.229.02.03.0								
Halter, Bremswellenlager Holder, brake shaft bearing passend für to fit to BERGISCHE ACHSE		03.020.0245.380 Vergl.-Nr. Comp.No 03.229.02.01.0								
Halter, Bremswellenlager Holder, brake shaft bearing passend für to fit to BERGISCHE ACHSE		03.020.0245.390 Vergl.-Nr. Comp.No 03.229.02.10.0								
Halter, Bremswellenlager Holder, brake shaft bearing passend für to fit to BERGISCHE ACHSE		03.020.0247.900 Vergl.-Nr. Comp.No 03.229.02.18.0								
Halter, Bremswellenlager Holder, brake shaft bearing passend für to fit to FRUEHAUF		03.020.0290.190 Vergl.-Nr. Comp.No A-JB-0001-001								
Halter, Bremswellenlager Holder, brake shaft bearing passend für to fit to SAF	<table border="1"> <tr> <td>Aussendurchmesser</td> <td>120</td> </tr> <tr> <td>Outer Diameter (mm)</td> <td></td> </tr> <tr> <td>Innendurchmesser</td> <td>53,35</td> </tr> <tr> <td>Inner Diameter (mm)</td> <td></td> </tr> </table> 	Aussendurchmesser	120	Outer Diameter (mm)		Innendurchmesser	53,35	Inner Diameter (mm)		03.020.2036.200 Vergl.-Nr. Comp.No 1.350.2001.04
Aussendurchmesser	120									
Outer Diameter (mm)										
Innendurchmesser	53,35									
Inner Diameter (mm)										

**Halter, Bremswellenlager
Holder, brake shaft bearing**

Halter, Bremswellenlager Holder, brake shaft bearing		
<p>Halter, Bremswellenlager Holder, brake shaft bearing</p> <p>passend für to fit to SAF</p>		<p>03.020.2169.1 S</p> <p>Vergl.-Nr. Comp.No 3.268.0047.00</p>
<p>Halter, Bremswellenlager Holder, brake shaft bearing</p> <p>passend für to fit to SAF</p>		<p>03.020.2169.100</p> <p>Vergl.-Nr. Comp.No 3.268.0045.00</p>
<p>Halter, Bremswellenlager Holder, brake shaft bearing</p> <p>passend für to fit to SAF</p>		<p>03.020.2169.2 S</p> <p>Vergl.-Nr. Comp.No 3.268.0050.00</p>
<p>Halter, Bremswellenlager Holder, brake shaft bearing</p> <p>passend für to fit to SAF</p>		<p>03.020.2169.200</p> <p>Vergl.-Nr. Comp.No 3.268.0046.00</p>

Halteschelle Fastening Clamp										
<p>Halteschelle Fastening Clamp</p> <p>passend für to fit to Bergische Achse</p>	<table border="1"> <tr> <td>Länge</td> <td>9</td> </tr> <tr> <td>Length (mm)</td> <td></td> </tr> <tr> <td>Innendurchmesser</td> <td>49</td> </tr> <tr> <td>Inner Diameter (mm)</td> <td></td> </tr> </table>	Länge	9	Length (mm)		Innendurchmesser	49	Inner Diameter (mm)		 <p>03.020.0242.300</p> <p>Vergl.-Nr. Comp.No 03.350.30.01.0</p>
Länge	9									
Length (mm)										
Innendurchmesser	49									
Inner Diameter (mm)										

BG-03.020

Lager, Bremsnockenwelle Bearing, brake camshaft



Lager, Bremsnockenwelle | Bearing, brake camshaft

Lager, Bremsnockenwelle Bearing, brake camshaft	Breite Width (mm)	20		03.020.0905.420
passend für to fit to MAN	Aussendurchmesser Outer Diameter (mm)	52		Vergl.-Nr. Comp.No 06.33719.0057
	Innendurchmesser Inner Diameter (mm)	46		

Lagerbuchse, Bremswelle | Bushing, brake shaft

Lagerbuchse, Bremswelle Bushing, brake shaft	Aussendurchmesser Outer Diameter (mm)	42		03.020.0238.011
passend für to fit to Bergische Achse	Innendurchmesser Inner Diameter (mm)	38		Vergl.-Nr. Comp.No 03.113.14.03.0
	Dicke/Stärke Thickness (mm)	62		

Lagerbuchse, Bremswelle Bushing, brake shaft	Lochabstand 1/Lochab- stand 2 Hole Pitch 1/ Hole Pitch 2	46		03.020.0240.080
passend für to fit to Bergische Achse	Innendurchmesser Inner Diameter (mm)	42		Vergl.-Nr. Comp.No 03.112.44.30.0
	Dicke/Stärke Thickness (mm)	70,5		

Lagerbuchse, Bremswelle Bushing, brake shaft	Aussendurchmesser Outer Diameter (mm)	46		03.020.0240.082
passend für to fit to Bergische Achse	Innendurchmesser Inner Diameter (mm)	42		Vergl.-Nr. Comp.No 03.112.44.34.0
	Dicke/Stärke Thickness (mm)	72,5		

Lagerbuchse, Bremswelle Bushing, brake shaft	Lochabstand 1/Lochab- stand 2 Hole Pitch 1/ Hole Pitch 2	46		03.020.0240.090
passend für to fit to Bergische Achse	Innendurchmesser Inner Diameter (mm)	42		Vergl.-Nr. Comp.No 03.112.44.22.0
	Dicke/Stärke Thickness (mm)	77		

Lagerbuchse, Bremswelle Bushing, brake shaft	Aussendurchmesser Outer Diameter (mm)	42		03.020.0240.150
passend für to fit to Bergische Achse	Innendurchmesser Inner Diameter (mm)	38		Vergl.-Nr. Comp.No 03.113.14.01.0
	Dicke/Stärke Thickness (mm)	60		

Lagerbuchse, Bremswelle Bushing, brake shaft	Aussendurchmesser Outer Diameter (mm)	45		03.020.0247.800
passend für to fit to Bergische Achse	Innendurchmesser Inner Diameter (mm)	42		Vergl.-Nr. Comp.No 03.113.03.06.0
	Dicke/Stärke Thickness (mm)	37,5		

Lagerbuchse, Bremswelle Bushing, brake shaft				
Lagerbuchse, Bremswelle Bushing, brake shaft	Lochabstand 1/Lochabstand 2 Hole Pitch 1/ Hole Pitch 2	50		03.020.0690.000 Vergl.-Nr. Comp.No 015.26.22.101.51
passend für to fit to Kässbohrer	Innendurchmesser Inner Diameter (mm)	45		
Lagerbuchse, Bremswelle Bushing, brake shaft	Aussendurchmesser Outer Diameter (mm)	50		
passend für to fit to Kässbohrer	Innendurchmesser Inner Diameter (mm)	50		03.020.0691.000 Vergl.-Nr. Comp.No 015.26.22.103.51
Lagerbuchse, Bremswelle Bushing, brake shaft	Dicke/Stärke Thickness (mm)	62		
passend für to fit to SAF	Innendurchmesser Inner Diameter (mm)	42		
Lagerbuchse, Bremswelle Bushing, brake shaft	Lochabstand 1/Lochabstand 2 Hole Pitch 1/ Hole Pitch 2	46		03.020.2003.000 Vergl.-Nr. Comp.No 1.230.0036.00
passend für to fit to SAF	Innendurchmesser Inner Diameter (mm)	42		
Lagerbuchse, Bremswelle Bushing, brake shaft	Dicke/Stärke Thickness (mm)	35		
passend für to fit to SAF	Innendurchmesser Inner Diameter (mm)	42		03.020.2008.000 Vergl.-Nr. Comp.No 1.230.0062.00
Lagerbuchse, Bremswelle Bushing, brake shaft	Lochabstand 1/Lochabstand 2 Hole Pitch 1/ Hole Pitch 2	46		
passend für to fit to SAF	Innendurchmesser Inner Diameter (mm)	42		
Lagerbuchse, Bremswelle Bushing, brake shaft	Lochabstand 1/Lochabstand 2 Hole Pitch 1/ Hole Pitch 2	50,3		03.020.2017.000 Vergl.-Nr. Comp.No 1.230.0089.00
passend für to fit to SAF	Innendurchmesser Inner Diameter (mm)	40		
Lagerbuchse, Bremswelle Bushing, brake shaft	Dicke/Stärke Thickness (mm)	112		
passend für to fit to SAF	Innendurchmesser Inner Diameter (mm)	38		03.020.2028.100 Vergl.-Nr. Comp.No 1.230.1002.04
Lagerbuchse, Bremswelle Bushing, brake shaft	Dicke/Stärke Thickness (mm)	60		
passend für to fit to SAF	Innendurchmesser Inner Diameter (mm)	38		
passend für to fit to SAF	Dicke/Stärke Thickness (mm)	60		03.020.2029.100 Vergl.-Nr. Comp.No 3.230.1002.03
Lagerbuchse, Bremswelle Bushing, brake shaft	Innendurchmesser Inner Diameter (mm)	38		
passend für to fit to SAF	Dicke/Stärke Thickness (mm)	60		
Stückliste Parts List	1 x 03.020.2029.000 Lagerbuchse, Bremswelle Bushing, brake shaft 1 x 18.080.1252.000 Zier-/Schutzleiste, Seitenscheibe Trim, side window			

BG-03.020

Lagerbuchse, Bremswelle Bushing, brake shaft



Lagerbuchse, Bremswelle Bushing, brake shaft				
Lagerbuchse, Bremswelle Bushing, brake shaft passend für to fit to SAF	Breite	33		03.020.2038.200 Vergl.-Nr. Comp.No 4.230.0176.00
	Width (mm)			
	Innendurchmesser	56		
	Inner Diameter (mm)			
Lagerbuchse, Bremswelle Bushing, brake shaft passend für to fit to SAF	Breite	40		03.020.2038.300 Vergl.-Nr. Comp.No 4.230.0180.00
	Width (mm)			
	Innendurchmesser	46		
	Inner Diameter (mm)			
Lagerbuchse, Bremswelle Bushing, brake shaft passend für to fit to SAF	Breite	22		03.020.2044.000 Vergl.-Nr. Comp.No 1.072.0017.01
	Width (mm)			
	Aussendurchmesser 1	48		
	Outer Diameter 1 (mm)			
	Aussendurchmesser 2	52		
	Outer Diameter 2 (mm)			
	Innendurchmesser	38		
	Inner Diameter (mm)			
Material	Nylon			
Material				
Farbe	weiß			
Colour	White			
Lagerbuchse, Bremswelle Bushing, brake shaft passend für to fit to SAF	Breite	22		03.020.2045.000 Vergl.-Nr. Comp.No 1.072.0018.00
	Width (mm)			
	Aussendurchmesser 1	48		
	Outer Diameter 1 (mm)			
	Aussendurchmesser 2	52		
	Outer Diameter 2 (mm)			
	Innendurchmesser	38		
	Inner Diameter (mm)			
Material	Nylon			
Material				
Farbe	gelb			
Colour	Yellow			
Lagerbuchse, Bremswelle Bushing, brake shaft passend für to fit to SAF	Lochabstand 1/Lochabstand 2	38		03.020.2144.000 Vergl.-Nr. Comp.No 1.230.1001.01
	Hole Pitch 1/ Hole Pitch 2			
	Aussendurchmesser	42		
	Outer Diameter (mm)			
	Dicke/Stärke	60		
Thickness (mm)				
Lagerbuchse, Bremswelle Bushing, brake shaft passend für to fit to SAF	Länge	44,8		03.020.2147.000 Vergl.-Nr. Comp.No 1.230.0106.02
	Length (mm)			
	Lochabstand 1/Lochabstand 2	42		
	Hole Pitch 1/ Hole Pitch 2			
	Innendurchmesser	38		
Inner Diameter (mm)				

Lagerbuchse, Bremswelle Bushing, brake shaft				
Lagerbuchse, Bremswelle Bushing, brake shaft	Innendurchmesser	42		03.020.2183.000
	Inner Diameter (mm)			
passend für to fit to SAF	Material	Stahl		Vergl.-Nr. Comp.No 1.072.0060.00
	Material	Steel		
Lagerbuchse, Bremswelle Bushing, brake shaft	Höhe	63		03.020.2184.000
	Height (mm)			
passend für to fit to SAF	Aussendurchmesser	69		Vergl.-Nr. Comp.No 1.230.2001.01
	Outer Diameter (mm)			
Stückliste Parts List 2 x 03.020.2185.000 Dichtung Gasket / Seal 1 x 18.080.1203.000 Sensor, Kraftstoffdruck Sensor, fuel pressure	Innendurchmesser	38		
	Inner Diameter (mm)			
Lagerbuchse, Bremswelle Bushing, brake shaft	Höhe	26		03.020.3004.520
	Height (mm)			
passend für to fit to Scania	Aussendurchmesser	42		Vergl.-Nr. Comp.No 134 494
	Outer Diameter (mm)			
Lagerbuchse, Bremswelle Bushing, brake shaft	Innendurchmesser	38		03.020.4004.890
	Inner Diameter (mm)			
passend für to fit to Volvo	Aussendurchmesser	49		Vergl.-Nr. Comp.No 1573 522
	Outer Diameter (mm)			
Lagerbuchse, Bremswelle Bushing, brake shaft	Innendurchmesser	44		03.020.4200.450
	Inner Diameter (mm)			
passend für to fit to ROR	Einbauseite	innen		Vergl.-Nr. Comp.No 152 20 224
	Fitting Position	inner		
Lagerbuchse, Bremswelle Bushing, brake shaft	Aussendurchmesser 1	99		03.020.4200.460
	Outer Diameter 1 (mm)			
passend für to fit to ROR	Aussendurchmesser 2	99		Vergl.-Nr. Comp.No 152 13 430
	Outer Diameter 2 (mm)			
Lagerbuchse, Bremswelle Bushing, brake shaft	Innendurchmesser	42,5		
	Inner Diameter (mm)			
Lagerbuchse, Bremswelle Bushing, brake shaft	Höhe	45		03.020.4200.460
	Height (mm)			
passend für to fit to ROR	Einbauseite	außen		Vergl.-Nr. Comp.No 152 13 430
	Fitting Position	Outer		
Lagerbuchse, Bremswelle Bushing, brake shaft	Aussendurchmesser 1	86,5		
	Outer Diameter 1 (mm)			
passend für to fit to ROR	Aussendurchmesser 2	86,5		
	Outer Diameter 2 (mm)			
Lagerbuchse, Bremswelle Bushing, brake shaft	Innendurchmesser	38		
	Inner Diameter (mm)			

BG-03.020

Lagerbuchse, Bremswelle Bushing, brake shaft





Lagerbuchse, Bremswelle | Bushing, brake shaft

Lagerbuchse, Bremswelle	Höhe	50		03.020.4200.480
Bushing, brake shaft	Height (mm)			
passend für to fit to	Aussendurchmesser	47,7		
ROR	Innendurchmesser	43		
	Outer Diameter (mm)			Vergl.-Nr. Comp.No
	Inner Diameter (mm)			212 09 990

Reparatursatz, Bremsnockenwelle | Repair Kit, brake camshaft

Reparatursatz, Bremsnockenwelle		03.020.0241.0 S	
Repair Kit, brake camshaft			Vergl.-Nr. Comp.No
passend für to fit to			09.801.00.14.0
Bergische Achse			
Stückliste Parts List			
2 x 03.020.0242.600 Sicherungsring Circlip			
1 x 03.020.0242.620 Dichtung Gasket / Seal			
1 x 03.020.0243.520 Dichtung Gasket / Seal			
1 x 03.020.0244.270 Distanzring Spacer Ring			
1 x 03.020.0244.280 Dichtung Gasket / Seal			
1 x 03.020.0244.290 Distanzscheibe, Bremswelle Spacer, brake shaft			
1 x 13.020.0241.500 Distanzscheibe Spacer			
1 x 18.060.0241.230 Mutter Nut			

Reparatursatz, Bremsnockenwelle		03.020.0241.1 S	
Repair Kit, brake camshaft			Vergl.-Nr. Comp.No
passend für to fit to			09.801.00.14.1
Bergische Achse			
Stückliste Parts List			
2 x 03.020.0242.600 Sicherungsring Circlip			
1 x 03.020.0242.620 Dichtung Gasket / Seal			
1 x 03.020.0243.520 Dichtung Gasket / Seal			
1 x 03.020.0244.270 Distanzring Spacer Ring			
1 x 03.020.0244.280 Dichtung Gasket / Seal			
1 x 03.020.0244.600 Distanzscheibe, Bremswelle Spacer, brake shaft			
2 x 03.020.0244.700 Sicherungsring Circlip			
1 x 13.020.0241.500 Distanzscheibe Spacer			
1 x 18.060.0241.230 Mutter Nut			

Reparatursatz, Bremsnockenwelle		03.020.0241.2 S	
Repair Kit, brake camshaft			Vergl.-Nr. Comp.No
passend für to fit to			09.801.00.14.2
Bergische Achse			
Stückliste Parts List			
1 x 03.020.0240.840 Dichtung Gasket / Seal			
1 x 03.020.0241.740 Distanzscheibe, Bremswelle Spacer, brake shaft			
1 x 03.020.0242.300 Halteschelle Fastening Clamp			
2 x 03.020.0242.600 Sicherungsring Circlip			
1 x 03.020.0243.520 Dichtung Gasket / Seal			
1 x 03.020.0244.280 Dichtung Gasket / Seal			
1 x 03.020.0244.600 Distanzscheibe, Bremswelle Spacer, brake shaft			
1 x 03.020.0244.700 Sicherungsring Circlip			
1 x 18.060.0241.230 Mutter Nut			

Reparatursatz, Bremsnockenwelle | Repair Kit, brake camshaft

Reparatursatz, Bremsnockenwelle

Repair Kit, brake camshaft

passend für | to fit to

Bergische Achse

Stückliste | Parts List

- 1 x 03.020.0240.840 Dichtung | Gasket / Seal
- 1 x 03.020.0242.300 Halteschelle | Fastening Clamp
- 1 x 03.020.0242.600 Sicherungsring | Circlip
- 1 x 03.020.0243.520 Dichtung | Gasket / Seal
- 1 x 03.020.0244.270 Distanzring | Spacer Ring
- 1 x 03.020.0244.280 Dichtung | Gasket / Seal
- 1 x 03.020.0244.600 Distanzscheibe, Bremswelle | Spacer, brake shaft
- 1 x 03.020.0244.700 Sicherungsring | Circlip
- 1 x 18.060.0241.230 Mutter | Nut

03.020.0241.3 S

 Vergl.-Nr. | Comp.No
09.801.00.24.1

Reparatursatz, Bremsnockenwelle

Repair Kit, brake camshaft

passend für | to fit to

Bergische Achse

Stückliste | Parts List

- 1 x 03.020.0240.082 Lagerbuchse, Bremswelle | Bushing, brake shaft
- 1 x 03.020.0240.150 Lagerbuchse, Bremswelle | Bushing, brake shaft
- 1 x 03.020.0240.840 Dichtung | Gasket / Seal
- 1 x 03.020.0242.300 Halteschelle | Fastening Clamp
- 2 x 03.020.0242.600 Sicherungsring | Circlip
- 1 x 03.020.0242.620 Dichtung | Gasket / Seal
- 1 x 03.020.0243.520 Dichtung | Gasket / Seal
- 1 x 03.020.0244.270 Distanzring | Spacer Ring
- 1 x 03.020.0244.280 Dichtung | Gasket / Seal
- 1 x 03.020.0244.600 Distanzscheibe, Bremswelle | Spacer, brake shaft
- 2 x 03.020.0244.700 Sicherungsring | Circlip
- 1 x 03.020.0245.380 Halter, Bremswellenlager | Holder, brake shaft bearing
- 1 x 03.020.0245.390 Halter, Bremswellenlager | Holder, brake shaft bearing
- 1 x 03.020.0246.230 Dichtung | Gasket / Seal
- 6 x 03.020.0246.250 Mutter | Nut
- 1 x 13.020.0241.500 Distanzscheibe | Spacer
- 6 x 18.050.0244.240 Schraube | Screw / Bolt
- 1 x 18.060.0241.230 Mutter | Nut
- 1 x 18.080.0242.670 Schmiernippel | Grease Nipple

03.020.0241.4 S

 Vergl.-Nr. | Comp.No
09.801.00.14.1 S

Reparatursatz, Bremsnockenwelle

Repair Kit, brake camshaft

passend für | to fit to

Bergische Achse

Stückliste | Parts List

- 2 x 03.020.0240.840 Dichtung | Gasket / Seal
- 1 x 03.020.0241.740 Distanzscheibe, Bremswelle | Spacer, brake shaft
- 2 x 03.020.0242.600 Sicherungsring | Circlip
- 1 x 03.020.0242.620 Dichtung | Gasket / Seal
- 2 x 03.020.0243.520 Dichtung | Gasket / Seal
- 1 x 03.020.0244.270 Distanzring | Spacer Ring
- 1 x 03.020.0244.280 Dichtung | Gasket / Seal
- 1 x 03.020.0244.600 Distanzscheibe, Bremswelle | Spacer, brake shaft
- 2 x 03.020.0247.800 Lagerbuchse, Bremswelle | Bushing, brake shaft
- 1 x 18.060.0241.230 Mutter | Nut

03.020.0241.5 S

 Vergl.-Nr. | Comp.No
09.801.00.43.1

BG-03.020

Reparatursatz, Bremsnockenwelle Repair Kit, brake camshaft



Reparatursatz, Bremsnockenwelle | Repair Kit, brake camshaft

Reparatursatz, Bremsnockenwelle

Repair Kit, brake camshaft

passend für | to fit to

Bergische Achse

Stückliste | Parts List

- 2 x 03.020.0240.150 Lagerbuchse, Bremswelle | Bushing, brake shaft
- 2 x 03.020.0245.380 Halter, Bremswellenlager | Holder, brake shaft bearing
- 2 x 03.020.0245.390 Halter, Bremswellenlager | Holder, brake shaft bearing
- 2 x 03.020.0246.250 Mutter | Nut
- 2 x 18.080.0242.670 Schmiernippel | Grease Nipple
- 2 x 18.080.1256.000 Ruß-/Partikelfilter, Abgasanlage | Soot-/ Particle Filter, exhaust system
- 12 x 20.990.0246.840 Schraubensatz | Srewset



03.020.0241.6 S

Vergl.-Nr. | Comp.No
09.801.02.15.0

Reparatursatz, Bremsnockenwelle

Repair Kit, brake camshaft

passend für | to fit to

Bergische Achse

Stückliste | Parts List

- 1 x 03.020.0242.600 Sicherungsring | Circlip
- 1 x 03.020.0244.290 Distanzscheibe, Bremswelle | Spacer, brake shaft
- 2 x 06.070.1057.000 Dichtring | Seal Ring
- 1 x 13.020.0241.500 Distanzscheibe | Spacer
- 1 x 18.060.0241.230 Mutter | Nut



03.020.0242.0 S

Vergl.-Nr. | Comp.No
09.801.00.26.0 S

Reparatursatz, Bremsnockenwelle

Repair Kit, brake camshaft

passend für | to fit to

Bergische Achse

Stückliste | Parts List

- 1 x 03.020.0240.082 Lagerbuchse, Bremswelle | Bushing, brake shaft
- 1 x 03.020.0240.150 Lagerbuchse, Bremswelle | Bushing, brake shaft
- 2 x 03.020.0240.840 Dichtung | Gasket / Seal
- 2 x 03.020.0242.300 Halteschelle | Fastening Clamp
- 1 x 03.020.0244.270 Distanzring | Spacer Ring
- 1 x 03.020.0245.380 Halter, Bremswellenlager | Holder, brake shaft bearing
- 1 x 03.020.0245.390 Halter, Bremswellenlager | Holder, brake shaft bearing
- 6 x 06.070.1020.000 Federring | Springwasher
- 6 x 18.050.0244.240 Schraube | Screw / Bolt
- 6 x 18.060.1021.000 Mutter | Nut
- 1 x 18.080.0242.670 Schmiernippel | Grease Nipple



03.020.0242.3 S

Vergl.-Nr. | Comp.No
03.112.44.30.0 S

Reparatursatz, Bremsnockenwelle | Repair Kit, brake camshaft

Reparatursatz, Bremsnockenwelle

Repair Kit, brake camshaft

passend für | to fit to

Bergische Achse

Stückliste | Parts List

1 x 03.020.0240.082 Lagerbuchse, Bremswelle | Bushing, brake shaft
 1 x 03.020.0240.150 Lagerbuchse, Bremswelle | Bushing, brake shaft
 2 x 03.020.0240.840 Dichtung | Gasket / Seal
 2 x 03.020.0242.300 Halteschelle | Fastening Clamp
 1 x 03.020.0244.270 Distanzring | Spacer Ring
 1 x 03.020.0245.380 Halter, Bremswellenlager | Holder, brake shaft bearing
 1 x 03.020.0245.390 Halter, Bremswellenlager | Holder, brake shaft bearing
 6 x 06.070.1020.000 Federring | Springwasher
 6 x 18.050.0244.240 Schraube | Screw / Bolt
 6 x 18.060.1021.000 Mutter | Nut
 1 x 18.080.0242.670 Schmiernippel | Grease Nipple

03.020.0242.4 S

Vergl.-Nr. | Comp.No

03.112.44.30.0 S

Reparatursatz, Bremsnockenwelle

Repair Kit, brake camshaft

passend für | to fit to

Bergische Achse

Stückliste | Parts List

1 x 03.020.0240.082 Lagerbuchse, Bremswelle | Bushing, brake shaft
 1 x 03.020.0240.150 Lagerbuchse, Bremswelle | Bushing, brake shaft
 1 x 03.020.0240.840 Dichtung | Gasket / Seal
 1 x 03.020.0242.300 Halteschelle | Fastening Clamp
 1 x 03.020.0244.270 Distanzring | Spacer Ring
 1 x 03.020.0245.380 Halter, Bremswellenlager | Holder, brake shaft bearing
 1 x 03.020.0245.390 Halter, Bremswellenlager | Holder, brake shaft bearing
 1 x 03.020.0246.230 Dichtung | Gasket / Seal
 6 x 03.020.0246.250 Mutter | Nut
 6 x 18.050.0244.240 Schraube | Screw / Bolt
 1 x 18.080.0242.670 Schmiernippel | Grease Nipple

03.020.0242.5 S

Vergl.-Nr. | Comp.No

Reparatursatz, Bremsnockenwelle

Repair Kit, brake camshaft

passend für | to fit to

Bergische Achse

Stückliste | Parts List

1 x 03.020.0240.082 Lagerbuchse, Bremswelle | Bushing, brake shaft
 1 x 03.020.0240.150 Lagerbuchse, Bremswelle | Bushing, brake shaft
 2 x 03.020.0240.840 Dichtung | Gasket / Seal
 2 x 03.020.0242.300 Halteschelle | Fastening Clamp
 1 x 03.020.0244.270 Distanzring | Spacer Ring
 1 x 03.020.0245.380 Halter, Bremswellenlager | Holder, brake shaft bearing
 1 x 03.020.0245.390 Halter, Bremswellenlager | Holder, brake shaft bearing
 1 x 03.020.0246.230 Dichtung | Gasket / Seal
 6 x 03.020.0246.250 Mutter | Nut
 6 x 18.050.0244.240 Schraube | Screw / Bolt
 1 x 18.080.0242.670 Schmiernippel | Grease Nipple

03.020.0242.6 S

Vergl.-Nr. | Comp.No

BG-03.020

Reparatursatz, Bremsnockenwelle Repair Kit, brake camshaft



Reparatursatz, Bremsnockenwelle | Repair Kit, brake camshaft

Reparatursatz, Bremsnockenwelle

Repair Kit, brake camshaft

passend für | to fit to

Bergische Achse

Stückliste | Parts List

- 1 x 03.020.0240.082 Lagerbuchse, Bremswelle | Bushing, brake shaft
- 1 x 03.020.0240.150 Lagerbuchse, Bremswelle | Bushing, brake shaft
- 1 x 03.020.0240.840 Dichtung | Gasket / Seal
- 1 x 03.020.0241.2 S Reparatursatz, Bremsnockenwelle | Repair Kit, brake camshaft
- 1 x 03.020.0242.300 Halteschelle | Fastening Clamp
- 1 x 03.020.0245.380 Halter, Bremswellenlager | Holder, brake shaft bearing
- 1 x 03.020.0245.390 Halter, Bremswellenlager | Holder, brake shaft bearing
- 1 x 03.020.0246.230 Dichtung | Gasket / Seal
- 6 x 06.070.1020.000 Federring | Springwasher
- 6 x 18.050.0244.240 Schraube | Screw / Bolt
- 6 x 18.060.1021.000 Mutter | Nut
- 1 x 18.080.0242.670 Schmiernippel | Grease Nipple
- 1 x 18.080.1256.000 Ruß-/Partikelfilter, Abgasanlage | Soot-/ Particle Filter, exhaust system



03.020.0242.7 S

Vergl.-Nr. | Comp.No
09.801.02.13.0

Reparatursatz, Bremsnockenwelle

Repair Kit, brake camshaft

passend für | to fit to

Bergische Achse

Stückliste | Parts List

- 2 x 03.020.0238.011 Lagerbuchse, Bremswelle | Bushing, brake shaft
- 2 x 03.020.0238.020 Halter, Bremswellenlager | Holder, brake shaft bearing
- 2 x 03.020.0238.030 Halter, Bremswellenlager | Holder, brake shaft bearing
- 2 x 03.020.0238.040 Dichtung | Gasket / Seal
- 2 x 03.020.0240.082 Lagerbuchse, Bremswelle | Bushing, brake shaft
- 2 x 03.020.0240.840 Dichtung | Gasket / Seal
- 2 x 03.020.0241.2 S Reparatursatz, Bremsnockenwelle | Repair Kit, brake camshaft
- 2 x 03.020.0242.300 Halteschelle | Fastening Clamp
- 2 x 03.020.0246.230 Dichtung | Gasket / Seal
- 12 x Federring | Springwasher
- 06.070.1020.000
- 12 x Schraube | Screw / Bolt
- 18.050.0244.240
- 12 x Mutter | Nut
- 18.060.1021.000
- 2 x 18.080.0238.050 Schmiernippel | Grease Nipple
- 2 x 18.080.1256.000 Ruß-/Partikelfilter, Abgasanlage | Soot-/ Particle Filter, exhaust system
- 2 x 18.080.1365.000 Prüfstraße | Inspection Lane



03.020.0242.81S

Vergl.-Nr. | Comp.No
09.801.02.22.0

Reparatursatz, Bremsnockenwelle

Repair Kit, brake camshaft

passend für | to fit to

Bergische Achse

Stückliste | Parts List

- 2 x 03.020.0240.082 Lagerbuchse, Bremswelle | Bushing, brake shaft
- 2 x 03.020.S7660000 Reparatursatz, Bremsnockenwelle | Repair Kit, brake camshaft



03.020.0242.85S

Vergl.-Nr. | Comp.No
09.801.06.09.1

**Reparatursatz, Bremsnockenwelle
Repair Kit, brake camshaft**
Reparatursatz, Bremsnockenwelle | Repair Kit, brake camshaft

Reparatursatz, Bremsnockenwelle

Repair Kit, brake camshaft

passend für | to fit to

Bergische Achse

Stückliste | Parts List

2 x 03.020.0240.090 Lagerbuchse, Bremswelle | Bushing, brake shaft
 2 x 03.020.0240.150 Lagerbuchse, Bremswelle | Bushing, brake shaft
 4 x 03.020.0240.840 Dichtung | Gasket / Seal
 4 x 03.020.0242.600 Sicherungsring | Circlip
 2 x 03.020.0242.620 Dichtung | Gasket / Seal
 2 x 03.020.0243.520 Dichtung | Gasket / Seal
 2 x 03.020.0244.270 Distanzring | Spacer Ring
 2 x 03.020.0244.280 Dichtung | Gasket / Seal
 2 x 03.020.0244.740 Sicherungsring | Circlip
 2 x 03.020.0246.230 Dichtung | Gasket / Seal
 2 x 13.020.0241.500 Distanzscheibe | Spacer
 2 x 18.060.0241.230 Mutter | Nut

03.020.0243.2 S

 Vergl.-Nr. | Comp.No
02.5616.05.90

Reparatursatz, Bremsnockenwelle

Repair Kit, brake camshaft

passend für | to fit to

Bergische Achse

Stückliste | Parts List

2 x 03.020.0240.082 Lagerbuchse, Bremswelle | Bushing, brake shaft
 2 x 03.020.0240.150 Lagerbuchse, Bremswelle | Bushing, brake shaft
 1 x 03.020.0240.840 Dichtung | Gasket / Seal
 1 x 03.020.0241.740 Distanzscheibe, Bremswelle | Spacer, brake shaft
 1 x 03.020.0242.300 Halteschelle | Fastening Clamp
 2 x 03.020.0242.600 Sicherungsring | Circlip
 2 x 03.020.0242.620 Dichtung | Gasket / Seal
 1 x 03.020.0243.520 Dichtung | Gasket / Seal
 1 x 03.020.0244.280 Dichtung | Gasket / Seal
 1 x 03.020.0244.600 Distanzscheibe, Bremswelle | Spacer, brake shaft
 1 x 03.020.0244.700 Sicherungsring | Circlip
 2 x 03.020.0245.380 Halter, Bremswellenlager | Holder, brake shaft bearing
 2 x 03.020.0245.390 Halter, Bremswellenlager | Holder, brake shaft bearing
 2 x 03.020.0246.230 Dichtung | Gasket / Seal
 1 x 18.060.0241.230 Mutter | Nut
 2 x 18.080.0242.670 Schmiernippel | Grease Nipple
 2 x 18.080.1365.000 Prüfstraße | Inspection Lane

03.020.0246.3 S

 Vergl.-Nr. | Comp.No
03.113.14.01.0 S

Reparatursatz, Bremsnockenwelle

Repair Kit, brake camshaft

passend für | to fit to

Frühauf

03.020.0290.410

 Vergl.-Nr. | Comp.No
AR-JA-0199-705

Reparatursatz, Bremsnockenwelle

Repair Kit, brake camshaft

passend für | to fit to

Kässbohrer

03.020.0692.0 S

 Vergl.-Nr. | Comp.No
8.951.038.200





BG-03.020

Reparatursatz, Bremsnockenwelle Repair Kit, brake camshaft



Reparatursatz, Bremsnockenwelle Repair Kit, brake camshaft		
<p>Reparatursatz, Bremsnockenwelle Repair Kit, brake camshaft</p> <p>passend für to fit to MAN</p> <p>Stückliste Parts List 1 x 03.020.0909.0 R Reparatursatz, Bremsnockenwelle Repair Kit, brake camshaft 2 x 09.010.1909.060 Gelenklager Joint Bearing</p>		<p>03.020.0909.0 S</p> <p>Vergl.-Nr. Comp.No 81.51901.6005</p>
<p>Reparatursatz, Bremsnockenwelle Repair Kit, brake camshaft</p> <p>passend für to fit to MAN</p> <p>Stückliste Parts List 1 x 03.020.0905.400 Distanzscheibe, Bremswelle Spacer, brake shaft 2 x 03.020.0905.420 Lager, Bremsnockenwelle Bearing, brake camshaft 1 x 03.020.1909.090 Distanzscheibe, Bremswelle Spacer, brake shaft 1 x 03.020.1909.100 Distanzscheibe, Bremswelle Spacer, brake shaft 1 x 03.020.1909.110 Distanzscheibe, Bremswelle Spacer, brake shaft 1 x 03.020.1909.120 Distanzscheibe, Bremswelle Spacer, brake shaft 1 x 03.020.1909.130 Distanzscheibe, Bremswelle Spacer, brake shaft 1 x 03.020.1909.150 Distanzscheibe, Bremswelle Spacer, brake shaft 1 x 03.020.1909.160 Sicherungsring Circlip 2 x 11.060.0905.410 Wellendichtring Shaft Oil Seal</p>		<p>03.020.0910.0 S</p> <p>Vergl.-Nr. Comp.No 81.51901.6006</p>
<p>Reparatursatz, Bremsnockenwelle Repair Kit, brake camshaft</p> <p>passend für to fit to Mercedes Benz; MAN</p> <p>Stückliste Parts List 1 x 03.020.1902.0R0 Reparatursatz, Bremsnockenwelle Repair Kit, brake camshaft 2 x 09.010.1909.060 Gelenklager Joint Bearing</p>		<p>03.020.1902.0 S</p> <p>Vergl.-Nr. Comp.No 06.36959.0014 S</p>
<p>Reparatursatz, Bremsnockenwelle Repair Kit, brake camshaft</p> <p>passend für to fit to Mercedes Benz</p> <p>Stückliste Parts List 1 x 03.020.1905.0R0 Reparatursatz, Bremsnockenwelle Repair Kit, brake camshaft 2 x 09.010.1909.060 Gelenklager Joint Bearing</p>		<p>03.020.1905.0 S</p> <p>Vergl.-Nr. Comp.No 360 420 03 41</p>

Reparatursatz, Bremsnockenwelle | Repair Kit, brake camshaft

<p>Reparatursatz, Bremsnockenwelle Repair Kit, brake camshaft</p> <p>passend für to fit to Mercedes Benz</p> <p>Stückliste Parts List</p> <p>1 x 03.020.1909.090 Distanzscheibe, Bremswelle Spacer, brake shaft 2 x 03.020.1909.110 Distanzscheibe, Bremswelle Spacer, brake shaft 1 x 03.020.1909.120 Distanzscheibe, Bremswelle Spacer, brake shaft 1 x 03.020.1909.130 Distanzscheibe, Bremswelle Spacer, brake shaft 1 x 03.020.1909.150 Distanzscheibe, Bremswelle Spacer, brake shaft 1 x 03.020.1909.160 Sicherungsring Circlip 1 x 03.020.1909.720 Distanzscheibe, Bremswelle Spacer, brake shaft 1 x 04.100.0904.680 Buchse Bush 1 x 04.100.0904.690 Buchse Bush 1 x 11.060.1906.170 Wellendichtring Shaft Oil Seal 1 x 11.060.1909.030 Wellendichtring Shaft Oil Seal</p>		<p>03.020.1905.1 S</p> <p>Vergl.-Nr. Comp.No 305 421 07 50 S</p>
<p>Reparatursatz, Bremsnockenwelle Repair Kit, brake camshaft</p> <p>passend für to fit to SAF</p> <p>Stückliste Parts List</p> <p>1 x 03.020.2062.000 Distanzscheibe, Bremswelle Spacer, brake shaft 1 x 03.020.2063.000 Sicherungsring Circlip 6 x 03.020.2187.000 Distanzscheibe, Bremswelle Spacer, brake shaft 1 x 03.020.2188.000 Sicherungsring Circlip 1 x 04.110.2186.000 Federring Springwasher</p>		<p>03.020.2001.S00</p> <p>Vergl.-Nr. Comp.No 3.317.0004.00</p>
<p>Reparatursatz, Bremsnockenwelle Repair Kit, brake camshaft</p> <p>passend für to fit to SAF</p> <p>Stückliste Parts List</p> <p>1 x 03.020.2028.100 Lagerbuchse, Bremswelle Bushing, brake shaft 2 x 03.020.2036.200 Halter, Bremswellenlager Holder, brake shaft bearing 5 x 06.070.1020.000 Federring Springwasher 5 x 18.050.2028.200 Schraube Screw 5 x 18.060.1021.000 Mutter Nut</p>		<p>03.020.2028.S00</p> <p>Vergl.-Nr. Comp.No 3.268.0007.02</p>
<p>Reparatursatz, Bremsnockenwelle Repair Kit, brake camshaft</p> <p>passend für to fit to SAF</p> <p>Stückliste Parts List</p> <p>1 x 03.020.2029.100 Lagerbuchse, Bremswelle Bushing, brake shaft 2 x 03.020.2036.200 Halter, Bremswellenlager Holder, brake shaft bearing 5 x 03.070.2065.000 Schraube Screw / Bolt 5 x 06.070.1020.000 Federring Springwasher 5 x 18.060.1021.000 Mutter Nut</p>		<p>03.020.2029.S00</p> <p>Vergl.-Nr. Comp.No 3.268.0007.01</p>

BG-03.020

Reparatursatz, Bremsnockenwelle Repair Kit, brake camshaft



Reparatursatz, Bremsnockenwelle Repair Kit, brake camshaft		
Reparatursatz, Bremsnockenwelle Repair Kit, brake camshaft passend für to fit to SAF		03.020.2029.200 Vergl.-Nr. Comp.No 3.317.0011.00
Reparatursatz, Bremsnockenwelle Repair Kit, brake camshaft passend für to fit to SAF		03.020.2029.300 Vergl.-Nr. Comp.No 3.317.0016.00
Reparatursatz, Bremsnockenwelle Repair Kit, brake camshaft passend für to fit to SAF Stückliste Parts List 2 x 03.020.2169.000 Halter, Bremswellenlager Holder, brake shaft bearing 1 x 03.020.2184.000 Lagerbuchse, Bremswelle Bushing, brake shaft 2 x 03.070.2065.000 Schraube Screw / Bolt 2 x 06.070.1020.000 Federring Springwasher 2 x 18.060.1021.000 Mutter Nut		03.020.2029.400 Vergl.-Nr. Comp.No 3.268.0006.00
Reparatursatz, Bremsnockenwelle Repair Kit, brake camshaft passend für to fit to SAF		03.020.2060.S00 Vergl.-Nr. Comp.No
Reparatursatz, Bremsnockenwelle Repair Kit, brake camshaft passend für to fit to SAF		03.020.2160.S00 Vergl.-Nr. Comp.No 3.317.0006.00
Reparatursatz, Bremsnockenwelle Repair Kit, brake camshaft passend für to fit to SAF Stückliste Parts List 1 x 03.020.2044.000 Lagerbuchse, Bremswelle Bushing, brake shaft 1 x 03.020.2045.000 Lagerbuchse, Bremswelle Bushing, brake shaft 2 x 03.020.2046.000 Dichtung Gasket / Seal 2 x 03.020.2052.000 Dichtung Gasket / Seal 1 x 03.020.2062.000 Distanzscheibe, Bremswelle Spacer, brake shaft 1 x 03.020.2063.000 Sicherungsring Circlip 1 x 03.020.2184.000 Lagerbuchse, Bremswelle Bushing, brake shaft 6 x 03.020.2187.000 Distanzscheibe, Bremswelle Spacer, brake shaft 1 x 03.020.2188.000 Sicherungsring Circlip 1 x 04.110.2186.000 Federring Springwasher		03.020.2184.S00 Vergl.-Nr. Comp.No 1.230.2001.01 S

Reparatursatz, Bremsnockenwelle | Repair Kit, brake camshaft

Reparatursatz, Bremsnockenwelle

Repair Kit, brake camshaft

passend für | to fit to

SAF

Stückliste | Parts List

- 2 x 03.020.2028.100 Lagerbuchse, Bremswelle | Bushing, brake shaft
- 4 x 03.020.2036.200 Halter, Bremswellenlager | Holder, brake shaft bearing
- 2 x 03.020.2037.100 Dichtring, Radnabe | Seal Ring, wheel hub
- 2 x 03.020.2037.400 Dichtung | Gasket / Seal
- 2 x 03.020.2037.500 Distanzring | Spacer Ring
- 1 x 03.020.2062.000 Distanzscheibe, Bremswelle | Spacer, brake shaft
- 1 x 03.020.2063.000 Sicherungsring | Circlip
- 2 x 03.020.2147.000 Lagerbuchse, Bremswelle | Bushing, brake shaft
- 6 x 03.020.2187.000 Distanzscheibe, Bremswelle | Spacer, brake shaft
- 1 x 03.020.2188.000 Sicherungsring | Circlip
- 2 x 03.020.2220.100 Distanzring | Spacer Ring
- 2 x 03.070.2221.100 Dichtung | Seal / Gasket
- 2 x 03.080.2067.000 Feder, Bremsbacken | Spring, brake shoe
- 1 x 04.110.2186.000 Federring | Springwasher
- 2 x 18.080.1365.000 Prüfstraße | Inspection Lane
- 2 x 18.080.2016.100 Kappe | Cap

03.020.2184.1 S

 Vergl.-Nr. | Comp.No
3.434.3620.00

Reparatursatz, Bremsnockenwelle

Repair Kit, brake camshaft

passend für | to fit to

SAF

Stückliste | Parts List

- 2 x 03.020.2028.100 Lagerbuchse, Bremswelle | Bushing, brake shaft
- 2 x 03.020.2029.200 Reparatursatz, Bremsnockenwelle | Repair Kit, brake camshaft
- 2 x 03.020.2038.200 Lagerbuchse, Bremswelle | Bushing, brake shaft
- 2 x 03.080.2067.000 Feder, Bremsbacken | Spring, brake shoe
- 4 x 18.080.2016.100 Kappe | Cap
- 2 x 20.990.2038.400 Dichtring | Sealing Ring
- 2 x 20.990.2039.100 Dichtring | Sealing Ring

03.020.2184.2 S

 Vergl.-Nr. | Comp.No
3.434.3622.00

Reparatursatz, Bremsnockenwelle

Repair Kit, brake camshaft

passend für | to fit to

SAF

Stückliste | Parts List

- 2 x 03.020.2001.S00 Reparatursatz, Bremsnockenwelle | Repair Kit, brake camshaft
- 2 x 03.020.2029.400 Reparatursatz, Bremsnockenwelle | Repair Kit, brake camshaft
- 2 x 03.020.2037.400 Dichtung | Gasket / Seal
- 2 x 03.020.2037.500 Distanzring | Spacer Ring
- 2 x 03.020.2046.000 Dichtung | Gasket / Seal
- 2 x 03.020.2147.000 Lagerbuchse, Bremswelle | Bushing, brake shaft
- 2 x 03.020.2220.100 Distanzring | Spacer Ring

03.020.2184.3 S

 Vergl.-Nr. | Comp.No
3.434.3637.00

BG-03.020

Reparatursatz, Bremsnockenwelle Repair Kit, brake camshaft



Reparatursatz, Bremsnockenwelle | Repair Kit, brake camshaft

Reparatursatz, Bremsnockenwelle

Repair Kit, brake camshaft

passend für | to fit to

SAF

Stückliste | Parts List

- 2 x 03.020.2028.100 Lagerbuchse, Bremswelle | Bushing, brake shaft
- 2 x 03.020.2029.300 Reparatursatz, Bremsnockenwelle | Repair Kit, brake camshaft
- 2 x 03.020.2038.300 Lagerbuchse, Bremswelle | Bushing, brake shaft
- 2 x 03.080.2067.000 Feder, Bremsbacken | Spring, brake shoe
- 2 x 04.120.2038.120 Dichtring | Sealing Ring
- 2 x 18.080.1252.000 Zier-/Schutzleiste, Seitenscheibe | Trim, side window
- 4 x 18.080.2016.100 Kappe | Cap
- 2 x 20.990.2038.400 Dichtring | Sealing Ring
- 2 x 20.990.2039.100 Dichtring | Sealing Ring



03.020.2184.5 S

Vergl.-Nr. | Comp.No
3.434.3638.00

Reparatursatz, Bremsnockenwelle

Repair Kit, brake camshaft

passend für | to fit to

SAF

Stückliste | Parts List

- 2 x 03.020.2169.200 Halter, Bremswellenlager | Holder, brake shaft bearing
- 2 x 03.020.2169.100 Halter, Bremswellenlager | Holder, brake shaft bearing
- 2 x 03.020.2029.300 Reparatursatz, Bremsnockenwelle | Repair Kit, brake camshaft
- 2 x 04.120.2038.120 Dichtring | Sealing Ring
- 2 x 03.080.0240.130 Feder, Bremsbacken | Spring, brake shoe
- 2 x 20.990.2038.400 Dichtring | Sealing Ring
- 2 x 20.990.2039.100 Dichtring | Sealing Ring



03.020.2184.6 S

Vergl.-Nr. | Comp.No
3.434.3639.00

Reparatursatz, Bremsnockenwelle

Repair Kit, brake camshaft

passend für | to fit to

SAF

Reparatursatz, Bremsnockenwelle

Repair Kit, brake camshaft

passend für | to fit to

SAF

Stückliste | Parts List

- 2 x 03.020.2028.S00 Reparatursatz, Bremsnockenwelle | Repair Kit, brake camshaft
- 2 x 03.020.2037.400 Dichtung | Gasket / Seal
- 2 x 03.020.2037.500 Distanzring | Spacer Ring
- 2 x 03.020.2046.000 Dichtung | Gasket / Seal
- 2 x 03.020.2062.000 Distanzscheibe, Bremswelle | Spacer, brake shaft
- 2 x 03.020.2063.000 Sicherungsring | Circlip
- 2 x 03.020.2147.000 Lagerbuchse, Bremswelle | Bushing, brake shaft
- 12 x 03.020.2187.000 Distanzscheibe, Bremswelle | Spacer, brake shaft
- 2 x 03.020.2188.000 Sicherungsring | Circlip
- 2 x 03.020.2220.100 Distanzring | Spacer Ring
- 2 x 04.110.2186.000 Federring | Springwasher









03.020.2185.S00

Vergl.-Nr. | Comp.No
3.434.3601.00

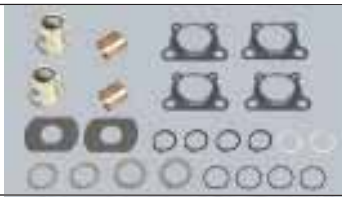
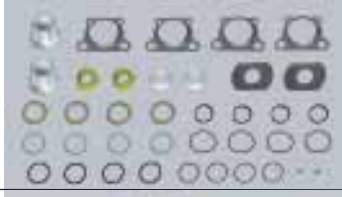
03.020.2280.S00

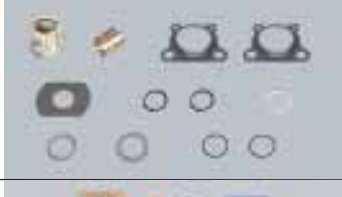
Vergl.-Nr. | Comp.No
3.434.3636.00

**Reparatursatz, Bremsnockenwelle
Repair Kit, brake camshaft**
Reparatursatz, Bremsnockenwelle | Repair Kit, brake camshaft

Reparatursatz, Bremsnockenwelle Repair Kit, brake camshaft passend für to fit to Trailor		03.020.3504.1 S Vergl.-Nr. Comp.No 6503723T
Reparatursatz, Bremsnockenwelle Repair Kit, brake camshaft passend für to fit to Trailor		03.020.3504.3 S Vergl.-Nr. Comp.No 6502103X
Reparatursatz, Bremsnockenwelle Repair Kit, brake camshaft passend für to fit to Trailor		03.020.3504.390 Vergl.-Nr. Comp.No 6502103X
Reparatursatz, Bremsnockenwelle Repair Kit, brake camshaft passend für to fit to Trailor		03.020.3504.430 Vergl.-Nr. Comp.No 6503723T
Reparatursatz, Bremsnockenwelle Repair Kit, brake camshaft passend für to fit to ROR		03.020.4200.230 Vergl.-Nr. Comp.No AXL 112
Reparatursatz, Bremsnockenwelle Repair Kit, brake camshaft passend für to fit to ROR		03.020.4200.240 Vergl.-Nr. Comp.No AXL 122
Reparatursatz, Bremsnockenwelle Repair Kit, brake camshaft passend für to fit to ROR		03.020.4200.250 Vergl.-Nr. Comp.No AXL 132

BG-03.020

Reparatursatz, Feststellbremswelle Repair Kit, parking brake shaft



Reparatursatz, Feststellbremswelle Repair Kit, parking brake shaft			
Reparatursatz, Feststellbremswelle Repair Kit, parking brake shaft passend für to fit to Mercedes Benz Stückliste Parts List 2 x 03.020.1733.110 Lagerschale Bearing Shell 1 x 03.030.1733.130 Buchse, Feststellbremswelle Bush, parking brake shaft 1 x 04.120.1752.000 Mutter Nut 1 x 04.120.1756.000 Halteblech, Bremsbackenbolzen Retaining Plate, brake shoe pins		03.020.1733.115 Vergl.-Nr. Comp.No 322 426 01 83 S	
Reparatursatz, Feststellbremswelle Repair Kit, parking brake shaft passend für to fit to Mercedes Benz Stückliste Parts List 4 x 03.020.1733.110 Lagerschale Bearing Shell 2 x 03.030.1733.130 Buchse, Feststellbremswelle Bush, parking brake shaft 2 x 04.120.1752.000 Mutter Nut 2 x 04.120.1756.000 Halteblech, Bremsbackenbolzen Retaining Plate, brake shoe pins		03.020.1906.0 S Vergl.-Nr. Comp.No 322 426 01 83 S	

Sicherungsring Circlip				
Sicherungsring Circlip passend für to fit to Bergische Achse	Aussendurchmesser Outer Diameter (mm) Innendurchmesser Inner Diameter (mm) Dicke/Stärke Thickness (mm) DIN/ISO DIN / ISO	42 38,6 2,5 471		03.020.0242.600 Vergl.-Nr. Comp.No 02.5676.01.00
Sicherungsring Circlip passend für to fit to Bergische Achse	Aussendurchmesser Outer Diameter (mm) Innendurchmesser Inner Diameter (mm) Dicke/Stärke Thickness (mm)	40,5 34 1		03.020.0244.700 Vergl.-Nr. Comp.No 02.5616.04.90
Sicherungsring Circlip passend für to fit to Bergische Achse	Aussendurchmesser Outer Diameter (mm) Innendurchmesser Inner Diameter (mm) Dicke/Stärke Thickness (mm) DIN/ISO DIN / ISO	41 34 2 5417		03.020.0244.740 Vergl.-Nr. Comp.No 02.5616.05.90

Sicherungsring | Circlip

Sicherungsring Circlip	Innendurchmesser Inner Diameter (mm)	62		03.020.1909.050
	Dicke/Stärke Thickness (mm)	2		Vergl.-Nr. Comp.No 307 994 00 35
passend für to fit to MAN, Mercedes Benz				
Sicherungsring Circlip	Innendurchmesser Inner Diameter (mm)	34		03.020.1909.160
	Dicke/Stärke Thickness (mm)	1,5		Vergl.-Nr. Comp.No 06.29010.0127
passend für to fit to MAN, Mercedes Benz	DIN/ISO DIN / ISO	471		
Sicherungsring Circlip	Aussendurchmesser Outer Diameter (mm)	38		03.020.2063.000
	Dicke/Stärke Thickness (mm)	1,75		Vergl.-Nr. Comp.No 4.348.1006.00
passend für to fit to SAF	DIN/ISO DIN / ISO	471		
Sicherungsring Circlip	Innendurchmesser Inner Diameter (mm)	37		03.020.2188.000
	Dicke/Stärke Thickness (mm)	1,75		Vergl.-Nr. Comp.No 4.348.1005.00
passend für to fit to SAF	DIN/ISO DIN / ISO	471		

Dichtung | Gasket / Seal

Dichtung Gasket / Seal	Aussendurchmesser Outer Diameter (mm)	62		03.020.0238.040
	Innendurchmesser Inner Diameter (mm)	41		Vergl.-Nr. Comp.No 03.120.43.12.0
passend für to fit to Bergische Achse	Höhe Height (mm)	25		
Dichtung Gasket / Seal	Aussendurchmesser Outer Diameter (mm)	62		03.020.0240.840
	Innendurchmesser Inner Diameter (mm)	39		Vergl.-Nr. Comp.No 03.120.63.01.0
passend für to fit to Bergische Achse	Dicke/Stärke Thickness (mm)	25		
	Material Material	Gummi Rubber		
Dichtung Gasket / Seal	Innendurchmesser Inner Diameter (mm)	37,8		03.020.0242.620
	Dicke/Stärke Thickness (mm)	2,6		Vergl.-Nr. Comp.No 02.5677.37.42
passend für to fit to Bergische Achse, Mercedes Benz				





BG-03.020

Dichtung Gasket / Seal



Dichtung Gasket / Seal				
Dichtung Gasket / Seal	Aussendurchmesser Outer Diameter (mm)	56		03.020.0243.520
passend für to fit to Bergische Achse	Innendurchmesser Inner Diameter (mm)	42		Vergl.-Nr. Comp.No 03.120.42.02.0
	Dicke/Stärke Thickness (mm)	2		
Dichtung Gasket / Seal	Innendurchmesser Inner Diameter (mm)	40		03.020.0244.280
passend für to fit to Bergische Achse	Dicke/Stärke Thickness (mm)	2,5		Vergl.-Nr. Comp.No 02.5679.23.00
Dichtung Gasket / Seal	Innendurchmesser Inner Diameter (mm)	41		03.020.0246.220
passend für to fit to Bergische Achse	Höhe Height (mm)	19		Vergl.-Nr. Comp.No 03.120.43.09.0
Dichtung Gasket / Seal	Aussendurchmesser Outer Diameter (mm)	64		03.020.0246.230
passend für to fit to Bergische Achse	Innendurchmesser Inner Diameter (mm)	34		Vergl.-Nr. Comp.No 03.120.43.10.0
	Höhe Height (mm)	26		
Dichtung Gasket / Seal	Aussendurchmesser Outer Diameter (mm)	47		03.020.0247.870
passend für to fit to Bergische Achse	Innendurchmesser Inner Diameter (mm)	42		Vergl.-Nr. Comp.No 03.120.42.09.0
	Höhe Height (mm)	15		
Dichtung Gasket / Seal	Innendurchmesser Inner Diameter (mm)	42		03.020.0247.880
passend für to fit to Bergische Achse	Höhe Height (mm)	13,5		Vergl.-Nr. Comp.No 03.120.42.08.0
Dichtung Gasket / Seal	Aussendurchmesser Outer Diameter (mm)	62		03.020.1909.010
passend für to fit to Mercedes Benz	Innendurchmesser Inner Diameter (mm)	58		Vergl.-Nr. Comp.No 381 423 00 58
	Höhe Height (mm)	30		
Dichtung Gasket / Seal	Aussendurchmesser Outer Diameter (mm)	62		03.020.1909.020
passend für to fit to MAN, Mercedes Benz	Innendurchmesser Inner Diameter (mm)	58		Vergl.-Nr. Comp.No 346 423 00 58
	Höhe Height (mm)	25		

Dichtung | Gasket / Seal

Dichtung Gasket / Seal	Innendurchmesser Inner Diameter (mm)	38		03.020.2037.400
passend für to fit to SAF	Dicke/Stärke Thickness (mm)	5		Vergl.-Nr. Comp.No 4.315.0048.00
Dichtung Gasket / Seal	Innendurchmesser Inner Diameter (mm)	38		03.020.2046.000
passend für to fit to SAF	Dicke/Stärke Thickness (mm)	2,5		Vergl.-Nr. Comp.No 4.315.0001.01
Dichtung Gasket / Seal	Innendurchmesser Inner Diameter (mm)	47		03.020.2052.000
passend für to fit to SAF	Dicke/Stärke Thickness (mm)	2,5		Vergl.-Nr. Comp.No 4.315.0003.00
Dichtung Gasket / Seal	Innendurchmesser Inner Diameter (mm)	38		03.020.2185.000
passend für to fit to SAF	Dicke/Stärke Thickness (mm)	3,5		Vergl.-Nr. Comp.No 4.315.0002.00

Gestängesteller, Bremsanlage | Brake Adjuster



Gestängesteller, Bremsanlage Brake Adjuster	Zähnezahl Number of Teeth	10		03.030.8750.000
passend für to fit to IVECO; SCANIA	Anzahl der Bohrungen Number of Bores	1		Vergl.-Nr. Comp.No 72586
	Betriebsart Operating Mode	automatisch Automatic		
	Verzahnung Tooth System	SAE 1 1/2' 10 C		
	gekröpft links Off-set Left (mm)	-38		
	Bohrung-Ø 1 Bore Ø 1 (mm)	14		
	Bohrungsabstand 1 Bore Distance 1 (mm)	140		

BG-03.030



Gestängesteller, Bremsanlage Brake Adjuster

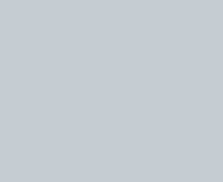

Gestängesteller, Bremsanlage | Brake Adjuster

Gestängesteller, Bremsanlage Brake Adjuster passend für to fit to Mercedes-Benz	Zähnezahl	26		03.030.8750.001 Vergl.-Nr. Comp.No 80000C
	Number of Teeth			
	Anzahl der Bohrungen	1		
	Number of Bores			
	Betriebsart	automatisch		
	Operating Mode	Automatic		
	Verzahnung	N42x1.5x9H DIN 5480		
	Tooth System			
	gekröpft links	-56		
	Off-set Left (mm)			
	Bohrung-Ø 1	14		
	Bore Ø 1 (mm)			
Bohrungsabstand 1	145			
Bore Distance 1 (mm)				
Gestängesteller, Bremsanlage Brake Adjuster passend für to fit to IVECO; SCANIA	Zähnezahl	10		03.030.8750.010 Vergl.-Nr. Comp.No 72587
	Number of Teeth			
	Anzahl der Bohrungen	1		
	Number of Bores			
	Betriebsart	automatisch		
	Operating Mode	Automatic		
	Verzahnung	SAE 1 1/2" 10 C		
	Tooth System			
	gekröpft links	38		
	Off-set Left (mm)			
	Bohrung-Ø 1	14		
	Bore Ø 1 (mm)			
Bohrungsabstand 1	140			
Bore Distance 1 (mm)				
Gestängesteller, Bremsanlage Brake Adjuster passend für to fit to DAF; MAN	Zähnezahl	26		03.030.8750.011 Vergl.-Nr. Comp.No 79225C
	Number of Teeth			
	Anzahl der Bohrungen	1		
	Number of Bores			
	Betriebsart	automatisch		
	Operating Mode	Automatic		
	Verzahnung	N42x1.5x9H DIN 5480		
	Tooth System			
	gekröpft links	-15		
	Off-set Left (mm)			
	Bohrung-Ø 1	14		
	Bore Ø 1 (mm)			
Bohrungsabstand 1	130			
Bore Distance 1 (mm)				

Gestängesteller, Bremsanlage | Brake Adjuster



Gestängesteller, Bremsanlage Brake Adjuster passend für to fit to DAF; MAN	Zähnezahl	26		03.030.8750.012 Vergl.-Nr. Comp.No 79226C
	Number of Teeth			
	Anzahl der Bohrungen	1		
	Number of Bores			
	Betriebsart	automatisch		
	Operating Mode	Automatic		
	Verzahnung	N42x1.5x9H DIN 5480		
	Tooth System			
	gekröpft links	15		
	Off-set Left (mm)			
Bohrung-Ø 1	14		03.030.8750.020 Vergl.-Nr. Comp.No 72679	
Bore Ø 1 (mm)				
Bohrungsabstand 1	130			
Bore Distance 1 (mm)				
Zähnezahl	10			
Number of Teeth				
Anzahl der Bohrungen	1			
Number of Bores				
Betriebsart	automatisch			
Operating Mode	Automatic			
Verzahnung	SAE 1 1/2' 10 C			
Tooth System				
gekröpft links	38			
Off-set Left (mm)				
Bohrung-Ø 1	14			
Bore Ø 1 (mm)				
Bohrungsabstand 1	140			
Bore Distance 1 (mm)				
Zähnezahl	10		03.030.8750.030 Vergl.-Nr. Comp.No 72680	
Number of Teeth				
Anzahl der Bohrungen	1			
Number of Bores				
Betriebsart	automatisch			
Operating Mode	Automatic			
Verzahnung	SAE 1 1/2' 10 C			
Tooth System				
gekröpft links	-38			
Off-set Left (mm)				
Bohrung-Ø 1	14			
Bore Ø 1 (mm)				
Bohrungsabstand 1	140			
Bore Distance 1 (mm)				

BG-03.030



Gestängesteller, Bremsanlage Brake Adjuster



Gestängesteller, Bremsanlage | Brake Adjuster

Gestängesteller, Bremsanlage Brake Adjuster passend für to fit to NEOPLAN	Zähnezahl	19		03.030.8750.040 Vergl.-Nr. Comp.No 72688
	Number of Teeth			
	Anzahl der Bohrungen	1		
	Number of Bores			
	Betriebsart	automatisch		
	Operating Mode	Automatic		
	Verzahnung	A38x34 DIN 5482		
	Tooth System			
	gekröpft links	56		
	Off-set Left (mm)			
	Bohrung-Ø 1	14		
	Bore Ø 1 (mm)			
Bohrungsabstand 1	145			
Bore Distance 1 (mm)				
Gestängesteller, Bremsanlage Brake Adjuster passend für to fit to NEOPLAN	Zähnezahl	19		03.030.8750.050 Vergl.-Nr. Comp.No 72689
	Number of Teeth			
	Anzahl der Bohrungen	1		
	Number of Bores			
	Betriebsart	automatisch		
	Operating Mode	Automatic		
	Verzahnung	A38x34 DIN 5482		
	Tooth System			
	gekröpft links	-56		
	Off-set Left (mm)			
	Bohrung-Ø 1	14		
	Bore Ø 1 (mm)			
Bohrungsabstand 1	145			
Bore Distance 1 (mm)				
Gestängesteller, Bremsanlage Brake Adjuster passend für to fit to MAN; Mercedes-Benz	Zähnezahl	26		03.030.8750.090 Vergl.-Nr. Comp.No 80001
	Number of Teeth			
	Anzahl der Bohrungen	1		
	Number of Bores			
	Betriebsart	automatisch		
	Operating Mode	Automatic		
	Verzahnung	N42x1.5x9H DIN 5480		
	Tooth System			
	gekröpft links	+56; -56		
	Off-set Left (mm)			
	Bohrung-Ø 1	14		
	Bore Ø 1 (mm)			
Bohrungsabstand 1	145			
Bore Distance 1 (mm)				

Gestängesteller, Bremsanlage | Brake Adjuster



Gestängesteller, Bremsanlage Brake Adjuster passend für to fit to MAN; Mercedes-Benz	Zähnezahl	26		03.030.8750.100 Vergl.-Nr. Comp.No 72415
	Number of Teeth			
	Anzahl der Bohrungen	1		
	Number of Bores			
	Betriebsart	automatisch		
	Operating Mode	Automatic		
	Verzahnung	N42x1.5x9H DIN 5480		
	Tooth System			
	gekröpft links	0		
	Off-set Left (mm)			
	Bohrung-Ø 1	14		
	Bore Ø 1 (mm)			
	Bohrungsabstand 1	145		
Bore Distance 1 (mm)				
Gestängesteller, Bremsanlage Brake Adjuster passend für to fit to Mercedes-Benz	Zähnezahl	26		03.030.8750.101 Vergl.-Nr. Comp.No 72060
	Number of Teeth			
	Anzahl der Bohrungen	1		
	Number of Bores			
	Betriebsart	automatisch		
	Operating Mode	Automatic		
	Verzahnung	N42x1.5x9H DIN 5480		
	Tooth System			
	gekröpft links	-15		
	Off-set Left (mm)			
	Bohrung-Ø 1	14		
	Bore Ø 1 (mm)			
	Bohrungsabstand 1	145		
Bore Distance 1 (mm)				
Gestängesteller, Bremsanlage Brake Adjuster passend für to fit to Mercedes-Benz	Zähnezahl	26		03.030.8750.102 Vergl.-Nr. Comp.No 72061
	Number of Teeth			
	Anzahl der Bohrungen	1		
	Number of Bores			
	Betriebsart	automatisch		
	Operating Mode	Automatic		
	Verzahnung	N42x1.5x9H DIN 5480		
	Tooth System			
	gekröpft links	15		
	Off-set Left (mm)			
	Bohrung-Ø 1	14		
	Bore Ø 1 (mm)			
	Bohrungsabstand 1	145		
Bore Distance 1 (mm)				

BG-03.030



Gestängesteller, Bremsanlage Brake Adjuster



Gestängesteller, Bremsanlage | Brake Adjuster

Gestängesteller, Bremsanlage Brake Adjuster passend für to fit to RENAULT	Zähnezahl	28		03.030.8750.103 Vergl.-Nr. Comp.No 79288
	Number of Teeth			
	Anzahl der Bohrungen	1		
	Number of Bores			
	Betriebsart	automatisch		
	Operating Mode	Automatic		
	Verzahnung	SAE 1 1/2' 28 C		
	Tooth System			
	gekröpft links	-38		
	Off-set Left (mm)			
	Bohrung-Ø 1	14		
	Bore Ø 1 (mm)			
Bohrungsabstand 1	160			
Bore Distance 1 (mm)				
Gestängesteller, Bremsanlage Brake Adjuster passend für to fit to RENAULT	Zähnezahl	28		03.030.8750.104 Vergl.-Nr. Comp.No 79305C
	Number of Teeth			
	Anzahl der Bohrungen	1		
	Number of Bores			
	Betriebsart	automatisch		
	Operating Mode	Automatic		
	Verzahnung	SAE 1 1/2' 28 C		
	Tooth System			
	gekröpft links	38		
	Off-set Left (mm)			
	Bohrung-Ø 1	14		
	Bore Ø 1 (mm)			
Bohrungsabstand 1	160			
Bore Distance 1 (mm)				
Gestängesteller, Bremsanlage Brake Adjuster passend für to fit to NEOPLAN	Zähnezahl	19		03.030.8750.105 Vergl.-Nr. Comp.No 70720
	Number of Teeth			
	Anzahl der Bohrungen	1		
	Number of Bores			
	Betriebsart	automatisch		
	Operating Mode	Automatic		
	Verzahnung	A38x34 DIN 5482		
	Tooth System			
	gekröpft links	0		
	Off-set Left (mm)			
	Bohrung-Ø 1	14		
	Bore Ø 1 (mm)			
Bohrungsabstand 1	145			
Bore Distance 1 (mm)				

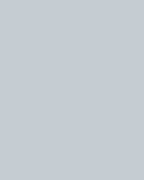
Gestängesteller, Bremsanlage | Brake Adjuster



Gestängesteller, Bremsanlage Brake Adjuster passend für to fit to DAF	Zähnezahl Number of Teeth	26		03.030.8750.106 Vergl.-Nr. Comp.No 72529		
	Anzahl der Bohrungen Number of Bores	1				
	Betriebsart Operating Mode	automatisch Automatic				
	Verzahnung Tooth System	N42x1.5x9H DIN 5480				
	gekröpft links Off-set Left (mm)	0				
	Bohrungsabstand 1 Bore Distance 1 (mm)	140				
	Zähnezahl Number of Teeth	19				03.030.8750.107 Vergl.-Nr. Comp.No 70702
	Anzahl der Bohrungen Number of Bores	1				
	Betriebsart Operating Mode	automatisch Automatic				
	Verzahnung Tooth System	A38x34 DIN 5482				
gekröpft links Off-set Left (mm)	0					
Bohrung-Ø 1 Bore Ø 1 (mm)	14					
Bohrungsabstand 1 Bore Distance 1 (mm)	110					
Zähnezahl Number of Teeth	26		03.030.8750.108 Vergl.-Nr. Comp.No 70950			
Anzahl der Bohrungen Number of Bores	1					
Betriebsart Operating Mode	automatisch Automatic					
Verzahnung Tooth System	N42x1.5x9H DIN 5480					
gekröpft links Off-set Left (mm)	0					
Bohrung-Ø 1 Bore Ø 1 (mm)	14					
Bohrungsabstand 1 Bore Distance 1 (mm)	110					

BG-03.030



Gestängesteller, Bremsanlage Brake Adjuster



Gestängesteller, Bremsanlage | Brake Adjuster

Gestängesteller, Bremsanlage Brake Adjuster passend für to fit to RENAULT	Zähnezahl Number of Teeth	19		03.030.8750.109 Vergl.-Nr. Comp.No 72137
	Anzahl der Bohrungen Number of Bores	1		
	Betriebsart Operating Mode	automatisch Automatic		
	Verzahnung Tooth System	A38x34 DIN 5482		
	gekröpft links Off-set Left (mm)	+60,3		
	Bohrung-Ø 1 Bore Ø 1 (mm)	14		
	Bohrungsabstand 1 Bore Distance 1 (mm)	170		
	Zähnezahl Number of Teeth	19		
	Anzahl der Bohrungen Number of Bores	1		
	Betriebsart Operating Mode	automatisch Automatic		
	Verzahnung Tooth System	A38x34 DIN 5482		
	gekröpft links Off-set Left (mm)	-60,3		
Bohrung-Ø 1 Bore Ø 1 (mm)	14			
Bohrungsabstand 1 Bore Distance 1 (mm)	170			
Gestängesteller, Bremsanlage Brake Adjuster passend für to fit to DAF; MAN; RENAULT	Zähnezahl Number of Teeth	19		03.030.8750.110 Vergl.-Nr. Comp.No 79225
	Anzahl der Bohrungen Number of Bores	1		
	Betriebsart Operating Mode	automatisch Automatic		
	Verzahnung Tooth System	A38x34 DIN 5482		
	gekröpft links Off-set Left (mm)	-60,3		
	Bohrung-Ø 1 Bore Ø 1 (mm)	14		
	Bohrungsabstand 1 Bore Distance 1 (mm)	170		
	Zähnezahl Number of Teeth	27		
	Anzahl der Bohrungen Number of Bores	1		
	Betriebsart Operating Mode	automatisch Automatic		
	Verzahnung Tooth System	BNA 227,35.0		
	gekröpft links Off-set Left (mm)	38		
Bohrung-Ø 1 Bore Ø 1 (mm)	14			
Bohrungsabstand 1 Bore Distance 1 (mm)	175			
Gestängesteller, Bremsanlage Brake Adjuster passend für to fit to RENAULT	Zähnezahl Number of Teeth	27		03.030.8750.111 Vergl.-Nr. Comp.No 79007C
	Anzahl der Bohrungen Number of Bores	1		
	Betriebsart Operating Mode	automatisch Automatic		
	Verzahnung Tooth System	BNA 227,35.0		
	gekröpft links Off-set Left (mm)	38		
	Bohrung-Ø 1 Bore Ø 1 (mm)	14		
	Bohrungsabstand 1 Bore Distance 1 (mm)	175		

Gestängesteller, Bremsanlage | Brake Adjuster



Gestängesteller, Bremsanlage Brake Adjuster passend für to fit to RENAULT	Zähnezahl	27		03.030.8750.112 Vergl.-Nr. Comp.No 79008C
	Number of Teeth			
	Anzahl der Bohrungen	1		
	Number of Bores			
	Betriebsart	automatisch		
	Operating Mode	Automatic		
	Verzahnung	BNA 227,35.0		
	Tooth System			
	gekröpft links	-38		
	Off-set Left (mm)			
	Bohrung-Ø 1	14		
Bore Ø 1 (mm)				
Bohrungsabstand 1	175			
Bore Distance 1 (mm)				
Gestängesteller, Bremsanlage Brake Adjuster passend für to fit to RENAULT	Zähnezahl	27		03.030.8750.113 Vergl.-Nr. Comp.No 79440C
	Number of Teeth			
	Anzahl der Bohrungen	1		
	Number of Bores			
	Betriebsart	automatisch		
	Operating Mode	Automatic		
	Verzahnung	BNA 227,35.0		
	Tooth System			
	gekröpft links	-56,2		
	Off-set Left (mm)			
	Bohrung-Ø 1	14		
Bore Ø 1 (mm)				
Bohrungsabstand 1	160			
Bore Distance 1 (mm)				
Gestängesteller, Bremsanlage Brake Adjuster passend für to fit to RENAULT	Zähnezahl	27		03.030.8750.114 Vergl.-Nr. Comp.No 79441C
	Number of Teeth			
	Anzahl der Bohrungen	1		
	Number of Bores			
	Betriebsart	automatisch		
	Operating Mode	Automatic		
	Verzahnung	BNA 227,35.0		
	Tooth System			
	gekröpft links	+56,2		
	Off-set Left (mm)			
	Bohrung-Ø 1	14		
Bore Ø 1 (mm)				
Bohrungsabstand 1	160			
Bore Distance 1 (mm)				

BG-03.030



Gestängesteller, Bremsanlage Brake Adjuster



Gestängesteller, Bremsanlage | Brake Adjuster

Gestängesteller, Bremsanlage Brake Adjuster passend für to fit to RENAULT	Zähnezahl	27		03.030.8750.115 Vergl.-Nr. Comp.No 79020C
	Number of Teeth			
	Anzahl der Bohrungen	1		
	Number of Bores			
	Betriebsart	automatisch		
	Operating Mode	Automatic		
	Verzahnung	BNA 227,35.0		
	Tooth System			
	gekröpft links	38		
	Off-set Left (mm)			
	Bohrung-Ø 1	14		
	Bore Ø 1 (mm)			
Bohrungsabstand 1	175			
Bore Distance 1 (mm)				
Gestängesteller, Bremsanlage Brake Adjuster passend für to fit to RENAULT	Zähnezahl	27		03.030.8750.116 Vergl.-Nr. Comp.No 79021C
	Number of Teeth			
	Anzahl der Bohrungen	1		
	Number of Bores			
	Betriebsart	automatisch		
	Operating Mode	Automatic		
	Verzahnung	BNA 227,35.0		
	Tooth System			
	gekröpft links	-38		
	Off-set Left (mm)			
	Bohrung-Ø 1	14		
	Bore Ø 1 (mm)			
Bohrungsabstand 1	175			
Bore Distance 1 (mm)				
Gestängesteller, Bremsanlage Brake Adjuster passend für to fit to Mercedes-Benz	Zähnezahl	26		03.030.8750.117 Vergl.-Nr. Comp.No 70992
	Number of Teeth			
	Anzahl der Bohrungen	1		
	Number of Bores			
	Betriebsart	automatisch		
	Operating Mode	Automatic		
	Verzahnung	N42x1.5x9H DIN 5480		
	Tooth System			
	gekröpft links	-50		
	Off-set Left (mm)			
	Bohrung-Ø 1	14		
	Bore Ø 1 (mm)			
Bohrungsabstand 1	145			
Bore Distance 1 (mm)				

Gestängesteller, Bremsanlage | Brake Adjuster



Gestängesteller, Bremsanlage Brake Adjuster passend für to fit to Mercedes-Benz	Zähnezahl	26		03.030.8750.118 Vergl.-Nr. Comp.No 70993
	Number of Teeth			
	Anzahl der Bohrungen	1		
	Number of Bores			
	Betriebsart	automatisch		
	Operating Mode	Automatic		
	Verzahnung	N42x1.5x9H DIN 5480		
	Tooth System			
	gekröpft links	50		
	Off-set Left (mm)			
Bohrung-Ø 1	14		03.030.8750.119 Vergl.-Nr. Comp.No 79105C	
Bore Ø 1 (mm)				
Bohrungsabstand 1	145			
Bore Distance 1 (mm)				
Zähnezahl	10			
Number of Teeth				
Anzahl der Bohrungen	1			
Number of Bores				
Betriebsart	automatisch			
Operating Mode	Automatic			
Verzahnung	SAE 1 1/2' 10 C			
Tooth System				
gekröpft links	-75			
Off-set Left (mm)				
Bohrung-Ø 1	16			
Bore Ø 1 (mm)				
Bohrungsabstand 1	165			
Bore Distance 1 (mm)				
Zähnezahl	10		03.030.8750.120 Vergl.-Nr. Comp.No 79106C	
Number of Teeth				
Anzahl der Bohrungen	1			
Number of Bores				
Betriebsart	automatisch			
Operating Mode	Automatic			
Verzahnung	SAE 1 1/2' 10 C			
Tooth System				
gekröpft links	75			
Off-set Left (mm)				
Bohrung-Ø 1	16			
Bore Ø 1 (mm)				
Bohrungsabstand 1	165			
Bore Distance 1 (mm)				

BG-03.030



Gestängesteller, Bremsanlage Brake Adjuster



Gestängesteller, Bremsanlage | Brake Adjuster

Gestängesteller, Bremsanlage Brake Adjuster passend für to fit to Mercedes-Benz	Zähnezahl	26		03.030.8750.121 Vergl.-Nr. Comp.No 80008C
	Number of Teeth			
	Anzahl der Bohrungen	1		
	Number of Bores			
	Betriebsart	automatisch		
	Operating Mode	Automatic		
	Verzahnung	N42x1.5x9H DIN 5480		
	Tooth System			
	gekröpft links	37		
	Off-set Left (mm)			
Bohrung-Ø 1	14		03.030.8750.122 Vergl.-Nr. Comp.No 80008C	
Bore Ø 1 (mm)				
Bohrungsabstand 1	145			
Bore Distance 1 (mm)				
Zähnezahl	26			
Number of Teeth				
Anzahl der Bohrungen	1			
Number of Bores				
Betriebsart	automatisch			
Operating Mode	Automatic			
Verzahnung	N42x1.5x9H DIN 5480			
Tooth System				
gekröpft links	-37			
Off-set Left (mm)				
Bohrung-Ø 1	14			
Bore Ø 1 (mm)				
Bohrungsabstand 1	145			
Bore Distance 1 (mm)				
Zähnezahl	10		03.030.8750.123 Vergl.-Nr. Comp.No 72658C	
Number of Teeth				
Anzahl der Bohrungen	1			
Number of Bores				
Betriebsart	automatisch			
Operating Mode	Automatic			
Verzahnung	SAE 1 1/2' 10 C			
Tooth System				
gekröpft links	-60,3			
Off-set Left (mm)				
Bohrung-Ø 1	12,7			
Bore Ø 1 (mm)				
Bohrungsabstand 1	151			
Bore Distance 1 (mm)				

Gestängesteller, Bremsanlage | Brake Adjuster



Gestängesteller, Bremsanlage Brake Adjuster passend für to fit to MAN	Zähnezahl	26		03.030.8750.130 Vergl.-Nr. Comp.No 79212C
	Number of Teeth			
	Anzahl der Bohrungen	1		
	Number of Bores			
	Betriebsart	automatisch		
	Operating Mode	Automatic		
	Verzahnung	N42x1.5x9H DIN 5480		
	Tooth System			
	gekröpft links	0		
	Off-set Left (mm)			
Bohrung-Ø 1	14		03.030.8750.140 Vergl.-Nr. Comp.No 72810	
Bore Ø 1 (mm)				
Bohrungsabstand 1	145			
Bore Distance 1 (mm)				
Zähnezahl	26			
Number of Teeth				
Anzahl der Bohrungen	1			
Number of Bores				
Betriebsart	automatisch			
Operating Mode	Automatic			
Verzahnung	N42x1.5x9H DIN 5480			
Tooth System				
gekröpft links	18			
Off-set Left (mm)				
Bohrung-Ø 1	14			
Bore Ø 1 (mm)				
Bohrungsabstand 1	130			
Bore Distance 1 (mm)				
Zähnezahl	26		03.030.8750.150 Vergl.-Nr. Comp.No 72809	
Number of Teeth				
Anzahl der Bohrungen	1			
Number of Bores				
Betriebsart	automatisch			
Operating Mode	Automatic			
Verzahnung	N42x1.5x9H DIN 5480			
Tooth System				
gekröpft links	-18			
Off-set Left (mm)				
Bohrung-Ø 1	14			
Bore Ø 1 (mm)				
Bohrungsabstand 1	130			
Bore Distance 1 (mm)				

BG-03.030



Gestängesteller, Bremsanlage Brake Adjuster



Gestängesteller, Bremsanlage | Brake Adjuster

Gestängesteller, Bremsanlage Brake Adjuster passend für to fit to Mercedes-Benz	Zähnezahl	26		03.030.8750.160 Vergl.-Nr. Comp.No 72213
	Number of Teeth			
	Anzahl der Bohrungen	1		
	Number of Bores			
	Betriebsart	automatisch		
	Operating Mode	Automatic		
	Verzahnung	N42x1.5x9H DIN 5480		
	Tooth System			
	gekröpft links	0		
	Off-set Left (mm)			
	Bohrung-Ø 1	14		
	Bore Ø 1 (mm)			
Bohrungsabstand 1	130			
Bore Distance 1 (mm)				
Gestängesteller, Bremsanlage Brake Adjuster passend für to fit to Mercedes-Benz; NEOPLAN	Zähnezahl	26		03.030.8750.170 Vergl.-Nr. Comp.No 70706
	Number of Teeth			
	Anzahl der Bohrungen	1		
	Number of Bores			
	Betriebsart	automatisch		
	Operating Mode	Automatic		
	Verzahnung	N42x1.5x9H DIN 5480		
	Tooth System			
	gekröpft links	0		
	Off-set Left (mm)			
	Bohrung-Ø 1	14		
	Bore Ø 1 (mm)			
Bohrungsabstand 1	115			
Bore Distance 1 (mm)				
Gestängesteller, Bremsanlage Brake Adjuster passend für to fit to MAN; Mercedes-Benz; NEOPLAN	Zähnezahl	26		03.030.8750.180 Vergl.-Nr. Comp.No 79204
	Number of Teeth			
	Anzahl der Bohrungen	1		
	Number of Bores			
	Betriebsart	automatisch		
	Operating Mode	Automatic		
	Verzahnung	N42x1.5x9H DIN 5480		
	Tooth System			
	gekröpft links	-15		
	Off-set Left (mm)			
	Bohrung-Ø 1	14		
	Bore Ø 1 (mm)			
Bohrungsabstand 1	115			
Bore Distance 1 (mm)				

Gestängesteller, Bremsanlage | Brake Adjuster



Gestängesteller, Bremsanlage Brake Adjuster passend für to fit to MAN; Mercedes-Benz; NEOPLAN	Zähnezahl	26		03.030.8750.190 Vergl.-Nr. Comp.No 79203
	Number of Teeth			
	Anzahl der Bohrungen	1		
	Number of Bores			
	Betriebsart	automatisch		
	Operating Mode	Automatic		
	Verzahnung	N42x1.5x9H DIN 5480		
	Tooth System			
	gekröpft links	15		
	Off-set Left (mm)			
Bohrung-Ø 1	14		03.030.8750.210 Vergl.-Nr. Comp.No 72059	
Number of Teeth	26			
Number of Bores	1			
Betriebsart	automatisch			
Operating Mode	Automatic			
Verzahnung	N42x1.5x9H DIN 5480			
Tooth System				
gekröpft links	0			
Off-set Left (mm)				
Bohrung-Ø 1	14			
Bore Ø 1 (mm)				
Bohrungsabstand 1	145		03.030.8750.220 Vergl.-Nr. Comp.No 72308	
Number of Teeth	26			
Number of Bores	1			
Betriebsart	automatisch			
Operating Mode	Automatic			
Verzahnung	N42x1.5x9H DIN 5480			
Tooth System				
gekröpft links	0			
Off-set Left (mm)				
Bohrung-Ø 1	14			
Bore Ø 1 (mm)				
Bohrungsabstand 1	145			
Bore Distance 1 (mm)				

BG-03.030



Gestängesteller, Bremsanlage Brake Adjuster



Gestängesteller, Bremsanlage | Brake Adjuster

Gestängesteller, Bremsanlage Brake Adjuster passend für to fit to Mercedes-Benz	Zähnezahl	26		03.030.8750.230 Vergl.-Nr. Comp.No 72211
	Number of Teeth			
	Anzahl der Bohrungen	1		
	Number of Bores			
	Betriebsart	automatisch		
	Operating Mode	Automatic		
	Verzahnung	N42x1.5x9H DIN 5480		
	Tooth System			
	gekröpft links	-15		
	Off-set Left (mm)			
	Bohrung-Ø 1	14		
	Bore Ø 1 (mm)			
Bohrungsabstand 1	130			
Bore Distance 1 (mm)				
Gestängesteller, Bremsanlage Brake Adjuster passend für to fit to Mercedes-Benz	Zähnezahl	26		03.030.8750.240 Vergl.-Nr. Comp.No 72212
	Number of Teeth			
	Anzahl der Bohrungen	1		
	Number of Bores			
	Betriebsart	automatisch		
	Operating Mode	Automatic		
	Verzahnung	N42x1.5x9H DIN 5480		
	Tooth System			
	gekröpft links	15		
	Off-set Left (mm)			
	Bohrung-Ø 1	14		
	Bore Ø 1 (mm)			
Bohrungsabstand 1	130			
Bore Distance 1 (mm)				
Gestängesteller, Bremsanlage Brake Adjuster passend für to fit to Mercedes-Benz	Zähnezahl	26		03.030.8750.250 Vergl.-Nr. Comp.No 79185
	Number of Teeth			
	Anzahl der Bohrungen	1		
	Number of Bores			
	Betriebsart	automatisch		
	Operating Mode	Automatic		
	Verzahnung	N42x1.5x9H DIN 5480		
	Tooth System			
	gekröpft links	0		
	Off-set Left (mm)			
	Bohrung-Ø 1	14		
	Bore Ø 1 (mm)			
Bohrungsabstand 1	145			
Bore Distance 1 (mm)				

Gestängesteller, Bremsanlage | Brake Adjuster



Gestängesteller, Bremsanlage Brake Adjuster passend für to fit to Mercedes-Benz	Zähnezahl	26		03.030.8750.260 Vergl.-Nr. Comp.No 70918
	Number of Teeth			
	Anzahl der Bohrungen	1		
	Number of Bores			
	Betriebsart	automatisch		
	Operating Mode	Automatic		
	Verzahnung	N42x1.5x9H DIN 5480		
	Tooth System			
	gekröpft links	-56		
	Off-set Left (mm)			
	Bohrung-Ø 1	14		
	Bore Ø 1 (mm)			
	Bohrungsabstand 1	145		
Bore Distance 1 (mm)				
Gestängesteller, Bremsanlage Brake Adjuster passend für to fit to SCANIA	Zähnezahl	10		03.030.8750.270 Vergl.-Nr. Comp.No 72490
	Number of Teeth			
	Anzahl der Bohrungen	2		
	Number of Bores			
	Betriebsart	automatisch		
	Operating Mode	Automatic		
	Verzahnung	SAE 1 1/2' 10 C		
	Tooth System			
	gekröpft links	0		
	Off-set Left (mm)			
	Bohrung-Ø 1	16		
	Bore Ø 1 (mm)			
	Bohrung-Ø 2	16		
Bore Ø 2 (mm)				
Bohrungsabstand 1	165			
Bore Distance 1 (mm)				
Bohrungsabstand 2	140			
Bore Distance 2 (mm)				
Gestängesteller, Bremsanlage Brake Adjuster passend für to fit to DAF	Zähnezahl	10		03.030.8750.280 Vergl.-Nr. Comp.No 72534
	Number of Teeth			
	Anzahl der Bohrungen	1		
	Number of Bores			
	Betriebsart	automatisch		
	Operating Mode	Automatic		
	Verzahnung	SAE 1 1/2' 10 C		
	Tooth System			
	gekröpft links	0		
	Off-set Left (mm)			
	Bohrung-Ø 1	14		
	Bore Ø 1 (mm)			
	Bohrungsabstand 1	140		
Bore Distance 1 (mm)				

BG-03.030



Gestängesteller, Bremsanlage Brake Adjuster



Gestängesteller, Bremsanlage | Brake Adjuster

Gestängesteller, Bremsanlage Brake Adjuster passend für to fit to SCANIA	Zähnezahl	10		03.030.8750.290 Vergl.-Nr. Comp.No 72959
	Number of Teeth			
	Anzahl der Bohrungen	1		
	Number of Bores			
	Betriebsart	automatisch		
	Operating Mode	Automatic		
	Verzahnung	SAE 1 1/2' 10 C		
	Tooth System			
	gekröpft links	-50		
	Off-set Left (mm)			
	Bohrung-Ø 1	16		
	Bore Ø 1 (mm)			
Bohrungsabstand 1	165			
Bore Distance 1 (mm)				
Gestängesteller, Bremsanlage Brake Adjuster passend für to fit to NEOPLAN; SCANIA	Zähnezahl	10		03.030.8750.300 Vergl.-Nr. Comp.No 72949
	Number of Teeth			
	Anzahl der Bohrungen	1		
	Number of Bores			
	Betriebsart	automatisch		
	Operating Mode	Automatic		
	Verzahnung	SAE 1 1/2' 10 C		
	Tooth System			
	gekröpft links	25		
	Off-set Left (mm)			
	Bohrung-Ø 1	16		
	Bore Ø 1 (mm)			
Bohrungsabstand 1	165			
Bore Distance 1 (mm)				
Gestängesteller, Bremsanlage Brake Adjuster passend für to fit to NEOPLAN; SCANIA	Zähnezahl	10		03.030.8750.310 Vergl.-Nr. Comp.No 72950
	Number of Teeth			
	Anzahl der Bohrungen	1		
	Number of Bores			
	Betriebsart	automatisch		
	Operating Mode	Automatic		
	Verzahnung	SAE 1 1/2' 10 C		
	Tooth System			
	gekröpft links	-25		
	Off-set Left (mm)			
	Bohrung-Ø 1	16		
	Bore Ø 1 (mm)			
Bohrungsabstand 1	165			
Bore Distance 1 (mm)				

Gestängesteller, Bremsanlage | Brake Adjuster



Gestängesteller, Bremsanlage Brake Adjuster passend für to fit to SCANIA	Zähnezahl	10		03.030.8750.320 Vergl.-Nr. Comp.No 72477
	Number of Teeth			
	Anzahl der Bohrungen	1		
	Number of Bores			
	Betriebsart	automatisch		
	Operating Mode	Automatic		
	Verzahnung	SAE 1 1/2' 10 C		
	Tooth System			
	gekröpft links	50		
	Off-set Left (mm)			
	Bohrung-Ø 1	16		
	Bore Ø 1 (mm)			
	Bohrungsabstand 1	165		
Bore Distance 1 (mm)				
Gestängesteller, Bremsanlage Brake Adjuster passend für to fit to VOLVO	Zähnezahl	10		03.030.8750.330 Vergl.-Nr. Comp.No 72782C
	Number of Teeth			
	Anzahl der Bohrungen	1		
	Number of Bores			
	Betriebsart	automatisch		
	Operating Mode	Automatic		
	Verzahnung	SAE 1 1/2' 10 C		
	Tooth System			
	gekröpft links	15		
	Off-set Left (mm)			
	Bohrung-Ø 1	12,7		
	Bore Ø 1 (mm)			
	Bohrungsabstand 1	145		
Bore Distance 1 (mm)				
Gestängesteller, Bremsanlage Brake Adjuster passend für to fit to VOLVO	Zähnezahl	10		03.030.8750.340 Vergl.-Nr. Comp.No 72783C
	Number of Teeth			
	Anzahl der Bohrungen	1		
	Number of Bores			
	Betriebsart	automatisch		
	Operating Mode	Automatic		
	Verzahnung	SAE 1 1/2' 10 C		
	Tooth System			
	gekröpft links	-15		
	Off-set Left (mm)			
	Bohrung-Ø 1	12,7		
	Bore Ø 1 (mm)			
	Bohrungsabstand 1	145		
Bore Distance 1 (mm)				

BG-03.030



Gestängesteller, Bremsanlage Brake Adjuster



Gestängesteller, Bremsanlage | Brake Adjuster

Gestängesteller, Bremsanlage Brake Adjuster passend für to fit to SCANIA	Zähnezahl	10		03.030.8750.350 Vergl.-Nr. Comp.No 72746C
	Number of Teeth			
	Anzahl der Bohrungen	1		
	Number of Bores			
	Betriebsart	automatisch		
	Operating Mode	Automatic		
	Verzahnung	SAE 1 1/2' 10 C		
	Tooth System			
	gekröpft links	-16		
	Off-set Left (mm)			
	Bohrung-Ø 1	12,7		
	Bore Ø 1 (mm)			
Bohrungsabstand 1	130			
Bore Distance 1 (mm)				
Gestängesteller, Bremsanlage Brake Adjuster passend für to fit to SCANIA	Zähnezahl	10		03.030.8750.360 Vergl.-Nr. Comp.No 72956
	Number of Teeth			
	Anzahl der Bohrungen	1		
	Number of Bores			
	Betriebsart	automatisch		
	Operating Mode	Automatic		
	Verzahnung	SAE 1 1/2' 10 C		
	Tooth System			
	gekröpft links	-16		
	Off-set Left (mm)			
	Bohrung-Ø 1	16		
	Bore Ø 1 (mm)			
Bohrungsabstand 1	130			
Bore Distance 1 (mm)				
Gestängesteller, Bremsanlage Brake Adjuster passend für to fit to SCANIA	Zähnezahl	10		03.030.8750.370 Vergl.-Nr. Comp.No 79442C
	Number of Teeth			
	Anzahl der Bohrungen	1		
	Number of Bores			
	Betriebsart	automatisch		
	Operating Mode	Automatic		
	Verzahnung	SAE 1 1/2' 10 C		
	Tooth System			
	gekröpft links	-65		
	Off-set Left (mm)			
	Bohrung-Ø 1	16		
	Bore Ø 1 (mm)			
Bohrungsabstand 1	165			
Bore Distance 1 (mm)				

Gestängesteller, Bremsanlage | Brake Adjuster

Gestängesteller, Bremsanlage Brake Adjuster passend für to fit to SCANIA	Zähnezahl Number of Teeth	10		03.030.8750.390 Vergl.-Nr. Comp.No 79442C		
	Anzahl der Bohrungen Number of Bores	1				
	Betriebsart Operating Mode	automatisch Automatic				
	Verzahnung Tooth System	SAE 1 1/2' 10 C				
	gekröpft links Off-set Left (mm)	-65				
	Bohrung-Ø 1 Bore Ø 1 (mm)	16				
	Bohrungsabstand 1 Bore Distance 1 (mm)	165				
	Zähnezahl Number of Teeth	26				03.030.8750.400 Vergl.-Nr. Comp.No 70958
	Anzahl der Bohrungen Number of Bores	1				
	Betriebsart Operating Mode	automatisch Automatic				
	Verzahnung Tooth System	N42x1.5x9H DIN 5480				
	gekröpft links Off-set Left (mm)	0				
Bohrung-Ø 1 Bore Ø 1 (mm)	14					
Bohrungsabstand 1 Bore Distance 1 (mm)	130					
Zähnezahl Number of Teeth	10		03.030.8750.410 Vergl.-Nr. Comp.No 72730C			
Anzahl der Bohrungen Number of Bores	1					
Betriebsart Operating Mode	automatisch Automatic					
Verzahnung Tooth System	SAE 1 1/2' 10 C					
gekröpft links Off-set Left (mm)	-35					
Bohrung-Ø 1 Bore Ø 1 (mm)	16					
Bohrungsabstand 1 Bore Distance 1 (mm)	130					

BG-03.030

Gestängesteller, Bremsanlage Brake Adjuster



Gestängesteller, Bremsanlage | Brake Adjuster

Gestängesteller, Bremsanlage

Brake Adjuster

passend für | to fit to
Bergische Achse; SAF

Zähnezahl	10
Number of Teeth	
Anzahl der Bohrungen	6
Number of Bores	
Betriebsart	automatisch
Operating Mode	Automatic
Verzahnung	SAE 1 1/2' 10 C
Tooth System	
gekröpft links	0
Off-set Left (mm)	
Bohrung-Ø 1	14
Bore Ø 1 (mm)	
Bohrung-Ø 2	14
Bore Ø 2 (mm)	
Bohrung-Ø 3	14
Bore Ø 3 (mm)	
Bohrung-Ø 4	14
Bore Ø 4 (mm)	
Bohrung-Ø 5	14
Bore Ø 5 (mm)	
Bohrungsabstand 1	250
Bore Distance 1 (mm)	
Bohrungsabstand 2	180
Bore Distance 2 (mm)	
Bohrungsabstand 3	165
Bore Distance 3 (mm)	
Bohrungsabstand 4	150
Bore Distance 4 (mm)	
Bohrungsabstand 5	135
Bore Distance 5 (mm)	



03.030.8750.42S

Vergl.-Nr. | Comp.No
72876D

Gestängesteller, Bremsanlage | Brake Adjuster

Gestängesteller, Bremsanlage Brake Adjuster	Zähnezahl	10		03.030.8750.43S Vergl.-Nr. Comp.No 80023D
	Number of Teeth			
	Anzahl der Bohrungen	4		
	Number of Bores			
	Betriebsart	automatisch		
	Operating Mode	Automatic		
	Verzahnung	SAE 1 1/2" 10 C		
	Tooth System			
	gekröpft links	0		
	Off-set Left (mm)			
	Bohrung-Ø 1	16		
	Bore Ø 1 (mm)			
	Bohrung-Ø 2	14		
	Bore Ø 2 (mm)			
	Bohrung-Ø 3	14		
	Bore Ø 3 (mm)			
	Bohrung-Ø 4	14		
	Bore Ø 4 (mm)			
	Bohrungsabstand 1	215		
	Bore Distance 1 (mm)			
	Bohrungsabstand 2	153		
	Bore Distance 2 (mm)			
	Bohrungsabstand 3	129		
	Bore Distance 3 (mm)			
	Bohrungsabstand 4	105		
	Bore Distance 4 (mm)			

BG-03.030

Gestängesteller, Bremsanlage Brake Adjuster



Gestängesteller, Bremsanlage | Brake Adjuster

Gestängesteller, Bremsanlage	Zähnezahl	10		03.030.8750.44S Vergl.-Nr. Comp.No 80024D
Brake Adjuster	Number of Teeth			
	Anzahl der Bohrungen	4		
	Number of Bores			
	Betriebsart	automatisch		
	Operating Mode	Automatic		
	Verzahnung	SAE 1 1/2' 10 C		
	Tooth System			
	gekröpft links	0		
	Off-set Left (mm)			
	Bohrung-Ø 1	14		
	Bore Ø 1 (mm)			
	Bohrung-Ø 2	14		
	Bore Ø 2 (mm)			
	Bohrung-Ø 3	14		
	Bore Ø 3 (mm)			
	Bohrung-Ø 4	14		
	Bore Ø 4 (mm)			
	Bohrungsabstand 1	210		
	Bore Distance 1 (mm)			
	Bohrungsabstand 2	180		
	Bore Distance 2 (mm)			
	Bohrungsabstand 3	150		
	Bore Distance 3 (mm)			
	Bohrungsabstand 4	125		
	Bore Distance 4 (mm)			

Gestängesteller, Bremsanlage | Brake Adjuster



Gestängesteller, Bremsanlage Brake Adjuster	Zähnezahl	10		03.030.8750.45S
	Number of Teeth			
passend für to fit to DAF	Anzahl der Bohrungen	5		Vergl.-Nr. Comp.No 80020D
	Number of Bores			
	Betriebsart	automatisch		
	Operating Mode	Automatic		
	Verzahnung	SAE 1 1/2' 10 C		
	Tooth System			
	gekröpft links	0		
	Off-set Left (mm)			
	Bohrung-Ø 1	14		
	Bore Ø 1 (mm)			
	Bohrung-Ø 2	14		
	Bore Ø 2 (mm)			
	Bohrung-Ø 3	14		
	Bore Ø 3 (mm)			
	Bohrung-Ø 4	14		
	Bore Ø 4 (mm)			
	Bohrung-Ø 5	14		
	Bore Ø 5 (mm)			
	Bohrungsabstand 1	205		
	Bore Distance 1 (mm)			
	Bohrungsabstand 2	153		
	Bore Distance 2 (mm)			
	Bohrungsabstand 3	140		
	Bore Distance 3 (mm)			
	Bohrungsabstand 4	127		
	Bore Distance 4 (mm)			
	Bohrungsabstand 5	115		
	Bore Distance 5 (mm)			

BG-03.030

Gestängesteller, Bremsanlage Brake Adjuster



Gestängesteller, Bremsanlage | Brake Adjuster

Gestängesteller, Bremsanlage Brake Adjuster	Zähnezahl	10		03.030.8750.46S																		
	Number of Teeth				Vergl.-Nr. Comp.No 79005D																	
passend für to fit to DAF; RENAULT; SAF	Anzahl der Bohrungen	6																				
	Number of Bores																					
Betriebsart	automatisch																					
Operating Mode	Automatic																					
Verzahnung	SAE 1 1/2' 10 C																					
Tooth System																						
gekröpft links	0																					
Off-set Left (mm)																						
Bohrung-Ø 1	14																					
Bore Ø 1 (mm)																						
Bohrung-Ø 2	14																					
Bore Ø 2 (mm)																						
Bohrung-Ø 3	14																					
Bore Ø 3 (mm)																						
Bohrung-Ø 4	14																					
Bore Ø 4 (mm)																						
Bohrung-Ø 5	14																					
Bore Ø 5 (mm)																						
Bohrungsabstand 1	250																					
Bore Distance 1 (mm)																						
Bohrungsabstand 2	180																					
Bore Distance 2 (mm)																						
Bohrungsabstand 3	155																					
Bore Distance 3 (mm)																						
Bohrungsabstand 4	140																					
Bore Distance 4 (mm)																						
Bohrungsabstand 5	125																					
Bore Distance 5 (mm)																						
Gestängesteller, Bremsanlage Brake Adjuster	Zähnezahl									26												03.030.8750.470
Number of Teeth										Vergl.-Nr. Comp.No 72919												
passend für to fit to Mercedes-Benz	Anzahl der Bohrungen									1												
	Number of Bores																					
Betriebsart	automatisch																					
Operating Mode	Automatic																					
Verzahnung	N42x1.5x9H DIN 5480																					
Tooth System																						
gekröpft links	-56																					
Off-set Left (mm)																						
Bohrung-Ø 1	14																					
Bore Ø 1 (mm)																						
Bohrungsabstand 1	145																					
Bore Distance 1 (mm)																						



BG-03.030

Gestängesteller, Bremsanlage Brake Adjuster

Gestängesteller, Bremsanlage | Brake Adjuster



Gestängesteller, Bremsanlage	Zähnezahl	10		03.030.8750.480
Brake Adjuster	Number of Teeth			Vergl.-Nr. Comp.No
	Anzahl der Bohrungen	5		80022
passend für to fit to	Number of Bores			
DAF; RENAULT; SAF	Betriebsart	automatisch		
	Operating Mode	Automatic		
	Verzahnung	SAE 1 1/2' 10 C		
	Tooth System			
	gekröpft links	0		
	Off-set Left (mm)			
	Bohrung-Ø 1	14		
	Bore Ø 1 (mm)			
	Bohrung-Ø 2	14		
	Bore Ø 2 (mm)			
	Bohrung-Ø 3	14		
	Bore Ø 3 (mm)			
	Bohrung-Ø 4	14		
	Bore Ø 4 (mm)			
	Bohrung-Ø 5	14		
	Bore Ø 5 (mm)			
	Bohrungsabstand 1	250		
	Bore Distance 1 (mm)			
	Bohrungsabstand 2	180		
	Bore Distance 2 (mm)			
	Bohrungsabstand 3	155		
	Bore Distance 3 (mm)			
	Bohrungsabstand 4	140		
	Bore Distance 4 (mm)			
	Bohrungsabstand 5	125		
	Bore Distance 5 (mm)			

BG-03.030



Gestängesteller, Bremsanlage Brake Adjuster



Gestängesteller, Bremsanlage | Brake Adjuster

Gestängesteller, Bremsanlage Brake Adjuster passend für to fit to Bergische Achse; DAF; SAF	Zähnezahl	10		03.030.8750.490 Vergl.-Nr. Comp.No 80019
	Number of Teeth			
	Anzahl der Bohrungen	6		
	Number of Bores			
	Betriebsart	automatisch		
	Operating Mode	Automatic		
	Verzahnung	SAE 1 1/2' 10 C		
	Tooth System			
	gekröpft links	0		
	Off-set Left (mm)			
	Bohrung-Ø 1	14		
	Bore Ø 1 (mm)			
	Bohrung-Ø 2	14		
	Bore Ø 2 (mm)			
	Bohrung-Ø 3	14		
	Bore Ø 3 (mm)			
	Bohrung-Ø 4	14		
	Bore Ø 4 (mm)			
	Bohrung-Ø 5	14		
	Bore Ø 5 (mm)			
Bohrungsabstand 1	250			
Bore Distance 1 (mm)				
Bohrungsabstand 2	180			
Bore Distance 2 (mm)				
Bohrungsabstand 3	165			
Bore Distance 3 (mm)				
Bohrungsabstand 4	150			
Bore Distance 4 (mm)				
Bohrungsabstand 5	135			
Bore Distance 5 (mm)				
Gestängesteller, Bremsanlage Brake Adjuster passend für to fit to DAF	Zähnezahl	10		03.030.8750.510 Vergl.-Nr. Comp.No 72139
	Number of Teeth			
	Anzahl der Bohrungen	1		
	Number of Bores			
	Betriebsart	automatisch		
	Operating Mode	Automatic		
	Verzahnung	SAE 1 1/2' 10 C		
	Tooth System			
	gekröpft links	0		
	Off-set Left (mm)			
Bohrungsabstand 1	140			
Bore Distance 1 (mm)				

Gestängesteller, Bremsanlage | Brake Adjuster



Gestängesteller, Bremsanlage Brake Adjuster passend für to fit to SCANIA	Zähnezahl	10		03.030.8750.520 Vergl.-Nr. Comp.No 72957
	Number of Teeth			
	Anzahl der Bohrungen	1		
	Number of Bores			
	Betriebsart	automatisch		
	Operating Mode	Automatic		
	Verzahnung	SAE 1 1/2° 10 C		
	Tooth System			
	gekröpft links	16		
	Off-set Left (mm)			
	Bohrung-Ø 1	16		
	Bore Ø 1 (mm)			
Bohrungsabstand 1	130			
Bore Distance 1 (mm)				
Gestängesteller, Bremsanlage Brake Adjuster passend für to fit to RENAULT	Zähnezahl	27		03.030.8750.530 Vergl.-Nr. Comp.No 72318
	Number of Teeth			
	Anzahl der Bohrungen	1		
	Number of Bores			
	Betriebsart	automatisch		
	Operating Mode	Automatic		
	Verzahnung	BNA 227, °35.0		
	Tooth System			
	gekröpft links	38		
	Off-set Left (mm)			
	Bohrung-Ø 1	14		
	Bore Ø 1 (mm)			
Bohrungsabstand 1	175			
Bore Distance 1 (mm)				
Gestängesteller, Bremsanlage Brake Adjuster passend für to fit to RENAULT	Zähnezahl	27		03.030.8750.540 Vergl.-Nr. Comp.No 79307
	Number of Teeth			
	Anzahl der Bohrungen	1		
	Number of Bores			
	Betriebsart	automatisch		
	Operating Mode	Automatic		
	Verzahnung	BNA 227, °35.0		
	Tooth System			
	gekröpft links	-38		
	Off-set Left (mm)			
	Bohrung-Ø 1	14		
	Bore Ø 1 (mm)			
Bohrungsabstand 1	175			
Bore Distance 1 (mm)				

BG-03.030



Gestängesteller, Bremsanlage Brake Adjuster



Gestängesteller, Bremsanlage | Brake Adjuster

Gestängesteller, Bremsanlage Brake Adjuster passend für to fit to VOLVO	Zähnezahl	10		03.030.8750.550 Vergl.-Nr. Comp.No 72721C
	Number of Teeth			
	Anzahl der Bohrungen	1		
	Number of Bores			
	Betriebsart	automatisch		
	Operating Mode	Automatic		
	Verzahnung	SAE 1 1/2' 10 C		
	Tooth System			
	gekröpft links	+12,7		
	Off-set Left (mm)			
	Bohrung-Ø 1	12,7		
	Bore Ø 1 (mm)			
	Bohrungsabstand 1	159		
Bore Distance 1 (mm)				
Gestängesteller, Bremsanlage Brake Adjuster passend für to fit to VOLVO	Zähnezahl	10		03.030.8750.560 Vergl.-Nr. Comp.No 72722C
	Number of Teeth			
	Anzahl der Bohrungen	1		
	Number of Bores			
	Betriebsart	automatisch		
	Operating Mode	Automatic		
	Verzahnung	SAE 1 1/2' 10 C		
	Tooth System			
	gekröpft links	-12,7		
	Off-set Left (mm)			
	Bohrung-Ø 1	12,7		
	Bore Ø 1 (mm)			
	Bohrungsabstand 1	159		
Bore Distance 1 (mm)				
Gestängesteller, Bremsanlage Brake Adjuster passend für to fit to SCANIA	Zähnezahl	10		03.030.8750.570 Vergl.-Nr. Comp.No 72655C
	Number of Teeth			
	Anzahl der Bohrungen	1		
	Number of Bores			
	Betriebsart	automatisch		
	Operating Mode	Automatic		
	Verzahnung	SAE 1 1/2' 10 C		
	Tooth System			
	gekröpft links	+47,6		
	Off-set Left (mm)			
	Bohrung-Ø 1	12,7		
	Bore Ø 1 (mm)			
	Bohrungsabstand 1	151		
Bore Distance 1 (mm)				

Gestängesteller, Bremsanlage | Brake Adjuster



Gestängesteller, Bremsanlage Brake Adjuster passend für to fit to SCANIA	Zähnezahl	10		03.030.8750.580 Vergl.-Nr. Comp.No 72656C
	Number of Teeth			
	Anzahl der Bohrungen	1		
	Number of Bores			
	Betriebsart	automatisch		
	Operating Mode	Automatic		
	Verzahnung	SAE 1 1/2' 10 C		
	Tooth System			
	gekröpft links	-47,6		
	Off-set Left (mm)			
	Bohrung-Ø 1	12,7		
	Bore Ø 1 (mm)			
Bohrungsabstand 1	151			
Bore Distance 1 (mm)				
Gestängesteller, Bremsanlage Brake Adjuster passend für to fit to SCANIA	Zähnezahl	10		03.030.8750.590 Vergl.-Nr. Comp.No 72657
	Number of Teeth			
	Anzahl der Bohrungen	1		
	Number of Bores			
	Betriebsart	automatisch		
	Operating Mode	Automatic		
	Verzahnung	SAE 1 1/2' 10 C		
	Tooth System			
	gekröpft links	+60,3		
	Off-set Left (mm)			
	Bohrung-Ø 1	12,7		
	Bore Ø 1 (mm)			
Bohrungsabstand 1	151			
Bore Distance 1 (mm)				
Gestängesteller, Bremsanlage Brake Adjuster passend für to fit to SCANIA	Zähnezahl	10		03.030.8750.600 Vergl.-Nr. Comp.No 72729C
	Number of Teeth			
	Anzahl der Bohrungen	1		
	Number of Bores			
	Betriebsart	automatisch		
	Operating Mode	Automatic		
	Verzahnung	SAE 1 1/2' 10 C		
	Tooth System			
	gekröpft links	35		
	Off-set Left (mm)			
	Bohrung-Ø 1	16		
	Bore Ø 1 (mm)			
Bohrungsabstand 1	130			
Bore Distance 1 (mm)				

BG-03.030



Gestängesteller, Bremsanlage Brake Adjuster



Gestängesteller, Bremsanlage | Brake Adjuster

Gestängesteller, Bremsanlage Brake Adjuster passend für to fit to SCANIA	Zähnezahl	10		03.030.8750.610 Vergl.-Nr. Comp.No 72744C
	Number of Teeth			
	Anzahl der Bohrungen	1		
	Number of Bores			
	Betriebsart	automatisch		
	Operating Mode	Automatic		
	Verzahnung	SAE 1 1/2' 10 C		
	Tooth System			
	gekröpft links	38		
	Off-set Left (mm)			
	Bohrung-Ø 1	16		
	Bore Ø 1 (mm)			
Bohrungsabstand 1	165			
Bore Distance 1 (mm)				
Gestängesteller, Bremsanlage Brake Adjuster passend für to fit to DAF; SCANIA	Zähnezahl	10		03.030.8750.620 Vergl.-Nr. Comp.No 72745C
	Number of Teeth			
	Anzahl der Bohrungen	1		
	Number of Bores			
	Betriebsart	automatisch		
	Operating Mode	Automatic		
	Verzahnung	SAE 1 1/2' 10 C		
	Tooth System			
	gekröpft links	-38		
	Off-set Left (mm)			
	Bohrung-Ø 1	16		
	Bore Ø 1 (mm)			
Bohrungsabstand 1	165			
Bore Distance 1 (mm)				
Gestängesteller, Bremsanlage Brake Adjuster passend für to fit to RENAULT	Zähnezahl	27		03.030.8750.630 Vergl.-Nr. Comp.No 79011C
	Number of Teeth			
	Anzahl der Bohrungen	1		
	Number of Bores			
	Betriebsart	automatisch		
	Operating Mode	Automatic		
	Verzahnung	BNA 227, °35.0		
	Tooth System			
	gekröpft links	0		
	Off-set Left (mm)			
	Bohrung-Ø 1	14		
	Bore Ø 1 (mm)			
Bohrungsabstand 1	150			
Bore Distance 1 (mm)				

Gestängesteller, Bremsanlage | Brake Adjuster



Gestängesteller, Bremsanlage Brake Adjuster passend für to fit to RENAULT	Zähnezahl	27		03.030.8750.640 Vergl.-Nr. Comp.No 79019C
	Number of Teeth			
	Anzahl der Bohrungen	1		
	Number of Bores			
	Betriebsart	automatisch		
	Operating Mode	Automatic		
	Verzahnung	BNA 227, °35.0		
	Tooth System			
	gekröpft links	0		
	Off-set Left (mm)			
	Bohrung-Ø 1	14		
	Bore Ø 1 (mm)			
Bohrungsabstand 1	140			
Bore Distance 1 (mm)				
Gestängesteller, Bremsanlage Brake Adjuster passend für to fit to VOLVO	Zähnezahl	10		03.030.8750.650 Vergl.-Nr. Comp.No 79271C
	Number of Teeth			
	Anzahl der Bohrungen	1		
	Number of Bores			
	Betriebsart	automatisch		
	Operating Mode	Automatic		
	Verzahnung	SAE 1 1/2' 10 C		
	Tooth System			
	gekröpft links	0		
	Off-set Left (mm)			
	Bohrung-Ø 1	12,7		
	Bore Ø 1 (mm)			
Bohrungsabstand 1	127			
Bore Distance 1 (mm)				
Gestängesteller, Bremsanlage Brake Adjuster passend für to fit to VOLVO	Zähnezahl	10		03.030.8750.660 Vergl.-Nr. Comp.No 72901C
	Number of Teeth			
	Anzahl der Bohrungen	1		
	Number of Bores			
	Betriebsart	automatisch		
	Operating Mode	Automatic		
	Verzahnung	SAE 1 1/2' 10 C		
	Tooth System			
	gekröpft links	-12,7		
	Off-set Left (mm)			
	Bohrung-Ø 1	12,7		
	Bore Ø 1 (mm)			
Bohrungsabstand 1	140			
Bore Distance 1 (mm)				

BG-03.030



Gestängesteller, Bremsanlage Brake Adjuster



Gestängesteller, Bremsanlage | Brake Adjuster

Gestängesteller, Bremsanlage Brake Adjuster passend für to fit to VOLVO	Zähnezahl	10		03.030.8750.670 Vergl.-Nr. Comp.No 72902C
	Number of Teeth			
	Anzahl der Bohrungen	1		
	Number of Bores			
	Betriebsart	automatisch		
	Operating Mode	Automatic		
	Verzahnung	SAE 1 1/2' 10 C		
	Tooth System			
	gekröpft links	+12,7		
	Off-set Left (mm)			
	Bohrung-Ø 1	12,7		
	Bore Ø 1 (mm)			
Bohrungsabstand 1	140			
Bore Distance 1 (mm)				
Gestängesteller, Bremsanlage Brake Adjuster passend für to fit to VOLVO	Zähnezahl	10		03.030.8750.680 Vergl.-Nr. Comp.No 72944C
	Number of Teeth			
	Anzahl der Bohrungen	1		
	Number of Bores			
	Betriebsart	automatisch		
	Operating Mode	Automatic		
	Verzahnung	SAE 1 1/2' 10 C		
	Tooth System			
	gekröpft links	0		
	Off-set Left (mm)			
	Bohrung-Ø 1	12,7		
	Bore Ø 1 (mm)			
Bohrungsabstand 1	152			
Bore Distance 1 (mm)				
Gestängesteller, Bremsanlage Brake Adjuster passend für to fit to SCANIA	Zähnezahl	10		03.030.8750.690 Vergl.-Nr. Comp.No 72947C
	Number of Teeth			
	Anzahl der Bohrungen	1		
	Number of Bores			
	Betriebsart	automatisch		
	Operating Mode	Automatic		
	Verzahnung	SAE 1 1/2' 10 C		
	Tooth System			
	gekröpft links	0		
	Off-set Left (mm)			
	Bohrung-Ø 1	16		
	Bore Ø 1 (mm)			
Bohrungsabstand 1	180			
Bore Distance 1 (mm)				

Gestängesteller, Bremsanlage | Brake Adjuster



Gestängesteller, Bremsanlage Brake Adjuster passend für to fit to SCANIA	Zähnezahl	10		03.030.8750.700 Vergl.-Nr. Comp.No 72910C
	Number of Teeth			
	Anzahl der Bohrungen	1		
	Number of Bores			
	Betriebsart	automatisch		
	Operating Mode	Automatic		
	Verzahnung	SAE 1 1/2' 10 C		
	Tooth System			
	gekröpft links	0		
	Off-set Left (mm)			
	Bohrung-Ø 1	16		
	Bore Ø 1 (mm)			
	Bohrungsabstand 1	130		
Bore Distance 1 (mm)				
Gestängesteller, Bremsanlage Brake Adjuster passend für to fit to VOLVO	Zähnezahl	10		03.030.8750.710 Vergl.-Nr. Comp.No 72784C
	Number of Teeth			
	Anzahl der Bohrungen	1		
	Number of Bores			
	Betriebsart	automatisch		
	Operating Mode	Automatic		
	Verzahnung	SAE 1 1/2' 10 C		
	Tooth System			
	gekröpft links	15		
	Off-set Left (mm)			
	Bohrung-Ø 1	12,7		
	Bore Ø 1 (mm)			
	Bohrungsabstand 1	165		
Bore Distance 1 (mm)				
Gestängesteller, Bremsanlage Brake Adjuster passend für to fit to VOLVO	Zähnezahl	10		03.030.8750.720 Vergl.-Nr. Comp.No 72785C
	Number of Teeth			
	Anzahl der Bohrungen	1		
	Number of Bores			
	Betriebsart	automatisch		
	Operating Mode	Automatic		
	Verzahnung	SAE 1 1/2' 10 C		
	Tooth System			
	gekröpft links	-15		
	Off-set Left (mm)			
	Bohrung-Ø 1	12,7		
	Bore Ø 1 (mm)			
	Bohrungsabstand 1	165		
Bore Distance 1 (mm)				

BG-03.030



Gestängesteller, Bremsanlage Brake Adjuster



Gestängesteller, Bremsanlage | Brake Adjuster

Gestängesteller, Bremsanlage Brake Adjuster passend für to fit to RENAULT	Zähnezahl	27		03.030.8750.730 Vergl.-Nr. Comp.No 79013C
	Number of Teeth			
	Anzahl der Bohrungen	1		
	Number of Bores			
	Betriebsart	automatisch		
	Operating Mode	Automatic		
	Verzahnung	BNA 227, °35.0		
	Tooth System			
	gekröpft links	38		
	Off-set Left (mm)			
	Bohrung-Ø 1	14		
	Bore Ø 1 (mm)			
Bohrungsabstand 1	175			
Bore Distance 1 (mm)				
Gestängesteller, Bremsanlage Brake Adjuster passend für to fit to RENAULT	Zähnezahl	27		03.030.8750.740 Vergl.-Nr. Comp.No 79014C
	Number of Teeth			
	Anzahl der Bohrungen	1		
	Number of Bores			
	Betriebsart	automatisch		
	Operating Mode	Automatic		
	Verzahnung	BNA 227, °35.0		
	Tooth System			
	gekröpft links	-38		
	Off-set Left (mm)			
	Bohrung-Ø 1	14		
	Bore Ø 1 (mm)			
Bohrungsabstand 1	175			
Bore Distance 1 (mm)				
Gestängesteller, Bremsanlage Brake Adjuster passend für to fit to SCANIA	Zähnezahl	10		03.030.8750.750 Vergl.-Nr. Comp.No 72747C
	Number of Teeth			
	Anzahl der Bohrungen	1		
	Number of Bores			
	Betriebsart	automatisch		
	Operating Mode	Automatic		
	Verzahnung	SAE 1 1/2° 10 C		
	Tooth System			
	gekröpft links	16		
	Off-set Left (mm)			
	Bohrung-Ø 1	12,7		
	Bore Ø 1 (mm)			
Bohrungsabstand 1	130			
Bore Distance 1 (mm)				

Gestängesteller, Bremsanlage | Brake Adjuster



Gestängesteller, Bremsanlage Brake Adjuster passend für to fit to RENAULT	Zähnezahl	27		03.030.8750.760 Vergl.-Nr. Comp.No 79152C
	Number of Teeth			
	Anzahl der Bohrungen	1		
	Number of Bores			
	Betriebsart	automatisch		
	Operating Mode	Automatic		
	Verzahnung	BNA 227, °35.0		
	Tooth System			
	gekröpft links	-22		
	Off-set Left (mm)			
	Bohrung-Ø 1	14		
Bore Ø 1 (mm)				
Bohrungsabstand 1	183			
Bore Distance 1 (mm)				
Gestängesteller, Bremsanlage Brake Adjuster passend für to fit to RENAULT	Zähnezahl	27		03.030.8750.770 Vergl.-Nr. Comp.No 79153C
	Number of Teeth			
	Anzahl der Bohrungen	1		
	Number of Bores			
	Betriebsart	automatisch		
	Operating Mode	Automatic		
	Verzahnung	BNA 227, °35.0		
	Tooth System			
	gekröpft links	22		
	Off-set Left (mm)			
	Bohrung-Ø 1	14		
Bore Ø 1 (mm)				
Bohrungsabstand 1	183			
Bore Distance 1 (mm)				
Gestängesteller, Bremsanlage Brake Adjuster passend für to fit to RENAULT	Zähnezahl	27		03.030.8750.780 Vergl.-Nr. Comp.No 79150C
	Number of Teeth			
	Anzahl der Bohrungen	1		
	Number of Bores			
	Betriebsart	automatisch		
	Operating Mode	Automatic		
	Verzahnung	BNA 227		
	Tooth System			
	gekröpft links	23		
	Off-set Left (mm)			
	Bohrung-Ø 1	14		
Bore Ø 1 (mm)				
Bohrungsabstand 1	190			
Bore Distance 1 (mm)				

BG-03.030



Gestängesteller, Bremsanlage Brake Adjuster



Gestängesteller, Bremsanlage | Brake Adjuster

Gestängesteller, Bremsanlage Brake Adjuster passend für to fit to RENAULT	Zähnezahl	27		03.030.8750.790 Vergl.-Nr. Comp.No 79151C
	Number of Teeth			
	Anzahl der Bohrungen	1		
	Number of Bores			
	Betriebsart	automatisch		
	Operating Mode	Automatic		
	Verzahnung	BNA 227		
	Tooth System			
	gekröpft links	-23		
	Off-set Left (mm)			
	Bohrung-Ø 1	14		
	Bore Ø 1 (mm)			
	Bohrungsabstand 1	190		
Bore Distance 1 (mm)				
Gestängesteller, Bremsanlage Brake Adjuster passend für to fit to RENAULT	Zähnezahl	27		03.030.8750.800 Vergl.-Nr. Comp.No 79303C
	Number of Teeth			
	Anzahl der Bohrungen	1		
	Number of Bores			
	Betriebsart	automatisch		
	Operating Mode	Automatic		
	Verzahnung	BNA 227, °35.0		
	Tooth System			
	gekröpft links	0		
	Off-set Left (mm)			
	Bohrung-Ø 1	14		
	Bore Ø 1 (mm)			
	Bohrungsabstand 1	190		
Bore Distance 1 (mm)				
Gestängesteller, Bremsanlage Brake Adjuster passend für to fit to RENAULT	Zähnezahl	28		03.030.8750.810 Vergl.-Nr. Comp.No 79298C
	Number of Teeth			
	Anzahl der Bohrungen	1		
	Number of Bores			
	Betriebsart	automatisch		
	Operating Mode	Automatic		
	Verzahnung	SAE 1 1/2' 10 C		
	Tooth System			
	gekröpft links	0		
	Off-set Left (mm)			
	Bohrung-Ø 1	14		
	Bore Ø 1 (mm)			
	Bohrungsabstand 1	160		
Bore Distance 1 (mm)				

Gestängesteller, Bremsanlage | Brake Adjuster



Gestängesteller, Bremsanlage Brake Adjuster passend für to fit to RENAULT	<table border="1"> <tr><td>Zähnezahl</td><td>27</td></tr> <tr><td>Number of Teeth</td><td></td></tr> <tr><td>Anzahl der Bohrungen</td><td>1</td></tr> <tr><td>Number of Bores</td><td></td></tr> <tr><td>Betriebsart</td><td>automatisch</td></tr> <tr><td>Operating Mode</td><td>Automatic</td></tr> <tr><td>Verzahnung</td><td>BNA 227, °35.0</td></tr> <tr><td>Tooth System</td><td></td></tr> <tr><td>gekröpft links</td><td>38</td></tr> <tr><td>Off-set Left (mm)</td><td></td></tr> <tr><td>Bohrung-Ø 1</td><td>14</td></tr> <tr><td>Bore Ø 1 (mm)</td><td></td></tr> <tr><td>Bohrungsabstand 1</td><td>160</td></tr> <tr><td>Bore Distance 1 (mm)</td><td></td></tr> </table>	Zähnezahl	27	Number of Teeth		Anzahl der Bohrungen	1	Number of Bores		Betriebsart	automatisch	Operating Mode	Automatic	Verzahnung	BNA 227, °35.0	Tooth System		gekröpft links	38	Off-set Left (mm)		Bohrung-Ø 1	14	Bore Ø 1 (mm)		Bohrungsabstand 1	160	Bore Distance 1 (mm)			03.030.8750.820 Vergl.-Nr. Comp.No 79301C
Zähnezahl	27																														
Number of Teeth																															
Anzahl der Bohrungen	1																														
Number of Bores																															
Betriebsart	automatisch																														
Operating Mode	Automatic																														
Verzahnung	BNA 227, °35.0																														
Tooth System																															
gekröpft links	38																														
Off-set Left (mm)																															
Bohrung-Ø 1	14																														
Bore Ø 1 (mm)																															
Bohrungsabstand 1	160																														
Bore Distance 1 (mm)																															
Gestängesteller, Bremsanlage Brake Adjuster passend für to fit to RENAULT	<table border="1"> <tr><td>Zähnezahl</td><td>27</td></tr> <tr><td>Number of Teeth</td><td></td></tr> <tr><td>Anzahl der Bohrungen</td><td>1</td></tr> <tr><td>Number of Bores</td><td></td></tr> <tr><td>Betriebsart</td><td>automatisch</td></tr> <tr><td>Operating Mode</td><td>Automatic</td></tr> <tr><td>Verzahnung</td><td>BNA 227, °35.0</td></tr> <tr><td>Tooth System</td><td></td></tr> <tr><td>gekröpft links</td><td>-38</td></tr> <tr><td>Off-set Left (mm)</td><td></td></tr> <tr><td>Bohrung-Ø 1</td><td>14</td></tr> <tr><td>Bore Ø 1 (mm)</td><td></td></tr> <tr><td>Bohrungsabstand 1</td><td>160</td></tr> <tr><td>Bore Distance 1 (mm)</td><td></td></tr> </table>	Zähnezahl	27	Number of Teeth		Anzahl der Bohrungen	1	Number of Bores		Betriebsart	automatisch	Operating Mode	Automatic	Verzahnung	BNA 227, °35.0	Tooth System		gekröpft links	-38	Off-set Left (mm)		Bohrung-Ø 1	14	Bore Ø 1 (mm)		Bohrungsabstand 1	160	Bore Distance 1 (mm)			03.030.8750.830 Vergl.-Nr. Comp.No 79302C
Zähnezahl	27																														
Number of Teeth																															
Anzahl der Bohrungen	1																														
Number of Bores																															
Betriebsart	automatisch																														
Operating Mode	Automatic																														
Verzahnung	BNA 227, °35.0																														
Tooth System																															
gekröpft links	-38																														
Off-set Left (mm)																															
Bohrung-Ø 1	14																														
Bore Ø 1 (mm)																															
Bohrungsabstand 1	160																														
Bore Distance 1 (mm)																															
Gestängesteller, Bremsanlage Brake Adjuster passend für to fit to RENAULT	<table border="1"> <tr><td>Zähnezahl</td><td>27</td></tr> <tr><td>Number of Teeth</td><td></td></tr> <tr><td>Anzahl der Bohrungen</td><td>1</td></tr> <tr><td>Number of Bores</td><td></td></tr> <tr><td>Betriebsart</td><td>automatisch</td></tr> <tr><td>Operating Mode</td><td>Automatic</td></tr> <tr><td>Verzahnung</td><td>BNA 227</td></tr> <tr><td>Tooth System</td><td></td></tr> <tr><td>gekröpft links</td><td>+56,2</td></tr> <tr><td>Off-set Left (mm)</td><td></td></tr> <tr><td>Bohrung-Ø 1</td><td>14</td></tr> <tr><td>Bore Ø 1 (mm)</td><td></td></tr> <tr><td>Bohrungsabstand 1</td><td>175</td></tr> <tr><td>Bore Distance 1 (mm)</td><td></td></tr> </table>	Zähnezahl	27	Number of Teeth		Anzahl der Bohrungen	1	Number of Bores		Betriebsart	automatisch	Operating Mode	Automatic	Verzahnung	BNA 227	Tooth System		gekröpft links	+56,2	Off-set Left (mm)		Bohrung-Ø 1	14	Bore Ø 1 (mm)		Bohrungsabstand 1	175	Bore Distance 1 (mm)			03.030.8750.840 Vergl.-Nr. Comp.No 72683
Zähnezahl	27																														
Number of Teeth																															
Anzahl der Bohrungen	1																														
Number of Bores																															
Betriebsart	automatisch																														
Operating Mode	Automatic																														
Verzahnung	BNA 227																														
Tooth System																															
gekröpft links	+56,2																														
Off-set Left (mm)																															
Bohrung-Ø 1	14																														
Bore Ø 1 (mm)																															
Bohrungsabstand 1	175																														
Bore Distance 1 (mm)																															

BG-03.030



Gestängesteller, Bremsanlage Brake Adjuster



Gestängesteller, Bremsanlage | Brake Adjuster

Gestängesteller, Bremsanlage Brake Adjuster passend für to fit to RENAULT	Zähnezahl	27		03.030.8750.850 Vergl.-Nr. Comp.No 72787
	Number of Teeth			
	Anzahl der Bohrungen	1		
	Number of Bores			
	Betriebsart	automatisch		
	Operating Mode	Automatic		
	Verzahnung	BNA 227		
	Tooth System			
	gekröpft links	-56,2		
	Off-set Left (mm)			
	Bohrung-Ø 1	14		
	Bore Ø 1 (mm)			
Bohrungsabstand 1	175			
Bore Distance 1 (mm)				
Gestängesteller, Bremsanlage Brake Adjuster passend für to fit to RENAULT	Zähnezahl	27		03.030.8750.860 Vergl.-Nr. Comp.No 79310C
	Number of Teeth			
	Anzahl der Bohrungen	1		
	Number of Bores			
	Betriebsart	automatisch		
	Operating Mode	Automatic		
	Verzahnung	BNA 227, °35.0		
	Tooth System			
	gekröpft links	-56,2		
	Off-set Left (mm)			
	Bohrung-Ø 1	14		
	Bore Ø 1 (mm)			
Bohrungsabstand 1	160			
Bore Distance 1 (mm)				
Gestängesteller, Bremsanlage Brake Adjuster passend für to fit to RENAULT	Zähnezahl	27		03.030.8750.870 Vergl.-Nr. Comp.No 79311C
	Number of Teeth			
	Anzahl der Bohrungen	1		
	Number of Bores			
	Betriebsart	automatisch		
	Operating Mode	Automatic		
	Verzahnung	BNA 227, °35.0		
	Tooth System			
	gekröpft links	+56,2		
	Off-set Left (mm)			
	Bohrung-Ø 1	14		
	Bore Ø 1 (mm)			
Bohrungsabstand 1	160			
Bore Distance 1 (mm)				

Gestängesteller, Bremsanlage | Brake Adjuster



Gestängesteller, Bremsanlage Brake Adjuster passend für to fit to DAF	Zähnezahl	10		03.030.8750.880 Vergl.-Nr. Comp.No 72535
	Number of Teeth			
	Anzahl der Bohrungen	1		
	Number of Bores			
	Betriebsart	automatisch		
	Operating Mode	Automatic		
	Verzahnung	SAE 1 1/2" 10 C		
	Tooth System			
	gekröpft links	0		
	Off-set Left (mm)			
	Bohrung-Ø 1	14		
	Bore Ø 1 (mm)			
	Bohrungsabstand 1	140		
Bore Distance 1 (mm)				
Gestängesteller, Bremsanlage Brake Adjuster passend für to fit to DAF	Zähnezahl	10		03.030.8750.890 Vergl.-Nr. Comp.No 72558
	Number of Teeth			
	Anzahl der Bohrungen	1		
	Number of Bores			
	Betriebsart	automatisch		
	Operating Mode	Automatic		
	Verzahnung	SAE 1 1/2" 10 C		
	Tooth System			
	gekröpft links	0		
	Off-set Left (mm)			
	Bohrung-Ø 1	14		
	Bore Ø 1 (mm)			
	Bohrungsabstand 1	140		
Bore Distance 1 (mm)				
Gestängesteller, Bremsanlage Brake Adjuster passend für to fit to RENAULT	Zähnezahl	27		03.030.8750.910 Vergl.-Nr. Comp.No 79300C
	Number of Teeth			
	Anzahl der Bohrungen	1		
	Number of Bores			
	Betriebsart	automatisch		
	Operating Mode	Automatic		
	Verzahnung	BNA 227, °35.0		
	Tooth System			
	gekröpft links	38		
	Off-set Left (mm)			
	Bohrung-Ø 1	14		
	Bore Ø 1 (mm)			
	Bohrungsabstand 1	160		
Bore Distance 1 (mm)				

BG-03.030



Gestängesteller, Bremsanlage Brake Adjuster



Gestängesteller, Bremsanlage | Brake Adjuster

Gestängesteller, Bremsanlage Brake Adjuster passend für to fit to RENAULT	Zähnezahl	27		03.030.8750.920 Vergl.-Nr. Comp.No 70975
	Number of Teeth			
	Anzahl der Bohrungen	1		
	Number of Bores			
	Betriebsart	automatisch		
	Operating Mode	Automatic		
	Verzahnung	BNA 227		
	Tooth System			
	gekröpft links	-12,4		
	Off-set Left (mm)			
	Bohrung-Ø 1	14		
	Bore Ø 1 (mm)			
Bohrungsabstand 1	238			
Bore Distance 1 (mm)				
Gestängesteller, Bremsanlage Brake Adjuster passend für to fit to RENAULT	Zähnezahl	27		03.030.8750.930 Vergl.-Nr. Comp.No 70976
	Number of Teeth			
	Anzahl der Bohrungen	1		
	Number of Bores			
	Betriebsart	automatisch		
	Operating Mode	Automatic		
	Verzahnung	BNA 227		
	Tooth System			
	gekröpft links	+12,4		
	Off-set Left (mm)			
	Bohrung-Ø 1	14		
	Bore Ø 1 (mm)			
Bohrungsabstand 1	238			
Bore Distance 1 (mm)				
Gestängesteller, Bremsanlage Brake Adjuster passend für to fit to MAN	Zähnezahl	26		03.030.8750.940 Vergl.-Nr. Comp.No 79215C
	Number of Teeth			
	Anzahl der Bohrungen	1		
	Number of Bores			
	Betriebsart	automatisch		
	Operating Mode	Automatic		
	Verzahnung	N42x1.5x9H DIN 5480		
	Tooth System			
	gekröpft links	0		
	Off-set Left (mm)			
	Bohrung-Ø 1	14		
	Bore Ø 1 (mm)			
Bohrungsabstand 1	130			
Bore Distance 1 (mm)				

Gestängesteller, Bremsanlage | Brake Adjuster



Gestängesteller, Bremsanlage Brake Adjuster passend für to fit to Mercedes-Benz	Zähnezahl	26		03.030.8750.950 Vergl.-Nr. Comp.No 72920
	Number of Teeth			
	Anzahl der Bohrungen	1		
	Number of Bores			
	Betriebsart	automatisch		
	Operating Mode	Automatic		
	Verzahnung	N42x1.5x9H DIN 5480		
	Tooth System			
	gekröpft links	56		
	Off-set Left (mm)			
	Bohrung-Ø 1	14		
	Bore Ø 1 (mm)			
	Bohrungsabstand 1	145		
Bore Distance 1 (mm)				
Gestängesteller, Bremsanlage Brake Adjuster passend für to fit to Mercedes-Benz	Zähnezahl	26		03.030.8750.960 Vergl.-Nr. Comp.No 70917
	Number of Teeth			
	Anzahl der Bohrungen	1		
	Number of Bores			
	Betriebsart	automatisch		
	Operating Mode	Automatic		
	Verzahnung	N42x1.5x9H DIN 5480		
	Tooth System			
	gekröpft links	56		
	Off-set Left (mm)			
	Bohrung-Ø 1	14		
	Bore Ø 1 (mm)			
	Bohrungsabstand 1	145		
Bore Distance 1 (mm)				
Gestängesteller, Bremsanlage Brake Adjuster passend für to fit to DAF; MAN	Zähnezahl	26		03.030.8750.970 Vergl.-Nr. Comp.No 79216C
	Number of Teeth			
	Anzahl der Bohrungen	1		
	Number of Bores			
	Betriebsart	automatisch		
	Operating Mode	Automatic		
	Verzahnung	N42x1.5x9H DIN 5480		
	Tooth System			
	gekröpft links	-40		
	Off-set Left (mm)			
	Bohrung-Ø 1	14		
	Bore Ø 1 (mm)			
	Bohrungsabstand 1	130		
Bore Distance 1 (mm)				

BG-03.030



Gestängesteller, Bremsanlage Brake Adjuster



Gestängesteller, Bremsanlage | Brake Adjuster

Gestängesteller, Bremsanlage Brake Adjuster passend für to fit to DAF; MAN	Zähnezahl	26		03.030.8750.980 Vergl.-Nr. Comp.No 79217C
	Number of Teeth			
	Anzahl der Bohrungen	1		
	Number of Bores			
	Betriebsart	automatisch		
	Operating Mode	Automatic		
	Verzahnung	N42x1.5x9H DIN 5480		
	Tooth System			
	gekröpft links	40		
	Off-set Left (mm)			
	Bohrung-Ø 1	14		
	Bore Ø 1 (mm)			
	Bohrungsabstand 1	130		
Bore Distance 1 (mm)				
Gestängesteller, Bremsanlage Brake Adjuster passend für to fit to Mercedes-Benz	Zähnezahl	26		03.030.8750.990 Vergl.-Nr. Comp.No 72056
	Number of Teeth			
	Anzahl der Bohrungen	1		
	Number of Bores			
	Betriebsart	automatisch		
	Operating Mode	Automatic		
	Verzahnung	N42x1.5x9H DIN 5480		
	Tooth System			
	gekröpft links	0		
	Off-set Left (mm)			
	Bohrung-Ø 1	14		
	Bore Ø 1 (mm)			
	Bohrungsabstand 1	145		
Bore Distance 1 (mm)				

Gestängesteller, Bremsanlage | Brake Adjuster



Gestängesteller, Bremsanlage Brake Adjuster passend für to fit to Bergische Achse; DAF	Länge	180		03.030.0240.870 Vergl.-Nr. Comp.No 100101041
	Length (mm)			
	Breite	51		
	Width (mm)			
	Zähnezahl	10		
	Number of Teeth			
	Anzahl der Bohrungen	3		
	Number of Bores			
	Betriebsart	manuell		
	Operating Mode	Manual		
	Verzahnung	SAE 1 1/2' 10 C		
	Tooth System			
	gekröpft links	0		
	Off-set Left (mm)			
	Bohrungsabstand 1	120		
	Bore Distance 1 (mm)			
Bohrungsabstand 2	150			
Bore Distance 2 (mm)				
Bohrungsabstand 3	180			
Bore Distance 3 (mm)				
Gestängesteller, Bremsanlage Brake Adjuster passend für to fit to Bergische Achse	Länge	290		03.030.0240.880 Vergl.-Nr. Comp.No 100001128
	Length (mm)			
	Breite	38		
	Width (mm)			
	Zähnezahl	10		
	Number of Teeth			
	Anzahl der Bohrungen	4		
	Number of Bores			
	Betriebsart	automatisch		
	Operating Mode	Automatic		
	Verzahnung	SAE 1 1/2' 10 C		
	Tooth System			
	gekröpft links	0		
	Off-set Left (mm)			
	Bohrungsabstand 1	175		
	Bore Distance 1 (mm)			
Bohrungsabstand 2	230			
Bore Distance 2 (mm)				
Bohrungsabstand 3	260			
Bore Distance 3 (mm)				
Bohrungsabstand 4	290			
Bore Distance 4 (mm)				

BG-03.030

Gestängesteller, Bremsanlage Brake Adjuster



Gestängesteller, Bremsanlage | Brake Adjuster

Gestängesteller, Bremsanlage Brake Adjuster passend für to fit to DAF; Mercedes-Benz	Länge	180		03.030.0240.890 Vergl.-Nr. Comp.No 100001021
	Length (mm)			
	Breite	38		
	Width (mm)			
	Zähnezahl	10		
	Number of Teeth			
	Anzahl der Bohrungen	3		
	Number of Bores			
	Betriebsart	automatisch		
	Operating Mode	Automatic		
	Verzahnung	SAE 1 1/2' 10 C		
	Tooth System			
	gekröpft links	0		
	Off-set Left (mm)			
	Bohrungsabstand 1	120		
	Bore Distance 1 (mm)			
Bohrungsabstand 2	150			
Bore Distance 2 (mm)				
Bohrungsabstand 3	180			
Bore Distance 3 (mm)				
Gestängesteller, Bremsanlage Brake Adjuster passend für to fit to Bergische Achse; DAF	Zähnezahl	10		03.030.0240.900 Vergl.-Nr. Comp.No 100101041
Number of Teeth				
Anzahl der Bohrungen	5			
Number of Bores				
Betriebsart	automatisch			
Operating Mode	Automatic			
Verzahnung	SAE 1 1/2' 10 C			
Tooth System				
gekröpft links	0			
Off-set Left (mm)				
Bohrungsabstand 1	120			
Bore Distance 1 (mm)				
Bohrungsabstand 2	150			
Bore Distance 2 (mm)				
Bohrungsabstand 3	180			
Bore Distance 3 (mm)				
Bohrungsabstand 4	220			
Bore Distance 4 (mm)				
Bohrungsabstand 5	250			
Bore Distance 5 (mm)				

Gestängesteller, Bremsanlage | Brake Adjuster

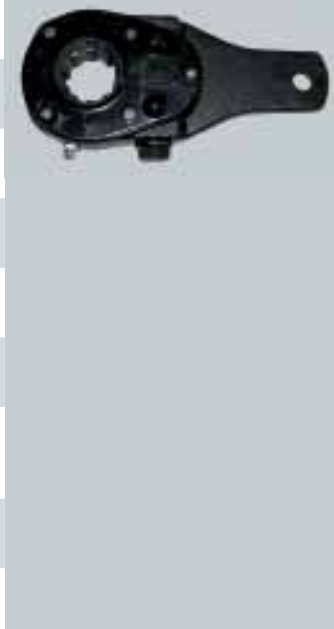
Gestängesteller, Bremsanlage Brake Adjuster passend für to fit to Bergische Achse	Zähnezahl	10		03.030.0244.901 Vergl.-Nr. Comp.No 100001760
	Number of Teeth			
	Anzahl der Bohrungen	7		
	Number of Bores			
	Betriebsart	automatisch		
	Operating Mode	Automatic		
	Verzahnung	SAE 1 1/2' 10 C		
	Tooth System			
	gekröpft links	0		
	Off-set Left (mm)			
	Bohrungsabstand 1	120		
	Bore Distance 1 (mm)			
	Bohrungsabstand 2	135		
	Bore Distance 2 (mm)			
	Bohrungsabstand 3	150		
Bore Distance 3 (mm)				
Bohrungsabstand 4	165			
Bore Distance 4 (mm)				
Bohrungsabstand 5	180			
Bore Distance 5 (mm)				
Gestängesteller, Bremsanlage Brake Adjuster passend für to fit to DAF	Länge	156		03.030.0285.001 Vergl.-Nr. Comp.No 100101364
	Length (mm)			
	Einbauseite	hinten		
	Fitting Position	Rear		
	Zähnezahl	10		
	Number of Teeth			
	Anzahl der Bohrungen	1		
	Number of Bores			
	Bohrungsabstand	140		
	Bore Distance (mm)			
	Betriebsart	manuell		
	Operating Mode	Manual		
	Verzahnung	SAE 1 1/2' 10 C		
	Tooth System			
	gekröpft links	0		
Off-set Left (mm)				
Bohrungsabstand 1	140			
Bore Distance 1 (mm)				

BG-03.030



Gestängesteller, Bremsanlage Brake Adjuster



Gestängesteller, Bremsanlage | Brake Adjuster

Gestängesteller, Bremsanlage Brake Adjuster passend für to fit to DAF; VOLVO	Einbauseite	vorne links		03.030.0287.000 Vergl.-Nr. Comp.No 104401201
	Fitting Position	Left Front		
	Zähnezahl	10		
	Number of Teeth			
	Anzahl der Bohrungen	1		
	Number of Bores			
	Bohrungsabstand	140		
	Bore Distance (mm)			
	Betriebsart	manuell		
	Operating Mode	Manual		
	Verzahnung	SAE 1 1/2' 10 C		
	Tooth System			
	gekröpft links	38		
	Off-set Left (mm)			
Bohrungsabstand 1	140			
Bore Distance 1 (mm)				
Gestängesteller, Bremsanlage Brake Adjuster passend für to fit to DAF	Länge	156		03.030.0288.001 Vergl.-Nr. Comp.No 100101364
	Length (mm)			
	Einbauseite	vorne rechts		
	Fitting Position	Right Front		
	Zähnezahl	10		
	Number of Teeth			
	Anzahl der Bohrungen	1		
	Number of Bores			
	Bohrungsabstand	140		
	Bore Distance (mm)			
	Betriebsart	manuell		
	Operating Mode	Manual		
	Verzahnung	SAE 1 1/2' 10 C		
	Tooth System			
gekröpft links	0			
Off-set Left (mm)				
Bohrungsabstand 1	140			
Bore Distance 1 (mm)				

Gestängesteller, Bremsanlage | Brake Adjuster



Gestängesteller, Bremsanlage Brake Adjuster passend für to fit to KÄSSBOHRER	Länge	310		03.030.0695.200 Vergl.-Nr. Comp.No 100002167
	Length (mm)			
	Breite	38		
	Width (mm)			
	Zähnezahl	37		
	Number of Teeth			
	Anzahl der Bohrungen	6		
	Number of Bores			
	Betriebsart	manuell		
	Operating Mode	Manual		
	Verzahnung	A36x40 DIN 5481		
	Tooth System			
	gekröpft links	0		
	Off-set Left (mm)			
	Bohrungsabstand 1	120		
	Bore Distance 1 (mm)			
	Bohrungsabstand 2	135		
Bore Distance 2 (mm)				
Bohrungsabstand 3	150			
Bore Distance 3 (mm)				
Bohrungsabstand 4	165			
Bore Distance 4 (mm)				
Bohrungsabstand 5	180			
Bore Distance 5 (mm)				
Gestängesteller, Bremsanlage Brake Adjuster passend für to fit to Bergische Achse; Mercedes-Benz	Länge	161		03.030.1906.560 Vergl.-Nr. Comp.No 104407401
	Length (mm)			
	Einbauseite	rechts		
	Fitting Position	Right		
	Zähnezahl	26		
	Number of Teeth			
	Anzahl der Bohrungen	1		
	Number of Bores			
	Betriebsart	manuell		
	Operating Mode	Manual		
Verzahnung	N42x1.5x9H DIN 5480			
Tooth System				
gekröpft links	-56			
Off-set Left (mm)				
Bohrungsabstand 1	145			
Bore Distance 1 (mm)				

BG-03.030



Gestängesteller, Bremsanlage Brake Adjuster



Gestängesteller, Bremsanlage | Brake Adjuster

Gestängesteller, Bremsanlage Brake Adjuster passend für to fit to Bergische Achse; Mercedes-Benz	Länge	161		03.030.1906.570 Vergl.-Nr. Comp.No 104507401
	Length (mm)			
	Einbauseite	links		
	Fitting Position	Left		
	Zähnezahl	26		
	Number of Teeth			
	Anzahl der Bohrungen	1		
	Number of Bores			
	Betriebsart	manuell		
	Operating Mode	Manual		
	Verzahnung	N42x1.5x9H DIN 5480		
	Tooth System			
	gekröpft links	56		
	Off-set Left (mm)			
Bohrungsabstand 1	145			
Bore Distance 1 (mm)				
Gestängesteller, Bremsanlage Brake Adjuster passend für to fit to SAF	Zähnezahl	10		03.030.2085.500 Vergl.-Nr. Comp.No 100101047
	Number of Teeth			
	Anzahl der Bohrungen	4		
	Number of Bores			
	Betriebsart	manuell		
	Operating Mode	Manual		
	Verzahnung	SAE 1 1/2' 10 C		
	Tooth System			
	gekröpft links	0		
	Off-set Left (mm)			
	Bohrungsabstand 1	127		
	Bore Distance 1 (mm)			
	Bohrungsabstand 2	152		
	Bore Distance 2 (mm)			
Bohrungsabstand 3	178			
Bore Distance 3 (mm)				
Bohrungsabstand 4	203			
Bore Distance 4 (mm)				



Reparatursatz, Gestängesteller | Repair Kit, adjuster

Reparatursatz, Gestängesteller Repair Kit, adjuster	Ergänzungsartikel / Ergänzende Info	automatisch		03.030.7161.0 S Vergl.-Nr. Comp.No 76046
	Supplementary Article/Supplementary Info	Automatic		
Reparatursatz, Gestängesteller Repair Kit, adjuster	Ergänzungsartikel / Ergänzende Info	automatisch		03.030.7161.01S Vergl.-Nr. Comp.No 76046
	Supplementary Article/Supplementary Info	Automatic		

**Reparatursatz, Gestängesteller
Repair Kit, adjuster**
Reparatursatz, Gestängesteller | Repair Kit, adjuster

Reparatursatz, Gestängesteller Repair Kit, adjuster	Ergänzungsartikel / Ergän- zende Info Supplementary Article/Sup- plementary Info	automatisch Automatic		03.030.8750.1 S Vergl.-Nr. Comp.No
--	---	------------------------------	--	--

Feder, Gestängesteller | Spring, adjuster

Feder, Gestängesteller Spring, adjuster	Länge Length (mm)	235		03.030.0241.850 Vergl.-Nr. Comp.No 05.397.26.02.0
	Aussendurchmesser Outer Diameter (mm)	22,5		
	Dicke/Stärke Thickness (mm)	2,5		
Feder, Gestängesteller Spring, adjuster	Länge Length (mm)	225		03.030.0241.860 Vergl.-Nr. Comp.No 05.397.26.01.0
	Aussendurchmesser Outer Diameter (mm)	25		
	Dicke/Stärke Thickness (mm)	3,2		





Bremsbackensatz | Brake Shoe Set

Bremsbackensatz Brake Shoe Set				03.040.4004.60S Vergl.-Nr. Comp.No 3090 074-0
passend für to fit to VOLVO				
Bremsbackensatz Brake Shoe Set				03.040.4004.7 S Vergl.-Nr. Comp.No 0270 828-7
passend für to fit to VOLVO				
Bremsbackensatz Brake Shoe Set				03.040.4004.8 S Vergl.-Nr. Comp.No 0270 827-9
passend für to fit to VOLVO				
Bremsbackensatz Brake Shoe Set				03.040.4004.9 S Vergl.-Nr. Comp.No 0270 829
passend für to fit to VOLVO				





BG-03.040

Bremsbacke Brake Shoe



Bremsbacke Brake Shoe				
Bremsbacke Brake Shoe	Breite Width (mm)	180		03.040.0242.700
	Material Material	Stahl Steel		
passend für to fit to Bergische Achse				Vergl.-Nr. Comp.No 05.091.26.21.0
Bremsbacke Brake Shoe	Länge Length (mm)	420		03.040.0242.760
	Breite Width (mm)	180		
passend für to fit to Bergische Achse		Material Material	Stahl Steel	Vergl.-Nr. Comp.No 05.091.26.64.2
	Bremsbelag Brake Pad	Komplett-Teil Full Body Section		
Bremsbacke Brake Shoe	Länge Length (mm)	420		03.040.0242.761
	Breite Width (mm)	180		
passend für to fit to Bergische Achse		Bremsbelag Brake Pad	mit Belag With lining	Vergl.-Nr. Comp.No 05.091.46.09.0
Stückliste Parts List				
1 x 03.040.0242.760 Bremsbacke Brake Shoe				
2 x 03.050.0242.762 Bremsbelag, Trommelbremse Brake Lining, drum brake				
20 x Niete, Trommelbremsbelag Rivet, drum brake lining				
03.060.7450.050				
Bremsbacke Brake Shoe	Bremsbelag Brake Pad	mit Belag With lining		03.040.0242.763
passend für to fit to Bergische Achse				Vergl.-Nr. Comp.No 05.091.46.09.0
Stückliste Parts List				
1 x 03.040.0242.760 Bremsbacke Brake Shoe				
2 x 03.050.0242.764 Bremsbelag, Trommelbremse Brake Lining, drum brake				
20 x Niete, Trommelbremsbelag Rivet, drum brake lining				
03.060.7450.050				
Bremsbacke Brake Shoe	Länge Length (mm)	420		03.040.0242.770
	Breite Width (mm)	200		
passend für to fit to Bergische Achse		Material Material	Stahl Steel	Vergl.-Nr. Comp.No 05.091.27.54.2
	Bremsbelag Brake Pad	Komplett-Teil Full Body Section		

Bremsbacke | Brake Shoe

<p>Bremsbacke Brake Shoe</p> <p>passend für to fit to Bergische Achse</p> <p>Stückliste Parts List 1 x 03.040.0242.770 Bremsbacke Brake Shoe 2 x 03.050.0242.772 Bremsbelag, Trommelbremse Brake Lining, drum brake 20 x Niete, Trommelbremsbelag Rivet, drum brake lining 03.060.7450.050</p>	<table border="1"> <tr><td>Breite</td><td>200</td></tr> <tr><td>Width (mm)</td><td></td></tr> <tr><td>Dicke/Stärke</td><td>18</td></tr> <tr><td>Thickness (mm)</td><td></td></tr> <tr><td>Bremsbelag</td><td>mit Belag</td></tr> <tr><td>Brake Pad</td><td>With lining</td></tr> <tr><td>Trommeldurchmesser</td><td>420</td></tr> <tr><td>Drum Diameter</td><td></td></tr> <tr><td>Anzahl Nietlöcher</td><td>10</td></tr> <tr><td>Number of Rivet Holes</td><td></td></tr> </table>	Breite	200	Width (mm)		Dicke/Stärke	18	Thickness (mm)		Bremsbelag	mit Belag	Brake Pad	With lining	Trommeldurchmesser	420	Drum Diameter		Anzahl Nietlöcher	10	Number of Rivet Holes			<p>03.040.0242.771</p> <p>Vergl.-Nr. Comp.No 05.091.27.79.0</p>
Breite	200																						
Width (mm)																							
Dicke/Stärke	18																						
Thickness (mm)																							
Bremsbelag	mit Belag																						
Brake Pad	With lining																						
Trommeldurchmesser	420																						
Drum Diameter																							
Anzahl Nietlöcher	10																						
Number of Rivet Holes																							
<p>Bremsbacke Brake Shoe</p> <p>passend für to fit to Bergische Achse</p> <p>Stückliste Parts List 1 x 03.040.0242.870 Bremsbacke Brake Shoe 2 x 03.050.0242.932 Bremsbelag, Trommelbremse Brake Lining, drum brake 20 x Niete, Trommelbremsbelag Rivet, drum brake lining 03.060.7450.050</p>	<table border="1"> <tr><td>Länge</td><td>300</td></tr> <tr><td>Length (mm)</td><td></td></tr> <tr><td>Breite</td><td>200</td></tr> <tr><td>Width (mm)</td><td></td></tr> </table>	Länge	300	Length (mm)		Breite	200	Width (mm)			<p>03.040.0242.870</p> <p>Vergl.-Nr. Comp.No 05.091.14.46.0</p>												
Länge	300																						
Length (mm)																							
Breite	200																						
Width (mm)																							
<p>Bremsbacke Brake Shoe</p> <p>passend für to fit to Bergische Achse</p> <p>Stückliste Parts List 1 x 03.040.0242.870 Bremsbacke Brake Shoe 2 x 03.050.0242.932 Bremsbelag, Trommelbremse Brake Lining, drum brake 20 x Niete, Trommelbremsbelag Rivet, drum brake lining 03.060.7450.050</p>	<table border="1"> <tr><td>Bremsbelag</td><td>mit Belag</td></tr> <tr><td>Brake Pad</td><td>With lining</td></tr> </table>	Bremsbelag	mit Belag	Brake Pad	With lining		<p>03.040.0242.871</p> <p>Vergl.-Nr. Comp.No 05.091.14.65.0</p>																
Bremsbelag	mit Belag																						
Brake Pad	With lining																						
<p>Bremsbacke Brake Shoe</p> <p>passend für to fit to Bergische Achse</p> <p>Stückliste Parts List 1 x 03.040.0242.930 Bremsbacke Brake Shoe 2 x 03.050.0242.932 Bremsbelag, Trommelbremse Brake Lining, drum brake 20 x Niete, Trommelbremsbelag Rivet, drum brake lining 03.060.7450.050</p>	<table border="1"> <tr><td>Länge</td><td>300</td></tr> <tr><td>Length (mm)</td><td></td></tr> <tr><td>Breite</td><td>200</td></tr> <tr><td>Width (mm)</td><td></td></tr> </table>	Länge	300	Length (mm)		Breite	200	Width (mm)			<p>03.040.0242.930</p> <p>Vergl.-Nr. Comp.No 05.091.14.19.0</p>												
Länge	300																						
Length (mm)																							
Breite	200																						
Width (mm)																							
<p>Bremsbacke Brake Shoe</p> <p>passend für to fit to Bergische Achse</p> <p>Stückliste Parts List 1 x 03.040.0242.931 Bremsbacke Brake Shoe 2 x 03.050.0242.932 Bremsbelag, Trommelbremse Brake Lining, drum brake 20 x Niete, Trommelbremsbelag Rivet, drum brake lining 03.060.7450.050</p>	<table border="1"> <tr><td>Bremsbelag</td><td>mit Belag</td></tr> <tr><td>Brake Pad</td><td>With lining</td></tr> </table>	Bremsbelag	mit Belag	Brake Pad	With lining		<p>03.040.0242.931</p> <p>Vergl.-Nr. Comp.No 05.091.14.70.0</p>																
Bremsbelag	mit Belag																						
Brake Pad	With lining																						



BG-03.040

Bremsbacke Brake Shoe



Bremsbacke Brake Shoe				
Bremsbacke Brake Shoe	Länge Length (mm)	360		03.040.0247.100 Vergl.-Nr. Comp.No 05.091.19.07.0
passend für to fit to Bergische Achse	Breite Width (mm)	200		
Bremsbacke Brake Shoe	Länge Length (mm)			03.040.0247.130 Vergl.-Nr. Comp.No 05.091.28.11.2
passend für to fit to Bergische Achse	Breite Width (mm)			
Stückliste Parts List 1 x 03.070.0242.900 Bremsbackenrolle Brake Shoe Sleeve 2 x 03.070.0242.910 Sicherungsclip Circlip 1 x 18.070.0243.530 Splint Split Pin				
Bremsbacke Brake Shoe	Länge Length (mm)	419		03.040.0290.320 Vergl.-Nr. Comp.No A-JA-0508-001 S
passend für to fit to Frühauf; Trailer	Breite Width (mm)	178		
Bremsbacke Brake Shoe	Länge Length (mm)	300		03.040.0672.500 Vergl.-Nr. Comp.No 016.26.52.200.03
passend für to fit to Kässbohrer	Breite Width (mm)	200		
Stückliste Parts List 1 x 03.070.0661.000 Bremsbackenrolle Brake Shoe Sleeve 1 x 03.070.0694.000 Sicherungsbügel Fastening Clamp 2 x 11.060.0672.480 Wellendichtring Shaft Oil Seal 1 x 20.010.0672.50R Bremsbacke Brake Shoe				
Bremsbacke Brake Shoe	Länge Length (mm)	400		03.040.0687.000 Vergl.-Nr. Comp.No 010.24.21.920.73
passend für to fit to Kässbohrer	Breite Width (mm)	200		
Stückliste Parts List 1 x 03.070.0661.000 Bremsbackenrolle Brake Shoe Sleeve 1 x 03.070.0694.000 Sicherungsbügel Fastening Clamp 2 x 03.070.0695.170 Buchse, Bremsbackenbolzen Bush, brake shoe pin 2 x 11.060.0672.480 Wellendichtring Shaft Oil Seal 1 x 20.010.0687.00R Bremsbacke Brake Shoe				

Bremsbacke | Brake Shoe



<p>Bremsbacke Brake Shoe</p> <p>passend für to fit to Kässbohrer</p>	<table border="1"> <tr> <td>Länge Length (mm)</td> <td>400</td> </tr> <tr> <td>Breite Width (mm)</td> <td>200</td> </tr> <tr> <td>Bremsbelag Brake Pad</td> <td>mit Belag With lining</td> </tr> </table>	Länge Length (mm)	400	Breite Width (mm)	200	Bremsbelag Brake Pad	mit Belag With lining		<p>03.040.0687.001</p> <p>Vergl.-Nr. Comp.No 015.26.21.500.36</p>				
Länge Length (mm)	400												
Breite Width (mm)	200												
Bremsbelag Brake Pad	mit Belag With lining												
<p>Stückliste Parts List</p> <p>2 x 03.050.0687.002 Bremsbelag, Trommelbremse Brake Lining, drum brake 20 x Niete, Trommelbremsbelag Rivet, drum brake lining</p> <p>03.060.7450.050 1 x 03.070.0661.000 Bremsbackenrolle Brake Shoe Sleeve 1 x 03.070.0694.000 Sicherungsbügel Fastening Clamp 2 x 03.070.0695.170 Buchse, Bremsbackenbolzen Bush, brake shoe pin 2 x 11.060.0672.480 Wellendichtring Shaft Oil Seal 1 x 20.010.0687.00R Bremsbacke Brake Shoe</p>													
<p>Bremsbacke Brake Shoe</p> <p>passend für to fit to MAN</p>	<table border="1"> <tr> <td>Länge Length (mm)</td> <td>410</td> </tr> <tr> <td>Breite Width (mm)</td> <td>180</td> </tr> <tr> <td>Material</td> <td>Stahl</td> </tr> <tr> <td>Material</td> <td>Steel</td> </tr> <tr> <td>Bremsbelag Brake Pad</td> <td>Komplett-Teil Full Body Section</td> </tr> </table>	Länge Length (mm)	410	Breite Width (mm)	180	Material	Stahl	Material	Steel	Bremsbelag Brake Pad	Komplett-Teil Full Body Section		<p>03.040.0904.140</p> <p>Vergl.-Nr. Comp.No 81.50201.6178</p>
Länge Length (mm)	410												
Breite Width (mm)	180												
Material	Stahl												
Material	Steel												
Bremsbelag Brake Pad	Komplett-Teil Full Body Section												
<p>Stückliste Parts List</p> <p>1 x 03.070.0941.000 Bremsbackenrolle Brake Shoe Sleeve 1 x 03.070.1455.020 Sicherungsring Circlip 1 x 03.070.1455.060 Bolzen, Bremsbackenrolle Pin, brake shoe sleeve 1 x 03.070.1455.070 Unterlegscheibe Washer 2 x 03.070.1457.030 Dichtring Seal Ring 1 x 03.070.1905.920 Federhaltestift, Bremsbacke Spring Retaining Pin, brake shoe 1 x 20.010.0904.53R Bremsbacke Brake Shoe</p>													
<p>Bremsbacke Brake Shoe</p> <p>passend für to fit to Mercedes-Benz; MAN</p>	<table border="1"> <tr> <td>Länge Length (mm)</td> <td>410</td> </tr> <tr> <td>Breite Width (mm)</td> <td>220</td> </tr> <tr> <td>Material</td> <td>Stahlguß</td> </tr> <tr> <td>Material</td> <td>Cast Steel</td> </tr> <tr> <td>Bremsbelag Brake Pad</td> <td>Komplett-Teil Full Body Section</td> </tr> </table>	Länge Length (mm)	410	Breite Width (mm)	220	Material	Stahlguß	Material	Cast Steel	Bremsbelag Brake Pad	Komplett-Teil Full Body Section		<p>03.040.1905.010</p> <p>Vergl.-Nr. Comp.No 659 420 04 19</p>
Länge Length (mm)	410												
Breite Width (mm)	220												
Material	Stahlguß												
Material	Cast Steel												
Bremsbelag Brake Pad	Komplett-Teil Full Body Section												

BG-03.040

Bremsbacke Brake Shoe



Bremsbacke | Brake Shoe

Bremsbacke Brake Shoe	Länge Length (mm)	410		03.040.1905.011 Vergl.-Nr. Comp.No 659 420 04 19
passend für to fit to Mercedes-Benz	Breite Width (mm)	220		
	Material	Stahlguß Cast Steel		
	Material	Cast Steel		
	Bremsbelag Brake Pad	mit Belag With lining		
Stückliste Parts List				
1 x 03.040.1905.010 Bremsbacke Brake Shoe 2 x 03.050.1905.012 Bremsbelag, Trommelbremse Brake Lining, drum brake 8 x 03.060.7450.550 Niete, Trommelbremsbelag Rivet, drum brake lining 8 x 03.060.7450.600 Niete, Trommelbremsbelag Rivet, drum brake lining				
Bremsbacke Brake Shoe	Länge Length (mm)	410		03.040.1905.740 Vergl.-Nr. Comp.No 335 420 00 19
passend für to fit to Mercedes-Benz	Breite Width (mm)	170		
	Material	Stahlguß Cast Steel		
	Material	Cast Steel		
	Bremsbelag Brake Pad	Komplett-Teil Full Body Section		
Stückliste Parts List				
2 x 03.070.1450.050 Buchse, Bremsbackenbolzen Bush, brake shoe pin 1 x 03.070.1454.000 Bolzen, Bremsbackenrolle Pin, brake shoe sleeve 1 x 03.070.1455.000 Bremsbackenrolle Brake Shoe Sleeve 1 x 03.070.1455.020 Sicherungsring Circlip 2 x 03.070.1455.050 Unterlegscheibe Washer 1 x 03.070.1455.080 Dichtring Seal Ring 1 x 20.010.1905.74R Bremsbacke Brake Shoe				
Bremsbacke Brake Shoe	Länge Length (mm)	410		03.040.1905.820 Vergl.-Nr. Comp.No 659 420 00 19
passend für to fit to Mercedes-Benz	Breite Width (mm)	160		
	Material	Stahl Steel		
	Material	Steel		
	Bremsbelag Brake Pad	Komplett-Teil Full Body Section		
Stückliste Parts List				
1 x 03.070.1455.000 Bremsbackenrolle Brake Shoe Sleeve 1 x 03.070.1455.020 Sicherungsring Circlip 1 x 03.070.1455.060 Bolzen, Bremsbackenrolle Pin, brake shoe sleeve 1 x 03.070.1455.070 Unterlegscheibe Washer 2 x 03.070.1455.080 Dichtring Seal Ring 2 x 03.070.1455.100 Sicherungsring Circlip 2 x 03.070.1457.030 Dichtring Seal Ring 1 x 03.070.1905.910 Federhaltestift, Bremsbacke Spring Retaining Pin, brake shoe 1 x 20.010.1905.82R Bremsbacke Brake Shoe				

Bremsbacke | Brake Shoe

Bremsbacke	Länge	410
Brake Shoe	Length (mm)	
	Breite	160
	Width (mm)	
passend für to fit to	Material	Stahl
Mercedes-Benz	Material	Steel
	Bremsbelag	mit Belag
	Brake Pad	With lining

Stückliste | Parts List

- 1 x 03.040.1905.820 Bremsbacke | Brake Shoe
- 2 x 03.050.1905.822 Bremsbelag, Trommelbremse | Brake Lining, drum brake
- 16 x Niete, Trommelbremsbelag | Rivet, drum brake lining
- 03.060.7450.500
- 1 x 03.070.1455.000 Bremsbackenrolle | Brake Shoe Sleeve
- 1 x 03.070.1455.020 Sicherungsring | Circlip
- 1 x 03.070.1455.060 Bolzen, Bremsbackenrolle | Pin, brake shoe sleeve
- 1 x 03.070.1455.070 Unterlegscheibe | Washer
- 2 x 03.070.1455.080 Dichtring | Seal Ring
- 2 x 03.070.1455.100 Sicherungsring | Circlip
- 2 x 03.070.1457.030 Dichtring | Seal Ring
- 1 x 03.070.1905.910 Federhaltestift, Bremsbacke | Spring Retaining Pin, brake shoe

Bremsbacke	Länge	410
Brake Shoe	Length (mm)	
	Breite	180
	Width (mm)	
passend für to fit to	Material	Stahlguß
Mercedes-Benz	Material	Cast Steel
	Bremsbelag	Komplett-Teil
	Brake Pad	Full Body Section

Stückliste | Parts List

- 1 x 03.070.1455.000 Bremsbackenrolle | Brake Shoe Sleeve
- 1 x 03.070.1455.020 Sicherungsring | Circlip
- 1 x 03.070.1455.060 Bolzen, Bremsbackenrolle | Pin, brake shoe sleeve
- 1 x 03.070.1455.070 Unterlegscheibe | Washer
- 2 x 03.070.1455.080 Dichtring | Seal Ring
- 2 x 03.070.1455.100 Sicherungsring | Circlip
- 2 x 03.070.1457.030 Dichtring | Seal Ring
- 1 x 03.070.1905.910 Federhaltestift, Bremsbacke | Spring Retaining Pin, brake shoe
- 1 x 20.010.1905.94R Bremsbacke | Brake Shoe



03.040.1905.821

Vergl.-Nr. | Comp.No
393 420 03 19



03.040.1905.850

Vergl.-Nr. | Comp.No
389 420 61 19

BG-03.040

Bremsbacke Brake Shoe



Bremsbacke | Brake Shoe

Bremsbacke	Länge	410
Brake Shoe	Length (mm)	
	Breite	180
	Width (mm)	
passend für to fit to	Material	Stahlguß
Mercedes-Benz	Material	Cast Steel
	Bremsbelag	mit Belag
	Brake Pad	With lining

Stückliste | Parts List

- 2 x 03.050.1905.942 Bremsbelag, Trommelbremse | Brake Lining, drum brake
- 16 x Niete, Trommelbremsbelag | Rivet, drum brake lining
- 03.060.7450.550
- 1 x 03.070.1455.000 Bremsbackenrolle | Brake Shoe Sleeve
- 1 x 03.070.1455.020 Sicherungsring | Circlip
- 1 x 03.070.1455.060 Bolzen, Bremsbackenrolle | Pin, brake shoe sleeve
- 1 x 03.070.1455.070 Unterlegscheibe | Washer
- 2 x 03.070.1455.080 Dichtring | Seal Ring
- 2 x 03.070.1455.100 Sicherungsring | Circlip
- 2 x 03.070.1457.030 Dichtring | Seal Ring
- 1 x 03.070.1905.910 Federhaltestift, Bremsbacke | Spring Retaining Pin, brake shoe
- 1 x 20.010.1905.94R Bremsbacke | Brake Shoe



03.040.1905.851

Vergl.-Nr. | Comp.No
389 420 61 19

Bremsbacke	Länge	410
Brake Shoe	Length (mm)	
	Breite	180
	Width (mm)	
passend für to fit to	Material	Stahl
Mercedes-Benz	Material	Steel
	Bremsbelag	Komplett-Teil
	Brake Pad	Full Body Section

Stückliste | Parts List

- 1 x 03.070.1455.000 Bremsbackenrolle | Brake Shoe Sleeve
- 1 x 03.070.1455.020 Sicherungsring | Circlip
- 1 x 03.070.1455.060 Bolzen, Bremsbackenrolle | Pin, brake shoe sleeve
- 1 x 03.070.1455.070 Unterlegscheibe | Washer
- 2 x 03.070.1455.080 Dichtring | Seal Ring
- 2 x 03.070.1455.100 Sicherungsring | Circlip
- 2 x 03.070.1457.030 Dichtring | Seal Ring
- 1 x 03.070.1905.910 Federhaltestift, Bremsbacke | Spring Retaining Pin, brake shoe
- 1 x 20.010.1905.94R Bremsbacke | Brake Shoe



03.040.1905.940

Vergl.-Nr. | Comp.No
659 420 03 19

Bremsbacke	Länge	410
Brake Shoe	Length (mm)	
	Breite	180
	Width (mm)	
passend für to fit to	Material	Stahl
Mercedes-Benz	Material	Steel
	Bremsbelag	mit Belag
	Brake Pad	With lining

Stückliste | Parts List





- 1 x 03.040.1905.940 Bremsbacke | Brake Shoe
- 2 x 03.050.1905.942 Bremsbelag, Trommelbremse | Brake Lining, drum brake
- 16 x Niete, Trommelbremsbelag | Rivet, drum brake lining
- 03.060.7450.550
- 1 x 03.070.1455.000 Bremsbackenrolle | Brake Shoe Sleeve



03.040.1905.941

Vergl.-Nr. | Comp.No
350 420 03 19





Bremsbacke | Brake Shoe





Bremsbacke	Länge	410		03.040.1905.960 Vergl.-Nr. Comp.No 659 420 13 19	
Brake Shoe	Length (mm)				
	Breite	220			
passend für to fit to	Width (mm)				
Mercedes-Benz	Material	Stahlguß			
	Material	Cast Steel			
Bremsbacke	Länge	420		03.040.2053.000 Vergl.-Nr. Comp.No 3.054.0052.00	
Brake Shoe	Length (mm)				
	Breite	180			
passend für to fit to	Width (mm)				
SAF	Bremsbelag	Komplett-Teil			
	Brake Pad	Full Body Section			
Stückliste Parts List					
1 x 03.070.2012.000 Bremsbackenrolle Brake Shoe Sleeve					
2 x 03.070.2051.000 Halteblech, Bremsbackenbolzen Retaining Plate, brake shoe pins					
2 x 03.070.2065.000 Schraube Screw / Bolt					
2 x 18.060.2064.000 Mutter Nut					
Bremsbacke	Länge	420		03.040.2053.010 Vergl.-Nr. Comp.No 3.055.0052.00	
Brake Shoe	Length (mm)				
	Breite	180			
passend für to fit to	Width (mm)				
SAF	Bremsbelag	mit Belag			
	Brake Pad	With lining			
Stückliste Parts List					
1 x 03.040.2053.000 Bremsbacke Brake Shoe					
2 x 03.050.0242.762 Bremsbelag, Trommelbremse Brake Lining, drum brake					
20 x 03.060.7450.050 Niete, Trommelbremsbelag Rivet, drum brake lining					
Bremsbacke	Länge	420		03.040.2054.000 Vergl.-Nr. Comp.No 3.054.0053.00	
Brake Shoe	Length (mm)				
	Breite	200			
passend für to fit to	Width (mm)				
SAF	Bremsbelag	Komplett-Teil			
	Brake Pad	Full Body Section			
Stückliste Parts List					
1 x 03.070.2012.000 Bremsbackenrolle Brake Shoe Sleeve					
2 x 03.070.2051.000 Halteblech, Bremsbackenbolzen Retaining Plate, brake shoe pins					
2 x 03.070.2065.000 Schraube Screw / Bolt					
2 x 18.060.2064.000 Mutter Nut					

BG-03.040

Bremsbacke Brake Shoe



Bremsbacke Brake Shoe				
Bremsbacke	Länge	420		03.040.2054.010 Vergl.-Nr. Comp.No 3.055.0053.00
Brake Shoe	Length (mm)			
	Breite	220		
	Width (mm)			
passend für to fit to SAF	Bremsbelag	mit Belag		
	Brake Pad	With lining		
Stückliste Parts List				
2 x 03.050.0242.772 Bremsbelag, Trommelbremse Brake Lining, drum brake				
20 x Niete, Trommelbremsbelag Rivet, drum brake lining				
03.060.7450.050				
1 x 03.070.2012.000 Bremsbackenrolle Brake Shoe Sleeve				
2 x 03.070.2051.000 Halteblech, Bremsbackenbolzen Retaining Plate, brake shoe pins				
2 x 03.070.2065.000 Schraube Screw / Bolt				
2 x 18.060.2064.000 Mutter Nut				
Bremsbacke				03.040.2060.000 Vergl.-Nr. Comp.No 3.054.0084.00
Brake Shoe				
passend für to fit to SAF				
Stückliste Parts List				
1 x 03.070.2012.000 Bremsbackenrolle Brake Shoe Sleeve				
2 x 03.070.2051.000 Halteblech, Bremsbackenbolzen Retaining Plate, brake shoe pins				
2 x 03.070.2065.000 Schraube Screw / Bolt				
2 x 18.060.2064.000 Mutter Nut				
1 x 20.010.2060.0R0 Bremsbacke Brake Shoe				
Bremsbacke	Länge	300		03.040.2060.010 Vergl.-Nr. Comp.No 3.055.0084.00
Brake Shoe	Length (mm)			
	Breite	200		
	Width (mm)			
passend für to fit to SAF	Bremsbelag	mit Belag		
	Brake Pad	With lining		
Stückliste Parts List				
20 x Niete, Trommelbremsbelag Rivet, drum brake lining				
03.060.7450.550				
1 x 03.070.2012.000 Bremsbackenrolle Brake Shoe Sleeve				
2 x 03.070.2051.000 Halteblech, Bremsbackenbolzen Retaining Plate, brake shoe pins				
2 x 03.070.2065.000 Schraube Screw / Bolt				
1 x 03.070.2221.700 Federhaltestift, Bremsbacke Spring Retaining Pin, brake shoe				
2 x 18.060.2064.000 Mutter Nut				
1 x 20.010.2060.0R0 Bremsbacke Brake Shoe				
Bremsbacke	Länge	420		03.040.2228.000 Vergl.-Nr. Comp.No 3.054.0120.00
Brake Shoe	Length (mm)			
	Breite	180		
	Width (mm)			
passend für to fit to SAF				
Bremsbacke				03.040.3504.140 Vergl.-Nr. Comp.No 1674 000B
Brake Shoe				
passend für to fit to Trailer				

Bremsbacke Brake Shoe				
Bremsbacke	Länge	419		03.040.3504.150 Vergl.-Nr. Comp.No M006093
Brake Shoe	Length (mm)			
	Breite	203		
passend für to fit to Trailer	Width (mm)			
	Bremsbelag	beinhaltete Rollen		
	Brake Pad	Pulleys con- tained		
Bremsbacke	Länge	419		03.040.3504.200 Vergl.-Nr. Comp.No 1649000R
Brake Shoe	Length (mm)			
	Breite	178		
passend für to fit to Trailer	Width (mm)			
Bremsbacke	Länge	419		03.040.4200.670 Vergl.-Nr. Comp.No 152 05 191
Brake Shoe	Length (mm)			
	Breite	220		
passend für to fit to ROR	Width (mm)			
	Bremsbelag	Komplett-Teil		
	Brake Pad	Full Body Section		
Bremsbacke	Länge	419		03.040.4200.680 Vergl.-Nr. Comp.No 152 05 533
Brake Shoe	Length (mm)			
	Breite	178		
passend für to fit to ROR	Width (mm)			
	Bremsbelag	Komplett-Teil		
	Brake Pad	Full Body Section		

BG-03.060

Niete, Trommelbremsbelag Rivet, drum brake lining



Bemaßungsgrundlage | Definition of Dimension



Artikel-Nr.	Nietart	Innendurchmesser	Länge	Material	DIN/ISO	Ref.-Nr.
article-no.	Rivet Type	Inner Diameter	Length	Material	DIN / ISO	Ref.-No.
03.060.7450.500	Stufenrohrniete Fully tubular rivet	8	15	Stahl Steel		307 990 01 97
03.060.7450.550	Stufenrohrniete Fully tubular rivet	8	18	Stahl Steel		307 990 02 97
03.060.7450.600	Stufenrohrniete Fully tubular rivet	8	20	Stahl Steel		06.24180.4559
03.060.7450.750	Halbhohlniete Brake-lining rivet, flat hat	4	10	Kupfer Copper		
03.060.7450.060	Halbhohlniete Brake-lining rivet, flat hat	5	14	Stahl Steel	7338 B	
03.060.7450.010	Halbhohlniete Brake-lining rivet, flat hat	5	14	Kupfer Copper	7338 B	
03.060.7450.090	Halbhohlniete Brake-lining rivet, flat hat	5	18	Stahl Steel	7338 B	
03.060.7450.040	Halbhohlniete Brake-lining rivet, flat hat	5	18	Kupfer Copper	7338 B	
03.060.7450.050	Halbhohlniete Brake-lining rivet, flat hat	8	15	Stahl Steel	7338 B	
03.060.7450.100	Halbhohlniete Brake-lining rivet, flat hat	8	15	Kupfer Copper	7338 B	
03.060.7450.700	Halbhohlniete Brake-lining rivet, flat hat	8	18	Stahl Steel	7338 B	4.267.0006.01
03.060.7450.150	Halbhohlniete Brake-lining rivet, flat hat	8	18	Kupfer Copper	7338 B	02.5805.82.35
03.060.7450.200	Halbhohlniete Brake-lining rivet, flat hat	8	20	Kupfer Copper	7338 B	02.5805.84.35
03.060.7450.950	Halbhohlniete Brake-lining rivet, flat hat	10	16	Stahl Steel		
03.060.7450.650	Senkkopf-Halbhohlniete Brake-lining rivet, countersunk	6,35	19,31	Kupfer Copper	7338 B	
03.060.7450.651	Senkkopf-Halbhohlniete Brake-lining rivet, countersunk	6,35	19	Stahl Steel	7338 B	
03.060.7450.800	Senkkopf-Halbhohlniete Brake-lining rivet, countersunk	6,35	14,3	Messing Brass		
03.060.7450.801	Senkkopf-Halbhohlniete Brake-lining rivet, countersunk	6,35	14,3	Stahl Steel		
03.060.7450.850	Senkkopf-Halbhohlniete Brake-lining rivet, countersunk	6,35	15,9	Messing Brass		
03.060.7450.851	Senkkopf-Halbhohlniete Brake-lining rivet, countersunk	6,35	15,9	Stahl Steel		

Bemaßungsgrundlage | Definition of Dimension

Artikel-Nr.	Nietart	Innendurchmesser	Länge	Material	DIN/ISO	Ref.-Nr.
article-no.	Rivet Type	Inner Diameter	Length	Material	DIN / ISO	Ref.-No.
03.060.7450.900	Senkkopf-Halbhohlniete Brake-lining rivet, countersunk	6,35	17,5	Messing Brass		
03.060.7450.901	Senkkopf-Halbhohlniete Brake-lining rivet, countersunk	6,35	17,5	Stahl Steel		
03.060.7450.250	Hohlniete Fully tubular rivet	8	15	Kupfer Copper	7338 C	02.5805.81.35
03.060.7450.260	Hohlniete Fully tubular rivet	8	15	Stahl Steel	7338 C	
03.060.7450.300	Hohlniete Fully tubular rivet	8	18	Kupfer Copper	7338 C	02.5805.83.35
03.060.7450.310	Hohlniete Fully tubular rivet	8	18	Stahl Steel	7338 C	
03.060.7450.350	Hohlniete Fully tubular rivet	8	20	Kupfer Copper	7338 C	
03.060.7450.360	Hohlniete Fully tubular rivet	8	20	Stahl Steel	7338 C	81.92201.0109
03.060.7450.000	Hohlniete Fully tubular rivet	8	22	Stahl Steel	7338 C	02.5805.80.35
03.060.7450.400	Hohlniete Fully tubular rivet	10	18	Kupfer Copper	7338 C	
03.060.7450.450	Hohlniete Fully tubular rivet	10	20	Kupfer Copper	7338 C	





SERVICE-HOTLINE

FON: +49 5156-9610-0

FAX: +49 5156-961196



Unterlegscheibe | Washer

Unterlegscheibe Washer	Aussendurchmesser Outer Diameter (mm)	31		03.070.0246.910 Vergl.-Nr. Comp.No 03.310.70.15.0
passend für to fit to Bergische Achse	Innendurchmesser Inner Diameter (mm)	24		
	Dicke/Stärke Thickness (mm)	7		
Unterlegscheibe Washer	Aussendurchmesser Outer Diameter (mm)	24		03.070.1455.050 Vergl.-Nr. Comp.No 317 990 16 40
passend für to fit to Mercedes-Benz	Innendurchmesser Inner Diameter (mm)	17		
	Dicke/Stärke Thickness (mm)	1,7		
Unterlegscheibe Washer	Aussendurchmesser Outer Diameter (mm)	24		03.070.1455.070 Vergl.-Nr. Comp.No 346 990 05 40
passend für to fit to Mercedes-Benz	Innendurchmesser Inner Diameter (mm)	17		
	Dicke/Stärke Thickness (mm)	1,7		
Unterlegscheibe Washer	Aussendurchmesser Outer Diameter (mm)	45		03.070.2030.000 Vergl.-Nr. Comp.No 1.331.0013.00
passend für to fit to SAF	Innendurchmesser Inner Diameter (mm)	32		
	Dicke/Stärke Thickness (mm)	1,5		
Unterlegscheibe Washer	Aussendurchmesser Outer Diameter (mm)	99		03.070.2094.000 Vergl.-Nr. Comp.No 1.331.0020.02
passend für to fit to SAF	Innendurchmesser Inner Diameter (mm)	50		
	Dicke/Stärke Thickness (mm)	9		

BG-03.070

Unterlegscheibe Washer



Schraube Screw / Bolt				
Schraube Screw / Bolt	Gewindemaß Thread Size	M10x34		03.070.0205.000
passend für to fit to Bergische Achse	Schlüsselweite Spanner Size	17		Vergl.-Nr. Comp.No 03.340.01.02.0
Schraube Screw / Bolt	Gewindemaß Thread Size	M10x28		03.070.0227.000
passend für to fit to Bergische Achse	Schlüsselweite Spanner Size	17	Vergl.-Nr. Comp.No 03.340.01.01.0	
Schraube Screw / Bolt	Gewindemaß Thread Size	M10x15		03.070.1904.930
passend für to fit to MAN; Mercedes-Benz	Schlüsselweite Spanner Size	17		Vergl.-Nr. Comp.No 000933 010130
Schraube Screw / Bolt	Gewindemaß Thread Size	M8x20		03.070.2065.000
passend für to fit to Mercedes-Benz; SAF	DIN/ISO DIN / ISO	933		Vergl.-Nr. Comp.No 4.343.1003.88

**Buchse, Bremsbackenbolzen
Bush, brake shoe pin**

Buchse, Bremsbackenbolzen Bush, brake shoe pin				
Buchse, Bremsbackenbolzen Bush, brake shoe pin	Innendurchmesser Inner Diameter (mm)	32		03.070.0240.760 Vergl.-Nr. Comp.No 03.112.22.07.0
	Aussendurchmesser Outer Diameter (mm)	36		
passend für to fit to Bergische Achse	Höhe Height (mm)	54		
Buchse, Bremsbackenbolzen Bush, brake shoe pin	Innendurchmesser Inner Diameter (mm)	32		03.070.0280.010 Vergl.-Nr. Comp.No 145 459
	Aussendurchmesser Outer Diameter (mm)	35		
passend für to fit to DAF	Höhe Height (mm)	18,5		
Buchse, Bremsbackenbolzen Bush, brake shoe pin	Innendurchmesser Inner Diameter (mm)	22		03.070.0281.010 Vergl.-Nr. Comp.No 0622 246
	Aussendurchmesser Outer Diameter (mm)	24		
passend für to fit to DAF	Höhe Height (mm)	19		
Buchse, Bremsbackenbolzen Bush, brake shoe pin	Innendurchmesser Inner Diameter (mm)	32		03.070.0290.150 Vergl.-Nr. Comp.No A-JA-0558-001
	Aussendurchmesser Outer Diameter (mm)	35		
passend für to fit to Frühauf	Höhe Height (mm)	37		
Buchse, Bremsbackenbolzen Bush, brake shoe pin	Innendurchmesser Inner Diameter (mm)	30		03.070.0695.170 Vergl.-Nr. Comp.No 6.694.030.300
	Aussendurchmesser Outer Diameter (mm)	34		
passend für to fit to Kässbohrer	Höhe Height (mm)	30		
Buchse, Bremsbackenbolzen Bush, brake shoe pin	Innendurchmesser Inner Diameter (mm)	20,3		03.070.0941.010 Vergl.-Nr. Comp.No 81.93020.0645
	Aussendurchmesser Outer Diameter (mm)	23		
passend für to fit to MAN	Höhe Height (mm)	39		
Buchse, Bremsbackenbolzen Bush, brake shoe pin	Innendurchmesser Inner Diameter (mm)	30		03.070.0942.000 Vergl.-Nr. Comp.No 81.93020.0013
	Aussendurchmesser Outer Diameter (mm)	35		
passend für to fit to MAN	Höhe Height (mm)	45		
Buchse, Bremsbackenbolzen Bush, brake shoe pin	Innendurchmesser Inner Diameter (mm)	20		03.070.1455.090 Vergl.-Nr. Comp.No 301 421 00 50
	Aussendurchmesser Outer Diameter (mm)	23		
passend für to fit to Mercedes-Benz	Höhe Height (mm)	25		

BG-03.070

Buchse, Bremsbackenbolzen Bush, brake shoe pin



Buchse, Bremsbackenbolzen Bush, brake shoe pin				
Buchse, Bremsbackenbolzen Bush, brake shoe pin	Innendurchmesser Inner Diameter (mm)	30		03.070.1457.010 Vergl.-Nr. Comp.No 302 421 01 50
passend für to fit to Mercedes-Benz	Aussendurchmesser Outer Diameter (mm)	32		
	Höhe Height (mm)	22		
Buchse, Bremsbackenbolzen Bush, brake shoe pin	Innendurchmesser Inner Diameter (mm)	30		03.070.1457.040 Vergl.-Nr. Comp.No 307 421 05 50
passend für to fit to Mercedes-Benz	Aussendurchmesser Outer Diameter (mm)	34		
	Höhe Height (mm)	42		
Buchse, Bremsbackenbolzen Bush, brake shoe pin	Innendurchmesser Inner Diameter (mm)	28		03.070.1920.020 Vergl.-Nr. Comp.No 318 421 00 50
passend für to fit to Mercedes-Benz	Aussendurchmesser Outer Diameter (mm)	31		
	Höhe Height (mm)	33,5		
Buchse, Bremsbackenbolzen Bush, brake shoe pin	Innendurchmesser Inner Diameter (mm)	30		03.070.1930.010 Vergl.-Nr. Comp.No 674 421 00 50
passend für to fit to Mercedes-Benz	Aussendurchmesser Outer Diameter (mm)	34		
	Höhe Height (mm)	47,5		
Buchse, Bremsbackenbolzen Bush, brake shoe pin	Innendurchmesser Inner Diameter (mm)	32		03.070.2002.000 Vergl.-Nr. Comp.No 1.230.0035.00
passend für to fit to SAF	Aussendurchmesser Outer Diameter (mm)	36		
	Höhe Height (mm)	40		
Buchse, Bremsbackenbolzen Bush, brake shoe pin	Innendurchmesser Inner Diameter (mm)	32		03.070.2007.000 Vergl.-Nr. Comp.No 1.230.0032.00
passend für to fit to SAF	Aussendurchmesser Outer Diameter (mm)	36		
	Höhe Height (mm)	32		
Buchse, Bremsbackenbolzen Bush, brake shoe pin	Innendurchmesser Inner Diameter (mm)	32		03.070.2049.000 Vergl.-Nr. Comp.No 1.230.0084.00
passend für to fit to SAF	Aussendurchmesser Outer Diameter (mm)	35		
	Höhe Height (mm)	37		
Buchse, Bremsbackenbolzen Bush, brake shoe pin	Innendurchmesser Inner Diameter (mm)	31,5		03.070.3000.330 Vergl.-Nr. Comp.No 141 164
passend für to fit to Scania	Aussendurchmesser Outer Diameter (mm)	35		
	Höhe Height (mm)	19		

Buchse, Bremsbackenbolzen Bush, brake shoe pin				
Buchse, Bremsbackenbolzen Bush, brake shoe pin	Innendurchmesser Inner Diameter (mm)	31,5		03.070.3000.340
passend für to fit to Scania	Aussendurchmesser Outer Diameter (mm)	35		Vergl.-Nr. Comp.No 141 163
	Höhe Height (mm)	25		
Buchse, Bremsbackenbolzen Bush, brake shoe pin	Innendurchmesser Inner Diameter (mm)	25		03.070.3000.380
passend für to fit to Scania	Aussendurchmesser Outer Diameter (mm)	28		Vergl.-Nr. Comp.No 154 261
	Höhe Height (mm)	10		
Buchse, Bremsbackenbolzen Bush, brake shoe pin	Innendurchmesser Inner Diameter (mm)	30		03.070.4000.570
passend für to fit to ROR	Aussendurchmesser Outer Diameter (mm)	34		Vergl.-Nr. Comp.No 0348 977-0
	Höhe Height (mm)	18		
Buchse, Bremsbackenbolzen Bush, brake shoe pin	Innendurchmesser Inner Diameter (mm)	30		03.070.4000.580
passend für to fit to ROR	Aussendurchmesser Outer Diameter (mm)	34		Vergl.-Nr. Comp.No 0348 978-8
	Höhe Height (mm)	24		
Buchse, Bremsbackenbolzen Bush, brake shoe pin	Innendurchmesser Inner Diameter (mm)	25,2		03.070.4000.720
passend für to fit to ROR	Aussendurchmesser Outer Diameter (mm)	28		Vergl.-Nr. Comp.No 0341 719-3
	Höhe Height (mm)	27		
Buchse, Bremsbackenbolzen Bush, brake shoe pin	Innendurchmesser Inner Diameter (mm)	32		03.070.4200.290
passend für to fit to ROR	Aussendurchmesser Outer Diameter (mm)	35		Vergl.-Nr. Comp.No 212 21 028
	Höhe Height (mm)	36,5		
Buchse, Bremsbackenbolzen Bush, brake shoe pin	Innendurchmesser Inner Diameter (mm)	32		03.070.4200.430
passend für to fit to ROR	Aussendurchmesser Outer Diameter (mm)	35		Vergl.-Nr. Comp.No 210 16 666
	Höhe Height (mm)	36		
Buchse, Bremsbackenbolzen Bush, brake shoe pin	Innendurchmesser Inner Diameter (mm)			03.070.4200.720
passend für to fit to ROR				Vergl.-Nr. Comp.No 165 00 005

BG-03.070

Bremsbackenrolle Brake Shoe Sleeve



Bremsbackenrolle Brake Shoe Sleeve				
Bremsbackenrolle Brake Shoe Sleeve passend für to fit to Bergische Achse	Länge	30		03.070.0207.000 Vergl.-Nr. Comp.No 03.200.64.01.0
	Length (mm)			
	Aussendurchmesser 1	24		
	Outer Diameter 1 (mm)			
Bremsbackenrolle Brake Shoe Sleeve passend für to fit to Bergische Achse	Aussendurchmesser 2	42		03.070.0240.000 Vergl.-Nr. Comp.No 03.200.34.02.0
	Outer Diameter 2 (mm)			
	Länge 1	42		
	Length 1 (mm)			
Bremsbackenrolle Brake Shoe Sleeve passend für to fit to Bergische Achse	Länge 2	51		03.070.0242.900 Vergl.-Nr. Comp.No 03.331.34.05.0
	Length 2 (mm)			
	Aussendurchmesser 1	26		
	Outer Diameter 1 (mm)			
Bremsbackenrolle Brake Shoe Sleeve passend für to fit to Bergische Achse	Aussendurchmesser 2	37		03.070.0243.000 Vergl.-Nr. Comp.No 03.331.34.02.0
	Outer Diameter 2 (mm)			
	Länge 1	42		
	Length 1 (mm)			
Bremsbackenrolle Brake Shoe Sleeve passend für to fit to Bergische Achse	Länge 2	78		03.070.0244.800 Vergl.-Nr. Comp.No 03.331.34.01.0
	Length 2 (mm)			
	Aussendurchmesser 1	22		
	Outer Diameter 1 (mm)			
Bremsbackenrolle Brake Shoe Sleeve passend für to fit to Bergische Achse	Aussendurchmesser 2	42		03.070.0246.890 Vergl.-Nr. Comp.No 05.331.44.02.0
	Outer Diameter 2 (mm)			
	Länge 1	22		
	Length 1 (mm)			
Bremsbackenrolle Brake Shoe Sleeve passend für to fit to Bergische Achse	Länge 2	59		
	Length 2 (mm)			
	Länge	33,5		
	Length (mm)			
Bremsbackenrolle Brake Shoe Sleeve passend für to fit to Bergische Achse	Aussendurchmesser	45		
	Outer Diameter (mm)			
	Innendurchmesser	26		
	Inner Diameter (mm)			

Bremsbackenrolle Brake Shoe Sleeve			
Bremsbackenrolle Brake Shoe Sleeve	Breite Width (mm)	28	 <p>03.070.0280.090</p> <p>Vergl.-Nr. Comp.No 667 965</p>
passend für to fit to DAF	Aussendurchmesser Outer Diameter (mm)	42	
	Innendurchmesser Inner Diameter (mm)	22	
Bremsbackenrolle Brake Shoe Sleeve	Breite Width (mm)	25	 <p>03.070.0281.000</p> <p>Vergl.-Nr. Comp.No 364 577</p>
passend für to fit to DAF	Aussendurchmesser Outer Diameter (mm)	42	
	Innendurchmesser Inner Diameter (mm)	19	
Bremsbackenrolle Brake Shoe Sleeve			 <p>03.070.0290.180</p> <p>Vergl.-Nr. Comp.No A-JA-0504-002</p>
passend für to fit to Frühauf			
Bremsbackenrolle Brake Shoe Sleeve	Länge Length (mm)	57	 <p>03.070.0661.000</p> <p>Vergl.-Nr. Comp.No 010.24.21.928.15</p>
passend für to fit to Kässbohrer	Aussendurchmesser 1 Outer Diameter 1 (mm)	20	
	Aussendurchmesser 2 Outer Diameter 2 (mm)	36	
Bremsbackenrolle Brake Shoe Sleeve	Breite Width (mm)	39	 <p>03.070.0941.000</p> <p>Vergl.-Nr. Comp.No 81.50213.6006</p>
passend für to fit to MAN	Aussendurchmesser Outer Diameter (mm)	52	
	Innendurchmesser Inner Diameter (mm)	20	
Stückliste Parts List			
1 x 03.070.0941.010 Buchse, Bremsbackenbolzen Bush, brake shoe pin			
1 x 20.010.0941.00R Bolzen, Bremsbackenrolle Pin, brake shoe sleeve			
Bremsbackenrolle Brake Shoe Sleeve	Breite Width (mm)	50	 <p>03.070.0983.000</p> <p>Vergl.-Nr. Comp.No 81.50213.6001</p>
passend für to fit to MAN	Aussendurchmesser Outer Diameter (mm)	35	
	Innendurchmesser Inner Diameter (mm)	16	
Bremsbackenrolle Brake Shoe Sleeve	Breite Width (mm)	39	 <p>03.070.1455.000</p> <p>Vergl.-Nr. Comp.No 81.50213.6013</p>
passend für to fit to MAN; Mercedes-Benz	Aussendurchmesser Outer Diameter (mm)	52	
	Innendurchmesser Inner Diameter (mm)	20	
Stückliste Parts List			
1 x 03.070.1455.090 Buchse, Bremsbackenbolzen Bush, brake shoe pin			
1 x 20.010.1455.00R Bolzen, Bremsbackenrolle Pin, brake shoe sleeve			

BG-03.070

Bremsbackenrolle Brake Shoe Sleeve





Bremsbackenrolle Brake Shoe Sleeve			
Bremsbackenrolle Brake Shoe Sleeve	Breite Width (mm)	40	 <p>03.070.2004.000</p> <p>Vergl.-Nr. Comp.No 1.265.0003.00</p>
passend für to fit to SAF	Aussendurchmesser Outer Diameter (mm)	42	
	Innendurchmesser Inner Diameter (mm)	21,5	
Bremsbackenrolle Brake Shoe Sleeve	Breite Width (mm)	57	 <p>03.070.2012.000</p> <p>Vergl.-Nr. Comp.No 1.265.0007.00</p>
passend für to fit to SAF	Aussendurchmesser Outer Diameter (mm)	32	
	Innendurchmesser Inner Diameter (mm)	19	
Bremsbackenrolle Brake Shoe Sleeve			 <p>03.070.2039.200</p> <p>Vergl.-Nr. Comp.No 1.265.0019.00</p>
passend für to fit to SAF			
Bremsbackenrolle Brake Shoe Sleeve	Breite Width (mm)	28	 <p>03.070.3000.370</p> <p>Vergl.-Nr. Comp.No 154 259 S</p>
passend für to fit to Scania	Aussendurchmesser Outer Diameter (mm)	60	
	Innendurchmesser Inner Diameter (mm)	25	
Bremsbackenrolle Brake Shoe Sleeve	Breite Width (mm)	28	 <p>03.070.3004.530</p> <p>Vergl.-Nr. Comp.No 154 259</p>
passend für to fit to Scania	Aussendurchmesser Outer Diameter (mm)	60	
	Innendurchmesser Inner Diameter (mm)	25	
Bremsbackenrolle Brake Shoe Sleeve	Breite Width (mm)	32	 <p>03.070.4000.700</p> <p>Vergl.-Nr. Comp.No 0341 717-7</p>
passend für to fit to Volvo	Aussendurchmesser Outer Diameter (mm)	48	
	Innendurchmesser Inner Diameter (mm)	25,2	
Stückliste Parts List			
1 x 03.070.4000.710 Bremsbackenrolle Brake Shoe Sleeve			
1 x 03.070.4000.720 Buchse, Bremsbackenbolzen Bush, brake shoe pin			
Bremsbackenrolle Brake Shoe Sleeve	Breite Width (mm)	32	 <p>03.070.4000.710</p> <p>Vergl.-Nr. Comp.No 0348 979-6</p>
passend für to fit to Volvo	Aussendurchmesser Outer Diameter (mm)	48	
	Innendurchmesser Inner Diameter (mm)	25,2	

Bremsbackenrolle | Brake Shoe Sleeve

Bremsbackenrolle	Aussendurchmesser 1	19		03.070.4200.080
Brake Shoe Sleeve	Outer Diameter 1 (mm)			Vergl.-Nr. Comp.No
	Aussendurchmesser 2	32		210 06 610
passend für to fit to	Outer Diameter 2 (mm)			
ROR	Länge 1	34		
	Length 1 (mm)			
	Länge 2	57		
	Length 2 (mm)			

Reparatursatz, Bremsbackenlagerung | Repair Kit, brake shoe mounting

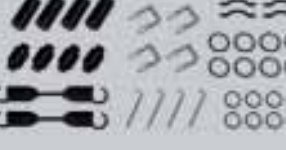
Reparatursatz, Bremsbackenlagerung				03.070.0290.500
Repair Kit, brake shoe mounting				Vergl.-Nr. Comp.No
passend für to fit to				AJA-0507-001
Frühauf				
Stückliste Parts List				
2 x 03.070.0290.150	Buchse, Bremsbackenbolzen Bush, brake shoe pin			
2 x 03.070.0290.170	Bolzen, Bremsbackenrolle Pin, brake shoe sleeve			
2 x 03.070.0290.560	Federhaltestift, Bremsbacke Spring Retaining Pin, brake shoe			
2 x 03.070.2012.000	Bremsbackenrolle Brake Shoe Sleeve			
2 x 03.070.2221.600	Federhaltestift, Bremsbacke Spring Retaining Pin, brake shoe			
2 x 03.070.4200.710	Halteblech, Bremsbackenbolzen Retaining Plate, brake shoe pins			
1 x 03.080.3504.020	Feder, Bremsbacken Spring, brake shoe			
Reparatursatz, Bremsbackenlagerung				03.070.2023.S00
Repair Kit, brake shoe mounting				Vergl.-Nr. Comp.No
passend für to fit to				3.434.3602.00
SAF				
Stückliste Parts List				
4 x 03.070.2012.000	Bremsbackenrolle Brake Shoe Sleeve			
4 x 03.070.2023.000	Bolzen, Bremsbackenrolle Pin, brake shoe sleeve			
8 x 03.070.2030.000	Unterlegscheibe Washer			
8 x 03.070.2051.000	Halteblech, Bremsbackenbolzen Retaining Plate, brake shoe pins			
8 x 03.070.2065.000	Schraube Screw / Bolt			
2 x 03.070.2221.100	Dichtung Seal / Gasket			
4 x 03.080.2035.000	Feder, Bremsbacken Spring, brake shoe			
8 x 04.120.1716.000	Sicherungsring Circlip			
8 x 18.060.2064.000	Mutter Nut			
2 x 18.080.1365.000	Prüfstraße Inspection Lane			
Reparatursatz, Bremsbackenlagerung				03.070.3504.2 S
Repair Kit, brake shoe mounting				Vergl.-Nr. Comp.No
passend für to fit to				6502102W
Trailor				
Reparatursatz, Bremsbackenlagerung				03.070.3504.4 S
Repair Kit, brake shoe mounting				Vergl.-Nr. Comp.No
passend für to fit to				6504775W 1/2
Trailor				

BG-03.070

Reparatursatz, Bremsbackenlagerung Repair Kit, brake shoe mounting



Reparatursatz, Bremsbackenlagerung Repair Kit, brake shoe mounting			
Reparatursatz, Bremsbackenlagerung Repair Kit, brake shoe mounting			03.070.3504.420 Vergl.-Nr. Comp.No 6502102W 1/2
passend für to fit to Trailer			
Reparatursatz, Bremsbackenlagerung Repair Kit, brake shoe mounting			03.070.3504.6 S Vergl.-Nr. Comp.No M009279/2
passend für to fit to Trailer			
Reparatursatz, Bremsbackenlagerung Repair Kit, brake shoe mounting			03.070.4200.260 Vergl.-Nr. Comp.No AXL 126
passend für to fit to ROR			
Stückliste Parts List 2 x 03.070.2221.600 Federhaltestift, Bremsbacke Spring Retaining Pin, brake shoe 2 x 03.070.4200.080 Bremsbackenrolle Brake Shoe Sleeve 2 x 03.070.4200.28S Bremsbackenrolle Brake Shoe Sleeve 2 x 03.070.4200.290 Buchse, Bremsbackenbolzen Bush, brake shoe pin 2 x 03.070.4200.710 Halteblech, Bremsbackenbolzen Retaining Plate, brake shoe pins 1 x 03.080.4200.140 Feder, Bremsbacken Spring, brake shoe 2 x 03.080.4200.580 Feder, Bremsbacken Spring, brake shoe			

Warnkontakt, Bremsbelagverschleiß Alarm Sensor, brake lining wear			
Warnkontakt, Bremsbelagverschleiß Alarm Sensor, brake lining wear	Länge Length (mm)	260	
passend für to fit to Mercedes-Benz			03.070.1935.080 Vergl.-Nr. Comp.No 670 540 00 17
Warnkontakt, Bremsbelagverschleiß Alarm Sensor, brake lining wear	Länge Length (mm)	205	
passend für to fit to Mercedes-Benz			03.070.1935.090 Vergl.-Nr. Comp.No 601 540 06 17

Dichtung | Gasket / Seal

Dichtung	Aussendurchmesser	160		03.070.2221.100
Seal / Gasket	Outer Diameter (mm)			
	Innendurchmesser	120		
	Inner Diameter (mm)			
passend für to fit to	Dicke/Stärke	0,3		Vergl.-Nr. Comp.No
SAF	Thickness (mm)			1.093.0005.00

Sicherungsring | Circlip

Sicherungsring	Innendurchmesser	24		03.070.0242.550
Circlip	Inner Diameter (mm)			
	Dicke/Stärke	1,2		
	Thickness (mm)			
passend für to fit to	DIN/ISO	471		Vergl.-Nr. Comp.No
Bergische Achse	DIN / ISO			02.5603.24.90
	Form	A-Form		
	Shape	A-shape		

Sicherungsring	Innendurchmesser	17		03.070.1455.020
Circlip	Inner Diameter (mm)			
	Dicke/Stärke	1		
	Thickness (mm)			
passend für to fit to	DIN/ISO	471		Vergl.-Nr. Comp.No
Mercedes-Benz	DIN / ISO			000471 017000
	Form	A-Form		
	Shape	A-shape		

Sicherungsring	Innendurchmesser	12		03.070.1455.100
Circlip	Inner Diameter (mm)			
	Dicke/Stärke	1		
	Thickness (mm)			
passend für to fit to	DIN/ISO	471		Vergl.-Nr. Comp.No
Mercedes-Benz	DIN / ISO			000471 012001
	Form	A-Form		
	Shape	A-shape		

Dichtring | Seal Ring

Dichtring	Innendurchmesser	21		03.070.0242.610
Seal Ring	Inner Diameter (mm)			
	Dicke/Stärke	2		
	Thickness (mm)			
passend für to fit to				Vergl.-Nr. Comp.No
Bergische Achse				02.5677.21.00

BG-03.070

Dichtring Sealing Ring









Dichtring Sealing Ring				
Dichtring Seal Ring passend für to fit to Mercedes-Benz	Innendurchmesser Inner Diameter (mm)	20		03.070.1455.080 Vergl.-Nr. Comp.No 003 997 15 48
	Dicke/Stärke Thickness (mm)	3		
	Farbe Colour	grün Green		
	Material	FPM/ACM (Viton/Polyacryl-Kautschuk)		
	Material	FPM / ACM (Viton / Polyachryle-Rubber)		
Dichtring Seal Ring passend für to fit to Mercedes-Benz	Innendurchmesser Inner Diameter (mm)	30		03.070.1457.020 Vergl.-Nr. Comp.No 302 997 04 45
	Dicke/Stärke Thickness (mm)	3		
Dichtring Seal Ring passend für to fit to Mercedes-Benz	Innendurchmesser Inner Diameter (mm)	30		03.070.1457.030 Vergl.-Nr. Comp.No 003 997 69 48
	Dicke/Stärke Thickness (mm)	4		
	Farbe Colour	schwarz Black		
Dichtring Seal Ring passend für to fit to Mercedes-Benz	Innendurchmesser Inner Diameter (mm)	28		03.070.1920.030 Vergl.-Nr. Comp.No 011 997 04 48
	Dicke/Stärke Thickness (mm)	4		
Dichtring Seal Ring passend für to fit to Mercedes-Benz	Innendurchmesser Inner Diameter (mm)	30		03.070.1930.020 Vergl.-Nr. Comp.No 001 997 70 48
	Dicke/Stärke Thickness (mm)	4,5		
	Farbe Colour	grün Green		
	Material	FPM/ACM (Viton/Polyacryl-Kautschuk)		
	Material	FPM / ACM (Viton / Polyachryle-Rubber)		
Dichtring Seal Ring passend für to fit to ROR	Innendurchmesser Inner Diameter (mm)	28		03.070.4200.470 Vergl.-Nr. Comp.No 212 20 668
	Dicke/Stärke Thickness (mm)	1,8		
	Material	MVQ (Silikon-Kautschuk)		
	Material	MVQ (Silicon-Rubber)		

Sicherungsclip | Circlip

<p>Sicherungsclip Circlip</p> <p>passend für to fit to Bergische Achse</p>		<p>03.070.0242.910</p> <p>Vergl.-Nr. Comp.No 03.350.00.13.0</p>
<p>Sicherungsclip Circlip</p> <p>passend für to fit to Bergische Achse</p>		<p>03.070.0247.830</p> <p>Vergl.-Nr. Comp.No 03.350.00.14.0</p>







Federhaltestift, Bremsbacke | Spring Retaining Pin, brake shoe

<p>Federhaltestift, Bremsbacke Spring Retaining Pin, brake shoe</p> <p>passend für to fit to Bergische Achse</p>	<table border="1"> <tr> <td>Länge</td> <td>100</td> </tr> <tr> <td>Length (mm)</td> <td></td> </tr> <tr> <td>Aussendurchmesser</td> <td>14</td> </tr> <tr> <td>Outer Diameter (mm)</td> <td></td> </tr> </table>	Länge	100	Length (mm)		Aussendurchmesser	14	Outer Diameter (mm)			<p>03.070.0240.190</p> <p>Vergl.-Nr. Comp.No 03.084.52.06.0</p>
Länge	100										
Length (mm)											
Aussendurchmesser	14										
Outer Diameter (mm)											
<p>Federhaltestift, Bremsbacke Spring Retaining Pin, brake shoe</p> <p>passend für to fit to Frühhauf</p>			<p>03.070.0290.560</p> <p>Vergl.-Nr. Comp.No</p>								
<p>Federhaltestift, Bremsbacke Spring Retaining Pin, brake shoe</p> <p>passend für to fit to Mercedes-Benz</p>	<table border="1"> <tr> <td>Länge</td> <td>95</td> </tr> <tr> <td>Length (mm)</td> <td></td> </tr> <tr> <td>Aussendurchmesser</td> <td>12</td> </tr> <tr> <td>Outer Diameter (mm)</td> <td></td> </tr> </table>	Länge	95	Length (mm)		Aussendurchmesser	12	Outer Diameter (mm)			<p>03.070.1905.910</p> <p>Vergl.-Nr. Comp.No 387 421 00 74</p>
Länge	95										
Length (mm)											
Aussendurchmesser	12										
Outer Diameter (mm)											
<p>Federhaltestift, Bremsbacke Spring Retaining Pin, brake shoe</p> <p>passend für to fit to Mercedes-Benz</p>	<table border="1"> <tr> <td>Länge</td> <td>72</td> </tr> <tr> <td>Length (mm)</td> <td></td> </tr> <tr> <td>Aussendurchmesser</td> <td>12</td> </tr> <tr> <td>Outer Diameter (mm)</td> <td></td> </tr> </table>	Länge	72	Length (mm)		Aussendurchmesser	12	Outer Diameter (mm)			<p>03.070.1905.920</p> <p>Vergl.-Nr. Comp.No 945 421 00 74</p>
Länge	72										
Length (mm)											
Aussendurchmesser	12										
Outer Diameter (mm)											
<p>Federhaltestift, Bremsbacke Spring Retaining Pin, brake shoe</p> <p>passend für to fit to SAF</p>			<p>03.070.2068.000</p> <p>Vergl.-Nr. Comp.No 1.395.1005.00</p>								
<p>Federhaltestift, Bremsbacke Spring Retaining Pin, brake shoe</p> <p>passend für to fit to Frühhauf; ROR; SAF</p>			<p>03.070.2221.600</p> <p>Vergl.-Nr. Comp.No 1.395.1001.00</p>								





BG-03.070

Federhaltestift, Bremsbacke Spring Retaining Pin, brake shoe



Federhaltestift, Bremsbacke Spring Retaining Pin, brake shoe										
Federhaltestift, Bremsbacke Spring Retaining Pin, brake shoe passend für to fit to Frühhauf; ROR; SAF		 <p>03.070.2221.700</p> Vergl.-Nr. Comp.No 1.395.1013.00								
Federhaltestift, Bremsbacke Spring Retaining Pin, brake shoe passend für to fit to Bergische Achse	<table border="1"> <tr> <td>Länge</td> <td>90</td> </tr> <tr> <td>Length (mm)</td> <td></td> </tr> <tr> <td>Aussendurchmesser</td> <td>12</td> </tr> <tr> <td>Outer Diameter (mm)</td> <td></td> </tr> </table>	Länge	90	Length (mm)		Aussendurchmesser	12	Outer Diameter (mm)		 <p>03.100.0240.100</p> Vergl.-Nr. Comp.No 03.001.08.05.0
Länge	90									
Length (mm)										
Aussendurchmesser	12									
Outer Diameter (mm)										
Federhaltestift, Bremsbacke Spring Retaining Pin, brake shoe passend für to fit to Bergische Achse	<table border="1"> <tr> <td>Länge</td> <td>120</td> </tr> <tr> <td>Length (mm)</td> <td></td> </tr> <tr> <td>Aussendurchmesser</td> <td>12</td> </tr> <tr> <td>Outer Diameter (mm)</td> <td></td> </tr> </table>	Länge	120	Length (mm)		Aussendurchmesser	12	Outer Diameter (mm)		 <p>03.100.0240.180</p> Vergl.-Nr. Comp.No 03.084.42.02.0
Länge	120									
Length (mm)										
Aussendurchmesser	12									
Outer Diameter (mm)										
Federhaltestift, Bremsbacke Spring Retaining Pin, brake shoe passend für to fit to Bergische Achse		 <p>03.100.0243.580</p> Vergl.-Nr. Comp.No 03.001.08.03.0								
Federhaltestift, Bremsbacke Spring Retaining Pin, brake shoe passend für to fit to Bergische Achse		 <p>03.100.0244.330</p> Vergl.-Nr. Comp.No 02.6010.25.60								
Federhaltestift, Bremsbacke Spring Retaining Pin, brake shoe passend für to fit to Bergische Achse		 <p>03.100.0244.341</p> Vergl.-Nr. Comp.No 02.6010.35.60								

Bolzen, Bremsbackenrolle | Pin, brake shoe sleeve

Bolzen, Bremsbackenrolle Pin, brake shoe sleeve passend für to fit to Bergische Achse	<table border="1"> <tr><td>Länge</td><td>157</td></tr> <tr><td>Length (mm)</td><td></td></tr> <tr><td>Aussendurchmesser</td><td>36</td></tr> <tr><td>Outer Diameter (mm)</td><td></td></tr> <tr><td>Ergänzungsartikel / Ergänzende Info</td><td>verchromt</td></tr> <tr><td>Supplementary Article/Supplementary Info</td><td>Chromed</td></tr> </table>	Länge	157	Length (mm)		Aussendurchmesser	36	Outer Diameter (mm)		Ergänzungsartikel / Ergänzende Info	verchromt	Supplementary Article/Supplementary Info	Chromed		03.070.0203.000 Vergl.-Nr. Comp.No 09.084.46.11.0
Länge	157														
Length (mm)															
Aussendurchmesser	36														
Outer Diameter (mm)															
Ergänzungsartikel / Ergänzende Info	verchromt														
Supplementary Article/Supplementary Info	Chromed														
Stückliste Parts List 1 x 03.070.0202.000 Bolzen, Bremsbackenrolle Pin, brake shoe sleeve 1 x 03.070.0205.000 Schraube Screw / Bolt 1 x 04.100.1494.000 Federring Springwasher 1 x 18.080.0229.000 Schmiernippel Grease Nipple															
Bolzen, Bremsbackenrolle Pin, brake shoe sleeve passend für to fit to Bergische Achse	<table border="1"> <tr><td>Länge</td><td>67</td></tr> <tr><td>Length (mm)</td><td></td></tr> <tr><td>Aussendurchmesser</td><td>24</td></tr> <tr><td>Outer Diameter (mm)</td><td></td></tr> </table>	Länge	67	Length (mm)		Aussendurchmesser	24	Outer Diameter (mm)			03.070.0206.000 Vergl.-Nr. Comp.No 03.084.54.02.0				
Länge	67														
Length (mm)															
Aussendurchmesser	24														
Outer Diameter (mm)															
Bolzen, Bremsbackenrolle Pin, brake shoe sleeve passend für to fit to Bergische Achse	<table border="1"> <tr><td>Länge</td><td>157</td></tr> <tr><td>Length (mm)</td><td></td></tr> <tr><td>Aussendurchmesser</td><td>36</td></tr> <tr><td>Outer Diameter (mm)</td><td></td></tr> <tr><td>Ergänzungsartikel / Ergänzende Info</td><td>verchromt</td></tr> <tr><td>Supplementary Article/Supplementary Info</td><td>Chromed</td></tr> </table>	Länge	157	Length (mm)		Aussendurchmesser	36	Outer Diameter (mm)		Ergänzungsartikel / Ergänzende Info	verchromt	Supplementary Article/Supplementary Info	Chromed		03.070.0230.000 Vergl.-Nr. Comp.No 03.084.46.05.0
Länge	157														
Length (mm)															
Aussendurchmesser	36														
Outer Diameter (mm)															
Ergänzungsartikel / Ergänzende Info	verchromt														
Supplementary Article/Supplementary Info	Chromed														
Bolzen, Bremsbackenrolle Pin, brake shoe sleeve passend für to fit to Bergische Achse	<table border="1"> <tr><td>Länge</td><td>147</td></tr> <tr><td>Length (mm)</td><td></td></tr> <tr><td>Aussendurchmesser</td><td>36</td></tr> <tr><td>Outer Diameter (mm)</td><td></td></tr> <tr><td>Ergänzungsartikel / Ergänzende Info</td><td>verchromt</td></tr> <tr><td>Supplementary Article/Supplementary Info</td><td>Chromed</td></tr> </table>	Länge	147	Length (mm)		Aussendurchmesser	36	Outer Diameter (mm)		Ergänzungsartikel / Ergänzende Info	verchromt	Supplementary Article/Supplementary Info	Chromed		03.070.0230.010 Vergl.-Nr. Comp.No 03.084.46.05.0
Länge	147														
Length (mm)															
Aussendurchmesser	36														
Outer Diameter (mm)															
Ergänzungsartikel / Ergänzende Info	verchromt														
Supplementary Article/Supplementary Info	Chromed														
Bolzen, Bremsbackenrolle Pin, brake shoe sleeve passend für to fit to Bergische Achse	<table border="1"> <tr><td>Länge</td><td>147</td></tr> <tr><td>Length (mm)</td><td></td></tr> <tr><td>Aussendurchmesser</td><td>36</td></tr> <tr><td>Outer Diameter (mm)</td><td></td></tr> <tr><td>Ergänzungsartikel / Ergänzende Info</td><td>gehärtet</td></tr> <tr><td>Supplementary Article/Supplementary Info</td><td>Hardened</td></tr> </table>	Länge	147	Length (mm)		Aussendurchmesser	36	Outer Diameter (mm)		Ergänzungsartikel / Ergänzende Info	gehärtet	Supplementary Article/Supplementary Info	Hardened		03.070.0231.000 Vergl.-Nr. Comp.No 09.084.46.12.0
Länge	147														
Length (mm)															
Aussendurchmesser	36														
Outer Diameter (mm)															
Ergänzungsartikel / Ergänzende Info	gehärtet														
Supplementary Article/Supplementary Info	Hardened														
Stückliste Parts List 1 x 03.070.0205.000 Schraube Screw / Bolt 1 x 03.070.0230.000 Bolzen, Bremsbackenrolle Pin, brake shoe sleeve 1 x 04.100.1494.000 Federring Springwasher 1 x 18.080.0229.000 Schmiernippel Grease Nipple															

BG-03.070

Bolzen, Bremsbackenrolle Pin, brake shoe sleeve



Bolzen, Bremsbackenrolle | Pin, brake shoe sleeve

<p>Bolzen, Bremsbackenrolle Pin, brake shoe sleeve</p> <p>passend für to fit to Bergische Achse</p>	<table border="1"> <tr><td>Länge</td><td>147</td></tr> <tr><td>Length (mm)</td><td></td></tr> <tr><td>Aussendurchmesser</td><td>36</td></tr> <tr><td>Outer Diameter (mm)</td><td></td></tr> <tr><td>Ergänzungsartikel / Ergänzende Info</td><td>verchromt</td></tr> <tr><td>Supplementary Article/Supplementary Info</td><td>Chromed</td></tr> </table>	Länge	147	Length (mm)		Aussendurchmesser	36	Outer Diameter (mm)		Ergänzungsartikel / Ergänzende Info	verchromt	Supplementary Article/Supplementary Info	Chromed		<p>03.070.0232.000</p> <p>Vergl.-Nr. Comp.No 03.084.66.15.0</p>
Länge	147														
Length (mm)															
Aussendurchmesser	36														
Outer Diameter (mm)															
Ergänzungsartikel / Ergänzende Info	verchromt														
Supplementary Article/Supplementary Info	Chromed														
<p>Bolzen, Bremsbackenrolle Pin, brake shoe sleeve</p> <p>passend für to fit to Bergische Achse</p> <p>Stückliste Parts List 1 x 03.070.0227.000 Schraube Screw / Bolt 1 x 03.070.0232.000 Bolzen, Bremsbackenrolle Pin, brake shoe sleeve</p>	<table border="1"> <tr><td>Länge</td><td>122</td></tr> <tr><td>Length (mm)</td><td></td></tr> <tr><td>Aussendurchmesser</td><td>36</td></tr> <tr><td>Outer Diameter (mm)</td><td></td></tr> <tr><td>Ergänzungsartikel / Ergänzende Info</td><td>verchromt</td></tr> <tr><td>Supplementary Article/Supplementary Info</td><td>Chromed</td></tr> </table>	Länge	122	Length (mm)		Aussendurchmesser	36	Outer Diameter (mm)		Ergänzungsartikel / Ergänzende Info	verchromt	Supplementary Article/Supplementary Info	Chromed		<p>03.070.0233.000</p> <p>Vergl.-Nr. Comp.No 09.084.66.02.0</p>
Länge	122														
Length (mm)															
Aussendurchmesser	36														
Outer Diameter (mm)															
Ergänzungsartikel / Ergänzende Info	verchromt														
Supplementary Article/Supplementary Info	Chromed														
<p>Bolzen, Bremsbackenrolle Pin, brake shoe sleeve</p> <p>passend für to fit to Bergische Achse</p>	<table border="1"> <tr><td>Länge</td><td>156</td></tr> <tr><td>Length (mm)</td><td></td></tr> <tr><td>Aussendurchmesser 1</td><td>28</td></tr> <tr><td>Outer Diameter 1 (mm)</td><td></td></tr> <tr><td>Aussendurchmesser 2</td><td>32</td></tr> <tr><td>Outer Diameter 2 (mm)</td><td></td></tr> </table>	Länge	156	Length (mm)		Aussendurchmesser 1	28	Outer Diameter 1 (mm)		Aussendurchmesser 2	32	Outer Diameter 2 (mm)			<p>03.070.0234.010</p> <p>Vergl.-Nr. Comp.No 03.177.23.09.0</p>
Länge	156														
Length (mm)															
Aussendurchmesser 1	28														
Outer Diameter 1 (mm)															
Aussendurchmesser 2	32														
Outer Diameter 2 (mm)															
<p>Bolzen, Bremsbackenrolle Pin, brake shoe sleeve</p> <p>passend für to fit to Bergische Achse</p> <p>Stückliste Parts List 1 x 03.070.0234.010 Bolzen, Bremsbackenrolle Pin, brake shoe sleeve 1 x 11.012.0240.850 Limesring, Felge Retaining Ring, wheel rim 1 x 18.060.1729.000 Mutter Nut</p>			<p>03.070.0234.020</p> <p>Vergl.-Nr. Comp.No 09.177.23.09.0</p>												
<p>Bolzen, Bremsbackenrolle Pin, brake shoe sleeve</p> <p>passend für to fit to Bergische Achse</p>	<table border="1"> <tr><td>Länge</td><td>80</td></tr> <tr><td>Length (mm)</td><td></td></tr> <tr><td>Aussendurchmesser</td><td>24</td></tr> <tr><td>Outer Diameter (mm)</td><td></td></tr> </table>	Länge	80	Length (mm)		Aussendurchmesser	24	Outer Diameter (mm)			<p>03.070.0238.000</p> <p>Vergl.-Nr. Comp.No 03.084.54.01.0</p>				
Länge	80														
Length (mm)															
Aussendurchmesser	24														
Outer Diameter (mm)															
<p>Bolzen, Bremsbackenrolle Pin, brake shoe sleeve</p> <p>passend für to fit to Bergische Achse</p>	<table border="1"> <tr><td>Länge</td><td>77</td></tr> <tr><td>Length (mm)</td><td></td></tr> <tr><td>Aussendurchmesser</td><td>25</td></tr> <tr><td>Outer Diameter (mm)</td><td></td></tr> </table>	Länge	77	Length (mm)		Aussendurchmesser	25	Outer Diameter (mm)			<p>03.070.0239.000</p> <p>Vergl.-Nr. Comp.No 03.084.55.11.0</p>				
Länge	77														
Length (mm)															
Aussendurchmesser	25														
Outer Diameter (mm)															

Bolzen, Bremsbackenrolle Pin, brake shoe sleeve			
Bolzen, Bremsbackenrolle Pin, brake shoe sleeve passend für to fit to Bergische Achse	Länge	155	 03.070.0242.860 Vergl.-Nr. Comp.No 03.084.46.22.0
	Length (mm)		
	Aussendurchmesser 1	28	
	Outer Diameter 1 (mm)		
Bolzen, Bremsbackenrolle Pin, brake shoe sleeve passend für to fit to Bergische Achse Stückliste Parts List 1 x 03.070.0242.860 Bolzen, Bremsbackenrolle Pin, brake shoe sleeve 1 x 03.070.0245.920 Halteblech, Bremsbackenbolzen Retaining Plate, brake shoe pins	Länge	140	 03.070.0242.861 Vergl.-Nr. Comp.No 09.084.46.36.0
	Length (mm)		
	Aussendurchmesser	36	
	Outer Diameter (mm)		
Bolzen, Bremsbackenrolle Pin, brake shoe sleeve passend für to fit to Bergische Achse	Länge	135	 03.070.0246.900 Vergl.-Nr. Comp.No 03.084.75.24.0
	Length (mm)		
	Aussendurchmesser	36	
	Outer Diameter (mm)		
Bolzen, Bremsbackenrolle Pin, brake shoe sleeve passend für to fit to DAF	Länge	95	 03.070.0280.000 Vergl.-Nr. Comp.No 145 450
	Length (mm)		
	Aussendurchmesser	31,7	
	Outer Diameter (mm)		
Bolzen, Bremsbackenrolle Pin, brake shoe sleeve passend für to fit to DAF	Länge	100,36	 03.070.0280.020 Vergl.-Nr. Comp.No 290 377
	Length (mm)		
	Aussendurchmesser	31,87	
	Outer Diameter (mm)		
Bolzen, Bremsbackenrolle Pin, brake shoe sleeve passend für to fit to Frühaufr	Länge	130	 03.070.0290.170 Vergl.-Nr. Comp.No A-JA-0507-001
	Length (mm)		
	Aussendurchmesser	30	
	Outer Diameter (mm)		
Bolzen, Bremsbackenrolle Pin, brake shoe sleeve passend für to fit to Kässbohrer	Länge	148	 03.070.0615.010 Vergl.-Nr. Comp.No 6.125.451.102
	Length (mm)		
	Aussendurchmesser	30	
	Outer Diameter (mm)		
Bolzen, Bremsbackenrolle Pin, brake shoe sleeve passend für to fit to Kässbohrer	Länge	148	 03.070.0616.000 Vergl.-Nr. Comp.No 6.125.451.103
	Length (mm)		
	Aussendurchmesser	30	
	Outer Diameter (mm)		

BG-03.070

Bolzen, Bremsbackenrolle Pin, brake shoe sleeve



Bolzen, Bremsbackenrolle Pin, brake shoe sleeve				
Bolzen, Bremsbackenrolle Pin, brake shoe sleeve	Länge	150		03.070.0633.000
	Aussendurchmesser	30		
passend für to fit to Kässbohrer	Outer Diameter (mm)			Vergl.-Nr. Comp.No 010.24.21.939.31
Bolzen, Bremsbackenrolle Pin, brake shoe sleeve	Länge	150		03.070.0634.000
	Aussendurchmesser	30		
passend für to fit to Kässbohrer	Outer Diameter (mm)			Vergl.-Nr. Comp.No 010.24.21.939.21
Bolzen, Bremsbackenrolle Pin, brake shoe sleeve	Länge	150		03.070.0634.010
	Aussendurchmesser	30		
passend für to fit to Kässbohrer	Outer Diameter (mm)			Vergl.-Nr. Comp.No 015.26.21.115.40
Bolzen, Bremsbackenrolle Pin, brake shoe sleeve	Länge	173		03.070.0646.000
	Aussendurchmesser	30		
passend für to fit to Kässbohrer	Outer Diameter (mm)			Vergl.-Nr. Comp.No 418.16.21.111.15
Bolzen, Bremsbackenrolle Pin, brake shoe sleeve	Länge	79,5		03.070.0982.000
	Aussendurchmesser	16		
passend für to fit to MAN	Outer Diameter (mm)			Vergl.-Nr. Comp.No 81.50212.0027
Bolzen, Bremsbackenrolle Pin, brake shoe sleeve	Länge	164		03.070.0991.000
	Aussendurchmesser 1	24		
passend für to fit to MAN	Outer Diameter 1 (mm)			Vergl.-Nr. Comp.No 81.50212.0019
Bolzen, Bremsbackenrolle Pin, brake shoe sleeve	Länge	163		03.070.1450.010
	Aussendurchmesser 1	24		
passend für to fit to Mercedes-Benz	Outer Diameter 1 (mm)			Vergl.-Nr. Comp.No 366 423 00 18
	Aussendurchmesser 2	30		
	Outer Diameter 2 (mm)			
	Ergänzungsartikel / Ergänzende Info	verchromt		
	Supplementary Article/Supplementary Info	Chromed		

Bolzen, Bremsbackenrolle Pin, brake shoe sleeve					
Bolzen, Bremsbackenrolle Pin, brake shoe sleeve passend für to fit to Mercedes-Benz	Länge	233		03.070.1452.000 Vergl.-Nr. Comp.No 335 421 02 18	
	Length (mm)				
	Aussendurchmesser 1	30			
	Outer Diameter 1 (mm)				
	Aussendurchmesser 2	32			
	Outer Diameter 2 (mm)				
	Ergänzungsartikel / Ergän- zende Info	verchromt			
	Supplementary Article/Sup- plementary Info	Chromed			
Bolzen, Bremsbackenrolle Pin, brake shoe sleeve passend für to fit to Mercedes-Benz	Länge	89,5		03.070.1454.000 Vergl.-Nr. Comp.No 335 421 00 74	
	Length (mm)				
	Aussendurchmesser	19,7			
	Outer Diameter (mm)				
	Ergänzungsartikel / Ergän- zende Info	verchromt			
	Supplementary Article/Sup- plementary Info	Chromed			
	Bolzen, Bremsbackenrolle Pin, brake shoe sleeve passend für to fit to Mercedes-Benz	Länge	73		03.070.1455.060 Vergl.-Nr. Comp.No 307 421 00 74
		Length (mm)			
Aussendurchmesser		20			
Outer Diameter (mm)					
Bolzen, Bremsbackenrolle Pin, brake shoe sleeve passend für to fit to Mercedes-Benz	Länge	102		03.070.1456.000 Vergl.-Nr. Comp.No 497 421 00 74	
	Length (mm)				
	Aussendurchmesser	30			
	Outer Diameter (mm)				
	Ergänzungsartikel / Ergän- zende Info	verchromt			
	Supplementary Article/Sup- plementary Info	Chromed			
	Bolzen, Bremsbackenrolle Pin, brake shoe sleeve passend für to fit to Mercedes-Benz	Länge	94		03.070.1457.000 Vergl.-Nr. Comp.No 302 421 10 74
		Length (mm)			
Aussendurchmesser		30			
Outer Diameter (mm)					
Bolzen, Bremsbackenrolle Pin, brake shoe sleeve passend für to fit to Mercedes-Benz	Länge	35		03.070.1462.010 Vergl.-Nr. Comp.No 302 421 01 74	
	Length (mm)				
	Aussendurchmesser	25			
	Outer Diameter (mm)				
Bolzen, Bremsbackenrolle Pin, brake shoe sleeve passend für to fit to Mercedes-Benz	Länge	94		03.070.1464.060 Vergl.-Nr. Comp.No 302 421 09 74	
	Length (mm)				
	Aussendurchmesser	36			
	Outer Diameter (mm)				

BG-03.070

Bolzen, Bremsbackenrolle Pin, brake shoe sleeve





Bolzen, Bremsbackenrolle Pin, brake shoe sleeve			
Bolzen, Bremsbackenrolle Pin, brake shoe sleeve passend für to fit to Mercedes-Benz	Länge Length (mm)	82	 03.070.1920.010 Vergl.-Nr. Comp.No 318 421 01 74
	Aussendurchmesser 1 Outer Diameter 1 (mm)	25	
	Aussendurchmesser 2 Outer Diameter 2 (mm)	28	
Bolzen, Bremsbackenrolle Pin, brake shoe sleeve passend für to fit to SAF	Länge Length (mm)	182	 03.070.2000.000 Vergl.-Nr. Comp.No 1.214.0004.06
	Aussendurchmesser Outer Diameter (mm)	32	
Bolzen, Bremsbackenrolle Pin, brake shoe sleeve passend für to fit to SAF	Länge Length (mm)	86,6	 03.070.2022.000 Vergl.-Nr. Comp.No 1.214.0022.01
	Aussendurchmesser Outer Diameter (mm)	31,7	
Bolzen, Bremsbackenrolle Pin, brake shoe sleeve passend für to fit to SAF	Länge Length (mm)	72,5	 03.070.2023.000 Vergl.-Nr. Comp.No 1.214.0023.02
	Aussendurchmesser Outer Diameter (mm)	31,7	
Bolzen, Bremsbackenrolle Pin, brake shoe sleeve passend für to fit to SAF	Länge Length (mm)	72,5	 03.070.2023.100 Vergl.-Nr. Comp.No 1.214.0023.01
	Aussendurchmesser Outer Diameter (mm)	31,7	
Bolzen, Bremsbackenrolle Pin, brake shoe sleeve passend für to fit to Scania	Länge Length (mm)	118	 03.070.3000.310 Vergl.-Nr. Comp.No 183 924
	Aussendurchmesser Outer Diameter (mm)	31,4	
Bolzen, Bremsbackenrolle Pin, brake shoe sleeve passend für to fit to Scania	Länge Length (mm)	133	 03.070.3000.320 Vergl.-Nr. Comp.No 180 064
	Aussendurchmesser Outer Diameter (mm)	31,25	
Bolzen, Bremsbackenrolle Pin, brake shoe sleeve passend für to fit to Trailer			 03.070.3504.220 Vergl.-Nr. Comp.No 1 652 010R

Bolzen, Bremsbackenrolle | Pin, brake shoe sleeve

Bolzen, Bremsbackenrolle Pin, brake shoe sleeve			03.070.3504.410 Vergl.-Nr. Comp.No 6502382B
passend für to fit to Trailor			
Bolzen, Bremsbackenrolle Pin, brake shoe sleeve			03.070.4000.550 Vergl.-Nr. Comp.No 1584 673-6
Länge Length (mm)	86,5		passend für to fit to Volvo
Bolzen, Bremsbackenrolle Pin, brake shoe sleeve			03.070.4000.560 Vergl.-Nr. Comp.No 1586 716-1
Länge Length (mm)	116		passend für to fit to Volvo
			Aussendurchmesser 1 Outer Diameter 1 (mm)
			Aussendurchmesser 2 Outer Diameter 2 (mm)

Reparatursatz, Bremsbackenrolle | Repair Kit, brake shoe sleeve

Reparatursatz, Bremsbackenrolle Repair Kit, brake shoe sleeve			03.070.0240.0 S Vergl.-Nr. Comp.No 05.331.84.01.0
passend für to fit to Bergische Achse			
Stückliste Parts List 1 x 03.070.0239.000 Bolzen, Bremsbackenrolle Pin, brake shoe sleeve 1 x 03.070.0240.000 Bremsbackenrolle Brake Shoe Sleeve 2 x 03.070.0242.610 Dichtring Seal Ring 1 x 03.070.0243.550 Bügel Bracket 1 x 18.070.0243.530 Splint Split Pin			
Reparatursatz, Bremsbackenrolle Repair Kit, brake shoe sleeve			03.070.0242.9 S Vergl.-Nr. Comp.No 09.801.02.10.0
passend für to fit to Bergische Achse			
Stückliste Parts List 1 x 03.070.0242.900 Bremsbackenrolle Brake Shoe Sleeve 2 x 03.070.0242.910 Sicherungsclip Circlip 1 x 18.070.0243.530 Splint Split Pin			
Reparatursatz, Bremsbackenrolle Repair Kit, brake shoe sleeve			03.070.0243.0 S Vergl.-Nr. Comp.No 03.331.34.02.0 S
passend für to fit to Bergische Achse			
Stückliste Parts List 1 x 03.070.0243.000 Bremsbackenrolle Brake Shoe Sleeve 2 x 03.070.0243.010 Halteblech, Bremsbackenbolzen Retaining Plate, brake shoe pins 1 x 18.070.0243.020 Splint Split Pin			

BG-03.070

Reparatursatz, Bremsbackenrolle Repair Kit, brake shoe sleeve



Reparatursatz, Bremsbackenrolle Repair Kit, brake shoe sleeve		
<p>Reparatursatz, Bremsbackenrolle Repair Kit, brake shoe sleeve</p> <p>passend für to fit to Bergische Achse</p> <p>Stückliste Parts List 1 x 03.070.0244.800 Bremsbackenrolle Brake Shoe Sleeve 2 x 03.070.0247.830 Sicherungsclip Circlip 1 x 18.070.0243.530 Splint Split Pin</p>		<p>03.070.0244.5 S</p> <p>Vergl.-Nr. Comp.No 09.801.02.12.0</p>
<p>Reparatursatz, Bremsbackenrolle Repair Kit, brake shoe sleeve</p> <p>passend für to fit to MAN</p> <p>Stückliste Parts List 1 x 03.070.0941.000 Bremsbackenrolle Brake Shoe Sleeve 1 x 03.070.1455.020 Sicherungsring Circlip 1 x 03.070.1455.060 Bolzen, Bremsbackenrolle Pin, brake shoe sleeve 1 x 03.070.1455.070 Unterlegscheibe Washer</p>		<p>03.070.0941.1 S</p> <p>Vergl.-Nr. Comp.No 81.50213.6006 S</p>
<p>Reparatursatz, Bremsbackenrolle Repair Kit, brake shoe sleeve</p> <p>passend für to fit to Mercedes-Benz</p> <p>Stückliste Parts List 1 x 03.070.1454.000 Bolzen, Bremsbackenrolle Pin, brake shoe sleeve 1 x 03.070.1455.000 Bremsbackenrolle Brake Shoe Sleeve 2 x 03.070.1455.020 Sicherungsring Circlip 2 x 03.070.1455.050 Unterlegscheibe Washer 2 x 03.070.1455.080 Dichtring Seal Ring</p>		<p>03.070.1454.1 S</p> <p>Vergl.-Nr. Comp.No 335 420 00 39</p>
<p>Reparatursatz, Bremsbackenrolle Repair Kit, brake shoe sleeve</p> <p>passend für to fit to Mercedes-Benz</p> <p>Stückliste Parts List 1 x 03.070.1455.000 Bremsbackenrolle Brake Shoe Sleeve 1 x 03.070.1455.020 Sicherungsring Circlip 1 x 03.070.1455.060 Bolzen, Bremsbackenrolle Pin, brake shoe sleeve 1 x 03.070.1455.070 Unterlegscheibe Washer 2 x 03.070.1455.080 Dichtring Seal Ring</p>		<p>03.070.1455.1 S</p> <p>Vergl.-Nr. Comp.No 307 420 03 39</p>

**Reparaturatz, Bremsbackenrolle
Repair Kit, brake shoe sleeve**
Reparaturatz, Bremsbackenrolle | Repair Kit, brake shoe sleeve

Reparaturatz, Bremsbackenrolle

Repair Kit, brake shoe sleeve

passend für | to fit to

Mercedes-Benz

Stückliste | Parts List

- 4 x 03.070.1455.100 Sicherungsring | Circlip
- 2 x 03.070.1456.000 Bolzen, Bremsbackenrolle | Pin, brake shoe sleeve
- 4 x 03.070.1457.030 Dichtring | Seal Ring
- 2 x 03.070.1457.040 Buchse, Bremsbackenbolzen | Bush, brake shoe pin
- 1 x 03.070.1904.890 Halteblech, Bremsbackenbolzen | Retaining Plate, brake shoe pins
- 1 x 03.070.1904.900 Halteblech, Bremsbackenbolzen | Retaining Plate, brake shoe pins
- 1 x 03.070.1904.910 Halteblech, Bremsbackenbolzen | Retaining Plate, brake shoe pins
- 1 x 03.070.1904.930 Schraube | Screw / Bolt
- 2 x 03.070.1905.910 Federhaltestift, Bremsbacke | Spring Retaining Pin, brake shoe
- 1 x 03.080.1780.000 Feder, Bremsbacken | Spring, brake shoe
- 1 x 03.080.1795.000 Feder, Bremsbacken | Spring, brake shoe

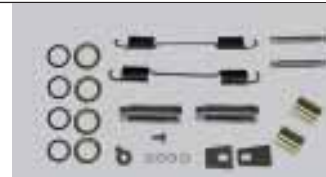
03.070.1608.1 S

 Vergl.-Nr. | Comp.No
346 421 11 74 S

Reparaturatz, Bremsbackenrolle

Repair Kit, brake shoe sleeve

passend für | to fit to

Mercedes-Benz

Stückliste | Parts List

- 2 x 03.070.1456.000 Bolzen, Bremsbackenrolle | Pin, brake shoe sleeve
- 4 x 03.070.1457.030 Dichtring | Seal Ring
- 2 x 03.070.1457.040 Buchse, Bremsbackenbolzen | Bush, brake shoe pin
- 1 x 03.070.1904.890 Halteblech, Bremsbackenbolzen | Retaining Plate, brake shoe pins
- 1 x 03.070.1904.900 Halteblech, Bremsbackenbolzen | Retaining Plate, brake shoe pins
- 1 x 03.070.1904.910 Halteblech, Bremsbackenbolzen | Retaining Plate, brake shoe pins
- 1 x 03.070.1904.930 Schraube | Screw / Bolt
- 2 x 03.070.1905.920 Federhaltestift, Bremsbacke | Spring Retaining Pin, brake shoe
- 2 x 03.080.1781.000 Feder, Bremsbacken | Spring, brake shoe

03.070.1609.1 S

 Vergl.-Nr. | Comp.No
497 421 00 74 S

Reparaturatz, Bremsbackenrolle

Repair Kit, brake shoe sleeve

passend für | to fit to

SAF

Stückliste | Parts List

- 1 x 03.070.2012.000 Bremsbackenrolle | Brake Shoe Sleeve
- 2 x 03.070.2051.000 Halteblech, Bremsbackenbolzen | Retaining Plate, brake shoe pins
- 2 x 03.070.2065.000 Schraube | Screw / Bolt
- 2 x 18.060.2064.000 Mutter | Nut

03.070.2012.S00

 Vergl.-Nr. | Comp.No
1.265.0007.00 S

Reparaturatz, Bremsbackenrolle

Repair Kit, brake shoe sleeve

passend für | to fit to

SAF

03.070.2013.S00

Vergl.-Nr. | Comp.No

BG-03.070

Reparatursatz, Bremsbackenrolle Repair Kit, brake shoe sleeve



Reparatursatz, Bremsbackenrolle | Repair Kit, brake shoe sleeve

Reparatursatz, Bremsbackenrolle

Repair Kit, brake shoe sleeve

passend für | to fit to

ROR

Reparatursatz, Bremsbackenrolle

Repair Kit, brake shoe sleeve

passend für | to fit to

ROR



03.070.4200.410

Vergl.-Nr. | Comp.No

AXL 125



03.070.4200.420

Vergl.-Nr. | Comp.No

AXL 117

Bremsbackenbolzensatz | Brake Shoe Pin Set

Bremsbackenbolzensatz

Brake Shoe Pin Set

passend für | to fit to

Mercedes-Benz

Stückliste | Parts List

- 2 x 03.070.1456.000 Bolzen, Bremsbackenrolle | Pin, brake shoe sleeve
- 4 x 03.070.1457.030 Dichtring | Seal Ring
- 2 x 03.070.1457.040 Buchse, Bremsbackenbolzen | Bush, brake shoe pin
- 1 x 03.070.1904.890 Halteblech, Bremsbackenbolzen | Retaining Plate, brake shoe pins
- 1 x 03.070.1904.900 Halteblech, Bremsbackenbolzen | Retaining Plate, brake shoe pins
- 1 x 03.070.1904.910 Halteblech, Bremsbackenbolzen | Retaining Plate, brake shoe pins
- 1 x 03.070.1904.930 Schraube | Screw / Bolt



03.070.1456.2 S

Vergl.-Nr. | Comp.No

307 420 40 02

Bremsbackenbolzensatz

Brake Shoe Pin Set

passend für | to fit to

Mercedes-Benz

Stückliste | Parts List

- 2 x 03.070.1457.000 Bolzen, Bremsbackenrolle | Pin, brake shoe sleeve
- 4 x 03.070.1457.010 Buchse, Bremsbackenbolzen | Bush, brake shoe pin
- 4 x 03.070.1457.020 Dichtring | Seal Ring
- 1 x 03.070.1904.910 Halteblech, Bremsbackenbolzen | Retaining Plate, brake shoe pins
- 1 x 03.070.1904.930 Schraube | Screw / Bolt
- 1 x 03.070.1904.940 Halteblech, Bremsbackenbolzen | Retaining Plate, brake shoe pins





03.070.1457.2 S

Vergl.-Nr. | Comp.No

395 420 00 41

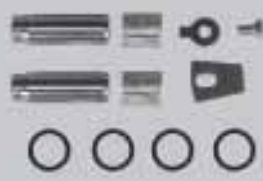
Bremsbackenbolzensatz | Brake Shoe Pin Set

<p>Bremsbackenbolzensatz Brake Shoe Pin Set</p> <p>passend für to fit to Mercedes-Benz</p> <p>Stückliste Parts List</p> <p>2 x 03.070.1456.000 Bolzen, Bremsbackenrolle Pin, brake shoe sleeve 4 x 03.070.1457.030 Dichtring Seal Ring 1 x 03.070.1904.890 Halteblech, Bremsbackenbolzen Retaining Plate, brake shoe pins 1 x 03.070.1904.900 Halteblech, Bremsbackenbolzen Retaining Plate, brake shoe pins 1 x 03.070.1904.910 Halteblech, Bremsbackenbolzen Retaining Plate, brake shoe pins 1 x 03.070.1904.930 Schraube Screw / Bolt 2 x 03.070.1930.010 Buchse, Bremsbackenbolzen Bush, brake shoe pin</p>		<p>03.070.1459.2 S</p> <p>Vergl.-Nr. Comp.No 307 420 41 02</p>
<p>Bremsbackenbolzensatz Brake Shoe Pin Set</p> <p>passend für to fit to Mercedes-Benz</p> <p>Stückliste Parts List</p> <p>1 x 03.070.1904.910 Halteblech, Bremsbackenbolzen Retaining Plate, brake shoe pins 1 x 03.070.1904.930 Schraube Screw / Bolt 2 x 03.070.1920.010 Bolzen, Bremsbackenrolle Pin, brake shoe sleeve 2 x 03.070.1920.020 Buchse, Bremsbackenbolzen Bush, brake shoe pin 4 x 03.070.1920.030 Dichtring Seal Ring 1 x 03.070.1920.040 Halteblech, Bremsbackenbolzen Retaining Plate, brake shoe pins</p>		<p>03.070.1920.2 S</p> <p>Vergl.-Nr. Comp.No 318 420 01 82</p>
<p>Bremsbackenbolzensatz Brake Shoe Pin Set</p> <p>passend für to fit to Mercedes-Benz</p> <p>Stückliste Parts List</p> <p>2 x 03.070.1456.000 Bolzen, Bremsbackenrolle Pin, brake shoe sleeve 1 x 03.070.1904.910 Halteblech, Bremsbackenbolzen Retaining Plate, brake shoe pins 1 x 03.070.1904.930 Schraube Screw / Bolt 2 x 03.070.1930.010 Buchse, Bremsbackenbolzen Bush, brake shoe pin 4 x 03.070.1930.020 Dichtring Seal Ring 1 x 03.070.1930.030 Halteblech, Bremsbackenbolzen Retaining Plate, brake shoe pins 2 x 03.070.1930.040 Bolzen, Bremsbackenrolle Pin, brake shoe sleeve</p>		<p>03.070.1930.2 S</p> <p>Vergl.-Nr. Comp.No 675 420 00 82</p>
<p>Bremsbackenbolzensatz Brake Shoe Pin Set</p> <p>passend für to fit to SAF</p> <p>Stückliste Parts List</p> <p>1 x 03.070.2000.000 Bolzen, Bremsbackenrolle Pin, brake shoe sleeve 1 x 04.120.1716.000 Sicherungsring Circlip 1 x 18.080.2001.000 Schmiernippel Grease Nipple</p>		<p>03.070.2000.S00</p> <p>Vergl.-Nr. Comp.No 3.213.0004.06</p>

BG-03.070

Bremsbackenbolzensatz Brake Shoe Pin Set



Bremsbackenbolzensatz | Brake Shoe Pin Set

Bremsbackenbolzensatz
Brake Shoe Pin Set

passend für | to fit to
SAF

Stückliste | Parts List

- 1 x 03.070.2022.000 Bolzen, Bremsbackenrolle | Pin, brake shoe sleeve
- 2 x 03.070.2030.000 Unterlegscheibe | Washer
- 2 x 04.120.1716.000 Sicherungsring | Circlip



03.070.2022.S00

Vergl.-Nr. | Comp.No
3.213.0022.02

Bremsbackenbolzensatz
Brake Shoe Pin Set

passend für | to fit to
SAF

Stückliste | Parts List

- 1 x 03.070.2023.000 Bolzen, Bremsbackenrolle | Pin, brake shoe sleeve
- 2 x 03.070.2030.000 Unterlegscheibe | Washer
- 2 x 04.120.1716.000 Sicherungsring | Circlip



03.070.2030.S00

Vergl.-Nr. | Comp.No
3.213.0023.02

Bremsbackenbolzensatz
Brake Shoe Pin Set

passend für | to fit to
SAF

Stückliste | Parts List

- 1 x 03.070.2023.100 Bolzen, Bremsbackenrolle | Pin, brake shoe sleeve
- 2 x 03.070.2030.000 Unterlegscheibe | Washer
- 2 x 04.120.1716.000 Sicherungsring | Circlip



03.070.2031.S00

Vergl.-Nr. | Comp.No
3.213.0023.01

Halteblech, Bremsbackenbolzen | Retaining Plate, brake shoe pins

Halteblech, Bremsbackenbolzen
Retaining Plate, brake shoe pins

passend für | to fit to
Bergische Achse

Länge	55
Length (mm)	
Breite 1	27,5
Width 1 (mm)	
Breite 2	37
Width 2 (mm)	
Dicke/Stärke	3,5
Thickness (mm)	



03.070.0243.010

Vergl.-Nr. | Comp.No
03.232.13.02.0

Halteblech, Bremsbackenbolzen
Retaining Plate, brake shoe pins

passend für | to fit to
Bergische Achse







Länge	58
Length (mm)	
Breite	52
Width (mm)	
Dicke/Stärke	4
Thickness (mm)	



03.070.0245.920

Vergl.-Nr. | Comp.No
03.167.23.02.0

**Halteblech, Bremsbackenbolzen
Retaining Plate, brake shoe pins**

Halteblech, Bremsbackenbolzen Retaining Plate, brake shoe pins				
Halteblech, Bremsbackenbolzen Retaining Plate, brake shoe pins	Länge Length (mm)	44,5		03.070.1904.890 Vergl.-Nr. Comp.No 346 994 01 09
passend für to fit to Mercedes-Benz	Breite 1 Width 1 (mm)	32		
	Breite 2 Width 2 (mm)	40		
	Dicke/Stärke Thickness (mm)	3,7		
Halteblech, Bremsbackenbolzen Retaining Plate, brake shoe pins	Länge Length (mm)	44,5		03.070.1904.900 Vergl.-Nr. Comp.No 381 994 00 09
passend für to fit to Mercedes-Benz	Breite 1 Width 1 (mm)	32		
	Breite 2 Width 2 (mm)	40		
	Dicke/Stärke Thickness (mm)	3,7		
Halteblech, Bremsbackenbolzen Retaining Plate, brake shoe pins				03.070.1904.910 Vergl.-Nr. Comp.No 346 994 00 09
passend für to fit to Mercedes-Benz				
Halteblech, Bremsbackenbolzen Retaining Plate, brake shoe pins	Länge Length (mm)	45		03.070.1904.940 Vergl.-Nr. Comp.No 302 994 02 09
passend für to fit to Mercedes-Benz	Breite Width (mm)	35		
	Dicke/Stärke Thickness (mm)	2,5		
Halteblech, Bremsbackenbolzen Retaining Plate, brake shoe pins	Länge Length (mm)	45		03.070.1920.040 Vergl.-Nr. Comp.No 318 421 02 73
passend für to fit to Mercedes-Benz	Breite 1 Width 1 (mm)	25		
	Breite 2 Width 2 (mm)	37		
	Dicke/Stärke Thickness (mm)	4		
Halteblech, Bremsbackenbolzen Retaining Plate, brake shoe pins				03.070.1930.030 Vergl.-Nr. Comp.No 674 421 00 73
passend für to fit to Mercedes-Benz				
Halteblech, Bremsbackenbolzen Retaining Plate, brake shoe pins				03.070.2051.000 Vergl.-Nr. Comp.No 1.345.0006.00
passend für to fit to SAF				

BG-03.070

Halteblech, Bremsbackenbolzen Retaining Plate, brake shoe pins



Halteblech, Bremsbackenbolzen | Retaining Plate, brake shoe pins

Halteblech, Bremsbackenbolzen
Retaining Plate, brake shoe pins

passend für | to fit to
Frühauf; ROR; Trailor



03.070.4200.710

Vergl.-Nr. | Comp.No
210 23 758

Bügel | Bracket

Bügel
Bracket

passend für | to fit to
Bergische Achse



03.070.0243.550

Vergl.-Nr. | Comp.No
03.114.44.03.0

Sicherungsbügel | Fastening Clamp

Sicherungsbügel
Fastening Clamp

passend für | to fit to
Kässbohrer



03.070.0694.000

Vergl.-Nr. | Comp.No
01.24219.26.15

Feder, Bremsbacken | Spring, brake shoe

Feder, Bremsbacken
Spring, brake shoe

passend für | to fit to
Bergische Achse

Länge	69
Length (mm)	
Aussendurchmesser	23,2
Outer Diameter (mm)	
Dicke/Stärke	2,8
Thickness (mm)	



03.080.0240.020

Vergl.-Nr. | Comp.No
03.397.26.04.0

Feder, Bremsbacken
Spring, brake shoe

passend für | to fit to
Bergische Achse

Länge	270
Length (mm)	
Aussendurchmesser	25
Outer Diameter (mm)	
Dicke/Stärke	5
Thickness (mm)	



03.080.0240.070

Vergl.-Nr. | Comp.No
05.397.56.07.0

Feder, Bremsbacken
Spring, brake shoe

passend für | to fit to
Bergische Achse

Länge	156
Length (mm)	
Aussendurchmesser	22
Outer Diameter (mm)	
Dicke/Stärke	4
Thickness (mm)	



03.080.0240.120

Vergl.-Nr. | Comp.No
05.397.45.05.0

Feder, Bremsbacken
Spring, brake shoe

passend für | to fit to
Bergische Achse







Länge	148
Length (mm)	
Aussendurchmesser	26
Outer Diameter (mm)	
Dicke/Stärke	2,8
Thickness (mm)	



03.080.0240.130

Vergl.-Nr. | Comp.No
03.397.26.03.0

Feder, Bremsbacken | Spring, brake shoe

<p>Feder, Bremsbacken Spring, brake shoe</p> <p>passend für to fit to Bergische Achse</p> <p>Stückliste Parts List 1 x 14.090.0243.560 Kronenmutter Castle Nut 1 x 18.070.0243.570 Splint Split Pin 1 x 20.010.0241.84R Haltefeder Retaining Spring</p>	<p>Länge 68 Length (mm)</p> <p>Aussendurchmesser 13 Outer Diameter (mm)</p> <p>Dicke/Stärke 2,25 Thickness (mm)</p>		<p>03.080.0241.840</p> <p>Vergl.-Nr. Comp.No 09.397.21.03.0</p>
<p>Feder, Bremsbacken Spring, brake shoe</p> <p>passend für to fit to Bergische Achse</p> <p>Stückliste Parts List 1 x 14.090.0243.560 Kronenmutter Castle Nut 1 x 18.070.0243.570 Splint Split Pin 1 x 20.010.0241.87R Haltefeder Retaining Spring</p>			<p>03.080.0241.870</p> <p>Vergl.-Nr. Comp.No 09.397.32.04.0</p>
<p>Feder, Bremsbacken Spring, brake shoe</p> <p>passend für to fit to Bergische Achse</p>	<p>Länge 101 Length (mm)</p> <p>Aussendurchmesser 20 Outer Diameter (mm)</p> <p>Dicke/Stärke 3,5 Thickness (mm)</p>		<p>03.080.0241.880</p> <p>Vergl.-Nr. Comp.No 03.397.34.01.0</p>
<p>Feder, Bremsbacken Spring, brake shoe</p> <p>passend für to fit to Bergische Achse</p>	<p>Länge 113 Length (mm)</p> <p>Aussendurchmesser 20 Outer Diameter (mm)</p> <p>Dicke/Stärke 3,5 Thickness (mm)</p>		<p>03.080.0241.890</p> <p>Vergl.-Nr. Comp.No 03.397.34.02.0</p>
<p>Feder, Bremsbacken Spring, brake shoe</p> <p>passend für to fit to Bergische Achse</p>	<p>Länge 180 Length (mm)</p> <p>Ergänzungsartikel / Ergänzende Info verzinkt Supplementary Article/Supplementary Info Zinc-coated</p> <p>Aussendurchmesser 21 Outer Diameter (mm)</p> <p>Dicke/Stärke 3,2 Thickness (mm)</p>		<p>03.080.0241.900</p> <p>Vergl.-Nr. Comp.No 03.397.34.10.0</p>
<p>Feder, Bremsbacken Spring, brake shoe</p> <p>passend für to fit to Bergische Achse</p>	<p>Länge 164 Length (mm)</p> <p>Aussendurchmesser 22 Outer Diameter (mm)</p> <p>Dicke/Stärke 3,6 Thickness (mm)</p>		<p>03.080.0241.910</p> <p>Vergl.-Nr. Comp.No 05.397.35.01.0</p>

BG-03.080

Feder, Bremsbacken Spring, brake shoe



Feder, Bremsbacken Spring, brake shoe			
Feder, Bremsbacken Spring, brake shoe passend für to fit to Bergische Achse	Länge Length (mm)	265	 03.080.0241.920 Vergl.-Nr. Comp.No 05.397.46.03.0
	Aussendurchmesser Outer Diameter (mm)	24	
	Dicke/Stärke Thickness (mm)	4,25	
Feder, Bremsbacken Spring, brake shoe passend für to fit to Bergische Achse	Länge Length (mm)	266	 03.080.0241.930 Vergl.-Nr. Comp.No 05.397.46.06.0
	Aussendurchmesser Outer Diameter (mm)	24	
	Dicke/Stärke Thickness (mm)	4	
Feder, Bremsbacken Spring, brake shoe passend für to fit to Bergische Achse	Länge Length (mm)	265	 03.080.0241.980 Vergl.-Nr. Comp.No 05.397.58.03.0
	Aussendurchmesser Outer Diameter (mm)	34	
	Dicke/Stärke Thickness (mm)	5,5	
Feder, Bremsbacken Spring, brake shoe passend für to fit to Bergische Achse	Länge Length (mm)	105	 03.080.0242.880 Vergl.-Nr. Comp.No 03.397.44.06.0
	Aussendurchmesser Outer Diameter (mm)	21	
	Dicke/Stärke Thickness (mm)	4	
Feder, Bremsbacken Spring, brake shoe passend für to fit to Bergische Achse	Länge Length (mm)	208	 03.080.0245.170 Vergl.-Nr. Comp.No 03.397.45.06.0
	Aussendurchmesser Outer Diameter (mm)	23,5	
	Dicke/Stärke Thickness (mm)	4,5	
Feder, Bremsbacken Spring, brake shoe passend für to fit to Bergische Achse	Länge Length (mm)	187	 03.080.0245.700 Vergl.-Nr. Comp.No 03.397.46.10.0
	Aussendurchmesser Outer Diameter (mm)	24	
	Dicke/Stärke Thickness (mm)	4	
Feder, Bremsbacken Spring, brake shoe passend für to fit to Bergische Achse	Länge Length (mm)	218	 03.080.0245.970 Vergl.-Nr. Comp.No 05.397.35.02.0
	Aussendurchmesser Outer Diameter (mm)	24	
	Dicke/Stärke Thickness (mm)	4	
Feder, Bremsbacken Spring, brake shoe passend für to fit to Bergische Achse	Länge Length (mm)	219	 03.080.0246.210 Vergl.-Nr. Comp.No 05.397.45.14.0
	Aussendurchmesser Outer Diameter (mm)	23,5	
	Dicke/Stärke Thickness (mm)	4	

Feder, Bremsbacken Spring, brake shoe				
Feder, Bremsbacken Spring, brake shoe passend für to fit to Bergische Achse	Länge Length (mm)	167		03.080.0246.430 Vergl.-Nr. Comp.No 05.397.46.12.0
	Aussendurchmesser Outer Diameter (mm)	24		
	Dicke/Stärke Thickness (mm)	4		
Feder, Bremsbacken Spring, brake shoe passend für to fit to Bergische Achse	Länge Length (mm)	180		03.080.0246.860 Vergl.-Nr. Comp.No 05.397.34.17.0
	Ergänzungsartikel / Ergän- zende Info Supplementary Article/Sup- plementary Info	verzinkt Zinc-coated		
	Aussendurchmesser Outer Diameter (mm)	20		
	Dicke/Stärke Thickness (mm)	3,6		
Feder, Bremsbacken Spring, brake shoe passend für to fit to Bergische Achse	Länge Length (mm)	107		03.080.0246.870 Vergl.-Nr. Comp.No 03.397.45.10.0
	Aussendurchmesser Outer Diameter (mm)	22		
	Dicke/Stärke Thickness (mm)	4		
Feder, Bremsbacken Spring, brake shoe passend für to fit to Bergische Achse	Länge Length (mm)	236		03.080.0246.880 Vergl.-Nr. Comp.No 05.397.46.13.0
	Aussendurchmesser Outer Diameter (mm)	24,5		
	Dicke/Stärke Thickness (mm)	4		
Feder, Bremsbacken Spring, brake shoe passend für to fit to Bergische Achse	Länge Length (mm)	166		03.080.0250.060 Vergl.-Nr. Comp.No 05.397.34.16.0
	Aussendurchmesser Outer Diameter (mm)	20		
	Dicke/Stärke Thickness (mm)	3,6		
Feder, Bremsbacken Spring, brake shoe passend für to fit to DAF	Länge Length (mm)	228		03.080.0284.000 Vergl.-Nr. Comp.No 1279 502
	Aussendurchmesser Outer Diameter (mm)	28		
	Dicke/Stärke Thickness (mm)	4		
Feder, Bremsbacken Spring, brake shoe passend für to fit to DAF	Länge Length (mm)	156		03.080.0289.010 Vergl.-Nr. Comp.No 1212 994
	Aussendurchmesser Outer Diameter (mm)	39		
	Dicke/Stärke Thickness (mm)	5,3		

BG-03.080

Feder, Bremsbacken Spring, brake shoe



Feder, Bremsbacken Spring, brake shoe			
Feder, Bremsbacken Spring, brake shoe passend für to fit to DAF	Länge Length (mm)	238	 03.080.0290.230 Vergl.-Nr. Comp.No 672 797
	Aussendurchmesser Outer Diameter (mm)	28	
	Dicke/Stärke Thickness (mm)	4,25	
Feder, Bremsbacken Spring, brake shoe passend für to fit to DAF	Länge Length (mm)	195	 03.080.0290.240 Vergl.-Nr. Comp.No 191 530
	Aussendurchmesser Outer Diameter (mm)	19	
	Dicke/Stärke Thickness (mm)	3	
Feder, Bremsbacken Spring, brake shoe passend für to fit to Kässbohrer	Länge Length (mm)	165	 03.080.0615.020 Vergl.-Nr. Comp.No 8.285.049.124.0
	Aussendurchmesser Outer Diameter (mm)	34	
	Dicke/Stärke Thickness (mm)	5	
Feder, Bremsbacken Spring, brake shoe passend für to fit to Kässbohrer	Länge Length (mm)	110	 03.080.0618.010 Vergl.-Nr. Comp.No 8.285.049.125.0
	Aussendurchmesser Outer Diameter (mm)	20	
	Dicke/Stärke Thickness (mm)	4,6	
Feder, Bremsbacken Spring, brake shoe passend für to fit to Kässbohrer	Länge Length (mm)	170	 03.080.0672.000 Vergl.-Nr. Comp.No 010.24.21.994.03
	Aussendurchmesser Outer Diameter (mm)	22	
	Dicke/Stärke Thickness (mm)	4	
Feder, Bremsbacken Spring, brake shoe passend für to fit to Kässbohrer	Länge Length (mm)	160	 03.080.0699.000 Vergl.-Nr. Comp.No 6.128.113.019.00
	Aussendurchmesser Outer Diameter (mm)	30	
	Dicke/Stärke Thickness (mm)	5	
Feder, Bremsbacken Spring, brake shoe passend für to fit to Fiat-Iveco	Länge Length (mm)	186	 03.080.0806.060 Vergl.-Nr. Comp.No 0812 1308
	Aussendurchmesser Outer Diameter (mm)	19,3	
	Dicke/Stärke Thickness (mm)	3,7	
Feder, Bremsbacken Spring, brake shoe passend für to fit to Fiat-Iveco	Länge Length (mm)	212	 03.080.0806.070 Vergl.-Nr. Comp.No 0812 1307
	Aussendurchmesser Outer Diameter (mm)	24	
	Dicke/Stärke Thickness (mm)	3,6	

Feder, Bremsbacken | Spring, brake shoe

Feder, Bremsbacken Spring, brake shoe	Länge Length (mm)	244		03.080.0806.080 Vergl.-Nr. Comp.No
passend für to fit to Fiat-Iveco	Aussendurchmesser Outer Diameter (mm)	28		
	Dicke/Stärke Thickness (mm)	4		
Feder, Bremsbacken Spring, brake shoe	Länge Length (mm)	228		03.080.0806.090 Vergl.-Nr. Comp.No
passend für to fit to Fiat-Iveco	Aussendurchmesser Outer Diameter (mm)	22		
	Dicke/Stärke Thickness (mm)	3,6		
Feder, Bremsbacken Spring, brake shoe	Länge Length (mm)	215		03.080.0807.070 Vergl.-Nr. Comp.No 4248 0056
passend für to fit to Fiat-Iveco	Aussendurchmesser Outer Diameter (mm)	24		
	Dicke/Stärke Thickness (mm)	3,4		
Feder, Bremsbacken Spring, brake shoe	Länge Length (mm)	232		03.080.0901.010 Vergl.-Nr. Comp.No 81.97610.0132
passend für to fit to MAN	Aussendurchmesser Outer Diameter (mm)	22		
	Dicke/Stärke Thickness (mm)	3		
Feder, Bremsbacken Spring, brake shoe	Länge Length (mm)	235		03.080.0901.030 Vergl.-Nr. Comp.No 81.97610.0099
passend für to fit to MAN	Aussendurchmesser Outer Diameter (mm)	30		
	Dicke/Stärke Thickness (mm)	5		
Feder, Bremsbacken Spring, brake shoe	Länge Length (mm)	240		03.080.0901.170 Vergl.-Nr. Comp.No 81.97610.0271
passend für to fit to MAN	Aussendurchmesser Outer Diameter (mm)	30		
	Dicke/Stärke Thickness (mm)	5		
Feder, Bremsbacken Spring, brake shoe	Länge Length (mm)	240		03.080.0904.980 Vergl.-Nr. Comp.No 81.97610.0266
passend für to fit to MAN	Aussendurchmesser Outer Diameter (mm)	30		
	Dicke/Stärke Thickness (mm)	5,0		
Feder, Bremsbacken Spring, brake shoe	Länge Length (mm)	244		03.080.1772.000 Vergl.-Nr. Comp.No 617 993 11 10
passend für to fit to Mercedes-Benz	Aussendurchmesser Outer Diameter (mm)	26		
	Dicke/Stärke Thickness (mm)	4		







BG-03.080

Feder, Bremsbacken Spring, brake shoe

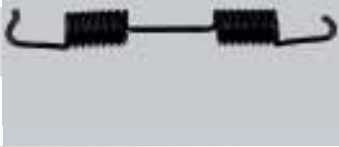
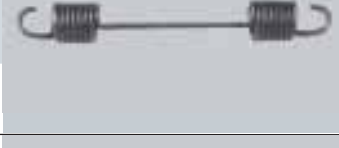

Feder, Bremsbacken Spring, brake shoe			
Feder, Bremsbacken Spring, brake shoe passend für to fit to Mercedes-Benz	Länge Length (mm)	232	 03.080.1773.000 Vergl.-Nr. Comp.No 945 993 00 10
	Aussendurchmesser Outer Diameter (mm)	28	
	Dicke/Stärke Thickness (mm)	4	
Feder, Bremsbacken Spring, brake shoe passend für to fit to Mercedes-Benz	Länge Length (mm)	217	 03.080.1779.000 Vergl.-Nr. Comp.No 335 421 03 92
	Aussendurchmesser Outer Diameter (mm)	33	
	Dicke/Stärke Thickness (mm)	4,25	
Feder, Bremsbacken Spring, brake shoe passend für to fit to Mercedes-Benz	Länge Length (mm)	246	 03.080.1780.000 Vergl.-Nr. Comp.No 346 993 02 10
	Aussendurchmesser Outer Diameter (mm)	26	
	Dicke/Stärke Thickness (mm)	4	
Feder, Bremsbacken Spring, brake shoe passend für to fit to Mercedes-Benz	Länge Length (mm)	236	 03.080.1781.000 Vergl.-Nr. Comp.No 346 993 03 10
	Aussendurchmesser Outer Diameter (mm)	26	
	Dicke/Stärke Thickness (mm)	4	
Feder, Bremsbacken Spring, brake shoe passend für to fit to Mercedes-Benz	Länge Length (mm)	255	 03.080.1782.000 Vergl.-Nr. Comp.No 360 993 01 10
	Aussendurchmesser Outer Diameter (mm)	31	
	Dicke/Stärke Thickness (mm)	5	
Feder, Bremsbacken Spring, brake shoe passend für to fit to Mercedes-Benz	Länge Length (mm)	240	 03.080.1783.000 Vergl.-Nr. Comp.No 385 993 05 10
	Aussendurchmesser Outer Diameter (mm)	24	
	Dicke/Stärke Thickness (mm)	4	
Feder, Bremsbacken Spring, brake shoe passend für to fit to Mercedes-Benz	Länge Length (mm)	192	 03.080.1784.000 Vergl.-Nr. Comp.No 314 993 08 10
	Aussendurchmesser Outer Diameter (mm)	22	
	Dicke/Stärke Thickness (mm)	4	
Feder, Bremsbacken Spring, brake shoe passend für to fit to Mercedes-Benz	Länge Length (mm)	242	 03.080.1785.000 Vergl.-Nr. Comp.No 346 993 01 10
	Aussendurchmesser Outer Diameter (mm)	26	
	Dicke/Stärke Thickness (mm)	4	

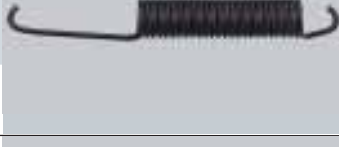
Feder, Bremsbacken | Spring, brake shoe

Feder, Bremsbacken Spring, brake shoe	Länge Length (mm)	182		03.080.1786.000 Vergl.-Nr. Comp.No 314 993 11 10
passend für to fit to Mercedes-Benz	Aussendurchmesser Outer Diameter (mm)	23		
	Dicke/Stärke Thickness (mm)	4		
Feder, Bremsbacken Spring, brake shoe	Länge Length (mm)	222		03.080.1787.000 Vergl.-Nr. Comp.No 336 993 00 10
passend für to fit to Mercedes-Benz	Aussendurchmesser Outer Diameter (mm)	30		
	Dicke/Stärke Thickness (mm)	4		
Feder, Bremsbacken Spring, brake shoe	Länge Length (mm)	253		03.080.1788.000 Vergl.-Nr. Comp.No 341 421 00 92
passend für to fit to Mercedes-Benz	Aussendurchmesser Outer Diameter (mm)	37		
	Dicke/Stärke Thickness (mm)	5,3		
Feder, Bremsbacken Spring, brake shoe	Länge Length (mm)	223		03.080.1789.000 Vergl.-Nr. Comp.No 335 421 01 92
passend für to fit to Mercedes-Benz	Aussendurchmesser Outer Diameter (mm)	34		
	Dicke/Stärke Thickness (mm)	4,8		
Feder, Bremsbacken Spring, brake shoe	Länge Length (mm)	380		03.080.1790.000 Vergl.-Nr. Comp.No 335 993 05 10
passend für to fit to Mercedes-Benz	Aussendurchmesser Outer Diameter (mm)	32		
	Dicke/Stärke Thickness (mm)	6		
Feder, Bremsbacken Spring, brake shoe	Länge Length (mm)	245		03.080.1791.000 Vergl.-Nr. Comp.No 302 993 06 10
passend für to fit to Mercedes-Benz	Aussendurchmesser Outer Diameter (mm)	33		
	Dicke/Stärke Thickness (mm)	5		
Feder, Bremsbacken Spring, brake shoe	Länge Length (mm)	205		03.080.1793.000 Vergl.-Nr. Comp.No 317 993 10 10
passend für to fit to Mercedes-Benz	Aussendurchmesser Outer Diameter (mm)	36		
	Dicke/Stärke Thickness (mm)	4,5		
Feder, Bremsbacken Spring, brake shoe	Länge Length (mm)	241		03.080.1794.000 Vergl.-Nr. Comp.No 326 993 00 10
passend für to fit to Mercedes-Benz	Aussendurchmesser Outer Diameter (mm)	34		
	Dicke/Stärke Thickness (mm)	5		

BG-03.080

Feder, Bremsbacken Spring, brake shoe



Feder, Bremsbacken Spring, brake shoe			
Feder, Bremsbacken Spring, brake shoe passend für to fit to Mercedes-Benz	Länge Length (mm)	229	 03.080.1795.000 Vergl.-Nr. Comp.No 346 993 08 10
	Aussendurchmesser Outer Diameter (mm)	31	
	Dicke/Stärke Thickness (mm)	4,2	
Feder, Bremsbacken Spring, brake shoe passend für to fit to Mercedes-Benz	Länge Length (mm)	70	 03.080.1796.000 Vergl.-Nr. Comp.No 302 993 03 10
	Aussendurchmesser Outer Diameter (mm)	16	
	Dicke/Stärke Thickness (mm)	2,5	
Feder, Bremsbacken Spring, brake shoe passend für to fit to Mercedes-Benz	Länge Length (mm)	215	 03.080.1905.810 Vergl.-Nr. Comp.No 303 993 04 10
	Aussendurchmesser Outer Diameter (mm)	27	
	Dicke/Stärke Thickness (mm)	3	
Feder, Bremsbacken Spring, brake shoe passend für to fit to Mercedes-Benz	Länge Length (mm)	96	 03.080.1908.000 Vergl.-Nr. Comp.No 677 993 03 10
	Aussendurchmesser Outer Diameter (mm)	30,25	
	Dicke/Stärke Thickness (mm)	4,25	
	DIN/ISO DIN / ISO	17223	
Feder, Bremsbacken Spring, brake shoe passend für to fit to Mercedes-Benz	Länge Length (mm)	65	 03.080.1908.040 Vergl.-Nr. Comp.No 673 993 02 10
	Aussendurchmesser Outer Diameter (mm)	25	
	Dicke/Stärke Thickness (mm)	4	
Feder, Bremsbacken Spring, brake shoe passend für to fit to SAF	Länge Length (mm)	168	 03.080.2031.000 Vergl.-Nr. Comp.No 1.447.0033.00
	Aussendurchmesser Outer Diameter (mm)	29	
	Dicke/Stärke Thickness (mm)	5	
Feder, Bremsbacken Spring, brake shoe passend für to fit to SAF	Länge Length (mm)	190	 03.080.2032.000 Vergl.-Nr. Comp.No 1.447.0021.01
	Aussendurchmesser Outer Diameter (mm)	26,25	
	Dicke/Stärke Thickness (mm)	4,25	

Feder, Bremsbacken Spring, brake shoe				
Feder, Bremsbacken Spring, brake shoe passend für to fit to SAF	Länge	228		03.080.2035.000 Vergl.-Nr. Comp.No 1.447.0038.00
	Aussendurchmesser	25,5		
	Outer Diameter (mm)			
	Dicke/Stärke	4		
	Thickness (mm)			
Feder, Bremsbacken Spring, brake shoe passend für to fit to SAF	Länge	185		03.080.2067.000 Vergl.-Nr. Comp.No 1.447.0036.00
	Aussendurchmesser	22,5		
	Outer Diameter (mm)			
	Dicke/Stärke	2,5		
	Thickness (mm)			
Feder, Bremsbacken Spring, brake shoe passend für to fit to SAF	Länge	224		03.080.2175.000 Vergl.-Nr. Comp.No 1.447.0050.00
	Aussendurchmesser	29,5		
	Outer Diameter (mm)			
	Dicke/Stärke	4,5		
	Thickness (mm)			
Feder, Bremsbacken Spring, brake shoe passend für to fit to SAF	Länge	185		03.080.2182.000 Vergl.-Nr. Comp.No 1.447.0023.01
	Aussendurchmesser	22,5		
	Outer Diameter (mm)			
	Dicke/Stärke	2,5		
	Thickness (mm)			
Feder, Bremsbacken Spring, brake shoe passend für to fit to SAF	Länge	203		03.080.2214.000 Vergl.-Nr. Comp.No 1.447.0027.01
	Aussendurchmesser	28,5		
	Outer Diameter (mm)			
	Dicke/Stärke	4,25		
	Thickness (mm)			
Feder, Bremsbacken Spring, brake shoe passend für to fit to SAF	Länge	232		03.080.2219.000 Vergl.-Nr. Comp.No 1.447.0058.00
	Aussendurchmesser	31,5		
	Outer Diameter (mm)			
	Dicke/Stärke	5,4		
	Thickness (mm)			
Feder, Bremsbacken Spring, brake shoe passend für to fit to SAF	Länge	35		03.080.2220.000 Vergl.-Nr. Comp.No 1.151.0008.00
	Dicke/Stärke	2,5		
	Thickness (mm)			
Feder, Bremsbacken Spring, brake shoe passend für to fit to SAF	Länge	200		03.080.2221.400 Vergl.-Nr. Comp.No 1.447.0041.00
	Aussendurchmesser	26		
	Outer Diameter (mm)			
	Dicke/Stärke	4		
	Thickness (mm)			





BG-03.080

Feder, Bremsbacken Spring, brake shoe



Feder, Bremsbacken Spring, brake shoe				
Feder, Bremsbacken Spring, brake shoe passend für to fit to SAF	Länge Length (mm)	165		03.080.2233.000 Vergl.-Nr. Comp.No 1.447.0056.00
	Aussendurchmesser Outer Diameter (mm)	25		
	Dicke/Stärke Thickness (mm)	3,6		
Feder, Bremsbacken Spring, brake shoe passend für to fit to Scania	Länge Length (mm)	97		03.080.3000.170 Vergl.-Nr. Comp.No 120 824
	Aussendurchmesser Outer Diameter (mm)	28		
	Dicke/Stärke Thickness (mm)	4,5		
Feder, Bremsbacken Spring, brake shoe passend für to fit to Trailer	Länge Length (mm)	203		03.080.3504.020 Vergl.-Nr. Comp.No 1643000C
	Aussendurchmesser Outer Diameter (mm)	32		
	Dicke/Stärke Thickness (mm)	5		
Feder, Bremsbacken Spring, brake shoe passend für to fit to Volvo	Länge Length (mm)	203		03.080.4000.250 Vergl.-Nr. Comp.No 1586 683
	Aussendurchmesser Outer Diameter (mm)	37,5		
	Dicke/Stärke Thickness (mm)	6		
Feder, Bremsbacken Spring, brake shoe passend für to fit to Volvo	Länge Length (mm)	200		03.080.4000.650 Vergl.-Nr. Comp.No 0346 499-7
	Aussendurchmesser Outer Diameter (mm)	46		
	Dicke/Stärke Thickness (mm)	5,6		
Feder, Bremsbacken Spring, brake shoe passend für to fit to Volvo	Länge Length (mm)	111		03.080.4001.580 Vergl.-Nr. Comp.No 1586 076
	Aussendurchmesser Outer Diameter (mm)	15		
	Dicke/Stärke Thickness (mm)	1,3		
Feder, Bremsbacken Spring, brake shoe passend für to fit to Volvo	Länge Length (mm)	111,5		03.080.4001.640 Vergl.-Nr. Comp.No 1586 076-0
	Aussendurchmesser Outer Diameter (mm)	15,2		
	Dicke/Stärke Thickness (mm)	1,3		
	DIN/ISO	17223		
	DIN / ISO			

Feder, Bremsbacken | Spring, brake shoe

Feder, Bremsbacken Spring, brake shoe			03.080.4004.810
passend für to fit to Volvo			Vergl.-Nr. Comp.No 1696 444
Feder, Bremsbacken Spring, brake shoe	Länge Length (mm)		03.080.4200.010
	Aussendurchmesser Outer Diameter (mm)		Vergl.-Nr. Comp.No 210 23 389
passend für to fit to ROR	Dicke/Stärke Thickness (mm)		
Feder, Bremsbacken Spring, brake shoe	Länge Length (mm)		03.080.4200.140
	Aussendurchmesser Outer Diameter (mm)		Vergl.-Nr. Comp.No 212 21 224
passend für to fit to ROR	Dicke/Stärke Thickness (mm)		
Feder, Bremsbacken Spring, brake shoe	Länge Length (mm)		03.080.4200.580
	Aussendurchmesser Outer Diameter (mm)		Vergl.-Nr. Comp.No 212 05 194
passend für to fit to ROR	Dicke/Stärke Thickness (mm)		

Bremstrommel | Brake Drum



Bremstrommel Brake Drum			03.090.0252.000
	Höhe Height (mm)		Vergl.-Nr. Comp.No 03.105.46.20.0
	Durchmesser Diameter (mm)		
passend für to fit to Bergische Achse	Lochkreis-Ø Pitch Circle Ø (mm)		
	Nabenbohrung-Ø Hub Bore Ø (mm)		
	Lochanzahl Number of Holes		
	Bremsbahn Brake Surface (mm)		





BG-03.090

Bremstrommel Brake Drum



Bremstrommel | Brake Drum

Bremstrommel Brake Drum	Höhe Height (mm)	250		03.090.0252.010 Vergl.-Nr. Comp.No 03.106.67.54.0
passend für to fit to Bergische Achse	Durchmesser Diameter (mm)	420		
	Lochkreis-Ø Pitch Circle Ø (mm)	335		
	Nabenbohrung-Ø Hub Bore Ø (mm)	290		
	Lochanzahl Number of Holes	10		
	Bremsbahn Brake Surface (mm)	191		
	Höhe Height (mm)	226		
	Durchmesser Diameter (mm)	420		
	Lochkreis-Ø Pitch Circle Ø (mm)	335		
	Nabenbohrung-Ø Hub Bore Ø (mm)	290		
Lochanzahl Number of Holes	10			
Bremsbahn Brake Surface (mm)	191			
Bremstrommel Brake Drum	Höhe Height (mm)	226		03.090.0252.030 Vergl.-Nr. Comp.No 03.106.67.62.0
passend für to fit to Bergische Achse	Durchmesser Diameter (mm)	420		
	Lochkreis-Ø Pitch Circle Ø (mm)	335		
	Nabenbohrung-Ø Hub Bore Ø (mm)	290		
	Lochanzahl Number of Holes	10		
	Bremsbahn Brake Surface (mm)	191		
	Höhe Height (mm)	284		
	Durchmesser Diameter (mm)	420		
	Lochkreis-Ø Pitch Circle Ø (mm)	335		
	Nabenbohrung-Ø Hub Bore Ø (mm)	290		
Lochanzahl Number of Holes	10			
Bremsbahn Brake Surface (mm)	215			
Bremstrommel Brake Drum	Höhe Height (mm)	284		03.090.0252.040 Vergl.-Nr. Comp.No 03.106.77.52.0
passend für to fit to Bergische Achse	Durchmesser Diameter (mm)	420		
	Lochkreis-Ø Pitch Circle Ø (mm)	335		
	Nabenbohrung-Ø Hub Bore Ø (mm)	290		
	Lochanzahl Number of Holes	10		
	Bremsbahn Brake Surface (mm)	215		
	Höhe Height (mm)	259		
	Durchmesser Diameter (mm)	420		
	Lochkreis-Ø Pitch Circle Ø (mm)	335		
	Nabenbohrung-Ø Hub Bore Ø (mm)	290		
Lochanzahl Number of Holes	10			
Bremsbahn Brake Surface (mm)	209			

Bremstrommel Brake Drum				
Bremstrommel Brake Drum passend für to fit to Bergische Achse	Höhe	245		03.090.0252.060 Vergl.-Nr. Comp.No 03.105.46.03.0
	Height (mm)			
	Durchmesser	300		
	Diameter (mm)			
	Lochkreis-Ø	225		
	Pitch Circle Ø (mm)			
	Nabenbohrung-Ø	190		
	Hub Bore Ø (mm)			
	Lochanzahl	10		
	Number of Holes			
Bremsbahn	217			
Brake Surface (mm)				
Bremstrommel Brake Drum passend für to fit to Bergische Achse	Höhe	246		03.090.0252.070 Vergl.-Nr. Comp.No 03.106.67.12.0
	Height (mm)			
	Durchmesser	420		
	Diameter (mm)			
	Lochkreis-Ø	335		
	Pitch Circle Ø (mm)			
	Nabenbohrung-Ø	290		
	Hub Bore Ø (mm)			
	Lochanzahl	10		
	Number of Holes			
Bremsbahn	194			
Brake Surface (mm)				
Bremstrommel Brake Drum passend für to fit to Bergische Achse	Höhe	275		03.090.0252.080 Vergl.-Nr. Comp.No 03.106.77.04.0
	Height (mm)			
	Durchmesser	420		
	Diameter (mm)			
	Lochkreis-Ø	335		
	Pitch Circle Ø (mm)			
	Nabenbohrung-Ø	290		
	Hub Bore Ø (mm)			
	Lochanzahl	10		
	Number of Holes			
Bremsbahn	215			
Brake Surface (mm)				
Bremstrommel Brake Drum passend für to fit to Bergische Achse	Höhe	307		03.090.0252.090 Vergl.-Nr. Comp.No 03.106.77.11.0
	Height (mm)			
	Durchmesser	420		
	Diameter (mm)			
	Lochkreis-Ø	335		
	Pitch Circle Ø (mm)			
	Nabenbohrung-Ø	290		
	Hub Bore Ø (mm)			
	Lochanzahl	10		
	Number of Holes			
Bremsbahn	220			
Brake Surface (mm)				

BG-03.090



Bremstrommel Brake Drum



Bremstrommel | Brake Drum

Bremstrommel Brake Drum	Höhe Height (mm)	295		03.090.0252.100 Vergl.-Nr. Comp.No 03.105.46.10.0
passend für to fit to Bergische Achse	Durchmesser Diameter (mm)	300		
	Lochkreis-Ø Pitch Circle Ø (mm)	225		
	Nabenbohrung-Ø Hub Bore Ø (mm)	190		
	Lochanzahl Number of Holes	10		
	Bremsbahn Brake Surface (mm)	220		
	Höhe Height (mm)	245		
	Durchmesser Diameter (mm)	300		
	Lochkreis-Ø Pitch Circle Ø (mm)	225		
	Nabenbohrung-Ø Hub Bore Ø (mm)	190		
Lochanzahl Number of Holes	10			
Bremsbahn Brake Surface (mm)	216			
Bremstrommel Brake Drum	Höhe Height (mm)	226		03.090.0252.120 Vergl.-Nr. Comp.No 03.109.67.19.0
passend für to fit to Bergische Achse	Durchmesser Diameter (mm)	420		
	Lochkreis-Ø Pitch Circle Ø (mm)	335		
	Nabenbohrung-Ø Hub Bore Ø (mm)	290		
	Lochanzahl Number of Holes	10		
	Bremsbahn Brake Surface (mm)	191		
	Höhe Height (mm)	297		
	Durchmesser Diameter (mm)	420		
	Lochkreis-Ø Pitch Circle Ø (mm)	335		
	Nabenbohrung-Ø Hub Bore Ø (mm)	290		
Lochanzahl Number of Holes	10			
Bremsbahn Brake Surface (mm)	214			

Bremstrommel | Brake Drum

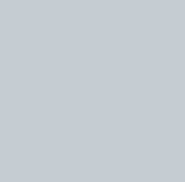
Bremstrommel Brake Drum passend für to fit to Bergische Achse	Höhe	259		03.090.0252.140 Vergl.-Nr. Comp.No 03.109.77.16.0
	Height (mm)			
	Durchmesser	420		
	Diameter (mm)			
	Lochkreis-Ø	335		
	Pitch Circle Ø (mm)			
	Nabenbohrung-Ø	290		
	Hub Bore Ø (mm)			
	Lochanzahl	10		
	Number of Holes			
Bremsbahn	209			
Brake Surface (mm)				
Bremstrommel Brake Drum passend für to fit to Bergische Achse	Höhe	260		03.090.0252.150 Vergl.-Nr. Comp.No 03.109.90.24.0
	Height (mm)			
	Durchmesser	360		
	Diameter (mm)			
	Lochkreis-Ø	225		
	Pitch Circle Ø (mm)			
	Nabenbohrung-Ø	190		
	Hub Bore Ø (mm)			
	Lochanzahl	10		
	Number of Holes			
Bremsbahn	200			
Brake Surface (mm)				
Bremstrommel Brake Drum passend für to fit to Bergische Achse	Höhe	260		03.090.0252.160 Vergl.-Nr. Comp.No 03.109.46.06.0
	Height (mm)			
	Durchmesser	300		
	Diameter (mm)			
	Lochkreis-Ø	225		
	Pitch Circle Ø (mm)			
	Nabenbohrung-Ø	190		
	Hub Bore Ø (mm)			
	Lochanzahl	10		
	Number of Holes			
Bremsbahn	209			
Brake Surface (mm)				
Bremstrommel Brake Drum passend für to fit to Bergische Achse	Höhe	260		03.090.0252.170 Vergl.-Nr. Comp.No 03.105.46.29.0
	Height (mm)			
	Durchmesser	300		
	Diameter (mm)			
	Lochkreis-Ø	225		
	Pitch Circle Ø (mm)			
	Nabenbohrung-Ø	190		
	Hub Bore Ø (mm)			
	Lochanzahl	10		
	Number of Holes			
Bremsbahn	206			
Brake Surface (mm)				

BG-03.090

Bremstrommel Brake Drum



Bremstrommel | Brake Drum

Bremstrommel Brake Drum	Höhe Height (mm)	263		03.090.0252.180 Vergl.-Nr. Comp.No 03.109.90.04.0
passend für to fit to Bergische Achse	Durchmesser Diameter (mm)	360		
	Lochkreis-Ø Pitch Circle Ø (mm)	225		
	Nabenbohrung-Ø Hub Bore Ø (mm)	190		
	Lochanzahl Number of Holes	10		
	Bremsbahn Brake Surface (mm)	209		
	Höhe Height (mm)	260		
	Durchmesser Diameter (mm)	360		
	Lochkreis-Ø Pitch Circle Ø (mm)	275		
	Nabenbohrung-Ø Hub Bore Ø (mm)	230		
Lochanzahl Number of Holes	8			
Bremsbahn Brake Surface (mm)	209			
Bremstrommel Brake Drum	Höhe Height (mm)	260		03.090.0252.190 Vergl.-Nr. Comp.No 03.109.90.03.0
passend für to fit to Bergische Achse	Durchmesser Diameter (mm)	360		
	Lochkreis-Ø Pitch Circle Ø (mm)	275		
	Nabenbohrung-Ø Hub Bore Ø (mm)	230		
	Lochanzahl Number of Holes	8		
	Bremsbahn Brake Surface (mm)	209		
	Höhe Height (mm)	260		
	Durchmesser Diameter (mm)	360		
	Lochkreis-Ø Pitch Circle Ø (mm)	275		
	Nabenbohrung-Ø Hub Bore Ø (mm)	230		
Lochanzahl Number of Holes	8			
Bremsbahn Brake Surface (mm)	208			
Bremstrommel Brake Drum	Höhe Height (mm)	260		03.090.0252.210 Vergl.-Nr. Comp.No 03.105.90.02.0
passend für to fit to Bergische Achse	Durchmesser Diameter (mm)	360		
	Lochkreis-Ø Pitch Circle Ø (mm)	275		
	Nabenbohrung-Ø Hub Bore Ø (mm)	230		
	Lochanzahl Number of Holes	8		
	Bremsbahn Brake Surface (mm)	208		
	Höhe Height (mm)	221		
	Durchmesser Diameter (mm)	360		
	Lochkreis-Ø Pitch Circle Ø (mm)	275		
	Nabenbohrung-Ø Hub Bore Ø (mm)	230		
Lochanzahl Number of Holes	8			
Bremsbahn Brake Surface (mm)	189			

Bremstrommel | Brake Drum

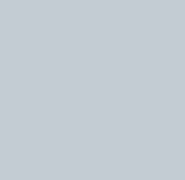
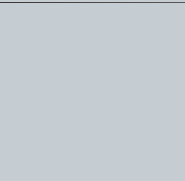
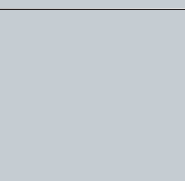

Bremstrommel Brake Drum passend für to fit to Bergische Achse	Höhe	238		03.090.0252.230 Vergl.-Nr. Comp.No 03.106.67.44.0
	Height (mm)			
	Durchmesser	420		
	Diameter (mm)			
	Lochkreis-Ø	335		
	Pitch Circle Ø (mm)			
	Nabenbohrung-Ø	290		
	Hub Bore Ø (mm)			
	Lochanzahl	6		
	Number of Holes			
Bremsbahn	210			
Brake Surface (mm)				
Bremstrommel Brake Drum passend für to fit to Bergische Achse	Höhe	249		03.090.0252.240 Vergl.-Nr. Comp.No 03.106.67.71.0
	Height (mm)			
	Durchmesser	420		
	Diameter (mm)			
	Lochkreis-Ø	335		
	Pitch Circle Ø (mm)			
	Nabenbohrung-Ø	290		
	Hub Bore Ø (mm)			
	Lochanzahl	10		
	Number of Holes			
Bremsbahn	190			
Brake Surface (mm)				
Bremstrommel Brake Drum passend für to fit to Bergische Achse	Höhe	328		03.090.0252.250 Vergl.-Nr. Comp.No 03.106.67.01.0
	Height (mm)			
	Durchmesser	420		
	Diameter (mm)			
	Lochkreis-Ø	335		
	Pitch Circle Ø (mm)			
	Nabenbohrung-Ø	290		
	Hub Bore Ø (mm)			
	Lochanzahl	10		
	Number of Holes			
Bremsbahn	225			
Brake Surface (mm)				
Bremstrommel Brake Drum passend für to fit to Bergische Achse	Höhe	295		03.090.0252.260 Vergl.-Nr. Comp.No 03.105.46.01.0
	Height (mm)			
	Durchmesser	300		
	Diameter (mm)			
	Lochkreis-Ø	225		
	Pitch Circle Ø (mm)			
	Nabenbohrung-Ø	190		
	Hub Bore Ø (mm)			
	Lochanzahl	10		
	Number of Holes			
Bremsbahn	220			
Brake Surface (mm)				

BG-03.090



Bremstrommel Brake Drum



Bremstrommel | Brake Drum

Bremstrommel Brake Drum	Höhe Height (mm)	285		03.090.0252.270 Vergl.-Nr. Comp.No 03.109.77.18.0
passend für to fit to Bergische Achse	Durchmesser Diameter (mm)	420		
	Lochkreis-Ø Pitch Circle Ø (mm)	290		
	Nabenbohrung-Ø Hub Bore Ø (mm)	335		
	Lochanzahl Number of Holes	10		
	Bremsbahn Brake Surface (mm)	217		
	Höhe Height (mm)	259		
	Durchmesser Diameter (mm)	420		
	Lochkreis-Ø Pitch Circle Ø (mm)	290		
	Nabenbohrung-Ø Hub Bore Ø (mm)	335		
Lochanzahl Number of Holes	10			
Bremsbahn Brake Surface (mm)	214			
Bremstrommel Brake Drum	Höhe Height (mm)	293,5		03.090.0252.280 Vergl.-Nr. Comp.No 03.109.77.17.0
passend für to fit to Bergische Achse	Durchmesser Diameter (mm)	420		
	Lochkreis-Ø Pitch Circle Ø (mm)	335		
	Nabenbohrung-Ø Hub Bore Ø (mm)	290		
	Lochanzahl Number of Holes	10		
	Bremsbahn Brake Surface (mm)	212		
	Höhe Height (mm)	230		
	Durchmesser Diameter (mm)	360		
	Lochkreis-Ø Pitch Circle Ø (mm)	275		
	Nabenbohrung-Ø Hub Bore Ø (mm)	226		
Lochanzahl Number of Holes	10			
Bremsbahn Brake Surface (mm)	180			

Bremstrommel | Brake Drum

Bremstrommel Brake Drum passend für to fit to DAF	Einbauseite	Vorderachse		03.090.0279.010 Vergl.-Nr. Comp.No 094 903
	Fitting Position	Front Axle		
	Höhe	228		
	Height (mm)			
	Durchmesser	420		
	Diameter (mm)			
	Lochkreis-Ø	335		
	Pitch Circle Ø (mm)			
	Nabenbohrung-Ø	285		
	Hub Bore Ø (mm)			
Lochanzahl	10		03.090.0279.020 Vergl.-Nr. Comp.No 365 579	
Number of Holes				
Bremsbahn	163			
Brake Surface (mm)				
Einbauseite	Hinterachse			
Fitting Position	Rear Axle			
Höhe	288			
Height (mm)				
Durchmesser	420			
Diameter (mm)				
Lochkreis-Ø	335			
Pitch Circle Ø (mm)				
Nabenbohrung-Ø	285			
Hub Bore Ø (mm)				
Lochanzahl	10		03.090.0279.030 Vergl.-Nr. Comp.No 638 167	
Number of Holes				
Bremsbahn	216			
Brake Surface (mm)				
Einbauseite	Vorderachse			
Fitting Position	Front Axle			
Höhe	230			
Height (mm)				
Durchmesser	419			
Diameter (mm)				
Lochkreis-Ø	335			
Pitch Circle Ø (mm)				
Nabenbohrung-Ø	285			
Hub Bore Ø (mm)				
Lochanzahl	10			
Number of Holes				
Bremsbahn	165			
Brake Surface (mm)				

BG-03.090



Bremstrommel Brake Drum

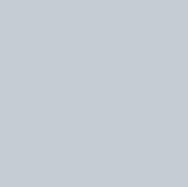
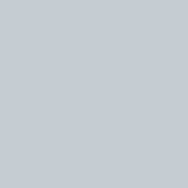

Bremstrommel | Brake Drum

Bremstrommel Brake Drum passend für to fit to DAF	Einbauseite	Hinterachse		03.090.0279.040 Vergl.-Nr. Comp.No 0754 397
	Fitting Position	Rear Axle		
	Höhe	288		
	Height (mm)			
	Durchmesser	420		
	Diameter (mm)			
	Lochkreis-Ø	335		
	Pitch Circle Ø (mm)			
	Nabenbohrung-Ø	285		
	Hub Bore Ø (mm)			
Lochanzahl	10			
Number of Holes				
Bremsbahn	213			
Brake Surface (mm)				
Bremstrommel Brake Drum passend für to fit to DAF	Einbauseite	Vorderachse		03.090.0279.050 Vergl.-Nr. Comp.No 090 500
	Fitting Position	Front Axle		
	Höhe	240		
	Height (mm)			
	Durchmesser	420		
	Diameter (mm)			
	Lochkreis-Ø	335		
	Pitch Circle Ø (mm)			
	Nabenbohrung-Ø	285		
	Hub Bore Ø (mm)			
Lochanzahl	10			
Number of Holes				
Bremsbahn	185			
Brake Surface (mm)				
Bremstrommel Brake Drum passend für to fit to DAF	Einbauseite	Hinterachse		03.090.0279.060 Vergl.-Nr. Comp.No 0161 518
	Fitting Position	Rear Axle		
	Höhe	262		
	Height (mm)			
	Durchmesser	419		
	Diameter (mm)			
	Lochkreis-Ø	335		
	Pitch Circle Ø (mm)			
	Nabenbohrung-Ø	285		
	Hub Bore Ø (mm)			
Lochanzahl	10			
Number of Holes				
Bremsbahn	193			
Brake Surface (mm)				

Bremstrommel | Brake Drum

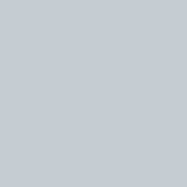

Bremstrommel Brake Drum passend für to fit to DAF	Einbauseite	Hinterachse		03.090.0279.070 Vergl.-Nr. Comp.No 395 247
	Fitting Position	Rear Axle		
	Höhe	315		
	Height (mm)			
	Durchmesser	420		
	Diameter (mm)			
	Lochkreis-Ø	335		
	Pitch Circle Ø (mm)			
	Nabenbohrung-Ø	285		
	Hub Bore Ø (mm)			
Lochanzahl	10			
Number of Holes				
Bremsbahn	250			
Brake Surface (mm)				
Bremstrommel Brake Drum passend für to fit to DAF	Einbauseite	Hinterachse		03.090.0279.080 Vergl.-Nr. Comp.No 595 222
	Fitting Position	Rear Axle		
	Höhe	284		
	Height (mm)			
	Durchmesser	420		
	Diameter (mm)			
	Lochkreis-Ø	335		
	Pitch Circle Ø (mm)			
	Nabenbohrung-Ø	285		
	Hub Bore Ø (mm)			
	Lochanzahl	10		
	Number of Holes			
	Lochanzahl 1	2		
	No. of holes 1			
Lochanzahl 2	2			
No. of holes 2				
Bremsbahn	225			
Brake Surface (mm)				
Bremstrommel Brake Drum passend für to fit to DAF	Höhe	252		03.090.0279.090 Vergl.-Nr. Comp.No 1232 806
	Height (mm)			
	Durchmesser	420		
	Diameter (mm)			
	Lochkreis-Ø	335		
	Pitch Circle Ø (mm)			
	Nabenbohrung-Ø	285		
	Hub Bore Ø (mm)			
	Lochanzahl	10		
	Number of Holes			
	Lochanzahl 1	2		
	No. of holes 1			
	Lochanzahl 2	2		
No. of holes 2				
Bremsbahn	192			
Brake Surface (mm)				

BG-03.090

Bremstrommel Brake Drum



Bremstrommel | Brake Drum

Bremstrommel Brake Drum	Höhe Height (mm)	256		03.090.0290.600 Vergl.-Nr. Comp.No M003176			
passend für to fit to SMB	Durchmesser Diameter (mm)	419					
	Lochkreis-Ø Pitch Circle Ø (mm)	335					
	Nabenbohrung-Ø Hub Bore Ø (mm)	288					
	Lochanzahl Number of Holes	10					
	Lochanzahl 1 No. of holes 1	2					
	Lochanzahl 2 No. of holes 2	2					
	Bremsbahn Brake Surface (mm)	212					
	Bremstrommel Brake Drum	Höhe Height (mm)			238		03.090.0290.610 Vergl.-Nr. Comp.No M068445
	passend für to fit to SMB	Durchmesser Diameter (mm)			419		
		Lochkreis-Ø Pitch Circle Ø (mm)			335		
		Nabenbohrung-Ø Hub Bore Ø (mm)			280		
		Lochanzahl Number of Holes			10		
Bremsbahn Brake Surface (mm)		214					
Bremstrommel Brake Drum		Höhe Height (mm)	272		03.090.0290.920 Vergl.-Nr. Comp.No 31270		
passend für to fit to Fruehauf		Durchmesser Diameter (mm)	419				
		Lochkreis-Ø Pitch Circle Ø (mm)	335				
		Nabenbohrung-Ø Hub Bore Ø (mm)	288				
		Lochanzahl Number of Holes	10				
		Lochanzahl 1 No. of holes 1	2				
		Bremsbahn Brake Surface (mm)	192				

Bremstrommel | Brake Drum

Bremstrommel Brake Drum passend für to fit to Fruehauf	Höhe	228		03.090.0291.000 Vergl.-Nr. Comp.No A-30026
	Height (mm)			
	Durchmesser	419		
	Diameter (mm)			
	Lochkreis-Ø	335		
	Pitch Circle Ø (mm)			
	Nabenbohrung-Ø	288		
	Hub Bore Ø (mm)			
	Lochanzahl	10		
	Number of Holes			
Lochanzahl 1	2			
No. of holes 1				
Bremsbahn	190			
Brake Surface (mm)				
Bremstrommel Brake Drum passend für to fit to Kässbohrer	Höhe	300		03.090.0601.000 Vergl.-Nr. Comp.No 016.26.52.312.01
	Height (mm)			
	Durchmesser	300		
	Diameter (mm)			
	Lochkreis-Ø	225		
	Pitch Circle Ø (mm)			
	Nabenbohrung-Ø	185		
	Hub Bore Ø (mm)			
	Lochanzahl	10		
	Number of Holes			
Bremsbahn	216			
Brake Surface (mm)				
Bremstrommel Brake Drum passend für to fit to Kässbohrer	Höhe	266		03.090.0601.010 Vergl.-Nr. Comp.No 015.26.85.111.15 B
	Height (mm)			
	Durchmesser	400		
	Diameter (mm)			
	Lochkreis-Ø	335		
	Pitch Circle Ø (mm)			
	Nabenbohrung-Ø	290		
	Hub Bore Ø (mm)			
	Lochanzahl	10		
	Number of Holes			
Bremsbahn	215			
Brake Surface (mm)				

BG-03.090



Bremstrommel Brake Drum



Bremstrommel | Brake Drum

Bremstrommel Brake Drum	Einbauseite Fitting Position	Hinterachse Rear Axle		03.090.0601.020	
passend für to fit to Kässbohrer	Höhe Height (mm)	260		Vergl.-Nr. Comp.No 107.25.20.150.06	
	Durchmesser Diameter (mm)	420			
	Lochkreis-Ø Pitch Circle Ø (mm)	335			
	Nabenbohrung-Ø Hub Bore Ø (mm)	290			
	Lochanzahl Number of Holes	10			
	Lochanzahl 1 No. of holes 1	2			
	Bremsbahn Brake Surface (mm)	190			
Bremstrommel Brake Drum	Einbauseite Fitting Position	Vorderachse Front Axle			03.090.0601.030
passend für to fit to Kässbohrer	Höhe Height (mm)	236			Vergl.-Nr. Comp.No 179.24.11.113.06
	Durchmesser Diameter (mm)	410			
	Lochkreis-Ø Pitch Circle Ø (mm)	335			
	Nabenbohrung-Ø Hub Bore Ø (mm)	290			
	Lochanzahl Number of Holes	10			
	Bremsbahn Brake Surface (mm)	170			
Bremstrommel Brake Drum	Einbauseite Fitting Position	Hinterachse Rear Axle			03.090.0601.040
passend für to fit to Kässbohrer	Höhe Height (mm)	281			Vergl.-Nr. Comp.No 179.25.20.114.11
	Durchmesser Diameter (mm)	410			
	Lochkreis-Ø Pitch Circle Ø (mm)	335			
	Nabenbohrung-Ø Hub Bore Ø (mm)	290			
	Lochanzahl Number of Holes	10			
	Bremsbahn Brake Surface (mm)	230			

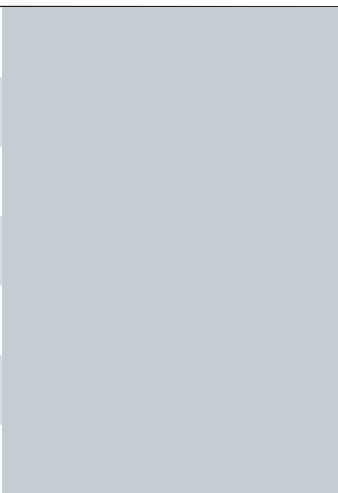
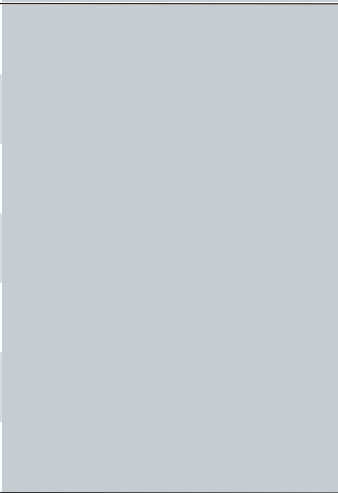
Bremstrommel | Brake Drum

Bremstrommel Brake Drum passend für to fit to Kässbohrer	Höhe	291		03.090.0601.050 Vergl.-Nr. Comp.No 315.25.20.122.01
	Height (mm)			
	Durchmesser	410		
	Diameter (mm)			
	Lochkreis-Ø	335		
	Pitch Circle Ø (mm)			
	Nabenbohrung-Ø	290		
	Hub Bore Ø (mm)			
	Lochanzahl	10		
	Number of Holes			
	Lochanzahl 1	2		
No. of holes 1				
Bremsbahn	230			
Brake Surface (mm)				
Bremstrommel Brake Drum passend für to fit to Kässbohrer	Einbauseite	Hinterachse		03.090.0601.060 Vergl.-Nr. Comp.No 179.25.20.112.07
	Fitting Position	Rear Axle		
	Höhe	260		
	Height (mm)			
	Durchmesser	410		
	Diameter (mm)			
	Lochkreis-Ø	335		
	Pitch Circle Ø (mm)			
	Nabenbohrung-Ø	290		
	Hub Bore Ø (mm)			
	Lochanzahl	10		
Number of Holes				
Bremsbahn	190			
Brake Surface (mm)				
Bremstrommel Brake Drum passend für to fit to Neoplan	Höhe	275		03.090.0710.700 Vergl.-Nr. Comp.No 8.252.0191.74
	Height (mm)			
	Durchmesser	410		
	Diameter (mm)			
	Lochkreis-Ø	335		
	Pitch Circle Ø (mm)			
	Nabenbohrung-Ø	282		
	Hub Bore Ø (mm)			
	Lochanzahl	10		
	Number of Holes			
	Bremsbahn	235		
Brake Surface (mm)				

BG-03.090

Bremstrommel Brake Drum



Bremstrommel | Brake Drum

Bremstrommel Brake Drum	Einbauseite Fitting Position	Vorderachse Front Axle		03.090.0710.710	
passend für to fit to Neoplan	Höhe Height (mm)	220		Vergl.-Nr. Comp.No 3416 4068	
	Durchmesser Diameter (mm)	410			
	Lochkreis-Ø Pitch Circle Ø (mm)	335			
	Nabenbohrung-Ø Hub Bore Ø (mm)	298			
	Lochanzahl Number of Holes	10			
	Lochanzahl 1 No. of holes 1	2			
	Lochanzahl 2 No. of holes 2	2			
	Bremsbahn Brake Surface (mm)	169			
Bremstrommel Brake Drum	Höhe Height (mm)	258			03.090.0809.010
passend für to fit to Iveco	Durchmesser Diameter (mm)	410			Vergl.-Nr. Comp.No 7172 079
	Lochkreis-Ø Pitch Circle Ø (mm)	335			
	Nabenbohrung-Ø Hub Bore Ø (mm)	285			
	Lochanzahl Number of Holes	10			
	Lochanzahl 1 No. of holes 1	2			
	Lochanzahl 2 No. of holes 2	2			
	Bremsbahn Brake Surface (mm)	210			

Bremstrommel | Brake Drum



Bremstrommel Brake Drum passend für to fit to Iveco	Einbauseite	Vorderachse		03.090.0809.020 Vergl.-Nr. Comp.No 7163 802
	Fitting Position	Front Axle		
	Höhe	243		
	Height (mm)			
	Durchmesser	381		
	Diameter (mm)			
	Lochkreis-Ø	335		
	Pitch Circle Ø (mm)			
	Nabenbohrung-Ø	285		
	Hub Bore Ø (mm)			
	Lochanzahl	10		
	Number of Holes			
	Lochanzahl 1	2		
	No. of holes 1			
Lochanzahl 2	2			
No. of holes 2				
Bremsbahn	190			
Brake Surface (mm)				
Bremstrommel Brake Drum passend für to fit to Iveco	Höhe	273		03.090.0809.030 Vergl.-Nr. Comp.No 4211 8426
	Height (mm)			
	Durchmesser	410		
	Diameter (mm)			
	Lochkreis-Ø	335		
	Pitch Circle Ø (mm)			
	Nabenbohrung-Ø	285		
	Hub Bore Ø (mm)			
	Lochanzahl	10		
	Number of Holes			
	Lochanzahl 1	2		
	No. of holes 1			
	Lochanzahl 2	2		
	No. of holes 2			
Bremsbahn	203			
Brake Surface (mm)				

BG-03.090

Bremstrommel Brake Drum



Bremstrommel | Brake Drum

Bremstrommel Brake Drum passend für to fit to Iveco	Einbauseite Fitting Position	Hinterachse Rear Axle		03.090.0809.040 Vergl.-Nr. Comp.No 0247 9853				
	Höhe Height (mm)	272						
	Durchmesser Diameter (mm)	381						
	Lochkreis-Ø Pitch Circle Ø (mm)	335						
	Nabenbohrung-Ø Hub Bore Ø (mm)	285						
	Lochanzahl Number of Holes	10						
	Lochanzahl 1 No. of holes 1	2						
	Bremsbahn Brake Surface (mm)	192						
	Bremstrommel Brake Drum passend für to fit to Iveco				Einbauseite Fitting Position	Hinterachse Rear Axle		03.090.0809.050 Vergl.-Nr. Comp.No 0717 2329
	Höhe Height (mm)	250						
	Durchmesser Diameter (mm)	410						
	Lochkreis-Ø Pitch Circle Ø (mm)	335						
Nabenbohrung-Ø Hub Bore Ø (mm)	285							
Lochanzahl Number of Holes	10							
Lochanzahl 1 No. of holes 1	2							
Lochanzahl 2 No. of holes 2	2							
Bremsbahn Brake Surface (mm)	193							
Bremstrommel Brake Drum passend für to fit to Iveco		Einbauseite Fitting Position	Hinterachse Rear Axle		03.090.0809.060 Vergl.-Nr. Comp.No 4211 8427			
Höhe Height (mm)	283							
Durchmesser Diameter (mm)	410							
Lochkreis-Ø Pitch Circle Ø (mm)	335							
Nabenbohrung-Ø Hub Bore Ø (mm)	285							
Lochanzahl Number of Holes	10							
Bremsbahn Brake Surface (mm)	206							

Bremstrommel | Brake Drum

Bremstrommel Brake Drum passend für to fit to Iveco	Einbauseite	Vorderachse	03.090.0809.110	
	Fitting Position	Front Axle		
	Höhe	235		Vergl.-Nr. Comp.No 0717 3281
	Height (mm)			
	Durchmesser	381		
	Diameter (mm)			
	Lochkreis-Ø	335		
	Pitch Circle Ø (mm)			
	Nabenbohrung-Ø	285		
	Hub Bore Ø (mm)			
Lochanzahl	10			
Number of Holes				
Bremsbahn	190			
Brake Surface (mm)				
Bremstrommel Brake Drum passend für to fit to Iveco	Einbauseite	Hinterachse	03.090.0809.120	
	Fitting Position	Rear Axle		
	Höhe	255		Vergl.-Nr. Comp.No 0718 3046
	Height (mm)			
	Durchmesser	410		
	Diameter (mm)			
	Lochkreis-Ø	335		
	Pitch Circle Ø (mm)			
	Nabenbohrung-Ø	285		
	Hub Bore Ø (mm)			
Lochanzahl	10			
Number of Holes				
Bremsbahn	205			
Brake Surface (mm)				
Bremstrommel Brake Drum passend für to fit to Iveco	Einbauseite	Vorderachse	03.090.0809.130	
	Fitting Position	Front Axle		
	Höhe	289		Vergl.-Nr. Comp.No 0718 3050
	Height (mm)			
	Durchmesser	410		
	Diameter (mm)			
	Lochkreis-Ø	335		
	Pitch Circle Ø (mm)			
	Nabenbohrung-Ø	285		
	Hub Bore Ø (mm)			
Lochanzahl	10			
Number of Holes				
Bremsbahn	205			
Brake Surface (mm)				

BG-03.090

Bremstrommel Brake Drum



Bremstrommel | Brake Drum

Bremstrommel Brake Drum	Einbauseite Fitting Position	Hinterachse Rear Axle		03.090.0809.140
passend für to fit to Iveco	Höhe Height (mm)	222		Vergl.-Nr. Comp.No 8601 7939
	Durchmesser Diameter (mm)	325		
	Lochkreis-Ø Pitch Circle Ø (mm)	245		
	Nabenbohrung-Ø Hub Bore Ø (mm)	207		
	Lochanzahl Number of Holes	6		
	Bremsbahn Brake Surface (mm)	155		
Bremstrommel Brake Drum	Einbauseite Fitting Position	Vorderachse Front Axle		03.090.0809.150
passend für to fit to Iveco	Höhe Height (mm)	235		Vergl.-Nr. Comp.No 0247 5817
	Durchmesser Diameter (mm)	381		
	Lochkreis-Ø Pitch Circle Ø (mm)	335		
	Nabenbohrung-Ø Hub Bore Ø (mm)	285		
	Lochanzahl Number of Holes	10		
	Bremsbahn Brake Surface (mm)	381		
Bremstrommel Brake Drum	Einbauseite Fitting Position	Vorderachse Front Axle		03.090.0919.010
passend für to fit to MAN	Höhe Height (mm)	232		Vergl.-Nr. Comp.No 81.50110.0214
	Durchmesser Diameter (mm)	410		
	Lochkreis-Ø Pitch Circle Ø (mm)	335		
	Nabenbohrung-Ø Hub Bore Ø (mm)	298		
	Lochanzahl Number of Holes	10		
	Lochanzahl 1 No. of holes 1	3		
	Bremsbahn Brake Surface (mm)	187		

Bremstrommel | Brake Drum



Bremstrommel Brake Drum passend für to fit to MAN	Einbauseite	Hinterachse		03.090.0919.020 Vergl.-Nr. Comp.No 81.50110.0104
	Fitting Position	Rear Axle		
	Höhe	300		
	Height (mm)			
	Durchmesser	410		
	Diameter (mm)			
	Lochkreis-Ø	335		
	Pitch Circle Ø (mm)			
	Nabenbohrung-Ø	298		
	Hub Bore Ø (mm)			
	Lochanzahl	10		
	Number of Holes			
	Lochanzahl 1	5		
	No. of holes 1			
Lochanzahl 2	3			
No. of holes 2				
Bremsbahn	232			
Brake Surface (mm)				
Bremstrommel Brake Drum passend für to fit to MAN	Einbauseite	Hinterachse		03.090.0919.030 Vergl.-Nr. Comp.No 81.50110.0175
	Fitting Position	Rear Axle		
	Höhe	191		
	Height (mm)			
	Durchmesser	325		
	Diameter (mm)			
	Lochkreis-Ø	245		
	Pitch Circle Ø (mm)			
	Nabenbohrung-Ø	204		
	Hub Bore Ø (mm)			
	Lochanzahl	6		
	Number of Holes			
	Lochanzahl 1	2		
	No. of holes 1			
Bremsbahn	157			
Brake Surface (mm)				

BG-03.090

Bremstrommel Brake Drum



Bremstrommel | Brake Drum

Bremstrommel Brake Drum passend für to fit to MAN	Einbauseite Fitting Position	Hinterachse Rear Axle		03.090.0919.100 Vergl.-Nr. Comp.No 81.50110.0101
	Höhe Height (mm)	270		
	Durchmesser Diameter (mm)	410		
	Lochkreis-Ø Pitch Circle Ø (mm)	335		
	Nabenbohrung-Ø Hub Bore Ø (mm)	298		
	Lochanzahl Number of Holes	10		
	Lochanzahl 1 No. of holes 1	5		
	Lochanzahl 2 No. of holes 2	3		
	Bremsbahn Brake Surface (mm)	192		
	Nabenbohrung-Ø 1 Hub Bore Ø 1 (mm)	369		
	Höhe Height (mm)	164		
	Durchmesser Diameter (mm)	410		
	Lochkreis-Ø Pitch Circle Ø (mm)	370		
	Nabenbohrung-Ø Hub Bore Ø (mm)	340		
	Lochanzahl Number of Holes	12		
Bremsbahn Brake Surface (mm)	148			
Bremstrommel Brake Drum passend für to fit to MAN	Einbauseite Fitting Position	Hinterachse Rear Axle		03.090.0919.120 Vergl.-Nr. Comp.No 51.50110.0212
	Höhe Height (mm)	242		
	Durchmesser Diameter (mm)	360		
	Lochkreis-Ø Pitch Circle Ø (mm)	275		
	Nabenbohrung-Ø Hub Bore Ø (mm)	230		
	Lochanzahl Number of Holes	8		
	Lochanzahl 1 No. of holes 1	2		
	Bremsbahn Brake Surface (mm)	175		

Bremstrommel | Brake Drum

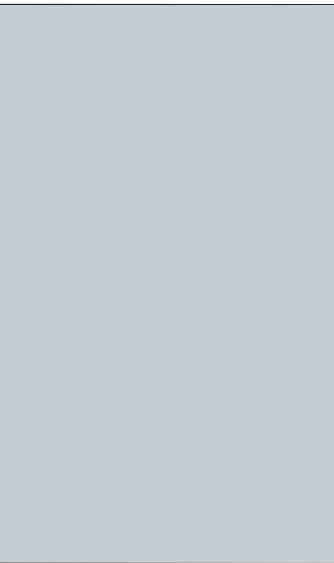
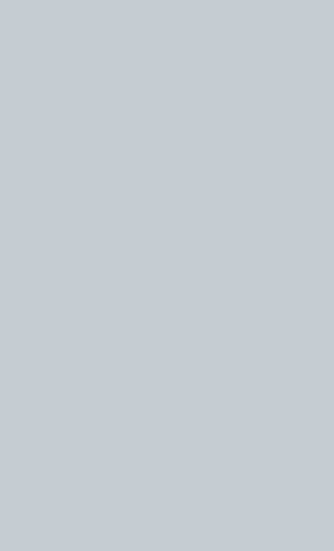
<p>Bremstrommel Brake Drum</p> <p>passend für to fit to MAN</p>	Einbauseite Fitting Position	Hinterachse Rear Axle		<p>03.090.0919.130</p> <p>Vergl.-Nr. Comp.No 81.50110.0216</p>
	Höhe Height (mm)	198		
	Durchmesser Diameter (mm)	360		
	Lochkreis-Ø Pitch Circle Ø (mm)	275		
	Nabenbohrung-Ø Hub Bore Ø (mm)	230		
	Lochanzahl Number of Holes	8		
	Lochanzahl 1 No. of holes 1	2		
	Bremsbahn Brake Surface (mm)	155		
	<p>Bremstrommel Brake Drum</p> <p>passend für to fit to MAN</p>	Einbauseite Fitting Position		
Höhe Height (mm)		247		
Durchmesser Diameter (mm)		360		
Lochkreis-Ø Pitch Circle Ø (mm)		275		
Nabenbohrung-Ø Hub Bore Ø (mm)		230		
Lochanzahl Number of Holes		8		
Lochanzahl 1 No. of holes 1		2		
Bremsbahn Brake Surface (mm)		185		
<p>Bremstrommel Brake Drum</p> <p>passend für to fit to MAN</p>		Einbauseite Fitting Position	Hinterachse Rear Axle	
	Höhe Height (mm)	167		
	Durchmesser Diameter (mm)	325		
	Lochkreis-Ø Pitch Circle Ø (mm)	245		
	Nabenbohrung-Ø Hub Bore Ø (mm)	204		
	Lochanzahl Number of Holes	6		
	Lochanzahl 1 No. of holes 1	3		
	Bremsbahn Brake Surface (mm)	107		

BG-03.090



Bremstrommel Brake Drum



Bremstrommel | Brake Drum

Bremstrommel Brake Drum	Einbauseite Fitting Position	Hinterachse Rear Axle	03.090.0919.160 Vergl.-Nr. Comp.No 81.50110.0233		
passend für to fit to MAN	Höhe Height (mm)	208			
	Durchmesser Diameter (mm)	325			
	Lochkreis-Ø Pitch Circle Ø (mm)	245			
	Nabenbohrung-Ø Hub Bore Ø (mm)	204			
	Lochanzahl Number of Holes	6			
	Bremsbahn Brake Surface (mm)	156			
	Bremstrommel Brake Drum	Einbauseite Fitting Position		Hinterachse Rear Axle	03.090.0919.170 Vergl.-Nr. Comp.No
	passend für to fit to MAN; Neoplan	Höhe Height (mm)		261,5	
		Durchmesser Diameter (mm)		420	
		Lochkreis-Ø Pitch Circle Ø (mm)		335	
Nabenbohrung-Ø Hub Bore Ø (mm)		290			
Lochanzahl Number of Holes		10			
Lochanzahl 1 No. of holes 1		2			
Bremsbahn Brake Surface (mm)		188			
Bremstrommel Brake Drum		Einbauseite Fitting Position	Hinterachse Rear Axle	03.090.1940.000 Vergl.-Nr. Comp.No 601 423 51 01	
passend für to fit to Mercedes-Benz		Höhe Height (mm)	73		
		Durchmesser Diameter (mm)	230		
	Lochkreis-Ø Pitch Circle Ø (mm)	130			
	Nabenbohrung-Ø Hub Bore Ø (mm)	85			
	Lochanzahl Number of Holes	5			
	Bremsbahn Brake Surface (mm)	43			

Bremstrommel | Brake Drum



<p>Bremstrommel Brake Drum</p> <p>passend für to fit to Mercedes-Benz</p>	Einbauseite Fitting Position	Hinterachse Rear Axle		<p>03.090.1940.010</p> <p>Vergl.-Nr. Comp.No 301 423 08 01</p>
	Höhe Height (mm)	306		
	Durchmesser Diameter (mm)	410		
	Lochkreis-Ø Pitch Circle Ø (mm)	335		
	Nabenbohrung-Ø Hub Bore Ø (mm)	298		
	Lochanzahl Number of Holes	10		
	Bremsbahn Brake Surface (mm)	238		
<p>Bremstrommel Brake Drum</p> <p>passend für to fit to Mercedes-Benz</p>	Einbauseite Fitting Position	Hinterachse Rear Axle		<p>03.090.1940.020</p> <p>Vergl.-Nr. Comp.No 305 423 03 01</p>
	Höhe Height (mm)	306		
	Durchmesser Diameter (mm)	410		
	Lochkreis-Ø Pitch Circle Ø (mm)	335		
	Nabenbohrung-Ø Hub Bore Ø (mm)	298		
	Lochanzahl Number of Holes	10		
	Bremsbahn Brake Surface (mm)	238		
<p>Bremstrommel Brake Drum</p> <p>passend für to fit to Mercedes-Benz</p>	Einbauseite Fitting Position	Vorderachse Front Axle		<p>03.090.1940.030</p> <p>Vergl.-Nr. Comp.No 305 421 01 01</p>
	Höhe Height (mm)	213		
	Durchmesser Diameter (mm)	410		
	Lochkreis-Ø Pitch Circle Ø (mm)	335		
	Nabenbohrung-Ø Hub Bore Ø (mm)	298		
	Lochanzahl Number of Holes	10		
	Lochanzahl 1 No. of holes 1	2		
	Lochanzahl 2 No. of holes 2	3		
	Bremsbahn Brake Surface (mm)	167		

BG-03.090

Bremstrommel Brake Drum



Bremstrommel | Brake Drum

Bremstrommel Brake Drum	Einbauseite Fitting Position	Vorderachse Front Axle		03.090.1940.040		
passend für to fit to Mercedes-Benz	Höhe Height (mm)	179		Vergl.-Nr. Comp.No 675 334 01 04		
	Durchmesser Diameter (mm)	308				
	Lochkreis-Ø Pitch Circle Ø (mm)	205				
	Lochanzahl Number of Holes	6				
	Bremsbahn Brake Surface (mm)	130				
Bremstrommel Brake Drum	Einbauseite Fitting Position	Vorderachse Front Axle		03.090.1940.050		
passend für to fit to Mercedes-Benz	Höhe Height (mm)	237		Vergl.-Nr. Comp.No 658 421 00 01		
	Durchmesser Diameter (mm)	410				
	Lochkreis-Ø Pitch Circle Ø (mm)	335				
	Nabenbohrung-Ø Hub Bore Ø (mm)	298				
	Lochanzahl Number of Holes	10				
	Bremsbahn Brake Surface (mm)	181				
Bremstrommel Brake Drum	Einbauseite Fitting Position	Vorderachse Front Axle		03.090.1940.051		
passend für to fit to Mercedes-Benz	Höhe Height (mm)	237		Vergl.-Nr. Comp.No 624 421 02 01		
	Durchmesser Diameter (mm)	410				
	Lochkreis-Ø Pitch Circle Ø (mm)	335				
	Nabenbohrung-Ø Hub Bore Ø (mm)	298				
	Lochanzahl Number of Holes	10				
	Lochanzahl 1 No. of holes 1	3				
	Bremsbahn Brake Surface (mm)	191				

Bremstrommel | Brake Drum



<p>Bremstrommel Brake Drum</p> <p>passend für to fit to Mercedes-Benz</p>	Einbauseite Fitting Position	Hinterachse Rear Axle		<p>03.090.1940.060</p> <p>Vergl.-Nr. Comp.No 674 356 06 02</p>			
	Höhe Height (mm)	296					
	Durchmesser Diameter (mm)	308					
	Lochkreis-Ø Pitch Circle Ø (mm)	205					
	Lochanzahl Number of Holes	6					
	Bremsbahn Brake Surface (mm)	147					
	Einbauseite Fitting Position				Vorderachse Front Axle		<p>03.090.1940.070</p> <p>Vergl.-Nr. Comp.No 675 334 04 04</p>
	Höhe Height (mm)	187					
	Durchmesser Diameter (mm)	308					
	Lochkreis-Ø Pitch Circle Ø (mm)	205					
Lochanzahl Number of Holes	6						
Bremsbahn Brake Surface (mm)	143						
Einbauseite Fitting Position		Vorderachse Front Axle		<p>03.090.1940.080</p> <p>Vergl.-Nr. Comp.No 677 421 02 01</p>			
Höhe Height (mm)	193						
Durchmesser Diameter (mm)	364						
Lochkreis-Ø Pitch Circle Ø (mm)	275						
Nabenbohrung-Ø Hub Bore Ø (mm)	238						
Lochanzahl Number of Holes	8						
Bremsbahn Brake Surface (mm)	142						

BG-03.090



Bremstrommel Brake Drum



Bremstrommel | Brake Drum

Bremstrommel Brake Drum	Einbauseite Fitting Position	Hinterachse Rear Axle		03.090.1940.090					
passend für to fit to Mercedes-Benz	Höhe Height (mm)	260			Vergl.-Nr. Comp.No 387 421 02 01				
	Durchmesser Diameter (mm)	410							
	Lochkreis-Ø Pitch Circle Ø (mm)	335							
	Nabenbohrung-Ø Hub Bore Ø (mm)	298							
	Lochanzahl Number of Holes	10							
	Lochanzahl 1 No. of holes 1	5							
	Lochanzahl 2 No. of holes 2	3							
	Bremsbahn Brake Surface (mm)	193							
	Einbauseite Fitting Position	Vorderachse Front Axle					03.090.1940.100		
	passend für to fit to Mercedes-Benz	Höhe Height (mm)					250		Vergl.-Nr. Comp.No 346 421 03 01
		Durchmesser Diameter (mm)					410		
		Lochkreis-Ø Pitch Circle Ø (mm)					335		
		Nabenbohrung-Ø Hub Bore Ø (mm)					298		
Lochanzahl Number of Holes		10							
Lochanzahl 1 No. of holes 1		5							
Lochanzahl 2 No. of holes 2		3							
Bremsbahn Brake Surface (mm)		172							
Nabenbohrung-Ø 1 Hub Bore Ø 1 (mm)		369							

Bremstrommel | Brake Drum

Bremstrommel Brake Drum passend für to fit to Mercedes-Benz	Einbauseite	Hinterachse		03.090.1940.110 Vergl.-Nr. Comp.No 346 423 00 01
	Fitting Position	Rear Axle		
	Höhe	270		
	Height (mm)			
	Durchmesser	410		
	Diameter (mm)			
	Lochkreis-Ø	335		
	Pitch Circle Ø (mm)			
	Nabenbohrung-Ø	298		
	Hub Bore Ø (mm)			
	Lochanzahl	5		
	Number of Holes			
	Lochanzahl 1	3		
	No. of holes 1			
	Lochanzahl 2	10		
No. of holes 2				
Bremsbahn	172			
Brake Surface (mm)				
Nabenbohrung-Ø 1	369			
Hub Bore Ø 1 (mm)				
Bremstrommel Brake Drum passend für to fit to Mercedes-Benz	Einbauseite	Hinterachse		03.090.1940.120 Vergl.-Nr. Comp.No 346 423 01 01
	Fitting Position	Rear Axle		
	Höhe	280		
	Height (mm)			
	Durchmesser	410		
	Diameter (mm)			
	Lochkreis-Ø	335		
	Pitch Circle Ø (mm)			
	Nabenbohrung-Ø	298		
	Hub Bore Ø (mm)			
	Lochanzahl	10		
	Number of Holes			
	Lochanzahl 1	5		
	No. of holes 1			
	Bremsbahn	192		
Brake Surface (mm)				

BG-03.090



Bremstrommel Brake Drum



Bremstrommel | Brake Drum

Bremstrommel Brake Drum	Einbauseite Fitting Position	Hinterachse Rear Axle		03.090.1940.130 Vergl.-Nr. Comp.No 381 423 01 01			
passend für to fit to Mercedes-Benz	Höhe Height (mm)	270					
	Durchmesser Diameter (mm)	410					
	Lochkreis-Ø Pitch Circle Ø (mm)	335					
	Nabenbohrung-Ø Hub Bore Ø (mm)	298					
	Lochanzahl Number of Holes	10					
	Bremsbahn Brake Surface (mm)	152					
	Einbauseite Fitting Position	Hinterachse Rear Axle				03.090.1940.140 Vergl.-Nr. Comp.No 381 423 00 01	
	Bremstrommel Brake Drum	Höhe Height (mm)					280
	passend für to fit to Mercedes-Benz	Durchmesser Diameter (mm)					410
Lochkreis-Ø Pitch Circle Ø (mm)		335					
Nabenbohrung-Ø Hub Bore Ø (mm)		298					
Lochanzahl Number of Holes		10					
Lochanzahl 1 No. of holes 1		5					
Bremsbahn Brake Surface (mm)		172					
Einbauseite Fitting Position		Hinterachse Rear Axle		03.090.1940.150 Vergl.-Nr. Comp.No 385 423 03 01			
Bremstrommel Brake Drum		Höhe Height (mm)					248
passend für to fit to Mercedes-Benz		Durchmesser Diameter (mm)			410		
	Lochkreis-Ø Pitch Circle Ø (mm)	335					
	Nabenbohrung-Ø Hub Bore Ø (mm)	298					
	Lochanzahl Number of Holes	10					
	Bremsbahn Brake Surface (mm)	172					

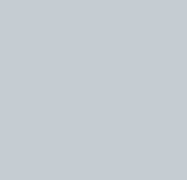
Bremstrommel | Brake Drum

Bremstrommel Brake Drum passend für to fit to Mercedes-Benz	Einbauseite	Hinterachse		03.090.1940.160 Vergl.-Nr. Comp.No 385 423 05 01
	Fitting Position	Rear Axle		
	Höhe	290		
	Height (mm)			
	Durchmesser	410		
	Diameter (mm)			
	Lochkreis-Ø	335		
	Pitch Circle Ø (mm)			
	Nabenbohrung-Ø	298		
	Hub Bore Ø (mm)			
Lochanzahl	10			
Number of Holes				
Bremsbahn	172			
Brake Surface (mm)				
Bremstrommel Brake Drum passend für to fit to Mercedes-Benz	Einbauseite	Hinterachse		03.090.1940.170 Vergl.-Nr. Comp.No 305 423 07 01
	Fitting Position	Rear Axle		
	Höhe	306		
	Height (mm)			
	Durchmesser	410		
	Diameter (mm)			
	Lochkreis-Ø	335		
	Pitch Circle Ø (mm)			
	Nabenbohrung-Ø	298		
	Hub Bore Ø (mm)			
Lochanzahl	10			
Number of Holes				
Bremsbahn	241			
Brake Surface (mm)				
Bremstrommel Brake Drum passend für to fit to Mercedes-Benz	Einbauseite	Hinterachse		03.090.1940.180 Vergl.-Nr. Comp.No 301 423 01 01
	Fitting Position	Rear Axle		
	Höhe	238		
	Height (mm)			
	Durchmesser	410		
	Diameter (mm)			
	Lochkreis-Ø	335		
	Pitch Circle Ø (mm)			
	Nabenbohrung-Ø	298		
	Hub Bore Ø (mm)			
Lochanzahl	10			
Number of Holes				
Bremsbahn	172			
Brake Surface (mm)				

BG-03.090



Bremstrommel Brake Drum



Bremstrommel | Brake Drum

Bremstrommel Brake Drum	Einbauseite Fitting Position	Hinterachse Rear Axle		03.090.1940.190 Vergl.-Nr. Comp.No 677 421 05 01			
passend für to fit to Mercedes-Benz	Höhe Height (mm)	210					
	Durchmesser Diameter (mm)	364					
	Lochkreis-Ø Pitch Circle Ø (mm)	275					
	Nabenbohrung-Ø Hub Bore Ø (mm)	238					
	Lochanzahl Number of Holes	8					
	Bremsbahn Brake Surface (mm)	172					
	Einbauseite Fitting Position	Vorderachse Front Axle				03.090.1940.230 Vergl.-Nr. Comp.No 301 421 01 01	
	Bremstrommel Brake Drum	Höhe Height (mm)					192
	passend für to fit to Mercedes-Benz	Durchmesser Diameter (mm)					410
Lochkreis-Ø Pitch Circle Ø (mm)		335					
Nabenbohrung-Ø Hub Bore Ø (mm)		298					
Lochanzahl Number of Holes		10					
Bremsbahn Brake Surface (mm)		150					
Einbauseite Fitting Position		Hinterachse Rear Axle		03.090.1940.240 Vergl.-Nr. Comp.No 301 423 12 01			
Bremstrommel Brake Drum		Höhe Height (mm)					306
passend für to fit to Mercedes-Benz		Durchmesser Diameter (mm)					410
		Lochkreis-Ø Pitch Circle Ø (mm)			335		
	Nabenbohrung-Ø Hub Bore Ø (mm)	298					
	Lochanzahl Number of Holes	10					
	Bremsbahn Brake Surface (mm)	238					

Bremstrommel | Brake Drum

<p>Bremstrommel Brake Drum</p> <p>passend für to fit to Mercedes-Benz</p>	Einbauseite Fitting Position	Hinterachse Rear Axle		<p>03.090.1940.250</p> <p>Vergl.-Nr. Comp.No 302 423 00 01</p>
	Höhe Height (mm)	215		
	Durchmesser Diameter (mm)	418		
	Lochkreis-Ø Pitch Circle Ø (mm)	275		
	Nabenbohrung-Ø Hub Bore Ø (mm)	230		
	Lochanzahl Number of Holes	8		
	Bremsbahn Brake Surface (mm)	150		
<p>Bremstrommel Brake Drum</p> <p>passend für to fit to Mercedes-Benz</p>	Einbauseite Fitting Position	Vorderachse Front Axle		<p>03.090.1940.260</p> <p>Vergl.-Nr. Comp.No 305 421 00 01</p>
	Höhe Height (mm)	228		
	Durchmesser Diameter (mm)	410		
	Lochkreis-Ø Pitch Circle Ø (mm)	335		
	Nabenbohrung-Ø Hub Bore Ø (mm)	298		
	Lochanzahl Number of Holes	10		
	Bremsbahn Brake Surface (mm)	172		
<p>Bremstrommel Brake Drum</p> <p>passend für to fit to Mercedes-Benz</p>	Einbauseite Fitting Position	Hinterachse Rear Axle		<p>03.090.1940.270</p> <p>Vergl.-Nr. Comp.No 316 356 01 02</p>
	Höhe Height (mm)	288		
	Durchmesser Diameter (mm)	300		
	Lochkreis-Ø Pitch Circle Ø (mm)	205		
	Lochanzahl Number of Holes	6		
	Bremsbahn Brake Surface (mm)	145		

BG-03.090



Bremstrommel Brake Drum



Bremstrommel | Brake Drum

Bremstrommel Brake Drum	Einbauseite Fitting Position	Hinterachse Rear Axle		03.090.1940.280
passend für to fit to Mercedes-Benz	Höhe Height (mm)	204		Vergl.-Nr. Comp.No 320 423 01 01
	Durchmesser Diameter (mm)	440		
	Lochkreis-Ø Pitch Circle Ø (mm)	380		
	Nabenbohrung-Ø Hub Bore Ø (mm)	350		
	Lochanzahl Number of Holes	12		
	Bremsbahn Brake Surface (mm)	180		
Bremstrommel Brake Drum	Einbauseite Fitting Position	Vorderachse Front Axle		03.090.1940.290
passend für to fit to Mercedes-Benz	Höhe Height (mm)	190		Vergl.-Nr. Comp.No 335 421 03 01
	Durchmesser Diameter (mm)	430		
	Lochkreis-Ø Pitch Circle Ø (mm)	400		
	Nabenbohrung-Ø Hub Bore Ø (mm)	373		
	Lochanzahl Number of Holes	12		
	Lochanzahl 1 No. of holes 1	2		
	Bremsbahn Brake Surface (mm)	160		
Bremstrommel Brake Drum	Einbauseite Fitting Position	Vorderachse Front Axle		03.090.1940.300
passend für to fit to Mercedes-Benz	Höhe Height (mm)	226		Vergl.-Nr. Comp.No 352 421 00 01
	Durchmesser Diameter (mm)	418		
	Lochkreis-Ø Pitch Circle Ø (mm)	275		
	Nabenbohrung-Ø Hub Bore Ø (mm)	230		
	Lochanzahl Number of Holes	8		

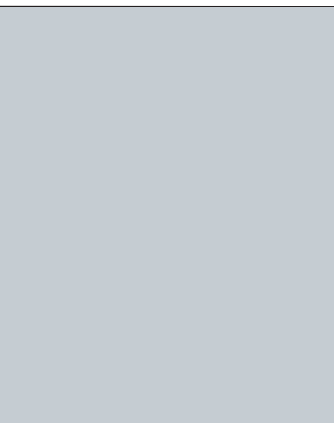
Bremstrommel | Brake Drum

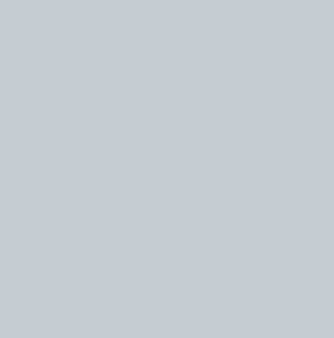
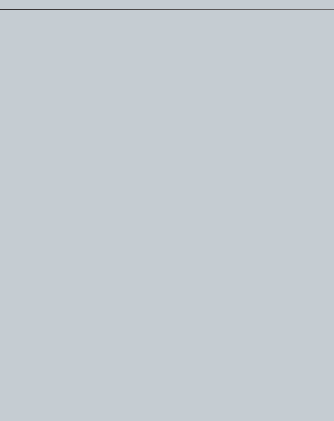
<p>Bremstrommel Brake Drum</p> <p>passend für to fit to Mercedes-Benz</p>	Einbauseite Fitting Position	Vorderachse Front Axle		<p>03.090.1940.310</p> <p>Vergl.-Nr. Comp.No 360 421 06 01</p>
	Höhe Height (mm)	218		
	Durchmesser Diameter (mm)	410		
	Lochkreis-Ø Pitch Circle Ø (mm)	335		
	Nabenbohrung-Ø Hub Bore Ø (mm)	298		
	Lochanzahl Number of Holes	10		
<p>Bremstrommel Brake Drum</p> <p>passend für to fit to Mercedes-Benz</p>	Einbauseite Fitting Position	Hinterachse Rear Axle		<p>03.090.1940.330</p> <p>Vergl.-Nr. Comp.No 673 356 12 02</p>
	Höhe Height (mm)	292		
	Durchmesser Diameter (mm)	308		
	Lochkreis-Ø Pitch Circle Ø (mm)	205		
	Lochanzahl Number of Holes	6		
	Bremsbahn Brake Surface (mm)	134		
<p>Bremstrommel Brake Drum</p> <p>passend für to fit to Mercedes-Benz</p>	Einbauseite Fitting Position	Hinterachse Rear Axle		<p>03.090.1940.340</p> <p>Vergl.-Nr. Comp.No 674 356 13 02</p>
	Höhe Height (mm)	296		
	Durchmesser Diameter (mm)	308		
	Lochkreis-Ø Pitch Circle Ø (mm)	205		
	Lochanzahl Number of Holes	6		
<p>Bremstrommel Brake Drum</p> <p>passend für to fit to Mercedes-Benz</p>	Einbauseite Fitting Position	Vorderachse Front Axle		<p>03.090.1940.350</p> <p>Vergl.-Nr. Comp.No 675 334 51 04</p>
	Höhe Height (mm)	187		
	Durchmesser Diameter (mm)	308		
	Lochkreis-Ø Pitch Circle Ø (mm)	205		
	Lochanzahl Number of Holes	6		
	Bremsbahn Brake Surface (mm)	144		

BG-03.090



Bremstrommel Brake Drum



Bremstrommel | Brake Drum

Bremstrommel Brake Drum	Höhe Height (mm)	171		03.090.1940.360	
passend für to fit to Mercedes-Benz	Durchmesser Diameter (mm)	308		Vergl.-Nr. Comp.No 675 334 56 04	
	Lochkreis-Ø Pitch Circle Ø (mm)	205			
	Lochanzahl Number of Holes	6			
	Bremsbahn Brake Surface (mm)	130			
	Einbauseite Fitting Position	Hinterachse Rear Axle			
	Höhe Height (mm)	289			Vergl.-Nr. Comp.No 674 356 16 02
	Durchmesser Diameter (mm)	308			
Lochkreis-Ø Pitch Circle Ø (mm)	205				
Lochanzahl Number of Holes	6				
Bremsbahn Brake Surface (mm)	132				
Bremstrommel Brake Drum	Höhe Height (mm)	251		03.090.1940.380	
passend für to fit to Mercedes-Benz	Durchmesser Diameter (mm)	364		Vergl.-Nr. Comp.No 677 421 03 01	
	Lochkreis-Ø Pitch Circle Ø (mm)	275			
	Lochanzahl Number of Holes	8			
	Bremsbahn Brake Surface (mm)	210			
	Nabenbohrung-Ø 1 Hub Bore Ø 1 (mm)	238			
	Höhe Height (mm)	179			
	Durchmesser Diameter (mm)	430			Vergl.-Nr. Comp.No 335 421 02 01
Lochkreis-Ø Pitch Circle Ø (mm)	380				
Lochanzahl Number of Holes	6				
Bremsbahn Brake Surface (mm)	153				

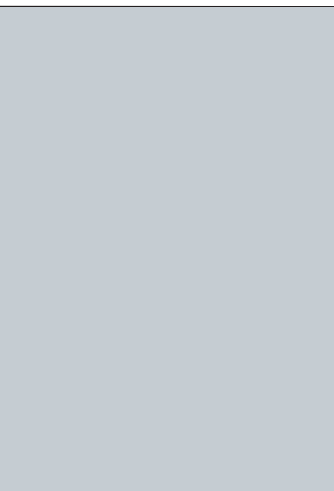
Bremstrommel | Brake Drum



Bremstrommel Brake Drum passend für to fit to Mercedes-Benz	Einbauseite	Hinterachse		03.090.1940.400 Vergl.-Nr. Comp.No 335 423 01 01
	Fitting Position	Rear Axle		
	Höhe	220		
	Height (mm)			
	Durchmesser	440		
	Diameter (mm)			
	Lochkreis-Ø	400		
	Pitch Circle Ø (mm)			
	Lochanzahl	12		
	Number of Holes			
Bremsbahn	188			
Brake Surface (mm)				
Nabenbohrung-Ø 1	372			
Hub Bore Ø 1 (mm)				
Bremstrommel Brake Drum passend für to fit to Mercedes-Benz	Höhe	178,50		03.090.1940.410 Vergl.-Nr. Comp.No 674 334 19 04
	Height (mm)			
	Durchmesser	308		
	Diameter (mm)			
	Lochkreis-Ø	205		
	Pitch Circle Ø (mm)			
	Nabenbohrung-Ø	230		
	Hub Bore Ø (mm)			
	Lochanzahl	6		
	Number of Holes			
Bremsbahn	130			
Brake Surface (mm)				
Bremstrommel Brake Drum passend für to fit to SAF	Höhe	279		03.090.2500.000 Vergl.-Nr. Comp.No 1.064.0223.00
	Height (mm)			
	Durchmesser	355		
	Diameter (mm)			
	Lochkreis-Ø	225		
	Pitch Circle Ø (mm)			
	Nabenbohrung-Ø	190		
	Hub Bore Ø (mm)			
	Lochanzahl	10		
	Number of Holes			
Bremsbahn	211			
Brake Surface (mm)				

BG-03.090

Bremstrommel Brake Drum



Bremstrommel | Brake Drum

Bremstrommel Brake Drum	Höhe Height (mm)	255		03.090.2500.010 Vergl.-Nr. Comp.No 1.064.0261.01
passend für to fit to SAF	Durchmesser Diameter (mm)	420		
	Lochkreis-Ø Pitch Circle Ø (mm)	335		
	Nabenbohrung-Ø Hub Bore Ø (mm)	290		
	Lochanzahl Number of Holes	10		
	Bremsbahn Brake Surface (mm)	212		
	Höhe Height (mm)	227		
	Durchmesser Diameter (mm)	420		
	Lochkreis-Ø Pitch Circle Ø (mm)	335		
	Nabenbohrung-Ø Hub Bore Ø (mm)	290		
Lochanzahl Number of Holes	10			
Bremsbahn Brake Surface (mm)	192			
Bremstrommel Brake Drum	Höhe Height (mm)	227		03.090.2500.020 Vergl.-Nr. Comp.No 1.064.0060.02
passend für to fit to SAF	Durchmesser Diameter (mm)	420		
	Lochkreis-Ø Pitch Circle Ø (mm)	335		
	Nabenbohrung-Ø Hub Bore Ø (mm)	290		
	Lochanzahl Number of Holes	10		
	Bremsbahn Brake Surface (mm)	192		
	Höhe Height (mm)	227		
	Durchmesser Diameter (mm)	420		
	Lochkreis-Ø Pitch Circle Ø (mm)	335		
	Nabenbohrung-Ø Hub Bore Ø (mm)	290		
Lochanzahl Number of Holes	10			
Bremsbahn Brake Surface (mm)	192			
Bremstrommel Brake Drum	Höhe Height (mm)	227		03.090.2500.030 Vergl.-Nr. Comp.No 1.064.0236.00
passend für to fit to SAF	Durchmesser Diameter (mm)	420		
	Lochkreis-Ø Pitch Circle Ø (mm)	335		
	Nabenbohrung-Ø Hub Bore Ø (mm)	290		
	Lochanzahl Number of Holes	10		
	Lochanzahl 1 No. of holes 1	4		
	Bremsbahn Brake Surface (mm)	192		
	Höhe Height (mm)	227		
	Durchmesser Diameter (mm)	420		
	Lochkreis-Ø Pitch Circle Ø (mm)	335		
Nabenbohrung-Ø Hub Bore Ø (mm)	290			



Bremstrommel Brake Drum			
Bremstrommel Brake Drum passend für to fit to SAF	Höhe	227	 <p>03.090.2500.040</p> <p>Vergl.-Nr. Comp.No 1.064.0260.01</p>
	Height (mm)		
	Durchmesser	420	
	Diameter (mm)		
	Lochkreis-Ø	335	
	Pitch Circle Ø (mm)		
	Nabenbohrung-Ø	300	
	Hub Bore Ø (mm)		
	Lochanzahl	10	
	Number of Holes		
Bremsbahn	194		
Brake Surface (mm)			
Bremstrommel Brake Drum passend für to fit to SAF	Höhe	280	 <p>03.090.2500.050</p> <p>Vergl.-Nr. Comp.No 1.064.0197.00</p>
	Height (mm)		
	Durchmesser	300	
	Diameter (mm)		
	Lochkreis-Ø	225	
	Pitch Circle Ø (mm)		
	Nabenbohrung-Ø	190	
	Hub Bore Ø (mm)		
	Lochanzahl	10	
	Number of Holes		
Bremsbahn	210		
Brake Surface (mm)			
Bremstrommel Brake Drum passend für to fit to SAF	Höhe	255	 <p>03.090.2500.070</p> <p>Vergl.-Nr. Comp.No 1.064.0108.01</p>
	Height (mm)		
	Durchmesser	420	
	Diameter (mm)		
	Lochkreis-Ø	335	
	Pitch Circle Ø (mm)		
	Nabenbohrung-Ø	290	
	Hub Bore Ø (mm)		
	Lochanzahl	10	
	Number of Holes		
Bremsbahn	212		
Brake Surface (mm)			
Bremstrommel Brake Drum passend für to fit to SAF	Höhe	225	 <p>03.090.2500.080</p> <p>Vergl.-Nr. Comp.No 1.064.0280.00</p>
	Height (mm)		
	Durchmesser	367	
	Diameter (mm)		
	Lochkreis-Ø	275	
	Pitch Circle Ø (mm)		
	Nabenbohrung-Ø	240	
	Hub Bore Ø (mm)		
	Lochanzahl	8	
	Number of Holes		
Bremsbahn	194		
Brake Surface (mm)			

BG-03.090



Bremstrommel Brake Drum



Bremstrommel | Brake Drum

Bremstrommel Brake Drum	Höhe Height (mm)	280		03.090.2500.090 Vergl.-Nr. Comp.No 1 064 0273 00			
passend für to fit to SAF	Durchmesser Diameter (mm)	300					
	Lochkreis-Ø Pitch Circle Ø (mm)	225					
	Nabenbohrung-Ø Hub Bore Ø (mm)	190					
	Lochanzahl Number of Holes	10					
	Bremsbahn Brake Surface (mm)	210					
	Höhe Height (mm)	280				03.090.2500.100 Vergl.-Nr. Comp.No 1.064.0218.00	
	Bremstrommel Brake Drum	Durchmesser Diameter (mm)					355
	passend für to fit to SAF	Lochkreis-Ø Pitch Circle Ø (mm)					275
		Nabenbohrung-Ø Hub Bore Ø (mm)					230
Lochanzahl Number of Holes		8					
Bremsbahn Brake Surface (mm)		210					
Höhe Height (mm)		255		03.090.2500.110 Vergl.-Nr. Comp.No 1.064.0270.00			
Bremstrommel Brake Drum		Durchmesser Diameter (mm)					420
passend für to fit to SAF		Lochkreis-Ø Pitch Circle Ø (mm)					335
		Nabenbohrung-Ø Hub Bore Ø (mm)					300
		Lochanzahl Number of Holes			10		
	Bremsbahn Brake Surface (mm)	217					
	Höhe Height (mm)	260				03.090.2500.120 Vergl.-Nr. Comp.No 1.064.0277.00	
	Bremstrommel Brake Drum	Durchmesser Diameter (mm)					367
	passend für to fit to SAF	Lochkreis-Ø Pitch Circle Ø (mm)					275
		Nabenbohrung-Ø Hub Bore Ø (mm)					240
		Lochanzahl Number of Holes	8				
Bremsbahn Brake Surface (mm)		210					

Bremstrommel | Brake Drum

Bremstrommel Brake Drum passend für to fit to SAF	Höhe	258		03.090.2500.130 Vergl.-Nr. Comp.No 1.064.0278.00
	Height (mm)			
	Durchmesser	367		
	Diameter (mm)			
	Lochkreis-Ø	225		
	Pitch Circle Ø (mm)			
	Nabenbohrung-Ø	190		
	Hub Bore Ø (mm)			
	Lochanzahl	10		
	Number of Holes			
Bremsbahn	210			
Brake Surface (mm)				
Bremstrommel Brake Drum passend für to fit to SAF	Höhe	280		03.090.2500.150 Vergl.-Nr. Comp.No 1.064.0149.00
	Height (mm)			
	Durchmesser	300		
	Diameter (mm)			
	Lochkreis-Ø	225		
	Pitch Circle Ø (mm)			
	Nabenbohrung-Ø	190		
	Hub Bore Ø (mm)			
	Lochanzahl	10		
	Number of Holes			
Bremsbahn	212			
Brake Surface (mm)				
Bremstrommel Brake Drum passend für to fit to Scania	Einbauseite	Hinterachse		03.090.3002.000 Vergl.-Nr. Comp.No 1 414 153
	Fitting Position	Rear Axle		
	Höhe	276		
	Height (mm)			
	Durchmesser	413		
	Diameter (mm)			
	Lochkreis-Ø	335		
	Pitch Circle Ø (mm)			
	Nabenbohrung-Ø	295		
	Hub Bore Ø (mm)			
	Lochanzahl	10		
	Number of Holes			
	Lochanzahl 1	3		
	No. of holes 1			
Lochanzahl 2	2			
No. of holes 2				
Bremsbahn	213			
Brake Surface (mm)				

BG-03.090



Bremstrommel Brake Drum



Bremstrommel | Brake Drum

Bremstrommel Brake Drum	Einbauseite Fitting Position	Vorderachse Front Axle		03.090.3002.010
passend für to fit to Scania	Höhe Height (mm)	221		Vergl.-Nr. Comp.No 360 564
	Durchmesser Diameter (mm)	413		
	Lochkreis-Ø Pitch Circle Ø (mm)	335		
	Nabenbohrung-Ø Hub Bore Ø (mm)	295		
	Lochanzahl Number of Holes	10		
	Bremsbahn Brake Surface (mm)	138		
Bremstrommel Brake Drum	Einbauseite Fitting Position	Hinterachse Rear Axle		03.090.3002.020
passend für to fit to Scania	Höhe Height (mm)	321		Vergl.-Nr. Comp.No 360 573
	Durchmesser Diameter (mm)	413		
	Lochkreis-Ø Pitch Circle Ø (mm)	335		
	Nabenbohrung-Ø Hub Bore Ø (mm)	295		
	Lochanzahl Number of Holes	10		
	Lochanzahl 1 No. of holes 1	3		
	Lochanzahl 2 No. of holes 2	2		
	Bremsbahn Brake Surface (mm)	266		

Bremstrommel | Brake Drum



<p>Bremstrommel Brake Drum</p> <p>passend für to fit to Scania</p>	Einbauseite	Vorderachse		<p>03.090.3002.030</p> <p>Vergl.-Nr. Comp.No 392 390</p>
	Fitting Position	Front Axle		
	Höhe	252		
	Height (mm)			
	Durchmesser	413		
	Diameter (mm)			
	Lochkreis-Ø	335		
	Pitch Circle Ø (mm)			
	Nabenbohrung-Ø	295		
	Hub Bore Ø (mm)			
	Lochanzahl	10		
	Number of Holes			
	Lochanzahl 1	3		
	No. of holes 1			
Lochanzahl 2	2			
No. of holes 2				
Bremsbahn	190			
Brake Surface (mm)				
<p>Bremstrommel Brake Drum</p> <p>passend für to fit to Scania</p>	Einbauseite	Hinterachse		<p>03.090.3002.040</p> <p>Vergl.-Nr. Comp.No 360 572</p>
	Fitting Position	Rear Axle		
	Höhe	296		
	Height (mm)			
	Durchmesser	413		
	Diameter (mm)			
	Lochkreis-Ø	335		
	Pitch Circle Ø (mm)			
	Nabenbohrung-Ø	295		
	Hub Bore Ø (mm)			
	Lochanzahl	10		
	Number of Holes			
	Bremsbahn	210		
	Brake Surface (mm)			
<p>Bremstrommel Brake Drum</p> <p>passend für to fit to Scania</p>	Einbauseite	Hinterachse		<p>03.090.3002.050</p> <p>Vergl.-Nr. Comp.No 1 414 152</p>
	Fitting Position	Rear Axle		
	Höhe	263		
	Height (mm)			
	Durchmesser	413		
	Diameter (mm)			
	Lochkreis-Ø	335		
	Pitch Circle Ø (mm)			
	Nabenbohrung-Ø	295		
	Hub Bore Ø (mm)			
	Lochanzahl	10		
	Number of Holes			
	Bremsbahn	190		
	Brake Surface (mm)			

BG-03.090

Bremstrommel Brake Drum

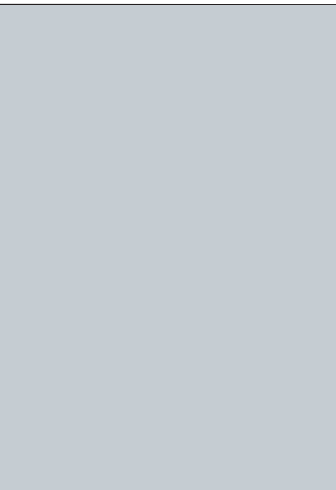
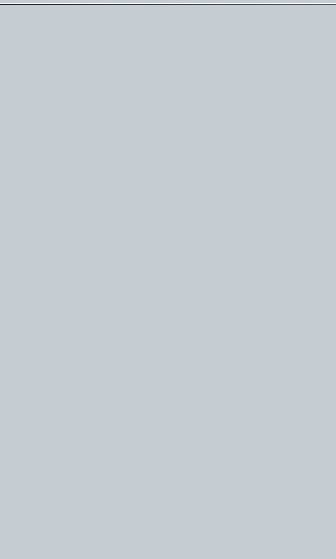

Bremstrommel | Brake Drum

Bremstrommel Brake Drum passend für to fit to Scania	Einbauseite Fitting Position	Hinterachse Rear Axle		03.090.3002.060 Vergl.-Nr. Comp.No 360 570		
	Höhe Height (mm)	263				
	Durchmesser Diameter (mm)	413				
	Lochkreis-Ø Pitch Circle Ø (mm)	335				
	Nabenbohrung-Ø Hub Bore Ø (mm)	295				
	Lochanzahl Number of Holes	10				
	Bremsbahn Brake Surface (mm)	189				
	Einbauseite Fitting Position	Hinterachse Rear Axle				03.090.3002.070 Vergl.-Nr. Comp.No 360 571
	Höhe Height (mm)	276				
	Durchmesser Diameter (mm)	413				
Lochkreis-Ø Pitch Circle Ø (mm)	335					
Nabenbohrung-Ø Hub Bore Ø (mm)	295					
Lochanzahl Number of Holes	10					
Lochanzahl 1 No. of holes 1	3					
Bremsbahn Brake Surface (mm)	216					
Einbauseite Fitting Position	Vorderachse Front Axle		03.090.3002.080 Vergl.-Nr. Comp.No 392 391			
Höhe Height (mm)	263					
Durchmesser Diameter (mm)	413					
Lochkreis-Ø Pitch Circle Ø (mm)	335					
Nabenbohrung-Ø Hub Bore Ø (mm)	295					
Lochanzahl Number of Holes	10					
Lochanzahl 1 No. of holes 1	3					
Bremsbahn Brake Surface (mm)	189					

Bremstrommel | Brake Drum



Bremstrommel Brake Drum passend für to fit to Trailer	Höhe	225		03.090.3504.920 Vergl.-Nr. Comp.No
	Height (mm)			
	Durchmesser	419		
	Diameter (mm)			
	Lochkreis-Ø	335		
	Pitch Circle Ø (mm)			
	Nabenbohrung-Ø	290		
	Hub Bore Ø (mm)			
	Lochanzahl	10		
	Number of Holes			
Bremsbahn	182			
Brake Surface (mm)				
Bremstrommel Brake Drum passend für to fit to Trailer	Höhe	266		03.090.3505.020 Vergl.-Nr. Comp.No
	Height (mm)			
	Durchmesser	419		
	Diameter (mm)			
	Lochkreis-Ø	335		
	Pitch Circle Ø (mm)			
	Nabenbohrung-Ø	290		
	Hub Bore Ø (mm)			
	Lochanzahl	10		
	Number of Holes			
Bremsbahn	210			
Brake Surface (mm)				
Bremstrommel Brake Drum passend für to fit to Trailer	Höhe	210		03.090.3505.030 Vergl.-Nr. Comp.No
	Height (mm)			
	Durchmesser	419		
	Diameter (mm)			
	Lochkreis-Ø	275		
	Pitch Circle Ø (mm)			
	Nabenbohrung-Ø	230		
	Hub Bore Ø (mm)			
	Lochanzahl	8		
	Number of Holes			
Bremsbahn	186			
Brake Surface (mm)				

BG-03.090

Bremstrommel Brake Drum



Bremstrommel | Brake Drum

Bremstrommel Brake Drum passend für to fit to Volvo	Einbauseite	Vorderachse		03.090.4004.000 Vergl.-Nr. Comp.No 1599 009
	Fitting Position	Front Axle		
	Höhe	262		
	Height (mm)			
	Durchmesser	410		
	Diameter (mm)			
	Lochkreis-Ø	335		
	Pitch Circle Ø (mm)			
	Nabenbohrung-Ø	282		
	Hub Bore Ø (mm)			
Lochanzahl	10			
Number of Holes				
Bremsbahn	190			
Brake Surface (mm)				
Bremstrommel Brake Drum passend für to fit to Volvo	Einbauseite	Vorderachse		03.090.4004.010 Vergl.-Nr. Comp.No 1599 010
	Fitting Position	Front Axle		
	Höhe	274		
	Height (mm)			
	Durchmesser	410		
	Diameter (mm)			
	Lochkreis-Ø	335		
	Pitch Circle Ø (mm)			
	Nabenbohrung-Ø	282		
	Hub Bore Ø (mm)			
Lochanzahl	10			
Number of Holes				
Bremsbahn	205			
Brake Surface (mm)				
Bremstrommel Brake Drum passend für to fit to Volvo	Einbauseite	Hinterachse		03.090.4004.020 Vergl.-Nr. Comp.No 1599 012-2
	Fitting Position	Rear Axle		
	Höhe	306		
	Height (mm)			
	Durchmesser	410		
	Diameter (mm)			
	Lochkreis-Ø	335		
	Pitch Circle Ø (mm)			
	Nabenbohrung-Ø	282		
	Hub Bore Ø (mm)			
Lochanzahl	10			
Number of Holes				
Bremsbahn	230			
Brake Surface (mm)				

Bremstrommel | Brake Drum

<p>Bremstrommel Brake Drum</p> <p>passend für to fit to Volvo</p>	Einbauseite	Hinterachse		<p>03.090.4004.030</p> <p>Vergl.-Nr. Comp.No 1599 011</p>
	Fitting Position	Rear Axle		
	Höhe	295		
	Height (mm)			
	Durchmesser	410		
	Diameter (mm)			
	Lochkreis-Ø	335		
	Pitch Circle Ø (mm)			
	Nabenbohrung-Ø	282		
	Hub Bore Ø (mm)			
	Lochanzahl	10		
	Number of Holes			
	Lochanzahl 1	2		
	No. of holes 1			
Lochanzahl 2	2			
No. of holes 2				
Bremsbahn	217			
Brake Surface (mm)				
<p>Bremstrommel Brake Drum</p> <p>passend für to fit to Volvo</p>	Einbauseite	Vorderachse		<p>03.090.4004.040</p> <p>Vergl.-Nr. Comp.No 1599 678-8</p>
	Fitting Position	Front Axle		
	Höhe	249		
	Height (mm)			
	Durchmesser	410		
	Diameter (mm)			
	Lochkreis-Ø	335		
	Pitch Circle Ø (mm)			
	Nabenbohrung-Ø	282		
	Hub Bore Ø (mm)			
	Lochanzahl	10		
	Number of Holes			
	Lochanzahl 1	2		
	No. of holes 1			
Lochanzahl 2	2			
No. of holes 2				
Bremsbahn	180			
Brake Surface (mm)				

BG-03.090



Bremstrommel Brake Drum



Bremstrommel | Brake Drum

Bremstrommel Brake Drum	Einbauseite Fitting Position	Hinterachse Rear Axle		03.090.4004.050 Vergl.-Nr. Comp.No 1590 313/1
passend für to fit to Volvo	Höhe Height (mm)	314		
	Durchmesser Diameter (mm)	394		
	Lochkreis-Ø Pitch Circle Ø (mm)	335		
	Nabenbohrung-Ø Hub Bore Ø (mm)	282		
	Lochanzahl Number of Holes	10		
	Lochanzahl 1 No. of holes 1	2		
	Bremsbahn Brake Surface (mm)	265		
Bremstrommel Brake Drum	Einbauseite Fitting Position	Vorderachse Front Axle		03.090.4004.060 Vergl.-Nr. Comp.No 1134 817-4
passend für to fit to Volvo	Höhe Height (mm)	269		
	Durchmesser Diameter (mm)	394		
	Lochkreis-Ø Pitch Circle Ø (mm)	335		
	Nabenbohrung-Ø Hub Bore Ø (mm)	282		
	Lochanzahl Number of Holes	10		
	Lochanzahl 1 No. of holes 1	2		
	Lochanzahl 2 No. of holes 2	2		
	Bremsbahn Brake Surface (mm)	219		
Bremstrommel Brake Drum	Einbauseite Fitting Position	Hinterachse Rear Axle		03.090.4004.070 Vergl.-Nr. Comp.No 1599 014
passend für to fit to Volvo	Höhe Height (mm)	236		
	Durchmesser Diameter (mm)	410		
	Lochkreis-Ø Pitch Circle Ø (mm)	335		
	Nabenbohrung-Ø Hub Bore Ø (mm)	282		
	Lochanzahl Number of Holes	10		
	Bremsbahn Brake Surface (mm)	159		

Bremstrommel | Brake Drum

<p>Bremstrommel Brake Drum</p> <p>passend für to fit to Volvo</p>	Einbauseite Fitting Position	Hinterachse Rear Axle		<p>03.090.4004.080</p> <p>Vergl.-Nr. Comp.No 3171 748</p>
	Höhe Height (mm)	306		
	Durchmesser Diameter (mm)	410		
	Lochkreis-Ø Pitch Circle Ø (mm)	335		
	Nabenbohrung-Ø Hub Bore Ø (mm)	282		
	Lochanzahl Number of Holes	10		
	Lochanzahl 1 No. of holes 1	2		
	Bremsbahn Brake Surface (mm)	231		
	<p>Bremstrommel Brake Drum</p> <p>passend für to fit to Volvo</p>	Einbauseite Fitting Position		
Höhe Height (mm)		273		
Durchmesser Diameter (mm)		410		
Lochkreis-Ø Pitch Circle Ø (mm)		335		
Nabenbohrung-Ø Hub Bore Ø (mm)		282		
Lochanzahl Number of Holes		10		
Lochanzahl 1 No. of holes 1		2		
Bremsbahn Brake Surface (mm)		211		
<p>Bremstrommel Brake Drum</p> <p>passend für to fit to Volvo</p>		Einbauseite Fitting Position	Vorderachse Front Axle	
	Höhe Height (mm)	261		
	Durchmesser Diameter (mm)	410		
	Lochkreis-Ø Pitch Circle Ø (mm)	335		
	Nabenbohrung-Ø Hub Bore Ø (mm)	282		
	Lochanzahl Number of Holes	10		
	Lochanzahl 1 No. of holes 1	2		
	Bremsbahn Brake Surface (mm)	195		

BG-03.090

Bremstrommel Brake Drum

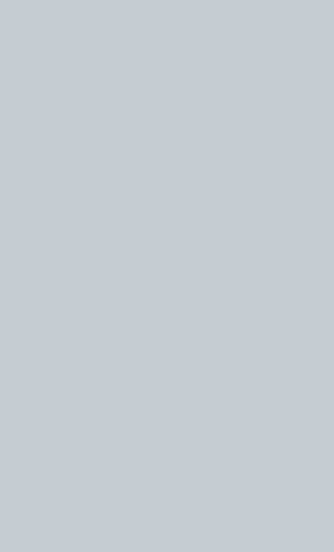
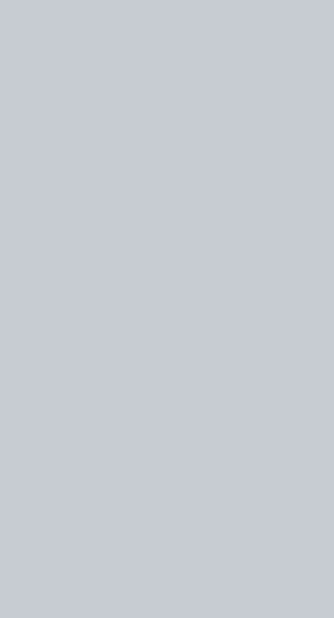

Bremstrommel | Brake Drum

Bremstrommel Brake Drum passend für to fit to Volvo	Einbauseite Fitting Position	Hinterachse Rear Axle		03.090.4004.110 Vergl.-Nr. Comp.No 3171 747
	Höhe Height (mm)	293		
	Durchmesser Diameter (mm)	410		
	Lochkreis-Ø Pitch Circle Ø (mm)	335		
	Nabenbohrung-Ø Hub Bore Ø (mm)	282		
	Lochanzahl Number of Holes	10		
	Bremsbahn Brake Surface (mm)	218		
Bremstrommel Brake Drum passend für to fit to Volvo	Einbauseite Fitting Position	Vorderachse Front Axle		03.090.4004.120 Vergl.-Nr. Comp.No 0352 786
	Höhe Height (mm)	240		
	Durchmesser Diameter (mm)	413		
	Lochkreis-Ø Pitch Circle Ø (mm)	335		
	Nabenbohrung-Ø Hub Bore Ø (mm)	282		
	Lochanzahl Number of Holes	10		
	Lochanzahl 1 No. of holes 1	2		
	Bremsbahn Brake Surface (mm)	163		
Bremstrommel Brake Drum passend für to fit to Volvo	Einbauseite Fitting Position	Hinterachse Rear Axle		03.090.4004.130 Vergl.-Nr. Comp.No 1589 429
	Höhe Height (mm)	305		
	Durchmesser Diameter (mm)	394		
	Lochkreis-Ø Pitch Circle Ø (mm)	335		
	Nabenbohrung-Ø Hub Bore Ø (mm)	282		
	Lochanzahl Number of Holes	10		
	Lochanzahl 1 No. of holes 1	2		
	Lochanzahl 2 No. of holes 2	2		
	Bremsbahn Brake Surface (mm)	250		

Bremstrommel | Brake Drum

Bremstrommel Brake Drum passend für to fit to Volvo	Einbauseite Fitting Position	Vorderachse Front Axle		03.090.4004.140 Vergl.-Nr. Comp.No 1577 439
	Höhe Height (mm)	253		
	Durchmesser Diameter (mm)	394		
	Lochkreis-Ø Pitch Circle Ø (mm)	335		
	Nabenbohrung-Ø Hub Bore Ø (mm)	282		
	Lochanzahl Number of Holes	10		
	Lochanzahl 1 No. of holes 1	2		
	Bremsbahn Brake Surface (mm)	191		
	Bremstrommel Brake Drum passend für to fit to Volvo	Einbauseite Fitting Position		
Höhe Height (mm)		276		
Durchmesser Diameter (mm)		394		
Lochkreis-Ø Pitch Circle Ø (mm)		286		
Nabenbohrung-Ø Hub Bore Ø (mm)		245		
Lochanzahl Number of Holes		10		
Bremsbahn Brake Surface (mm)		190		
Bremstrommel Brake Drum passend für to fit to Volvo		Einbauseite Fitting Position	Hinterachse Rear Axle	
	Höhe Height (mm)	282		
	Durchmesser Diameter (mm)	410		
	Lochkreis-Ø Pitch Circle Ø (mm)	335		
	Nabenbohrung-Ø Hub Bore Ø (mm)	282		
	Lochanzahl Number of Holes	10		
	Lochanzahl 1 No. of holes 1	2		
	Lochanzahl 2 No. of holes 2	2		
	Bremsbahn Brake Surface (mm)	202		

BG-03.090

Bremstrommel Brake Drum



Bremstrommel | Brake Drum

Bremstrommel Brake Drum	Höhe Height (mm)	247,5		03.090.4004.170 Vergl.-Nr. Comp.No 6772 133
passend für to fit to Volvo	Durchmesser Diameter (mm)	360		
	Lochkreis-Ø Pitch Circle Ø (mm)	275		
	Nabenbohrung-Ø Hub Bore Ø (mm)	228		
	Lochanzahl Number of Holes	8		
	Bremsbahn Brake Surface (mm)	186		
	Höhe Height (mm)	271		
	Durchmesser Diameter (mm)	419		
	Lochkreis-Ø Pitch Circle Ø (mm)	335		
	Nabenbohrung-Ø Hub Bore Ø (mm)	283		
Lochanzahl Number of Holes	10			
Bremsbahn Brake Surface (mm)	230			
passend für to fit to ROR	Höhe Height (mm)	260		
	Durchmesser Diameter (mm)	311		
	Lochkreis-Ø Pitch Circle Ø (mm)	225		
	Nabenbohrung-Ø Hub Bore Ø (mm)	183		
	Lochanzahl Number of Holes	10		
	Bremsbahn Brake Surface (mm)	201		
	Höhe Height (mm)	271		
	Durchmesser Diameter (mm)	419		
	Lochkreis-Ø Pitch Circle Ø (mm)	335		
	Nabenbohrung-Ø Hub Bore Ø (mm)	283		
Lochanzahl Number of Holes	10			
Bremsbahn Brake Surface (mm)	230			

Bremstrommel | Brake Drum

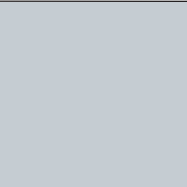
Bremstrommel Brake Drum passend für to fit to ROR	Höhe	238		03.090.4200.320 Vergl.-Nr. Comp.No 212 20 183
	Height (mm)			
	Durchmesser	419		
	Diameter (mm)			
	Lochkreis-Ø	335		
	Pitch Circle Ø (mm)			
	Nabenbohrung-Ø	283		
	Hub Bore Ø (mm)			
	Lochanzahl	10		
	Number of Holes			
	Lochanzahl 1	2		
	No. of holes 1			
	Lochanzahl 2	2		
No. of holes 2				
Bremsbahn	192			
Brake Surface (mm)				
Bremstrommel Brake Drum passend für to fit to ROR	Höhe	248		03.090.4200.330 Vergl.-Nr. Comp.No 210 18 986
	Height (mm)			
	Durchmesser	419		
	Diameter (mm)			
	Lochkreis-Ø	335		
	Pitch Circle Ø (mm)			
	Nabenbohrung-Ø	283		
	Hub Bore Ø (mm)			
	Lochanzahl	10		
	Number of Holes			
	Bremsbahn	230		
	Brake Surface (mm)			
	Bremstrommel Brake Drum passend für to fit to Renault	Höhe		
Height (mm)				
Durchmesser		414		
Diameter (mm)				
Lochkreis-Ø		335		
Pitch Circle Ø (mm)				
Nabenbohrung-Ø		281		
Hub Bore Ø (mm)				
Lochanzahl		2		
Number of Holes				
Lochanzahl 1		10		
No. of holes 1				
Lochanzahl 2		2		
No. of holes 2				
Bremsbahn	233			
Brake Surface (mm)				

BG-03.090

Bremstrommel Brake Drum



Bremstrommel | Brake Drum

Bremstrommel	Höhe	230		03.090.4251.000	
Brake Drum	Height (mm)				
passend für to fit to Renault	Durchmesser	414			Vergl.-Nr. Comp.No 5000737768
	Diameter (mm)				
	Lochkreis-Ø	335			
	Pitch Circle Ø (mm)				
	Nabenbohrung-Ø	281			
	Hub Bore Ø (mm)				
	Lochanzahl	10			
	Number of Holes				
	Lochanzahl 1	2			
	No. of holes 1				
	Lochanzahl 2	2			
	No. of holes 2				
	Bremsbahn	186			
	Brake Surface (mm)				

Radnabe | Wheel Hub









Radnabe	Achslast in Tonnen	8		11.030.0245.250
Wheel Hub	Axle Load in Tons (t)			
passend für to fit to Bergische Achse			Vergl.-Nr. Comp.No 03.272.30.05.0	
Radnabe	Achslast in Tonnen	10		11.030.0245.950
Wheel Hub	Axle Load in Tons (t)			
passend für to fit to Bergische Achse			Vergl.-Nr. Comp.No 03.272.48.32.0	
Radnabe	Gewindeart	Außengewinde		11.030.0246.170
Wheel Hub	Thread Type	Outer Thread		
passend für to fit to Bergische Achse	Achslast in Tonnen	9	Vergl.-Nr. Comp.No 03.272.30.81.0	
	Axle Load in Tons (t)			
Radnabe	Lochanzahl	10		11.030.0246.180
Wheel Hub	Number of Holes			
passend für to fit to Bergische Achse			Vergl.-Nr. Comp.No 03.272.30.41.0	
Radnabe	Achslast in Tonnen	8		11.030.0246.190
Wheel Hub	Axle Load in Tons (t)			
passend für to fit to Bergische Achse			Vergl.-Nr. Comp.No 03.272.30.31.0	

Radnabe Wheel Hub				
Radnabe Wheel Hub				11.030.0246.460 Vergl.-Nr. Comp.No 03.272.48.17.0
passend für to fit to Bergische Achse				
Radnabe Wheel Hub				11.030.0246.470 Vergl.-Nr. Comp.No 03.272.48.40.0
passend für to fit to Bergische Achse				
Radnabe Wheel Hub	Gewindeart Thread Type	Außengewinde Outer Thread		11.030.0246.950 Vergl.-Nr. Comp.No 03.272.48.78.0
passend für to fit to Bergische Achse				
Radnabe Wheel Hub				11.030.0290.290 Vergl.-Nr. Comp.No A-JB-0038-001
passend für to fit to Frühauf				
Radnabe Wheel Hub				11.030.1909.730 Vergl.-Nr. Comp.No 942 334 12 01
passend für to fit to Mercedes-Benz				
Radnabe Wheel Hub				11.030.2037.100 Vergl.-Nr. Comp.No 1.307.1129.01
passend für to fit to SAF				
Radnabe Wheel Hub				11.030.2246.000 Vergl.-Nr. Comp.No 3.307.3006.00
passend für to fit to SAF				
Radnabe Wheel Hub				11.030.2246.100 Vergl.-Nr. Comp.No 1.146.2004.02
passend für to fit to SAF				









BG-03.100

Radnabe Wheel Hub



Radnabe Wheel Hub		
Radnabe Wheel Hub		11.030.3504.100 Vergl.-Nr. Comp.No 6502795D
passend für to fit to Trailor		
Radnabe Wheel Hub		11.030.3504.270 Vergl.-Nr. Comp.No M006050
passend für to fit to Trailor		
Abdeckblech, Staubschutz-Radlager Cover Plate, dust-cover wheel bearing		
Abdeckblech, Staubschutz-Radlager Cover Plate, dust-cover wheel bearing		03.100.0246.690 Vergl.-Nr. Comp.No 99.00.000.0.88
passend für to fit to Bergische Achse		
Abdeckblech, Staubschutz-Radlager Cover Plate, dust-cover wheel bearing		03.100.0249.000 Vergl.-Nr. Comp.No 99.00.000.0.71
passend für to fit to Bergische Achse		
Abdeckblech, Staubschutz-Radlager Cover Plate, dust-cover wheel bearing		03.100.0249.120 Vergl.-Nr. Comp.No 99.00.000.0.93
passend für to fit to Bergische Achse		
Abdeckblech, Staubschutz-Radlager Cover Plate, dust-cover wheel bearing		03.100.0249.130 Vergl.-Nr. Comp.No 99.00.000.0.37
passend für to fit to Bergische Achse		
Abdeckblech, Staubschutz-Radlager Cover Plate, dust-cover wheel bearing		03.100.0249.140 Vergl.-Nr. Comp.No 99.00.000.0.40
passend für to fit to Bergische Achse		
Abdeckblech, Staubschutz-Radlager Cover Plate, dust-cover wheel bearing		03.100.0249.150 Vergl.-Nr. Comp.No 99.00.000.0.42
passend für to fit to Bergische Achse		









**Abdeckblech, Staubschutz-Radlager
Cover Plate, dust-cover wheel bearing**

Abdeckblech, Staubschutz-Radlager Cover Plate, dust-cover wheel bearing		
Abdeckblech, Staubschutz-Radlager Cover Plate, dust-cover wheel bearing passend für to fit to Bergische Achse		03.100.0249.160 Vergl.-Nr. Comp.No 99.00.000.0.70
Abdeckblech, Staubschutz-Radlager Cover Plate, dust-cover wheel bearing passend für to fit to Bergische Achse		03.100.0249.170 Vergl.-Nr. Comp.No 99.00.000.0.72
Abdeckblech, Staubschutz-Radlager Cover Plate, dust-cover wheel bearing passend für to fit to Bergische Achse		03.100.0249.180 Vergl.-Nr. Comp.No 99.00.000.0.73
Abdeckblech, Staubschutz-Radlager Cover Plate, dust-cover wheel bearing passend für to fit to Bergische Achse		03.100.0249.190 Vergl.-Nr. Comp.No 99.00.000.0.76
Abdeckblech, Staubschutz-Radlager Cover Plate, dust-cover wheel bearing passend für to fit to Bergische Achse		03.100.0249.200 Vergl.-Nr. Comp.No 99.00.000.0.80
Abdeckblech, Staubschutz-Radlager Cover Plate, dust-cover wheel bearing passend für to fit to Bergische Achse		03.100.0249.210 Vergl.-Nr. Comp.No 99.00.000.0.85
Abdeckblech, Staubschutz-Radlager Cover Plate, dust-cover wheel bearing passend für to fit to Bergische Achse		03.100.0249.220 Vergl.-Nr. Comp.No 99.00.000.0.89
Abdeckblech, Staubschutz-Radlager Cover Plate, dust-cover wheel bearing passend für to fit to Bergische Achse		03.100.0249.230 Vergl.-Nr. Comp.No 99.00.000.0.94









BG-03.100

Abdeckblech, Staubschutz-Radlager Cover Plate, dust-cover wheel bearing



Abdeckblech, Staubschutz-Radlager Cover Plate, dust-cover wheel bearing		
<p>Abdeckblech, Staubschutz-Radlager Cover Plate, dust-cover wheel bearing</p> <p>passend für to fit to Bergische Achse</p>		<p>03.100.0249.240</p> <p>Vergl.-Nr. Comp.No 99.00.000.0.95</p>
<p>Abdeckblech, Staubschutz-Radlager Cover Plate, dust-cover wheel bearing</p> <p>passend für to fit to Bergische Achse</p>		<p>03.100.0249.250</p> <p>Vergl.-Nr. Comp.No 99.00.000.0.97</p>
<p>Abdeckblech, Staubschutz-Radlager Cover Plate, dust-cover wheel bearing</p> <p>passend für to fit to Bergische Achse</p>		<p>03.100.0249.260</p> <p>Vergl.-Nr. Comp.No 99.00.000.0.84</p>
<p>Abdeckblech, Staubschutz-Radlager Cover Plate, dust-cover wheel bearing</p> <p>passend für to fit to Bergische Achse</p>		<p>03.100.0249.270</p> <p>Vergl.-Nr. Comp.No 99.00.000.1.03</p>
<p>Abdeckblech, Staubschutz-Radlager Cover Plate, dust-cover wheel bearing</p> <p>passend für to fit to Bergische Achse</p>		<p>03.100.0249.280</p> <p>Vergl.-Nr. Comp.No 99.00.000.0.81</p>
<p>Abdeckblech, Staubschutz-Radlager Cover Plate, dust-cover wheel bearing</p> <p>passend für to fit to Bergische Achse</p>		<p>03.100.0249.290</p> <p>Vergl.-Nr. Comp.No 99.00.000.0.83</p>
<p>Abdeckblech, Staubschutz-Radlager Cover Plate, dust-cover wheel bearing</p> <p>passend für to fit to Bergische Achse</p>		<p>03.100.0249.300</p> <p>Vergl.-Nr. Comp.No 99.00.000.1.06</p>
<p>Abdeckblech, Staubschutz-Radlager Cover Plate, dust-cover wheel bearing</p> <p>passend für to fit to Bergische Achse</p>		<p>03.100.0249.310</p> <p>Vergl.-Nr. Comp.No 99.00.000.1.05</p>

**Abdeckblech, Staubschutz-Radlager
Cover Plate, dust-cover wheel bearing**
Abdeckblech, Staubschutz-Radlager | Cover Plate, dust-cover wheel bearing

<p>Abdeckblech, Staubschutz-Radlager Cover Plate, dust-cover wheel bearing</p> <p>passend für to fit to Bergische Achse</p>		<p>03.100.0249.320</p> <p>Vergl.-Nr. Comp.No 99.00.000.0.75</p>
<p>Abdeckblech, Staubschutz-Radlager Cover Plate, dust-cover wheel bearing</p> <p>passend für to fit to Bergische Achse</p>		<p>03.100.0249.330</p> <p>Vergl.-Nr. Comp.No 99.00.000.0.98</p>
<p>Abdeckblech, Staubschutz-Radlager Cover Plate, dust-cover wheel bearing</p> <p>passend für to fit to Bergische Achse</p>		<p>03.100.0249.390</p> <p>Vergl.-Nr. Comp.No 99.00.000.1.09</p>
<p>Abdeckblech, Staubschutz-Radlager Cover Plate, dust-cover wheel bearing</p> <p>passend für to fit to Frühaufl</p>		<p>03.100.0290.160</p> <p>Vergl.-Nr. Comp.No A-JA-0483-001</p>
<p>Abdeckblech, Staubschutz-Radlager Cover Plate, dust-cover wheel bearing</p> <p>passend für to fit to Frühaufl</p>		<p>03.100.0290.980</p> <p>Vergl.-Nr. Comp.No AR-JB-0006-701</p>
<p>Abdeckblech, Staubschutz-Radlager Cover Plate, dust-cover wheel bearing</p> <p>passend für to fit to Frühaufl</p>		<p>03.100.0290.990</p> <p>Vergl.-Nr. Comp.No AR-JB-0006-701</p>
<p>Abdeckblech, Staubschutz-Radlager Cover Plate, dust-cover wheel bearing</p> <p>passend für to fit to SAF</p>		<p>03.100.2036.900</p> <p>Vergl.-Nr. Comp.No 3.005.0037.03</p>
<p>Abdeckblech, Staubschutz-Radlager Cover Plate, dust-cover wheel bearing</p> <p>passend für to fit to SAF</p>		<p>03.100.2037.200</p> <p>Vergl.-Nr. Comp.No 3.005.0147.00</p>

BG-03.100

Abdeckblech, Staubschutz-Radlager Cover Plate, dust-cover wheel bearing



Abdeckblech, Staubschutz-Radlager Cover Plate, dust-cover wheel bearing		
Abdeckblech, Staubschutz-Radlager Cover Plate, dust-cover wheel bearing passend für to fit to SAF		03.100.2039.300 Vergl.-Nr. Comp.No 3.005.0141.00
Abdeckblech, Staubschutz-Radlager Cover Plate, dust-cover wheel bearing passend für to fit to SAF		03.100.2039.400 Vergl.-Nr. Comp.No 3.005.0173.00
Abdeckblech, Staubschutz-Radlager Cover Plate, dust-cover wheel bearing passend für to fit to SAF		03.100.2039.600 Vergl.-Nr. Comp.No 3.005.0117.00
Abdeckblech, Staubschutz-Radlager Cover Plate, dust-cover wheel bearing passend für to fit to SAF		03.100.2039.700 Vergl.-Nr. Comp.No 3.005.0055.00
Abdeckblech, Staubschutz-Radlager Cover Plate, dust-cover wheel bearing passend für to fit to SAF		03.100.2039.800 Vergl.-Nr. Comp.No 3.005.0009.02
Abdeckblech, Staubschutz-Radlager Cover Plate, dust-cover wheel bearing passend für to fit to SAF		03.100.2039.900 Vergl.-Nr. Comp.No 3.005.0108.00
Abdeckblech, Staubschutz-Radlager Cover Plate, dust-cover wheel bearing passend für to fit to Scania		03.100.3002.190 Vergl.-Nr. Comp.No 375 329
Abdeckblech, Staubschutz-Radlager Cover Plate, dust-cover wheel bearing passend für to fit to Trailer		03.100.3504.240 Vergl.-Nr. Comp.No M002904

**Abdeckblech, Staubschutz-Radlager
Cover Plate, dust-cover wheel bearing**

Abdeckblech, Staubschutz-Radlager Cover Plate, dust-cover wheel bearing		
Abdeckblech, Staubschutz-Radlager Cover Plate, dust-cover wheel bearing passend für to fit to Trailor		03.100.3505.050 Vergl.-Nr. Comp.No 6502809R
Abdeckblech, Staubschutz-Radlager Cover Plate, dust-cover wheel bearing passend für to fit to Volvo		03.100.4003.150 Vergl.-Nr. Comp.No 1629 835
Abdeckblech, Staubschutz-Radlager Cover Plate, dust-cover wheel bearing passend für to fit to Volvo		03.100.4003.160 Vergl.-Nr. Comp.No 2036 734-3
Abdeckblech, Staubschutz-Radlager Cover Plate, dust-cover wheel bearing passend für to fit to Volvo		03.100.4003.170 Vergl.-Nr. Comp.No 1629 836
Abdeckblech, Staubschutz-Radlager Cover Plate, dust-cover wheel bearing passend für to fit to Volvo		03.100.4004.190 Vergl.-Nr. Comp.No 1629 834
Abdeckblech, Staubschutz-Radlager Cover Plate, dust-cover wheel bearing passend für to fit to ROR		03.100.4201.000 Vergl.-Nr. Comp.No 212 24 522
Abdeckblech, Staubschutz-Radlager Cover Plate, dust-cover wheel bearing passend für to fit to ROR		03.100.4201.010 Vergl.-Nr. Comp.No 212 20 647
Abdeckblech, Staubschutz-Radlager Cover Plate, dust-cover wheel bearing passend für to fit to ROR		03.100.4201.020 Vergl.-Nr. Comp.No 210 08 062

BG-03.100

Abdeckblech, Staubschutz-Radlager Cover Plate, dust-cover wheel bearing



Abdeckblech, Staubschutz-Radlager | Cover Plate, dust-cover wheel bearing

Abdeckblech, Staubschutz-Radlager
Cover Plate, dust-cover wheel bearing

passend für | to fit to
ROR



03.100.4201.030

Vergl.-Nr. | Comp.No
212 21 567

Abdeckblech, Staubschutz-Radlager
Cover Plate, dust-cover wheel bearing

passend für | to fit to
ROR



03.100.4201.040

Vergl.-Nr. | Comp.No
212 00 910

Bremsscheibe | Brake Disc

Bremsscheibe	Höhe	160
Brake Disc	Height (mm)	
	Durchmesser	377
	Diameter (mm)	
passend für to fit to Bergische Achse	Lochkreis-Ø	335
	Pitch Circle Ø (mm)	
	Lochanzahl	10
	Number of Holes	
	Bremsbahn	45
	Brake Surface (mm)	
	Mindestdicke	37
	Minimum Thickness(mm)	



03.110.0251.000

Vergl.-Nr. | Comp.No
03.088.34.06.0





Bremsscheibe	Höhe	160
Brake Disc	Height (mm)	
	Durchmesser	377
	Diameter (mm)	
passend für to fit to Bergische Achse	Lochkreis-Ø	335
	Pitch Circle Ø (mm)	
	Lochanzahl	10
	Number of Holes	
	Bremsbahn	45
	Brake Surface (mm)	
	Mindestdicke	37
	Minimum Thickness(mm)	



03.110.0251.030

Vergl.-Nr. | Comp.No
03.088.35.04.7

Bremsscheibe | Brake Disc

Bremsscheibe Brake Disc passend für to fit to Bergische Achse	Höhe	160		03.110.0251.040 Vergl.-Nr. Comp.No 03.088.34.03.0
	Height (mm)			
	Durchmesser	376		
	Diameter (mm)			
	Lochkreis-Ø	275		
	Pitch Circle Ø (mm)			
	Lochanzahl	8		
	Number of Holes			
	Bremsbahn	45		
	Brake Surface (mm)			
Mindestdicke	37			
Minimum Thickness(mm)				
Bremsscheibe Brake Disc passend für to fit to Bergische Achse	Höhe	169		03.110.0251.050 Vergl.-Nr. Comp.No 03.088.34.08.7
	Height (mm)			
	Durchmesser	377		
	Diameter (mm)			
	Lochkreis-Ø	335		
	Pitch Circle Ø (mm)			
	Lochanzahl	10		
	Number of Holes			
	Bremsbahn	45		
	Brake Surface (mm)			
Mindestdicke	37			
Minimum Thickness(mm)				
Bremsscheibe Brake Disc passend für to fit to Bergische Achse	Höhe	160		03.110.0251.060 Vergl.-Nr. Comp.No 03.088.34.10.0
	Height (mm)			
	Durchmesser	377		
	Diameter (mm)			
	Lochkreis-Ø	335		
	Pitch Circle Ø (mm)			
	Lochanzahl	10		
	Number of Holes			
	Bremsbahn	45		
	Brake Surface (mm)			
Mindestdicke	37			
Minimum Thickness(mm)				
Bremsscheibe Brake Disc passend für to fit to Bergische Achse	Höhe	160		03.110.0251.070 Vergl.-Nr. Comp.No 03.088.35.05.0
	Height (mm)			
	Durchmesser	430		
	Diameter (mm)			
	Lochkreis-Ø	335		
	Pitch Circle Ø (mm)			
	Lochanzahl	10		
	Number of Holes			
	Bremsbahn	45		
	Brake Surface (mm)			
Mindestdicke	40			
Minimum Thickness(mm)				

BG-03.110





Bremsscheibe Brake Disc



Bremsscheibe | Brake Disc

Bremsscheibe Brake Disc	Höhe Height (mm)	159		03.110.0251.080 Vergl.-Nr. Comp.No 03.088.34.13.0
passend für to fit to Bergische Achse	Durchmesser Diameter (mm)	377		
	Lochkreis-Ø Pitch Circle Ø (mm)	335		
	Lochanzahl Number of Holes	10		
	Bremsbahn Brake Surface (mm)	45		
	Mindestdicke Minimum Thickness(mm)	40		
	Höhe Height (mm)	137		
	Durchmesser Diameter (mm)	312		
	Lochkreis-Ø Pitch Circle Ø (mm)	155		
	Lochanzahl Number of Holes	12		
Bremsbahn Brake Surface (mm)	30			
Mindestdicke Minimum Thickness(mm)	27			
Bremsscheibe Brake Disc	Höhe Height (mm)	119		03.110.0275.810 Vergl.-Nr. Comp.No 1238 372
passend für to fit to DAF	Durchmesser Diameter (mm)	460		
	Lochkreis-Ø Pitch Circle Ø (mm)	195		
	Lochanzahl Number of Holes	10		
	Bremsbahn Brake Surface (mm)	48		
	Mindestdicke Minimum Thickness(mm)	42		
	Höhe Height (mm)	122		
	Durchmesser Diameter (mm)	315		
	Lochkreis-Ø Pitch Circle Ø (mm)	138		
Lochanzahl Number of Holes	10			
Bremsbahn Brake Surface (mm)	26			
Mindestdicke Minimum Thickness(mm)	23			

Bremsscheibe | Brake Disc





Bremsscheibe Brake Disc passend für to fit to DAF	Höhe	128		03.110.0275.840 Vergl.-Nr. Comp.No MJK2785
	Height (mm)			
	Durchmesser	375		
	Diameter (mm)			
	Lochkreis-Ø	185		
	Pitch Circle Ø (mm)			
	Lochanzahl	10		
	Number of Holes			
	Bremsbahn	44		
	Brake Surface (mm)			
Mindestdicke	40			
Minimum Thickness(mm)				
Bremsscheibe Brake Disc passend für to fit to DAF	Höhe	123		03.110.0275.850 Vergl.-Nr. Comp.No 1400 163
	Height (mm)			
	Durchmesser	330		
	Diameter (mm)			
	Lochkreis-Ø	136		
	Pitch Circle Ø (mm)			
	Lochanzahl	12		
	Number of Holes			
	Bremsbahn	34		
	Brake Surface (mm)			
Mindestdicke	31			
Minimum Thickness(mm)				
Bremsscheibe Brake Disc passend für to fit to DAF	Höhe	119		03.110.0275.860 Vergl.-Nr. Comp.No 1400 273
	Height (mm)			
	Durchmesser	330		
	Diameter (mm)			
	Lochkreis-Ø	175		
	Pitch Circle Ø (mm)			
	Lochanzahl	12		
	Number of Holes			
	Bremsbahn	34		
	Brake Surface (mm)			
Mindestdicke	31			
Minimum Thickness(mm)				
Bremsscheibe Brake Disc passend für to fit to DAF	Höhe	146		03.110.0275.870 Vergl.-Nr. Comp.No 1400 284
	Height (mm)			
	Durchmesser	375		
	Diameter (mm)			
	Lochkreis-Ø	210		
	Pitch Circle Ø (mm)			
	Lochanzahl	10		
	Number of Holes			
	Bremsbahn	45		
	Brake Surface (mm)			
Mindestdicke	40			
Minimum Thickness(mm)				

BG-03.110



Bremsscheibe Brake Disc



Bremsscheibe | Brake Disc

Bremsscheibe Brake Disc	Höhe Height (mm)	143		03.110.0275.880 Vergl.-Nr. Comp.No 1403 758			
passend für to fit to DAF	Durchmesser Diameter (mm)	330					
	Lochkreis-Ø Pitch Circle Ø (mm)	155					
	Lochanzahl Number of Holes	16					
	Bremsbahn Brake Surface (mm)	34					
	Mindestdicke Minimum Thickness(mm)	30					
	Höhe Height (mm)	99				03.110.0275.890 Vergl.-Nr. Comp.No 1400 069	
	Bremsscheibe Brake Disc	Durchmesser Diameter (mm)					375
	passend für to fit to DAF	Lochkreis-Ø Pitch Circle Ø (mm)					145
		Lochanzahl Number of Holes					10
Bremsbahn Brake Surface (mm)		45					
Mindestdicke Minimum Thickness(mm)		40					
Höhe Height (mm)		135		03.110.0620.000 Vergl.-Nr. Comp.No 0501.313.313			
Bremsscheibe Brake Disc		Durchmesser Diameter (mm)					432
passend für to fit to Kässbohrer		Lochkreis-Ø Pitch Circle Ø (mm)					220
		Lochanzahl Number of Holes					10
		Bremsbahn Brake Surface (mm)			45		
	Mindestdicke Minimum Thickness(mm)	35					
	Höhe Height (mm)	142				03.110.0620.010 Vergl.-Nr. Comp.No 172.24.11.130.02	
	Bremsscheibe Brake Disc	Durchmesser Diameter (mm)					320
	passend für to fit to Kässbohrer	Lochkreis-Ø Pitch Circle Ø (mm)					215
		Lochanzahl Number of Holes					6
		Bremsbahn Brake Surface (mm)	50				
Mindestdicke Minimum Thickness(mm)		45					

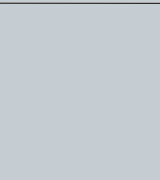
Bremsscheibe | Brake Disc

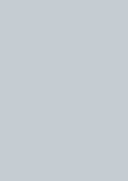
Bremsscheibe Brake Disc passend für to fit to Kässbohrer	Höhe	175		03.110.0620.020 Vergl.-Nr. Comp.No 179.24.11.111.31
	Height (mm)			
	Durchmesser	406		
	Diameter (mm)			
	Lochkreis-Ø	215		
	Pitch Circle Ø (mm)			
	Lochanzahl	10		
	Number of Holes			
	Bremsbahn	48		
	Brake Surface (mm)			
Mindestdicke	48			
Minimum Thickness(mm)				
Bremsscheibe Brake Disc passend für to fit to Kässbohrer	Höhe	119		03.110.0620.030 Vergl.-Nr. Comp.No 179.24.11.113.07
	Height (mm)			
	Durchmesser	396		
	Diameter (mm)			
	Lochkreis-Ø	215		
	Pitch Circle Ø (mm)			
	Lochanzahl	10		
	Number of Holes			
	Bremsbahn	48		
	Brake Surface (mm)			
Mindestdicke	45			
Minimum Thickness(mm)				
Bremsscheibe Brake Disc passend für to fit to Neoplan	Höhe	120		03.110.0711.000 Vergl.-Nr. Comp.No 0801.621.00
	Height (mm)			
	Durchmesser	410		
	Diameter (mm)			
	Lochkreis-Ø	185		
	Pitch Circle Ø (mm)			
	Lochanzahl	12		
	Number of Holes			
	Bremsbahn	48		
	Brake Surface (mm)			
Mindestdicke	38			
Minimum Thickness(mm)				
Bremsscheibe Brake Disc passend für to fit to Neoplan	Höhe	149		03.110.0711.010 Vergl.-Nr. Comp.No 0801.616.00
	Height (mm)			
	Durchmesser	315		
	Diameter (mm)			
	Lochkreis-Ø	245		
	Pitch Circle Ø (mm)			
	Lochanzahl	6		
	Number of Holes			
	Bremsbahn	35		
	Brake Surface (mm)			
Mindestdicke	26			
Minimum Thickness(mm)				

BG-03.110



Bremsscheibe Brake Disc



Bremsscheibe | Brake Disc

Bremsscheibe Brake Disc passend für to fit to Neoplan	Höhe Height (mm) Durchmesser Diameter (mm) Lochkreis-Ø Pitch Circle Ø (mm) Lochanzahl Number of Holes Bremsbahn Brake Surface (mm) Mindestdicke Minimum Thickness(mm)	131 430 235 10 45 37		03.110.0711.020 Vergl.-Nr. Comp.No 0821.333.10
Bremsscheibe Brake Disc passend für to fit to Neoplan	Höhe Height (mm) Durchmesser Diameter (mm) Lochkreis-Ø Pitch Circle Ø (mm) Lochanzahl Number of Holes Bremsbahn Brake Surface (mm) Mindestdicke Minimum Thickness(mm)	131 430 235 10 45 45		03.110.0711.030 Vergl.-Nr. Comp.No 0821.358.30
Bremsscheibe Brake Disc passend für to fit to Fiat-Iveco	Höhe Height (mm) Durchmesser Diameter (mm) Lochkreis-Ø Pitch Circle Ø (mm) Lochanzahl Number of Holes Bremsbahn Brake Surface (mm) Lochkreis-Ø 1 Pitch Circle Ø 1 (mm) Lochkreis-Ø 2 Pitch Circle Ø 2 (mm) Lochanzahl 1 No. of holes 1 Lochanzahl 2 No. of holes 2 Mindestdicke Minimum Thickness(mm)	105 267 170 6 14 95 72 6 3 12,8		03.110.0810.400 Vergl.-Nr. Comp.No 8582 290

Bremsscheibe | Brake Disc

Bremsscheibe Brake Disc passend für to fit to Fiat-Iveco	Höhe	142		03.110.0811.400 Vergl.-Nr. Comp.No 8584 182
	Height (mm)			
	Durchmesser	280		
	Diameter (mm)			
	Lochkreis-Ø	170		
	Pitch Circle Ø (mm)			
	Lochanzahl	6		
	Number of Holes			
	Bremsbahn	16		
	Brake Surface (mm)			
	Lochkreis-Ø 1	85		
	Pitch Circle Ø 1 (mm)			
	Lochkreis-Ø 2	72		
	Pitch Circle Ø 2 (mm)			
	Lochanzahl 1	6		
No. of holes 1				
Lochanzahl 2	3			
No. of holes 2				
Mindestdicke	12,8			
Minimum Thickness(mm)				
Bremsscheibe Brake Disc passend für to fit to Fiat-Iveco	Höhe	129		03.110.0813.200 Vergl.-Nr. Comp.No 0190 7528
	Height (mm)			
	Durchmesser	304		
	Diameter (mm)			
	Lochkreis-Ø	205		
	Pitch Circle Ø (mm)			
	Lochanzahl	6		
	Number of Holes			
	Bremsbahn	30		
	Brake Surface (mm)			
Mindestdicke	27,5			
Minimum Thickness(mm)				
Bremsscheibe Brake Disc passend für to fit to Fiat-Iveco	Höhe	118		03.110.0814.400 Vergl.-Nr. Comp.No 0716 8368
	Height (mm)			
	Durchmesser	315		
	Diameter (mm)			
	Lochkreis-Ø	205		
	Pitch Circle Ø (mm)			
	Lochanzahl	6		
	Number of Holes			
	Bremsbahn	26		
	Brake Surface (mm)			
	Lochkreis-Ø 1	205		
	Pitch Circle Ø 1 (mm)			
	Lochanzahl 1	2		
No. of holes 1				
Mindestdicke	23			
Minimum Thickness(mm)				

BG-03.110



Bremsscheibe Brake Disc



Bremsscheibe | Brake Disc

Bremsscheibe Brake Disc	Höhe Height (mm)	134		03.110.0815.200 Vergl.-Nr. Comp.No 7172 018			
passend für to fit to Fiat-Iveco	Durchmesser Diameter (mm)	322					
	Lochkreis-Ø Pitch Circle Ø (mm)	275					
	Lochanzahl Number of Holes	8					
	Bremsbahn Brake Surface (mm)	30					
	Mindestdicke Minimum Thickness(mm)	27,5					
	Bremsscheibe Brake Disc	Höhe Height (mm)			129		03.110.0816.400 Vergl.-Nr. Comp.No 7171 255
	passend für to fit to Fiat-Iveco	Durchmesser Diameter (mm)			322		
		Lochkreis-Ø Pitch Circle Ø (mm)			275		
		Lochanzahl Number of Holes			8		
Bremsbahn Brake Surface (mm)		30					
Mindestdicke Minimum Thickness(mm)		27,5					
Bremsscheibe Brake Disc		Höhe Height (mm)	150		03.110.0817.400 Vergl.-Nr. Comp.No 7172 880		
passend für to fit to Fiat-Iveco		Durchmesser Diameter (mm)	370				
		Lochkreis-Ø Pitch Circle Ø (mm)	275				
		Lochanzahl Number of Holes	8				
	Bremsbahn Brake Surface (mm)	45					
	Mindestdicke Minimum Thickness(mm)	27,5					
	Bremsscheibe Brake Disc	Höhe Height (mm)	102				03.110.0818.400 Vergl.-Nr. Comp.No 0299 1979
	passend für to fit to Fiat-Iveco	Durchmesser Diameter (mm)	430				
		Lochkreis-Ø Pitch Circle Ø (mm)	195				
		Lochanzahl Number of Holes	12				
Bremsbahn Brake Surface (mm)		50					
Mindestdicke Minimum Thickness(mm)		42					

Bremsscheibe | Brake Disc

Bremsscheibe Brake Disc passend für to fit to Fiat-Iveco	Höhe	112		03.110.0819.400
	Height (mm)			
	Durchmesser	267		
	Diameter (mm)			
	Lochkreis-Ø	170		
	Pitch Circle Ø (mm)			
	Lochanzahl	6		
	Number of Holes			
	Bremsbahn	14		
	Brake Surface (mm)			
	Lochkreis-Ø 1	95		
	Pitch Circle Ø 1 (mm)			
	Lochkreis-Ø 2	72		
	Pitch Circle Ø 2 (mm)			
	Lochanzahl 1	6		
No. of holes 1				
Lochanzahl 2	3			
No. of holes 2				
Mindestdicke	12,8			
Minimum Thickness(mm)				
Bremsscheibe Brake Disc passend für to fit to Fiat-Iveco	Höhe	182		03.110.0820.400
	Height (mm)			
	Durchmesser	370		
	Diameter (mm)			
	Lochkreis-Ø	275		
	Pitch Circle Ø (mm)			
	Lochanzahl	8		
	Number of Holes			
	Bremsbahn	45		
	Brake Surface (mm)			
Mindestdicke	27,5			
Minimum Thickness(mm)				
Bremsscheibe Brake Disc passend für to fit to Fiat-Iveco	Höhe	105		03.110.0821.400
	Height (mm)			
	Durchmesser	290		
	Diameter (mm)			
	Lochkreis-Ø	170		
	Pitch Circle Ø (mm)			
	Lochanzahl	6		
	Number of Holes			
	Bremsbahn	22		
	Brake Surface (mm)			
	Lochkreis-Ø 1	95		
	Pitch Circle Ø 1 (mm)			
	Lochanzahl 1	6		
No. of holes 1				
Mindestdicke	20			
Minimum Thickness(mm)				

BG-03.110



Bremsscheibe Brake Disc



Bremsscheibe | Brake Disc

Bremsscheibe Brake Disc	Höhe Height (mm)	85		03.110.0822.200 Vergl.-Nr. Comp.No 0190 8773			
passend für to fit to Fiat-Iveco	Durchmesser Diameter (mm)	289					
	Lochkreis-Ø Pitch Circle Ø (mm)	108					
	Lochanzahl Number of Holes	8					
	Bremsbahn Brake Surface (mm)	22					
	Mindestdicke Minimum Thickness(mm)	20					
	Bremsscheibe Brake Disc	Höhe Height (mm)			139		03.110.0823.200 Vergl.-Nr. Comp.No 0190 6438
	passend für to fit to Fiat-Iveco	Durchmesser Diameter (mm)			437		
		Lochkreis-Ø Pitch Circle Ø (mm)			240		
		Lochanzahl Number of Holes			12		
Bremsbahn Brake Surface (mm)		45					
Mindestdicke Minimum Thickness(mm)		41					
Bremsscheibe Brake Disc		Höhe Height (mm)	102		03.110.0922.010 Vergl.-Nr. Comp.No 81.50803.0010		
passend für to fit to MAN		Durchmesser Diameter (mm)	324				
		Lochkreis-Ø Pitch Circle Ø (mm)	158				
		Lochanzahl Number of Holes	10				
	Bremsbahn Brake Surface (mm)	30					
	Mindestdicke Minimum Thickness(mm)	24					
	Bremsscheibe Brake Disc	Höhe Height (mm)	104				03.110.0922.020 Vergl.-Nr. Comp.No 81.50803.0026
	passend für to fit to MAN	Durchmesser Diameter (mm)	330				
		Lochkreis-Ø Pitch Circle Ø (mm)	158				
		Lochanzahl Number of Holes	10				
Bremsbahn Brake Surface (mm)		34					
Mindestdicke Minimum Thickness(mm)		26					

Bremsscheibe | Brake Disc

Bremsscheibe Brake Disc passend für to fit to MAN	Höhe	135		03.110.0922.030 Vergl.-Nr. Comp.No 81.50803.0015
	Height (mm)			
	Durchmesser	438		
	Diameter (mm)			
	Lochkreis-Ø	235		
	Pitch Circle Ø (mm)			
	Lochanzahl	10		
	Number of Holes			
	Bremsbahn	45		
	Brake Surface (mm)			
Mindestdicke	35			
Minimum Thickness(mm)				
Bremsscheibe Brake Disc passend für to fit to MAN	Höhe	124		03.110.0922.040 Vergl.-Nr. Comp.No 81.50803.0022
	Height (mm)			
	Durchmesser	330		
	Diameter (mm)			
	Lochkreis-Ø	180		
	Pitch Circle Ø (mm)			
	Lochanzahl	12		
	Number of Holes			
	Bremsbahn	34		
	Brake Surface (mm)			
Mindestdicke	26			
Minimum Thickness(mm)				
Bremsscheibe Brake Disc passend für to fit to MAN	Höhe	130		03.110.0922.050 Vergl.-Nr. Comp.No 81.50803.0038
	Height (mm)			
	Durchmesser	432		
	Diameter (mm)			
	Lochkreis-Ø	168		
	Pitch Circle Ø (mm)			
	Lochanzahl	12		
	Number of Holes			
	Bremsbahn	45		
	Brake Surface (mm)			
	Lochkreis-Ø 1	168		
	Pitch Circle Ø 1 (mm)			
	Lochanzahl 1	3		
No. of holes 1				
Mindestdicke	37			
Minimum Thickness(mm)				

BG-03.110





Bremsscheibe Brake Disc



Bremsscheibe | Brake Disc

Bremsscheibe Brake Disc	Höhe Height (mm)	128		03.110.0922.070 Vergl.-Nr. Comp.No 81.50803.0020			
passend für to fit to MAN	Durchmesser Diameter (mm)	377					
	Lochkreis-Ø Pitch Circle Ø (mm)	195					
	Lochanzahl Number of Holes	10					
	Bremsbahn Brake Surface (mm)	45					
	Mindestdicke Minimum Thickness(mm)	37					
	Bremsscheibe Brake Disc	Höhe Height (mm)			135		03.110.0922.080 Vergl.-Nr. Comp.No 81.35700.6111
	passend für to fit to MAN	Durchmesser Diameter (mm)			438		
		Lochkreis-Ø Pitch Circle Ø (mm)			235		
		Lochanzahl Number of Holes			10		
Bremsbahn Brake Surface (mm)		45					
Mindestdicke Minimum Thickness(mm)		35					
Bremsscheibe Brake Disc		Höhe Height (mm)	130		03.110.0922.090 Vergl.-Nr. Comp.No 81.50803.0040		
passend für to fit to MAN		Durchmesser Diameter (mm)	432				
		Lochkreis-Ø Pitch Circle Ø (mm)	168				
		Lochanzahl Number of Holes	12				
	Bremsbahn Brake Surface (mm)	45					
	Mindestdicke Minimum Thickness(mm)	37					
	Bremsscheibe Brake Disc	Höhe Height (mm)	135				03.110.0922.100 Vergl.-Nr. Comp.No 81.50803.0021
	passend für to fit to MAN	Durchmesser Diameter (mm)	432				
		Lochkreis-Ø Pitch Circle Ø (mm)	235				
		Lochanzahl Number of Holes	10				
Bremsbahn Brake Surface (mm)		45					
Mindestdicke Minimum Thickness(mm)		35					

Bremsscheibe | Brake Disc

Bremsscheibe Brake Disc passend für to fit to MAN	Höhe	93		03.110.0922.130 Vergl.-Nr. Comp.No 81.50803.0042
	Height (mm)			
	Durchmesser	335		
	Diameter (mm)			
	Lochanzahl	10		
	Number of Holes			
	Bremsbahn	34		
Brake Surface (mm)				
Mindestdicke	26			
Minimum Thickness(mm)				
Bremsscheibe Brake Disc passend für to fit to Mercedes	Höhe	133		03.110.1926.000 Vergl.-Nr. Comp.No 942 421 05 12
	Height (mm)			
	Durchmesser	430		
	Diameter (mm)			
	Lochkreis-Ø	238		
	Pitch Circle Ø (mm)			
	Lochanzahl	10		
Number of Holes				
Bremsbahn	45			
Brake Surface (mm)				
Mindestdicke	37			
Minimum Thickness(mm)				
Bremsscheibe Brake Disc passend für to fit to Mercedes	Höhe	91		03.110.1926.010 Vergl.-Nr. Comp.No 669 421 06 012
	Height (mm)			
	Durchmesser	304		
	Diameter (mm)			
	Lochkreis-Ø	140		
	Pitch Circle Ø (mm)			
	Lochanzahl	6		
Number of Holes				
Bremsbahn	30			
Brake Surface (mm)				
Mindestdicke	26			
Minimum Thickness(mm)				
Bremsscheibe Brake Disc passend für to fit to Mercedes	Höhe	103		03.110.1926.020 Vergl.-Nr. Comp.No 970 421 00 12
	Height (mm)			
	Durchmesser	335		
	Diameter (mm)			
	Lochkreis-Ø	120		
	Pitch Circle Ø (mm)			
	Lochanzahl	10		
Number of Holes				
Bremsbahn	34			
Brake Surface (mm)				
Mindestdicke	26			
Minimum Thickness(mm)				

BG-03.110

Bremsscheibe Brake Disc



Bremsscheibe | Brake Disc

Bremsscheibe Brake Disc	Höhe Height (mm)	91		03.110.1926.030 Vergl.-Nr. Comp.No 668 421 01 12
passend für to fit to Mercedes	Durchmesser Diameter (mm)	304		
	Lochkreis-Ø Pitch Circle Ø (mm)	140		
	Lochanzahl Number of Holes	6		
	Bremsbahn Brake Surface (mm)	30		
	Mindestdicke Minimum Thickness(mm)	26		
	Höhe Height (mm)	91		
	Durchmesser Diameter (mm)	324		
	Lochkreis-Ø Pitch Circle Ø (mm)	140		
	Lochanzahl Number of Holes	6		
Bremsbahn Brake Surface (mm)	30			
Mindestdicke Minimum Thickness(mm)	26			
Bremsscheibe Brake Disc	Höhe Height (mm)	91		03.110.1926.040 Vergl.-Nr. Comp.No 668 421 02 12
passend für to fit to Mercedes	Durchmesser Diameter (mm)	324		
	Lochkreis-Ø Pitch Circle Ø (mm)	140		
	Lochanzahl Number of Holes	6		
	Bremsbahn Brake Surface (mm)	30		
	Mindestdicke Minimum Thickness(mm)	26		
	Höhe Height (mm)	22		
	Durchmesser Diameter (mm)	374		
	Lochkreis-Ø Pitch Circle Ø (mm)	108		
	Lochanzahl Number of Holes	10		
Bremsbahn Brake Surface (mm)	22			
Mindestdicke Minimum Thickness(mm)	20,5			
Bremsscheibe Brake Disc	Höhe Height (mm)	22		03.110.1926.050 Vergl.-Nr. Comp.No 416 421 04 12
passend für to fit to Mercedes	Durchmesser Diameter (mm)	374		
	Lochkreis-Ø Pitch Circle Ø (mm)	108		
	Lochanzahl Number of Holes	10		
	Bremsbahn Brake Surface (mm)	22		
	Mindestdicke Minimum Thickness(mm)	20,5		
	Höhe Height (mm)	22		
	Durchmesser Diameter (mm)	374		
	Lochkreis-Ø Pitch Circle Ø (mm)	108		
	Lochanzahl Number of Holes	10		
Bremsbahn Brake Surface (mm)	22			
Mindestdicke Minimum Thickness(mm)	20,5			
Bremsscheibe Brake Disc	Höhe Height (mm)	22		03.110.1926.060 Vergl.-Nr. Comp.No 417 421 00 12
passend für to fit to Mercedes	Durchmesser Diameter (mm)	374		
	Lochkreis-Ø Pitch Circle Ø (mm)	108		
	Lochanzahl Number of Holes	10		
	Bremsbahn Brake Surface (mm)	22		
	Mindestdicke Minimum Thickness(mm)	20,5		
	Höhe Height (mm)	22		
	Durchmesser Diameter (mm)	374		
	Lochkreis-Ø Pitch Circle Ø (mm)	108		
	Lochanzahl Number of Holes	10		
Bremsbahn Brake Surface (mm)	22			
Mindestdicke Minimum Thickness(mm)	20,5			

Bremsscheibe | Brake Disc

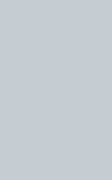
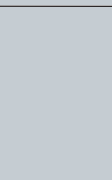
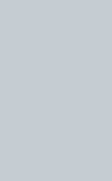

Bremsscheibe Brake Disc passend für to fit to Mercedes	Höhe	68		03.110.1926.070 Vergl.-Nr. Comp.No 425 421 00 12
	Height (mm)			
	Durchmesser	380		
	Diameter (mm)			
	Lochkreis-Ø	180		
	Pitch Circle Ø (mm)			
	Lochanzahl	8		
	Number of Holes			
	Bremsbahn	30		
Brake Surface (mm)				
Mindestdicke	26			
Minimum Thickness(mm)				
Bremsscheibe Brake Disc passend für to fit to Mercedes	Höhe	22		03.110.1926.090 Vergl.-Nr. Comp.No 437 421 02 12
	Height (mm)			
	Durchmesser	374		
	Diameter (mm)			
	Lochkreis-Ø	108		
	Pitch Circle Ø (mm)			
	Lochanzahl	10		
	Number of Holes			
	Bremsbahn	22		
Brake Surface (mm)				
Bremsscheibe Brake Disc passend für to fit to Mercedes	Höhe	64		03.110.1926.100 Vergl.-Nr. Comp.No 437 421 04 12
	Height (mm)			
	Durchmesser	380		
	Diameter (mm)			
	Lochkreis-Ø	180		
	Pitch Circle Ø (mm)			
	Lochanzahl	8		
	Number of Holes			
	Bremsbahn	30		
Brake Surface (mm)				
Mindestdicke	26			
Minimum Thickness(mm)				
Bremsscheibe Brake Disc passend für to fit to Mercedes	Höhe	67		03.110.1926.110 Vergl.-Nr. Comp.No 437 421 05 12
	Height (mm)			
	Durchmesser	380		
	Diameter (mm)			
	Lochkreis-Ø	180		
	Pitch Circle Ø (mm)			
	Lochanzahl	8		
	Number of Holes			
	Bremsbahn	22		
Brake Surface (mm)				
Mindestdicke	20,5			
Minimum Thickness(mm)				

BG-03.110



Bremsscheibe Brake Disc



Bremsscheibe | Brake Disc

Bremsscheibe Brake Disc	Höhe Height (mm)	62		03.110.1926.120 Vergl.-Nr. Comp.No 440 421 01 12			
passend für to fit to Mercedes	Durchmesser Diameter (mm)	421					
	Lochkreis-Ø Pitch Circle Ø (mm)	180					
	Lochanzahl Number of Holes	8					
	Bremsbahn Brake Surface (mm)	22					
	Mindestdicke Minimum Thickness(mm)	19					
	Bremsscheibe Brake Disc					03.110.1926.130 Vergl.-Nr. Comp.No 601 420 03 72	
	Höhe Height (mm)	79					
	Durchmesser Diameter (mm)	280					
	Lochkreis-Ø Pitch Circle Ø (mm)	112					
Lochanzahl Number of Holes	5						
Bremsbahn Brake Surface (mm)	22						
Lochkreis-Ø 1 Pitch Circle Ø 1 (mm)	112						
Lochanzahl 1 No. of holes 1	5						
Mindestdicke Minimum Thickness(mm)	19						
Bremsscheibe Brake Disc				03.110.1926.140 Vergl.-Nr. Comp.No 356 421 03 12			
Höhe Height (mm)	135						
Durchmesser Diameter (mm)	438						
Lochkreis-Ø Pitch Circle Ø (mm)	235						
Lochanzahl Number of Holes	10						
Bremsbahn Brake Surface (mm)	45						
Mindestdicke Minimum Thickness(mm)	37						

Bremsscheibe | Brake Disc

Bremsscheibe Brake Disc passend für to fit to Mercedes	Höhe	91		03.110.1926.150 Vergl.-Nr. Comp.No 670 421 01 012
	Height (mm)			
	Durchmesser	324		
	Diameter (mm)			
	Lochkreis-Ø	140		
	Pitch Circle Ø (mm)			
	Lochanzahl	6		
	Number of Holes			
	Bremsbahn	30		
	Brake Surface (mm)			
Mindestdicke	26			
Minimum Thickness(mm)				
Bremsscheibe Brake Disc passend für to fit to Mercedes	Höhe	134		03.110.1926.160 Vergl.-Nr. Comp.No 975 421 00 12
	Height (mm)			
	Durchmesser	377		
	Diameter (mm)			
	Lochkreis-Ø	138		
	Pitch Circle Ø (mm)			
	Lochanzahl	14		
	Number of Holes			
	Bremsbahn	45		
	Brake Surface (mm)			
Mindestdicke	37			
Minimum Thickness(mm)				
Bremsscheibe Brake Disc passend für to fit to Mercedes	Höhe	97		03.110.1926.170 Vergl.-Nr. Comp.No 902 423 03 12
	Height (mm)			
	Durchmesser	272		
	Diameter (mm)			
	Lochkreis-Ø	130		
	Pitch Circle Ø (mm)			
	Lochanzahl	5		
	Number of Holes			
	Bremsbahn	16		
	Brake Surface (mm)			
	Lochkreis-Ø 1	112		
	Pitch Circle Ø 1 (mm)			
	Lochanzahl 1	1		
No. of holes 1				
Mindestdicke	14			
Minimum Thickness(mm)				

BG-03.110

Bremsscheibe Brake Disc



Bremsscheibe | Brake Disc

Bremsscheibe Brake Disc	Höhe Height (mm)	77		03.110.1926.180 Vergl.-Nr. Comp.No 902 421 06 12			
passend für to fit to Mercedes	Durchmesser Diameter (mm)	276					
	Lochkreis-Ø Pitch Circle Ø (mm)	130					
	Lochanzahl Number of Holes	5					
	Bremsbahn Brake Surface (mm)	22					
	Mindestdicke Minimum Thickness(mm)	19					
	Höhe Height (mm)	127				03.110.1926.190 Vergl.-Nr. Comp.No 943 421 03 12	
	Bremsscheibe Brake Disc	Durchmesser Diameter (mm)					430
	passend für to fit to Mercedes	Lochkreis-Ø Pitch Circle Ø (mm)					168
		Lochanzahl Number of Holes					10
Bremsbahn Brake Surface (mm)		45					
Mindestdicke Minimum Thickness(mm)		19					
Höhe Height (mm)		111		03.110.1926.200 Vergl.-Nr. Comp.No 669 421 05 12			
Bremsscheibe Brake Disc		Durchmesser Diameter (mm)					324
passend für to fit to Mercedes		Lochkreis-Ø Pitch Circle Ø (mm)					205
		Lochanzahl Number of Holes					6
		Bremsbahn Brake Surface (mm)			30		
	Mindestdicke Minimum Thickness(mm)	26					
	Höhe Height (mm)	93				03.110.1926.210 Vergl.-Nr. Comp.No 904 423 02 12	
	Bremsscheibe Brake Disc	Durchmesser Diameter (mm)					285
	passend für to fit to Mercedes	Lochkreis-Ø Pitch Circle Ø (mm)					145
		Lochanzahl Number of Holes					6
		Bremsbahn Brake Surface (mm)	22				
Mindestdicke Minimum Thickness(mm)		19					

Bremsscheibe | Brake Disc

Bremsscheibe Brake Disc passend für to fit to Mercedes	Höhe	139		03.110.1926.220 Vergl.-Nr. Comp.No 975 423 06 12
	Height (mm)			
	Durchmesser	377		
	Diameter (mm)			
	Lochkreis-Ø	196		
	Pitch Circle Ø (mm)			
	Lochanzahl	8		
	Number of Holes			
	Bremsbahn	45		
	Brake Surface (mm)			
Mindestdicke	37			
Minimum Thickness(mm)				
Bremsscheibe Brake Disc passend für to fit to Mercedes	Höhe	120		03.110.1926.230 Vergl.-Nr. Comp.No 668 423 05 12
	Height (mm)			
	Durchmesser	324		
	Diameter (mm)			
	Lochkreis-Ø	192		
	Pitch Circle Ø (mm)			
	Lochanzahl	6		
	Number of Holes			
	Bremsbahn	30		
	Brake Surface (mm)			
Mindestdicke	26			
Minimum Thickness(mm)				
Bremsscheibe Brake Disc passend für to fit to Mercedes	Höhe	120		03.110.1926.240 Vergl.-Nr. Comp.No 668 423 04 12
	Height (mm)			
	Durchmesser	304		
	Diameter (mm)			
	Lochkreis-Ø	192		
	Pitch Circle Ø (mm)			
	Lochanzahl	6		
	Number of Holes			
	Bremsbahn	30		
	Brake Surface (mm)			
Mindestdicke	26			
Minimum Thickness(mm)				
Bremsscheibe Brake Disc passend für to fit to Mercedes	Höhe	120		03.110.1926.250 Vergl.-Nr. Comp.No 668 423 01 12
	Height (mm)			
	Durchmesser	324		
	Diameter (mm)			
	Lochkreis-Ø	192		
	Pitch Circle Ø (mm)			
	Lochanzahl	6		
	Number of Holes			
	Bremsbahn	30		
	Brake Surface (mm)			
Mindestdicke	26			
Minimum Thickness(mm)				

BG-03.110



Bremsscheibe Brake Disc



Bremsscheibe | Brake Disc

Bremsscheibe Brake Disc	Höhe Height (mm)	120		03.110.1926.260 Vergl.-Nr. Comp.No 668 423 00 12			
passend für to fit to Mercedes	Durchmesser Diameter (mm)	304					
	Lochkreis-Ø Pitch Circle Ø (mm)	192					
	Lochanzahl Number of Holes	6					
	Bremsbahn Brake Surface (mm)	30					
	Mindestdicke Minimum Thickness(mm)	26					
	Höhe Height (mm)	111				03.110.1926.270 Vergl.-Nr. Comp.No 970 423 05 12	
	Bremsscheibe Brake Disc	Durchmesser Diameter (mm)					335
	passend für to fit to Mercedes	Lochkreis-Ø Pitch Circle Ø (mm)					177
		Lochanzahl Number of Holes					8
Bremsbahn Brake Surface (mm)		34					
Mindestdicke Minimum Thickness(mm)		28					
Höhe Height (mm)		111		03.110.1926.280 Vergl.-Nr. Comp.No 970 423 10 12			
Bremsscheibe Brake Disc		Durchmesser Diameter (mm)					335
passend für to fit to Mercedes		Lochkreis-Ø Pitch Circle Ø (mm)					177
		Lochanzahl Number of Holes					8
		Bremsbahn Brake Surface (mm)			34		
	Mindestdicke Minimum Thickness(mm)	28					

Bremsscheibe | Brake Disc

Bremsscheibe Brake Disc passend für to fit to Mercedes	Höhe	97		03.110.1926.290 Vergl.-Nr. Comp.No 901 423 08 12
	Height (mm)			
	Durchmesser	258		
	Diameter (mm)			
	Lochkreis-Ø	130		
	Pitch Circle Ø (mm)			
	Lochanzahl	5		
	Number of Holes			
	Bremsbahn	12		
	Brake Surface (mm)			
	Lochkreis-Ø 1	112		
	Pitch Circle Ø 1 (mm)			
	Lochanzahl 1	1		
No. of holes 1				
Mindestdicke	28			
Minimum Thickness(mm)				
Bremsscheibe Brake Disc passend für to fit to Mercedes	Höhe	79		03.110.1926.300 Vergl.-Nr. Comp.No 601 421 50 12
	Height (mm)			
	Durchmesser	280		
	Diameter (mm)			
	Lochkreis-Ø	112		
	Pitch Circle Ø (mm)			
	Lochanzahl	5		
	Number of Holes			
	Bremsbahn	16		
	Brake Surface (mm)			
	Mindestdicke	37		
	Minimum Thickness(mm)			
	Bremsscheibe Brake Disc passend für to fit to Mercedes	Höhe		
Height (mm)				
Durchmesser		238		
Diameter (mm)				
Lochkreis-Ø		140		
Pitch Circle Ø (mm)				
Lochanzahl		5		
Number of Holes				
Bremsbahn		16		
Brake Surface (mm)				
Mindestdicke		19		
Minimum Thickness(mm)				

BG-03.110

Bremsscheibe Brake Disc



Bremsscheibe | Brake Disc

Bremsscheibe Brake Disc	Höhe Height (mm)	82		03.110.1926.330 Vergl.-Nr. Comp.No 631 420 01 72			
passend für to fit to Mercedes	Durchmesser Diameter (mm)	263					
	Lochkreis-Ø Pitch Circle Ø (mm)	140					
	Lochanzahl Number of Holes	5					
	Bremsbahn Brake Surface (mm)	24					
	Mindestdicke Minimum Thickness(mm)	22					
	Bremsscheibe Brake Disc	Höhe Height (mm)			60		03.110.1926.340 Vergl.-Nr. Comp.No 638 421 01 12
	passend für to fit to Mercedes	Durchmesser Diameter (mm)			276		
		Lochkreis-Ø Pitch Circle Ø (mm)			112		
		Lochanzahl Number of Holes			5		
Bremsbahn Brake Surface (mm)		22					
Mindestdicke Minimum Thickness(mm)		26					
Bremsscheibe Brake Disc		Höhe Height (mm)	63		03.110.1926.350 Vergl.-Nr. Comp.No 638 423 01 12		
passend für to fit to Mercedes		Durchmesser Diameter (mm)	280				
		Lochkreis-Ø Pitch Circle Ø (mm)	112				
		Lochanzahl Number of Holes	5				
	Bremsbahn Brake Surface (mm)	10					
	Mindestdicke Minimum Thickness(mm)	8					
	Bremsscheibe Brake Disc	Höhe Height (mm)	130				03.110.1926.390 Vergl.-Nr. Comp.No 970 423 02 12
	passend für to fit to Mercedes/MAN	Durchmesser Diameter (mm)	330				
		Lochkreis-Ø Pitch Circle Ø (mm)	177				
		Lochanzahl Number of Holes	8				
Bremsbahn Brake Surface (mm)		34					
Mindestdicke Minimum Thickness(mm)		28					

Bremsscheibe | Brake Disc

Bremsscheibe Brake Disc passend für to fit to Sauer	Höhe	130		03.110.2400.000 Vergl.-Nr. Comp.No 4.079.0005.00
	Height (mm)			
	Durchmesser	430		
	Diameter (mm)			
	Lochkreis-Ø	168		
	Pitch Circle Ø (mm)			
	Lochanzahl	12		
	Number of Holes			
	Bremsbahn	45		
	Brake Surface (mm)			
Mindestdicke	37			
Minimum Thickness(mm)				
Bremsscheibe Brake Disc passend für to fit to Sauer	Höhe	158		03.110.2401.000 Vergl.-Nr. Comp.No 4.079.0004.00
	Height (mm)			
	Durchmesser	377		
	Diameter (mm)			
	Lochkreis-Ø	275		
	Pitch Circle Ø (mm)			
	Lochanzahl	8		
	Number of Holes			
	Bremsbahn	45		
	Brake Surface (mm)			
Mindestdicke	37			
Minimum Thickness(mm)				
Bremsscheibe Brake Disc passend für to fit to Sauer	Höhe	161		03.110.2402.000 Vergl.-Nr. Comp.No 4.079.0003.00
	Height (mm)			
	Durchmesser	430		
	Diameter (mm)			
	Lochkreis-Ø	335		
	Pitch Circle Ø (mm)			
	Lochanzahl	10		
	Number of Holes			
	Bremsbahn	45		
	Brake Surface (mm)			
Mindestdicke	37			
Minimum Thickness(mm)				

BG-03.110

Bremsscheibe Brake Disc



Bremsscheibe | Brake Disc

Bremsscheibe Brake Disc	Höhe Height (mm)	139		03.110.2403.000 Vergl.-Nr. Comp.No 4.079.0007.00			
passend für to fit to Sauer	Durchmesser Diameter (mm)	377					
	Lochkreis-Ø Pitch Circle Ø (mm)	168					
	Lochanzahl Number of Holes	12					
	Bremsbahn Brake Surface (mm)	45					
	Lochkreis-Ø 1 Pitch Circle Ø 1 (mm)	168					
	Lochanzahl 1 No. of holes 1	3					
	Mindestdicke Minimum Thickness(mm)	37					
	Bremsscheibe Brake Disc	Höhe Height (mm)			131		03.110.3021.000 Vergl.-Nr. Comp.No 1 386 686
	passend für to fit to Scania	Durchmesser Diameter (mm)			430		
		Lochkreis-Ø Pitch Circle Ø (mm)			237		
		Lochanzahl Number of Holes			10		
		Bremsbahn Brake Surface (mm)			45		
Mindestdicke Minimum Thickness(mm)		37					
Bremsscheibe Brake Disc		Höhe Height (mm)	155		03.110.3504.900 Vergl.-Nr. Comp.No M069018		
passend für to fit to Trailer		Durchmesser Diameter (mm)	430				
		Lochkreis-Ø Pitch Circle Ø (mm)	335				
		Lochanzahl Number of Holes	10				
	Bremsbahn Brake Surface (mm)	45					
	Mindestdicke Minimum Thickness(mm)	37					

Bremsscheibe | Brake Disc



Bremsscheibe Brake Disc	Höhe Height (mm)	138		03.110.3504.910 Vergl.-Nr. Comp.No M078157			
passend für to fit to Trailer	Durchmesser Diameter (mm)	377					
	Lochkreis-Ø Pitch Circle Ø (mm)	196					
	Lochanzahl Number of Holes	8					
	Bremsbahn Brake Surface (mm)	45					
	Mindestdicke Minimum Thickness(mm)	37					
	Bremsscheibe Brake Disc	Höhe Height (mm)			127		03.110.4020.000 Vergl.-Nr. Comp.No 3112 960
	passend für to fit to Volvo	Durchmesser Diameter (mm)			438		
		Lochkreis-Ø Pitch Circle Ø (mm)			235		
		Lochanzahl Number of Holes			10		
Bremsbahn Brake Surface (mm)		45					
Mindestdicke Minimum Thickness(mm)		37					
Bremsscheibe Brake Disc		Höhe Height (mm)	90		03.110.4020.010 Vergl.-Nr. Comp.No 6774 686-7		
passend für to fit to Volvo		Durchmesser Diameter (mm)	322				
		Lochkreis-Ø Pitch Circle Ø (mm)	154				
	Lochanzahl Number of Holes	8					
	Bremsbahn Brake Surface (mm)	30					
	Mindestdicke Minimum Thickness(mm)	28					
	Bremsscheibe Brake Disc	Höhe Height (mm)	138				03.110.4020.020 Vergl.-Nr. Comp.No 6775 223
	passend für to fit to Volvo	Durchmesser Diameter (mm)	322				
Lochkreis-Ø Pitch Circle Ø (mm)		275					
Lochanzahl Number of Holes		8					
Bremsbahn Brake Surface (mm)		30					
Mindestdicke Minimum Thickness(mm)		27					

BG-03.110

Bremsscheibe Brake Disc



Bremsscheibe | Brake Disc

Bremsscheibe Brake Disc	Höhe Height (mm)	90		03.110.4020.030 Vergl.-Nr. Comp.No 6779 208			
passend für to fit to Volvo	Durchmesser Diameter (mm)	322					
	Lochkreis-Ø Pitch Circle Ø (mm)	154					
	Lochanzahl Number of Holes	6					
	Bremsbahn Brake Surface (mm)	30					
	Mindestdicke Minimum Thickness(mm)	28					
	Bremsscheibe Brake Disc	Höhe Height (mm)			150		03.110.4200.340 Vergl.-Nr. Comp.No 212 24 263
	passend für to fit to ROR	Durchmesser Diameter (mm)			378		
		Lochkreis-Ø Pitch Circle Ø (mm)			275		
		Lochanzahl Number of Holes			8		
Bremsbahn Brake Surface (mm)		45					
Lochkreis-Ø 1 Pitch Circle Ø 1 (mm)		275					
Lochanzahl 1 No. of holes 1		2					
Mindestdicke Minimum Thickness(mm)		41					
Bremsscheibe Brake Disc		Höhe Height (mm)	150		03.110.4200.390 Vergl.-Nr. Comp.No 212 27 349		
passend für to fit to ROR		Durchmesser Diameter (mm)	378				
	Lochkreis-Ø Pitch Circle Ø (mm)	250					
	Lochanzahl Number of Holes	10					
	Bremsbahn Brake Surface (mm)	45					
	Mindestdicke Minimum Thickness(mm)	39					

Bremsscheibe | Brake Disc



Bremsscheibe Brake Disc passend für to fit to Renault	Höhe	82		03.110.4255.000 Vergl.-Nr. Comp.No 5000450158
	Height (mm)			
	Durchmesser	354		
	Diameter (mm)			
	Lochkreis-Ø	151		
	Pitch Circle Ø (mm)			
	Lochanzahl	10		
	Number of Holes			
	Bremsbahn	30		
	Brake Surface (mm)			
Mindestdicke	26			
Minimum Thickness(mm)				
Bremsscheibe Brake Disc passend für to fit to Renault	Höhe	73		03.110.4255.010 Vergl.-Nr. Comp.No 5010019249
	Height (mm)			
	Durchmesser	350		
	Diameter (mm)			
	Lochkreis-Ø	165		
	Pitch Circle Ø (mm)			
	Lochanzahl	16		
	Number of Holes			
	Bremsbahn	30		
	Brake Surface (mm)			
Mindestdicke	26			
Minimum Thickness(mm)				
Bremsscheibe Brake Disc passend für to fit to Renault	Höhe	96		03.110.4255.020 Vergl.-Nr. Comp.No 5010216437
	Height (mm)			
	Durchmesser	438		
	Diameter (mm)			
	Lochkreis-Ø	165		
	Pitch Circle Ø (mm)			
	Lochanzahl	10		
	Number of Holes			
	Bremsbahn	45		
	Brake Surface (mm)			
Mindestdicke	35			
Minimum Thickness(mm)				

BG-03.110



Bremsscheibe Brake Disc

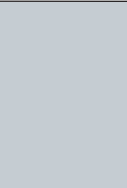

Bremsscheibe | Brake Disc

Bremsscheibe Brake Disc	Höhe Height (mm)	100		03.110.4255.030 Vergl.-Nr. Comp.No 5010216548			
passend für to fit to Renault	Durchmesser Diameter (mm)	440					
	Lochkreis-Ø Pitch Circle Ø (mm)	165					
	Lochanzahl Number of Holes	10					
	Bremsbahn Brake Surface (mm)	45					
	Lochkreis-Ø 1 Pitch Circle Ø 1 (mm)	165					
	Lochanzahl 1 No. of holes 1	2					
	Mindestdicke Minimum Thickness(mm)	35					
	Bremsscheibe Brake Disc	Höhe Height (mm)			44		03.110.4255.040 Vergl.-Nr. Comp.No 500396612
	passend für to fit to Renault	Durchmesser Diameter (mm)			276		
		Lochkreis-Ø Pitch Circle Ø (mm)			114		
		Lochanzahl Number of Holes			10		
		Bremsbahn Brake Surface (mm)			24		
Mindestdicke Minimum Thickness(mm)		22					
Bremsscheibe Brake Disc		Höhe Height (mm)	44		03.110.4255.060 Vergl.-Nr. Comp.No 5010216433		
passend für to fit to Renault		Durchmesser Diameter (mm)	276				
		Lochkreis-Ø Pitch Circle Ø (mm)	120				
		Lochanzahl Number of Holes	10				
		Bremsbahn Brake Surface (mm)	24				
		Mindestdicke Minimum Thickness(mm)	22				

Bremsscheibe | Brake Disc

Bremsscheibe Brake Disc passend für to fit to Renault	Höhe	140		03.110.4255.070 Vergl.-Nr. Comp.No 5010216932
	Height (mm)			
	Durchmesser	322		
	Diameter (mm)			
	Lochkreis-Ø	245		
	Pitch Circle Ø (mm)			
	Lochanzahl	6		
	Number of Holes			
	Bremsbahn	30		
	Brake Surface (mm)			
Mindestdicke	26			
Minimum Thickness(mm)				
Bremsscheibe Brake Disc passend für to fit to Renault	Höhe	135		03.110.4255.080 Vergl.-Nr. Comp.No 5010216931
	Height (mm)			
	Durchmesser	304		
	Diameter (mm)			
	Lochkreis-Ø	205		
	Pitch Circle Ø (mm)			
	Lochanzahl	6		
	Number of Holes			
	Bremsbahn	30		
	Brake Surface (mm)			
Mindestdicke	27			
Minimum Thickness(mm)				
Bremsscheibe Brake Disc passend für to fit to Renault	Höhe	74		03.110.4255.090 Vergl.-Nr. Comp.No 5010260609
	Height (mm)			
	Durchmesser	290		
	Diameter (mm)			
	Lochkreis-Ø	132		
	Pitch Circle Ø (mm)			
	Lochanzahl	8		
	Number of Holes			
	Bremsbahn	22		
	Brake Surface (mm)			
Mindestdicke	19			
Minimum Thickness(mm)				
Bremsscheibe Brake Disc passend für to fit to Renault	Höhe	43		03.110.4255.100 Vergl.-Nr. Comp.No 5010260603
	Height (mm)			
	Durchmesser	290		
	Diameter (mm)			
	Lochkreis-Ø	120		
	Pitch Circle Ø (mm)			
	Lochanzahl	10		
	Number of Holes			
	Bremsbahn	26		
	Brake Surface (mm)			
Mindestdicke	23			
Minimum Thickness(mm)				

BG-03.110

Bremsscheibe Brake Disc



Bremsscheibe | Brake Disc

Bremsscheibe	Höhe	160		03.110.4255.110 Vergl.-Nr. Comp.No 5010422364
Brake Disc	Height (mm)			
	Durchmesser	434		
passend für to fit to	Diameter (mm)			
Renault	Lochkreis-Ø	256		
	Pitch Circle Ø (mm)			
	Lochanzahl	12		
	Number of Holes			
	Bremsbahn	45		
	Brake Surface (mm)			
	Mindestdicke	41		
	Minimum Thickness(mm)			



Schraube, Bremsscheibe | Bolt, brake disc

Schraube, Bremsscheibe	Gewindemaß	M18x1,5		03.130.0923.960 Vergl.-Nr. Comp.No 81.90405.0254
Bolt, brake disc	Thread Size			
	Länge	60		
passend für to fit to	Length (mm)			
MAN				
Schraube, Bremsscheibe	Gewindemaß	M16x1,5		03.130.0923.970 Vergl.-Nr. Comp.No 06.02191.2824
Bolt, brake disc	Thread Size			
	Länge	120		
passend für to fit to	Length (mm)			
MAN				
Schraube, Bremsscheibe	Gewindemaß	M14x1,5		03.130.0923.980 Vergl.-Nr. Comp.No 06.01902.3413
Bolt, brake disc	Thread Size			
	Länge	80		
passend für to fit to	Length (mm)			
MAN				
Schraube, Bremsscheibe	Gewindemaß	M14x1,5		03.130.1905.140 Vergl.-Nr. Comp.No 942 990 28 04
Bolt, brake disc	Thread Size			
	Länge	70		
passend für to fit to	Length (mm)			
Mercedes-Benz				
Schraube, Bremsscheibe	Gewindemaß	M12x1,5		03.130.1905.150 Vergl.-Nr. Comp.No 910105 014019
Bolt, brake disc	Thread Size			
	Länge	80		
passend für to fit to	Length (mm)			
Mercedes-Benz				
Schraube, Bremsscheibe	Gewindemaß	M16x1,5		03.130.1935.110 Vergl.-Nr. Comp.No 910105 014009
Bolt, brake disc	Thread Size			
	Länge	120		
passend für to fit to	Length (mm)			
Mercedes-Benz				

Schraube, Bremsscheibe | Bolt, brake disc

Schraube, Bremsscheibe Bolt, brake disc	Gewindemaß Thread Size	M14x1,5		03.130.1935.120 Vergl.-Nr. Comp.No 910105 014017
	Länge Length (mm)	60		
passend für to fit to Mercedes-Benz				

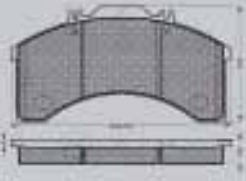
Bremsbelagsatz, Scheibenbremse | Brake Pad Set, disc brake

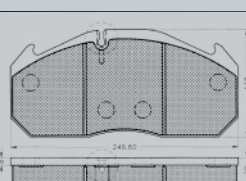
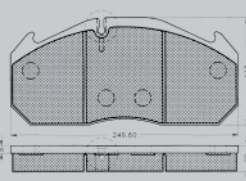
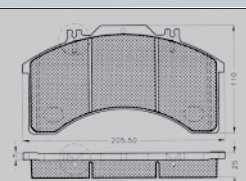
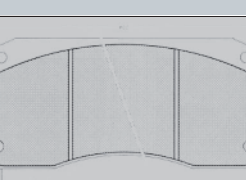
Bremsbelagsatz, Scheibenbremse Brake Pad Set, disc brake	Länge Length (mm)	240,5		03.120.8700.000 Vergl.-Nr. Comp.No WVA 29011
	Breite Width (mm)	124,8		
	Dicke/Stärke Thickness (mm)	25		
Bremsbelagsatz, Scheibenbremse Brake Pad Set, disc brake	Länge Length (mm)	149		03.120.8700.010 Vergl.-Nr. Comp.No WVA 29012
	Breite Width (mm)	69		
	Dicke/Stärke Thickness (mm)	18		
Bremsbelagsatz, Scheibenbremse Brake Pad Set, disc brake	Länge Length (mm)	249,5		03.120.8700.02P Vergl.-Nr. Comp.No WVA 29030
	Breite Width (mm)	118,1		
	Dicke/Stärke Thickness (mm)	28		
	Info	Premium quality		
	Info			
Bremsbelagsatz, Scheibenbremse Brake Pad Set, disc brake	Länge Length (mm)	249,5		03.120.8700.020 Vergl.-Nr. Comp.No WVA 29030
	Breite Width (mm)	118,1		
	Dicke/Stärke Thickness (mm)	28		
Bremsbelagsatz, Scheibenbremse Brake Pad Set, disc brake	Länge Length (mm)	205,5		03.120.8700.030 Vergl.-Nr. Comp.No WVA 29032
	Breite Width (mm)	110		
	Dicke/Stärke Thickness (mm)	25		
Bremsbelagsatz, Scheibenbremse Brake Pad Set, disc brake	Länge Length (mm)	203,6		03.120.8700.040 Vergl.-Nr. Comp.No WVA 29043
	Breite Width (mm)	95,5		
	Dicke/Stärke Thickness (mm)	24		



BG-03.120

Bremsbelagsatz, Scheibenbremse Brake Pad Set, disc brake

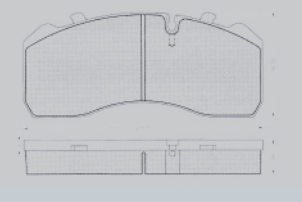
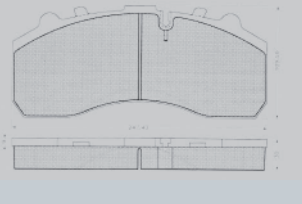
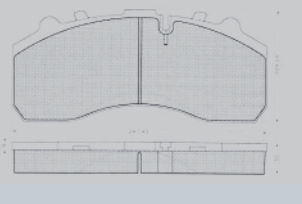
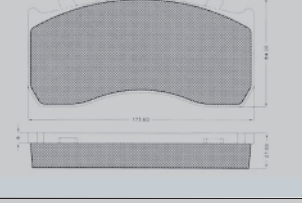

Bremsbelagsatz, Scheibenbremse Brake Pad Set, disc brake				
Bremsbelagsatz, Scheibenbremse Brake Pad Set, disc brake	Länge Length (mm)	175,45		03.120.8700.050 Vergl.-Nr. Comp.No WVA 29055
	Breite Width (mm)	82,45		
	Dicke/Stärke Thickness (mm)	22		
Bremsbelagsatz, Scheibenbremse Brake Pad Set, disc brake	Länge Length (mm)	174,8		03.120.8700.060 Vergl.-Nr. Comp.No WVA 29065
	Breite Width (mm)	85,6		
	Dicke/Stärke Thickness (mm)	22		
Bremsbelagsatz, Scheibenbremse Brake Pad Set, disc brake	Länge Length (mm)	175,35		03.120.8700.070 Vergl.-Nr. Comp.No WVA 29067
	Breite Width (mm)	78		
	Dicke/Stärke Thickness (mm)	22		
Bremsbelagsatz, Scheibenbremse Brake Pad Set, disc brake	Länge Length (mm)	164,8		03.120.8700.080 Vergl.-Nr. Comp.No WVA 29076
	Breite Width (mm)	73		
	Dicke/Stärke Thickness (mm)	20		
Bremsbelagsatz, Scheibenbremse Brake Pad Set, disc brake	Länge Length (mm)	175,3		03.120.8700.090 Vergl.-Nr. Comp.No WVA 29088
	Breite Width (mm)	86,15		
	Dicke/Stärke Thickness (mm)	26		
Bremsbelagsatz, Scheibenbremse Brake Pad Set, disc brake	Länge Length (mm)	249		03.120.8700.100 Vergl.-Nr. Comp.No WVA 29090
	Breite Width (mm)	114,44		
	Dicke/Stärke Thickness (mm)	28,3		
Bremsbelagsatz, Scheibenbremse Brake Pad Set, disc brake	Länge Length (mm)	210,3		03.120.8700.11P Vergl.-Nr. Comp.No WVA 29095
	Breite Width (mm)	92,45		
	Dicke/Stärke Thickness (mm)	30		
	Info	Premium quality		
	Info			

**Bremsbelagsatz, Scheibenbremse
Brake Pad Set, disc brake**
Bremsbelagsatz, Scheibenbremse | Brake Pad Set, disc brake

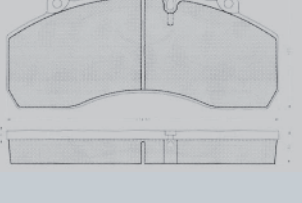
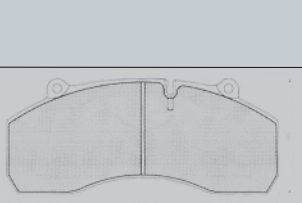
Bremsbelagsatz, Scheibenbremse Brake Pad Set, disc brake	Länge	210,3		03.120.8700.110
	Length (mm)			
	Breite	92,45		
	Width (mm)			
	Dicke/Stärke	30		
	Thickness (mm)			Vergl.-Nr. Comp.No WVA 29095
Bremsbelagsatz, Scheibenbremse Brake Pad Set, disc brake	Länge	247,4		03.120.8700.12P
	Length (mm)			
	Breite	109,5		
	Width (mm)			
	Dicke/Stärke	30		
	Thickness (mm)			
Info	Premium quality			Vergl.-Nr. Comp.No WVA 29087
Info				
Bremsbelagsatz, Scheibenbremse Brake Pad Set, disc brake	Länge	247,4		03.120.8700.120
	Length (mm)			
	Breite	109,5		
	Width (mm)			
	Dicke/Stärke	30		
	Thickness (mm)			Vergl.-Nr. Comp.No WVA 29087
Bremsbelagsatz, Scheibenbremse Brake Pad Set, disc brake	Länge	173,5		03.120.8700.130
	Length (mm)			
	Breite	84		
	Width (mm)			
	Dicke/Stärke	27		
	Thickness (mm)			Vergl.-Nr. Comp.No WVA 29115
Bremsbelagsatz, Scheibenbremse Brake Pad Set, disc brake	Länge	249,2		03.120.8700.140
	Length (mm)			
	Breite	111		
	Width (mm)			
	Dicke/Stärke	29		
	Thickness (mm)			Vergl.-Nr. Comp.No WVA 29125
Bremsbelagsatz, Scheibenbremse Brake Pad Set, disc brake	Länge	247,4		03.120.8700.15P
	Length (mm)			
	Breite	105		
	Width (mm)			
	Dicke/Stärke	30		
	Thickness (mm)			
Info	Premium quality			Vergl.-Nr. Comp.No WVA 29120
Info				
Bremsbelagsatz, Scheibenbremse Brake Pad Set, disc brake	Länge	247,4		03.120.8700.150
	Length (mm)			
	Breite	105		
	Width (mm)			
	Dicke/Stärke	30		
	Thickness (mm)			Vergl.-Nr. Comp.No WVA 29120



BG-03.120

Bremsbelagsatz, Scheibenbremse Brake Pad Set, disc brake

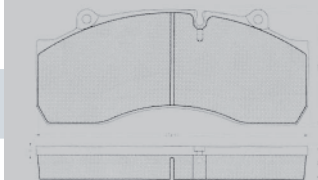
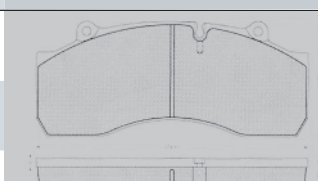
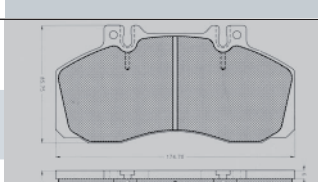
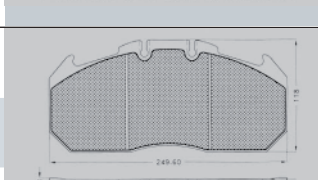
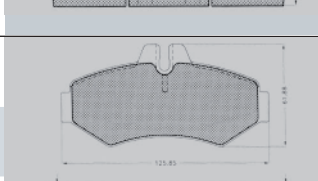
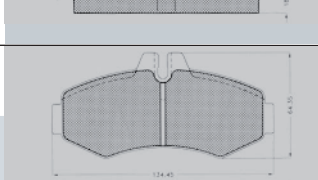
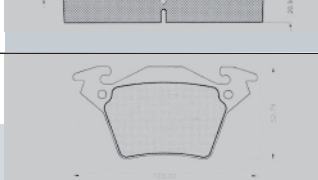

Bremsbelagsatz, Scheibenbremse Brake Pad Set, disc brake					
Bremsbelagsatz, Scheibenbremse Brake Pad Set, disc brake	Länge Length (mm)	247,4		03.120.8700.16P Vergl.-Nr. Comp.No WVA 29143	
	Breite Width (mm)	105			
	Dicke/Stärke Thickness (mm)	30			
	Info Info	Premium quality			
Bremsbelagsatz, Scheibenbremse Brake Pad Set, disc brake	Länge Length (mm)	247,4		03.120.8700.160 Vergl.-Nr. Comp.No WVA 29143	
	Breite Width (mm)	105			
	Dicke/Stärke Thickness (mm)	30			
Bremsbelagsatz, Scheibenbremse Brake Pad Set, disc brake	Länge Length (mm)	174,8		03.120.8700.170 Vergl.-Nr. Comp.No WVA 29835	
	Breite Width (mm)	85,6			
	Dicke/Stärke Thickness (mm)	22			
Bremsbelagsatz, Scheibenbremse Brake Pad Set, disc brake	Länge Length (mm)	249,3		03.120.8700.180 Vergl.-Nr. Comp.No WVA 29131	
	Breite Width (mm)	117,9			
	Dicke/Stärke Thickness (mm)	30,25			
Bremsbelagsatz, Scheibenbremse Brake Pad Set, disc brake	Länge Length (mm)	125,8		03.120.8700.190 Vergl.-Nr. Comp.No WVA 23021	
	Breite Width (mm)	62			
	Dicke/Stärke Thickness (mm)	18,8			
Bremsbelagsatz, Scheibenbremse Brake Pad Set, disc brake	Länge Length (mm)	134,4		03.120.8700.200 Vergl.-Nr. Comp.No WVA 23022	
	Breite Width (mm)	64,5			
	Dicke/Stärke Thickness (mm)	20,8			
Bremsbelagsatz, Scheibenbremse Brake Pad Set, disc brake	Länge Length (mm)	105		03.120.8700.210 Vergl.-Nr. Comp.No WVA 23020	
	Breite Width (mm)	52,8			
	Dicke/Stärke Thickness (mm)	17,8			

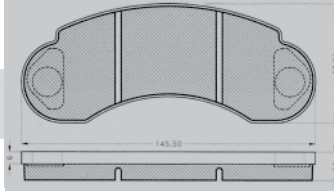
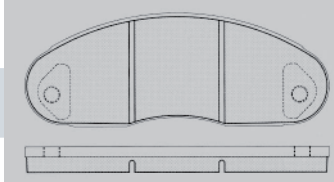
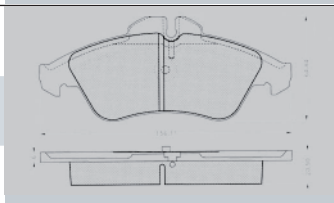
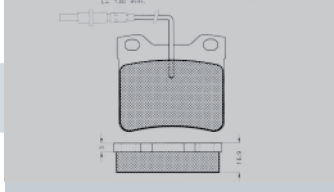
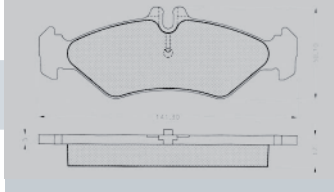
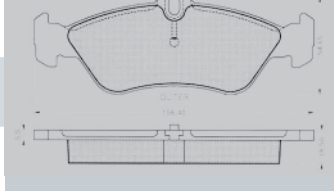
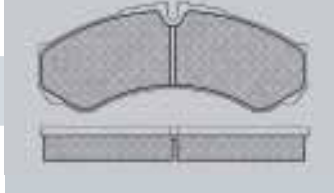
**Bremsbelagsatz, Scheibenbremse
Brake Pad Set, disc brake**
Bremsbelagsatz, Scheibenbremse | Brake Pad Set, disc brake

Bremsbelagsatz, Scheibenbremse Brake Pad Set, disc brake	Länge Length (mm)	145,5		03.120.8700.220 Vergl.-Nr. Comp.No WVA 20934
	Breite Width (mm)	60		
	Dicke/Stärke Thickness (mm)	14		
Bremsbelagsatz, Scheibenbremse Brake Pad Set, disc brake	Länge Length (mm)	166,6		03.120.8700.230 Vergl.-Nr. Comp.No WVA 29706
	Breite Width (mm)	62		
	Dicke/Stärke Thickness (mm)	17		
Bremsbelagsatz, Scheibenbremse Brake Pad Set, disc brake	Länge Length (mm)	156,5		03.120.8700.250 Vergl.-Nr. Comp.No WVA 21576
	Breite Width (mm)	64,9		
	Dicke/Stärke Thickness (mm)	20,5		
Bremsbelagsatz, Scheibenbremse Brake Pad Set, disc brake	Länge Length (mm)	63,8		03.120.8700.260 Vergl.-Nr. Comp.No WVA 21904
	Breite Width (mm)	57,55		
	Dicke/Stärke Thickness (mm)	17		
Bremsbelagsatz, Scheibenbremse Brake Pad Set, disc brake	Länge Length (mm)	141,4		03.120.8700.270 Vergl.-Nr. Comp.No WVA 21621
	Breite Width (mm)	50,2		
	Dicke/Stärke Thickness (mm)	17		
Bremsbelagsatz, Scheibenbremse Brake Pad Set, disc brake	Länge Length (mm)	156,4		03.120.8700.280 Vergl.-Nr. Comp.No WVA 21592
	Breite Width (mm)	54,8		
	Dicke/Stärke Thickness (mm)	18,5		
Bremsbelagsatz, Scheibenbremse Brake Pad Set, disc brake	Länge Length (mm)	164,5		03.120.8700.290 Vergl.-Nr. Comp.No WVA 29374
	Breite Width (mm)	66,3		
	Dicke/Stärke Thickness (mm)	20		
Bremsbelagsatz, Scheibenbremse Brake Pad Set, disc brake	Länge Length (mm)	174,6		03.120.8700.300 Vergl.-Nr. Comp.No WVA 29122
	Breite Width (mm)	85,4		
	Dicke/Stärke Thickness (mm)	22		

BG-03.120



Bremsbelagsatz, Scheibenbremse Brake Pad Set, disc brake



Bremsbelagsatz, Scheibenbremse | Brake Pad Set, disc brake

Bremsbelagsatz, Scheibenbremse Brake Pad Set, disc brake	Länge Length (mm)	210,2		03.120.8700.31P
	Breite Width (mm)	92,3		Vergl.-Nr. Comp.No WVA 29126
	Dicke/Stärke Thickness (mm)	30		
	Info	Premium quality		
	Info			
Bremsbelagsatz, Scheibenbremse Brake Pad Set, disc brake	Länge Length (mm)	210,2		03.120.8700.310
	Breite Width (mm)	92,3		Vergl.-Nr. Comp.No WVA 29126
	Dicke/Stärke Thickness (mm)	30		
Bremsbelagsatz, Scheibenbremse Brake Pad Set, disc brake	Länge Length (mm)	204,1		03.120.8700.320
	Breite Width (mm)	99,64		Vergl.-Nr. Comp.No WVA 29141
	Dicke/Stärke Thickness (mm)	29,85		
Bremsbelagsatz, Scheibenbremse Brake Pad Set, disc brake	Länge Length (mm)	175,2		03.120.8700.340
	Breite Width (mm)	88,5		Vergl.-Nr. Comp.No WVA 29136
	Dicke/Stärke Thickness (mm)	29,2		
Bremsbelagsatz, Scheibenbremse Brake Pad Set, disc brake	Länge Length (mm)	210,45		03.120.8700.35P
	Breite Width (mm)	109,46		Vergl.-Nr. Comp.No WVA 29162
	Dicke/Stärke Thickness (mm)	31		
	Info	Premium quality		
	Info			
Bremsbelagsatz, Scheibenbremse Brake Pad Set, disc brake	Länge Length (mm)	210,45		03.120.8700.350
	Breite Width (mm)	109,46		Vergl.-Nr. Comp.No WVA 29162
	Dicke/Stärke Thickness (mm)	31		
Bremsbelagsatz, Scheibenbremse Brake Pad Set, disc brake	Länge Length (mm)	209,8		03.120.8700.360
	Breite Width (mm)	101,8		Vergl.-Nr. Comp.No WVA 29137
	Dicke/Stärke Thickness (mm)	29,2		

**Bremsbelagsatz, Scheibenbremse
Brake Pad Set, disc brake**
Bremsbelagsatz, Scheibenbremse | Brake Pad Set, disc brake

Bremsbelagsatz, Scheibenbremse Brake Pad Set, disc brake	Länge Length (mm)	109,5		03.120.8700.380	
	Breite Width (mm)	63,47			Vergl.-Nr. Comp.No WVA 29123
	Dicke/Stärke Thickness (mm)	20,3			
Bremsbelagsatz, Scheibenbremse Brake Pad Set, disc brake	Länge Length (mm)	247,3		03.120.8700.390	
	Breite Width (mm)	107,75			Vergl.-Nr. Comp.No WVA 29154
	Dicke/Stärke Thickness (mm)	30			
Bremsbelagsatz, Scheibenbremse Brake Pad Set, disc brake	Länge Length (mm)	210,2		03.120.8700.41P	
	Breite Width (mm)	92,5			Vergl.-Nr. Comp.No WVA 29215
	Dicke/Stärke Thickness (mm)	30			
	Info	Premium quality			
	Info				
Bremsbelagsatz, Scheibenbremse Brake Pad Set, disc brake	Länge Length (mm)	210,2		03.120.8700.410	
	Breite Width (mm)	92,5			Vergl.-Nr. Comp.No WVA 29215
	Dicke/Stärke Thickness (mm)	30			
Bremsbelagsatz, Scheibenbremse Brake Pad Set, disc brake	Länge Length (mm)	247,2		03.120.8700.42P	
	Breite Width (mm)	109,5			Vergl.-Nr. Comp.No WVA 29216
	Dicke/Stärke Thickness (mm)	30			
	Info	Premium quality			
	Info				
Bremsbelagsatz, Scheibenbremse Brake Pad Set, disc brake	Länge Length (mm)	247,2		03.120.8700.420	
	Breite Width (mm)	109,5			Vergl.-Nr. Comp.No WVA 29216
	Dicke/Stärke Thickness (mm)	30			
Bremsbelagsatz, Scheibenbremse Brake Pad Set, disc brake	Länge Length (mm)	210,8		03.120.8700.430	
	Breite Width (mm)	108			Vergl.-Nr. Comp.No WVA 29158
	Dicke/Stärke Thickness (mm)	30			

BG-03.120



Bremsbelagsatz, Scheibenbremse Brake Pad Set, disc brake



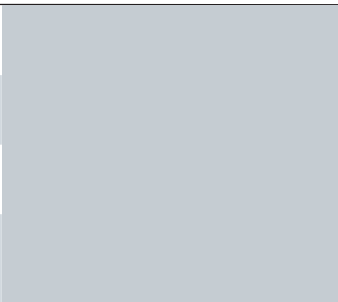



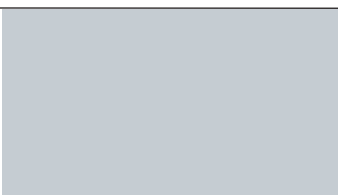
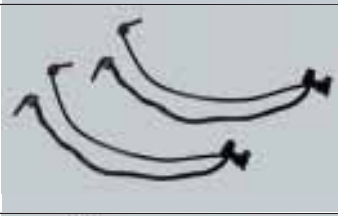
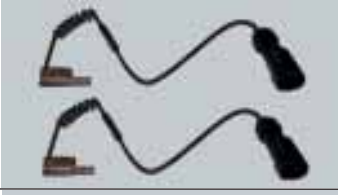
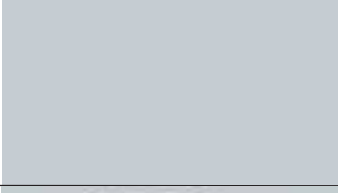
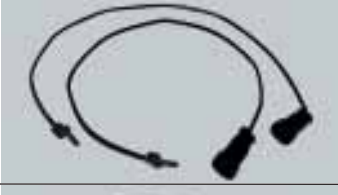

Bremsbelagsatz, Scheibenbremse | Brake Pad Set, disc brake

Bremsbelagsatz, Scheibenbremse	Länge	210,8		03.120.8700.43P
Brake Pad Set, disc brake	Length (mm)			
	Breite	108		
	Width (mm)			
	Dicke/Stärke	30		
	Thickness (mm)			
	Info	Premium quality		
	Info			Vergl.-Nr. Comp.No WVA 29158

Warnkontakt, Bremsbelagverschleiß | Alarm Sensor, brake lining wear

Warnkontakt, Bremsbelagverschleiß	Länge	365		03.130.8701.150
Alarm Sensor, brake lining wear	Length (mm)			
passend für to fit to WVA 29088				
				Vergl.-Nr. Comp.No 0190 6468
Warnkontakt, Bremsbelagverschleiß	Länge	270		03.130.8701.000
Alarm Sensor, brake lining wear	Length (mm)			
passend für to fit to WVA 29108; WVA 29120; WVA 29143; WVA 19185				
				Vergl.-Nr. Comp.No WVA29032
Warnkontakt, Bremsbelagverschleiß	Länge	430		03.130.8701.010
Alarm Sensor, brake lining wear	Length (mm)			
passend für to fit to WVA 29011; WVA 29032				
				Vergl.-Nr. Comp.No 1908 231
Warnkontakt, Bremsbelagverschleiß	Länge	500		03.130.8701.020
Alarm Sensor, brake lining wear	Length (mm)			
passend für to fit to WVA 29065; WVA 29067				
				Vergl.-Nr. Comp.No WVA29067
Warnkontakt, Bremsbelagverschleiß	Länge	500		03.130.8701.030
Alarm Sensor, brake lining wear	Length (mm)			
passend für to fit to WVA 29065; WVA 29067				
				Vergl.-Nr. Comp.No WVA29067
Warnkontakt, Bremsbelagverschleiß	Länge	475		03.130.8701.040
Alarm Sensor, brake lining wear	Length (mm)			
passend für to fit to WVA 29067				
				Vergl.-Nr. Comp.No WVA29067

**Warnkontakt, Bremsbelagverschleiß
Alarm Sensor, brake lining wear**

Warnkontakt, Bremsbelagverschleiß Alarm Sensor, brake lining wear			
Warnkontakt, Bremsbelagverschleiß Alarm Sensor, brake lining wear	Länge Length (mm)	295	03.130.8701.050
passend für to fit to WVA 29067; WVA 29374			Vergl.-Nr. Comp.No WVA29067
Warnkontakt, Bremsbelagverschleiß Alarm Sensor, brake lining wear	Länge 1 Length 1 (mm)	885	03.130.8701.060
	Länge 2 Length 2 (mm)	780	Vergl.-Nr. Comp.No WVA29065
passend für to fit to WVA 29065			
Warnkontakt, Bremsbelagverschleiß Alarm Sensor, brake lining wear	Länge 1 Length 1 (mm)	380	03.130.8701.070
	Länge 2 Length 2 (mm)	337	Vergl.-Nr. Comp.No WVA29065
passend für to fit to WVA 29055; WVA 29093			
Warnkontakt, Bremsbelagverschleiß Alarm Sensor, brake lining wear	Länge Length (mm)	355	03.130.8701.090
passend für to fit to WVA 29030; WVA 29090			Vergl.-Nr. Comp.No WVA29090
			
Warnkontakt, Bremsbelagverschleiß Alarm Sensor, brake lining wear	Länge Length (mm)	215	03.130.8701.100
passend für to fit to WVA 29090			Vergl.-Nr. Comp.No
			
Warnkontakt, Bremsbelagverschleiß Alarm Sensor, brake lining wear	Länge 1 Length 1 (mm)	278	03.130.8701.130
	Länge 2 Length 2 (mm)	246	Vergl.-Nr. Comp.No WVA29088
passend für to fit to WVA 29088; WVA 29030			
Warnkontakt, Bremsbelagverschleiß Alarm Sensor, brake lining wear	Länge Length (mm)	300	03.130.8701.140
passend für to fit to WVA 29088; WVA 29131; WVA 29142			Vergl.-Nr. Comp.No WVA29131
			
Warnkontakt, Bremsbelagverschleiß Alarm Sensor, brake lining wear	Länge Length (mm)	420	03.130.8701.160
passend für to fit to WVA 29043			Vergl.-Nr. Comp.No WVA 29043
			

BG-03.130





Warnkontakt, Bremsbelagverschleiß Alarm Sensor, brake lining wear



Warnkontakt, Bremsbelagverschleiß | Alarm Sensor, brake lining wear

Warnkontakt, Bremsbelagverschleiß Alarm Sensor, brake lining wear	Länge 1 Length 1 (mm)	220		03.130.8701.170 Vergl.-Nr. Comp.No WVA 29835
passend für to fit to WVA 29835; WVA 29030	Länge 2 Length 2 (mm)	310		
Warnkontakt, Bremsbelagverschleiß Alarm Sensor, brake lining wear	Länge Length (mm)	355		03.130.8701.180 Vergl.-Nr. Comp.No 81.50811.0004
passend für to fit to WVA 29030				
Warnkontakt, Bremsbelagverschleiß Alarm Sensor, brake lining wear	Länge 1 Length 1 (mm)	340		03.130.8701.190 Vergl.-Nr. Comp.No WVA 29030
passend für to fit to WVA 29030	Länge 2 Length 2 (mm)	230		
Warnkontakt, Bremsbelagverschleiß Alarm Sensor, brake lining wear	Länge Length (mm)	405		03.130.8701.200 Vergl.-Nr. Comp.No
passend für to fit to WVA 29011; WVA 29032				
Warnkontakt, Bremsbelagverschleiß Alarm Sensor, brake lining wear	Länge Length (mm)	380		03.130.8701.220 Vergl.-Nr. Comp.No
passend für to fit to WVA 29142; WVA 29141; WVA 29119; WVA 29159; WVA 29126				
Warnkontakt, Bremsbelagverschleiß Alarm Sensor, brake lining wear	Länge Length (mm)	450		03.130.8701.230 Vergl.-Nr. Comp.No
passend für to fit to WVA 29159; WVA 29126				
Warnkontakt, Bremsbelagverschleiß Alarm Sensor, brake lining wear	Länge Length (mm)	238		03.130.1935.000 Vergl.-Nr. Comp.No 669 540 04 17
passend für to fit to Mercedes-Benz				
Warnkontakt, Bremsbelagverschleiß Alarm Sensor, brake lining wear	Länge 1 Length 1 (mm)	120		03.130.1935.020 Vergl.-Nr. Comp.No 677 540 07 17
passend für to fit to Mercedes-Benz	Länge 2 Length 2 (mm)	190		
	Höhe Height (mm)	8,3		

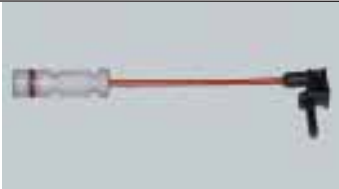
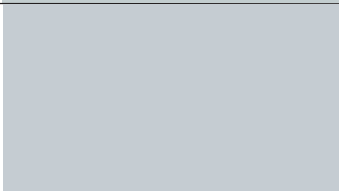
**Warnkontakt, Bremsbelagverschleiß
Alarm Sensor, brake lining wear**

Warnkontakt, Bremsbelagverschleiß Alarm Sensor, brake lining wear			
Warnkontakt, Bremsbelagverschleiß Alarm Sensor, brake lining wear	Länge 1 Length 1 (mm)	120	 <p>03.130.1935.030</p> <p>Vergl.-Nr. Comp.No 677 540 08 17</p>
passend für to fit to Mercedes-Benz	Länge 2 Length 2 (mm)	190	
	Höhe Height (mm)	8,3	
Warnkontakt, Bremsbelagverschleiß Alarm Sensor, brake lining wear	Länge Length (mm)	90	 <p>03.130.1935.040</p> <p>Vergl.-Nr. Comp.No 000 540 02 17</p>
passend für to fit to Mercedes-Benz			
Warnkontakt, Bremsbelagverschleiß Alarm Sensor, brake lining wear	Länge Length (mm)	90	 <p>03.130.1935.050</p> <p>Vergl.-Nr. Comp.No 601 540 13 17</p>
passend für to fit to Mercedes-Benz			
Warnkontakt, Bremsbelagverschleiß Alarm Sensor, brake lining wear	Länge Length (mm)	155	 <p>03.130.1935.060</p> <p>Vergl.-Nr. Comp.No 356 540 00 17</p>
passend für to fit to Mercedes-Benz			
Warnkontakt, Bremsbelagverschleiß Alarm Sensor, brake lining wear	Länge Length (mm)	210	 <p>03.130.1935.070</p> <p>Vergl.-Nr. Comp.No 901 540 00 17</p>
passend für to fit to Mercedes-Benz			

BG-03.130

Zubehörsatz, Scheibenbremsbelag Accessory Kit, disc brake pads



Zubehörsatz, Scheibenbremsbelag Accessory Kit, disc brake pads		
Zubehörsatz, Scheibenbremsbelag Accessory Kit, disc brake pads passend für to fit to WVA 29030		03.130.8702.00S Vergl.-Nr. Comp.No
Zubehörsatz, Scheibenbremsbelag Accessory Kit, disc brake pads passend für to fit to WVA 29030		03.130.8702.01S Vergl.-Nr. Comp.No
Zubehörsatz, Scheibenbremsbelag Accessory Kit, disc brake pads passend für to fit to WVA 29032		03.130.8702.02S Vergl.-Nr. Comp.No
Zubehörsatz, Scheibenbremsbelag Accessory Kit, disc brake pads passend für to fit to WVA 29067		03.130.8702.03S Vergl.-Nr. Comp.No
Zubehörsatz, Scheibenbremsbelag Accessory Kit, disc brake pads passend für to fit to WVA 29076		03.130.8702.04S Vergl.-Nr. Comp.No
Zubehörsatz, Scheibenbremsbelag Accessory Kit, disc brake pads passend für to fit to WVA 29088		03.130.8702.05S Vergl.-Nr. Comp.No
Zubehörsatz, Scheibenbremsbelag Accessory Kit, disc brake pads passend für to fit to WVA 29090		03.130.8702.06S Vergl.-Nr. Comp.No
Zubehörsatz, Scheibenbremsbelag Accessory Kit, disc brake pads passend für to fit to WVA 29087; WVA 29108		03.130.8702.07S Vergl.-Nr. Comp.No

**Zubehörsatz, Scheibenbremsbelag
Accessory Kit, disc brake pads**

Zubehörsatz, Scheibenbremsbelag Accessory Kit, disc brake pads		
<p>Zubehörsatz, Scheibenbremsbelag Accessory Kit, disc brake pads</p> <p>passend für to fit to WVA 29087; WVA 29108</p>		<p>03.130.8702.08S</p> <p>Vergl.-Nr. Comp.No</p>
<p>Zubehörsatz, Scheibenbremsbelag Accessory Kit, disc brake pads</p> <p>passend für to fit to WVA 20934; WVA 21573</p>		<p>03.130.8702.09S</p> <p>Vergl.-Nr. Comp.No</p>
<p>Zubehörsatz, Scheibenbremsbelag Accessory Kit, disc brake pads</p> <p>passend für to fit to WVA 29374</p>		<p>03.130.8702.10S</p> <p>Vergl.-Nr. Comp.No</p>

SERVICE-HOTLINE

FON: +49 5156-9610-0

FAX: +49 5156-961196



aufsteigend nach ST-Nr. | ascending to ST-No.

03.010.0240.210	09.097.02.07.0
03.010.0240.210	09.097.02.07.1
03.010.0240.210	09.097.02.37.0
03.010.0240.210	09.097.02.37.1
03.010.0240.220	09.097.02.08.0
03.010.0240.220	09.097.02.08.1
03.010.0240.220	09.097.02.38.0
03.010.0240.220	09.097.02.38.1
03.010.0240.230	09.097.05.01.0
03.010.0240.230	09.097.05.01.1
03.010.0240.231	05.097.05.01.1
03.010.0240.231	05.097.05.01.3
03.010.0240.240	09.097.05.02.0
03.010.0240.240	09.097.05.02.1
03.010.0240.241	05.097.05.02.1
03.010.0240.241	05.097.05.02.3
03.010.0240.250	09.097.05.03.0
03.010.0240.250	09.097.05.03.1
03.010.0240.251	05.097.05.03.0
03.010.0240.251	05.097.05.03.1
03.010.0240.251	05.097.05.03.3
03.010.0240.270	09.097.05.05.0
03.010.0240.270	09.097.05.05.1
03.010.0240.271	05.097.05.05.0
03.010.0240.271	05.097.05.05.1
03.010.0240.271	05.097.05.05.3
03.010.0240.280	09.097.05.06.0
03.010.0240.280	09.097.05.06.1
03.010.0240.281	05.097.05.06.0
03.010.0240.281	05.097.05.06.1
03.010.0240.281	05.097.05.06.3
03.010.0240.290	09.097.05.07.0
03.010.0240.290	09.097.05.07.1
03.010.0240.291	05.097.05.07.0
03.010.0240.291	05.097.05.07.1
03.010.0240.291	05.097.05.07.3
03.010.0240.300	09.097.05.08.0
03.010.0240.300	09.097.05.08.1
03.010.0240.301	05.097.05.08.0
03.010.0240.301	05.097.05.08.1
03.010.0240.301	05.097.05.08.3
03.010.0240.310	09.097.05.09.0

03.010.0240.310	09.097.05.09.1
03.010.0240.311	05.097.05.09.0
03.010.0240.311	05.097.05.09.1
03.010.0240.311	05.097.05.09.3
03.010.0240.320	09.097.05.10.0
03.010.0240.320	09.097.05.10.1
03.010.0240.321	05.097.05.10.0
03.010.0240.321	05.097.05.10.1
03.010.0240.321	05.097.05.10.3
03.010.0240.330	09.097.05.11.0
03.010.0240.330	09.097.05.11.1
03.010.0240.331	05.097.05.11.0
03.010.0240.331	05.097.05.11.1
03.010.0240.331	05.097.05.11.3
03.010.0240.340	09.097.05.12.0
03.010.0240.340	09.097.05.12.1
03.010.0240.341	05.097.05.12.0
03.010.0240.341	05.097.05.12.1
03.010.0240.341	05.097.05.12.3
03.010.0240.350	09.097.05.13.0
03.010.0240.350	09.097.05.13.1
03.010.0240.351	05.097.05.13.0
03.010.0240.351	05.097.05.13.1
03.010.0240.351	05.097.05.13.3
03.010.0240.360	09.097.05.14.0
03.010.0240.360	09.097.05.14.1
03.010.0240.361	05.097.05.14.0
03.010.0240.361	05.097.05.14.1
03.010.0240.361	05.097.05.14.3
03.010.0240.370	09.097.05.15.0
03.010.0240.370	09.097.05.15.1
03.010.0240.371	05.097.05.15.0
03.010.0240.371	05.097.05.15.1
03.010.0240.371	05.097.05.15.3
03.010.0240.380	09.097.05.16.0
03.010.0240.380	09.097.05.16.1
03.010.0240.381	05.097.05.16.0
03.010.0240.381	05.097.05.16.1
03.010.0240.381	05.097.05.16.3
03.010.0240.390	09.097.05.17.0
03.010.0240.390	09.097.05.17.1
03.010.0240.391	05.097.05.17.0

Vergleichsliste | Crosslist

aufsteigend nach ST-Nr. | ascending to ST-No.

03.010.0240.391	05.097.05.17.1	03.010.0240.480	09.097.05.26.0
03.010.0240.391	05.097.05.17.3	03.010.0240.480	09.097.05.26.1
03.010.0240.400	09.097.05.18.0	03.010.0240.481	05.097.05.26.0
03.010.0240.400	09.097.05.18.1	03.010.0240.481	05.097.05.26.1
03.010.0240.401	05.097.05.18.0	03.010.0240.481	05.097.05.26.3
03.010.0240.401	05.097.05.18.1	03.010.0240.490	09.097.05.27.0
03.010.0240.401	05.097.05.18.3	03.010.0240.490	09.097.05.27.1
03.010.0240.410	09.097.05.19.0	03.010.0240.491	05.097.05.27.0
03.010.0240.410	09.097.05.19.1	03.010.0240.491	05.097.05.27.1
03.010.0240.411	05.097.05.19.0	03.010.0240.491	05.097.05.27.3
03.010.0240.411	05.097.05.19.1	03.010.0240.500	09.097.05.28.0
03.010.0240.411	05.097.05.19.3	03.010.0240.500	09.097.05.28.1
03.010.0240.420	09.097.05.20.0	03.010.0240.501	05.097.05.28.0
03.010.0240.420	09.097.05.20.1	03.010.0240.501	05.097.05.28.1
03.010.0240.421	05.097.05.20.0	03.010.0240.501	05.097.05.28.3
03.010.0240.421	05.097.05.20.1	03.010.0240.510	09.097.05.29.0
03.010.0240.421	05.097.05.20.3	03.010.0240.510	09.097.05.29.1
03.010.0240.430	09.097.05.21.0	03.010.0240.511	05.097.05.29.0
03.010.0240.430	09.097.05.21.1	03.010.0240.511	05.097.05.29.1
03.010.0240.431	05.097.05.21.0	03.010.0240.511	05.097.05.29.3
03.010.0240.431	05.097.05.21.1	03.010.0240.520	09.097.05.30.0
03.010.0240.431	05.097.05.21.3	03.010.0240.520	09.097.05.30.1
03.010.0240.440	09.097.05.22.0	03.010.0240.521	05.097.05.30.0
03.010.0240.440	09.097.05.22.1	03.010.0240.521	05.097.05.30.1
03.010.0240.441	05.097.05.22.0	03.010.0240.521	05.097.05.30.3
03.010.0240.441	05.097.05.22.1	03.010.0240.530	09.097.05.31.0
03.010.0240.441	05.097.05.22.3	03.010.0240.530	09.097.05.31.1
03.010.0240.450	09.097.05.23.0	03.010.0240.531	05.097.05.31.1
03.010.0240.450	09.097.05.23.1	03.010.0240.531	05.097.05.31.3
03.010.0240.451	05.097.05.23.0	03.010.0240.541	05.097.05.32.1
03.010.0240.451	05.097.05.23.1	03.010.0240.541	05.097.05.32.3
03.010.0240.451	05.097.05.23.3	03.010.0240.570	09.097.05.35.0
03.010.0240.460	09.097.05.24.0	03.010.0240.570	09.097.05.35.1
03.010.0240.460	09.097.05.24.1	03.010.0240.571	05.097.05.35.1
03.010.0240.461	05.097.05.24.0	03.010.0240.571	05.097.05.35.3
03.010.0240.461	05.097.05.24.1	03.010.0240.580	09.097.05.36.0
03.010.0240.461	05.097.05.24.3	03.010.0240.580	09.097.05.36.1
03.010.0240.470	09.097.05.25.0	03.010.0240.581	05.097.05.36.1
03.010.0240.470	09.097.05.25.1	03.010.0240.581	05.097.05.36.3
03.010.0240.471	05.097.05.25.0	03.010.0240.590	09.097.05.37.0
03.010.0240.471	05.097.05.25.1	03.010.0240.590	09.097.05.37.1
03.010.0240.471	05.097.05.25.3	03.010.0240.591	05.097.05.37.0

aufsteigend nach ST-Nr. | ascending to ST-No.

03.010.0240.591	05.097.05.37.1	03.010.0658.000	010.24.21.849.78
03.010.0240.591	05.097.05.37.3	03.010.0692.000	010.24.21.849.59
03.010.0240.600	09.097.05.38.0	03.010.0903.510	81.50301.0271
03.010.0240.600	09.097.05.38.1	03.010.0903.520	81.50301.0272
03.010.0240.601	05.097.05.38.0	03.010.0908.170	305 421 18 36
03.010.0240.601	05.097.05.38.1	03.010.0908.170	307 421 00 36
03.010.0240.601	05.097.05.38.3	03.010.0908.170	81.50301.0153
03.010.0240.610	09.097.05.39.0	03.010.0908.170	81.50301.0225
03.010.0240.610	09.097.05.39.1	03.010.0908.180	305 421 19 36
03.010.0240.611	05.097.05.39.0	03.010.0908.180	307 421 01 36
03.010.0240.611	05.097.05.39.1	03.010.0908.180	81.50301.0154
03.010.0240.611	05.097.05.39.3	03.010.0908.180	81.50301.0226
03.010.0240.620	09.097.05.40.0	03.010.1905.830	389 421 01 36
03.010.0240.620	09.097.05.40.1	03.010.1905.830	623 421 01 36
03.010.0240.621	05.097.05.40.0	03.010.1905.830	81.50301.0223
03.010.0240.621	05.097.05.40.1	03.010.1905.840	389 421 02 36
03.010.0240.621	05.097.05.40.3	03.010.1905.840	623 421 02 36
03.010.0240.670	09.097.05.45.0	03.010.1905.840	81.50301.0224
03.010.0240.670	09.097.05.45.1	03.010.1905.860	346 423 11 36
03.010.0240.671	05.097.05.45.0	03.010.1905.860	623 423 01 36
03.010.0240.671	05.097.05.45.1	03.010.1905.860	81.50301.0113
03.010.0240.671	05.097.05.45.3	03.010.1905.870	346 423 12 36
03.010.0240.680	09.097.05.46.0	03.010.1905.870	623 423 02 36
03.010.0240.680	09.097.05.46.1	03.010.1905.870	81.50301.0112
03.010.0240.681	05.097.05.46.0	03.010.2158.000	2.262.0283.01
03.010.0240.681	05.097.05.46.1	03.010.2158.000	2.262.0283.02
03.010.0240.681	05.097.05.46.3	03.010.2158.000	3.262.0283.01
03.010.0240.690	09.097.05.47.0	03.010.2159.000	2.262.0284.01
03.010.0240.690	09.097.05.47.1	03.010.2159.000	2.262.0284.02
03.010.0240.691	05.097.05.47.0	03.010.2159.000	3.262.0284.01
03.010.0240.691	05.097.05.47.1	03.010.2161.000	2.262.0293.02
03.010.0240.691	05.097.05.47.3	03.010.2162.000	2.262.0294.02
03.010.0240.700	09.097.05.48.0	03.010.2163.000	2.262.0261.01
03.010.0240.700	09.097.05.48.1	03.010.2163.000	2.262.0261.02
03.010.0240.701	05.097.05.48.0	03.010.2163.000	3.262.0261.01
03.010.0240.701	05.097.05.48.1	03.010.2164.000	2.262.0262.01
03.010.0240.701	05.097.05.48.3	03.010.2164.000	2.262.0262.02
03.010.0290.700	A-JA-0476-003	03.010.2164.000	3.262.0262.01
03.010.0290.710	A-JA-0476-004	03.010.2165.000	2.262.0253.01
03.010.0290.720	A-JA-0660-003	03.010.2165.000	2.262.0253.02
03.010.0290.730	A-JA-0660-004	03.010.2165.000	3.262.0253.01
03.010.0657.000	010.24.21.849.77	03.010.2166.000	2.262.0254.01

Vergleichsliste | Crosslist



aufsteigend nach ST-Nr. | ascending to ST-No.

03.010.2166.000	2.262.0254.02
03.010.2166.000	3.262.0254.01
03.010.2167.000	2.262.0285.01
03.010.2167.000	2.262.0285.02
03.010.2167.000	3.262.0285.01
03.010.2168.000	2.262.0286.01
03.010.2168.000	2.262.0286.02
03.010.2168.000	3.262.0286.01
03.010.2191.000	2.262.0271.01
03.010.2191.000	2.262.0271.02
03.010.2191.000	3.262.0271.01
03.010.2202.000	2.262.0279.01
03.010.2202.000	2.262.0279.02
03.010.2202.000	3.262.0279.01
03.010.2203.000	2.262.0280.01
03.010.2203.000	2.262.0280.02
03.010.2203.000	3.262.0280.01
03.010.2212.000	2.262.0331.01
03.010.2212.000	3.262.0331.01
03.010.2213.000	2.262.0332.01
03.010.2213.000	3.262.0332.01
03.010.2240.000	2.262.0403.02
03.010.2240.000	3.262.0403.02
03.010.2241.000	2.262.0404.02
03.010.2241.000	3.262.0404.02
03.010.2242.000	2.262.0411.02
03.010.2242.000	3.262.0411.02
03.010.2243.000	2.262.0412.02
03.010.2243.000	3.262.0412.02
03.010.2244.000	2.262.0415.02
03.010.2244.000	3.262.0415.02
03.010.2245.000	2.262.0416.02
03.010.2245.000	3.262.0416.02
03.010.2251.000	2.262.1102.02
03.010.2252.000	2.262.1103.02
03.010.2253.000	2.262.1102.01
03.010.2254.000	2.262.1103.01
03.010.2255.000	2.262.1110.02
03.010.2256.000	2.262.1111.02
03.010.3500.200	M003036
03.010.3500.200	M023433
03.010.3500.200	M044473

03.010.3500.210	M003028
03.010.3500.210	M023425
03.010.3500.210	M044465
03.010.3500.220	6503339G
03.010.3500.220	6503391M
03.010.3500.230	6503340Z
03.010.3500.230	6503390L
03.010.4200.810	212 21 070
03.010.4200.820	212 21 071
03.010.4200.830	212 21 194
03.010.4200.840	212 21 195
03.010.4200.850	212 19 257
03.010.4200.860	212 19 258
03.020.0238.011	03.113.14.03.0
03.020.0238.020	03.229.02.16.0
03.020.0238.030	03.229.02.17.0
03.020.0238.040	03.120.43.12.0
03.020.0240.080	03.112.44.30.0
03.020.0240.082	03.112.44.34.0
03.020.0240.090	03.112.44.22.0
03.020.0240.150	03.113.14.01.0
03.020.0240.840	03.120.43.14.0
03.020.0240.840	03.120.63.01.0
03.020.0241.0 S	09.801.00.14.0
03.020.0241.1 S	09.801.00.14.1
03.020.0241.150	03.229.02.03.0
03.020.0241.2 S	09.801.00.14.2
03.020.0241.3 S	09.801.00.24.1
03.020.0241.3 S	09.801.00.24.2
03.020.0241.4 S	09.801.00.14.1 S
03.020.0241.5 S	09.801.00.43.1
03.020.0241.6 S	09.801.02.15.0
03.020.0242.0 S	09.801.00.26.0 S
03.020.0242.3 S	03.112.44.30.0 S
03.020.0242.300	02.3502.04.00
03.020.0242.300	03.350.30.01.0
03.020.0242.300	03.350.30.02.0
03.020.0242.4 S	03.112.44.30.0 S
03.020.0242.4 S	03.112.44.30.0 SP
03.020.0242.600	02.5676.01.00
03.020.0242.620	02.5677.37.42
03.020.0242.7 S	09.801.02.13.0

aufsteigend nach ST-Nr. | ascending to ST-No.

03.020.0242.81S	09.801.02.22.0	03.020.1909.020	81.50308.0006
03.020.0242.81S	09.801.02.22.0.	03.020.1909.020	81.50308.0011
03.020.0242.85S	09.801.06.09.1	03.020.1909.050	307 994 00 35
03.020.0243.2 S	02.5616.05.90	03.020.1909.070	346 423 05 52
03.020.0243.520	03.120.42.02.0	03.020.1909.080	346 423 00 57
03.020.0244.270	03.310.81.02.0	03.020.1909.090	346 423 01 57
03.020.0244.280	02.5679.23.00	03.020.1909.090	81.90711.0714
03.020.0244.290	03.320.11.10.0	03.020.1909.100	346 421 09 52
03.020.0244.600	03.320.11.16.0	03.020.1909.100	81.90711.0738
03.020.0244.600	03.320.11.16.1	03.020.1909.110	346 421 05 52
03.020.0244.700	02.5616.04.90	03.020.1909.110	81.90711.0707
03.020.0244.740	02.5616.05.90	03.020.1909.120	346 421 06 52
03.020.0245.380	03.229.02.01.0	03.020.1909.120	81.90711.0706
03.020.0245.380	03.229.02.09.0	03.020.1909.130	346 421 07 52
03.020.0245.390	03.229.02.10.0	03.020.1909.130	81.90711.0705
03.020.0246.220	03.120.43.09.0	03.020.1909.140	346 421 08 52
03.020.0246.230	03.120.43.10.0	03.020.1909.150	346 421 10 52
03.020.0246.3 S	03.113.14.01.0 S	03.020.1909.150	81.90711.0739
03.020.0247.800	03.113.03.06.0	03.020.1909.160	000471 034000
03.020.0247.870	03.120.42.09.0	03.020.1909.160	06.29010.0127
03.020.0247.880	03.120.42.08.0	03.020.1909.720	385 421 01 52
03.020.0247.900	03.229.02.18.0	03.020.2001.S00	3.317.0004.00
03.020.0290.190	A-JB-0001-001	03.020.2003.000	1.230.0036.00
03.020.0290.410	AR-JA-0199-705	03.020.2008.000	1.230.0062.00
03.020.0690.000	015.26.22.101.51	03.020.2008.000	1.230.0062.01
03.020.0691.000	015.26.22.103.51	03.020.2017.000	1.230.0089.00
03.020.0692.0 S	8.951.038.200	03.020.2028.S00	3.268.0007.02
03.020.0905.400	81.91710.0163	03.020.2028.S00	3.268.0029.00
03.020.0905.420	06.33719.0057	03.020.2028.S00	3.268.0034.00
03.020.0905.420	06.33719.0058	03.020.2028.100	1.230.1002.04
03.020.0905.420	06.33719.0061	03.020.2028.100	3.230.1002.04
03.020.0909.0 S	81.51901.6005	03.020.2029.S00	3.268.0007.01
03.020.0910.0 S	81.51901.6006	03.020.2029.100	3.230.1002.03
03.020.1733.11S	322 426 01 83 S	03.020.2029.200	3.317.0011.00
03.020.1902.0 S	06.36959.0014 S	03.020.2029.300	3.317.0016.00
03.020.1902.0 S	360 420 04 41	03.020.2029.400	3.268.0006.00
03.020.1902.0 S	360 586 04 42	03.020.2036.200	1.350.2001.04
03.020.1905.0 S	360 420 03 41	03.020.2037.100	1.093.0012.00
03.020.1905.1 S	305 421 07 50 S	03.020.2037.400	4.315.0048.00
03.020.1906.0 S	322 426 01 83 S	03.020.2037.500	1.094.0034.00
03.020.1909.010	381 423 00 58	03.020.2038.200	4.230.0176.00
03.020.1909.020	346 423 00 58	03.020.2038.300	4.230.0180.00

Vergleichsliste | Crosslist

aufsteigend nach ST-Nr. | ascending to ST-No.

03.020.2044.000	1.072.0017.01	03.020.4200.450	152 20 224
03.020.2045.000	1.072.0018.00	03.020.4200.450	152 24 821
03.020.2046.000	4.315.0001.00	03.020.4200.460	152 13 430
03.020.2046.000	4.315.0001.01	03.020.4200.460	152 20 720
03.020.2052.000	4.315.0003.00	03.020.4200.480	212 09 990
03.020.2062.000	1.331.0056.00	03.030.0240.870	05.174.52.10.0
03.020.2063.000	4.348.1006.00	03.030.0240.870	100101041
03.020.2144.000	1.230.1001.01	03.030.0240.870	2100200008
03.020.2147.000	1.230.0106.02	03.030.0240.880	05.174.52.23.0
03.020.2147.000	1.230.0106.03	03.030.0240.880	100001128
03.020.2147.000	1.230.0106.04	03.030.0240.890	05.174.52.34.0
03.020.2160.S00	3.317.0006.00	03.030.0240.890	100001021
03.020.2169.1 S	3.268.0047.00	03.030.0240.890	2100200001
03.020.2169.100	3.268.0045.00	03.030.0240.890	335 420 03 38
03.020.2169.2 S	3.268.0050.00	03.030.0240.900	05.174.52.61.0
03.020.2169.200	3.268.0046.00	03.030.0240.900	100001721
03.020.2183.000	1.072.0060.00	03.030.0240.900	2100200701
03.020.2184.S00	1.230.2001.01 S	03.030.0241.850	05.397.26.02.0
03.020.2184.000	1.230.2001.01	03.030.0241.860	05.397.26.01.0
03.020.2184.1 S	3.434.3620.00	03.030.0241.860	05.397.26.02.0
03.020.2184.2 S	3.434.3622.00	03.030.0244.901	05.174.65.13.0
03.020.2184.3 S	3.434.3637.00	03.030.0244.901	100001760
03.020.2184.5 S	3.434.3638.00	03.030.0285.001	100101364
03.020.2184.6 S	3.434.3639.00	03.030.0285.001	285 952
03.020.2185.S00	3.434.3601.00	03.030.0285.001	286 952
03.020.2185.000	4.315.0002.00	03.030.0285.001	505 835
03.020.2187.000	1.331.0015.00	03.030.0285.001	663 772
03.020.2188.000	4.348.1005.00	03.030.0285.001	663 773
03.020.2220.100	1.094.0019.00	03.030.0287.000	104401201
03.020.2280.S00	3.434.3636.00	03.030.0287.000	285 951
03.020.3004.520	134 494	03.030.0287.000	351 952
03.020.3004.520	289 336	03.030.0287.000	505 839
03.020.3504.1 S	6503723T	03.030.0288.001	100101364
03.020.3504.3 S	6502103X	03.030.0288.001	285 952
03.020.3504.390	6502103X	03.030.0288.001	286 952
03.020.3504.430	6503723T	03.030.0288.001	505 835
03.020.4004.890	1573 522	03.030.0288.001	663 772
03.020.4004.890	1606 683	03.030.0288.001	663 773
03.020.4004.890	351 132	03.030.0695.200	100002167
03.020.4200.230	AXL 112	03.030.0695.200	8.283.000.5620
03.020.4200.240	AXL 122	03.030.1906.560	05.174.54.69.0
03.020.4200.250	AXL 132	03.030.1906.560	104407401

aufsteigend nach ST-Nr. | ascending to ST-No.

03.030.1906.560	346 420 17 38
03.030.1906.570	05.174.45.70.0
03.030.1906.570	104507401
03.030.1906.570	346 420 18 38
03.030.2085.500	100101047
03.030.2085.500	2.175.0037.00
03.030.7161.0 S	000 420 00 92
03.030.7161.0 S	1 350 817
03.030.7161.0 S	1276 868
03.030.7161.0 S	179 979
03.030.7161.0 S	3091 286
03.030.7161.0 S	324 728
03.030.7161.0 S	324 729
03.030.7161.0 S	5001825536
03.030.7161.0 S	76046
03.030.7161.0 S	81.50610.6132
03.030.7161.01S	000 420 00 92
03.030.7161.01S	1 350 817
03.030.7161.01S	1276 868
03.030.7161.01S	179 979
03.030.7161.01S	3091 286
03.030.7161.01S	324 728
03.030.7161.01S	324 729
03.030.7161.01S	5001825536
03.030.7161.01S	76046
03.030.7161.01S	81.50610.6132
03.030.8750.000	159 556
03.030.8750.000	159 558
03.030.8750.000	278 350
03.030.8750.000	281 090
03.030.8750.000	292 924
03.030.8750.000	538 470
03.030.8750.000	72107
03.030.8750.000	72109
03.030.8750.000	72164
03.030.8750.000	72523
03.030.8750.000	72525
03.030.8750.000	72532
03.030.8750.000	72586
03.030.8750.000	92419
03.030.8750.001	387 420 03 38
03.030.8750.001	617 420 03 38

03.030.8750.001	619 420 07 38
03.030.8750.001	655 420 00 38
03.030.8750.001	80000C
03.030.8750.001	942 420 02 38
03.030.8750.001	942 420 04 38
03.030.8750.001	945 420 02 38
03.030.8750.010	159 557
03.030.8750.010	159 559
03.030.8750.010	278 351
03.030.8750.010	281 091
03.030.8750.010	292 925
03.030.8750.010	538 471
03.030.8750.010	72108
03.030.8750.010	72110
03.030.8750.010	72165
03.030.8750.010	72524
03.030.8750.010	72526
03.030.8750.010	72533
03.030.8750.010	72587
03.030.8750.010	92420
03.030.8750.011	ESXBU1033
03.030.8750.011	79225C
03.030.8750.011	81.50610.34170
03.030.8750.011	81.50610.6126
03.030.8750.011	81.50610.6170
03.030.8750.011	81.50610.6222
03.030.8750.012	ESXBU1030
03.030.8750.012	79226C
03.030.8750.012	81.50610.35169
03.030.8750.012	81.50610.6127
03.030.8750.012	81.50610.6169
03.030.8750.012	81.50610.6223
03.030.8750.020	159 561
03.030.8750.020	159 587
03.030.8750.020	289 691
03.030.8750.020	361 541
03.030.8750.020	72223
03.030.8750.020	72310
03.030.8750.020	72536
03.030.8750.020	72542
03.030.8750.020	72679
03.030.8750.030	159 562

Vergleichsliste | Crosslist

aufsteigend nach ST-Nr. | ascending to ST-No.

03.030.8750.030	159 588	03.030.8750.090	81.50610.6177
03.030.8750.030	289 692	03.030.8750.090	81.50610.6210
03.030.8750.030	361 542	03.030.8750.090	81.50610.6215
03.030.8750.030	72224	03.030.8750.090	942 420 03 38
03.030.8750.030	72311	03.030.8750.090	942 420 05 38
03.030.8750.030	72537	03.030.8750.090	942 420 11 38
03.030.8750.030	72543	03.030.8750.100	341 420 19 38
03.030.8750.030	72680	03.030.8750.100	345 420 08 38
03.030.8750.040	0702.760.10	03.030.8750.100	383 420 05 38
03.030.8750.040	72688	03.030.8750.100	387 420 01 38
03.030.8750.050	0702.760.11	03.030.8750.100	387 420 03 38
03.030.8750.050	72689	03.030.8750.100	617 420 03 38
03.030.8750.090	341 420 18 38	03.030.8750.100	619 420 06 38
03.030.8750.090	345 420 07 38	03.030.8750.100	619 420 07 38
03.030.8750.090	383 420 04 38	03.030.8750.100	621 420 00 38
03.030.8750.090	387 420 00 38	03.030.8750.100	655 420 00 38
03.030.8750.090	387 420 02 38	03.030.8750.100	70707
03.030.8750.090	617 420 04 38	03.030.8750.100	70952
03.030.8750.090	619 420 07 38	03.030.8750.100	72013
03.030.8750.090	621 420 01 38	03.030.8750.100	72037
03.030.8750.090	655 420 01 38	03.030.8750.100	72070
03.030.8750.090	70953	03.030.8750.100	72174
03.030.8750.090	72012	03.030.8750.100	72208
03.030.8750.090	72036	03.030.8750.100	72245
03.030.8750.090	72069	03.030.8750.100	72303
03.030.8750.090	72173	03.030.8750.100	72340
03.030.8750.090	72244	03.030.8750.100	72415
03.030.8750.090	72304	03.030.8750.100	72616
03.030.8750.090	72339	03.030.8750.100	72966
03.030.8750.090	72414	03.030.8750.100	72968
03.030.8750.090	72617	03.030.8750.100	79074
03.030.8750.090	72965	03.030.8750.100	79193
03.030.8750.090	72969	03.030.8750.100	79196
03.030.8750.090	79073	03.030.8750.100	79206
03.030.8750.090	79195	03.030.8750.100	79207
03.030.8750.090	79205	03.030.8750.100	79208
03.030.8750.090	79209	03.030.8750.100	80000
03.030.8750.090	80001	03.030.8750.100	80010
03.030.8750.090	80011	03.030.8750.100	81.50610.13160
03.030.8750.090	81.50610.6139	03.030.8750.100	81.50610.19177
03.030.8750.090	81.50610.6161	03.030.8750.100	81.50610.6085
03.030.8750.090	81.50610.6166	03.030.8750.100	81.50610.6137

aufsteigend nach ST-Nr. | ascending to ST-No.

03.030.8750.100	81.50610.6139
03.030.8750.100	81.50610.6140
03.030.8750.100	81.50610.6160
03.030.8750.100	81.50610.6165
03.030.8750.100	81.50610.6176
03.030.8750.100	81.50610.6193
03.030.8750.100	81.50610.6211
03.030.8750.100	81.50610.6214
03.030.8750.100	81.50610.6235
03.030.8750.100	81.50610.66177
03.030.8750.100	81.50610.66215
03.030.8750.100	81.99803.3225
03.030.8750.100	942 420 02 38
03.030.8750.100	942 420 04 38
03.030.8750.100	942 420 10 38
03.030.8750.100	945 420 08 38
03.030.8750.100	945 520 02 38
03.030.8750.100	946 420 08 38
03.030.8750.101	357 420 06 38
03.030.8750.101	72060
03.030.8750.102	357 420 07 38
03.030.8750.102	72061
03.030.8750.103	5010098831
03.030.8750.103	5010260027
03.030.8750.103	72740
03.030.8750.103	72997
03.030.8750.103	79288
03.030.8750.103	79304
03.030.8750.103	79304C
03.030.8750.104	5010098832
03.030.8750.104	5010260028
03.030.8750.104	72741
03.030.8750.104	72998
03.030.8750.104	79289
03.030.8750.104	79305
03.030.8750.104	79305C
03.030.8750.105	0702.770.00
03.030.8750.105	70720
03.030.8750.106	279 243
03.030.8750.106	279 244
03.030.8750.106	72116
03.030.8750.106	72529

03.030.8750.107	305 420 04 38
03.030.8750.107	305 420 27 38
03.030.8750.107	70518
03.030.8750.107	70702
03.030.8750.108	305 420 29 38
03.030.8750.108	305 420 30 38
03.030.8750.108	625 420 06 38
03.030.8750.108	70950
03.030.8750.108	70951
03.030.8750.109	5000504467
03.030.8750.109	72137
03.030.8750.110	ESXBU1033
03.030.8750.110	5000504468
03.030.8750.110	70962
03.030.8750.110	72138
03.030.8750.110	72512
03.030.8750.110	72987
03.030.8750.110	79225
03.030.8750.110	81.50610.34170
03.030.8750.110	81.50610.6126
03.030.8750.110	81.50610.6170
03.030.8750.110	81.50610.6222
03.030.8750.111	5000787264
03.030.8750.111	79007C
03.030.8750.112	5000787265
03.030.8750.112	79008C
03.030.8750.113	5010197577
03.030.8750.113	79440C
03.030.8750.114	5010197578
03.030.8750.114	79441C
03.030.8750.115	5010013393
03.030.8750.115	79020C
03.030.8750.116	5010013394
03.030.8750.116	79021C
03.030.8750.117	376 420 02 38
03.030.8750.117	70992
03.030.8750.118	376 420 03 38
03.030.8750.118	70993
03.030.8750.119	1 324 357
03.030.8750.119	219 860
03.030.8750.119	79105C
03.030.8750.120	1 324 358

Vergleichsliste | Crosslist

aufsteigend nach ST-Nr. | ascending to ST-No.

03.030.8750.120	219 859
03.030.8750.120	79106C
03.030.8750.121	619 420 00 38
03.030.8750.121	619 420 02 38
03.030.8750.121	623 420 12 38
03.030.8750.121	623 420 14 38
03.030.8750.121	652 420 00 38
03.030.8750.121	658 420 02 38
03.030.8750.121	80008C
03.030.8750.121	942 420 00 38
03.030.8750.121	942 420 09 38
03.030.8750.121	942 420 12 38
03.030.8750.121	945 542 00 38
03.030.8750.122	05.174.90.20.0
03.030.8750.122	619 420 01 38
03.030.8750.122	619 420 03 38
03.030.8750.122	623 420 13 38
03.030.8750.122	623 420 15 38
03.030.8750.122	652 420 01 38
03.030.8750.122	658 420 03 38
03.030.8750.122	80008C
03.030.8750.122	942 420 01 38
03.030.8750.122	942 420 08 38
03.030.8750.122	942 420 13 38
03.030.8750.122	945 420 01 38
03.030.8750.123	221 734
03.030.8750.123	72658C
03.030.8750.130	79212C
03.030.8750.130	81.50610.6081
03.030.8750.130	81.50610.6151
03.030.8750.130	81.50610.6231
03.030.8750.130	81.50610.8151
03.030.8750.130	81.50610.9151
03.030.8750.140	357 420 14 38
03.030.8750.140	357 420 16 38
03.030.8750.140	72456
03.030.8750.140	72732
03.030.8750.140	72810
03.030.8750.140	72812
03.030.8750.140	72982
03.030.8750.140	72991
03.030.8750.140	79220

03.030.8750.140	79229
03.030.8750.140	81.50610.25181
03.030.8750.140	81.50610.6181
03.030.8750.140	81.50610.6199
03.030.8750.140	81.50610.6203
03.030.8750.140	81.50610.6229
03.030.8750.150	357 420 13 38
03.030.8750.150	357 420 15 38
03.030.8750.150	72455
03.030.8750.150	72731
03.030.8750.150	72809
03.030.8750.150	72811
03.030.8750.150	72981
03.030.8750.150	72990
03.030.8750.150	79219
03.030.8750.150	79228
03.030.8750.150	81.50610.24182
03.030.8750.150	81.50610.6182
03.030.8750.150	81.50610.6200
03.030.8750.150	81.50610.6204
03.030.8750.150	81.50610.6228
03.030.8750.160	301 420 11 38
03.030.8750.160	72213
03.030.8750.170	0701.125.07
03.030.8750.170	305 420 02 38
03.030.8750.170	305 420 26 38
03.030.8750.170	70706
03.030.8750.180	0701.143.04
03.030.8750.180	307 420 01 38
03.030.8750.180	70772
03.030.8750.180	72562
03.030.8750.180	79204
03.030.8750.180	81.50610.41184
03.030.8750.180	81.50610.6064
03.030.8750.180	81.50610.6184
03.030.8750.190	0701.143.05
03.030.8750.190	307 420 02 38
03.030.8750.190	70771
03.030.8750.190	72561
03.030.8750.190	79203
03.030.8750.190	81.50610.40183
03.030.8750.190	81.50610.6063

aufsteigend nach ST-Nr. | ascending to ST-No.

03.030.8750.190	81.50610.6183
03.030.8750.210	357 420 05 38
03.030.8750.210	72059
03.030.8750.220	389 420 02 38
03.030.8750.220	389 420 07 38
03.030.8750.220	396 420 00 38
03.030.8750.220	620 420 02 38
03.030.8750.220	620 420 03 38
03.030.8750.220	70805
03.030.8750.220	70867
03.030.8750.220	72308
03.030.8750.230	357 420 11 38
03.030.8750.230	72211
03.030.8750.240	357 420 12 38
03.030.8750.240	72212
03.030.8750.250	371 420 00 38
03.030.8750.250	652 420 02 38
03.030.8750.250	72596
03.030.8750.250	79185
03.030.8750.260	385 420 12 38
03.030.8750.260	70918
03.030.8750.270	1 112 832
03.030.8750.270	1 112 841
03.030.8750.270	215 850
03.030.8750.270	308 677
03.030.8750.270	394 180
03.030.8750.270	394 197
03.030.8750.270	70661
03.030.8750.270	70974
03.030.8750.270	72464
03.030.8750.270	72490
03.030.8750.270	72623
03.030.8750.270	72632
03.030.8750.270	72654
03.030.8750.270	72953
03.030.8750.270	72962
03.030.8750.280	282 609
03.030.8750.280	282 610
03.030.8750.280	537 538
03.030.8750.280	537 539
03.030.8750.280	72534
03.030.8750.290	276 526

03.030.8750.290	276 576
03.030.8750.290	321 470
03.030.8750.290	362 134
03.030.8750.290	384 418
03.030.8750.290	394 186
03.030.8750.290	394 192
03.030.8750.290	70938
03.030.8750.290	72001
03.030.8750.290	72248
03.030.8750.290	72476
03.030.8750.290	72487
03.030.8750.290	72489
03.030.8750.290	72621
03.030.8750.290	72627
03.030.8750.290	72631
03.030.8750.290	72664
03.030.8750.290	72665
03.030.8750.290	72826
03.030.8750.290	72952
03.030.8750.290	72954
03.030.8750.290	72959
03.030.8750.300	0824.603.00
03.030.8750.300	278 737
03.030.8750.300	394 181
03.030.8750.300	70878
03.030.8750.300	72491
03.030.8750.300	72624
03.030.8750.300	72660
03.030.8750.300	72949
03.030.8750.310	0702.656.00
03.030.8750.310	278 738
03.030.8750.310	394 182
03.030.8750.310	70879
03.030.8750.310	72492
03.030.8750.310	72625
03.030.8750.310	72661
03.030.8750.310	72950
03.030.8750.320	276 525
03.030.8750.320	276 575
03.030.8750.320	321 469
03.030.8750.320	362 135
03.030.8750.320	384 417

Vergleichsliste | Crosslist



aufsteigend nach ST-Nr. | ascending to ST-No.

03.030.8750.320	394 185
03.030.8750.320	394 191
03.030.8750.320	70937
03.030.8750.320	72002
03.030.8750.320	72247
03.030.8750.320	72477
03.030.8750.320	72486
03.030.8750.320	72488
03.030.8750.320	72620
03.030.8750.320	72626
03.030.8750.320	72630
03.030.8750.320	72663
03.030.8750.320	72666
03.030.8750.320	72825
03.030.8750.320	72951
03.030.8750.320	72955
03.030.8750.320	72958
03.030.8750.330	1195 461
03.030.8750.330	72782C
03.030.8750.340	119 462
03.030.8750.340	72783C
03.030.8750.350	221 737
03.030.8750.350	72746C
03.030.8750.360	362 046
03.030.8750.360	394 190
03.030.8750.360	397 746
03.030.8750.360	72236
03.030.8750.360	72482
03.030.8750.360	72580
03.030.8750.360	72728
03.030.8750.360	72956
03.030.8750.370	1 335 986
03.030.8750.370	1 356 696
03.030.8750.370	1 358 634
03.030.8750.370	72851
03.030.8750.370	72995
03.030.8750.370	79033
03.030.8750.370	79442C
03.030.8750.390	1 358 634
03.030.8750.390	79442C
03.030.8750.400	70958
03.030.8750.400	72210

03.030.8750.400	72438
03.030.8750.400	72578
03.030.8750.400	72980
03.030.8750.400	72989
03.030.8750.400	79218
03.030.8750.400	79227
03.030.8750.400	81.50610.22180
03.030.8750.400	81.50610.23180
03.030.8750.400	81.50610.42194
03.030.8750.400	81.50610.43194
03.030.8750.400	81.50610.6123
03.030.8750.400	81.50610.6157
03.030.8750.400	81.50610.6180
03.030.8750.400	81.50610.6194
03.030.8750.400	81.50610.6216
03.030.8750.400	81.50610.6226
03.030.8750.410	383 825
03.030.8750.410	394 196
03.030.8750.410	72730C
03.030.8750.42S	05.174.72.12.0
03.030.8750.42S	05.174.82.03.1
03.030.8750.42S	05.174.82.03.2
03.030.8750.42S	05.174.82.31.2
03.030.8750.42S	05.574.82.67.2
03.030.8750.42S	05.575.82.27.0
03.030.8750.42S	4.175.0184.00
03.030.8750.42S	72876D
03.030.8750.43S	80023D
03.030.8750.44S	80024D
03.030.8750.45S	80020D
03.030.8750.46S	1325 310
03.030.8750.46S	2.175.0168.00
03.030.8750.46S	2.175.0202.00
03.030.8750.46S	3.434.3502.02
03.030.8750.46S	3.434.3514.00
03.030.8750.46S	4.175.0228.00
03.030.8750.46S	4.175.0249.00
03.030.8750.46S	5000816365
03.030.8750.46S	79005D
03.030.8750.470	699 420 05 38
03.030.8750.470	72919
03.030.8750.480	SK5086

aufsteigend nach ST-Nr. | ascending to ST-No.

03.030.8750.480	1325 310	03.030.8750.490	05.174.82.63.3
03.030.8750.480	2.175.0156.00	03.030.8750.490	05.174.82.67.2
03.030.8750.480	2.175.0168.00	03.030.8750.490	05.174.82.74.2
03.030.8750.480	2.175.0202.00	03.030.8750.490	05.574.82.02.1
03.030.8750.480	3.434.3502.02	03.030.8750.490	05.574.82.03.1
03.030.8750.480	3.434.3514.00	03.030.8750.490	05.574.82.12.1
03.030.8750.480	4.175.0085.00	03.030.8750.490	05.574.82.19.0
03.030.8750.480	4.175.0228.00	03.030.8750.490	05.574.82.20.0
03.030.8750.480	4.175.0249.00	03.030.8750.490	05.574.82.22.0
03.030.8750.480	5000816365	03.030.8750.490	05.574.82.27.0
03.030.8750.480	633105040	03.030.8750.490	05.574.82.43.0
03.030.8750.480	72250	03.030.8750.490	05.574.82.43.2
03.030.8750.480	79005	03.030.8750.490	05.574.82.44.0
03.030.8750.480	79109	03.030.8750.490	05.574.82.44.2
03.030.8750.480	79112	03.030.8750.490	05.574.82.55.2
03.030.8750.480	79149	03.030.8750.490	05.574.82.59.2
03.030.8750.480	80022	03.030.8750.490	05.574.82.65.2
03.030.8750.490	05.174.82.02.0	03.030.8750.490	05.574.82.67.2
03.030.8750.490	05.174.82.02.1	03.030.8750.490	05.574.82.68.2
03.030.8750.490	05.174.82.02.2	03.030.8750.490	05.574.82.87.2
03.030.8750.490	05.174.82.03.0	03.030.8750.490	05.574.82.87.3
03.030.8750.490	05.174.82.03.1	03.030.8750.490	05.574.82.93.2
03.030.8750.490	05.174.82.03.2	03.030.8750.490	10613835
03.030.8750.490	05.174.82.12.0	03.030.8750.490	1325 309
03.030.8750.490	05.174.82.12.2	03.030.8750.490	2.175.0169.00
03.030.8750.490	05.174.82.14.0	03.030.8750.490	4.175.0184.00
03.030.8750.490	05.174.82.14.2	03.030.8750.490	4.175.0239.00
03.030.8750.490	05.174.82.21.0	03.030.8750.490	72875
03.030.8750.490	05.174.82.21.2	03.030.8750.490	72876
03.030.8750.490	05.174.82.22.0	03.030.8750.490	80019
03.030.8750.490	05.174.82.22.2	03.030.8750.510	1234 233
03.030.8750.490	05.174.82.24.0	03.030.8750.510	159 569
03.030.8750.490	05.174.82.24.2	03.030.8750.510	159 570
03.030.8750.490	05.174.82.31.0	03.030.8750.510	159 578
03.030.8750.490	05.174.82.31.2	03.030.8750.510	159 579
03.030.8750.490	05.174.82.39.2	03.030.8750.510	281 094
03.030.8750.490	05.174.82.47.0	03.030.8750.510	281 095
03.030.8750.490	05.174.82.47.2	03.030.8750.510	297 174
03.030.8750.490	05.174.82.49.0	03.030.8750.510	297 175
03.030.8750.490	05.174.82.49.2	03.030.8750.510	388 947
03.030.8750.490	05.174.82.56.2	03.030.8750.510	72139
03.030.8750.490	05.174.82.63.2	03.030.8750.510	72314

Vergleichsliste | Crosslist

aufsteigend nach ST-Nr. | ascending to ST-No.

03.030.8750.510	72442
03.030.8750.510	72531
03.030.8750.510	72546
03.030.8750.510	72553
03.030.8750.510	72793
03.030.8750.520	362 047
03.030.8750.520	394 189
03.030.8750.520	397 745
03.030.8750.520	72237
03.030.8750.520	72483
03.030.8750.520	72579
03.030.8750.520	72727
03.030.8750.520	72957
03.030.8750.530	5000788696
03.030.8750.530	5000791212
03.030.8750.530	5010260023
03.030.8750.530	5810111404
03.030.8750.530	637208940
03.030.8750.530	637208950
03.030.8750.530	637208960
03.030.8750.530	637208970
03.030.8750.530	72089
03.030.8750.530	72318
03.030.8750.530	72633
03.030.8750.530	79000
03.030.8750.530	79009
03.030.8750.530	79017
03.030.8750.530	79306
03.030.8750.540	5000788697
03.030.8750.540	5000791213
03.030.8750.540	5010260024
03.030.8750.540	5810111405
03.030.8750.540	72090
03.030.8750.540	72319
03.030.8750.540	72634
03.030.8750.540	79001
03.030.8750.540	79010
03.030.8750.540	79018
03.030.8750.540	79307
03.030.8750.550	1134 829
03.030.8750.550	72721C
03.030.8750.560	1134 830

03.030.8750.560	72722C
03.030.8750.570	219 997
03.030.8750.570	72655C
03.030.8750.580	219 998
03.030.8750.580	72656C
03.030.8750.590	221 733
03.030.8750.590	72657C
03.030.8750.600	383 826
03.030.8750.600	394 195
03.030.8750.600	72729C
03.030.8750.610	218 833
03.030.8750.610	72744C
03.030.8750.620	ESXBU1009
03.030.8750.620	218 834
03.030.8750.620	72745C
03.030.8750.630	5000445830
03.030.8750.630	79011C
03.030.8750.640	5010037900
03.030.8750.640	79019C
03.030.8750.650	3013 676
03.030.8750.650	79271C
03.030.8750.660	1581 472
03.030.8750.660	72901C
03.030.8750.670	1581 471
03.030.8750.670	72902C
03.030.8750.680	1195 316
03.030.8750.680	72944C
03.030.8750.690	246 392
03.030.8750.690	72947C
03.030.8750.700	311 508
03.030.8750.700	72910C
03.030.8750.710	1197 965
03.030.8750.710	72784C
03.030.8750.720	1197 966
03.030.8750.720	72785C
03.030.8750.730	5000789892
03.030.8750.730	5010056685
03.030.8750.730	79013C
03.030.8750.740	5010056686
03.030.8750.740	79014C
03.030.8750.750	221 738
03.030.8750.750	72747C

aufsteigend nach ST-Nr. | ascending to ST-No.

03.030.8750.760	5000785203
03.030.8750.760	79152C
03.030.8750.770	5000785204
03.030.8750.770	79153C
03.030.8750.780	5000785205
03.030.8750.780	79150C
03.030.8750.790	5000785206
03.030.8750.790	79151C
03.030.8750.800	5010152965
03.030.8750.800	79303C
03.030.8750.810	5010201995
03.030.8750.810	79298C
03.030.8750.820	5010216904
03.030.8750.820	79301C
03.030.8750.830	5010216905
03.030.8750.830	79302C
03.030.8750.840	5000470830
03.030.8750.840	5010067156
03.030.8750.840	5010098893
03.030.8750.840	5010151248
03.030.8750.840	5010216246
03.030.8750.840	5010260085
03.030.8750.840	5010260115
03.030.8750.840	5010260344
03.030.8750.840	70896
03.030.8750.840	72394
03.030.8750.840	72683
03.030.8750.840	72786
03.030.8750.840	72796
03.030.8750.840	79045
03.030.8750.840	79075
03.030.8750.840	79290
03.030.8750.840	79292
03.030.8750.840	79308
03.030.8750.850	5000470831
03.030.8750.850	5010067157
03.030.8750.850	5010151249
03.030.8750.850	5010216247
03.030.8750.850	5010260086
03.030.8750.850	5010260116
03.030.8750.850	5010260345
03.030.8750.850	70897

03.030.8750.850	72395
03.030.8750.850	72684
03.030.8750.850	72787
03.030.8750.850	72797
03.030.8750.850	79046
03.030.8750.850	79076
03.030.8750.850	79291
03.030.8750.850	79293
03.030.8750.850	79309
03.030.8750.860	HB100393
03.030.8750.860	5010260117
03.030.8750.860	79310C
03.030.8750.870	HB100394
03.030.8750.870	5010260118
03.030.8750.870	79311C
03.030.8750.880	159 560
03.030.8750.880	159 565
03.030.8750.880	278 678
03.030.8750.880	278 679
03.030.8750.880	284 860
03.030.8750.880	72117
03.030.8750.880	72202
03.030.8750.880	72530
03.030.8750.880	72535
03.030.8750.890	392 736
03.030.8750.890	537 537
03.030.8750.890	72383
03.030.8750.890	72558
03.030.8750.910	5010216844
03.030.8750.910	79300C
03.030.8750.920	5000882316
03.030.8750.920	70975
03.030.8750.930	5000882317
03.030.8750.930	70976
03.030.8750.940	70846
03.030.8750.940	70857
03.030.8750.940	72613
03.030.8750.940	79202
03.030.8750.940	79215C
03.030.8750.940	81.50610.14167
03.030.8750.940	81.50610.15167
03.030.8750.940	81.50610.16167

Vergleichsliste | Crosslist

aufsteigend nach ST-Nr. | ascending to ST-No.

03.030.8750.940	81.50610.16209	03.040.0242.931	05.091.14.70.0
03.030.8750.940	81.50610.38091	03.040.0247.100	05.091.19.07.0
03.030.8750.940	81.50610.39091	03.040.0247.130	05.091.28.11.2
03.030.8750.940	81.50610.44001	03.040.0290.320	A-JA-0508-001 S
03.030.8750.940	81.50610.45001	03.040.0672.500	016.26.52.200.03
03.030.8750.940	81.50610.6001	03.040.0672.500	051.26.52.200.03
03.030.8750.940	81.50610.6091	03.040.0687.000	010.24.21.920.73
03.030.8750.940	81.50610.6098	03.040.0687.000	051.24.21.920.73
03.030.8750.940	81.50610.6167	03.040.0687.001	015.26.21.500.36
03.030.8750.940	81.50610.6209	03.040.0904.140	81.50201.6178
03.030.8750.950	699 420 06 38	03.040.0904.530	81.50201.6098
03.030.8750.950	72920	03.040.1905.010	659 420 04 19
03.030.8750.960	385 420 11 38	03.040.1905.011	659 420 04 19
03.030.8750.960	70917	03.040.1905.740	335 420 00 19
03.030.8750.970	ESXBU1024	03.040.1905.820	393 420 03 19
03.030.8750.970	72159	03.040.1905.820	393 420 07 19
03.030.8750.970	79216	03.040.1905.820	393 420 25 19
03.030.8750.970	79216C	03.040.1905.820	393 420 29 19
03.030.8750.970	81.05610.6206	03.040.1905.820	659 420 00 19
03.030.8750.970	81.50610.20178	03.040.1905.821	393 420 03 19
03.030.8750.970	81.50610.6150	03.040.1905.850	389 420 61 19
03.030.8750.970	81.50610.6178	03.040.1905.850	81.50201.6099
03.030.8750.970	81.50610.6206	03.040.1905.850	81.50201.6184
03.030.8750.980	ESXBU1032	03.040.1905.851	389 420 61 19
03.030.8750.980	72158	03.040.1905.940	350 420 03 19
03.030.8750.980	79217	03.040.1905.940	389 420 64 19
03.030.8750.980	79217C	03.040.1905.940	620 420 00 19
03.030.8750.980	81.50610.21179	03.040.1905.940	620 420 02 19
03.030.8750.980	81.50610.6149	03.040.1905.940	659 420 03 19
03.030.8750.980	81.50610.6179	03.040.1905.941	350 420 03 19
03.030.8750.980	81.50610.6205	03.040.1905.960	305 420 07 19
03.030.8750.990	623 420 18 38	03.040.1905.960	659 420 13 19
03.030.8750.990	72056	03.040.1905.960	81.50201.6188
03.040.0242.700	05.091.26.21.0	03.040.2053.000	3.054.0052.00
03.040.0242.760	05.091.26.64.2	03.040.2053.010	3.055.0052.00
03.040.0242.761	05.091.46.09.0	03.040.2054.000	3.054.0053.00
03.040.0242.763	05.091.46.09.0	03.040.2054.010	3.055.0053.00
03.040.0242.770	05.091.27.54.2	03.040.2060.000	3.054.0084.00
03.040.0242.771	05.091.27.79.0	03.040.2060.010	3.055.0084.00
03.040.0242.870	05.091.14.46.0	03.040.2228.000	3.054.0120.00
03.040.0242.871	05.091.14.65.0	03.040.3504.140	1674 000B
03.040.0242.930	05.091.14.19.0	03.040.3504.150	M006093

aufsteigend nach ST-Nr. | ascending to ST-No.

03.040.3504.200	1649000R	03.070.0240.760	03.112.22.07.0
03.040.4004.60S	3090 074-0	03.070.0240.760	03.112.22.21.0
03.040.4004.7 S	0270 828-7	03.070.0240.760	03.112.22.23.0
03.040.4004.7 S	272 843	03.070.0240.760	03.112.22.24.0
03.040.4004.7 S	3090 076-5	03.070.0242.550	02.5603.24.90
03.040.4004.8 S	0270 827-9	03.070.0242.610	02.5677.21.00
03.040.4004.8 S	0272 842	03.070.0242.860	03.084.46.22.0
03.040.4004.8 S	3090 075-7	03.070.0242.861	09.084.46.36.0
03.040.4004.9 S	0270 829	03.070.0242.9 S	09.801.02.10.0
03.040.4004.9 S	3090 077	03.070.0242.900	03.331.34.05.0
03.040.4200.670	152 05 191	03.070.0242.910	03.350.00.13.0
03.040.4200.680	152 05 533	03.070.0243.0 S	03.331.34.02.0 S
03.060.7450.000	02.5805.80.35	03.070.0243.000	03.331.34.02.0
03.060.7450.000	4 267 0007 01	03.070.0243.010	03.232.13.02.0
03.060.7450.150	02.5805.82.35	03.070.0243.550	03.114.44.03.0
03.060.7450.200	02.5805.84.35	03.070.0244.5 S	09.801.02.12.0
03.060.7450.250	02.5805.81.35	03.070.0244.800	03.331.34.01.0
03.060.7450.300	02.5805.83.35	03.070.0245.920	03.167.23.02.0
03.060.7450.360	81.92201.0109	03.070.0246.890	05.331.44.02.0
03.060.7450.500	307 990 01 97	03.070.0246.900	03.084.75.24.0
03.060.7450.550	307 990 02 97	03.070.0246.910	03.310.70.15.0
03.060.7450.600	06.24180.4559	03.070.0247.830	03.350.00.14.0
03.060.7450.700	4.267.0006.01	03.070.0280.000	145 450
03.070.0203.000	09.084.46.11.0	03.070.0280.010	145 459
03.070.0205.000	03.340.01.02.0	03.070.0280.020	290 377
03.070.0206.000	03.084.54.02.0	03.070.0280.090	667 965
03.070.0207.000	03.200.64.01.0	03.070.0281.000	364 577
03.070.0227.000	03.340.01.01.0	03.070.0281.000	622 247
03.070.0230.000	03.084.46.05.0	03.070.0281.010	0622 246
03.070.0230.010	03.084.46.05.0	03.070.0281.010	622 246
03.070.0231.000	09.084.46.12.0	03.070.0290.150	A-JA-0558-001
03.070.0232.000	03.084.66.15.0	03.070.0290.170	A-JA-0507-001
03.070.0233.000	09.084.66.02.0	03.070.0290.180	A-JA-0504-002
03.070.0234.010	03.177.23.09.0	03.070.0290.500	AJA-0507-001
03.070.0234.010	03.177.23.10.0	03.070.0615.010	6.125.451.102
03.070.0234.010	03.177.23.10.1	03.070.0616.000	6.125.451.103
03.070.0234.020	09.177.23.09.0	03.070.0633.000	010.24.21.939.31
03.070.0238.000	03.084.54.01.0	03.070.0634.000	010.24.21.939.21
03.070.0239.000	03.084.55.11.0	03.070.0634.010	015.26.21.115.40
03.070.0240.0 S	05.331.84.01.0	03.070.0646.000	418.16.21.111.15
03.070.0240.000	03.200.34.02.0	03.070.0661.000	010.24.21.928.15
03.070.0240.190	03.084.52.06.0	03.070.0694.000	01.24219.26.15

Vergleichsliste | Crosslist

aufsteigend nach ST-Nr. | ascending to ST-No.

03.070.0695.170	6.694.030.300
03.070.0941.000	81.50213.6006
03.070.0941.010	81.93020.0645
03.070.0941.1 S	81.50213.6006 S
03.070.0942.000	81.93020.0013
03.070.0982.000	81.50212.0027
03.070.0983.000	81.50213.6001
03.070.0991.000	81.50212.0019
03.070.1450.010	366 423 00 18
03.070.1450.010	366 423 01 18
03.070.1452.000	335 421 00 18
03.070.1452.000	335 421 02 18
03.070.1454.000	335 421 00 74
03.070.1454.1 S	335 420 00 39
03.070.1455.000	301 420 00 39
03.070.1455.000	307 420 01 39
03.070.1455.000	317 420 00 39
03.070.1455.000	346 420 00 39
03.070.1455.000	81.50213.6013
03.070.1455.020	000471 017000
03.070.1455.020	06.29010.0114
03.070.1455.050	317 990 16 40
03.070.1455.060	307 421 00 74
03.070.1455.060	81.50211.0023
03.070.1455.060	81.50211.0030
03.070.1455.070	000988 017012
03.070.1455.070	000988 017100
03.070.1455.070	317 990 05 40
03.070.1455.070	346 990 05 40
03.070.1455.070	81.90711.0710
03.070.1455.080	003 997 15 48
03.070.1455.090	301 421 00 50
03.070.1455.1 S	307 420 03 39
03.070.1455.100	000471 012001
03.070.1456.000	346 421 11 74
03.070.1456.000	497 421 00 74
03.070.1456.000	81.50212.0032
03.070.1456.000	81.50212.0036
03.070.1456.2 S	307 420 40 02
03.070.1457.000	302 421 10 74
03.070.1457.010	302 421 01 50
03.070.1457.010	81.93020.0466

03.070.1457.020	302 997 04 45
03.070.1457.030	003 997 69 48
03.070.1457.030	81.96501.0831
03.070.1457.040	307 421 05 50
03.070.1457.040	81.93020.0576
03.070.1457.2 S	395 420 00 41
03.070.1457.2 S	395 586 01 42
03.070.1459.2 S	307 420 41 02
03.070.1462.010	302 421 01 74
03.070.1464.060	302 421 09 74
03.070.1608.1 S	346 421 11 74 S
03.070.1609.1 S	497 421 00 74 S
03.070.1904.890	346 994 01 09
03.070.1904.890	81.90801.0225
03.070.1904.900	381 994 00 09
03.070.1904.910	000093 010502
03.070.1904.910	06.16010.0108
03.070.1904.910	06.16010.0408
03.070.1904.910	302 994 00 10
03.070.1904.910	346 994 00 09
03.070.1904.930	000933 010130
03.070.1904.930	000933 010288
03.070.1904.930	06.01289.0104
03.070.1904.940	302 994 02 09
03.070.1905.910	346 421 07 74
03.070.1905.910	387 421 00 74
03.070.1905.910	658 421 00 74
03.070.1905.910	81.50211.0016
03.070.1905.910	81.50211.0027
03.070.1905.920	346 421 06 74
03.070.1905.920	81.50211.0018
03.070.1905.920	945 421 00 74
03.070.1920.010	318 421 01 74
03.070.1920.020	318 421 00 50
03.070.1920.030	011 997 04 48
03.070.1920.040	318 421 02 73
03.070.1920.2 S	318 420 01 82
03.070.1930.010	674 421 00 50
03.070.1930.020	001 997 70 48
03.070.1930.030	674 421 00 73
03.070.1930.2 S	675 420 00 82
03.070.1935.080	670 540 00 17

aufsteigend nach ST-Nr. | ascending to ST-No.

03.070.1935.090	601 540 06 17	03.070.4000.560	1586 716-1
03.070.2000.S00	3.213.0004.06	03.070.4000.570	0348 977-0
03.070.2000.000	1.214.0004.06	03.070.4000.580	0348 978-8
03.070.2002.000	1.230.0035.00	03.070.4000.700	0341 717-7
03.070.2004.000	1.265.0003.00	03.070.4000.710	0348 979-6
03.070.2007.000	1.230.0032.00	03.070.4000.720	0341 719-3
03.070.2012.S00	1.265.0007.00 S	03.070.4200.080	210 06 610
03.070.2012.000	1.265.0007.00	03.070.4200.080	210 06 610 A
03.070.2022.S00	3.213.0022.02	03.070.4200.260	AXL 126
03.070.2022.000	1.214.0022.01	03.070.4200.290	212 21 028
03.070.2022.000	1.214.0022.02	03.070.4200.410	AXL 125
03.070.2023.S00	3.434.3602.00	03.070.4200.420	AXL 117
03.070.2023.000	1.214.0023.02	03.070.4200.430	210 16 666
03.070.2023.100	1.214.0023.01	03.070.4200.430	210 16 666A
03.070.2030.S00	3.213.0023.02	03.070.4200.470	212 20 668
03.070.2030.000	1.331.0013.00	03.070.4200.710	210 23 758
03.070.2031.S00	3.213.0023.01	03.070.4200.720	165 00 005
03.070.2039.200	1.265.0019.00	03.080.0240.020	03.397.26.04.0
03.070.2049.000	1.230.0084.00	03.080.0240.070	05.397.56.07.0
03.070.2049.000	1.230.0084.01	03.080.0240.070	1.447.0045.00
03.070.2051.000	1.345.0006.00	03.080.0240.120	05.397.45.05.0
03.070.2065.000	4.343.1003.88	03.080.0240.130	03.397.26.03.0
03.070.2065.000	4.343.1015.88	03.080.0240.130	05.397.26.03.0
03.070.2068.000	1.395.1005.00	03.080.0240.130	1.447.0037.00
03.070.2094.000	1.331.0020.02	03.080.0241.840	09.397.21.03.0
03.070.2221.100	1.093.0005.00	03.080.0241.870	09.397.32.04.0
03.070.2221.600	1.395.1001.00	03.080.0241.880	03.397.34.01.0
03.070.2221.700	1.395.1013.00	03.080.0241.890	03.397.34.02.0
03.070.3000.310	183 924	03.080.0241.900	03.397.34.10.0
03.070.3000.320	180 064	03.080.0241.900	03.397.34.11.0
03.070.3000.330	141 164	03.080.0241.910	03.397.35.01.0
03.070.3000.340	141 163	03.080.0241.910	05.397.35.01.0
03.070.3000.370	154 259 S	03.080.0241.910	05.397.35.03.0
03.070.3000.380	154 261	03.080.0241.920	05.397.46.03.0
03.070.3004.530	154 259	03.080.0241.930	05.397.46.06.0
03.070.3504.2 S	6502102W	03.080.0241.930	05.397.46.07.0
03.070.3504.220	1 652 010R	03.080.0241.930	1 309 465
03.070.3504.4 S	6504775W 1/2	03.080.0241.980	05.397.58.03.0
03.070.3504.410	6502382B	03.080.0242.880	03.397.44.06.0
03.070.3504.420	6502102W 1/2	03.080.0242.880	1.447.0049.00
03.070.3504.6 S	M009279/2	03.080.0245.170	03.397.45.06.0
03.070.4000.550	1584 673-6	03.080.0245.700	03.397.46.10.0

Vergleichsliste | Crosslist

aufsteigend nach ST-Nr. | ascending to ST-No.

03.080.0245.970	05.397.35.02.0	03.080.1794.000	326 993 00 10
03.080.0246.210	05.397.45.14.0	03.080.1795.000	346 993 08 10
03.080.0246.430	05.397.46.12.0	03.080.1796.000	302 993 03 10
03.080.0246.860	05.397.34.17.0	03.080.1905.810	303 993 04 10
03.080.0246.870	03.397.45.10.0	03.080.1905.810	81.97610.0001
03.080.0246.880	05.397.46.13.0	03.080.1908.000	677 993 03 10
03.080.0250.060	05.397.34.16.0	03.080.1908.040	673 993 02 10
03.080.0284.000	1279 502	03.080.1908.040	673 993 04 10
03.080.0284.000	194 592	03.080.2031.000	1.447.0033.00
03.080.0289.010	1212 994	03.080.2032.000	1.447.0021.01
03.080.0289.010	1301 490	03.080.2035.000	1.447.0038.00
03.080.0289.010	1340 297	03.080.2067.000	1.447.0036.00
03.080.0289.010	389 862	03.080.2175.000	1.447.0050.00
03.080.0806.060	0812 1308	03.080.2182.000	1.447.0023.01
03.080.0806.070	0812 1307	03.080.2214.000	1.447.0027.01
03.080.0807.070	4248 0056	03.080.2219.000	1.447.0058.00
03.080.0901.010	81.97610.0132	03.080.2220.000	1.151.0008.00
03.080.0901.030	81.97610.0099	03.080.2221.400	1.447.0041.00
03.080.0901.170	81.97610.0271	03.080.2233.000	1.447.0056.00
03.080.0904.980	81.97610.0266	03.080.3000.170	120 824
03.080.1772.000	617 993 11 10	03.080.3504.020	AJB 0119-001
03.080.1773.000	945 993 00 10	03.080.3504.020	M002874
03.080.1779.000	335 421 03 92	03.080.3504.020	1643000C
03.080.1780.000	346 993 02 10	03.080.4000.250	0341 720
03.080.1780.000	617 993 06 10	03.080.4000.250	1586 683
03.080.1780.000	81.97610.0118	03.080.4000.250	1586 683-3
03.080.1780.000	81.97610.0208	03.080.4000.650	0346 499-7
03.080.1781.000	346 993 03 10	03.080.4001.580	1586 076
03.080.1781.000	81.97610.0123	03.080.4001.640	1586 076-0
03.080.1782.000	360 993 01 10	03.080.4004.810	1696 444
03.080.1783.000	385 993 05 10	03.080.4004.810	3097 092-2
03.080.1784.000	314 993 08 10	03.080.4200.010	210 23 389
03.080.1785.000	346 993 01 10	03.080.4200.140	212 21 224
03.080.1785.000	81.97610.0115	03.080.4200.580	212 05 194
03.080.1786.000	314 993 11 10	03.090.0252.000	03.105.46.20.0
03.080.1787.000	336 993 00 10	03.090.0252.000	03.109.46.40.0
03.080.1788.000	341 421 00 92	03.090.0252.010	03.106.67.54.0
03.080.1788.000	352 421 01 92	03.090.0252.010	03.109.67.74.0
03.080.1789.000	335 421 01 92	03.090.0252.030	03.106.67.62.0
03.080.1790.000	335 993 05 10	03.090.0252.030	03.109.67.13.0
03.080.1791.000	302 993 06 10	03.090.0252.030	03.109.67.82.0
03.080.1793.000	317 993 10 10	03.090.0252.040	03.106.77.52.0

aufsteigend nach ST-Nr. | ascending to ST-No.

03.090.0252.040	03.109.77.72.0
03.090.0252.050	03.106.77.57.0
03.090.0252.050	03.109.77.16.0
03.090.0252.050	03.109.77.77.0
03.090.0252.060	03.105.46.03.0
03.090.0252.070	03.106.67.12.0
03.090.0252.080	03.106.77.04.0
03.090.0252.090	03.106.77.11.0
03.090.0252.100	03.105.46.10.0
03.090.0252.110	03.105.46.13.0
03.090.0252.120	03.109.67.19.0
03.090.0252.130	03.106.77.63.0
03.090.0252.140	03.109.77.16.0
03.090.0252.150	03.109.90.24.0
03.090.0252.160	03.109.46.06.0
03.090.0252.170	03.105.46.29.0
03.090.0252.170	03.109.46.49.0
03.090.0252.180	03.109.90.04.0
03.090.0252.190	03.109.90.03.0
03.090.0252.210	03.105.90.02.0
03.090.0252.220	03.105.90.04.0
03.090.0252.220	03.105.90.05.0
03.090.0252.230	03.106.67.44.0
03.090.0252.240	03.106.67.71.0
03.090.0252.240	03.109.67.71.0
03.090.0252.250	03.106.67.01.0
03.090.0252.260	03.105.46.01.0
03.090.0252.270	03.109.77.18.0
03.090.0252.280	03.109.77.17.0
03.090.0252.290	03.106.77.59.0
03.090.0279.000	0094 898
03.090.0279.010	094 903
03.090.0279.010	1233 462
03.090.0279.010	284 620
03.090.0279.020	365 579
03.090.0279.030	638 167
03.090.0279.040	0754 397
03.090.0279.040	368 829
03.090.0279.050	090 500
03.090.0279.060	0161 518
03.090.0279.070	395 247
03.090.0279.080	595 222

03.090.0279.090	1232 806
03.090.0290.600	A-JB-0465-002
03.090.0290.600	M003176
03.090.0290.610	M068445
03.090.0290.920	A-JA-0489-001
03.090.0290.920	A-JA-0489-002
03.090.0290.920	A-JA-0595-001
03.090.0290.920	31270
03.090.0290.920	86671
03.090.0291.000	A-J 0026001
03.090.0291.000	A-JB 0335001
03.090.0291.000	A-JB0026001
03.090.0291.000	A-30026
03.090.0291.000	A-31468
03.090.0601.000	016.26.52.312.01
03.090.0601.010	015.26.85.111.15 B
03.090.0601.020	107.25.20.150.06
03.090.0601.030	179.24.11.113.06
03.090.0601.040	179.25.20.114.11
03.090.0601.050	315.25.20.122.01
03.090.0601.060	179.25.20.112.07
03.090.0710.700	44.62322.131
03.090.0710.700	8.252.0191.74
03.090.0710.710	3416 4068
03.090.0809.010	7172 079
03.090.0809.010	7183 047
03.090.0809.020	7163 802
03.090.0809.030	4211 8426
03.090.0809.040	0247 9853
03.090.0809.050	0717 2329
03.090.0809.060	4211 8427
03.090.0809.110	0717 3281
03.090.0809.120	0718 3046
03.090.0809.130	0718 3050
03.090.0809.140	8601 7939
03.090.0809.150	0247 5817
03.090.0919.010	81.50110.0214
03.090.0919.010	81.50110.0227
03.090.0919.010	81.50110.0232
03.090.0919.020	81.50110.0104
03.090.0919.020	81.50110.0107
03.090.0919.020	81.50110.0144

Vergleichsliste | Crosslist



aufsteigend nach ST-Nr. | ascending to ST-No.

03.090.0919.030	81.50110.0175
03.090.0919.030	81.50110.0195
03.090.0919.100	81.50110.0101
03.090.0919.110	81.50110.0115
03.090.0919.110	81.50110.0218
03.090.0919.120	51.50110.0212
03.090.0919.130	81.50110.0216
03.090.0919.140	81.50110.0237
03.090.0919.150	81.51110.0194
03.090.0919.160	81.50110.0233
03.090.1940.000	601 423 51 01
03.090.1940.010	301 423 08 01
03.090.1940.010	307 423 01 01
03.090.1940.020	305 423 03 01
03.090.1940.020	305 423 04 01
03.090.1940.030	305 421 01 01
03.090.1940.030	305 421 04 01
03.090.1940.030	305 423 06 01
03.090.1940.030	81.50110.0226
03.090.1940.030	81.50110.0231
03.090.1940.040	675 334 01 04
03.090.1940.040	675 334 19 04
03.090.1940.040	675 334 21 04
03.090.1940.040	675 334 43 04
03.090.1940.040	675 334 55 04
03.090.1940.050	658 421 00 01
03.090.1940.051	624 421 02 01
03.090.1940.060	674 356 06 02
03.090.1940.060	674 356 12 02
03.090.1940.070	675 334 04 04
03.090.1940.070	675 334 24 04
03.090.1940.070	675 334 36 04
03.090.1940.070	675 334 49 04
03.090.1940.070	675 334 53 04
03.090.1940.080	677 421 02 01
03.090.1940.080	677 421 04 01
03.090.1940.080	677 423 02 01
03.090.1940.090	387 421 02 01
03.090.1940.100	346 421 03 01
03.090.1940.100	387 421 00 01
03.090.1940.100	81.50110.0118
03.090.1940.100	81.50110.0213

03.090.1940.100	81.50110.0242
03.090.1940.110	346 423 00 01
03.090.1940.110	346 423 06 01
03.090.1940.110	81.50110.0102
03.090.1940.120	346 423 01 01
03.090.1940.120	346 423 05 01
03.090.1940.120	355 423 06 01
03.090.1940.130	381 423 01 01
03.090.1940.140	381 423 00 01
03.090.1940.150	385 423 03 01
03.090.1940.160	385 423 05 01
03.090.1940.170	305 423 07 01
03.090.1940.180	301 423 01 01
03.090.1940.190	677 421 05 01
03.090.1940.190	677 423 00 01
03.090.1940.230	301 421 01 01
03.090.1940.240	301 423 12 01
03.090.1940.250	302 423 00 01
03.090.1940.260	305 421 00 01
03.090.1940.270	316 356 01 02
03.090.1940.280	320 423 01 01
03.090.1940.290	335 421 03 01
03.090.1940.300	352 421 00 01
03.090.1940.310	360 421 06 01
03.090.1940.330	673 356 12 02
03.090.1940.340	674 356 13 02
03.090.1940.350	675 334 51 04
03.090.1940.360	675 334 56 04
03.090.1940.370	674 356 16 02
03.090.1940.380	677 421 03 01
03.090.1940.390	335 421 02 01
03.090.1940.400	335 423 01 01
03.090.1940.410	674 334 19 04
03.090.2500.000	1.064.0223.00
03.090.2500.010	1.064.0261.01
03.090.2500.020	1.064.0060.02
03.090.2500.030	1.064.0236.00
03.090.2500.030	1.064.0236.01
03.090.2500.040	1.064.0260.01
03.090.2500.040	1.064.0260.02
03.090.2500.050	1.064.0197.00
03.090.2500.070	1.064.0108.01

aufsteigend nach ST-Nr. | ascending to ST-No.

03.090.2500.080	1.064.0280.00
03.090.2500.080	1.064.0280.01
03.090.2500.090	1 064 0273 00
03.090.2500.100	1.064.0218.00
03.090.2500.110	1.064.0270.00
03.090.2500.120	1.064.0277.00
03.090.2500.130	1.064.0278.00
03.090.2500.150	1.064.0149.00
03.090.3002.000	1 361 331
03.090.3002.000	1 414 153
03.090.3002.010	285 901
03.090.3002.010	360 564
03.090.3002.020	1 385 893
03.090.3002.020	1 414 435
03.090.3002.020	293 543
03.090.3002.020	305 438
03.090.3002.020	342 880
03.090.3002.020	360 573
03.090.3002.030	392 390
03.090.3002.040	277 308
03.090.3002.040	305 406
03.090.3002.040	360 572
03.090.3002.050	1 334 075
03.090.3002.050	1 414 152
03.090.3002.060	285 894
03.090.3002.060	360 570
03.090.3002.070	360 571
03.090.3002.080	392 391
03.090.4004.000	1599 009
03.090.4004.010	1599 010
03.090.4004.020	1599 012
03.090.4004.020	1599 012-2
03.090.4004.030	1599 011
03.090.4004.030	1599 011-2
03.090.4004.040	1599 678-8
03.090.4004.050	1590 313/1
03.090.4004.060	1134 817-4
03.090.4004.070	1599 014
03.090.4004.080	1075 310
03.090.4004.080	3171 748
03.090.4004.090	1075 307
03.090.4004.090	3171 745

03.090.4004.100	107 5309
03.090.4004.100	1075 306
03.090.4004.100	3171 744
03.090.4004.110	1075 309
03.090.4004.110	3171 747
03.090.4004.120	0352 786
03.090.4004.130	1589 429
03.090.4004.140	1577 439
03.090.4004.150	0324 005
03.090.4004.160	1599 679
03.090.4004.170	6772 133
03.090.4200.300	210 21 14
03.090.4200.310	212 09 723 S
03.090.4200.320	212 20 183
03.090.4200.330	210 18 986
03.090.4250.990	5010098949
03.090.4251.000	5000737768
03.100.0240.100	03.001.08.05.0
03.100.0240.180	03.084.42.02.0
03.100.0243.580	03.001.08.03.0
03.100.0244.330	02.6010.25.60
03.100.0244.341	02.6010.35.60
03.100.0246.690	99.00.000.0.88
03.100.0249.000	99.00.000.0.71
03.100.0249.120	99.00.000.0.93
03.100.0249.130	99.00.000.0.37
03.100.0249.140	99.00.000.0.40
03.100.0249.150	99.00.000.0.42
03.100.0249.160	99.00.000.0.70
03.100.0249.170	99.00.000.0.72
03.100.0249.180	99.00.000.0.73
03.100.0249.190	05.010.98.20.0
03.100.0249.190	05.010.98.21.0
03.100.0249.190	05.010.98.49.1
03.100.0249.190	05.010.98.50.1
03.100.0249.190	99.00.000.0.76
03.100.0249.200	99.00.000.0.80
03.100.0249.210	99.00.000.0.85
03.100.0249.220	99.00.000.0.89
03.100.0249.230	99.00.000.0.94
03.100.0249.240	99.00.000.0.95
03.100.0249.250	99.00.000.0.97

Vergleichsliste | Crosslist

aufsteigend nach ST-Nr. | ascending to ST-No.

03.100.0249.260	99.00.000.0.84
03.100.0249.270	99.00.000.1.03
03.100.0249.280	99.00.000.0.81
03.100.0249.290	99.00.000.0.83
03.100.0249.300	99.00.000.1.06
03.100.0249.310	99.00.000.1.05
03.100.0249.320	99.00.000.0.75
03.100.0249.330	99.00.000.0.98
03.100.0249.390	99.00.000.1.09
03.100.0290.160	A-JA-0483-001
03.100.0290.980	AR-JB-0006-701
03.100.0290.990	AR-JB-0006-701
03.100.2036.900	3.005.0037.03
03.100.2037.200	3.005.0147.00
03.100.2039.300	3.005.0141.00
03.100.2039.400	3.005.0173.00
03.100.2039.600	3.005.0117.00
03.100.2039.700	3.005.0055.00
03.100.2039.800	3.005.0009.02
03.100.2039.900	3.005.0108.00
03.100.3002.190	375 329
03.100.3504.240	M002904
03.100.3504.240	M002912
03.100.3505.050	6502809R
03.100.4003.150	1629 835
03.100.4003.160	2036 734-3
03.100.4003.170	1629 836
03.100.4004.190	1629 834
03.100.4201.000	212 24 522
03.100.4201.010	212 20 647
03.100.4201.020	210 08 062
03.100.4201.030	212 21 567
03.100.4201.040	212 00 910
03.110.0251.000	03.088.34.02.0
03.110.0251.000	03.088.34.02.7
03.110.0251.000	03.088.34.06.0
03.110.0251.000	03.088.34.06.7
03.110.0251.030	03.088.35.04.7
03.110.0251.040	03.088.34.01.0
03.110.0251.040	03.088.34.01.7
03.110.0251.040	03.088.34.03.0
03.110.0251.040	03.088.34.03.7

03.110.0251.050	03.088.34.08.7
03.110.0251.060	03.088.34.10.0
03.110.0251.060	03.088.34.10.7
03.110.0251.070	03.088.35.05.0
03.110.0251.070	03.088.35.05.7
03.110.0251.080	03.088.34.13.0
03.110.0251.080	03.088.34.13.7
03.110.0275.800	MAK 2578
03.110.0275.810	1238 372
03.110.0275.810	299 095
03.110.0275.820	MAK 7429
03.110.0275.820	MAK 7529
03.110.0275.820	PAK7404
03.110.0275.840	AMPA014
03.110.0275.840	AMPB481
03.110.0275.840	AMPB860
03.110.0275.840	MJK2785
03.110.0275.850	1400 163
03.110.0275.860	1400 273
03.110.0275.870	1400 284
03.110.0275.880	1403 758
03.110.0275.890	1400 069
03.110.0620.000	0501.313.313
03.110.0620.000	8.285.390.000
03.110.0620.010	172.24.11.130.02
03.110.0620.010	173.25.20.128.02
03.110.0620.020	179.24.11.111.31
03.110.0620.030	179.24.11.113.07
03.110.0711.000	0801.621.00
03.110.0711.010	0801.616.00
03.110.0711.020	0821.333.10
03.110.0711.030	0821.358.30
03.110.0711.030	1 415 147
03.110.0810.400	8582 290
03.110.0811.400	8584 182
03.110.0813.200	0190 7528
03.110.0814.400	0716 8368
03.110.0814.400	0717 1274
03.110.0815.200	0190 7527
03.110.0815.200	0190 7530
03.110.0815.200	0190 8578
03.110.0815.200	7172 018

aufsteigend nach ST-Nr. | ascending to ST-No.

03.110.0816.400	7171 255	03.110.1926.110	437 421 05 12
03.110.0817.400	7172 880	03.110.1926.120	440 421 01 12
03.110.0817.400	7172 881	03.110.1926.130	601 420 01 72
03.110.0817.400	7172 882	03.110.1926.130	601 420 03 72
03.110.0818.400	0299 1979	03.110.1926.130	601 421 03 12
03.110.0818.400	7573 317	03.110.1926.130	601 421 05 12
03.110.0819.400	9380 0492	03.110.1926.140	356 421 03 12
03.110.0820.400	0717 2928	03.110.1926.140	356 421 10 12
03.110.0820.400	0717 2929	03.110.1926.140	356 421 12 12
03.110.0820.400	0717 2930	03.110.1926.150	670 421 01 012
03.110.0821.400	4247 0842	03.110.1926.160	975 421 00 12
03.110.0821.400	9382 1918	03.110.1926.160	975 421 01 12
03.110.0822.200	0190 8773	03.110.1926.160	975 421 02 12
03.110.0823.200	0190 6438	03.110.1926.170	902 423 03 12
03.110.0823.200	0299 2477	03.110.1926.180	902 421 06 12
03.110.0922.010	81.50803.0010	03.110.1926.190	943 421 03 12
03.110.0922.020	81.50803.0026	03.110.1926.200	669 421 05 12
03.110.0922.030	81.50803.0015	03.110.1926.210	904 423 02 12
03.110.0922.040	81.50803.0022	03.110.1926.210	904 423 03 12
03.110.0922.050	81.50803.0038	03.110.1926.220	975 423 06 12
03.110.0922.070	81.50803.0020	03.110.1926.230	668 423 05 12
03.110.0922.070	81.50803.0027	03.110.1926.240	668 423 04 12
03.110.0922.080	81.35700.6111	03.110.1926.250	668 423 01 12
03.110.0922.080	81.50803.0028	03.110.1926.260	668 423 00 12
03.110.0922.080	81.50803.0048	03.110.1926.270	970 423 05 12
03.110.0922.090	81.50803.0040	03.110.1926.270	970 423 07 12
03.110.0922.100	81.50803.0021	03.110.1926.280	970 423 04 12
03.110.0922.100	81.50803.0041	03.110.1926.280	970 423 06 12
03.110.0922.130	81.50803.0042	03.110.1926.280	970 423 10 12
03.110.1926.000	942 421 05 12	03.110.1926.280	970 423 12 12
03.110.1926.000	942 421 09 12	03.110.1926.290	901 423 08 12
03.110.1926.010	669 421 06 012	03.110.1926.300	601 420 00 72
03.110.1926.020	970 421 00 12	03.110.1926.300	601 420 02 72
03.110.1926.020	970 421 02 12	03.110.1926.300	601 421 50 12
03.110.1926.020	970 421 06 12	03.110.1926.300	601 421 51 12
03.110.1926.030	668 421 01 12	03.110.1926.300	601 421 51 12.
03.110.1926.040	668 421 02 12	03.110.1926.310	631 420 03 72
03.110.1926.050	416 421 04 12	03.110.1926.330	631 420 01 72
03.110.1926.060	417 421 00 12	03.110.1926.340	638 421 01 12
03.110.1926.070	425 421 00 12	03.110.1926.350	638 423 01 12
03.110.1926.090	437 421 02 12	03.110.1926.390	81.50803.0039
03.110.1926.100	437 421 04 12	03.110.1926.390	970 423 02 12

Vergleichsliste | Crosslist

aufsteigend nach ST-Nr. | ascending to ST-No.

03.110.2400.000	4.079.0005.00	03.120.8700.020	WVA 29030
03.110.2400.000	4.079.0005.01	03.120.8700.020	003 420 84 20
03.110.2400.000	4.079.0005.02	03.120.8700.020	5001823000
03.110.2401.000	4.079.0004.00	03.120.8700.020	81.50820.5006
03.110.2402.000	4.079.0003.00	03.120.8700.020	81.50820.5064
03.110.2403.000	4.079.0007.00	03.120.8700.020	81.50820.6002
03.110.2403.000	4.079.0007.01	03.120.8700.020	81.50820.6014
03.110.3021.000	1 386 686	03.120.8700.020	81.50820.6016
03.110.3504.900	M069018	03.120.8700.020	81.50820.6034
03.110.3504.910	M078157	03.120.8700.020	81.50820.6036
03.110.4020.000	3112 960	03.120.8700.020	81.50820.6046
03.110.4020.000	3112 965	03.120.8700.020	8.285.388.435
03.110.4020.010	6774 686-7	03.120.8700.020	8.285.408.463
03.110.4020.020	6775 223	03.120.8700.020	8.285.408.534
03.110.4020.020	6775 227-9	03.120.8700.020	8.285.521.000
03.110.4020.020	6775 229	03.120.8700.020	8.285.522.000
03.110.4020.030	6779 208	03.120.8700.020	8.285.525.000
03.110.4200.340	212 24 263	03.120.8700.020	8.285.526.000
03.110.4200.390	212 27 349	03.120.8700.030	WVA 29032
03.110.4255.000	5000450158	03.120.8700.040	WVA 29043
03.110.4255.010	5010019249	03.120.8700.040	5000297198
03.110.4255.010	5010190865	03.120.8700.040	5000297345
03.110.4255.010	5010207431	03.120.8700.040	5000525640
03.110.4255.020	5010216437	03.120.8700.040	5001821964
03.110.4255.030	5010216548	03.120.8700.050	WVA 29055
03.110.4255.040	500396612	03.120.8700.050	81.50804.6025
03.110.4255.060	5010216433	03.120.8700.050	81.50820.5011
03.110.4255.070	5010216932	03.120.8700.050	81.50820.6009
03.110.4255.070	5010260102	03.120.8700.050	81.50820.6011
03.110.4255.080	5010216931	03.120.8700.060	WVA 29065
03.110.4255.080	5010260101	03.120.8700.060	0190 6144
03.110.4255.090	5010260609	03.120.8700.060	50.01014.694
03.110.4255.100	5010260603	03.120.8700.070	WVA 29067
03.110.4255.110	5010422364	03.120.8700.070	0190 6043
03.120.8700.000	WVA 29011	03.120.8700.070	5001014704
03.120.8700.000	1906 191	03.120.8700.080	WVA 29076
03.120.8700.000	1906 459	03.120.8700.080	000 423 71 10
03.120.8700.000	290 112 50 04	03.120.8700.080	002 420 42 20
03.120.8700.000	333 344	03.120.8700.080	003 420 17 20
03.120.8700.010	WVA 29012	03.120.8700.080	004 420 26 20
03.120.8700.010	0190 6040	03.120.8700.080	902 421 01 10
03.120.8700.02P	WVA 29030	03.120.8700.090	WVA 29088

aufsteigend nach ST-Nr. | ascending to ST-No.

03.120.8700.090	81.50820.5023
03.120.8700.090	81.50820.5029
03.120.8700.090	81.50820.6006
03.120.8700.090	81.50820.6020
03.120.8700.100	WVA 29090
03.120.8700.100	5001831161
03.120.8700.100	5001833114
03.120.8700.100	5001846034
03.120.8700.11P	WVA 29095
03.120.8700.110	WVA 29093
03.120.8700.110	WVA 29095
03.120.8700.110	002 420 78 20
03.120.8700.110	02.0312.15.00
03.120.8700.110	02.0312.16.00
03.120.8700.110	05.801.02.93.0
03.120.8700.110	09.801.02.75.0
03.120.8700.110	09.801.02.93.0
03.120.8700.110	290 953 00 14
03.120.8700.110	3.057.0078.00
03.120.8700.12P	WVA 29087
03.120.8700.120	WVA 29087
03.120.8700.120	000 421 05 10
03.120.8700.120	000 421 43 10
03.120.8700.120	003 420 10 20
03.120.8700.120	003 420 16 20
03.120.8700.120	003 420 20 20
03.120.8700.120	003 420 22 20
03.120.8700.120	003 420 35 20
03.120.8700.120	004 420 22 20
03.120.8700.120	0190 6439
03.120.8700.120	0190 6467
03.120.8700.120	05.362.70.02.0
03.120.8700.120	0821.340.00
03.120.8700.120	0821.351.00
03.120.8700.120	09.801.02.57.0
03.120.8700.120	09.801.02.92.0
03.120.8700.120	09.801.06.20.0
03.120.8700.120	09.801.06.96.0
03.120.8700.120	1 390 428
03.120.8700.120	1 439 324
03.120.8700.120	1439 324
03.120.8700.120	1617 343

03.120.8700.120	1906 467
03.120.8700.120	204 552
03.120.8700.120	290 593 00 14
03.120.8700.120	290 613 00 14
03.120.8700.120	29106
03.120.8700.120	29109
03.120.8700.120	29163
03.120.8700.120	305 700 77 00
03.120.8700.120	3.057.0077.00
03.120.8700.120	3.057.0079.00
03.120.8700.120	501316953
03.120.8700.120	69823
03.120.8700.120	81.50820.6030
03.120.8700.120	8.285.000.571
03.120.8700.120	8.285.515.573
03.120.8700.120	9291 037
03.120.8700.130	WVA 29115
03.120.8700.130	000 421 10 10
03.120.8700.130	001 421 05 10
03.120.8700.130	001 421 06 10
03.120.8700.130	002 420 57 20
03.120.8700.130	003 420 11 20
03.120.8700.130	003 420 12 20
03.120.8700.130	003 420 66 20
03.120.8700.140	WVA 29125
03.120.8700.15P	WVA 29120
03.120.8700.150	WVA 29120
03.120.8700.150	3.057.3179.00
03.120.8700.16P	WVA 29143
03.120.8700.160	WVA 29143
03.120.8700.160	3.057.3179.00
03.120.8700.170	WVA 29835
03.120.8700.170	001 420 15 20
03.120.8700.170	002 420 57 20
03.120.8700.170	002 420 62 20
03.120.8700.170	669 420 00 20
03.120.8700.170	669 420 01 20
03.120.8700.170	669 421 01 08
03.120.8700.170	670 420 28 20
03.120.8700.180	WVA 29131
03.120.8700.180	5001855646
03.120.8700.180	81.50820.5072

Vergleichsliste | Crosslist

aufsteigend nach ST-Nr. | ascending to ST-No.

03.120.8700.190	WVA 23021
03.120.8700.200	WVA 23022
03.120.8700.210	WVA 23020
03.120.8700.210	000 421 42 10
03.120.8700.220	WVA 20934
03.120.8700.220	WVA 21573
03.120.8700.230	WVA 29706
03.120.8700.230	5001834527
03.120.8700.250	WVA 21576
03.120.8700.250	WVA 21577
03.120.8700.250	002 420 39 20
03.120.8700.250	901 421 04 10
03.120.8700.250	901 421 05 10
03.120.8700.250	901 421 06 10
03.120.8700.260	WVA 21904
03.120.8700.260	002 420 48 20
03.120.8700.260	638 423 01 10
03.120.8700.270	WVA 21621
03.120.8700.270	000 421 24 10
03.120.8700.270	002 420 56 20
03.120.8700.270	002 420 69 20
03.120.8700.280	WVA 21592
03.120.8700.280	002 420 40 20
03.120.8700.290	WVA 29374
03.120.8700.290	0190 6401
03.120.8700.290	0299 2339
03.120.8700.290	4253 5791
03.120.8700.300	WVA 29122
03.120.8700.300	WVA 29357
03.120.8700.31P	WVA 29126
03.120.8700.310	WVA 29126
03.120.8700.310	12 999 737
03.120.8700.310	1628 064
03.120.8700.320	WVA 29119
03.120.8700.320	WVA 29141
03.120.8700.320	WVA 29142
03.120.8700.320	29142
03.120.8700.320	5001855902
03.120.8700.340	WVA 29136
03.120.8700.35P	WVA 29162
03.120.8700.350	WVA 29162
03.120.8700.360	WVA 29137

03.120.8700.380	WVA 29123
03.120.8700.390	WVA 29154
03.120.8700.41P	WVA 29215
03.120.8700.410	WVA 29215
03.120.8700.42P	WVA 29216
03.120.8700.420	WVA 29216
03.120.8700.43P	WVA 29158
03.120.8700.430	WVA 29158
03.130.0923.960	81.90405.0254
03.130.0923.970	06.02191.2824
03.130.0923.980	06.01902.3413
03.130.1905.140	942 990 28 04
03.130.1905.150	910105 014019
03.130.1935.000	669 540 04 17
03.130.1935.000	669 540 05 17
03.130.1935.020	677 540 07 17
03.130.1935.030	677 540 08 17
03.130.1935.040	000 540 02 17
03.130.1935.040	123 540 00 17
03.130.1935.050	601 540 13 17
03.130.1935.060	356 540 00 17
03.130.1935.070	901 540 00 17
03.130.1935.070	901 540 01 17
03.130.1935.110	910105 014009
03.130.1935.120	910105 014017
03.130.8701.000	WVA29011
03.130.8701.000	WVA29032
03.130.8701.000	1907 956
03.130.8701.010	1908 231
03.130.8701.020	WVA29065
03.130.8701.020	WVA29067
03.130.8701.020	1907 842
03.130.8701.030	WVA29065
03.130.8701.030	WVA29067
03.130.8701.040	WVA29067
03.130.8701.050	WVA29067
03.130.8701.060	WVA29065
03.130.8701.060	5001829545
03.130.8701.070	WVA29065
03.130.8701.090	WVA29030
03.130.8701.090	WVA29090
03.130.8701.130	WVA29030

aufsteigend nach ST-Nr. | ascending to ST-No.

03.130.8701.130	WVA29088
03.130.8701.130	81.50822.6014
03.130.8701.140	WVA29088
03.130.8701.140	WVA29131
03.130.8701.160	WVA 29043
03.130.8701.170	WVA 29030
03.130.8701.170	WVA 29835
03.130.8701.170	669 540 06 17
03.130.8701.180	81.50811.0004
03.130.8701.190	WVA 29030
11.030.0245.250	03.272.30.05.0
11.030.0245.250	03.272.30.07.0
11.030.0245.250	03.272.30.30.0
11.030.0245.950	03.272.48.07.0
11.030.0245.950	03.272.48.10.0
11.030.0245.950	03.272.48.12.0
11.030.0245.950	03.272.48.32.0
11.030.0246.170	03.272.30.81.0
11.030.0246.170	03.272.30.87.0
11.030.0246.180	03.272.30.41.0
11.030.0246.180	03.272.30.62.0
11.030.0246.190	03.272.30.31.0
11.030.0246.460	03.272.48.17.0
11.030.0246.460	03.272.48.33.0
11.030.0246.470	03.272.48.40.0
11.030.0246.470	03.272.48.46.0
11.030.0246.950	03.272.48.78.0
11.030.0290.290	A-JB-0038-001
11.030.1909.730	942 334 12 01
11.030.2037.100	1.307.1129.01
11.030.2246.000	3.307.3006.00
11.030.2246.100	1.146.2004.02
11.030.3504.100	6502795D
11.030.3504.100	6503723T
11.030.3504.270	M006050

SERVICE-HOTLINE

FON: +49 5156-9610-0

FAX: +49 5156-961196



aufsteigend nach Vergleichsnummer | ascending to Comp.-No.

BERGISCHE ACHSE	
02.0312.15.00	03.120.8700.110
02.0312.16.00	03.120.8700.110
02.3502.04.00	03.020.0242.300
02.5603.24.90	03.070.0242.550
02.5616.04.90	03.020.0244.700
02.5616.05.90	03.020.0243.2 S
02.5616.05.90	03.020.0244.740
02.5676.01.00	03.020.0242.600
02.5677.21.00	03.070.0242.610
02.5677.37.42	03.020.0242.620
02.5679.23.00	03.020.0244.280
02.5805.80.35	03.060.7450.000
02.5805.81.35	03.060.7450.250
02.5805.82.35	03.060.7450.150
02.5805.83.35	03.060.7450.300
02.5805.84.35	03.060.7450.200
02.6010.25.60	03.100.0244.330
03.001.08.03.0	03.100.0243.580
03.001.08.05.0	03.100.0240.100
03.084.42.02.0	03.100.0240.180
03.084.46.05.0	03.070.0230.010
03.084.46.05.0	03.070.0230.000
03.084.46.22.0	03.070.0242.860
03.084.52.06.0	03.070.0240.190
03.084.54.01.0	03.070.0238.000
03.084.54.02.0	03.070.0206.000
03.084.55.11.0	03.070.0239.000
03.084.66.15.0	03.070.0232.000
03.084.75.24.0	03.070.0246.900
03.088.34.01.0	03.110.0251.040
03.088.34.01.7	03.110.0251.040
03.088.34.02.0	03.110.0251.000
03.088.34.02.7	03.110.0251.000
03.088.34.03.0	03.110.0251.040
03.088.34.03.7	03.110.0251.040
03.088.34.06.0	03.110.0251.000
03.088.34.06.7	03.110.0251.000
03.088.34.08.7	03.110.0251.050
03.088.34.10.0	03.110.0251.060
03.088.34.10.7	03.110.0251.060

BERGISCHE ACHSE	
03.088.34.13.0	03.110.0251.080
03.088.34.13.7	03.110.0251.080
03.088.35.04.7	03.110.0251.030
03.088.35.05.0	03.110.0251.070
03.088.35.05.7	03.110.0251.070
03.105.46.01.0	03.090.0252.260
03.105.46.03.0	03.090.0252.060
03.105.46.10.0	03.090.0252.100
03.105.46.13.0	03.090.0252.110
03.105.46.20.0	03.090.0252.000
03.105.46.29.0	03.090.0252.170
03.105.90.02.0	03.090.0252.210
03.105.90.04.0	03.090.0252.220
03.105.90.05.0	03.090.0252.220
03.106.67.01.0	03.090.0252.250
03.106.67.12.0	03.090.0252.070
03.106.67.44.0	03.090.0252.230
03.106.67.54.0	03.090.0252.010
03.106.67.62.0	03.090.0252.030
03.106.67.71.0	03.090.0252.240
03.106.77.04.0	03.090.0252.080
03.106.77.11.0	03.090.0252.090
03.106.77.52.0	03.090.0252.040
03.106.77.57.0	03.090.0252.050
03.106.77.59.0	03.090.0252.290
03.106.77.63.0	03.090.0252.130
03.109.46.06.0	03.090.0252.160
03.109.46.40.0	03.090.0252.000
03.109.46.49.0	03.090.0252.170
03.109.67.13.0	03.090.0252.030
03.109.67.19.0	03.090.0252.120
03.109.67.71.0	03.090.0252.240
03.109.67.74.0	03.090.0252.010
03.109.67.82.0	03.090.0252.030
03.109.77.16.0	03.090.0252.050
03.109.77.16.0	03.090.0252.140
03.109.77.17.0	03.090.0252.280
03.109.77.18.0	03.090.0252.270
03.109.77.72.0	03.090.0252.040

Vergleichsliste | Crosslist

aufsteigend nach Vergleichsnummer | ascending to Comp.-No.

BERGISCHE ACHSE		BERGISCHE ACHSE	
03.109.77.77.0	03.090.0252.050	03.272.30.05.0	11.030.0245.250
03.109.90.03.0	03.090.0252.190	03.272.30.07.0	11.030.0245.250
03.109.90.04.0	03.090.0252.180	03.272.30.30.0	11.030.0245.250
03.109.90.24.0	03.090.0252.150	03.272.30.31.0	11.030.0246.190
03.112.22.07.0	03.070.0240.760	03.272.30.41.0	11.030.0246.180
03.112.22.21.0	03.070.0240.760	03.272.30.62.0	11.030.0246.180
03.112.22.23.0	03.070.0240.760	03.272.30.81.0	11.030.0246.170
03.112.22.24.0	03.070.0240.760	03.272.30.87.0	11.030.0246.170
03.112.44.22.0	03.020.0240.090	03.272.48.07.0	11.030.0245.950
03.112.44.30.0	03.020.0240.080	03.272.48.10.0	11.030.0245.950
03.112.44.30.0 S	03.020.0242.3 S	03.272.48.12.0	11.030.0245.950
03.112.44.30.0 S	03.020.0242.4 S	03.272.48.17.0	11.030.0246.460
03.112.44.30.0 SP	03.020.0242.4 S	03.272.48.32.0	11.030.0245.950
03.112.44.34.0	03.020.0240.082	03.272.48.33.0	11.030.0246.460
03.113.03.06.0	03.020.0247.800	03.272.48.40.0	11.030.0246.470
03.113.14.01.0	03.020.0240.150	03.272.48.46.0	11.030.0246.470
03.113.14.01.0 S	03.020.0246.3 S	03.272.48.78.0	11.030.0246.950
03.113.14.03.0	03.020.0238.011	03.310.70.15.0	03.070.0246.910
03.114.44.03.0	03.070.0243.550	03.310.81.02.0	03.020.0244.270
03.120.42.02.0	03.020.0243.520	03.320.11.10.0	03.020.0244.290
03.120.42.08.0	03.020.0247.880	03.320.11.16.0	03.020.0244.600
03.120.42.09.0	03.020.0247.870	03.320.11.16.1	03.020.0244.600
03.120.43.09.0	03.020.0246.220	03.331.34.01.0	03.070.0244.800
03.120.43.10.0	03.020.0246.230	03.331.34.02.0	03.070.0243.000
03.120.43.12.0	03.020.0238.040	03.331.34.02.0 S	03.070.0243.0 S
03.120.43.14.0	03.020.0240.840	03.331.34.05.0	03.070.0242.900
03.120.63.01.0	03.020.0240.840	03.340.01.01.0	03.070.0227.000
03.167.23.02.0	03.070.0245.920	03.340.01.02.0	03.070.0205.000
03.177.23.09.0	03.070.0234.010	03.350.00.13.0	03.070.0242.910
03.177.23.10.0	03.070.0234.010	03.350.00.14.0	03.070.0247.830
03.177.23.10.1	03.070.0234.010	03.350.30.01.0	03.020.0242.300
03.200.34.02.0	03.070.0240.000	03.350.30.02.0	03.020.0242.300
03.200.64.01.0	03.070.0207.000	03.397.26.03.0	03.080.0240.130
03.229.02.01.0	03.020.0245.380	03.397.26.04.0	03.080.0240.020
03.229.02.03.0	03.020.0241.150	03.397.34.01.0	03.080.0241.880
03.229.02.09.0	03.020.0245.380	03.397.34.02.0	03.080.0241.890
03.229.02.10.0	03.020.0245.390	03.397.34.10.0	03.080.0241.900
03.229.02.16.0	03.020.0238.020	03.397.34.11.0	03.080.0241.900
03.229.02.17.0	03.020.0238.030	03.397.35.01.0	03.080.0241.910
03.229.02.18.0	03.020.0247.900	03.397.44.06.0	03.080.0242.880
03.232.13.02.0	03.070.0243.010	03.397.45.06.0	03.080.0245.170

aufsteigend nach Vergleichsnummer | ascending to Comp.-No.

BERGISCHE ACHSE	
03.397.45.10.0	03.080.0246.870
03.397.46.10.0	03.080.0245.700
05.010.98.20.0	03.100.0249.190
05.010.98.21.0	03.100.0249.190
05.010.98.49.1	03.100.0249.190
05.010.98.50.1	03.100.0249.190
05.091.14.19.0	03.040.0242.930
05.091.14.46.0	03.040.0242.870
05.091.14.65.0	03.040.0242.871
05.091.14.70.0	03.040.0242.931
05.091.19.07.0	03.040.0247.100
05.091.26.21.0	03.040.0242.700
05.091.26.64.2	03.040.0242.760
05.091.27.54.2	03.040.0242.770
05.091.27.79.0	03.040.0242.771
05.091.28.11.2	03.040.0247.130
05.091.46.09.0	03.040.0242.761
05.091.46.09.0	03.040.0242.763
05.097.05.01.1	03.010.0240.231
05.097.05.01.3	03.010.0240.231
05.097.05.02.1	03.010.0240.241
05.097.05.02.3	03.010.0240.241
05.097.05.03.0	03.010.0240.251
05.097.05.03.1	03.010.0240.251
05.097.05.03.3	03.010.0240.251
05.097.05.05.0	03.010.0240.271
05.097.05.05.1	03.010.0240.271
05.097.05.05.3	03.010.0240.271
05.097.05.06.0	03.010.0240.281
05.097.05.06.1	03.010.0240.281
05.097.05.06.3	03.010.0240.281
05.097.05.07.0	03.010.0240.291
05.097.05.07.1	03.010.0240.291
05.097.05.07.3	03.010.0240.291
05.097.05.08.0	03.010.0240.301
05.097.05.08.1	03.010.0240.301
05.097.05.08.3	03.010.0240.301
05.097.05.09.0	03.010.0240.311
05.097.05.09.1	03.010.0240.311
05.097.05.09.3	03.010.0240.311
05.097.05.10.0	03.010.0240.321

BERGISCHE ACHSE	
05.097.05.10.1	03.010.0240.321
05.097.05.10.3	03.010.0240.321
05.097.05.11.0	03.010.0240.331
05.097.05.11.1	03.010.0240.331
05.097.05.11.3	03.010.0240.331
05.097.05.12.0	03.010.0240.341
05.097.05.12.1	03.010.0240.341
05.097.05.12.3	03.010.0240.341
05.097.05.13.0	03.010.0240.351
05.097.05.13.1	03.010.0240.351
05.097.05.13.3	03.010.0240.351
05.097.05.14.0	03.010.0240.361
05.097.05.14.1	03.010.0240.361
05.097.05.14.3	03.010.0240.361
05.097.05.15.0	03.010.0240.371
05.097.05.15.1	03.010.0240.371
05.097.05.15.3	03.010.0240.371
05.097.05.16.0	03.010.0240.381
05.097.05.16.1	03.010.0240.381
05.097.05.16.3	03.010.0240.381
05.097.05.17.0	03.010.0240.391
05.097.05.17.1	03.010.0240.391
05.097.05.17.3	03.010.0240.391
05.097.05.18.0	03.010.0240.401
05.097.05.18.1	03.010.0240.401
05.097.05.18.3	03.010.0240.401
05.097.05.19.0	03.010.0240.411
05.097.05.19.1	03.010.0240.411
05.097.05.19.3	03.010.0240.411
05.097.05.20.0	03.010.0240.421
05.097.05.20.1	03.010.0240.421
05.097.05.20.3	03.010.0240.421
05.097.05.21.0	03.010.0240.431
05.097.05.21.1	03.010.0240.431
05.097.05.21.3	03.010.0240.431
05.097.05.22.0	03.010.0240.441
05.097.05.22.1	03.010.0240.441
05.097.05.22.3	03.010.0240.441
05.097.05.23.0	03.010.0240.451
05.097.05.23.1	03.010.0240.451
05.097.05.23.3	03.010.0240.451

Vergleichsliste | Crosslist

aufsteigend nach Vergleichsnummer | ascending to Comp.-No.

BERGISCHE ACHSE		BERGISCHE ACHSE	
05.097.05.24.0	03.010.0240.461	05.097.05.45.0	03.010.0240.671
05.097.05.24.1	03.010.0240.461	05.097.05.45.1	03.010.0240.671
05.097.05.24.3	03.010.0240.461	05.097.05.45.3	03.010.0240.671
05.097.05.25.0	03.010.0240.471	05.097.05.46.0	03.010.0240.681
05.097.05.25.1	03.010.0240.471	05.097.05.46.1	03.010.0240.681
05.097.05.25.3	03.010.0240.471	05.097.05.46.3	03.010.0240.681
05.097.05.26.0	03.010.0240.481	05.097.05.47.0	03.010.0240.691
05.097.05.26.1	03.010.0240.481	05.097.05.47.1	03.010.0240.691
05.097.05.26.3	03.010.0240.481	05.097.05.47.3	03.010.0240.691
05.097.05.27.0	03.010.0240.491	05.097.05.48.0	03.010.0240.701
05.097.05.27.1	03.010.0240.491	05.097.05.48.1	03.010.0240.701
05.097.05.27.3	03.010.0240.491	05.097.05.48.3	03.010.0240.701
05.097.05.28.0	03.010.0240.501	05.174.45.70.0	03.030.1906.570
05.097.05.28.1	03.010.0240.501	05.174.52.10.0	03.030.0240.870
05.097.05.28.3	03.010.0240.501	05.174.52.23.0	03.030.0240.880
05.097.05.29.0	03.010.0240.511	05.174.52.34.0	03.030.0240.890
05.097.05.29.1	03.010.0240.511	05.174.52.61.0	03.030.0240.900
05.097.05.29.3	03.010.0240.511	05.174.54.69.0	03.030.1906.560
05.097.05.30.0	03.010.0240.521	05.174.65.13.0	03.030.0244.901
05.097.05.30.1	03.010.0240.521	05.174.72.12.0	03.030.8750.42S
05.097.05.30.3	03.010.0240.521	05.174.82.02.0	03.030.8750.490
05.097.05.31.1	03.010.0240.531	05.174.82.02.1	03.030.8750.490
05.097.05.31.3	03.010.0240.531	05.174.82.02.2	03.030.8750.490
05.097.05.32.1	03.010.0240.541	05.174.82.03.0	03.030.8750.490
05.097.05.32.3	03.010.0240.541	05.174.82.03.1	03.030.8750.490
05.097.05.35.1	03.010.0240.571	05.174.82.03.1	03.030.8750.42S
05.097.05.35.3	03.010.0240.571	05.174.82.03.2	03.030.8750.42S
05.097.05.36.1	03.010.0240.581	05.174.82.03.2	03.030.8750.490
05.097.05.36.3	03.010.0240.581	05.174.82.12.0	03.030.8750.490
05.097.05.37.0	03.010.0240.591	05.174.82.12.2	03.030.8750.490
05.097.05.37.1	03.010.0240.591	05.174.82.14.0	03.030.8750.490
05.097.05.37.3	03.010.0240.591	05.174.82.14.2	03.030.8750.490
05.097.05.38.0	03.010.0240.601	05.174.82.21.0	03.030.8750.490
05.097.05.38.1	03.010.0240.601	05.174.82.21.2	03.030.8750.490
05.097.05.38.3	03.010.0240.601	05.174.82.22.0	03.030.8750.490
05.097.05.39.0	03.010.0240.611	05.174.82.22.2	03.030.8750.490
05.097.05.39.1	03.010.0240.611	05.174.82.24.0	03.030.8750.490
05.097.05.39.3	03.010.0240.611	05.174.82.24.2	03.030.8750.490
05.097.05.40.0	03.010.0240.621	05.174.82.31.0	03.030.8750.490
05.097.05.40.1	03.010.0240.621	05.174.82.31.2	03.030.8750.42S
05.097.05.40.3	03.010.0240.621	05.174.82.31.2	03.030.8750.490

aufsteigend nach Vergleichsnummer | ascending to Comp.-No.

BERGISCHE ACHSE	
05.174.82.39.2	03.030.8750.490
05.174.82.47.0	03.030.8750.490
05.174.82.47.2	03.030.8750.490
05.174.82.49.0	03.030.8750.490
05.174.82.49.2	03.030.8750.490
05.174.82.56.2	03.030.8750.490
05.174.82.63.2	03.030.8750.490
05.174.82.63.3	03.030.8750.490
05.174.82.67.2	03.030.8750.490
05.174.82.74.2	03.030.8750.490
05.174.90.20.0	03.030.8750.122
05.331.44.02.0	03.070.0246.890
05.331.84.01.0	03.070.0240.0 S
05.362.70.02.0	03.120.8700.120
05.397.26.01.0	03.030.0241.860
05.397.26.02.0	03.030.0241.860
05.397.26.02.0	03.030.0241.850
05.397.26.03.0	03.080.0240.130
05.397.34.16.0	03.080.0250.060
05.397.34.17.0	03.080.0246.860
05.397.35.01.0	03.080.0241.910
05.397.35.02.0	03.080.0245.970
05.397.35.03.0	03.080.0241.910
05.397.45.05.0	03.080.0240.120
05.397.45.14.0	03.080.0246.210
05.397.46.03.0	03.080.0241.920
05.397.46.06.0	03.080.0241.930
05.397.46.07.0	03.080.0241.930
05.397.46.12.0	03.080.0246.430
05.397.46.13.0	03.080.0246.880
05.397.56.07.0	03.080.0240.070
05.397.58.03.0	03.080.0241.980
05.574.82.02.1	03.030.8750.490
05.574.82.03.1	03.030.8750.490
05.574.82.12.1	03.030.8750.490
05.574.82.19.0	03.030.8750.490
05.574.82.20.0	03.030.8750.490
05.574.82.22.0	03.030.8750.490
05.574.82.27.0	03.030.8750.490
05.574.82.43.0	03.030.8750.490
05.574.82.43.2	03.030.8750.490

BERGISCHE ACHSE	
05.574.82.44.0	03.030.8750.490
05.574.82.44.2	03.030.8750.490
05.574.82.55.2	03.030.8750.490
05.574.82.59.2	03.030.8750.490
05.574.82.65.2	03.030.8750.490
05.574.82.67.2	03.030.8750.490
05.574.82.67.2	03.030.8750.42S
05.574.82.68.2	03.030.8750.490
05.574.82.87.2	03.030.8750.490
05.574.82.87.3	03.030.8750.490
05.574.82.93.2	03.030.8750.490
05.575.82.27.0	03.030.8750.42S
05.801.02.93.0	03.120.8700.110
06.24180.4559	03.060.7450.600
09.084.46.11.0	03.070.0203.000
09.084.46.12.0	03.070.0231.000
09.084.46.36.0	03.070.0242.861
09.084.66.02.0	03.070.0233.000
09.097.02.07.0	03.010.0240.210
09.097.02.07.1	03.010.0240.210
09.097.02.08.0	03.010.0240.220
09.097.02.08.1	03.010.0240.220
09.097.02.37.0	03.010.0240.210
09.097.02.37.1	03.010.0240.210
09.097.02.38.0	03.010.0240.220
09.097.02.38.1	03.010.0240.220
09.097.05.01.0	03.010.0240.230
09.097.05.01.1	03.010.0240.230
09.097.05.02.0	03.010.0240.240
09.097.05.02.1	03.010.0240.240
09.097.05.03.0	03.010.0240.250
09.097.05.03.1	03.010.0240.250
09.097.05.05.0	03.010.0240.270
09.097.05.05.1	03.010.0240.270
09.097.05.06.0	03.010.0240.280
09.097.05.06.1	03.010.0240.280
09.097.05.07.0	03.010.0240.290
09.097.05.07.1	03.010.0240.290
09.097.05.08.0	03.010.0240.300
09.097.05.08.1	03.010.0240.300
09.097.05.09.0	03.010.0240.310

Vergleichsliste | Crosslist

aufsteigend nach Vergleichsnummer | ascending to Comp.-No.

BERGISCHE ACHSE		BERGISCHE ACHSE	
09.097.05.09.1	03.010.0240.310	09.097.05.30.0	03.010.0240.520
09.097.05.10.0	03.010.0240.320	09.097.05.30.1	03.010.0240.520
09.097.05.10.1	03.010.0240.320	09.097.05.31.0	03.010.0240.530
09.097.05.11.0	03.010.0240.330	09.097.05.31.1	03.010.0240.530
09.097.05.11.1	03.010.0240.330	09.097.05.35.0	03.010.0240.570
09.097.05.12.0	03.010.0240.340	09.097.05.35.1	03.010.0240.570
09.097.05.12.1	03.010.0240.340	09.097.05.36.0	03.010.0240.580
09.097.05.13.0	03.010.0240.350	09.097.05.36.1	03.010.0240.580
09.097.05.13.1	03.010.0240.350	09.097.05.37.0	03.010.0240.590
09.097.05.14.0	03.010.0240.360	09.097.05.37.1	03.010.0240.590
09.097.05.14.1	03.010.0240.360	09.097.05.38.0	03.010.0240.600
09.097.05.15.0	03.010.0240.370	09.097.05.38.1	03.010.0240.600
09.097.05.15.1	03.010.0240.370	09.097.05.39.0	03.010.0240.610
09.097.05.16.0	03.010.0240.380	09.097.05.39.1	03.010.0240.610
09.097.05.16.1	03.010.0240.380	09.097.05.40.0	03.010.0240.620
09.097.05.17.0	03.010.0240.390	09.097.05.40.1	03.010.0240.620
09.097.05.17.1	03.010.0240.390	09.097.05.45.0	03.010.0240.670
09.097.05.18.0	03.010.0240.400	09.097.05.45.1	03.010.0240.670
09.097.05.18.1	03.010.0240.400	09.097.05.46.0	03.010.0240.680
09.097.05.19.0	03.010.0240.410	09.097.05.46.1	03.010.0240.680
09.097.05.19.1	03.010.0240.410	09.097.05.47.0	03.010.0240.690
09.097.05.20.0	03.010.0240.420	09.097.05.47.1	03.010.0240.690
09.097.05.20.1	03.010.0240.420	09.097.05.48.0	03.010.0240.700
09.097.05.21.0	03.010.0240.430	09.097.05.48.1	03.010.0240.700
09.097.05.21.1	03.010.0240.430	09.177.23.09.0	03.070.0234.020
09.097.05.22.0	03.010.0240.440	09.397.21.03.0	03.080.0241.840
09.097.05.22.1	03.010.0240.440	09.397.32.04.0	03.080.0241.870
09.097.05.23.0	03.010.0240.450	09.801.00.14.0	03.020.0241.0 S
09.097.05.23.1	03.010.0240.450	09.801.00.14.1	03.020.0241.1 S
09.097.05.24.0	03.010.0240.460	09.801.00.14.1 S	03.020.0241.4 S
09.097.05.24.1	03.010.0240.460	09.801.00.14.2	03.020.0241.2 S
09.097.05.25.0	03.010.0240.470	09.801.00.24.1	03.020.0241.3 S
09.097.05.25.1	03.010.0240.470	09.801.00.24.2	03.020.0241.3 S
09.097.05.26.0	03.010.0240.480	09.801.00.26.0 S	03.020.0242.0 S
09.097.05.26.1	03.010.0240.480	09.801.00.43.1	03.020.0241.5 S
09.097.05.27.0	03.010.0240.490	09.801.02.10.0	03.070.0242.9 S
09.097.05.27.1	03.010.0240.490	09.801.02.12.0	03.070.0244.5 S
09.097.05.28.0	03.010.0240.500	09.801.02.13.0	03.020.0242.7 S
09.097.05.28.1	03.010.0240.500	09.801.02.15.0	03.020.0241.6 S
09.097.05.29.0	03.010.0240.510	09.801.02.22.0	03.020.0242.81S
09.097.05.29.1	03.010.0240.510	09.801.02.22.0.	03.020.0242.81S

aufsteigend nach Vergleichsnummer | ascending to Comp.-No.

BERGISCHE ACHSE	
09.801.02.57.0	03.120.8700.120
09.801.02.75.0	03.120.8700.110
09.801.02.92.0	03.120.8700.120
09.801.02.93.0	03.120.8700.110
09.801.06.09.1	03.020.0242.85S
09.801.06.20.0	03.120.8700.120
09.801.06.96.0	03.120.8700.120
99.00.000.0.37	03.100.0249.130
99.00.000.0.40	03.100.0249.140
99.00.000.0.42	03.100.0249.150
99.00.000.0.70	03.100.0249.160
99.00.000.0.71	03.100.0249.000
99.00.000.0.72	03.100.0249.170
99.00.000.0.73	03.100.0249.180
99.00.000.0.75	03.100.0249.320
99.00.000.0.76	03.100.0249.190
99.00.000.0.80	03.100.0249.200
99.00.000.0.81	03.100.0249.280
99.00.000.0.83	03.100.0249.290
99.00.000.0.84	03.100.0249.260
99.00.000.0.85	03.100.0249.210
99.00.000.0.88	03.100.0246.690
99.00.000.0.89	03.100.0249.220
99.00.000.0.93	03.100.0249.120
99.00.000.0.94	03.100.0249.230
99.00.000.0.95	03.100.0249.240
99.00.000.0.97	03.100.0249.250
99.00.000.0.98	03.100.0249.330
99.00.000.1.03	03.100.0249.270
99.00.000.1.05	03.100.0249.310
99.00.000.1.06	03.100.0249.300
99.00.000.1.09	03.100.0249.390

DAF	
AMPA014	03.110.0275.840
AMPB481	03.110.0275.840
AMPB860	03.110.0275.840
ESXBU1009	03.030.8750.620
ESXBU1024	03.030.8750.970
ESXBU1030	03.030.8750.012
ESXBU1032	03.030.8750.980

DAF	
ESXBU1033	03.030.8750.011
ESXBU1033	03.030.8750.110
MAK 2578	03.110.0275.800
MAK 7429	03.110.0275.820
MAK 7529	03.110.0275.820
MJK2785	03.110.0275.840
PAK7404	03.110.0275.820
0094 898	03.090.0279.000
0161 518	03.090.0279.060
0622 246	03.070.0281.010
0754 397	03.090.0279.040
090 500	03.090.0279.050
094 903	03.090.0279.010
1212 994	03.080.0289.010
1232 806	03.090.0279.090
1233 462	03.090.0279.010
1234 233	03.030.8750.510
1238 372	03.110.0275.810
1276 868	03.030.7161.0 S
1276 868	03.030.7161.01S
1279 502	03.080.0284.000
1301 490	03.080.0289.010
1325 309	03.030.8750.490
1325 310	03.030.8750.46S
1325 310	03.030.8750.480
1340 297	03.080.0289.010
1400 069	03.110.0275.890
1400 163	03.110.0275.850
1400 273	03.110.0275.860
1400 284	03.110.0275.870
1403 758	03.110.0275.880
1439 324	03.120.8700.120
145 450	03.070.0280.000
145 459	03.070.0280.010
159 560	03.030.8750.880
159 561	03.030.8750.020
159 562	03.030.8750.030
159 565	03.030.8750.880
159 569	03.030.8750.510
159 570	03.030.8750.510
159 578	03.030.8750.510

Vergleichsliste | Crosslist

aufsteigend nach Vergleichsnummer | ascending to Comp.-No.

DAF	
159 579	03.030.8750.510
159 587	03.030.8750.020
159 588	03.030.8750.030
194 592	03.080.0284.000
2100200001	03.030.0240.890
2100200008	03.030.0240.870
2100200701	03.030.0240.900
278 678	03.030.8750.880
278 679	03.030.8750.880
279 243	03.030.8750.106
279 244	03.030.8750.106
281 094	03.030.8750.510
281 095	03.030.8750.510
282 609	03.030.8750.280
282 610	03.030.8750.280
284 620	03.090.0279.010
284 860	03.030.8750.880
285 951	03.030.0287.000
285 952	03.030.0285.001
285 952	03.030.0288.001
286 952	03.030.0285.001
286 952	03.030.0288.001
289 691	03.030.8750.020
289 692	03.030.8750.030
290 377	03.070.0280.020
297 174	03.030.8750.510
297 175	03.030.8750.510
299 095	03.110.0275.810
361 541	03.030.8750.020
361 542	03.030.8750.030
364 577	03.070.0281.000
365 579	03.090.0279.020
368 829	03.090.0279.040
388 947	03.030.8750.510
389 862	03.080.0289.010
392 736	03.030.8750.890
505 835	03.030.0285.001
505 835	03.030.0288.001
505 839	03.030.0287.000
537 537	03.030.8750.890
537 538	03.030.8750.280

DAF	
537 539	03.030.8750.280
595 222	03.090.0279.080
622 246	03.070.0281.010
622 247	03.070.0281.000
638 167	03.090.0279.030
663 772	03.030.0285.001
663 772	03.030.0288.001
663 773	03.030.0285.001
663 773	03.030.0288.001
667 965	03.070.0280.090

FRUEHAUF	
A-J 0026001	03.090.0291.000
A-JA-0476-003	03.010.0290.700
A-JA-0476-004	03.010.0290.710
A-JA-0483-001	03.100.0290.160
A-JA-0489-001	03.090.0290.920
A-JA-0489-002	03.090.0290.920
A-JA-0504-002	03.070.0290.180
A-JA-0507-001	03.070.0290.170
AJA-0507-001	03.070.0290.500
A-JA-0508-001 S	03.040.0290.320
A-JA-0558-001	03.070.0290.150
A-JA-0595-001	03.090.0290.920
A-JA-0660-003	03.010.0290.720
A-JA-0660-004	03.010.0290.730
AJB 0119-001	03.080.3504.020
A-JB 0335001	03.090.0291.000
A-JB-0001-001	03.020.0290.190
A-JB0026001	03.090.0291.000
A-JB-0038-001	11.030.0290.290
A-JB-0465-002	03.090.0290.600
AR-JA-0199-705	03.020.0290.410
AR-JB-0006-701	03.100.0290.980
AR-JB-0006-701	03.100.0290.990
A-30026	03.090.0291.000
A-31468	03.090.0291.000
29106	03.120.8700.120
29109	03.120.8700.120
29142	03.120.8700.320
29163	03.120.8700.120

aufsteigend nach Vergleichsnummer | ascending to Comp.-No.

FRUEHAUF	
31270	03.090.0290.920

HALDEX	
100001021	03.030.0240.890
100001128	03.030.0240.880
100001721	03.030.0240.900
100001760	03.030.0244.901
100002167	03.030.0695.200
100101041	03.030.0240.870
100101047	03.030.2085.500
100101364	03.030.0288.001
100101364	03.030.0285.001
104401201	03.030.0287.000
104407401	03.030.1906.560
104507401	03.030.1906.570
69823	03.120.8700.120
70518	03.030.8750.107
70661	03.030.8750.270
70702	03.030.8750.107
70706	03.030.8750.170
70707	03.030.8750.100
70720	03.030.8750.105
70771	03.030.8750.190
70772	03.030.8750.180
70805	03.030.8750.220
70846	03.030.8750.940
70857	03.030.8750.940
70867	03.030.8750.220
70878	03.030.8750.300
70879	03.030.8750.310
70896	03.030.8750.840
70897	03.030.8750.850
70917	03.030.8750.960
70918	03.030.8750.260
70937	03.030.8750.320
70938	03.030.8750.290
70950	03.030.8750.108
70951	03.030.8750.108
70952	03.030.8750.100
70953	03.030.8750.090
70958	03.030.8750.400

HALDEX	
70962	03.030.8750.110
70974	03.030.8750.270
70975	03.030.8750.920
70976	03.030.8750.930
70992	03.030.8750.117
70993	03.030.8750.118
72001	03.030.8750.290
72002	03.030.8750.320
72012	03.030.8750.090
72013	03.030.8750.100
72036	03.030.8750.090
72037	03.030.8750.100
72056	03.030.8750.990
72059	03.030.8750.210
72060	03.030.8750.101
72061	03.030.8750.102
72069	03.030.8750.090
72070	03.030.8750.100
72089	03.030.8750.530
72090	03.030.8750.540
72107	03.030.8750.000
72108	03.030.8750.010
72109	03.030.8750.000
72110	03.030.8750.010
72116	03.030.8750.106
72117	03.030.8750.880
72137	03.030.8750.109
72138	03.030.8750.110
72139	03.030.8750.510
72158	03.030.8750.980
72159	03.030.8750.970
72164	03.030.8750.000
72165	03.030.8750.010
72173	03.030.8750.090
72174	03.030.8750.100
72202	03.030.8750.880
72208	03.030.8750.100
72210	03.030.8750.400
72211	03.030.8750.230
72212	03.030.8750.240
72213	03.030.8750.160

Vergleichsliste | Crosslist



aufsteigend nach Vergleichsnummer | ascending to Comp.-No.

HALDEX	
72223	03.030.8750.020
72224	03.030.8750.030
72236	03.030.8750.360
72237	03.030.8750.520
72244	03.030.8750.090
72245	03.030.8750.100
72247	03.030.8750.320
72248	03.030.8750.290
72250	03.030.8750.480
72303	03.030.8750.100
72304	03.030.8750.090
72308	03.030.8750.220
72310	03.030.8750.020
72311	03.030.8750.030
72314	03.030.8750.510
72318	03.030.8750.530
72319	03.030.8750.540
72339	03.030.8750.090
72340	03.030.8750.100
72383	03.030.8750.890
72394	03.030.8750.840
72395	03.030.8750.850
72414	03.030.8750.090
72415	03.030.8750.100
72438	03.030.8750.400
72442	03.030.8750.510
72455	03.030.8750.150
72456	03.030.8750.140
72464	03.030.8750.270
72476	03.030.8750.290
72477	03.030.8750.320
72482	03.030.8750.360
72483	03.030.8750.520
72486	03.030.8750.320
72487	03.030.8750.290
72488	03.030.8750.320
72489	03.030.8750.290
72490	03.030.8750.270
72491	03.030.8750.300
72492	03.030.8750.310
72512	03.030.8750.110

HALDEX	
72523	03.030.8750.000
72524	03.030.8750.010
72525	03.030.8750.000
72526	03.030.8750.010
72529	03.030.8750.106
72530	03.030.8750.880
72531	03.030.8750.510
72532	03.030.8750.000
72533	03.030.8750.010
72534	03.030.8750.280
72535	03.030.8750.880
72536	03.030.8750.020
72537	03.030.8750.030
72542	03.030.8750.020
72543	03.030.8750.030
72546	03.030.8750.510
72553	03.030.8750.510
72558	03.030.8750.890
72561	03.030.8750.190
72562	03.030.8750.180
72578	03.030.8750.400
72579	03.030.8750.520
72580	03.030.8750.360
72586	03.030.8750.000
72587	03.030.8750.010
72596	03.030.8750.250
72613	03.030.8750.940
72616	03.030.8750.100
72617	03.030.8750.090
72620	03.030.8750.320
72621	03.030.8750.290
72623	03.030.8750.270
72624	03.030.8750.300
72625	03.030.8750.310
72626	03.030.8750.320
72627	03.030.8750.290
72630	03.030.8750.320
72631	03.030.8750.290
72632	03.030.8750.270
72633	03.030.8750.530
72634	03.030.8750.540

aufsteigend nach Vergleichsnummer | ascending to Comp.-No.

HALDEX	
72654	03.030.8750.270
72655C	03.030.8750.570
72656C	03.030.8750.580
72657C	03.030.8750.590
72658C	03.030.8750.123
72660	03.030.8750.300
72661	03.030.8750.310
72663	03.030.8750.320
72664	03.030.8750.290
72665	03.030.8750.290
72666	03.030.8750.320
72679	03.030.8750.020
72680	03.030.8750.030
72683	03.030.8750.840
72684	03.030.8750.850
72688	03.030.8750.040
72689	03.030.8750.050
72721C	03.030.8750.550
72722C	03.030.8750.560
72727	03.030.8750.520
72728	03.030.8750.360
72729C	03.030.8750.600
72730C	03.030.8750.410
72731	03.030.8750.150
72732	03.030.8750.140
72740	03.030.8750.103
72741	03.030.8750.104
72744C	03.030.8750.610
72745C	03.030.8750.620
72746C	03.030.8750.350
72747C	03.030.8750.750
72782C	03.030.8750.330
72783C	03.030.8750.340
72784C	03.030.8750.710
72785C	03.030.8750.720
72786	03.030.8750.840
72787	03.030.8750.850
72793	03.030.8750.510
72796	03.030.8750.840
72797	03.030.8750.850
72809	03.030.8750.150

HALDEX	
72810	03.030.8750.140
72811	03.030.8750.150
72812	03.030.8750.140
72825	03.030.8750.320
72826	03.030.8750.290
72851	03.030.8750.370
72875	03.030.8750.490
72876	03.030.8750.490
72876D	03.030.8750.42S
72901C	03.030.8750.660
72902C	03.030.8750.670
72910C	03.030.8750.700
72919	03.030.8750.470
72920	03.030.8750.950
72944C	03.030.8750.680
72947C	03.030.8750.690
72949	03.030.8750.300
72950	03.030.8750.310
72951	03.030.8750.320
72952	03.030.8750.290
72953	03.030.8750.270
72954	03.030.8750.290
72955	03.030.8750.320
72956	03.030.8750.360
72957	03.030.8750.520
72958	03.030.8750.320
72959	03.030.8750.290
72962	03.030.8750.270
72965	03.030.8750.090
72966	03.030.8750.100
72968	03.030.8750.100
72969	03.030.8750.090
72980	03.030.8750.400
72981	03.030.8750.150
72982	03.030.8750.140
72987	03.030.8750.110
72989	03.030.8750.400
72990	03.030.8750.150
72991	03.030.8750.140
72995	03.030.8750.370
72997	03.030.8750.103

Vergleichsliste | Crosslist



aufsteigend nach Vergleichsnummer | ascending to Comp.-No.

HALDEX	
72998	03.030.8750.104
76046	03.030.7161.01S
76046	03.030.7161.0 S
79000	03.030.8750.530
79001	03.030.8750.540
79005	03.030.8750.480
79005D	03.030.8750.46S
79007C	03.030.8750.111
79008C	03.030.8750.112
79009	03.030.8750.530
79010	03.030.8750.540
79011C	03.030.8750.630
79013C	03.030.8750.730
79014C	03.030.8750.740
79017	03.030.8750.530
79018	03.030.8750.540
79019C	03.030.8750.640
79020C	03.030.8750.115
79021C	03.030.8750.116
79033	03.030.8750.370
79045	03.030.8750.840
79046	03.030.8750.850
79073	03.030.8750.090
79074	03.030.8750.100
79075	03.030.8750.840
79076	03.030.8750.850
79105C	03.030.8750.119
79106C	03.030.8750.120
79109	03.030.8750.480
79112	03.030.8750.480
79149	03.030.8750.480
79150C	03.030.8750.780
79151C	03.030.8750.790
79152C	03.030.8750.760
79153C	03.030.8750.770
79185	03.030.8750.250
79193	03.030.8750.100
79195	03.030.8750.090
79196	03.030.8750.100
79202	03.030.8750.940
79203	03.030.8750.190

HALDEX	
79204	03.030.8750.180
79205	03.030.8750.090
79206	03.030.8750.100
79207	03.030.8750.100
79208	03.030.8750.100
79209	03.030.8750.090
79212C	03.030.8750.130
79215C	03.030.8750.940
79216	03.030.8750.970
79216C	03.030.8750.970
79217	03.030.8750.980
79217C	03.030.8750.980
79218	03.030.8750.400
79219	03.030.8750.150
79220	03.030.8750.140
79225	03.030.8750.110
79225C	03.030.8750.011
79226C	03.030.8750.012
79227	03.030.8750.400
79228	03.030.8750.150
79229	03.030.8750.140
79271C	03.030.8750.650
79288	03.030.8750.103
79289	03.030.8750.104
79290	03.030.8750.840
79291	03.030.8750.850
79292	03.030.8750.840
79293	03.030.8750.850
79298C	03.030.8750.810
79300C	03.030.8750.910
79301C	03.030.8750.820
79302C	03.030.8750.830
79303C	03.030.8750.800
79304	03.030.8750.103
79304C	03.030.8750.103
79305	03.030.8750.104
79305C	03.030.8750.104
79306	03.030.8750.530
79307	03.030.8750.540
79308	03.030.8750.840
79309	03.030.8750.850

aufsteigend nach Vergleichsnummer | ascending to Comp.-No.

HALDEX	
79310C	03.030.8750.860
79311C	03.030.8750.870
79440C	03.030.8750.113
79441C	03.030.8750.114
79442C	03.030.8750.390
79442C	03.030.8750.370
80000	03.030.8750.100
80000C	03.030.8750.001
80001	03.030.8750.090
80008C	03.030.8750.122
80008C	03.030.8750.121
80010	03.030.8750.100
80011	03.030.8750.090
80019	03.030.8750.490
80020D	03.030.8750.45S
80022	03.030.8750.480
80023D	03.030.8750.43S
80024D	03.030.8750.44S
86671	03.090.0290.920
92419	03.030.8750.000
92420	03.030.8750.010

HENDRICKSON	
HB100393	03.030.8750.860
HB100394	03.030.8750.870
SK5086	03.030.8750.480

IVECO	
0190 6040	03.120.8700.010
0190 6043	03.120.8700.070
0190 6144	03.120.8700.060
0190 6401	03.120.8700.290
0190 6438	03.110.0823.200
0190 6439	03.120.8700.120
0190 6467	03.120.8700.120
0190 7527	03.110.0815.200
0190 7528	03.110.0813.200
0190 7530	03.110.0815.200
0190 8578	03.110.0815.200
0190 8773	03.110.0822.200
0247 5817	03.090.0809.150

IVECO	
0247 9853	03.090.0809.040
0299 1979	03.110.0818.400
0299 2339	03.120.8700.290
0299 2477	03.110.0823.200
0716 8368	03.110.0814.400
0717 1274	03.110.0814.400
0717 2329	03.090.0809.050
0717 2928	03.110.0820.400
0717 2929	03.110.0820.400
0717 2930	03.110.0820.400
0717 3281	03.090.0809.110
0718 3046	03.090.0809.120
0718 3050	03.090.0809.130
0812 1307	03.080.0806.070
0812 1308	03.080.0806.060
159 556	03.030.8750.000
159 557	03.030.8750.010
159 558	03.030.8750.000
159 559	03.030.8750.010
179 979	03.030.7161.0 S
179 979	03.030.7161.01S
1906 191	03.120.8700.000
1906 459	03.120.8700.000
1906 467	03.120.8700.120
1907 842	03.130.8701.020
1907 956	03.130.8701.000
1908 231	03.130.8701.010
204 552	03.120.8700.120
3416 4068	03.090.0710.710
4211 8426	03.090.0809.030
4211 8427	03.090.0809.060
4247 0842	03.110.0821.400
4248 0056	03.080.0807.070
4253 5791	03.120.8700.290
7163 802	03.090.0809.020
7171 255	03.110.0816.400
7172 018	03.110.0815.200
7172 079	03.090.0809.010
7172 880	03.110.0817.400
7172 881	03.110.0817.400
7172 882	03.110.0817.400

Vergleichsliste | Crosslist

aufsteigend nach Vergleichsnummer | ascending to Comp.-No.

IVECO	
7183 047	03.090.0809.010
7573 317	03.110.0818.400
8582 290	03.110.0810.400
8584 182	03.110.0811.400
8601 7939	03.090.0809.140
9291 037	03.120.8700.120
9380 0492	03.110.0819.400
9382 1918	03.110.0821.400

KÄSSBOHRER	
010.24.21.849.59	03.010.0692.000
010.24.21.849.77	03.010.0657.000
010.24.21.849.78	03.010.0658.000
010.24.21.920.73	03.040.0687.000
010.24.21.928.15	03.070.0661.000
010.24.21.939.21	03.070.0634.000
010.24.21.939.31	03.070.0633.000
01.24219.26.15	03.070.0694.000
015.26.21.115.40	03.070.0634.010
015.26.21.500.36	03.040.0687.001
015.26.22.101.51	03.020.0690.000
015.26.22.103.51	03.020.0691.000
015.26.85.111.15 B	03.090.0601.010
016.26.52.200.03	03.040.0672.500
016.26.52.312.01	03.090.0601.000
0501.313.313	03.110.0620.000
051.24.21.920.73	03.040.0687.000
051.26.52.200.03	03.040.0672.500
107.25.20.150.06	03.090.0601.020
172.24.11.130.02	03.110.0620.010
173.25.20.128.02	03.110.0620.010
179.24.11.111.31	03.110.0620.020
179.24.11.113.06	03.090.0601.030
179.24.11.113.07	03.110.0620.030
179.25.20.112.07	03.090.0601.060
179.25.20.114.11	03.090.0601.040
315.25.20.122.01	03.090.0601.050
418.16.21.111.15	03.070.0646.000
6.125.451.102	03.070.0615.010
6.125.451.103	03.070.0616.000
6.694.030.300	03.070.0695.170

KÄSSBOHRER	
8.252.0191.74	03.090.0710.700
8.283.000.5620	03.030.0695.200
8.285.000.571	03.120.8700.120
8.285.388.435	03.120.8700.020
8.285.390.000	03.110.0620.000
8.285.408.463	03.120.8700.020
8.285.408.534	03.120.8700.020
8.285.515.573	03.120.8700.120
8.285.521.000	03.120.8700.020
8.285.522.000	03.120.8700.020
8.285.525.000	03.120.8700.020
8.285.526.000	03.120.8700.020
8.951.038.200	03.020.0692.0 S

MAN	
06.01289.0104	03.070.1904.930
06.01902.3413	03.130.0923.980
06.02191.2824	03.130.0923.970
06.16010.0108	03.070.1904.910
06.16010.0408	03.070.1904.910
06.29010.0114	03.070.1455.020
06.29010.0127	03.020.1909.160
06.33719.0057	03.020.0905.420
06.33719.0058	03.020.0905.420
06.33719.0061	03.020.0905.420
06.36959.0014 S	03.020.1902.0 S
44.62322.131	03.090.0710.700
50.01014.694	03.120.8700.060
51.50110.0212	03.090.0919.120
81.05610.6206	03.030.8750.970
81.35700.6111	03.110.0922.080
81.50110.0101	03.090.0919.100
81.50110.0102	03.090.1940.110
81.50110.0104	03.090.0919.020
81.50110.0107	03.090.0919.020
81.50110.0115	03.090.0919.110
81.50110.0118	03.090.1940.100
81.50110.0144	03.090.0919.020
81.50110.0175	03.090.0919.030
81.50110.0195	03.090.0919.030
81.50110.0213	03.090.1940.100

aufsteigend nach Vergleichsnummer | ascending to Comp.-No.

MAN	
81.50110.0214	03.090.0919.010
81.50110.0216	03.090.0919.130
81.50110.0218	03.090.0919.110
81.50110.0226	03.090.1940.030
81.50110.0227	03.090.0919.010
81.50110.0231	03.090.1940.030
81.50110.0232	03.090.0919.010
81.50110.0233	03.090.0919.160
81.50110.0237	03.090.0919.140
81.50110.0242	03.090.1940.100
81.50201.6098	03.040.0904.530
81.50201.6099	03.040.1905.850
81.50201.6178	03.040.0904.140
81.50201.6184	03.040.1905.850
81.50201.6188	03.040.1905.960
81.50211.0016	03.070.1905.910
81.50211.0018	03.070.1905.920
81.50211.0023	03.070.1455.060
81.50211.0027	03.070.1905.910
81.50211.0030	03.070.1455.060
81.50212.0019	03.070.0991.000
81.50212.0027	03.070.0982.000
81.50212.0032	03.070.1456.000
81.50212.0036	03.070.1456.000
81.50213.6001	03.070.0983.000
81.50213.6006	03.070.0941.000
81.50213.6006 S	03.070.0941.1 S
81.50213.6013	03.070.1455.000
81.50301.0112	03.010.1905.870
81.50301.0113	03.010.1905.860
81.50301.0153	03.010.0908.170
81.50301.0154	03.010.0908.180
81.50301.0223	03.010.1905.830
81.50301.0224	03.010.1905.840
81.50301.0225	03.010.0908.170
81.50301.0226	03.010.0908.180
81.50301.0271	03.010.0903.510
81.50301.0272	03.010.0903.520
81.50308.0006	03.020.1909.020
81.50308.0011	03.020.1909.020
81.50610.13160	03.030.8750.100

MAN	
81.50610.14167	03.030.8750.940
81.50610.15167	03.030.8750.940
81.50610.16167	03.030.8750.940
81.50610.16209	03.030.8750.940
81.50610.19177	03.030.8750.100
81.50610.20178	03.030.8750.970
81.50610.21179	03.030.8750.980
81.50610.22180	03.030.8750.400
81.50610.23180	03.030.8750.400
81.50610.24182	03.030.8750.150
81.50610.25181	03.030.8750.140
81.50610.34170	03.030.8750.011
81.50610.34170	03.030.8750.110
81.50610.35169	03.030.8750.012
81.50610.38091	03.030.8750.940
81.50610.39091	03.030.8750.940
81.50610.40183	03.030.8750.190
81.50610.41184	03.030.8750.180
81.50610.42194	03.030.8750.400
81.50610.43194	03.030.8750.400
81.50610.44001	03.030.8750.940
81.50610.45001	03.030.8750.940
81.50610.6001	03.030.8750.940
81.50610.6063	03.030.8750.190
81.50610.6064	03.030.8750.180
81.50610.6081	03.030.8750.130
81.50610.6085	03.030.8750.100
81.50610.6091	03.030.8750.940
81.50610.6098	03.030.8750.940
81.50610.6123	03.030.8750.400
81.50610.6126	03.030.8750.110
81.50610.6126	03.030.8750.011
81.50610.6127	03.030.8750.012
81.50610.6132	03.030.7161.0 S
81.50610.6132	03.030.7161.01S
81.50610.6137	03.030.8750.100
81.50610.6139	03.030.8750.090
81.50610.6139	03.030.8750.100
81.50610.6140	03.030.8750.100
81.50610.6149	03.030.8750.980
81.50610.6150	03.030.8750.970

Vergleichsliste | Crosslist



aufsteigend nach Vergleichsnummer | ascending to Comp.-No.

MAN	
81.50610.6151	03.030.8750.130
81.50610.6157	03.030.8750.400
81.50610.6160	03.030.8750.100
81.50610.6161	03.030.8750.090
81.50610.6165	03.030.8750.100
81.50610.6166	03.030.8750.090
81.50610.6167	03.030.8750.940
81.50610.6169	03.030.8750.012
81.50610.6170	03.030.8750.110
81.50610.6170	03.030.8750.011
81.50610.6176	03.030.8750.100
81.50610.6177	03.030.8750.090
81.50610.6178	03.030.8750.970
81.50610.6179	03.030.8750.980
81.50610.6180	03.030.8750.400
81.50610.6181	03.030.8750.140
81.50610.6182	03.030.8750.150
81.50610.6183	03.030.8750.190
81.50610.6184	03.030.8750.180
81.50610.6193	03.030.8750.100
81.50610.6194	03.030.8750.400
81.50610.6199	03.030.8750.140
81.50610.6200	03.030.8750.150
81.50610.6203	03.030.8750.140
81.50610.6204	03.030.8750.150
81.50610.6205	03.030.8750.980
81.50610.6206	03.030.8750.970
81.50610.6209	03.030.8750.940
81.50610.6210	03.030.8750.090
81.50610.6211	03.030.8750.100
81.50610.6214	03.030.8750.100
81.50610.6215	03.030.8750.090
81.50610.6216	03.030.8750.400
81.50610.6222	03.030.8750.110
81.50610.6222	03.030.8750.011
81.50610.6223	03.030.8750.012
81.50610.6226	03.030.8750.400
81.50610.6228	03.030.8750.150
81.50610.6229	03.030.8750.140
81.50610.6231	03.030.8750.130
81.50610.6235	03.030.8750.100

MAN	
81.50610.66177	03.030.8750.100
81.50610.66215	03.030.8750.100
81.50610.8151	03.030.8750.130
81.50610.9151	03.030.8750.130
81.50803.0010	03.110.0922.010
81.50803.0015	03.110.0922.030
81.50803.0020	03.110.0922.070
81.50803.0021	03.110.0922.100
81.50803.0022	03.110.0922.040
81.50803.0026	03.110.0922.020
81.50803.0027	03.110.0922.070
81.50803.0028	03.110.0922.080
81.50803.0038	03.110.0922.050
81.50803.0039	03.110.1926.390
81.50803.0040	03.110.0922.090
81.50803.0041	03.110.0922.100
81.50803.0042	03.110.0922.130
81.50803.0048	03.110.0922.080
81.50804.6025	03.120.8700.050
81.50811.0004	03.130.8701.180
81.50820.5006	03.120.8700.020
81.50820.5011	03.120.8700.050
81.50820.5023	03.120.8700.090
81.50820.5029	03.120.8700.090
81.50820.5064	03.120.8700.020
81.50820.5072	03.120.8700.180
81.50820.6002	03.120.8700.020
81.50820.6006	03.120.8700.090
81.50820.6009	03.120.8700.050
81.50820.6011	03.120.8700.050
81.50820.6014	03.120.8700.020
81.50820.6016	03.120.8700.020
81.50820.6020	03.120.8700.090
81.50820.6030	03.120.8700.120
81.50820.6034	03.120.8700.020
81.50820.6036	03.120.8700.020
81.50820.6046	03.120.8700.020
81.50822.6014	03.130.8701.130
81.51110.0194	03.090.0919.150
81.51901.6005	03.020.0909.0 S
81.51901.6006	03.020.0910.0 S

aufsteigend nach Vergleichsnummer | ascending to Comp.-No.

MAN	
81.90405.0254	03.130.0923.960
81.90711.0705	03.020.1909.130
81.90711.0706	03.020.1909.120
81.90711.0707	03.020.1909.110
81.90711.0710	03.070.1455.070
81.90711.0714	03.020.1909.090
81.90711.0738	03.020.1909.100
81.90711.0739	03.020.1909.150
81.90801.0225	03.070.1904.890
81.91710.0163	03.020.0905.400
81.92201.0109	03.060.7450.360
81.93020.0013	03.070.0942.000
81.93020.0466	03.070.1457.010
81.93020.0576	03.070.1457.040
81.93020.0645	03.070.0941.010
81.96501.0831	03.070.1457.030
81.97610.0001	03.080.1905.810
81.97610.0099	03.080.0901.030
81.97610.0115	03.080.1785.000
81.97610.0118	03.080.1780.000
81.97610.0123	03.080.1781.000
81.97610.0132	03.080.0901.010
81.97610.0208	03.080.1780.000
81.97610.0266	03.080.0904.980
81.97610.0271	03.080.0901.170
81.99803.3225	03.030.8750.100

MERCEDES-BENZ	
910105 014009	03.130.1935.110
910105 014017	03.130.1935.120
910105 014019	03.130.1905.150
290 112 50 04	03.120.8700.000
000933 010130	03.070.1904.930
000933 010288	03.070.1904.930
942 334 12 01	11.030.1909.730
674 334 19 04	03.090.1940.410
675 334 01 04	03.090.1940.040
675 334 04 04	03.090.1940.070
675 334 19 04	03.090.1940.040
675 334 21 04	03.090.1940.040
675 334 24 04	03.090.1940.070

MERCEDES-BENZ	
675 334 36 04	03.090.1940.070
675 334 43 04	03.090.1940.040
675 334 49 04	03.090.1940.070
675 334 51 04	03.090.1940.350
675 334 53 04	03.090.1940.070
675 334 55 04	03.090.1940.040
675 334 56 04	03.090.1940.360
316 356 01 02	03.090.1940.270
673 356 12 02	03.090.1940.330
674 356 06 02	03.090.1940.060
674 356 12 02	03.090.1940.060
674 356 13 02	03.090.1940.340
674 356 16 02	03.090.1940.370
307 420 40 02	03.070.1456.2 S
307 420 41 02	03.070.1459.2 S
305 420 07 19	03.040.1905.960
335 420 00 19	03.040.1905.740
350 420 03 19	03.040.1905.940
350 420 03 19	03.040.1905.941
389 420 61 19	03.040.1905.851
389 420 61 19	03.040.1905.850
389 420 64 19	03.040.1905.940
393 420 03 19	03.040.1905.821
393 420 03 19	03.040.1905.820
393 420 07 19	03.040.1905.820
393 420 25 19	03.040.1905.820
393 420 29 19	03.040.1905.820
620 420 00 19	03.040.1905.940
620 420 02 19	03.040.1905.940
659 420 00 19	03.040.1905.820
659 420 03 19	03.040.1905.940
659 420 04 19	03.040.1905.010
659 420 04 19	03.040.1905.011
659 420 13 19	03.040.1905.960
001 420 15 20	03.120.8700.170
002 420 39 20	03.120.8700.250
002 420 40 20	03.120.8700.280
002 420 42 20	03.120.8700.080
002 420 48 20	03.120.8700.260
002 420 56 20	03.120.8700.270
002 420 57 20	03.120.8700.130

Vergleichsliste | Crosslist

aufsteigend nach Vergleichsnummer | ascending to Comp.-No.

MERCEDES-BENZ	
002 420 57 20	03.120.8700.170
002 420 62 20	03.120.8700.170
002 420 69 20	03.120.8700.270
002 420 78 20	03.120.8700.110
003 420 10 20	03.120.8700.120
003 420 11 20	03.120.8700.130
003 420 12 20	03.120.8700.130
003 420 16 20	03.120.8700.120
003 420 17 20	03.120.8700.080
003 420 20 20	03.120.8700.120
003 420 22 20	03.120.8700.120
003 420 35 20	03.120.8700.120
003 420 66 20	03.120.8700.130
003 420 84 20	03.120.8700.020
004 420 22 20	03.120.8700.120
004 420 26 20	03.120.8700.080
669 420 00 20	03.120.8700.170
669 420 01 20	03.120.8700.170
670 420 28 20	03.120.8700.170
301 420 11 38	03.030.8750.160
305 420 02 38	03.030.8750.170
305 420 04 38	03.030.8750.107
305 420 26 38	03.030.8750.170
305 420 27 38	03.030.8750.107
305 420 29 38	03.030.8750.108
305 420 30 38	03.030.8750.108
307 420 01 38	03.030.8750.180
307 420 02 38	03.030.8750.190
335 420 03 38	03.030.0240.890
341 420 18 38	03.030.8750.090
341 420 19 38	03.030.8750.100
345 420 07 38	03.030.8750.090
345 420 08 38	03.030.8750.100
346 420 17 38	03.030.1906.560
346 420 18 38	03.030.1906.570
357 420 05 38	03.030.8750.210
357 420 06 38	03.030.8750.101
357 420 07 38	03.030.8750.102
357 420 11 38	03.030.8750.230
357 420 12 38	03.030.8750.240
357 420 13 38	03.030.8750.150

MERCEDES-BENZ	
357 420 14 38	03.030.8750.140
357 420 15 38	03.030.8750.150
357 420 16 38	03.030.8750.140
371 420 00 38	03.030.8750.250
376 420 02 38	03.030.8750.117
376 420 03 38	03.030.8750.118
383 420 04 38	03.030.8750.090
383 420 05 38	03.030.8750.100
385 420 11 38	03.030.8750.960
385 420 12 38	03.030.8750.260
387 420 00 38	03.030.8750.090
387 420 01 38	03.030.8750.100
387 420 02 38	03.030.8750.090
387 420 03 38	03.030.8750.001
387 420 03 38	03.030.8750.100
389 420 02 38	03.030.8750.220
389 420 07 38	03.030.8750.220
396 420 00 38	03.030.8750.220
617 420 03 38	03.030.8750.001
617 420 03 38	03.030.8750.100
617 420 04 38	03.030.8750.090
619 420 00 38	03.030.8750.121
619 420 01 38	03.030.8750.122
619 420 02 38	03.030.8750.121
619 420 03 38	03.030.8750.122
619 420 06 38	03.030.8750.100
619 420 07 38	03.030.8750.100
619 420 07 38	03.030.8750.090
619 420 07 38	03.030.8750.001
620 420 02 38	03.030.8750.220
620 420 03 38	03.030.8750.220
621 420 00 38	03.030.8750.100
621 420 01 38	03.030.8750.090
623 420 12 38	03.030.8750.121
623 420 13 38	03.030.8750.122
623 420 14 38	03.030.8750.121
623 420 15 38	03.030.8750.122
623 420 18 38	03.030.8750.990
625 420 06 38	03.030.8750.108
652 420 00 38	03.030.8750.121
652 420 01 38	03.030.8750.122

aufsteigend nach Vergleichsnummer | ascending to Comp.-No.

MERCEDES-BENZ	
652 420 02 38	03.030.8750.250
655 420 00 38	03.030.8750.100
655 420 00 38	03.030.8750.001
655 420 01 38	03.030.8750.090
658 420 02 38	03.030.8750.121
658 420 03 38	03.030.8750.122
699 420 05 38	03.030.8750.470
699 420 06 38	03.030.8750.950
942 420 00 38	03.030.8750.121
942 420 01 38	03.030.8750.122
942 420 02 38	03.030.8750.001
942 420 02 38	03.030.8750.100
942 420 03 38	03.030.8750.090
942 420 04 38	03.030.8750.100
942 420 04 38	03.030.8750.001
942 420 05 38	03.030.8750.090
942 420 08 38	03.030.8750.122
942 420 09 38	03.030.8750.121
942 420 10 38	03.030.8750.100
942 420 11 38	03.030.8750.090
942 420 12 38	03.030.8750.121
942 420 13 38	03.030.8750.122
945 420 01 38	03.030.8750.122
945 420 02 38	03.030.8750.001
945 420 08 38	03.030.8750.100
946 420 08 38	03.030.8750.100
301 420 00 39	03.070.1455.000
307 420 01 39	03.070.1455.000
307 420 03 39	03.070.1455.1 S
317 420 00 39	03.070.1455.000
335 420 00 39	03.070.1454.1 S
346 420 00 39	03.070.1455.000
360 420 03 41	03.020.1905.0 S
360 420 04 41	03.020.1902.0 S
395 420 00 41	03.070.1457.2 S
601 420 00 72	03.110.1926.300
601 420 01 72	03.110.1926.130
601 420 02 72	03.110.1926.300
601 420 03 72	03.110.1926.130
631 420 01 72	03.110.1926.330
631 420 03 72	03.110.1926.310

MERCEDES-BENZ	
318 420 01 82	03.070.1920.2 S
675 420 00 82	03.070.1930.2 S
000 420 00 92	03.030.7161.01S
000 420 00 92	03.030.7161.0 S
301 421 01 01	03.090.1940.230
305 421 00 01	03.090.1940.260
305 421 01 01	03.090.1940.030
305 421 04 01	03.090.1940.030
335 421 02 01	03.090.1940.390
335 421 03 01	03.090.1940.290
346 421 03 01	03.090.1940.100
352 421 00 01	03.090.1940.300
360 421 06 01	03.090.1940.310
387 421 00 01	03.090.1940.100
387 421 02 01	03.090.1940.090
624 421 02 01	03.090.1940.051
658 421 00 01	03.090.1940.050
669 421 06 012	03.110.1926.010
670 421 01 012	03.110.1926.150
677 421 02 01	03.090.1940.080
677 421 03 01	03.090.1940.380
677 421 04 01	03.090.1940.080
677 421 05 01	03.090.1940.190
669 421 01 08	03.120.8700.170
000 421 05 10	03.120.8700.120
000 421 10 10	03.120.8700.130
000 421 24 10	03.120.8700.270
000 421 42 10	03.120.8700.210
000 421 43 10	03.120.8700.120
001 421 05 10	03.120.8700.130
001 421 06 10	03.120.8700.130
901 421 04 10	03.120.8700.250
901 421 05 10	03.120.8700.250
901 421 06 10	03.120.8700.250
902 421 01 10	03.120.8700.080
356 421 03 12	03.110.1926.140
356 421 10 12	03.110.1926.140
356 421 12 12	03.110.1926.140
416 421 04 12	03.110.1926.050
417 421 00 12	03.110.1926.060
425 421 00 12	03.110.1926.070

Vergleichsliste | Crosslist

aufsteigend nach Vergleichsnummer | ascending to Comp.-No.

MERCEDES-BENZ		MERCEDES-BENZ	
437 421 02 12	03.110.1926.090	346 421 07 52	03.020.1909.130
437 421 04 12	03.110.1926.100	346 421 08 52	03.020.1909.140
437 421 05 12	03.110.1926.110	346 421 09 52	03.020.1909.100
440 421 01 12	03.110.1926.120	346 421 10 52	03.020.1909.150
601 421 03 12	03.110.1926.130	385 421 01 52	03.020.1909.720
601 421 05 12	03.110.1926.130	318 421 02 73	03.070.1920.040
601 421 50 12	03.110.1926.300	674 421 00 73	03.070.1930.030
601 421 51 12.	03.110.1926.300	302 421 01 74	03.070.1462.010
601 421 51 12	03.110.1926.300	302 421 09 74	03.070.1464.060
638 421 01 12	03.110.1926.340	302 421 10 74	03.070.1457.000
668 421 01 12	03.110.1926.030	307 421 00 74	03.070.1455.060
668 421 02 12	03.110.1926.040	318 421 01 74	03.070.1920.010
669 421 05 12	03.110.1926.200	335 421 00 74	03.070.1454.000
902 421 06 12	03.110.1926.180	346 421 06 74	03.070.1905.920
942 421 05 12	03.110.1926.000	346 421 07 74	03.070.1905.910
942 421 09 12	03.110.1926.000	346 421 11 74 S	03.070.1608.1 S
943 421 03 12	03.110.1926.190	346 421 11 74	03.070.1456.000
970 421 00 12	03.110.1926.020	387 421 00 74	03.070.1905.910
970 421 02 12	03.110.1926.020	497 421 00 74	03.070.1456.000
970 421 06 12	03.110.1926.020	497 421 00 74 S	03.070.1609.1 S
975 421 00 12	03.110.1926.160	658 421 00 74	03.070.1905.910
975 421 01 12	03.110.1926.160	945 421 00 74	03.070.1905.920
975 421 02 12	03.110.1926.160	335 421 01 92	03.080.1789.000
335 421 00 18	03.070.1452.000	335 421 03 92	03.080.1779.000
335 421 02 18	03.070.1452.000	341 421 00 92	03.080.1788.000
305 421 18 36	03.010.0908.170	352 421 01 92	03.080.1788.000
305 421 19 36	03.010.0908.180	301 423 01 01	03.090.1940.180
307 421 00 36	03.010.0908.170	301 423 08 01	03.090.1940.010
307 421 01 36	03.010.0908.180	301 423 12 01	03.090.1940.240
389 421 01 36	03.010.1905.830	302 423 00 01	03.090.1940.250
389 421 02 36	03.010.1905.840	305 423 03 01	03.090.1940.020
623 421 01 36	03.010.1905.830	305 423 04 01	03.090.1940.020
623 421 02 36	03.010.1905.840	305 423 06 01	03.090.1940.030
301 421 00 50	03.070.1455.090	305 423 07 01	03.090.1940.170
302 421 01 50	03.070.1457.010	307 423 01 01	03.090.1940.010
305 421 07 50 S	03.020.1905.1 S	320 423 01 01	03.090.1940.280
307 421 05 50	03.070.1457.040	335 423 01 01	03.090.1940.400
318 421 00 50	03.070.1920.020	346 423 00 01	03.090.1940.110
674 421 00 50	03.070.1930.010	346 423 01 01	03.090.1940.120
346 421 05 52	03.020.1909.110	346 423 05 01	03.090.1940.120
346 421 06 52	03.020.1909.120	346 423 06 01	03.090.1940.110

aufsteigend nach Vergleichsnummer | ascending to Comp.-No.

MERCEDES-BENZ	
355 423 06 01	03.090.1940.120
381 423 00 01	03.090.1940.140
381 423 01 01	03.090.1940.130
385 423 03 01	03.090.1940.150
385 423 05 01	03.090.1940.160
601 423 51 01	03.090.1940.000
677 423 00 01	03.090.1940.190
677 423 02 01	03.090.1940.080
000 423 71 10	03.120.8700.080
638 423 01 10	03.120.8700.260
638 423 01 12	03.110.1926.350
668 423 00 12	03.110.1926.260
668 423 01 12	03.110.1926.250
668 423 04 12	03.110.1926.240
668 423 05 12	03.110.1926.230
901 423 08 12	03.110.1926.290
902 423 03 12	03.110.1926.170
904 423 02 12	03.110.1926.210
904 423 03 12	03.110.1926.210
970 423 02 12	03.110.1926.390
970 423 04 12	03.110.1926.280
970 423 05 12	03.110.1926.270
970 423 06 12	03.110.1926.280
970 423 07 12	03.110.1926.270
970 423 10 12	03.110.1926.280
970 423 12 12	03.110.1926.280
975 423 06 12	03.110.1926.220
366 423 00 18	03.070.1450.010
366 423 01 18	03.070.1450.010
346 423 11 36	03.010.1905.860
346 423 12 36	03.010.1905.870
623 423 01 36	03.010.1905.860
623 423 02 36	03.010.1905.870
346 423 05 52	03.020.1909.070
346 423 00 57	03.020.1909.080
346 423 01 57	03.020.1909.090
346 423 00 58	03.020.1909.020
381 423 00 58	03.020.1909.010
322 426 01 83 S	03.020.1906.0 S
322 426 01 83 S	03.020.1733.11S
945 520 02 38	03.030.8750.100

MERCEDES-BENZ	
000 540 02 17	03.130.1935.040
123 540 00 17	03.130.1935.040
356 540 00 17	03.130.1935.060
601 540 06 17	03.070.1935.090
601 540 13 17	03.130.1935.050
669 540 04 17	03.130.1935.000
669 540 05 17	03.130.1935.000
669 540 06 17	03.130.8701.170
670 540 00 17	03.070.1935.080
677 540 07 17	03.130.1935.020
677 540 08 17	03.130.1935.030
901 540 00 17	03.130.1935.070
901 540 01 17	03.130.1935.070
945 542 00 38	03.030.8750.121
360 586 04 42	03.020.1902.0 S
395 586 01 42	03.070.1457.2 S
290 593 00 14	03.120.8700.120
290 613 00 14	03.120.8700.120
305 700 77 00	03.120.8700.120
000471 017000	03.070.1455.020
000471 034000	03.020.1909.160
000471 012001	03.070.1455.100
000988 017100	03.070.1455.070
000988 017012	03.070.1455.070
000093 010502	03.070.1904.910
290 953 00 14	03.120.8700.110
942 990 28 04	03.130.1905.140
317 990 05 40	03.070.1455.070
317 990 16 40	03.070.1455.050
346 990 05 40	03.070.1455.070
307 990 01 97	03.060.7450.500
307 990 02 97	03.060.7450.550
302 993 03 10	03.080.1796.000
302 993 06 10	03.080.1791.000
303 993 04 10	03.080.1905.810
314 993 08 10	03.080.1784.000
314 993 11 10	03.080.1786.000
317 993 10 10	03.080.1793.000
326 993 00 10	03.080.1794.000
335 993 05 10	03.080.1790.000
336 993 00 10	03.080.1787.000

Vergleichsliste | Crosslist

aufsteigend nach Vergleichsnummer | ascending to Comp.-No.

MERCEDES-BENZ	
346 993 01 10	03.080.1785.000
346 993 02 10	03.080.1780.000
346 993 03 10	03.080.1781.000
346 993 08 10	03.080.1795.000
360 993 01 10	03.080.1782.000
385 993 05 10	03.080.1783.000
617 993 06 10	03.080.1780.000
617 993 11 10	03.080.1772.000
673 993 02 10	03.080.1908.040
673 993 04 10	03.080.1908.040
677 993 03 10	03.080.1908.000
945 993 00 10	03.080.1773.000
302 994 02 09	03.070.1904.940
346 994 00 09	03.070.1904.910
346 994 01 09	03.070.1904.890
381 994 00 09	03.070.1904.900
302 994 00 10	03.070.1904.910
307 994 00 35	03.020.1909.050
302 997 04 45	03.070.1457.020
001 997 70 48	03.070.1930.020
003 997 15 48	03.070.1455.080
003 997 69 48	03.070.1457.030
011 997 04 48	03.070.1920.030

MERITOR / ROR	
AXL 112	03.020.4200.230
AXL 117	03.070.4200.420
AXL 122	03.020.4200.240
AXL 125	03.070.4200.410
AXL 126	03.070.4200.260
AXL 132	03.020.4200.250
152 05 191	03.040.4200.670
152 05 533	03.040.4200.680
152 13 430	03.020.4200.460
152 20 224	03.020.4200.450
152 20 720	03.020.4200.460
152 24 821	03.020.4200.450
165 00 005	03.070.4200.720
210 06 610	03.070.4200.080
210 06 610 A	03.070.4200.080
210 08 062	03.100.4201.020

MERITOR / ROR	
210 16 666	03.070.4200.430
210 16 666A	03.070.4200.430
210 18 986	03.090.4200.330
210 21 14	03.090.4200.300
210 23 389	03.080.4200.010
210 23 758	03.070.4200.710
212 00 910	03.100.4201.040
212 05 194	03.080.4200.580
212 09 723 S	03.090.4200.310
212 09 990	03.020.4200.480
212 19 257	03.010.4200.850
212 19 258	03.010.4200.860
212 20 183	03.090.4200.320
212 20 647	03.100.4201.010
212 20 668	03.070.4200.470
212 21 028	03.070.4200.290
212 21 070	03.010.4200.810
212 21 071	03.010.4200.820
212 21 194	03.010.4200.830
212 21 195	03.010.4200.840
212 21 224	03.080.4200.140
212 21 567	03.100.4201.030
212 24 263	03.110.4200.340
212 24 522	03.100.4201.000
212 27 349	03.110.4200.390

NEOPLAN	
0701.125.07	03.030.8750.170
0701.143.04	03.030.8750.180
0701.143.05	03.030.8750.190
0702.656.00	03.030.8750.310
0702.760.10	03.030.8750.040
0702.760.11	03.030.8750.050
0702.770.00	03.030.8750.105
0801.616.00	03.110.0711.010
0801.621.00	03.110.0711.000
0821.333.10	03.110.0711.020
0821.340.00	03.120.8700.120
0821.351.00	03.120.8700.120
0821.358.30	03.110.0711.030
0824.603.00	03.030.8750.300

aufsteigend nach Vergleichsnummer | ascending to Comp.-No.

RENAULT	
5000297198	03.120.8700.040
5000297345	03.120.8700.040
5000445830	03.030.8750.630
5000450158	03.110.4255.000
5000470830	03.030.8750.840
5000470831	03.030.8750.850
5000504467	03.030.8750.109
5000504468	03.030.8750.110
5000525640	03.120.8700.040
5000737768	03.090.4251.000
5000785203	03.030.8750.760
5000785204	03.030.8750.770
5000785205	03.030.8750.780
5000785206	03.030.8750.790
5000787264	03.030.8750.111
5000787265	03.030.8750.112
5000788696	03.030.8750.530
5000788697	03.030.8750.540
5000789892	03.030.8750.730
5000791212	03.030.8750.530
5000791213	03.030.8750.540
5000816365	03.030.8750.46S
5000816365	03.030.8750.480
5000882316	03.030.8750.920
5000882317	03.030.8750.930
5001014704	03.120.8700.070
5001821964	03.120.8700.040
5001823000	03.120.8700.020
5001825536	03.030.7161.0 S
5001825536	03.030.7161.01S
5001829545	03.130.8701.060
5001831161	03.120.8700.100
5001833114	03.120.8700.100
5001834527	03.120.8700.230
5001846034	03.120.8700.100
5001855646	03.120.8700.180
5001855902	03.120.8700.320
500396612	03.110.4255.040
5010013393	03.030.8750.115
5010013394	03.030.8750.116
5010019249	03.110.4255.010

RENAULT	
5010037900	03.030.8750.640
5010056685	03.030.8750.730
5010056686	03.030.8750.740
5010067156	03.030.8750.840
5010067157	03.030.8750.850
5010098831	03.030.8750.103
5010098832	03.030.8750.104
5010098893	03.030.8750.840
5010098949	03.090.4250.990
5010151248	03.030.8750.840
5010151249	03.030.8750.850
5010152965	03.030.8750.800
5010190865	03.110.4255.010
5010197577	03.030.8750.113
5010197578	03.030.8750.114
5010201995	03.030.8750.810
5010207431	03.110.4255.010
5010216246	03.030.8750.840
5010216247	03.030.8750.850
5010216433	03.110.4255.060
5010216437	03.110.4255.020
5010216548	03.110.4255.030
5010216844	03.030.8750.910
5010216904	03.030.8750.820
5010216905	03.030.8750.830
5010216931	03.110.4255.080
5010216932	03.110.4255.070
5010260023	03.030.8750.530
5010260024	03.030.8750.540
5010260027	03.030.8750.103
5010260028	03.030.8750.104
5010260085	03.030.8750.840
5010260086	03.030.8750.850
5010260101	03.110.4255.080
5010260102	03.110.4255.070
5010260115	03.030.8750.840
5010260116	03.030.8750.850
5010260117	03.030.8750.860
5010260118	03.030.8750.870
5010260344	03.030.8750.840
5010260345	03.030.8750.850

Vergleichsliste | Crosslist

aufsteigend nach Vergleichsnummer | ascending to Comp.-No.

RENAULT	
5010260603	03.110.4255.100
5010260609	03.110.4255.090
5010422364	03.110.4255.110
501316953	03.120.8700.120
5810111404	03.030.8750.530
5810111405	03.030.8750.540

SAF	
1 064 0273 00	03.090.2500.090
1.064.0060.02	03.090.2500.020
1.064.0108.01	03.090.2500.070
1.064.0149.00	03.090.2500.150
1.064.0197.00	03.090.2500.050
1.064.0218.00	03.090.2500.100
1.064.0223.00	03.090.2500.000
1.064.0236.00	03.090.2500.030
1.064.0236.01	03.090.2500.030
1.064.0260.01	03.090.2500.040
1.064.0260.02	03.090.2500.040
1.064.0261.01	03.090.2500.010
1.064.0270.00	03.090.2500.110
1.064.0277.00	03.090.2500.120
1.064.0278.00	03.090.2500.130
1.064.0280.00	03.090.2500.080
1.064.0280.01	03.090.2500.080
1.072.0017.01	03.020.2044.000
1.072.0018.00	03.020.2045.000
1.072.0060.00	03.020.2183.000
1.093.0005.00	03.070.2221.100
1.093.0012.00	03.020.2037.100
1.094.0019.00	03.020.2220.100
1.094.0034.00	03.020.2037.500
1.146.2004.02	11.030.2246.100
1.151.0008.00	03.080.2220.000
12 999 737	03.120.8700.310
1.214.0004.06	03.070.2000.000
1.214.0022.01	03.070.2022.000
1.214.0022.02	03.070.2022.000
1.214.0023.01	03.070.2023.100
1.214.0023.02	03.070.2023.000
1.230.0032.00	03.070.2007.000

SAF	
1.230.0035.00	03.070.2002.000
1.230.0036.00	03.020.2003.000
1.230.0062.00	03.020.2008.000
1.230.0062.01	03.020.2008.000
1.230.0084.00	03.070.2049.000
1.230.0084.01	03.070.2049.000
1.230.0089.00	03.020.2017.000
1.230.0106.02	03.020.2147.000
1.230.0106.03	03.020.2147.000
1.230.0106.04	03.020.2147.000
1.230.1001.01	03.020.2144.000
1.230.1002.04	03.020.2028.100
1.230.2001.01	03.020.2184.000
1.230.2001.01 S	03.020.2184.500
1.265.0003.00	03.070.2004.000
1.265.0007.00	03.070.2012.000
1.265.0007.00 S	03.070.2012.500
1.265.0019.00	03.070.2039.200
1.307.1129.01	11.030.2037.100
1.331.0013.00	03.070.2030.000
1.331.0015.00	03.020.2187.000
1.331.0020.02	03.070.2094.000
1.331.0056.00	03.020.2062.000
1.345.0006.00	03.070.2051.000
1.350.2001.04	03.020.2036.200
1.395.1001.00	03.070.2221.600
1.395.1005.00	03.070.2068.000
1.395.1013.00	03.070.2221.700
1.447.0021.01	03.080.2032.000
1.447.0023.01	03.080.2182.000
1.447.0027.01	03.080.2214.000
1.447.0033.00	03.080.2031.000
1.447.0036.00	03.080.2067.000
1.447.0037.00	03.080.0240.130
1.447.0038.00	03.080.2035.000
1.447.0041.00	03.080.2221.400
1.447.0045.00	03.080.0240.070
1.447.0049.00	03.080.0242.880
1.447.0050.00	03.080.2175.000
1.447.0056.00	03.080.2233.000
1.447.0058.00	03.080.2219.000

aufsteigend nach Vergleichsnummer | ascending to Comp.-No.

SAF	
2.175.0037.00	03.030.2085.500
2.175.0156.00	03.030.8750.480
2.175.0168.00	03.030.8750.46S
2.175.0168.00	03.030.8750.480
2.175.0169.00	03.030.8750.490
2.175.0202.00	03.030.8750.480
2.175.0202.00	03.030.8750.46S
2.262.0253.01	03.010.2165.000
2.262.0253.02	03.010.2165.000
2.262.0254.01	03.010.2166.000
2.262.0254.02	03.010.2166.000
2.262.0261.01	03.010.2163.000
2.262.0261.02	03.010.2163.000
2.262.0262.01	03.010.2164.000
2.262.0262.02	03.010.2164.000
2.262.0271.01	03.010.2191.000
2.262.0271.02	03.010.2191.000
2.262.0279.01	03.010.2202.000
2.262.0279.02	03.010.2202.000
2.262.0280.01	03.010.2203.000
2.262.0280.02	03.010.2203.000
2.262.0283.01	03.010.2158.000
2.262.0283.02	03.010.2158.000
2.262.0284.01	03.010.2159.000
2.262.0284.02	03.010.2159.000
2.262.0285.01	03.010.2167.000
2.262.0285.02	03.010.2167.000
2.262.0286.01	03.010.2168.000
2.262.0286.02	03.010.2168.000
2.262.0293.02	03.010.2161.000
2.262.0294.02	03.010.2162.000
2.262.0331.01	03.010.2212.000
2.262.0332.01	03.010.2213.000
2.262.0403.02	03.010.2240.000
2.262.0404.02	03.010.2241.000
2.262.0411.02	03.010.2242.000
2.262.0412.02	03.010.2243.000
2.262.0415.02	03.010.2244.000
2.262.0416.02	03.010.2245.000
2.262.1102.01	03.010.2253.000
2.262.1102.02	03.010.2251.000

SAF	
2.262.1103.01	03.010.2254.000
2.262.1103.02	03.010.2252.000
2.262.1110.02	03.010.2255.000
2.262.1111.02	03.010.2256.000
3.005.0009.02	03.100.2039.800
3.005.0037.03	03.100.2036.900
3.005.0055.00	03.100.2039.700
3.005.0108.00	03.100.2039.900
3.005.0117.00	03.100.2039.600
3.005.0141.00	03.100.2039.300
3.005.0147.00	03.100.2037.200
3.005.0173.00	03.100.2039.400
3.054.0052.00	03.040.2053.000
3.054.0053.00	03.040.2054.000
3.054.0084.00	03.040.2060.000
3.054.0120.00	03.040.2228.000
3.055.0052.00	03.040.2053.010
3.055.0053.00	03.040.2054.010
3.055.0084.00	03.040.2060.010
3.057.0077.00	03.120.8700.120
3.057.0078.00	03.120.8700.110
3.057.0079.00	03.120.8700.120
3.057.3179.00	03.120.8700.160
3.057.3179.00	03.120.8700.150
3.213.0004.06	03.070.2000.S00
3.213.0022.02	03.070.2022.S00
3.213.0023.01	03.070.2031.S00
3.213.0023.02	03.070.2030.S00
3.230.1002.03	03.020.2029.100
3.230.1002.04	03.020.2028.100
3.262.0253.01	03.010.2165.000
3.262.0254.01	03.010.2166.000
3.262.0261.01	03.010.2163.000
3.262.0262.01	03.010.2164.000
3.262.0271.01	03.010.2191.000
3.262.0279.01	03.010.2202.000
3.262.0280.01	03.010.2203.000
3.262.0283.01	03.010.2158.000
3.262.0284.01	03.010.2159.000
3.262.0285.01	03.010.2167.000
3.262.0286.01	03.010.2168.000

Vergleichsliste | Crosslist

aufsteigend nach Vergleichsnummer | ascending to Comp.-No.

SAF	
3.262.0331.01	03.010.2212.000
3.262.0332.01	03.010.2213.000
3.262.0403.02	03.010.2240.000
3.262.0404.02	03.010.2241.000
3.262.0411.02	03.010.2242.000
3.262.0412.02	03.010.2243.000
3.262.0415.02	03.010.2244.000
3.262.0416.02	03.010.2245.000
3.268.0006.00	03.020.2029.400
3.268.0007.01	03.020.2029.S00
3.268.0007.02	03.020.2028.S00
3.268.0029.00	03.020.2028.S00
3.268.0034.00	03.020.2028.S00
3.268.0045.00	03.020.2169.100
3.268.0046.00	03.020.2169.200
3.268.0047.00	03.020.2169.1 S
3.268.0050.00	03.020.2169.2 S
3.307.3006.00	11.030.2246.000
3.317.0004.00	03.020.2001.S00
3.317.0006.00	03.020.2160.S00
3.317.0011.00	03.020.2029.200
3.317.0016.00	03.020.2029.300
3.434.3502.02	03.030.8750.480
3.434.3502.02	03.030.8750.46S
3.434.3514.00	03.030.8750.480
3.434.3514.00	03.030.8750.46S
3.434.3601.00	03.020.2185.S00
3.434.3602.00	03.070.2023.S00
3.434.3620.00	03.020.2184.1 S
3.434.3622.00	03.020.2184.2 S
3.434.3636.00	03.020.2280.S00
3.434.3637.00	03.020.2184.3 S
3.434.3638.00	03.020.2184.5 S
3.434.3639.00	03.020.2184.6 S
4 267 0007 01	03.060.7450.000
4.079.0003.00	03.110.2402.000
4.079.0004.00	03.110.2401.000
4.079.0005.00	03.110.2400.000
4.079.0005.01	03.110.2400.000
4.079.0005.02	03.110.2400.000
4.079.0007.00	03.110.2403.000

SAF	
4.079.0007.01	03.110.2403.000
4.175.0085.00	03.030.8750.480
4.175.0184.00	03.030.8750.490
4.175.0184.00	03.030.8750.42S
4.175.0228.00	03.030.8750.46S
4.175.0228.00	03.030.8750.480
4.175.0239.00	03.030.8750.490
4.175.0249.00	03.030.8750.480
4.175.0249.00	03.030.8750.46S
4.230.0176.00	03.020.2038.200
4.230.0180.00	03.020.2038.300
4.267.0006.01	03.060.7450.700
4.315.0001.00	03.020.2046.000
4.315.0001.01	03.020.2046.000
4.315.0002.00	03.020.2185.000
4.315.0003.00	03.020.2052.000
4.315.0048.00	03.020.2037.400
4.343.1003.88	03.070.2065.000
4.343.1015.88	03.070.2065.000
4.348.1005.00	03.020.2188.000
4.348.1006.00	03.020.2063.000

SCANIA	
1 112 832	03.030.8750.270
1 112 841	03.030.8750.270
1 309 465	03.080.0241.930
1 324 357	03.030.8750.119
1 324 358	03.030.8750.120
1 334 075	03.090.3002.050
1 335 986	03.030.8750.370
1 350 817	03.030.7161.0 S
1 350 817	03.030.7161.01S
1 356 696	03.030.8750.370
1 358 634	03.030.8750.370
1 358 634	03.030.8750.390
1 361 331	03.090.3002.000
1 385 893	03.090.3002.020
1 386 686	03.110.3021.000
1 390 428	03.120.8700.120
1 414 152	03.090.3002.050
1 414 153	03.090.3002.000

aufsteigend nach Vergleichsnummer | ascending to Comp.-No.

SCANIA	
1 414 435	03.090.3002.020
1 415 147	03.110.0711.030
1 439 324	03.120.8700.120
1 652 010R	03.070.3504.220
120 824	03.080.3000.170
134 494	03.020.3004.520
141 163	03.070.3000.340
141 164	03.070.3000.330
154 259	03.070.3004.530
154 259 S	03.070.3000.370
154 261	03.070.3000.380
180 064	03.070.3000.320
183 924	03.070.3000.310
215 850	03.030.8750.270
218 833	03.030.8750.610
218 834	03.030.8750.620
219 859	03.030.8750.120
219 860	03.030.8750.119
219 997	03.030.8750.570
219 998	03.030.8750.580
221 733	03.030.8750.590
221 734	03.030.8750.123
221 737	03.030.8750.350
221 738	03.030.8750.750
246 392	03.030.8750.690
276 525	03.030.8750.320
276 526	03.030.8750.290
276 575	03.030.8750.320
276 576	03.030.8750.290
277 308	03.090.3002.040
278 350	03.030.8750.000
278 351	03.030.8750.010
278 737	03.030.8750.300
278 738	03.030.8750.310
281 090	03.030.8750.000
281 091	03.030.8750.010
285 894	03.090.3002.060
285 901	03.090.3002.010
289 336	03.020.3004.520
292 924	03.030.8750.000
292 925	03.030.8750.010

SCANIA	
293 543	03.090.3002.020
305 406	03.090.3002.040
305 438	03.090.3002.020
308 677	03.030.8750.270
311 508	03.030.8750.700
321 469	03.030.8750.320
321 470	03.030.8750.290
324 728	03.030.7161.0 S
324 728	03.030.7161.01S
324 729	03.030.7161.0 S
324 729	03.030.7161.01S
333 344	03.120.8700.000
342 880	03.090.3002.020
360 564	03.090.3002.010
360 570	03.090.3002.060
360 571	03.090.3002.070
360 572	03.090.3002.040
360 573	03.090.3002.020
362 046	03.030.8750.360
362 047	03.030.8750.520
362 134	03.030.8750.290
362 135	03.030.8750.320
375 329	03.100.3002.190
383 825	03.030.8750.410
383 826	03.030.8750.600
384 417	03.030.8750.320
384 418	03.030.8750.290
392 390	03.090.3002.030
392 391	03.090.3002.080
394 180	03.030.8750.270
394 181	03.030.8750.300
394 182	03.030.8750.310
394 185	03.030.8750.320
394 186	03.030.8750.290
394 189	03.030.8750.520
394 190	03.030.8750.360
394 191	03.030.8750.320
394 192	03.030.8750.290
394 195	03.030.8750.600
394 196	03.030.8750.410
394 197	03.030.8750.270

Vergleichsliste | Crosslist



aufsteigend nach Vergleichsnummer | ascending to Comp.-No.

SCANIA	
395 247	03.090.0279.070
397 745	03.030.8750.520
397 746	03.030.8750.360
538 470	03.030.8750.000
538 471	03.030.8750.010

SMB	
M002874	03.080.3504.020
M002904	03.100.3504.240
M002912	03.100.3504.240
M003028	03.010.3500.210
M003036	03.010.3500.200
M003176	03.090.0290.600
M006050	11.030.3504.270
M006093	03.040.3504.150
M009279/2	03.070.3504.6 S
M023425	03.010.3500.210
M023433	03.010.3500.200
M044465	03.010.3500.210
M044473	03.010.3500.200
M068445	03.090.0290.610

WVA	
WVA 20934	03.120.8700.220
WVA 21573	03.120.8700.220
WVA 21576	03.120.8700.250
WVA 21577	03.120.8700.250
WVA 21592	03.120.8700.280
WVA 21621	03.120.8700.270
WVA 21904	03.120.8700.260
WVA 23020	03.120.8700.210
WVA 23021	03.120.8700.190
WVA 23022	03.120.8700.200
WVA 29011	03.120.8700.000
WVA 29012	03.120.8700.010
WVA 29030	03.130.8701.190
WVA 29030	03.120.8700.02P
WVA 29030	03.120.8700.020
WVA 29030	03.130.8701.170
WVA 29032	03.120.8700.030
WVA 29043	03.130.8701.160

WVA	
WVA 29043	03.120.8700.040
WVA 29055	03.120.8700.050
WVA 29065	03.120.8700.060
WVA 29067	03.120.8700.070
WVA 29076	03.120.8700.080
WVA 29087	03.120.8700.12P
WVA 29087	03.120.8700.120
WVA 29088	03.120.8700.090
WVA 29090	03.120.8700.100
WVA 29093	03.120.8700.110
WVA 29095	03.120.8700.110
WVA 29095	03.120.8700.11P
WVA 29115	03.120.8700.130
WVA 29119	03.120.8700.320
WVA 29120	03.120.8700.15P
WVA 29120	03.120.8700.150
WVA 29122	03.120.8700.300
WVA 29123	03.120.8700.380
WVA 29125	03.120.8700.140
WVA 29126	03.120.8700.310
WVA 29126	03.120.8700.31P
WVA 29131	03.120.8700.180
WVA 29136	03.120.8700.340
WVA 29137	03.120.8700.360
WVA 29141	03.120.8700.320
WVA 29142	03.120.8700.320
WVA 29143	03.120.8700.16P
WVA 29143	03.120.8700.160
WVA 29154	03.120.8700.390
WVA 29158	03.120.8700.43P
WVA 29158	03.120.8700.430
WVA 29162	03.120.8700.35P
WVA 29162	03.120.8700.350
WVA 29215	03.120.8700.41P
WVA 29215	03.120.8700.410
WVA 29216	03.120.8700.42P
WVA 29216	03.120.8700.420
WVA 29357	03.120.8700.300
WVA 29374	03.120.8700.290
WVA 29706	03.120.8700.230
WVA 29835	03.120.8700.170

aufsteigend nach Vergleichsnummer | ascending to Comp.-No.

WVA	
WVA 29835	03.130.8701.170
WVA29011	03.130.8701.000
WVA29030	03.130.8701.090
WVA29030	03.130.8701.130
WVA29032	03.130.8701.000
WVA29065	03.130.8701.070
WVA29065	03.130.8701.060
WVA29065	03.130.8701.030
WVA29065	03.130.8701.020
WVA29067	03.130.8701.050
WVA29067	03.130.8701.020
WVA29067	03.130.8701.030
WVA29067	03.130.8701.040
WVA29088	03.130.8701.130
WVA29088	03.130.8701.140
WVA29090	03.130.8701.090
WVA29131	03.130.8701.140

VAN HOOL	
633105040	03.030.8750.480
637208940	03.030.8750.530
637208950	03.030.8750.530
637208960	03.030.8750.530
637208970	03.030.8750.530

VOLVO	
0270 827-9	03.040.4004.8 S
0270 828-7	03.040.4004.7 S
0270 829	03.040.4004.9 S
0272 842	03.040.4004.8 S
0324 005	03.090.4004.150
0341 717-7	03.070.4000.700
0341 719-3	03.070.4000.720
0341 720	03.080.4000.250
0346 499-7	03.080.4000.650
0348 977-0	03.070.4000.570
0348 978-8	03.070.4000.580
0348 979-6	03.070.4000.710
0352 786	03.090.4004.120
107 5309	03.090.4004.100
1075 306	03.090.4004.100
1075 307	03.090.4004.090
1075 309	03.090.4004.110
1075 310	03.090.4004.080
1134 817-4	03.090.4004.060
1134 829	03.030.8750.550
1134 830	03.030.8750.560
119 462	03.030.8750.340
1195 316	03.030.8750.680
1195 461	03.030.8750.330
1197 965	03.030.8750.710
1197 966	03.030.8750.720
1573 522	03.020.4004.890
1577 439	03.090.4004.140
1581 471	03.030.8750.670
1581 472	03.030.8750.660
1584 673-6	03.070.4000.550
1586 076	03.080.4001.580
1586 076-0	03.080.4001.640
1586 683	03.080.4000.250

TRAILOR	
M069018	03.110.3504.900
M078157	03.110.3504.910
1643000C	03.080.3504.020
1649000R	03.040.3504.200
6502102W	03.070.3504.2 S
6502102W 1/2	03.070.3504.420
6502103X	03.020.3504.390
6502103X	03.020.3504.3 S
6502382B	03.070.3504.410
6502795D	11.030.3504.100
6502809R	03.100.3505.050
6503339G	03.010.3500.220
6503340Z	03.010.3500.230
6503390L	03.010.3500.230
6503391M	03.010.3500.220
6503723T	11.030.3504.100
6503723T	03.020.3504.430
6503723T	03.020.3504.1 S
6504775W 1/2	03.070.3504.4 S

VAN HOOL	
10613835	03.030.8750.490

Vergleichsliste | Crosslist

aufsteigend nach Vergleichsnummer | ascending to Comp.-No.

VOLVO	
1586 683-3	03.080.4000.250
1586 716-1	03.070.4000.560
1589 429	03.090.4004.130
1590 313/1	03.090.4004.050
1599 009	03.090.4004.000
1599 010	03.090.4004.010
1599 011	03.090.4004.030
1599 011-2	03.090.4004.030
1599 012	03.090.4004.020
1599 012-2	03.090.4004.020
1599 014	03.090.4004.070
1599 678-8	03.090.4004.040
1599 679	03.090.4004.160
1606 683	03.020.4004.890
1617 343	03.120.8700.120
1628 064	03.120.8700.310
1629 834	03.100.4004.190
1629 835	03.100.4003.150
1629 836	03.100.4003.170
1674 000B	03.040.3504.140
1696 444	03.080.4004.810
2036 734-3	03.100.4003.160
272 843	03.040.4004.7 S
3013 676	03.030.8750.650
3090 074-0	03.040.4004.60S
3090 075-7	03.040.4004.8 S
3090 076-5	03.040.4004.7 S
3090 077	03.040.4004.9 S
3091 286	03.030.7161.01S
3091 286	03.030.7161.0 S
3097 092-2	03.080.4004.810
3112 960	03.110.4020.000
3112 965	03.110.4020.000
3171 744	03.090.4004.100
3171 745	03.090.4004.090
3171 747	03.090.4004.110
3171 748	03.090.4004.080
351 132	03.020.4004.890
351 952	03.030.0287.000
6772 133	03.090.4004.170
6774 686-7	03.110.4020.010

VOLVO	
6775 223	03.110.4020.020
6775 227-9	03.110.4020.020
6775 229	03.110.4020.020
6779 208	03.110.4020.030



SERVICE-HOTLINE

FON: +49 5156-9610-0

FAX: +49 5156-961196

SERVICE-HOTLINE

FON: +49 5156-9610-0

FAX: +49 5156-961196

